

TOSHIBA

Leading Innovation >>>

SMART MANAGER Owner's Manual

Model name: _____

BMS-SM1280HTLE

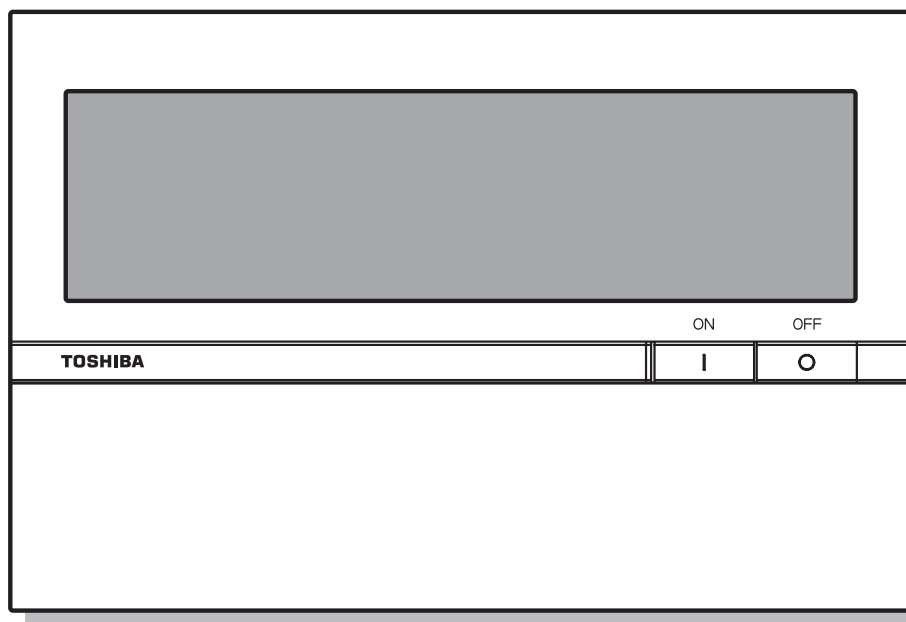

-
- Save These Instructions!
-

ENGLISH



Thank you very much for purchasing TOSHIBA Smart Manager.
This manual explains how to use the main unit of the Smart Manager. For the usage of the WEB TYPE Smart Manager, refer to its specific Owner's Manual.

Contents





1	Precautions for Safety	3
2	Specification	4
3	System Configuration	5
4	Operating Instructions	6
5	Group Operation	10
6	Zone Operation and Simultaneous Operation	11

1 Precautions for Safety



- Important information is described in the product itself and the manuals to prevent injury to the user and other persons, and damage to property, and for safe and correct use. Make sure to thoroughly understand the following details (descriptions and graphic symbols) before reading the text, and make sure to observe the precautions.
- Keep this Manual at accessible place for future reference.

Indication	Meaning of Indication
 WARNING	Text set off in this manner indicates that failure to adhere to the directions in the warning could result in serious bodily harm (*1) or loss of life if the product is handled improperly.
 CAUTION	Text set off in this manner indicates that failure to adhere to the directions in the caution could result in serious bodily injury (*2) or damage (*3) to property if the product is handled improperly.

- *1: Serious bodily harm indicates loss of eyesight, injury, burns, electric shock, bone fracture, poisoning, and other injuries which leave aftereffect and require hospitalization or long-term treatment as an outpatient.
 *2: Bodily injury indicates injury, burns, electric shock, and other injuries which do not require hospitalization or long-term treatment as an outpatient.
 *3: Damage to property indicates damage extending to buildings, household effects, domestic livestock, and pets.

Symbols	Meaning of Symbols
	“  ” Indicates prohibited items. The actual contents of the prohibition are indicated by a picture or text placed inside or next to the graphic symbol.
	“  ” Indicates compulsory (mandatory) items. The actual contents of the obligation indicated by a picture or text placed inside or next to the graphic symbol.

WARNING

	<ul style="list-style-type: none"> • Only a qualified installer or qualified service person is allowed to do installation work. Installation requires specialized knowledge and skills. If installation is carried out by an unqualified individual, fire or electric shock may result. • If an abnormality occurs (burning odour), stop operations, and turn off the circuit breaker. Otherwise, fire or electric shock may result. Consult your dealer to repair the product.
	<ul style="list-style-type: none"> • Do not disassemble, modify, repair or move the product yourself. Doing so may cause fire, electric shock or injury. Ask a qualified installer or qualified service person to do any repairs or to move the product.

CAUTION

	<ul style="list-style-type: none"> • Do not operate the buttons with wet hands. Doing so may cause electric shock.
---	--

2 Specification

Using the Smart Manager, you can control up to 128 groups of air conditioners by line, zone or group; you can run/stop them and change their settings centrally. The Smart Manager also displays the status and settings of the air conditioners.

Line	Two lines, line 1 and line 2, can be connected to the Smart Manager to communicate with air conditioners. The Smart Manager can manage all air conditioners connected to the same line at once.
Zone	In the zone setting mode, you can make zones by grouping air conditioners. You can make up to 64 zones (zone 1 - zone 64). The Smart Manager can manage all air conditioners in a zone at once. (For setting zones, refer to the Installation Manual.)

Part name		Central Controller	Power Unit
Model name		BMS-SM1280HTLE	
Power supply		Use bundled power unit.	220 - 240 VAC, 50/60 Hz
Power consumption			7W
Connectable unit number	Indoor unit	Up to 128 units (Line1: Up to 64 units, Line2: Up to 64 units)	—
	Energy monitoring interface	Up to 4 units.	—
	Digital input/output interface	Up to 4 units	—
Operating temperature / humidity		0 °C to 40 °C, 10 to 90 %RH (no condensation)	
Dimension		120(H) x 180(W) x 64(D) mm	114(H) x 177(W) x 50(D) mm
Mass		0.8 kg	0.9 kg

External Dimensions

Central Controller

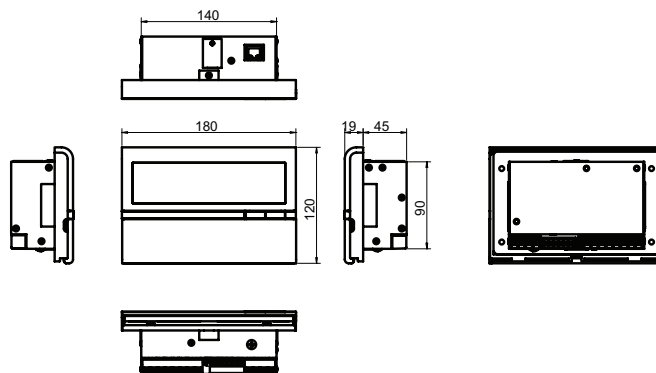

Power Unit

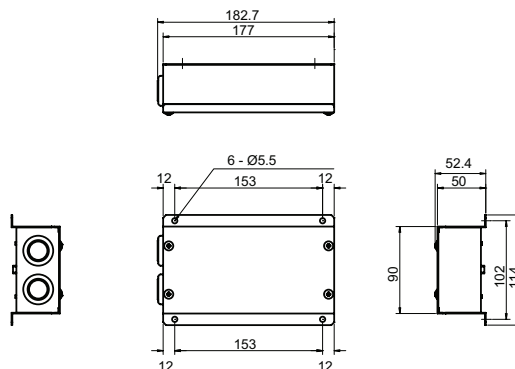

3 System Configuration

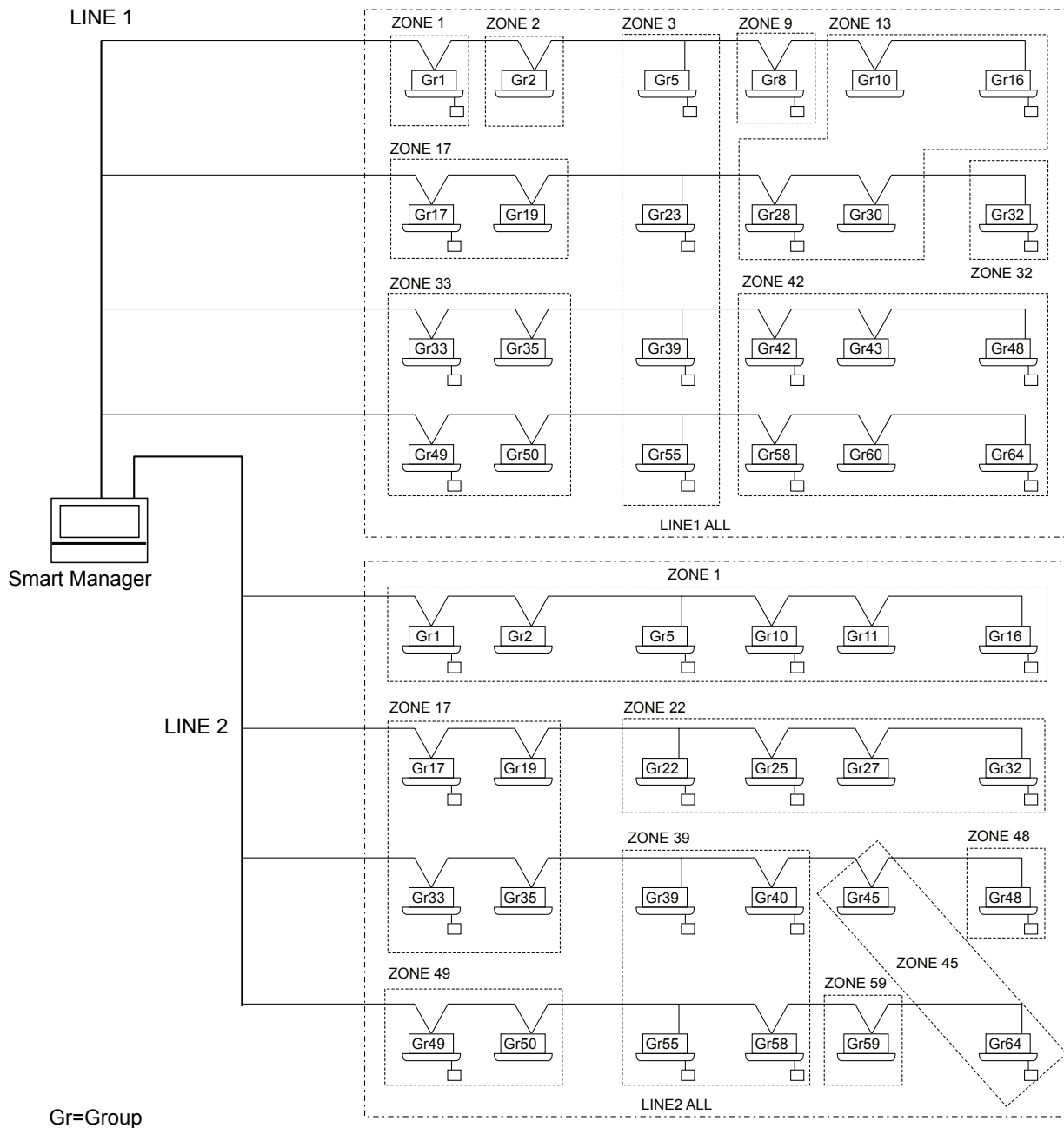

EN

* Up to 64 zones and 64 groups per line can be managed.
(This Smart Manager controls 2 lines, 128 zones, and 128 groups in total.)









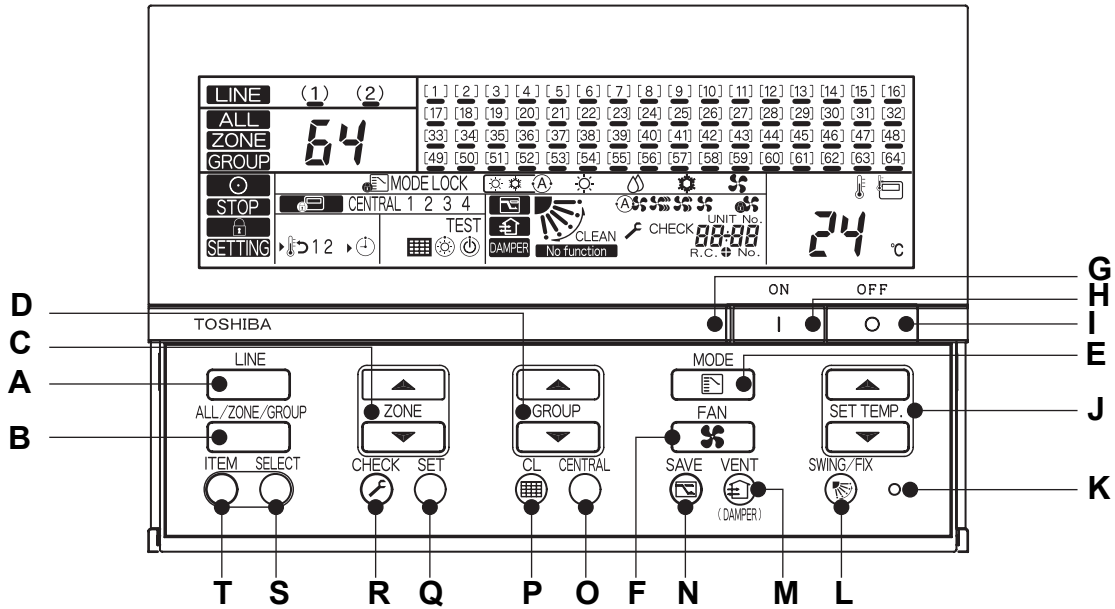







* Groups that can be registered in each zone must meet the following conditions.
1. Groups are connected to the same line.
2. Groups are in the same group number range when the control group selection is used.

* In the control group selection, the Smart Manager displays only for air conditioners in the set group number range. (For details, refer to the Installation Manual.)

4 Operating Instructions

■ Button operation



A: LINE button 	Switches line 1 (display 1), line 2 (display 2)
B: ALL/ ZONE/ GROUP button 	Switches ALL, ZONE, and GROUP. ALL : Selects all groups on the selected line simultaneously. ZONE : Selects all groups in the specified zone. GROUP : Selects a group. <ul style="list-style-type: none"> Group 1 to 64 connected to the same line can configure zones. Groups connected to different lines cannot be specified for the same zone. This remote controller can control up to 2 lines, 128 zones, and 128 groups.
C: ZONE button 	<ul style="list-style-type: none"> ▲: Increments the zone number. ▼: Decrements the zone number. * There are up to 64 zones per line. (128 groups in total).
D: GROUP button 	<ul style="list-style-type: none"> ▲: Increments the group number. ▼: Decrements the group number. * There are up to 64 groups per line. (128 groups in total).
E: MODE button 	Switches operation mode. (* Selectable operation modes vary depending on models.) AUTO:  Automatically switches heating operation and cooling operation alternately. HEAT:  Performs heating operation. DRY:  Performs dehumidifying operation. COOL:  Performs cooling operation. FAN:  Performs FAN operation. * When  MODE LOCK lights, operation mode is fixed to COOL or HEAT by the remote control system.
F: FAN button 	Switches air volume. (* Selectable air volume levels vary depending on models.) AUTO:  Air volume is automatically switched by the indoor unit. HEAT:  Large air volume (Fan speed: High) MED.:  Medium air volume (Fan speed: Medium) LOW:  Small air volume (Fan speed: Low) * While  is displayed, air volume is fixed and cannot be selected.

G: Run lamp		Indicates the operating status of the selected group. OFF: The selected group is not operating. ON: The selected group is operating. Flashing: When an error occurs or the protective device is activated
H: ON button		Starts operation.
I: OFF button		Stops operation.
J: SET TEMP. button		 Increases the set temperature.  Decreases the set temperature.
K: RESET button		Used to reset settings. (Do not usually use this button.)
L: SWING/FIX button		Switches the auto-swing mode and louver direction when no remote controller is used. * This button is disabled in the ALL or ZONE mode.
M: VENT button		Used when a commercially available ventilation fan is connected. Pressing this button runs or stops the connected ventilation fan. When operation of air conditioners is started or stopped, the ventilation fan is also started or stopped at the same time. (While the ventilation fan is running,  is displayed on the display.) * When No function appears on the display when the VENT button is pressed, no ventilation fan is connected. * This button is used to operate and stop the damper when a heat exchange ventilators is connected.
N: SAVE button		Drives the air conditioner into the power saving mode. * When No function appears on the display, the power saving mode is not available for the air conditioner.
O: CENTRAL button		Switches CENTRAL 1 to CENTRAL 4 in the central control mode. No indication: Central control is cleared (individual operation) * This button is disabled in the remote controller mode. Individual: Controls with the remote controller are possible. CENTRAL 1: Disables operation start/stop using the remote controller. CENTRAL 2: Disables operation start/stop, operation mode switching, and temperature setting using the remote controller. CENTRAL 3: Disables operation mode switching and temperature setting using the remote controller. CENTRAL 4: Disables operation mode switching using the remote controller.
P: CL button		Erases the filter mark on the display. This button is also used for the initial settings.
Q: SET button		Used for service or special operations. (Do not usually use these buttons.)
R: CHECK button		
S: ITEM button		Used for enable/disable settings for return-back operation* and timer operation. ITEM  : Selects an item to be set sequentially. (The selected item and the  mark light.) SELECT  : Enables or disables the selected item. * Selectable items may vary depending on models.
T: SELEC T button		

* **[Return-back operation]**







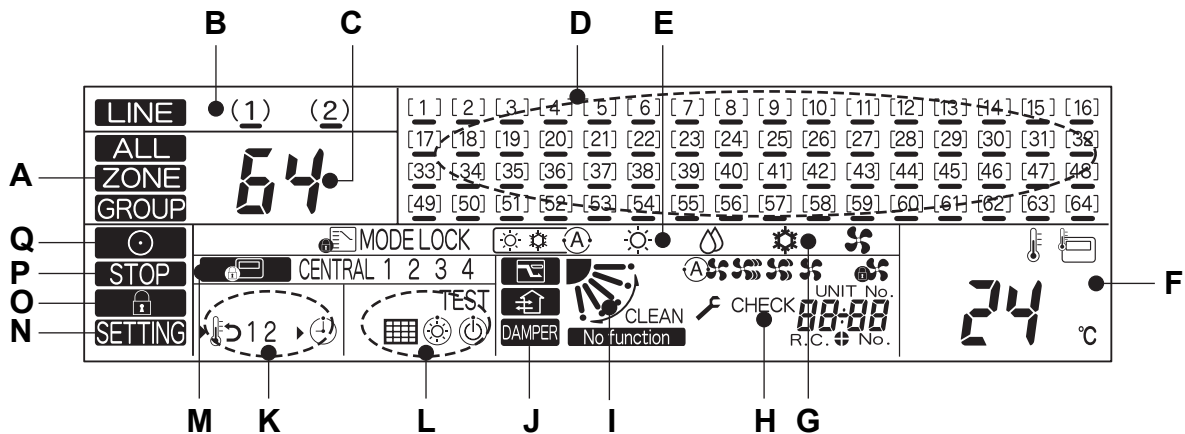















The return-back operation is a function to return the temperature automatically to the set temperature in a predetermined time period if a temperature lower than the specified temperature (for cooling) or higher than the specified temperature (for heating) is set on the remote controller. (For details, refer to the Installation Manual.)

* For the details of power saving mode, refer to the Owner's Manual of the air conditioner.

■ Indications on the LCD panel



A: ALL/ZONE/GROUP	ALL , ZONE , or GROUP is displayed.
B: Line number	<p>When a line is selected, the () mark of the selected line number flashes.</p> <p>The number lights up when any controllable unit is detected on the line.</p> <p>When both line 1 and line 2 are selected, the line of the flashing () mark is displayed.</p> <p>The underline lights when there is at least one operating air conditioner on the line.</p> <p>The underline flashes when an alarm occurs.</p>
C: Zone number	The selected line number, zone number or group number is displayed. ALL 1.2 ZONE 1~64 GROUP 1~64
D: Group number	Connected groups are automatically recognized and displayed. When a group is specified with the GROUP button, it is displayed like . Flashing: Shows the group whose settings are displayed on the panel. Lighting: Shows selected groups. Underline: Shows that the group is operating. The underline flashes when an alarm occurs.
E: Operation mode	The current operation mode is displayed. AUTO: HEAT: DRY: COOL: FAN: * When MODE LOCK lights when the button is pressed, switching of HEAT and COOL operation mode is disabled.
F: Temperature	The set temperature is displayed.
G: Air volume	One of AUTO , HEAT , MED. , LOW , or FIXED is displayed.

H: Check code	When the selected air conditioner is abnormal, its unit number and the check code are displayed.
I: Louver position/swing	Louver position or louver swinging is displayed. (When no remote controller is used.)
J: Functions (1)	 : Lights when the power saving mode is activated.  : Lights when a ventilation fan is running.  : Lights when the  or  button is pressed though the function is not provided.
K: Functions (2)	 1 : Displayed when functions of schedule (*) and return-back operation enabled activated.  2 : * (A separately sold weekly timer is required.) 
L: Functions (3)	 : Indicates that filters should be replaced. TEST : Indicates that a test run is being executed.  : Displayed when the air conditioner cannot operate with the selected operation mode (when heating and cooling modes are mixed in the multi- indoor unit control system).  : Displayed at the beginning of heating operation or during defrosting operation. While this mark is displayed, the indoor fan stops.
M: Central control	CENTRAL 1 2 3 4 : The selected operation prohibited setting (CENTRAL 1, 2, 3, or 4) is displayed in the central control mode.  : Displayed when the central control system is controlling. When the  ,  ,  , or SET TEMP.   button is pressed with remote controller operation disabled by the central control system,  flashes and no setting change is accepted.
N: SETTING	Flashes for several minutes when the power switch is turned on. While this mark is flashing, no setting is enabled because the Smart Manager is recognizing connected groups.
O:  (“Controller Prohibition” mark)	Lights while the controller prohibition function is activated. (While this mark is lighting, no operation is enabled.) * Pressing the  ,  , and  buttons simultaneously switches controller prohibition ON/OFF.
P: STOP	Lights in the emergency stop state due to an alarm signal input. (Ex. fire alarm)
Q:  (“Operating” mark)	Lights when at least one controlled air conditioner is operating. Flashes when at least one air conditioner is abnormal or the protective device is activated.

5 Group Operation

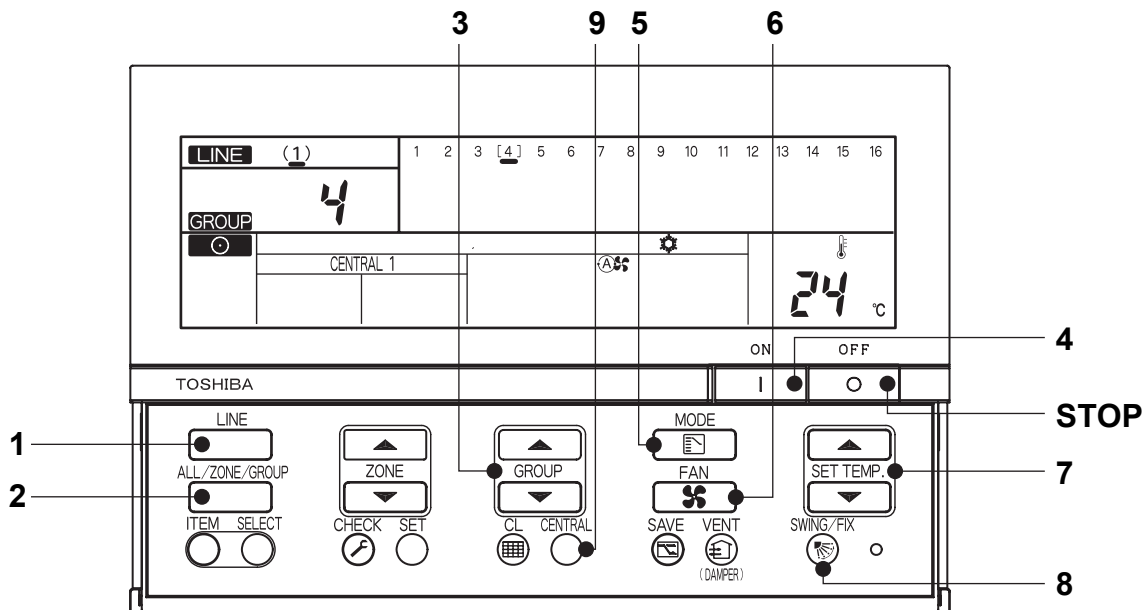

(Example) Operating LINE 1, GROUP 4 (Cooling at 24°C, air volume: AUTO)







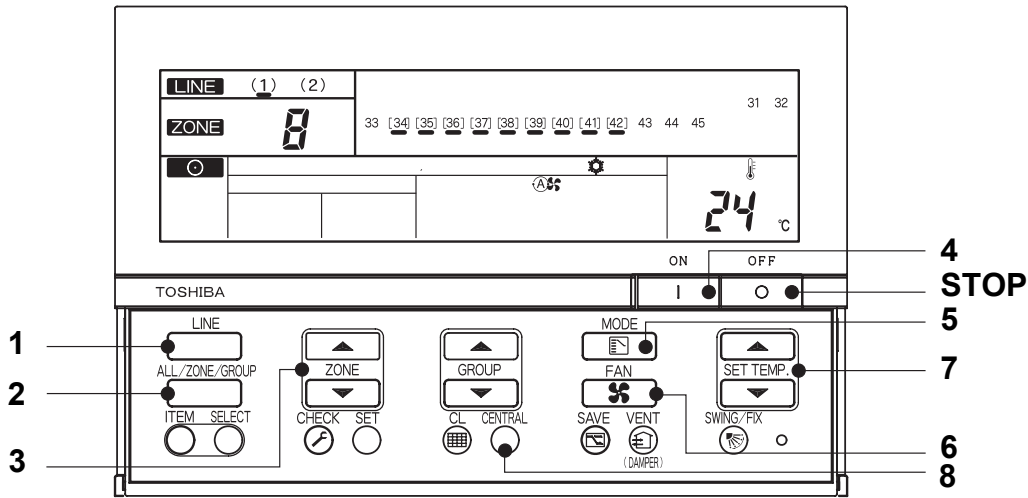



Power on	Turn on the power of the remote controller. (Buttons on the remote controller are disabled while SETTING is displayed, but this is not a fault.)
1 Line switching	Select line 1 with the button.
2 ALL/ZONE/GROUP	Select GROUP with the button.
3 Group switching	Select group number 4 with the buttons. (Group number 4 blinks like .)
4 ON	Press the ON button to start operation.
5 Operation mode switching	Select COOL mode with the button.
6 Air volume switching	Select AUTO air volume with the button.
7 Temperature setting	24°C Set temperature to 24°C with the SET TEMP. buttons.
8 Swing/wind direction setting (When no remote controller is used)	Select a louver position or up/down swinging with the button.
9 Central/individual (Only in the central control mode)	Change the setting with the button. Individual: Controls with the remote controller are possible. CENTRAL 1: Disables operation start/stop using the remote controller. CENTRAL 2: Disables operation start/stop, operation mode switching, and temperature setting using the remote controller. CENTRAL 3: Disables operation mode switching and temperature setting using the remote controller. CENTRAL 4: Disables operation mode switching using the remote controller. “CENTRAL” is displayed for central or individual control other than above.
STOP	Press the OFF button to stop operation.

* Indications on the LCD of the Smart Manager remain unchanged even when operation is stopped.

6 Zone Operation and Simultaneous Operation



(Example) Performing zone operation (LINE 1, ZONE 8, GROUP 34~42 cooling at 24°C, air volume: AUTO) and simultaneous operation (LINE 1, cooling at 24°C, air volume: AUTO)

	Zone operation (LINE 1, ZONE 8, cooling at 24°C, air volume: AUTO)	Simultaneous operation (LINE 1, cooling at 24°C, air volume: AUTO)
Power on	Turn on the power of the remote controller (Buttons on the remote controller are disabled while SETTING is displayed, but this is not a fault.)	
1 Line switching	Select line 1 with the LINE button.  (1)	
2 ALL/ZONE/GROUP	Select ZONE with the ALL/ZONE/GROUP button.	Select ALL with the ALL/ZONE/GROUP button.
3 Zone switching	Select 8 ZONE with the ZONE  and  buttons. ("8" is displayed.)	(Not necessary) ("1" is displayed.)
4 ON	Press the ON button to start operation. (Operation starts one group after another at about one-second interval.)	
5 Operation mode switching	Select COOL mode with the MODE button.  	
6 Air volume switching	Select AUTO air volume with the FAN button.  	
7 Temperature setting	24°C Set temperature to 24°C with the SET TEMP.  and  buttons.	
8 Central/individual (Only in the central control mode)	Change the setting with the CENTRAL button. Individual: Controls with the remote controller are possible. CENTRAL 1: Disables operation start/stop using the remote controller. CENTRAL 2: Disables operation start/stop, operation mode switching, and temperature setting using the remote controller. CENTRAL 3: Disables operation mode switching and temperature setting using the remote controller. CENTRAL 4: Disables operation mode switching using the remote controller. "CENTRAL" is displayed for central or individual control other than above.	
STOP	Press the OFF button to stop operation. 	

- * When **ALL** or **ZONE** is displayed, the **SWING/FIX** button is disabled.
- * Settings when ALL or ZONE is selected: Only the contents that are set in the ALL or ZONE mode are set in each air conditioner.
 (Example) When the **MODE** button is pressed in the ALL or ZONE mode, only the operation mode is set in each air conditioner.
- * Indications on the LCD of the Smart Manager remain unchanged even when operation is stopped.

EN

TOSHIBA CARRIER CORPORATION
336 TADEHARA, FUJI-SHI, SHIZUOKA-KEN 416-8521 JAPAN

DE93919001