

TOSHIBA

AIR CONDITIONER (ACCESSORIES)

Operations Manual

**Air purifier kit
(For 4-Way cassette type)**

Model:

TCB-EAPC1UHP-E

Thank you very much for purchasing TOSHIBA air conditioner.

Please read this Operations Manual carefully before using your air conditioner

- Be sure to obtain the “Operations Manual” and “Installation Manual” from Qualified Installer and Service Person. Request to Qualified Installer and Service Person
- Please clearly explain the contents of the Operations Manual and hand over it.

Observe the safety precautions described in the Installation Manual supplied with the ceiling panel and air conditioner (indoor unit).

Contents

1	COMPONENTS	2
2	PARTS NAME OF REMOTE CONTROLLER	3
3	ADJUSTING CLOCK.....	6
4	LIMITED OPERATION BY GROUP CONTROL.....	7
5	HANDLING THE REMOTE CONTROLLER.....	8
6	HOW TO USE REMOTE CONTROLLER.....	9
7	TEMPORARY OPERATION	15
8	MAINTENANCE AND CLEANING	16

1 COMPONENTS

Remote controller

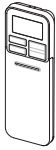

Remote controller holder



Wireless receiver

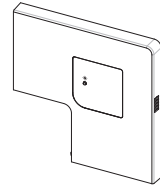

Batteries (two)



Air purifier kit

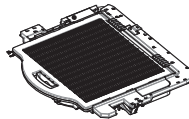

Deodorize filter



■ Names and functions of indicators and controls on Wireless receiver

Display panel

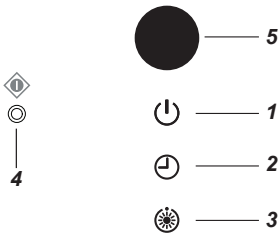

The operating conditions are indicated below.

1 OPERATION (White)

This lamp goes on during operation.

2 TIMER (White)

This lamp goes on white the timer reserved.

NOTE

In case of timer setting by Wired remote controller, TIMER lamp does not light.

In case of group control, TIMER lamp goes on header unit only. (see "4 LIMITED OPERATION BY GROUP CONTROL")

3 Preheat/Defrost (White)

This lamp lights up when the power is turned on or right after heating operation starts or during defrost operation.

CAUTION

• Disagreement in operation mode

If you select AUTOMATIC OPERATION in a model with no auto-changeover (cooling/ heating) control setting or if you select HEAT in a Cool Only model, an alarm sound (pi, pi) from the air conditioner due to disagreement in operation mode. Change the operation mode with the MODE button on the Wireless remote controller. This disagreement indication cannot be deleted by the Wired remote controller.

- When local prohibition is set by the central control from other equipment, no signal is received even if the Remote controller button is pressed. However, a signal of START/STOP button is accepted. (An alarm sound "pi" arises intermittently five times.)

4 TEMPORARY operation

If you misplace or lose the Wireless remote controller or its batteries are exhausted, push the temporary operation button.

- Push the temporary operation button to start the air conditioner. Push this button once again to stop it.

5 Dust indicator (Blue, Green, Yellow, Red)

This lamp lights color change follow room air quality.

- Blue : Air quality "Good"
- Green : Air quality "Moderate"
- Yellow : Air quality "Unhealthy"
- Red : Air quality "Very Unhealthy"

2 PARTS NAME OF REMOTE CONTROLLER

■ Names and functions of indicators and controls on indoor unit

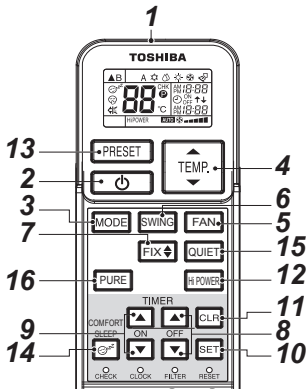

1 Infrared signal emitter

Transmits a signal to the indoor unit.

2 START/STOP button

Press the button to start operation.

(A receiving beep is heard.)

Press the button again to stop operation.

(A receiving beep is heard.)

If no receiving sound is heard from the indoor unit, press the button twice.

3 Mode select button (MODE)

Press this button to select a mode.

Each time you press the button, a mode is selected in a sequence that goes from A : Auto, ❄️ : Cool, 💧 : Dry, ☀️ : Heat, 🌀 : Fan only, and back to A.

(A receiving beep is heard.)

4 Temperature button (TEMP.)

TEMP. ↑The set temperature is increased up to 30°C.

TEMP. ↓The set temperature is dropped down to 17°C. (A receiving beep is heard.)

5 Fan speed button (FAN)

Press this button to select fan speed. When you select AUTO, the fan speed is automatically adjusted according to the room temperature. You can also manually select the desired fan speed from among five settings.

(LOW ■, LOW+ ■■■, MED ■■■■, MED+ ■■■■■, HIGH ■■■■■■)
(A receiving beep is heard.)

6 Auto louver button (SWING)

Press this button to swing the louver.

(A receiving beep is heard.)

Press the SWING button to stop the louver swinging.

(A receiving beep is heard.)

7 Set louver button (FIX)

Press this button to adjust the airflow direction.

(A receiving beep is heard.) While this button is kept depressed, the receiving tone continuously sounds.

8 Off timer button (OFF)

Press this button to set the OFF timer.

9 On timer button (ON)

Press this button to set the ON timer.

10 Reserve button (SET)

Press this button to reserve time settings.

(A receiving beep is heard.)

11 Cancel button (CLR)

Press this button to cancel ON timer and OFF timer. (A receiving beep is heard.)

12 High power button (Hi POWER)

Press this button to start the high power operation.
This function is not operated group control.

13 PRESET button

Press this button to change the operation mode to the preferred operation mode memorized previously. To memorize the operation mode, press this button for at least 3 seconds during the preferred operation mode. **P** is displayed and the operation mode is memorized.

14 COMFORT SLEEP button

Press this button to start the OFF timer operation that automatically adjusts the room temperature and the fan speed. You can select the OFF timer time from four durations (1, 3, 5 or 9 hours).
During group control operation, the set temperature and the fan speed are not automatically adjusted.
Only off timer function is activated.

15 QUIET button

Press this button to start quiet operation. Pressing this button again will restore normal operation.

16 PURE button

Press this button to start Air purifier operation. Pressing this button again will stop Air purifier operation.

■ Names and functions of indications on Wireless remote controller

Display

All indications, except for clock time indication, are indicated by pressing the START/STOP  button.

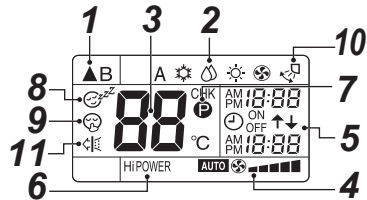





- In the illustration, all indications are indicated for explanation. During operation, only the relevant indications will be indicated on the Remote controller.

1 Transmission mark

This transmission mark () indicates when the Remote controller transmits signals to the indoor unit.







2 Mode display

Indicates the current operation mode.
(A : Auto,  : Cool,  : Dry,  : Heat,  : Fan only)

3 Temperature display

Indicates the temperature setting (17°C to 30°C). When you set the operating mode to : Fan only, no temperature setting is indicated.

4 FAN speed display

Indicates the selected fan speed. AUTO or one of five fan speed levels (LOW , LOW+ , MED , MED+ , HIGH ) can be indicated. Indicates **AUTO** when the operating mode is  : Dry.

5 TIMER and clock time display

The time set for timer operation or clock time is indicated.

The present time is always indicated except for TIMER operation.

6 Hi POWER display

Indicates when the high power operation starts. Press the Hi POWER button to start and press it again to stop the operation.

7 (PRESET) display

Indicated when memorizing the preferred operation mode or when it has been memorized. Also, this icon is indicated when the memorized preferred operation is displayed.

8 (COMFORT SLEEP) display

Indicated during the OFF timer operation that automatically adjusts the room temperature and the fan speed. Each time you press the COMFORT SLEEP button, the display changes in the sequence of 1h, 3h, 5h, and 9h.

9 (QUIET) display

Indicated during the quiet operation.

10 Swing display

Indicated during the swinging operation where the horizontal louver automatically moves up and down.

11 Air purifier display

Indicated during the Air purifier operation are activated.

NOTE

When both Wired remote controller and Wireless remote controller are used, display on the screen of Wireless remote controller may differ from the actual operation in some cases.

■ Preparation and check before use

1. Loading Batteries
 - Remove the battery cover.
 - Insert 2 new batteries (R03 [AAA]) following the (+) and (-) positions.
2. Removing Batteries
 - Remove the battery cover.
 - Remove the 2 used batteries.

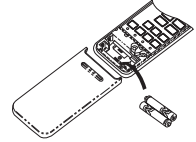

Batteries

- To replace the batteries, use two new batteries (R03 [AAA]).
- In normal use, the batteries will last about one year.
- Replace the batteries if there is no receiving beep from the indoor unit or when the air conditioner cannot be operated using the Remote controller.
- To avoid malfunctions by battery leakage, remove the batteries when not using the Remote controller for more than one month.
- Please dispose of the used batteries according to the local regulation.

3 ADJUSTING CLOCK

Setting the clock



Before you start operating the air conditioner, set the clock of the Remote controller using the procedures given in this section. The clock panel on the Remote controller will indicate the time regardless of whether the air conditioner is in use or not.

■ Initial setting

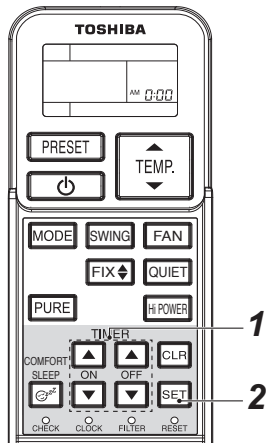
When batteries are inserted in the Remote controller the clock panel will indicate AM 0:00 and will flash.



1 TIMER or button

Press the TIMER  or  button to set the current time.
 Each press of the TIMER button changes the time in one minute steps.
 Pressing the TIMER button continually changes the time in ten minute steps.

2 SET button

Press the SET  button.
 The current time is indicated and the clock starts.

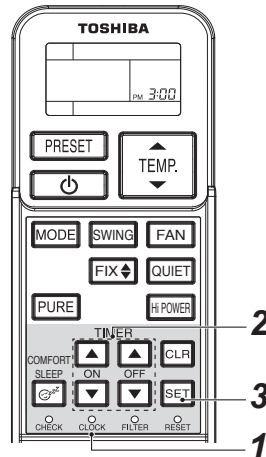

■ Clock adjusting



1 CLOCK button

Press the CLOCK  by tip of a pencil.
 The CLOCK display flashes.

2 TIMER or button

Press the TIMER  or  button to set the current time.
 Each press of the TIMER button changes the time by one minute.
 Pressing the TIMER button continually changes the time by ten minutes.

3 SET button

Press the SET  button.
 The current time is indicated and the clock starts.

4 LIMITED OPERATION BY GROUP CONTROL

NOTE

Group control: Operate air conditioners in more than one system in same time.

Header indoor unit: The representative unit during group control. Receive commands from Wired remote controller and transmit the commands to follower units.

(Header indoor unit is indoor unit that receives START/STOP signal from the Wireless remote control.)

Follower indoor unit: Indoor units other than the Header unit are called follower unit.

A Wired remote controller (separately available) is required for the group control.

▼ Example of group combination

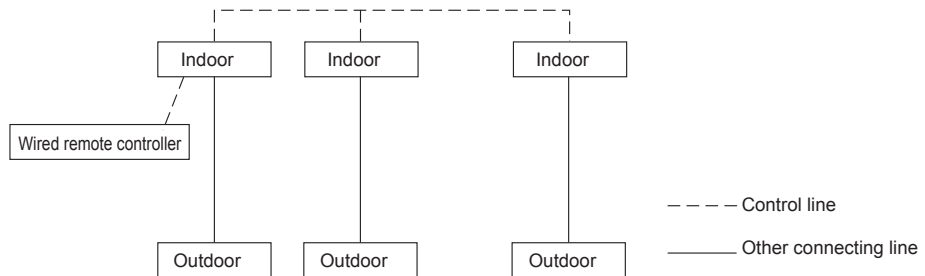

⚠ CAUTION

When using indoor unit in group control,

1. Hi POWER operation will not function.

When Hi POWER is transmitted from Wireless remote controller the receiving sound will be heard from the indoor unit and display on the Wireless remote controller will also change. However, the indoor unit does not operate Hi POWER operation. Restore the display on the Wireless remote controller pushing Hi POWER button.

2. COMFORT SLEEP

When COMFORT SLEEP is transmitted from Wireless remote controller, the receiving sound will be heard from the indoor unit and the display on the Wireless remote controller will also be changed as same as Hi POWER operation. However, the set temperature and the fan speed will not be automatically adjusted. Only off timer function is activated.

3. Units other than the Header unit cannot be operated with Remote controller and the TEMPORARY operation.

When operating air conditioner with Wireless remote controller transmission should be sent to the Header unit.

Header and follower indoor units are decided through address setting upon installation. Follower unit will not receive any signals from Wireless remote controller.

Air conditioner will not work even if the temporary operation button on the follower unit is pressed.

(Some Follower units may receive SWING and FIX, but these operations are performed only on the unit that received the signal.)

(When Wireless remote controller is used, only the Header unit receives SWING signal. If the SWING signal is transmitted to follower unit, the sound to refuse receiving signal (3 beeps) is heard and the follower unit does not receive the signal.

For FIX operation, both Header and follower unit perform the operation by itself. When Wired remote controller is used, airflow direction can be changed on each unit by selecting the indoor unit.)

4. TIMER lamp lights up only on the Header unit.

When the timer is set with Wired remote controller, even the TIMER lamp on the Header unit will not light up.

5 HANDLING THE REMOTE CONTROLLER

CAUTION

- The air conditioner will not operate if curtains, doors or other materials block the signals from the Remote controller to the indoor unit.
- Prevent any liquid from falling into the Remote controller.
Do not expose the Remote controller to direct sunlight or heat.
- If the infrared signal receiver on the indoor unit is exposed to direct sunlight, the air conditioner may not function properly.
Use curtains to prevent the sunlight from reaching the receiver.
- If the room using the air conditioner has fluorescent lighting with electronic starters, signals may not be properly received. If you are planning to use such fluorescent lamps, consult your local dealer.
- If other electrical appliances react to the Remote controller move these appliances or consult your local dealer.

■ Location of the Remote controller

- Keep the Remote controller where its signals can reach the receiver of the indoor unit (a distance of 7 m is allowed).
- When you select the timer operation, the Remote controller automatically transmits a signal to the indoor unit at the specified time.
If you keep the Remote controller in a position that hinders proper signal transmission, a time lag of up to 15 minutes may occur.

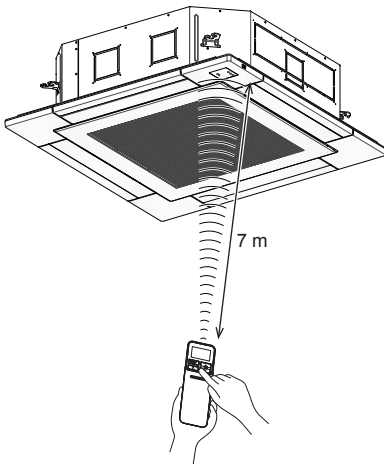

■ Remote controller holder

Installing the remote controller holder

- Before you actually install the remote controller holder on a wall or pillar, check whether the Remote controller signals can be received by the indoor unit.

Mounting and removing the Remote controller

- To mount the remote controller hold it parallel to the remote controller holder and push it in fully. To remove the Remote controller slide the Remote controller upwards and out from the holder.

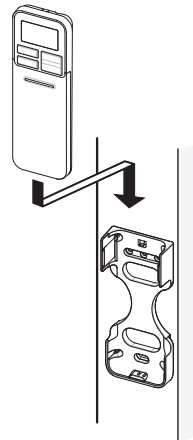

6 HOW TO USE REMOTE CONTROLLER

■ Cooling/heating/fan only operation

Start

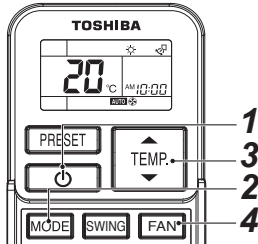

1 START/STOP button ()

Press this button to start the air conditioner.

2 Mode select button (MODE)

Select Cool , Heat , or Fan only .



3 Temperature button ()

Set the desired temperature.

When the air conditioner is in FAN ONLY operation, the temperature display is not indicated.

4 Fan speed button (FAN)

Select one of **AUTO**  LOW , LOW* , MED , MED* , HIGH .

- The  OPERATION lamp on the display panel of the indoor unit goes on. And operation starts after approximately 3 minutes. (If you select FAN ONLY mode, the unit will start immediately.)
 - The  : Fan only mode does not control temperature.
 - Fan speed **AUTO** is the same as HIGH .
- Therefore, perform only steps **1**, **2** and **4** to select this mode.

Stop

START/STOP button ()

Press this button again to stop the air conditioner.

NOTE

When the indoor unit is operated together with a cooling only outdoor model outdoor unit,  appears on the Remote controller but the heating operation is disabled.

■ Dry operation

Start

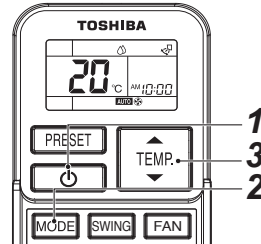

1 START/STOP button ()

Press this button to start the air conditioner.

2 Mode select button (MODE)

Select Dry .

3 Temperature button ()

Set the desired temperature.

- The fan speed display indicates **AUTO**.
- The  OPERATION lamp on the display panel of the indoor unit lights, and operation starts after approximately 3 minutes.

Stop

START/STOP button ()

Press this button again to stop the air conditioner.

■ Automatic operation (auto changeover)

This function is available only for use in combination with a heat recovery model outdoor unit. If this function is used with another model of outdoor unit, "A" (Auto) appears on the Remote controller but the automatic operation is disabled.

Start

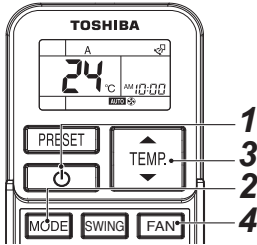

1 START/STOP button ()

Press this button to start the air conditioner.

2 Mode select button (MODE)

Select A.

3 Temperature button ()

Set the desired temperature.

4 Fan speed button (FAN)

Select one of **AUTO** , **LOW** , **LOW*** , **MED** , **MED*** , **HIGH** .

- The OPERATION lamp on the display panel of the indoor unit lights. The operating mode is selected in accordance with the room temperature and operation starts after approximately 3 minutes.
- If the "A" mode is uncomfortable, you can select the desired conditions manually.

Stop

START/STOP button ()

Press this button again to stop the air conditioner.

CAUTION

Disagreement in operation mode

If you select AUTOMATIC OPERATION in a model with no auto-changeover (cooling/heating) control setting or if you select HEAT in a Cool Only model, lamp lights up and and lamps blink alternately with an alarm sound (pi, pi) from the air conditioner due to disagreement in operation mode. Change the operation mode with the MODE button on the Wireless remote controller. This disagreement indication cannot be deleted by the Wired remote controller.

■ Timer operation

Use the Wired remote controller for timer setting if it is also in use.

ON timer and OFF timer

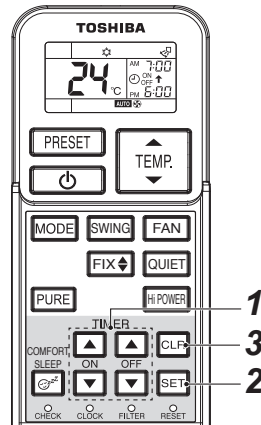

Setting TIMER

1 ON/OFF TIMER button (or)

Press the ON or OFF TIMER buttons as required.

- The previous timer setting is displayed and flashes along with ON/OFF timer display.

Set the timer to the desired time.

Each press of the TIMER button changes the time in ten minute steps. Pressing the TIMER button continually changes the time in one hour step.

2 SET button

Press the SET button to set the timer.

The timer time is indicated and the timer starts.

Cancelling TIMER

3 CLR button

Press the CLR button to cancel the timer setting.

CAUTION

- When you select the timer operation, the Remote controller automatically transmits the timer signal to the indoor unit at the specified time. Therefore, keep the Remote controller in a location where it can transmit the signal to the indoor unit properly. Otherwise, the time lag of up to 15 minutes will occur.
- If you do not press the SET button within 30 seconds after setting the time, the setting will be cancelled.

Once you select the timer operation mode, the settings are saved in the Remote controller. Thereafter, the air conditioner will start operating under the same conditions when you simply press the ON/OFF button of the Remote controller.

If the clock display is flashing, you cannot set the timer.

Follow the instructions in the section "SETTING THE CLOCK" and then set the timer.

Combined timer (Setting both ON and OFF timers simultaneously)

OFF timer → ON timer (Operation → Stop → Operation)



This feature is useful when you want to stop the air conditioner after you go to sleep, and start it again in the morning when you wake up or you return home.

Example:

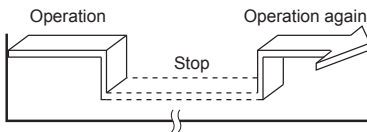
To stop the air conditioner and start it again next morning.



▼ Setting combined TIMER

1. Press the OFF TIMER  button to adjust the OFF timer.
2. Press the ON TIMER  button to adjust the ON timer.
3. Press the SET  button.

ON timer → OFF timer (Stop → Operation → Stop)



You can use this setting to start the air conditioner when you wake up and stop it when you leave the house.

Example:

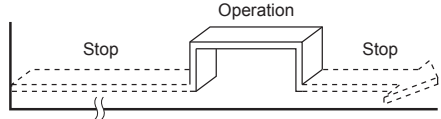
To start the air conditioner next morning and stop it.







▼ Setting combined TIMER

1. Press the ON TIMER  button to adjust the ON timer.
 2. Press the OFF TIMER  button to adjust the OFF timer.
 3. Press the SET  button.
- Either ON or OFF timer function which is closer to the current time, is activated first.
 - If the same time is set for both ON and OFF timers, no timer operation is performed. Also, the air conditioner may stop operating.

Every day combined timer (setting both ON and OFF timer simultaneously and activate every day.)

This feature is useful when you want to use combined timer at the same time every day.

▼ Setting combined TIMER

1. Press the ON TIMER  button to adjust the ON timer.
 2. Press the OFF TIMER  button to adjust the OFF timer.
 3. Press the SET  button.
 4. After step 3, an arrow mark (↑ or ↓) flashes for about 3 seconds and during this flashing, press the SET  button.
- During the every day timer is activating, both arrows (↑, ↓) are indicated.

Cancel the timer operation

Press the CLR  button.

Clock display

During the TIMER operation (ON-OFF, OFF-ON, OFF timer) clock display is disappeared so as to show the setting time. To see the present time, press SET button briefly and the present time is displayed about 3 seconds.

■ High power operation

High power (Hi POWER)

- The Hi POWER (high power operation) mode automatically controls room temperature, airflow and operation mode so that the room is quickly cooled in summer and warmed in winter.

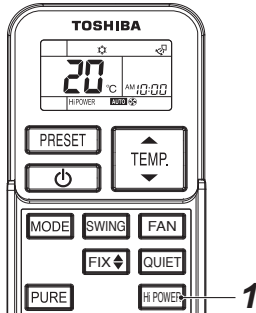

Setting Hi POWER mode

1 Hi POWER button



Press the Hi POWER button after starting any operation. At the same time, the “Hi POWER” mark on the Remote controller is indicated.

Cancelling Hi POWER mode

1 Hi POWER button

Press the Hi POWER button once again. At the same time, the “Hi POWER” mark on the Remote controller goes out.

CAUTION

- The Hi POWER mode cannot be activated in the  DRY and  FAN ONLY operation and when the ON TIMER operation is reserved.
- Hi POWER mode is not available for group control. When Hi POWER is transmitted to the Header indoor unit, the receiving sound is heard but the Hi POWER mode will not be performed. Please cancel the Hi POWER mode.

■ Quiet operation

- The QUIET mode provides quiet operating status by automatically setting the fan speed to the lowest speed.

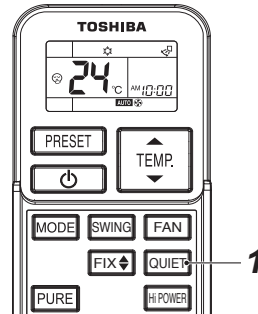

Setting QUIET mode

1 QUIET button

Press the QUIET button after starting any operation.

At the same time, the  mark is indicated.

Cancelling QUIET mode

1 QUIET button

Press the QUIET button once again.

At the same time, the  mark on the Remote controller disappears.

CAUTION

The QUIET mode cannot be activated in the  DRY operation.

NOTE

Under certain conditions, the quiet operation may not provide adequate cooling or heating due to the feature of quietness.

■ Preset Operation

Set your preferred operation mode for future use. The setting is memorized by the unit for future operation (except airflow direction).

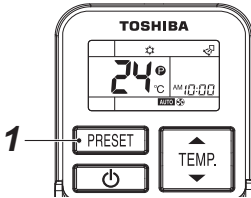

Select your preferred operation.

1 Press the PRESET button for 3 seconds to memorize the setting.

The mark is displayed.

When you press this button next time, the memorized operation mode will be enabled.

■ Air Purifier Operation

Capture efficiency of floating impurities in the air is accelerated by plasma ion charger. They are caught by the air conditioner and eliminated with the drain water.

Thus, the air discharged by the air conditioner is kept clean.

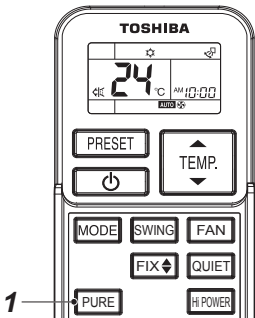

Setting PURE mode

1 PURE button

Press the PURE button after starting any operation.

At the same time, the mark is indicated.

Cancelling PURE mode

1 PURE button

Press the PURE button once again.

At the same time, the mark on the Remote controller disappears.

NOTE

Air purifier operation does not remove harmful substances from cigarette smoke (carbon monoxide etc.).

Open a window occasionally for ventilation.

■ Comfort sleep operation

COMFORT SLEEP mode is a OFF timer operation with automatic temperature and fan speed adjustment.

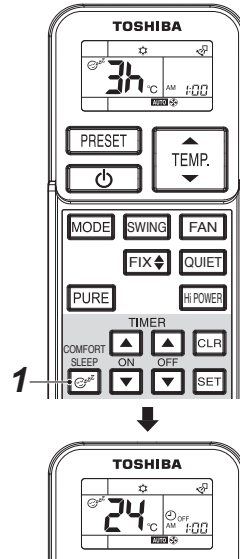

1 Press the COMFORT SLEEP button.

Select 1, 3, 5 or 9 hours for the OFF timer operation.

CAUTION

The COMFORT SLEEP mode is not enabled in the DRY or FAN ONLY operation.

NOTE

- For the cooling operation, the set temperature will automatically increase 1 degree/hour for 2 hours (maximum 2 degrees increase). For the heating operation, the set temperature will decrease.
- During group control operation, the set temperature and the fan speed are not automatically adjusted. Only off timer function is activated.

■ Adjusting airflow direction

- Adjust the airflow direction properly. Otherwise, it might cause discomfort and make the room temperature uneven.
- Adjust the vertical airflow using the Remote controller.
- Adjust the horizontal airflow manually.

Adjust the vertical airflow

The air conditioner automatically adjusts the vertical airflow direction in accordance with the operating conditions when AUTO or A mode is selected.

To set the airflow direction you desire

Perform this function when the air conditioner is in operation.

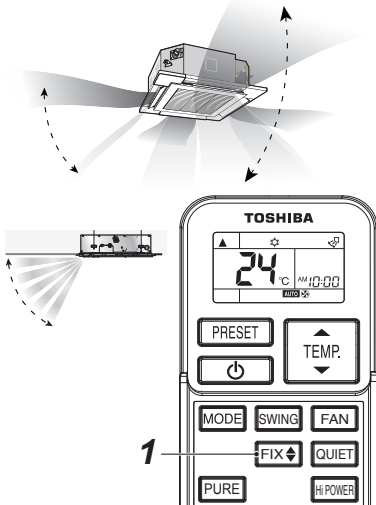

1 FIX button

Keep pressing or pressing briefly the FIX button on the Remote controller to move the louver in the desired direction.

- In subsequent operations, the vertical airflow is automatically set in the direction to which you adjusted the louver using the FIX button.

NOTE

Operating angle of vertical airflow louver will be different during cooling, dry and heating operation.

To automatically swing the airflow direction

Perform this function when the air conditioner is in operation.

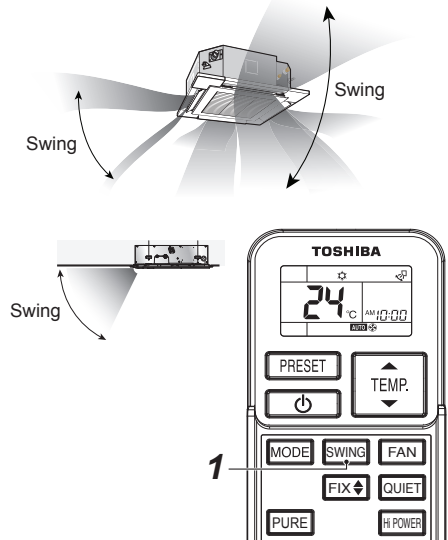

1 SWING button

Press the SWING button on the Remote controller.

- To stop the function, press the SWING button.

⚠ CAUTION

- The FIX and SWING buttons will be disabled when the air conditioner is not in operation (including when the ON timer is set).
- Do not operate the air conditioner for long hours with the airflow direction set downward during the cooling or dry operation. Otherwise, condensation may occur on the surface of the vertical airflow louver and cause dew dripping.
- Do not move the vertical airflow louver manually. Always use the FIX button. If you move the louver manually, it may malfunction during operation. If the louver malfunctions, stop the air conditioner once, and restart.
- When the air conditioner is started immediately after it was stopped, the vertical airflow louver might not move for 10 seconds or so.
- Louver operation is limited when performing group control. (see page 7)

7 TEMPORARY OPERATION

■ TEMPORARY operation

This function is used to operate the unit temporarily in case you misplace the Wireless remote controller or its batteries are exhausted.

- Push the temporary operation button once (less than 3 seconds) to start the air conditioner.
- The last operation conducted with the Wireless remote controller will be performed. (When Wireless remote controller is not used, models with the auto-changeover (cooling/heating) function perform "A" operation, and those without the function perform cooling operation (set temperature: 24°C, fan: HIGH).)

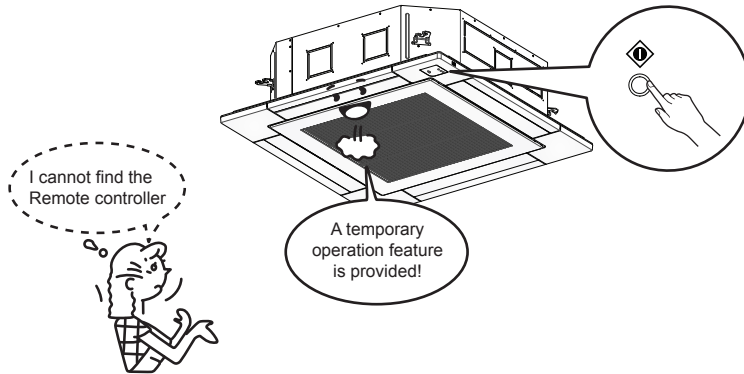

CAUTION

Continuous pressing of the temporary operation button for 10 seconds and above will start the forced cooling operation.

(This will impose burden on the air conditioner. Do not perform this for the purposes other than test run.)
In this time all indicators of indoor unit go on.

8 MAINTENANCE AND CLEANING

The Air purifier unit is based on the principle of collecting cigarette smoke and dust in the room to the dust collection area. After using for a certain period of time, be sure to clean each part as follows.

WARNING

- Cleaning each part involves dangerous work in high places, so be sure to have a qualified installer or qualified service person to do it. Do not attempt it by yourself.
- Before cleaning each part, stop the operation forcibly and turn off the circuit breaker to avoid electric shock.
- Especially, Dust collector and Deodorize filter cleaning shall be done after stop the operation 2 minutes at least to avoid electric shock by electrostatic discharge from Dust collector.

■ Dust collector filter

- Clean every 6 months (assuming 8 hours of daily use) when dust stuck or covers the Dust collector filter.
- Take extra care when cleaning the Dust collector filter.
- Recommend to submerge the Dust collector filter in water then shaking it several times to clean.
- In case of getting heavy dirty on the Dust collector filter, please soak it in lukewarm water at 40°C to 50°C for about 30 minutes with mild detergent and rinse thoroughly with clean water.
- Do not use alcohol, benzene, thinner, polishing powder or chemically-treated duster for cleaning.
- Dry the Dust collector filter in the shade for about half a day or until it completely dry.

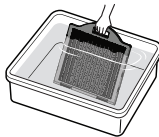

NOTE

- The cleaning frequency of the Dust collector filter depends on the level of impurities in your operation environment. Higher levels of impurities may require more frequent cleaning.

How to disassemble the Dust collector filter

1. Push hook of Main frame at handle position to unlock the Dust collector as below.

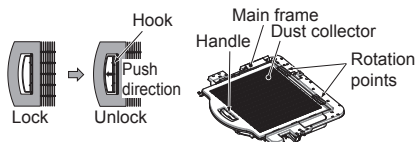

2. Rotate the Dust collector then slide it out of the Main frame follow figure as below.

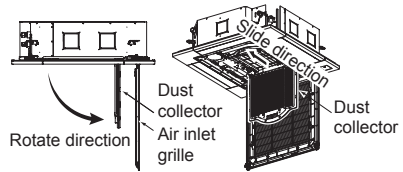

WARNING

- Do not use brush or poke the Dust collector to remove dust as this can cause damage.
- If necessary to dry the Dust collector with the blower, it should low pressure air.
- Please make sure the Dust collector filter is completely dry before use.
- Please avoid drying the Dust collector with a hot air dryer as it may cause damage.

■ Deodorize filter

- Clean every 3-6 months when dust stuck or covers the Deodorize filter.
- Recommend to use vacuum to clean by sucking the dusts which stick or dip inside the Deodorize filter or use the blower to blow the dust go out through the Deodorize filter.
- If necessary to use water to clean, simply use the plain water to wash the Deodorize filter, dry with the sunlight for 3-4 hours or until it completely dry.
- Nevertheless, use hair dryer to dry it. However, washing with water, it may reduce the performance of the Deodorize filter.
- Replace every 2 years or sooner. (contact your dealer to purchase new Deodorize filter)

How to disassemble the Deodorize filter

- Slide the Deodorize filter from the Main frame follow direction shown below.

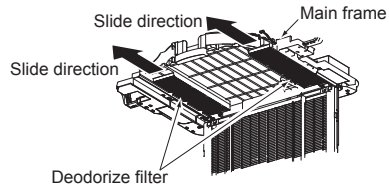

NOTE

- Deodorize filter life depends on the level of impurities in your operation environment. Higher levels of impurities may require more frequent cleaning and replacement.

Toshiba Carrier (Thailand) Co., Ltd.

144 / 9 Moo 5, Bangkadi Industrial Park, Tivanon Road, Tambol Bangkadi, Amphur Muang, Pathumthani 12000, Thailand

1130696201