

# **TOSHIBA**

**R32**

## **Installation Manual**

---

### **Flow Selector unit Multi-port type**

---

---

**RBM-Y1801FU4PE**

**RBM-Y1801FU8PE**

**RBM-Y1801FU12PE**

### Flow Selector unit Multi-port type (hereafter "Flow Selector unit")

Thank you very much for purchasing TOSHIBA Super Heat Recovery Multi Advance (SHRM-A) Air conditioner. Please read this manual carefully before using your Flow Selector unit.

- When installing an indoor or outdoor unit, follow the Installation Manual supplied with the unit.
- To connect the Flow Selector unit to an outdoor unit with pipes, a branching joint or header is required. Choose one according to the capacity of the units.

#### **ADOPTION OF R32 REFRIGERANT**

The Super Heat Recovery Multi Advance has adopted a refrigerant HFC (R32) which does not destroy the ozone layer. This Flow Selector unit is for the R32 refrigerant only. Be sure to use an indoor or outdoor unit in combination with the R32 refrigerant.







## CONTENTS

---

Accessory parts and Parts to be procured locally .....	2
<b>1</b> PRECAUTIONS FOR SAFETY .....	2
<b>2</b> SELECTION OF INSTALLATION PLACE .....	5
<b>3</b> INSTALLATION OF FLOW SELECTOR UNIT .....	7
INSTALLATION OF BATTERY KIT .....	8
<b>4</b> REFRIGERANT PIPING .....	9
<b>5</b> ELECTRICAL CONNECTION .....	12

## Accessory parts and Parts to be procured locally

### ■ Accessory parts



Part name		Q'ty RBM-Y1801			Shape	Usage
		FU4PE	FU8PE	FU12PE		
Installation Manual		1	1	1	This manual	This manual for installer. (For other languages that do not appear in this Installation Manual, Please refer to the enclosed CD-ROM.)
CD-ROM		1	1	1		-
Heat insulating pipe	Ø55	8	16	24		For indoor unit connection
Attached pipe	Ø9.5 – Ø6.4	4	8	12		For liquid pipe of indoor unit connection
	Ø15.9 – Ø12.7 – Ø9.5	4	8	2		For gas pipe of indoor unit connection
Attached pipe for main-pipe	Ø28.6 – Ø22.2	1	1	1		For suction gas pipe of outdoor unit connection
	Ø28.6 – Ø19.1	1	1	1		For high pressure / low pressure gas pipe of outdoor unit connection
	Ø22.2 – Ø19.1	1	1	1		
	Ø22.2 – Ø15.9	1	1	1		
	Ø15.9 – Ø12.7	1	1	1		For liquid pipe of outdoor unit connection
Binding band (L300)		8	16	24		For fixing heat insulating pipes
Cable clamp		3	3	3		For fixing indoor unit communication cables
Washer		8	8	8	M10 × Ø34	For hanging the unit
Stopper pipe	Ø9.5	2	2	2		For liquid pipe of indoor unit connection
	Ø15.9	2	2	2		For gas pipe of indoor unit connection
Heat insulator for stopper pipe	Ø22	2	2	2		For liquid pipe of indoor unit connection
	Ø36	2	2	2		For gas pipe of indoor unit connection

# 1 PRECAUTIONS FOR SAFETY

- Ensure that all Local, National and International regulations are satisfied.
- Read this “PRECAUTIONS FOR SAFETY” carefully before Installation.
- The precautions described below include the important items regarding safety. Observe them without fail.
- After the installation work, perform a trial operation to check for any problem.  
Follow the Owner’s Manual to explain how to use and maintain the unit to the customer.
- Turn off the main power supply switch (or breaker) before the unit maintenance.
- Ask the customer to keep the Installation Manual and explain the customer in detail of this installation completion state.

## ■ Meanings of symbols in this manual





These safety cautions describe important matters concerning safety to prevent injury to users or other people and damages to property. Please read through this manual after understanding the contents below (meanings of indications), and be sure to follow the description.

Indication	Meaning of Indication
 <b>WARNING</b>	Text set off in this manner indicates that failure to adhere to the directions in the warning could result in serious bodily harm (*1) or loss of life if the product is handled improperly.
 <b>CAUTION</b>	Text set off in this manner indicates that failure to adhere to the directions in the caution could result in slight injury (*2) or damage (*3) to property if the product is handled improperly.

\*1: Serious bodily harm indicates loss of eyesight, injury, burns, electric shock, bone fracture, poisoning, and other injuries which leave aftereffect and require hospitalization or long-term treatment as an outpatient.

\*2: Slight injury indicates injury, burns, electric shock, and other injuries which do not require hospitalization or long-term treatment as an outpatient.

\*3: Damage to property indicates damage extending to buildings, household effects, domestic livestock, and pets.

	<b>WARNING</b> (Risk of fire)	This mark is for R32 refrigerant only. Refrigerant type is written on nameplate of outdoor unit. In case that refrigerant type is R32, this unit uses a flammable refrigerant. If refrigerant leaks and comes in contact with fire or heating part, it will create harmful gas and there is risk of fire.
	Read the OWNER'S MANUAL carefully before operation.	
	Service personnel are required to carefully read the OWNER'S MANUAL and INSTALLATION MANUAL before operation.	
	Further information is available in the OWNER'S MANUAL, INSTALLATION MANUAL, and the like.	

## REQUIREMENT

For precautions regarding R32 refrigerant, refer to "Precautions for using R32 refrigerant" in the indoor unit and outdoor unit Installation Manual.

**⚠ WARNING**

---

- **Ask an authorized dealer or qualified installation professional to install/maintain the air conditioner.**  
Inappropriate installation may result in water leakage, electric shock or fire.
- **Turn off the main power supply switch or breaker before attempting any electrical work.**  
Make sure all power switches are off. Failure to do so may cause electric shock.
- **Connect the connecting wire correctly.**  
If the connecting wire is connected in a wrong way, electric parts may be damaged.
- **When moving the air conditioner for the installation into another place, be very careful not to enter any gaseous matter other than the specified refrigerant into the refrigeration cycle.**  
If air or any other gas is mixed in the refrigerant, the gas pressure in the refrigeration cycle becomes abnormally high and it as a result causes pipe burst and injuries on persons.
- **Do not modify this unit by removing any of the safety guards or by by-passing any of the safety interlock switches.**
- **Exposure of unit to water or other moisture before installation may cause a short-circuit of electrical parts.**  
Do not store it in a wet basement or expose to rain or water.
- **After unpacking the unit, examine it carefully if there is possible damage.**
- **Do not install in a place that might increase the vibration of the unit.**

- **To avoid personal injury (with sharp edges), be careful when handling parts.**
- **Perform installation work properly according to the Installation Manual.**  
Inappropriate installation may result in water leakage, electric shock or fire.
- **When the air conditioner is installed in a small room, provide appropriate measures to ensure that the concentration of refrigerant leakage occur in the room does not exceed the critical level.**
- **Install the air conditioner securely in a location where the base can sustain the weight adequately.**
- **Perform the specified installation work to guard against an earthquake.**  
If the air conditioner is not installed appropriately, accidents may occur due to the falling unit.
- **If refrigerant gas has leaked during the installation work, ventilate the room immediately.**  
If the leaked refrigerant gas comes in contact with fire, noxious gas may generate.
- **After the installation work, confirm that refrigerant gas does not leak.**  
If refrigerant gas leaks into the room and flows near a fire source, such as a cooking range, noxious gas might generate.
- **Electrical work must be performed by a qualified electrician in accordance with the Installation Manual.**  
**Make sure the air conditioner uses an exclusive power supply.**  
An insufficient power supply capacity or inappropriate installation may cause fire.

- Use the specified wires for wiring connect the terminals securely fix.  
To prevent external forces applied to the terminals from affecting the terminals.
- Conform to the regulations of the local electric company when wiring the power supply.  
Inappropriate grounding may cause electric shock.
- Do not install the air conditioner in a location subject to a risk of exposure to a combustible gas.  
If a combustible gas leaks, and stays around the unit, a fire may occur.

---

**⚠ CAUTION**

---

**This Air Conditioner has adopted a refrigerant HFC (R32) which does not destroy the ozone layer.**

- As the R32 refrigerant is easily affected by impurities such as moisture, oxidized film, oil, etc., due to the high pressure, be careful not to allow the moisture, dirt, existing refrigerant, refrigerating machine oil, etc., to get mixed up in the refrigeration cycle during the installation work.
  - A special tool for the R32 or R410A refrigerant is required for installation.
  - Use a new and clean piping materials for the connecting pipe so that moisture and dirt are not mixed together during the installation work.
- 

## 2 SELECTION OF INSTALLATION PLACE

---

**⚠ CAUTION**

**Do not install the air conditioner at place where combustible gas may leak.**  
If gas leaks is collected at surrounding the unit, the production of fire may be caused.

**Cautions for Installation at a Place with the Quiet Background Sound**

As the Flow Selector unit incorporates the Pulse motor valve, the refrigerant sound or the operating sound of the Pulse motor valve such as "Bushuu..." generates when exchanging between cooling and heating mode and during defrost operation. Therefore, avoid installing the unit at a place with quiet background sound as follows.

- (1) Rooms with quiet background sound such as bedroom, hospital, or room in a hotel.
- (2) Rooms which have no ceiling and a fabric does not block the residence space from the Flow Selector unit.
- (3) Rooms which have opening port at the ceiling.

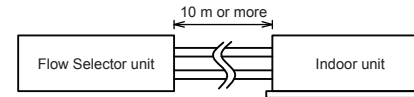

When installing the unit at the above places, separate the unit from the indoor unit (more than 10 m) and install the unit at a place so that sound does not transmit into the room such as in the corridor ceiling.

And take sound proof measure, such as covering around the Flow Selector unit with the sound proofing materials.

---

**Upon customer's approval, install the air conditioner at a place where satisfies the following conditions.**

- Place where Flow Selector unit can be installed horizontally.
- Place which can reserve a service space for safe maintenance or check.

**Apply electric insulation between metal section of the building and metal section of the air conditioner in conformance with the Local Regulation.**

**Avoid the following places.**

- Salty place (seaside area) or place with much gas sulfide (hot spring area)  
(If selecting such a place, a special maintenance is required.)
  - Place where oil (including machine oil), steam, oil smoke or corrosive gas generates.
  - Place where a device generating high frequency (inverter, non-utility generator, medical apparatus, or communication equipment) is set. (A bad influence may generate by malfunction of the air conditioner, control trouble, or noise for such equipment.)
-

## ■ Installation under high-humidity atmosphere

In some cases including the rainy season, especially inside of the ceiling may become high-humidity atmosphere.

1. Installation to inside of the ceiling with tiles on the roof
2. Installation to inside of the ceiling with slated roof
3. Installation to a place where inside of the ceiling is used for pathway to intake the fresh air
4. Installation to a kitchen

- In the above cases, additionally attach the heat insulator to all positions of Flow Selector unit, which come to contact with the high-humidity atmosphere.

[Installation condition for additional insulation]

When the dry-bulb temperature inside the ceiling is 28°C or the relative temperature exceeds 80%  
(The shaded area on the psychrometric chart.)

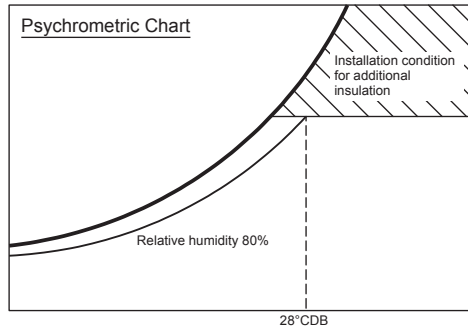

## ■ Installation and service space

Reserve sufficient space required for installation or service work.

- Make space for installation and service. (Make space to the electrical parts box cover side for service.)
- When installing the unit inside the ceiling, be sure to create a check port. The check port is required when the unit is installed and serviced.
- Keep a clearance of 100 mm or more between the top panel of the unit and the ceiling.

## <Installation space>

(Unit : mm)

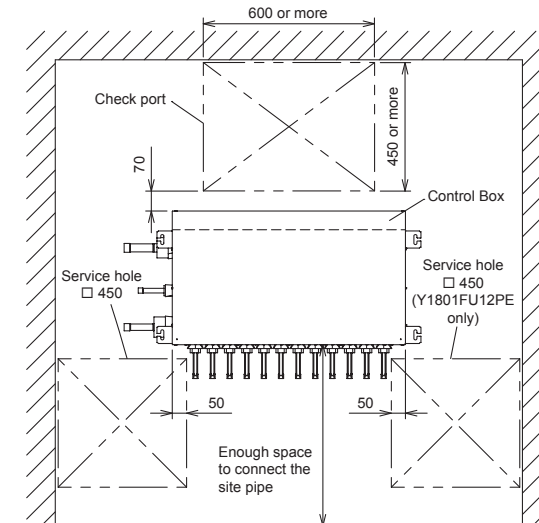
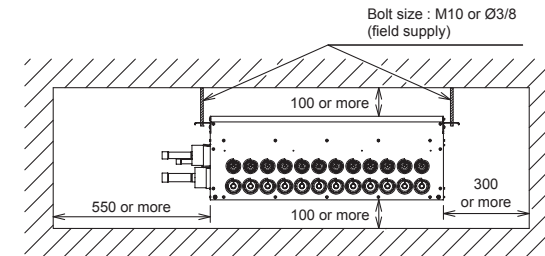

# 3 INSTALLATION OF FLOW SELECTOR UNIT

## ⚠ WARNING

**Install the unit securely in the place to sufficiently withstand the weight of the unit.**  
If the foundation is not sturdy enough, the unit may fall and cause personal injury.

**Perform a specified installation work to guard against earthquake.**  
Improper installation may cause the unit to fall.

## REQUIREMENT

Strictly comply with the following rules to prevent damage of the Flow Selector unit and human injury.

- Do not put a heavy article on the Flow Selector unit or let a person get on it. (Even units are packaged)
- Carry in the Flow Selector unit as it is packaged if possible. If carrying in the Flow Selector unit unpacked by necessity, use buffering cloth or other material to not damage the Flow Selector unit.
- To move the Flow Selector unit, hold the hooking brackets (4 positions) only.  
Do not apply force to the other parts (refrigerant pipe, drain pan, foamed parts, resin parts or other parts).
- Carry the package by two or more persons, and do not bundle it with plastic band at positions other than specified.

## ■ Installation of hanging bolt

- Consider the piping / wiring before the unit is hung to determine the location of the Flow Selector unit installation and orientation.
- After the location of the Flow Selector unit installation has been determined, install hanging bolts.
- For the dimensions of the hanging bolt pitches, refer to the external view.
- When a ceiling already exists, lay the refrigerant pipe, control wires, and remote controller wires to their connection locations before hanging the Flow Selector unit.

Procure hanging bolts washer and nuts for installing the Flow Selector unit (these are not supplied).

Hanging bolt	M10 or W3/8	4 pieces
Nut	M10 or W3/8	12 pieces

## Installation of hanging bolt

Use M10 hanging bolts (4 pcs, locally procured).

Matching to the existing structure, set pitch according to size in the unit external view as shown below.

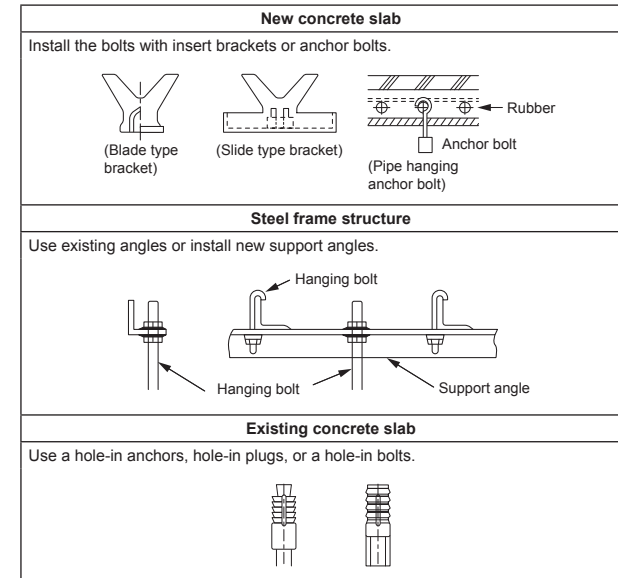

## ■ Installation of Flow Selector unit

### Treatment of ceiling

The ceiling differs according to structure of building.

For details, consult your constructor or interior finish contractor.

In the process after the ceiling board has been removed, it is important to reinforce ceiling foundation (frame) and to keep horizontal level of installed ceiling correctly in order to prevent vibration of ceiling board.

- Attach the nuts and the M10 flat washers to the hanging bolt.
- Put washers at up and down of the hanging bracket of the Flow Selector unit to hang down the Flow Selector unit.
- Check that four sides are horizontal with a level gauge. (Horizontal degree: Within 5 mm)

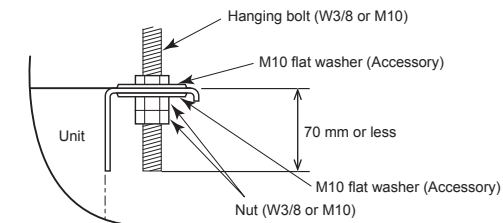



## External view

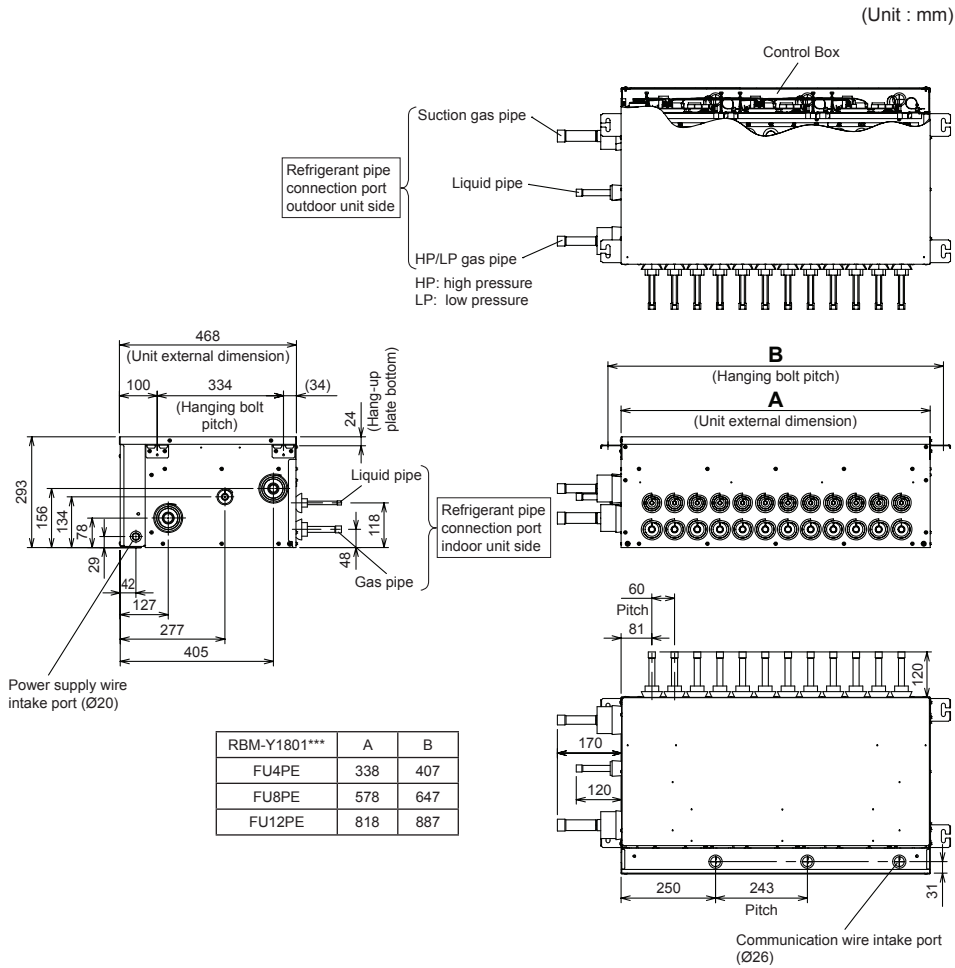

## Installation of Battery kit (TCB-BT1UPE)

- One Battery kit is required for each P.C. board of Flow Selector unit. If even one port of an indoor unit is connected to each P.C. board, a Battery kit for it is required. Refer to the Installation Manual of the outdoor unit for details.
- Do not connect anything except TOSHIBA Battery kit.
- This kit includes a nickel-metal hydride battery (NiMH). For your safety, please read Instruction Manual in Battery kit carefully and handle it with care.
- Do not touch this kit for at least 1 minute after disconnecting power supply at servicing.

1. Loosen the upper side of the cover attachment screws (2 positions) of the electrical control box, and remove the lower side of the screws (2 positions) to remove the cover.
2. Install the Battery kit with the two screws (accessory of Battery kit) in the orientation shown in the figure. When installing the Battery kit, be careful not to let the Battery kit contact the P.C. board of Flow Selector unit and do not pinch the wires with the Battery kit.
3. Connect the connector of the Battery kit to CN521 (RED) on the P.C. board of the Flow Selector unit, which is located on the right side when viewed from the Battery kit.
4. Turn on the No.4 DIP switch of SW03 on the P.C. board where the connector is connected.

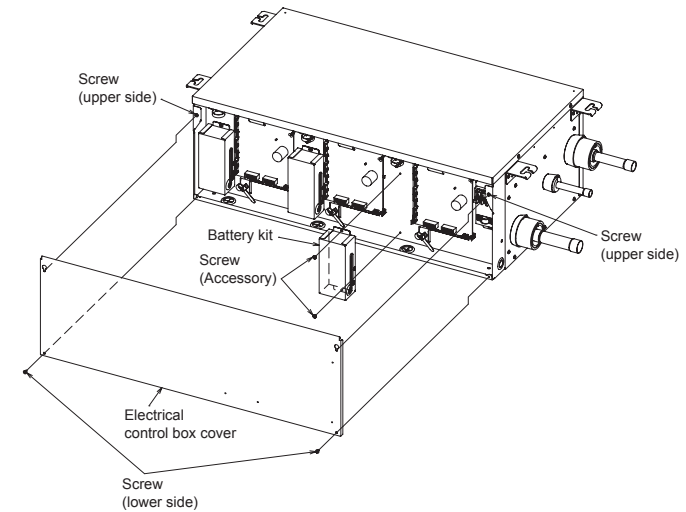

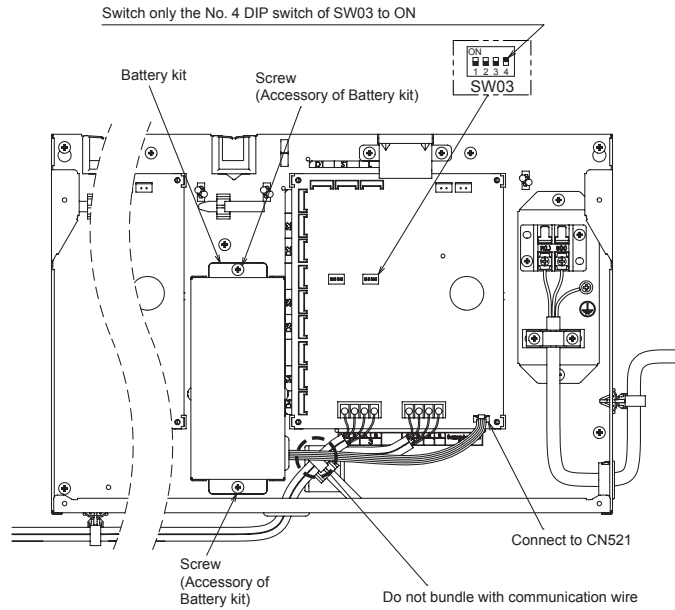

### CAUTION

Do not pull the wire too hard. The connector inside the Battery kit may come off.

### Incorrect

Do not connect the Battery kit to the P.C. board on the left.

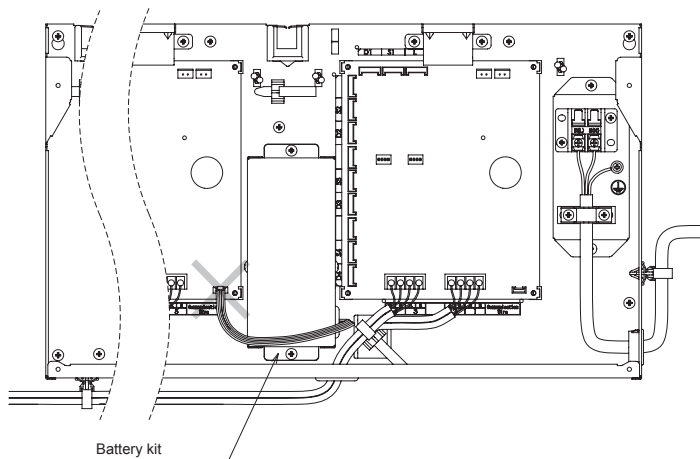

## 4 REFRIGERANT PIPING

### WARNING

If refrigerant gas has leaked during the installation work, ventilate the room immediately.  
If the leaked refrigerant gas comes in contact with fire, noxious gas may be generated.

After the installation work, confirm that refrigerant gas does not leak.

If refrigerant gas leaks into the room and flows near a fire source, such as a fan heater, cooking stove or heating unit, noxious gas may be generated.

### ■ Permissible pipe length and permissible height difference

For piping dimensions, follow the Installation Manual attached to the outdoor unit.

### REQUIREMENT

When the refrigerant pipe is long, set the support brackets to fix the pipe at intervals of 2.5 to 3 m.  
If the pipe is not fixed, noise may be generated.

### ■ Connection pipe size of Flow Selector unit (default)

(Unit : mm)

RBM-Y1801****	Outdoor unit side (Upstream)			Indoor unit side (Downstream)	
	Suction gas pipe	HP/LP gas pipe	Liquid pipe	Gas pipe	Liquid pipe
FU4PE	Ø28.6	Ø22.2	Ø15.9	Ø15.9	Ø9.5
FU8PE					
FU12PE					

HP: high pressure  
LP: low pressure

## ■ Pipe connecting process

- Connect the pipes. (Be sure to use port No.1)
- Use attached-pipe (accessory) to connect the pipe with different diameter from the pipe to Flow Selector unit.

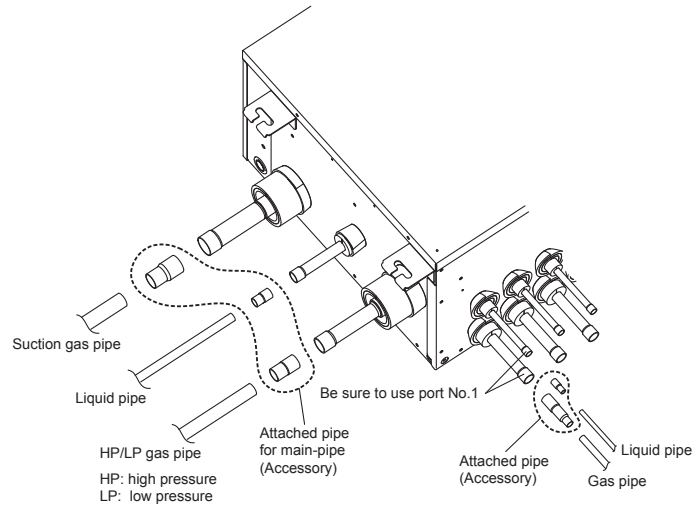

- Use stopper-pipe (accessory) to the port to which indoor unit is not connected.

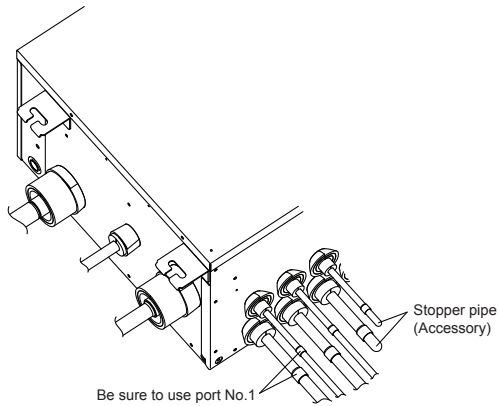

- Be sure to connect the indoor unit to port No. 1 of the Flow Selector unit. (Figure 1)
- Allows the concatenation of two neighboring ports.(Connecting pipes are arranged locally.) (Figure 2)
- The maximum capacity of the indoor unit that may be connected downstream of the combined port is 12.8 HP (horsepower).
- Please observe the following
  - Do not combine more than 3 ports. (Figure 3)
  - Do not make connections between non-adjacent ports. (Figure 4)
  - Do not combine Port No.4 and No.5 (in the case of 8 port and 12 port models) and Port No.8 and No.9 (in the case of 12 port model). (Figure 5)
  - Do not combine Port No.2 and No.3, Port No.6 and No.7, Port No.10 and No.11. (Figure 6)

▼ Figure 1

**Incorrect**

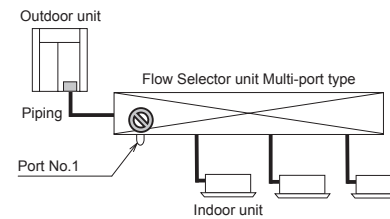

▼ Figure 2

**Correct**

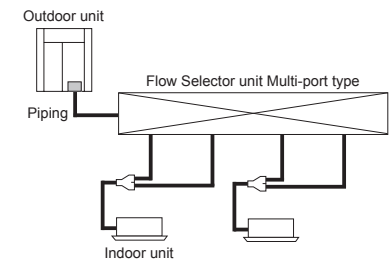

▼ Figure 3

**Incorrect**

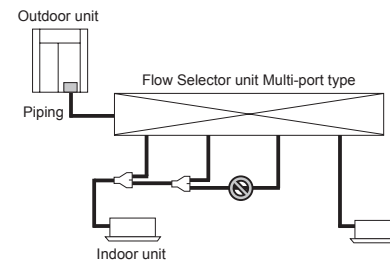

▼ Figure 4

**Incorrect**

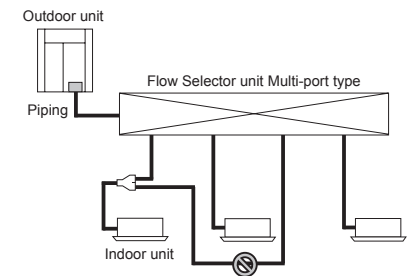

▼ Figure 5  
Incorrect

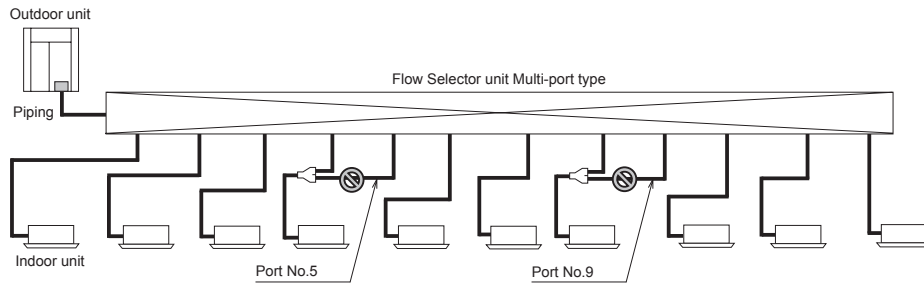

▼ Figure 6  
Incorrect

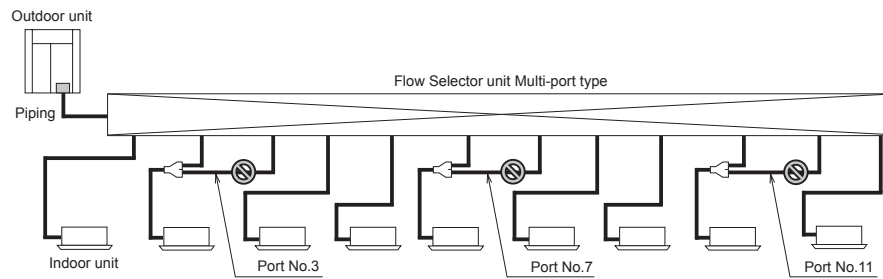

**CAUTION**

\* Be sure to wrap the pipe with wet cloth when applying brazing.

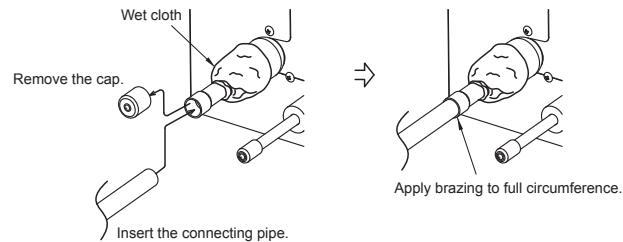

• For a brazing work of the refrigerant pipes, be sure to use nitrogen gas in order to prevent oxidation of the inside of the pipes; otherwise clogging of the refrigerating cycle due to oxidized scale may occur.

\* Remove all flux after brazing.

■ Airtight test/Air purge, etc.

For airtight test, air purge, addition of refrigerant, and gas leak check, follow the Installation Manual attached to the outdoor unit.

**REQUIREMENT**

Be sure to use the tool such as charge hose exclusive to R32 or R410A.  
Do not turn on the power until the airtight test and the vacuuming have finished.  
(If turning on the power, the incorporated PMV is closed fully and the period until the vacuuming finishes elongates.)

■ Open fully valves of the outdoor unit

■ Gas leak check

Check with a leak detector or soap water whether gas leaks or not, from the pipe connecting section.

**REQUIREMENT**

Use a leak detector manufactured exclusively for HFC refrigerant (R32, R410A, R134a, etc.).

■ Heat insulating process

Perform heat insulating for each pipes separately.

In cooling time, temperature at both liquid and gas sides becomes lower.

Therefore, perform heat insulating process sufficiently to avoid dewing.

- For heat insulator of pipe at gas side, be sure to use one with heat-resisting temp. 120°C or more.
- Using the attached heat insulating pipe, perform heat insulating process securely for pipe connecting part of the Flow Selector units without clearance.

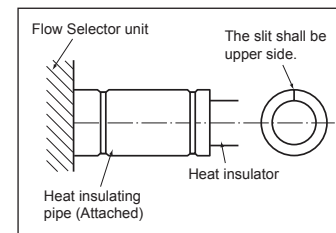

• Indoor unit side

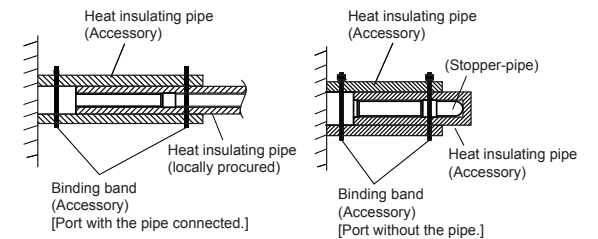

• Outdoor unit side

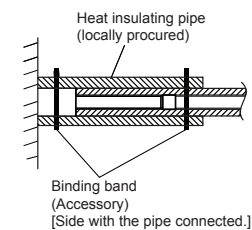

**REQUIREMENT**

Apply the heat insulation to the pipe connecting section of the Flow Selector unit securely up to the root without exposure of the pipe. (The pipe exposed to the outside causes water leak.)

# 5 ELECTRICAL CONNECTION

## ⚠ CAUTION

- If incorrect / incomplete wiring is carried out, it will cause an electrical fire or smoke.
- Use the cord clamps attached to the product.
- Do not damage or scratch the conductive core and inner insulator of power and communication wires when peeling them.
- Use the power cord and communication wire of specified thickness, type, and protective devices required.
- Do not connect 220-240 V power to the terminal blocks (Ⓐ, Ⓑ) for communication wiring. (Otherwise, the system will fail.)
- Perform the electric wiring so that it does not come to contact with the high-temperature part of the pipe. The coating may melt resulting in an accident.

## REQUIREMENT

- For power supply wiring, strictly conform to the Local Regulation in each country.
- After connecting wires to the terminal blocks, provide a trap and fix wires with the cord clamp.
- Run the refrigerant piping line and communication wiring line in the same line.
- Do not turn on the power of the Flow Selector unit until vacuuming of the refrigerant pipes completes.
- This Flow Selector unit has multiple ports. So piping and wiring to the same indoor unit shall be connected to the same number (1, 2, 3, 4 ...) of port.

### ■ Power supply wire and communication wires specifications

Power supply wire and communication wires are locally procured.

For the power supply specifications, follow to the table below. If capacity is little, it is dangerous because overheat or burnout may be caused. For system wiring diagram, follow the Installation Manual attached to the outdoor unit.

#### Power supply

- Power supply wire specification: Cable 3-core 2.5 mm<sup>2</sup>, in conformity with Design 60245 IEC 57.

Power supply	220-240 V ~, 50 Hz 220 V ~, 60 Hz	
Power supply switch / circuit breaker or power supply wiring / fuse rating for Flow Selector units should be selected by the accumulated total current values of the Flow Selector units.		
Power supply wiring	Below 50 m	2.5 mm <sup>2</sup>

#### Safety device

- This circuit must be protected with the required safety devices like a main switch, a slow blow fuse on each phase and an earth leakage circuit breaker.
- When using residual current operated circuit breakers, be sure to use a high-speed type (0.1 second or less) 30 mA rated residual operating current.

RBM-	MCA (A)	MOCP (A)
Y1801FU4PE	0.6	15
Y1801FU8PE	0.9	
Y1801FU12PE	1.2	

MCA: Min. Circuit Amps

MOCP: Maximum Overcurrent Protection (Amps)

## Communication wiring

- 2-core with non-polarity wire is used for wiring of the communication wiring.

• Wire size : 0.5 mm <sup>2</sup> to 2.0 mm <sup>2</sup>
• Up to 300 m (L1 + L2 + L3 + L4)

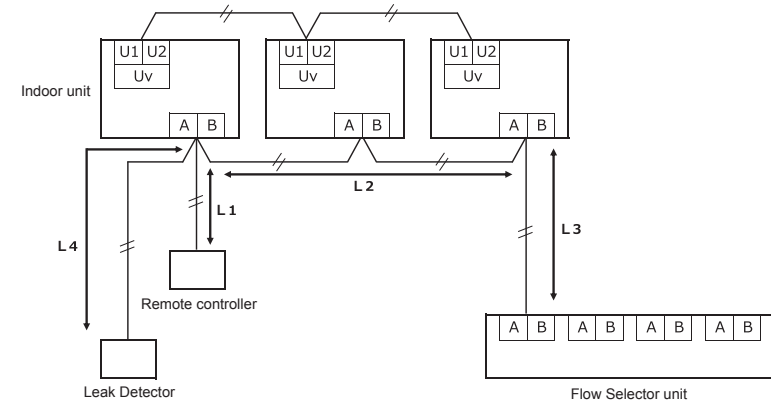

## ⚠ CAUTION

The communication wiring and AC 220-240 V wires cannot be parallel to contact each other and cannot be stored in the same conduits. If doing so, a trouble may be caused on the control system due to noise or other factor.

### ■ Wire connection

#### REQUIREMENT

- Connect the wires matching the terminal numbers. Incorrect connection causes a trouble.
- Pass the wires through the bushing of wire connection holes of the Flow Selector unit.
- Keep a margin (Approx. 100 mm) on a wire to hang down the electrical control box at servicing.
- The low-voltage circuit is provided for the communication wires. (Do not connect the high-voltage circuit)

- 1 Loosen the upper side of the cover attachment screws (2 positions) of the electrical control box, and remove the lower side of the screws (2 positions) to remove the cover.
- 2 The cable clamp (accessory) is installed in the underside of the Flow Selector unit.
- 3 Connect the power supply wire and communication wires to the terminal blocks of the electrical control box.
- 4 Tighten screws of the terminal block securely, and fix the wires with cord clamp attached to the electrical control box. (Do not apply tension to the connecting section of the terminal block.)
- 5 Mount the cover of the electrical control box so that it does not pinch the wires.

▼ Connecting power supply wire and communication wires

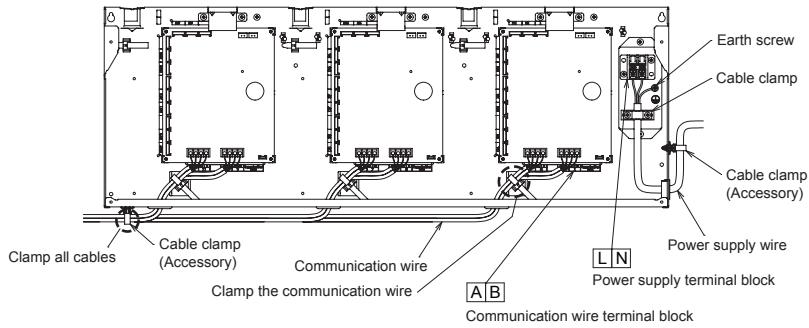
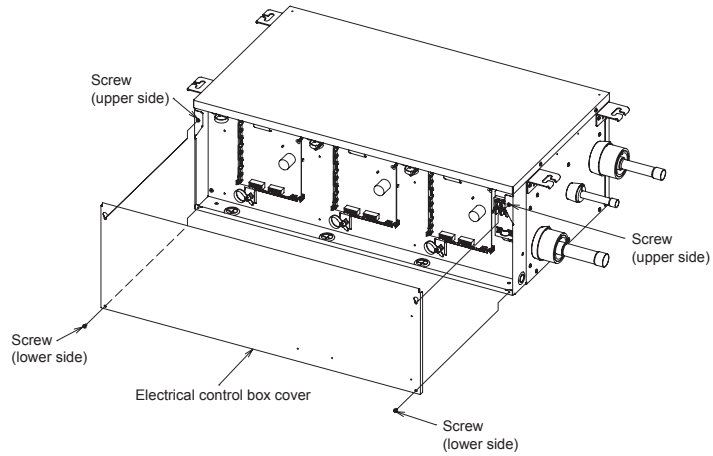

When wiring the communication wire from the right side.

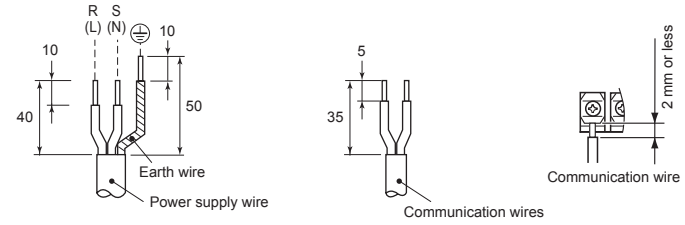
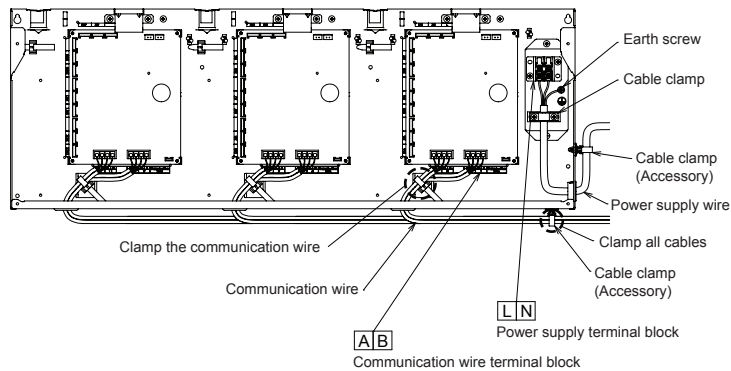

See the figure on the left for connecting wires to the terminal.

Communication wiring

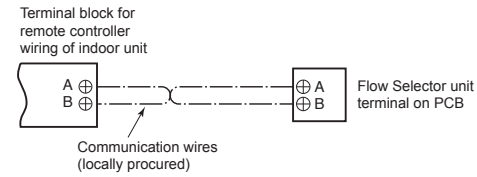

■ In the case of connecting two ports

The communication wire should be connected only to the port with the smaller number. (In the figure below, Port No.1 and Port No.3)  
Set the DN code according to the Installation Manual of the outdoor unit.

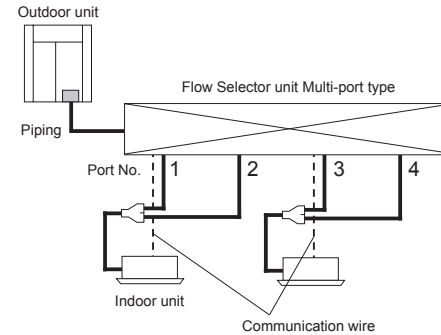



# Toshiba Carrier (Thailand) Co., Ltd.

144 / 9 Moo 5, Bangkadi Industrial Park, Tivanon Road, Tambol Bangkadi, Amphur Muang, Pathumthani 12000, Thailand

1143012099