

TOSHIBA

SERVICE MANUAL

AIR-CONDITIONER (SPLIT TYPE)

OUTDOOR UNIT
<DIGITAL INVERTER>

RAV-GM1601ATP-E (TR)
RAV-GM1601ATJP-E

R32

INVERTER



Original instruction Adoption of R32 Refrigerant

This air conditioner adopts the HFC refrigerant (R32) which does not destroy the ozone layer.
This outdoor unit is designed exclusively for use with R32 refrigerant. Be sure to use in combination with a R32 refrigerant indoor unit.

CONTENTS

SAFETY CAUTION	3
1. SPECIFICATIONS	17
1-1. Outdoor Unit	17
1-2. Operation Characteristic Curve	18
2. CONSTRUCTION VIEWS (EXTERNAL VIEWS)	19
3. SYSTEMATIC REFRIGERATING CYCLE DIAGRAM	22
3-1. Indoor Unit	22
3-2. Outdoor Unit	24
4. WIRING DIAGRAM	25
5. SPECIFICATIONS OF ELECTRICAL PARTS	26
6. REFRIGERANT R32	27
6-1. Safety During Installation/Serviceing	27
6-2. Refrigerant Piping Installation	27
6-3. Tools	31
6-4. Recharging of Refrigerant	31
6-5. Brazing of Pipes	32
6-6. Instructions for Re-use Piping of R22 or R407C	34
6-7. Charging additional refrigerant	36
6-8. Tolerance of Pipe Length and Pipe Head	37
6-9. Additional Refrigerant Amount	39
6-10. Piping Materials and Sizes	41
6-11. Branch Pipe	42
6-12. Distributor	42
6-13. General Safety precautions for using R32 refrigerant	43
7. OUTDOOR CONTROL CIRCUIT	44
7-1. Outline of Main Controls	44
7-2. Outdoor Print Circuit Board	49
8. TROUBLESHOOTING	50
8-1. Summary of Troubleshooting	50
8-2. Troubleshooting	52
8-3. Table Inspection of outdoor unit main parts	73
9. SETUP AT LOCAL SITE AND OTHERS	74
9-1. Calling of Error History	74
9-2. Group Control Operation	74
9-3. Outdoor Unit	76
10. ADDRESS SETUP	85
10-1. Address Setup Procedure	85
10-2. Address Setup & Group Control	86
10-3. Remote Controller Wiring	89
10-4. Address Setup (Manual setting from remote controller)	89
10-5. Confirmation of Indoor Unit No. Position	90
11. REPLACEMENT OF THE SERVICE P.C. BOARD	92
12. HOW TO EXCHANGE COMPRESSOR	93
12-1. Exchanging Procedure of Compressor (Outline)	93
12-2. Exchange of Compressor	93
13. DETACHMENTS	94
14. EXPLODED VIEWS AND PARTS LIST	102

SAFETY CAUTION

Please read carefully through these instructions that contain important information which complies with the Machinery Directive (Directive 2006/42/EC), and ensure that you understand them. Some of the details provided in these instructions differ from the service manual, and the instructions provided here take precedence.

Generic Denomination: Air Conditioner

Definition of Qualified Installer or Qualified Service Person

The air conditioner must be installed, maintained, repaired and removed by a qualified installer or qualified service person.

When any of these jobs is to be done, ask a qualified installer or qualified service person to do them for you. A qualified installer or qualified service person is an agent who has the qualifications and knowledge described in the table below.

Agent	Qualifications and knowledge which the agent must have
Qualified installer (*1)	<ul style="list-style-type: none"> • The qualified installer is a person who installs, maintains, relocates and removes the air conditioners made by Toshiba Carrier Corporation. He or she has been trained to install, maintain, relocate and remove the air conditioners made by Toshiba Carrier Corporation or, alternatively, he or she has been instructed in such operations by an individual or individuals who have been trained and is thus thoroughly acquainted with the knowledge related to these operations. • The qualified installer who is allowed to do the electrical work involved in installation, relocation and removal has the qualifications pertaining to this electrical work as stipulated by the local laws and regulations, and he or she is a person who has been trained in matters relating to electrical work on the air conditioners made by Toshiba Carrier Corporation or, alternatively, he or she has been instructed in such matters by an individual or individuals who have been trained and is thus thoroughly acquainted with the knowledge related to this work. • The qualified installer who is allowed to do the refrigerant handling and piping work involved in installation, relocation and removal has the qualifications pertaining to this refrigerant handling and piping work as stipulated by the local laws and regulations, and he or she is a person who has been trained in matters relating to refrigerant handling and piping work on the air conditioners made by Toshiba Carrier Corporation or, alternatively, he or she has been instructed in such matters by an individual or individuals who have been trained and is thus thoroughly acquainted with the knowledge related to this work. • The qualified installer who is allowed to work at heights has been trained in matters relating to working at heights with the air conditioners made by Toshiba Carrier Corporation or, alternatively, he or she has been instructed in such matters by an individual or individuals who have been trained and is thus thoroughly acquainted with the knowledge related to this work.
Qualified service person (*1)	<ul style="list-style-type: none"> • The qualified service person is a person who installs, repairs, maintains, relocates and removes the air conditioners made by Toshiba Carrier Corporation. He or she has been trained to install, repair, maintain, relocate and remove the air conditioners made by Toshiba Carrier Corporation or, alternatively, he or she has been instructed in such operations by an individual or individuals who have been trained and is thus thoroughly acquainted with the knowledge related to these operations. • The qualified service person who is allowed to do the electrical work involved in installation, repair, relocation and removal has the qualifications pertaining to this electrical work as stipulated by the local laws and regulations, and he or she is a person who has been trained in matters relating to electrical work on the air conditioners made by Toshiba Carrier Corporation or, alternatively, he or she has been instructed in such matters by an individual or individuals who have been trained and is thus thoroughly acquainted with the knowledge related to this work. • The qualified service person who is allowed to do the refrigerant handling and piping work involved in installation, repair, relocation and removal has the qualifications pertaining to this refrigerant handling and piping work as stipulated by the local laws and regulations, and he or she is a person who has been trained in matters relating to refrigerant handling and piping work on the air conditioners made by Toshiba Carrier Corporation or, alternatively, he or she has been instructed in such matters by an individual or individuals who have been trained and is thus thoroughly acquainted with the knowledge related to this work. • The qualified service person who is allowed to work at heights has been trained in matters relating to working at heights with the air conditioners made by Toshiba Carrier Corporation or, alternatively, he or she has been instructed in such matters by an individual or individuals who have been trained and is thus thoroughly acquainted with the knowledge related to this work.

Definition of Protective Gear

When the air conditioner is to be transported, installed, maintained, repaired or removed, wear protective gloves and “safety” work clothing.



In addition to such normal protective gear, wear the protective gear described below when undertaking the special work detailed in the table below.

Failure to wear the proper protective gear is dangerous because you will be more susceptible to injury, burns, electric shocks and other injuries.

Work undertaken	Protective gear worn
All types of work	Protective gloves “Safety” working clothing
Electrical-related work	Gloves to provide protection for electricians Insulating shoes Clothing to provide protection from electric shock
Work done at heights (50 cm or more)	Helmets for use in industry
Transportation of heavy objects	Shoes with additional protective toe cap
Repair of outdoor unit	Gloves to provide protection for electricians



The important contents concerned to the safety are described on the product itself and on this Service Manual. Please read this Service Manual after understanding the described items thoroughly in the following contents (Indications/Illustrated marks), and keep them.

[Explanation of indications]

Indication	Explanation
 DANGER	Indicates contents assumed that an imminent danger causing a death or serious injury of the repair engineers and the third parties when an incorrect work has been executed.
 WARNING	Indicates possibilities assumed that a danger causing a death or serious injury of the repair engineers, the third parties, and the users due to troubles of the product after work when an incorrect work has been executed.
 CAUTION	Indicates contents assumed that an injury or property damage (*) may be caused on the repair engineers, the third parties, and the users due to troubles of the product after work when an incorrect work has been executed.

* Property damage : Enlarged damage concerned to property, furniture, and domestic animal/pet

[Explanation of illustrated marks]





Mark	Explanation
	Indicates prohibited items (Forbidden items to do) The sentences near an illustrated mark describe the concrete prohibited contents.
	Indicates mandatory items (Compulsory items to do) The sentences near an illustrated mark describe the concrete mandatory contents.
	Indicates cautions (Including danger/warning) The sentences or illustration near or in an illustrated mark describe the concrete cautious contents.



■ Warning Indications on the Air Conditioner Unit



[Confirmation of warning label on the main unit]

Confirm that labels are indicated on the specified positions
If removing the label during parts replace, stick it as the original.

Meaning of symbols displayed on the unit

	<p>WARNING (Risk of fire)</p>	<p>This mark is for R32 refrigerant only. Refrigerant type is written on nameplate of outdoor unit. In case that refrigerant type is R32, this unit uses a flammable refrigerant. If refrigerant leaks and comes in contact with fire or heating part, it will create harmful gas and there is risk of fire.</p>
	<p>Read the OWNER'S MANUAL carefully before operation.</p>	
	<p>Service personnel are required to carefully read the OWNER'S MANUAL and INSTALLATION MANUAL before operation.</p>	
	<p>Further information is available in the OWNER'S MANUAL, INSTALLATION MANUAL, and the like.</p>	



Warning indication	Description
 <p>WARNING ELECTRICAL SHOCK HAZARD Disconnect all remote electric power supplies before servicing.</p>	<p>WARNING ELECTRICAL SHOCK HAZARD Disconnect all remote electric power supplies before servicing.</p>
 <p>WARNING Moving parts. Do not operate unit with grille removed. Stop the unit before the servicing.</p>	<p>WARNING Moving parts. Do not operate unit with grille removed. Stop the unit before the servicing.</p>
 <p>CAUTION High temperature parts. You might get burned when removing this panel.</p>	<p>CAUTION High temperature parts. You might get burned when removing this panel.</p>

	<p>WARNING</p> <p>Capacitor connected within this disconnect or downstream upon shutdown wait 5 minute to allow capacitors to discharge.</p>	<p>WARNING</p> <p>Open the service valves before the operation, otherwise there might be the burst.</p>
	<p>CAUTION</p> <p>BURST HAZARD</p> <p>Open the service valves before the operation, otherwise there might be the burst.</p>	<p>CAUTION</p> <p>BURST HAZARD</p> <p>Open the service valves before the operation, otherwise there might be the burst.</p>
	<p>CAUTION</p> <p>Do not touch the aluminum fins of the unit. Doing so may result in injury.</p>	<p>CAUTION</p> <p>Do not touch the aluminum fins of the unit. Doing so may result in injury.</p>

Precaution for Safety









The appliance shall be installed in accordance with national wiring regulations. Capacity shortages of the power circuit or an incomplete installation may cause an electric shock or fire.





DANGER





 Turn off breaker.	Before carrying out the installation, maintenance, repair or removal work, be sure to set the circuit breaker to the OFF position. Otherwise, electric shocks may result.
	Before opening the intake grille of the indoor unit or service panel of the outdoor unit, set the circuit breaker to the OFF position. Failure to set the circuit breaker to the OFF position may result in electric shocks through contact with the interior parts.
	Only a qualified installer (*1) or qualified service person (*1) is allowed to remove the intake grille of the indoor unit or service panel of the outdoor unit and do the work required.
	Before starting to repair the outdoor unit fan or fan guard, be absolutely sure to set the circuit breaker to the OFF position, and place a "Work in progress" sign on the circuit breaker.
 Prohibition	When cleaning the filter or other parts of the indoor unit, set the circuit breaker to OFF without fail, and place a "Work in progress" sign near the circuit breaker before proceeding with the work.
	Do not turn ON the circuit breaker under the condition of removing a cabinet, a panel, etc. Otherwise, it leads to an electric shock with a high voltage, resulting in loss of life.



WARNING

 General	Before starting to repair the air conditioner, read carefully through the Service Manual, and repair the air conditioner by following its instructions.
	Only qualified service person (*1) is allowed to repair the air conditioner. Repair of the air conditioner by unqualified person may give rise to a fire, electric shocks, injury, water leaks and/or other problems.
	Only a qualified installer (*1) or qualified service person (*1) is allowed to carry out the electrical work of the air conditioner. Under no circumstances must this work be done by an unqualified individual since failure to carry out the work properly may result in electric shocks and/or electrical leaks.
	Wear protective gloves and safety work clothing during installation, servicing and removal.
	When connecting the electrical wires, repairing the electrical parts or undertaking other electrical jobs, wear gloves to provide protection for electricians, insulating shoes and clothing to provide protection from electric shocks. Failure to wear this protective gear may result in electric shocks.
	Use wiring that meets the specifications in the Installation Manual and the stipulations in the local regulations and laws. Use of wiring which does not meet the specifications may give rise to electric shocks, electrical leakage, smoking and/or a fire.
	Only a qualified installer (*1) or qualified service person (*1) is allowed to undertake work at heights using a stand of 50 cm or more.
	When working at heights, use a ladder which complies with the ISO 14122 standard, and follow the procedure in the ladder's instructions. Also wear a helmet for use in industry as protective gear to undertake the work.
	When working at heights, put a sign in place so that no-one will approach the work location, before proceeding with the work. Parts and other objects may fall from above, possibly injuring a person below.
	Do not touch the aluminum fin of the outdoor unit. You may injure yourself if you do so. If the fin must be touched for some reason, first put on protective gloves and safety work clothing, and then proceed.
	Do not climb onto or place objects on top of the outdoor unit. You may fall or the objects may fall off of the outdoor unit and result in injury.
	When transporting the air conditioner, wear shoes with additional protective toe caps.
	When transporting the air conditioner, do not take hold of the bands around the packing carton. You may injure yourself if the bands should break.
	This air conditioner has passed the pressure test as specified in IEC 60335-2-40 Annex EE.



 Electric shock hazard	When you access inside of the electric cover to repair electric parts, wait for about five minutes after turning off the breaker. Do not start repairing immediately. Otherwise you may get electric shock by touching terminals of high-voltage capacitors. Natural discharge of the capacitor takes about five minutes.
 Prohibition	Place a "Work in progress" sign near the circuit breaker while the installation, maintenance, repair or removal work is being carried out. There is a danger of electric shocks if the circuit breaker is set to ON by mistake. When checking the electric parts, removing the cover of the electric parts box of Indoor Unit and/or front panel of Outdoor Unit inevitably to determine the failure, put a sign "Do not enter" around the site before the work. Failure to do this may result in third person getting electric shock. Before operating the air conditioner after having completed the work, check that the electrical parts box cover of the indoor unit and service panel of the outdoor unit are closed, and set the circuit breaker to the ON position. You may receive an electric shock if the power is turned on without first conducting these checks.
 Stay on protection	If, in the course of carrying out repairs, it becomes absolutely necessary to check out the electrical parts with the electrical parts box cover of one or more of the indoor units and the service panel of the outdoor unit removed in order to find out exactly where the trouble lies, wear insulated heat-resistant gloves, insulated boots and insulated work overalls, and take care to avoid touching any live parts. You may receive an electric shock if you fail to heed this warning. Only qualified service person (*1) is allowed to do this kind of work.
 Check earth wires.	Before troubleshooting or repair work, check the earth wire is connected to the earth terminals of the main unit, otherwise an electric shock is caused when a leak occurs. If the earth wire is not correctly connected, contact an electric engineer for rework. After completing the repair or relocation work, check that the ground wires are connected properly. Be sure to connect earth wire. (Grounding work) Incomplete grounding causes an electric shock. Do not connect ground wires to gas pipes, water pipes, and lightning rods or ground wires for telephone wires.
 Prohibition of modification.	Do not modify the products. Do not also disassemble or modify the parts. It may cause a fire, electric shock or injury.
 Use specified parts.	When any of the electrical parts are to be replaced, ensure that the replacement parts satisfy the specifications given in the Service Manual (or use the parts contained on the parts list in the Service Manual). Use of any parts which do not satisfy the required specifications may give rise to electric shocks, smoking and/or a fire. Replace components only with parts specified by the manufacturer. Other parts may result in the ignition of refrigerant in the atmosphere from a leak.
 Do not bring a child close to the equipment.	If, in the course of carrying out repairs, it becomes absolutely necessary to check out the electrical parts with the electrical parts box cover of one or more of the indoor units and the service panel of the outdoor unit removed in order to find out exactly where the trouble lies, place Keep out signs around the work site before proceeding. Third-party individuals may enter the work site and receive electric shocks if this warning is not heeded.
 Insulating measures	Connect the cut-off lead wires with crimp contact, etc., put the closed end side upward and then apply a water-cut method, otherwise a leak or production of fire is caused at the users' side.

 No fire	<p>When performing repairs using a gas burner, replace the refrigerant with nitrogen gas because the oil that coats the pipes may otherwise burn.</p> <p>When repairing the refrigerating cycle, take the following measures.</p> <ol style="list-style-type: none"> 1) Be attentive to fire around the cycle. When using a gas stove, etc., be sure to put out fire before work; otherwise the oil mixed with refrigerant gas may catch fire. 2) Do not use a welder in the closed room. When using it without ventilation, carbon monoxide poisoning may be caused. 3) Do not bring inflammables close to the refrigerant cycle, otherwise fire of the welder may catch the inflammables.
 Refrigerant	<p>The refrigerant used by this air conditioner is the R32.</p> <p>Check the used refrigerant name and use tools and materials of the parts which match with it. For the products which use R32 refrigerant, the refrigerant name is indicated at a position on the outdoor unit where is easy to see. To prevent miss-charging, the route of the service port is changed from one of the former R22. Be careful for miss-charging since a charging port of R32 is the same diameter as that of R410A.</p> <p>Do not use any refrigerant different from the one specified for complement or replacement. Otherwise, abnormally high pressure may be generated in the refrigeration cycle, which may result in a failure or explosion of the product or an injury to your body.</p> <p>For an air conditioner which uses R32, never use other refrigerant than R32. For an air conditioner which uses other refrigerant (R22, R410A etc.), never use R32. If different types of refrigerant are mixed, abnormal high pressure generates in the refrigerating cycle and an injury due to breakage may be caused. If the different type of refrigerants are mixed in, be sure to recharge the refrigerant</p> <p>Do not charge refrigerant additionally. If charging refrigerant additionally when refrigerant gas leaks, the refrigerant composition in the refrigerating cycle changes resulted in change of air conditioner characteristics or refrigerant over the specified standard amount is charged and an abnormal high pressure is applied to the inside of the refrigerating cycle resulted in cause of breakage or injury. Therefore if the refrigerant gas leaks, recover the refrigerant in the air conditioner, execute vacuuming, and then newly recharge the specified amount of liquid refrigerant. In this time, never charge the refrigerant over the specified amount.</p> <p>When recharging the refrigerant in the refrigerating cycle, do not mix the refrigerant or air other than R32 into the specified refrigerant. If air or others is mixed with the refrigerant, abnormal high pressure generates in the refrigerating cycle resulted in cause of injury due to breakage.</p> <p>After the installation work, confirm that refrigerant gas does not leak. If refrigerant gas leaks into the room and flows near a fire source, such as a cooking range, it may generate noxious gases, causing a fire.</p> <p>Never recover the refrigerant into the outdoor unit. When the equipment is moved or repaired, be sure to recover the refrigerant with recovering device. The refrigerant cannot be recovered in the outdoor unit; otherwise a serious accident such as breakage or injury is caused.</p>
 Assembly/ Wiring	<p>After repair work, surely assemble the disassembled parts, and connect and lead the removed wires as before. Perform the work so that the cabinet or panel does not catch the inner wires. If incorrect assembly or incorrect wire connection was done, a disaster such as a leak or fire is caused at user's side.</p>
 Insulator check	<p>After the work has finished, be sure to use an insulation tester set (500V Megger) to check the resistance is 1MΩ or more between the charge section and the non-charge metal section (Earth position). If the resistance value is low, a disaster such as a leak or electric shock is caused at user's side.</p>
 Ventilation	<p>When the refrigerant gas leaks during work, execute ventilation. If the refrigerant gas touches to a fire, it may generate noxious gases, causing a fire. A case of leakage of the refrigerant and the closed room full with gas is dangerous because a shortage of oxygen occurs. Be sure to execute ventilation.</p> <p>If refrigerant gas has leaked during the installation work, ventilate the room immediately. If the leaked refrigerant gas comes in contact with fire, it may generate noxious gases, causing a fire.</p>

 Compulsion	<p>When the refrigerant gas leaks, find up the leaked position and repair it surely. If the leaked position cannot be found up and the repair work is interrupted, pump-down and tighten the service valve, otherwise the refrigerant gas may leak into the room. When gas touches to fire such as fan heater, stove or cooking stove, it may generate noxious gases, causing a fire though the refrigerant gas itself is innocuous. When installing equipment which includes a large amount of charged refrigerant such as a multi air conditioner in a sub-room, it is necessary that the density does not the limit even if the refrigerant leaks. If the refrigerant leaks and exceeds the limit density, an accident of shortage of oxygen is caused.</p> <p>Tighten the flare nut with a torque wrench in the specified manner. Excessive tighten of the flare nut may cause a crack in the flare nut after a long period, which may result in refrigerant leakage.</p> <p>Nitrogen gas must be used for the airtight test.</p> <p>The charge hose must be connected in such a way that it is not slack.</p> <p>For the installation/moving/reinstallation work, follow to the Installation Manual. If an incorrect installation is done, a trouble of the refrigerating cycle, water leak, electric shock or fire is caused.</p> <p>Install the outdoor unit properly in a location that is durable enough to support the weight of the outdoor unit. Insufficient durability may cause the outdoor unit to fall, which may result in injury.</p>
 Check after repair	<p>Once the repair work has been completed, check for refrigerant leaks, and check the insulation resistance and water drainage. Then perform a trial run to check that the air conditioner is running properly.</p> <p>After repair work has finished, check there is no trouble. If check is not executed, a fire, electric shock or injury may be caused. For a check, turn off the power breaker.</p> <p>After repair work (installation of front panel and cabinet) has finished, execute a test run to check there is no generation of smoke or abnormal sound. If check is not executed, a fire or an electric shock is caused. Before test run, install the front panel and cabinet.</p>
 Do not operate the unit with the valve closed.	<p>Check the following matters before a test run after repairing piping.</p> <ul style="list-style-type: none"> • Connect the pipes surely and there is no leak of refrigerant. • The valve is opened. <p>Running the compressor under condition that the valve closes causes an abnormal high pressure resulted in damage of the parts of the compressor and etc. and moreover if there is leak of refrigerant at connecting section of pipes, the air is suctioned and causes further abnormal high pressure resulted in burst or injury.</p>
 Check after reinstallation	<p>Only a qualified installer (*1) or qualified service person (*1) is allowed to relocate the air conditioner. It is dangerous for the air conditioner to be relocated by an unqualified individual since a fire, electric shocks, injury, water leakage, noise and/or vibration may result.</p> <p>Check the following items after reinstallation.</p> <ol style="list-style-type: none"> 1) The earth wire is correctly connected. 2) The power cord is not caught in the product. 3) There is no inclination or unsteadiness and the installation is stable. <p>If check is not executed, a fire, an electric shock or an injury is caused.</p>
 Cooling check	<p>When the service panel of the outdoor unit is to be opened in order for the compressor or the area around this part to be repaired immediately after the air conditioner has been shut down, set the circuit breaker to the OFF position, and then wait at least 10 minutes before opening the service panel. If you fail to heed this warning, you will run the risk of burning yourself because the compressor pipes and other parts will be very hot to the touch. In addition, before proceeding with the repair work, wear the kind of insulated heat-resistant gloves designed to protect electricians.</p> <p>When the service panel of the outdoor unit is to be opened in order for the fan motor, reactor, inverter or the areas around these parts to be repaired immediately after the air conditioner has been shut down, set the circuit breaker to the OFF position, and then wait at least 10 minutes before opening the service panel. If you fail to heed this warning, you will run the risk of burning yourself because the fan motor, reactor, inverter heat sink and other parts will be very hot to the touch. In addition, before proceeding with the repair work, wear the kind of insulated heat-resistant gloves designed to protect electricians.</p>

 Installation	Only a qualified installer (*1) or qualified service person (*1) is allowed to install the air conditioner. If the air conditioner is installed by an unqualified individual, a fire, electric shocks, injury, water leakage, noise and/or vibration may result.
	Before starting to install the air conditioner, read carefully through the Installation Manual, and follow its instructions to install the air conditioner.
	Do not install the air conditioner in a location that may be subject to a risk of exposure to a combustible gas. If a combustible gas leaks and becomes concentrated around the unit, a fire may occur.
	When transporting the air conditioner, use a forklift and when moving the air conditioner by hand, move the unit with 4 people
	Install a circuit breaker that meets the specifications in the installation manual and the stipulations in the local regulations and laws.
	Install the circuit breaker where it can be easily accessed by the agent.
	Do not place any combustion appliance in a place where it is directly exposed to the wind of air conditioner, otherwise it may cause imperfect combustion.
 Compulsion	When carrying out the pump-down work shut down the compressor before disconnecting the refrigerant pipe. Disconnecting the refrigerant pipe with the service valve left open and the compressor still operating will cause air, etc. to be sucked in, raising the pressure inside the refrigeration cycle to an abnormally high level, and possibly resulting in reputing, injury, etc.
	When removing the welding parts of suction and discharge pipe for the compressor, remove them at the place ventilated well after recovering the refrigerant. Improper recovering may cause the spurt of the refrigerant and the refrigeration oil, causing an injury.
 Prohibition	Do not vent gases to the atmosphere. Venting gases to the atmosphere is prohibited by the law.

 **CAUTION**

 Wearing of gloves	Ensure wearing of gloves when performing any work in order to avoid injury from parts, etc. Failure to wear the proper protective gloves cause an injury due to the parts, etc.
 Confirm	When performing the welding work, check whether refrigerant leaks or remains. If the leakage refrigerant gas touches a fire source, it may generate noxious gases, causing a fire.

Explanations given to user

- If you have discovered that the fan grille is damaged, do not approach the outdoor unit but set the circuit breaker to the OFF position, and contact a qualified service person to have the repairs done.
Do not set the circuit breaker to the ON position until the repairs are completed.

Relocation

- Only a qualified installer (*1) or qualified service person (*1) is allowed to relocate the air conditioner. It is dangerous for the air conditioner to be relocated by an unqualified individual since a fire, electric shocks, injury, water leakage, noise and/or vibration may result.
- When carrying out the pump-down work shut down the compressor before disconnecting the refrigerant pipe. Disconnecting the refrigerant pipe with the service valve left open and the compressor still operating will cause air, etc. to be sucked in, raising the pressure inside the refrigeration cycle to an abnormally high level, and possibly resulting in reputing, injury, etc.

(*1) Refer to the "Definition of Qualified Installer or Qualified Service Person."

Declaration of Conformity

Manufacturer: **TOSHIBA CARRIER (THAILAND) CO., LTD.**
144 / 9 Moo 5, Bangkadi Industrial Park, Tivanon Road, Tambol Bangkadi,
Amphur Muang, Pathumthani 12000, Thailand

TCF holder: TOSHIBA CARRIER EUROPE S.A.S
Route de Thil 01120 Montluel FRANCE

Hereby declares that the machinery described below:

Generic Denomination: Air Conditioner
Model/type: RAV-GM1601ATP-E
RAV-GM1601ATJP-E
RAV-GM1601ATP-TR

Commercial name: Digital Inverter Series Air Conditioner

Complies with the provision of the Machinery Directive (Directive 2006/42/EC) and the regulations transposing into national law.

Note: This declaration becomes invalid if technical or operational modifications are introduced without the manufacturer's consent.

Specification

Model	Sound power level (dBA)		Weight (kg)
	Cooling	Heating	
RAV-GM1601ATP-E	70	72	95
RAV-GM1601ATJP-E	70	72	95
RAV-GM1601ATP-TR	70	72	95

Refrigerant R32

This air conditioner adopts a new HFC type refrigerant (R32) which does not deplete the ozone layer.

1. Safety Caution Concerned to Refrigerant R32

Be sure that water, dust, the former refrigerant or the former refrigerating oil is not mixed into the refrigerating cycle of the air conditioner with refrigerant R32 during installation work or service work. If an incorrect work or incorrect service is performed, there is a possibility to cause a serious accident. Use the tools and materials exclusive to R32 to purpose a safe work.

2. Safety and Cautions on Installation/Service

<Safety items>

When gas concentration and ignition energy are happened at the same time, R32 has a slight possibility of burning. Although it will not ignite under normal work environment conditions, be aware that the flame spreads if ignition should occur. It is necessary to carry out installation/servicing safely while taking the following precautions into consideration.

- 1) Never use refrigerant other than specified refrigerant (R32) in an air conditioner which is designed to operate with the specified refrigerant (R32).
If other refrigerant than R32 is used, it may cause personal injury, etc. by a malfunction, a fire, a rupture.
- 2) Since R32 is heavier than air, it tends to accumulate on the bottom (near the floor). Ventilate properly for the working environment to prevent its combustion. Especially in a basement or a closed room where is the high risk of the accumulation, ventilate the room with a local exhaust ventilation. If refrigerant leakage is confirmed in the room or the place where the ventilation is insufficient, do not work until the proper ventilation is performed and the work environment is improved.
- 3) When performing brazing work, be sure to check for leakage refrigerant or residual refrigerant. If the leakage refrigerant comes into contact with fire, a poisonous gas may occur or it may cause a fire. Keep adequate ventilation during the work.
- 4) When refrigerant gas leaks during work, execute ventilation. If the leakage refrigerant comes into contact with a fire, a poisonous gas may occur or it may cause a fire.
- 5) In places where installing / repairing air-conditioning equipment, etc., keep the source of ignition such as gas combustion equipment, petroleum combustion equipment, electric heater etc. away. Do not smoke in the place.
- 6) When installing or removing an air conditioner, do not mix air in the refrigerant cycle. If air or others is mixed with the refrigerant, abnormal high pressure generates in the refrigerating cycle, causing injury due to the breakage.
- 7) After installation work complete, confirm that refrigerant gas is not leaking on the flare connection part or others. If leaked refrigerant comes to contact with a fire, toxic gas may occur, causing a fire.
- 8) Perform the installation work and re-installation according to the installation manual. Pay attention especially to the area of application. Improper installation may cause refrigeration trouble or water leakage, electric shock and fire etc.
- 9) Unauthorized modifications to the air conditioner may be dangerous. If a breakdown occurs please call a qualified air conditioner technician or electrician. Improper repair may result in water leakage, electric shock and fire, etc.
- 10) Carry out the airtight test with nitrogen at a specified pressure. Do not use oxygen or acetylene gas absolutely as it may cause an explosion.
- 11) Always carry a refrigerant leakage detection sensor during the work and work while checking that no refrigerant leaks around working environment.
- 12) If the leakage refrigerant comes into contact with fire, it may cause a fire. Have a dry powder or CO₂ fire extinguisher adjacent to the charging area.

<Caution items>

- 1) The opposite side dimension of the air-conditioner's flared nut using R32 and the shape of the charge port are the same as those of R410A.
- 2) Be careful not to charge refrigerant by mistake. Should the different type of refrigerant mix in, be sure to recharge the refrigerant
- 3) Do not mix the other refrigerant or refrigerating oil with the refrigerant.
- 4) Since the pressure of R32 is higher 1.6 times of that of the former refrigerant (R22), use tools and parts with high pressure withstand specification similar to R410A.
- 5) In the installation time, use clean pipe materials and work with great attention so that water and others do not mix in because pipes are affected by impurities such as water, oxide film, oil, etc. Use the clean pipes. Be sure to braze while flowing nitrogen gas in the pipe.
(Never use gas other than nitrogen gas.)
- 6) For the earth protection, use a vacuum pump for air purge.
- 7) R32 refrigerant is Single-component refrigerant that does not change its composition. Although it is possible to charge the refrigerant with either liquid or gas, charge it with liquid.
(If using gas for charging, composition of the refrigerant changes and then characteristics of the air conditioner change.)

3. Pipe Materials

For the refrigerant pipes, copper pipe and joints are mainly used.
It is necessary to select the most appropriate pipes to conform to the standard.
Use clean material in which impurities adhere inside of pipe or joint to a minimum.

1) Copper pipe

<Piping>

The pipe thickness, flare finishing size, flare nut and others differ according to a refrigerant type. When using a long copper pipe for R32, it is recommended to select "Copper or copper-base pipe without seam" and one with bonded oil amount 40mg/10m or less.

Also do not use crushed, deformed, discolored (especially inside) pipes.
(Impurities cause clogging of expansion valves and capillary tubes.)

<Flare nut>

Use the flare nuts which are attached to the air conditioner unit.

Be sure to select the pipes with copper thickness in the table below since the pressure of an air conditioner using R32 is higher than that of R22.

Nominal diameter	Outer diameter (mm)	Thickness (mm) R410A or R32
1/2	6.4	0.80
3/8	9.5	0.80
1/2	12.7	0.80
5/8	15.9	1.00

Make sure not to use a thin copper pipe such as 0.7 mm copper thickness in the market.

2) Joint

The flare joint and socket joint are used for joints of the copper pipe.
The joints are rarely used for installation of the air conditioner.
However clear impurities when using them.

4. Tools

Tools exclusive for R410A (The following tools for R410A are required.)

○: R410A tools available

△: Partly unavailable, ×: R410A tools unavailable

No	Installation/service tools		Use	Applicability to R32 air conditioner or not	Applicability to R22 air conditioner or not
	Tools / Equipment	specification			
1	Flare tool	Clutch type	Pipe flaring	○	○
2	Copper pipe gauge for adjusting projection margin	—	Flaring by conventional flare tool	○	—
3	Torque wrench	—	Tightening of flare nut	○	×
4	Gauge manifold	Port size 1/2"-20UNF (5/16" Flare)	Evacuating, refrigerant charge, run check, etc.	○ Note 2	×
5	Charge hose	High-voltage		○	×
6	Vacuum pump	—	Vacuum drying	○ Note 3 1/2"-20UNF(5/16" Flare)	△ Connection diameter 1/4"
7	Vacuum pump adapter	—	Vacuum drying	○ Note 4 1/2"-20UNF(5/16" Flare)	△ Connection diameter 1/4"
8	Electronic balance for refrigerant charging	For 10 kg or 20 kg cylinder	Refrigerant charge	○	○
9	Leakage detector	—	Gas leakage check	○ Note 5	○ Note 5
10	Refrigerant cylinder	—	Refrigerant charge	×	×
11	Refrigerant recovery cylinder	Exclusive for R32	Refrigerant recovery container	×	×
12	Refrigerant recovery device	—	Refrigerant recovery device	○ Note 8	△ Connection diameter 1/4"

Note 1 When flaring is carried out for R410A or R32 using the conventional flare tools, adjustment of projection margin is necessary. For this adjustment, a copper pipe gauge, etc. are necessary.

Note 2 When saturation temperature is described, the gauge manifold differs for R410A and R32. If saturation temperature reading is required, special tools exclusive for R32 are required.

Note 3 Since R32 has a slight possibility of burning, be sure to use the tools corresponding to R32.

Note 4 Like R410, a Vacuum pump adapter needs installing to prevent a Vacuum pump oil (mineral oil) from flowing backward into the Charge hose. Mixing of the Vacuum pump oil into R32 refrigerant may cause a trouble such as generation of sludge, clogging of capillary, etc.

Note 5 Be sure to use those tools after confirming they correspond to each refrigerant.

Note 6 For a refrigerant cylinder exclusive for R32, the paint color (or label color) of the cylinder is set the specified color (light blue) together with the indication of the refrigerant name.

Note 7 Although the container specification is the same as R410A, use a recovering container exclusive for R32 to avoid mixing with other refrigerants.

Note 8 Be careful for miss-charging of the refrigerant during work. Miss-charging of the refrigerant type may cause not only damage of the equipments but also a fire etc.

General tools

In addition to the above exclusive tools, the following equipments are necessary as the general tools.

- | | |
|-----------------------|-----------------------------|
| 1) Pipe cutter | 6) Spanner or Monkey wrench |
| 2) Reamer | 7) Hole core drill |
| 3) Pipe bender | 8) Tape measure |
| 4) Level vial | 9) Metal saw |
| 5) Screwdriver (+, -) | |

Also prepare the following equipments for other installation method and run check.

- | | |
|----------------|--|
| 1) Clamp meter | 3) Insulation resistance tester (Megger) |
| 2) Thermometer | 4) Electrocope |

1. SPECIFICATIONS

1-1. Outdoor Unit

<Digital Inverter>

Model name	Outdoor unit		RAV-GM	1601AT*P*
Power supply				1 phase 220-240V, 50Hz 1 phase 220V, 60Hz (Power exclusive to outdoor is required.)
Compressor	Type			Hermetic compressor
	Motor	(kW)		3.75
	Pole			4
Refrigerant charged			(kg)	2.4
Refrigerant control				Pulse motor valve
Inter connecting pipe	Standard length		(m)	7.5
	Min. length		(m)	5
	Max. total length		(m)	50
	Additional refrigerant charge under long piping connector			35g/m (31m to 50m)
	Height difference	Outdoor lower	(m)	30
		Outdoor higher	(m)	30
Outer dimension	Height		(mm)	1340
	Width		(mm)	900
	Depth		(mm)	320
Appearance				Silky shade (Muncel 1Y8.5/0.5)
Total weight			(kg)	95
Heat exchanger				Finned tube
Fan unit	Fan			Propeller fan
	Standard air flow high		(m ³ /min.)	115
	Motor		(W)	100+100
Connecting pipe	Gas side		(mm)	15.9
	Liquid side		(mm)	6.4
Sound pressure level			Cooling/Heating (dB·A)	53/55
Sound power level			Cooling/Heating (dB·A)	70/72
Outside air temperature, Cooling			°C (Dry bulb temp.)	46 to -15
Outside air temperature, Heating			°C (Wet bulb temp.)	15 to -15

1-2. Operation Characteristic Curve

RAV-GM1601AT*P*

<Cooling>

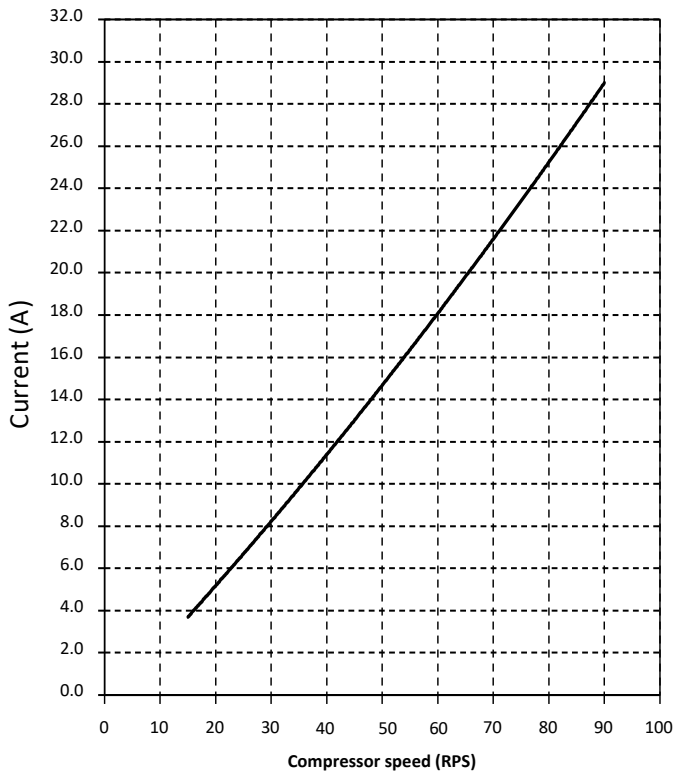

<Heating>

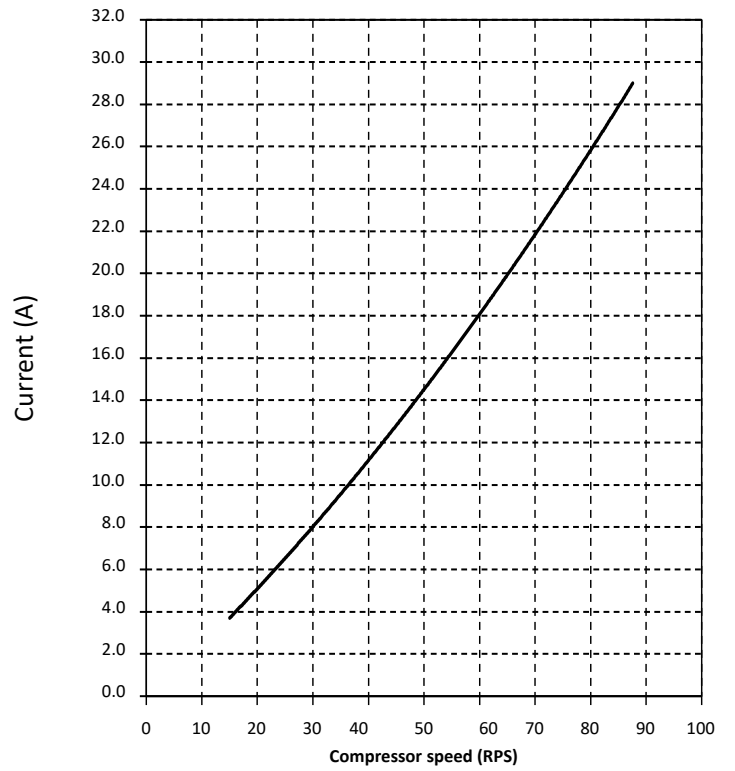

Capacity variation ratio according to temperature

<Cooling>

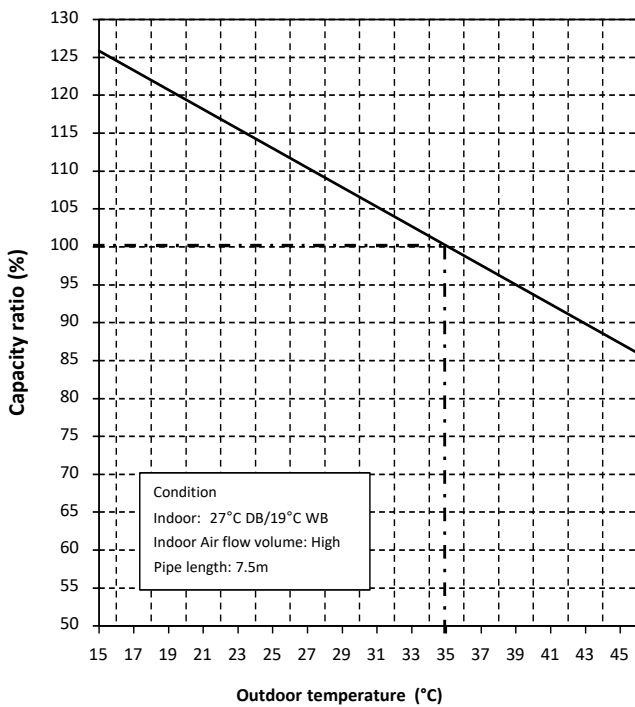

<Heating>

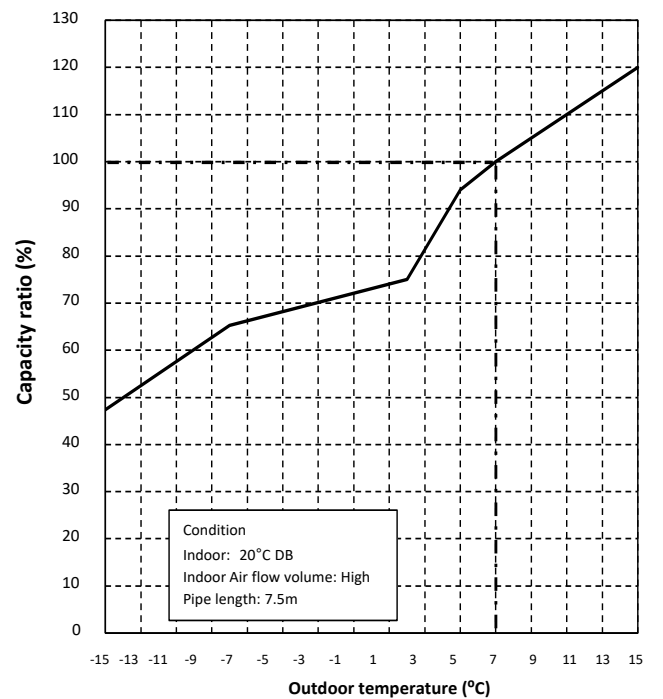

2. CONSTRUCTION VIEWS (EXTERNAL VIEWS)

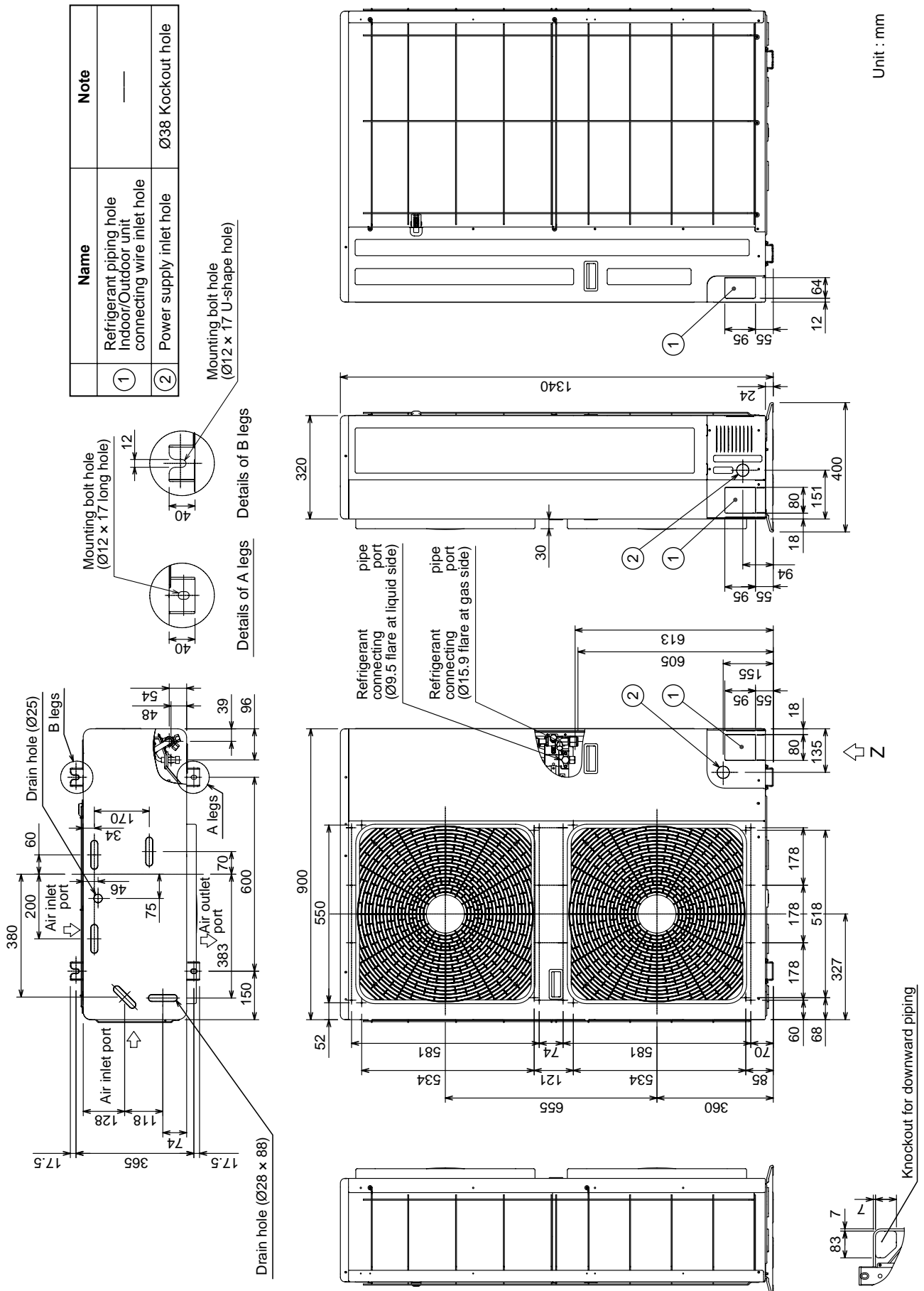

RAV-TWP30E2, RAV-TWP50E2 (Simultaneous Twin)

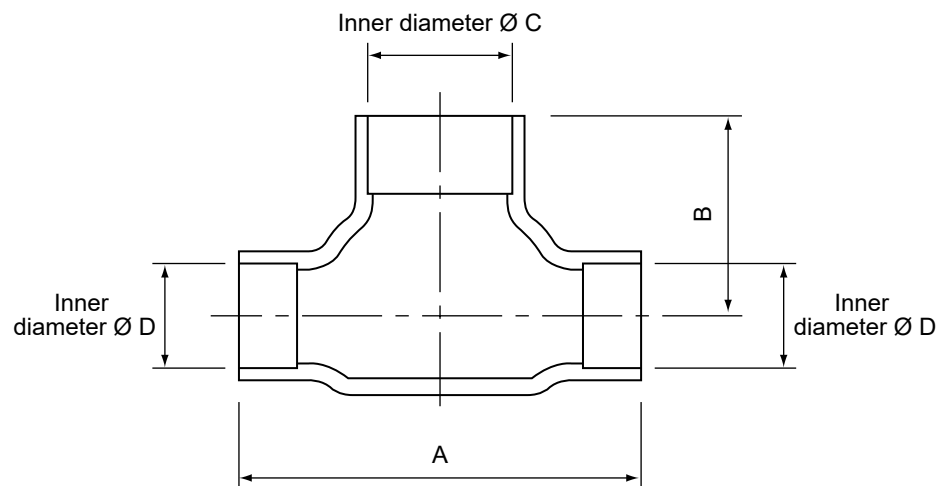

Model (RBC-)		A	B	C	D
TWP30E2	Liquid side	36	14	Ø9.5	Ø6.4
	Gas side	43	23	Ø15.9	Ø12.7
TWP50E2	Liquid side	34	14	Ø9.5	Ø9.5
	Gas side	44	21	Ø15.9	Ø15.9

RBC-TRP100E (Simultaneous Triple)

<Gas side>

Header assembly

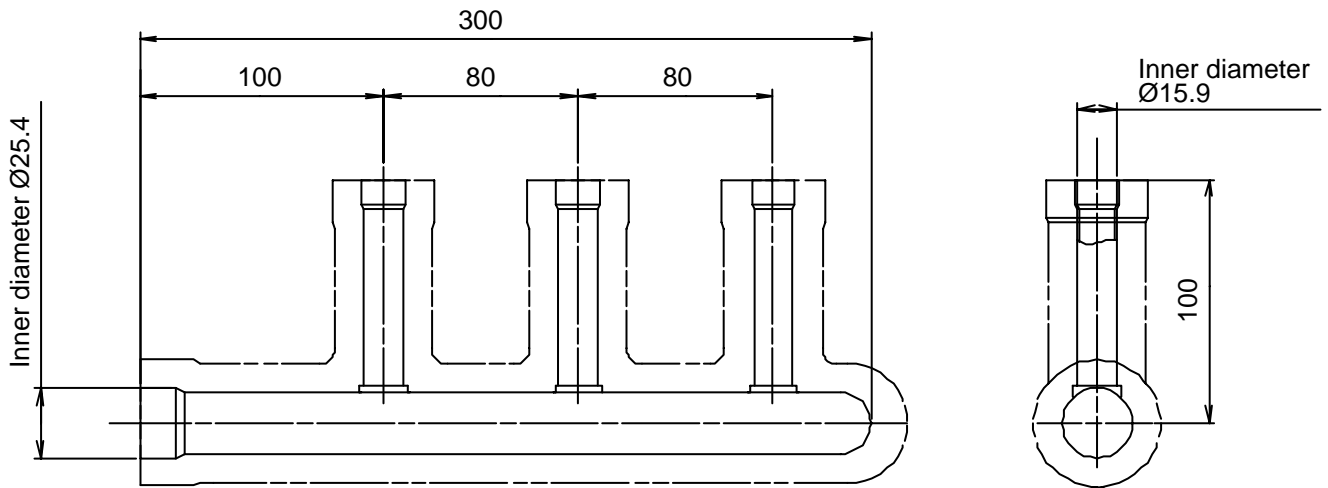

<Liquid side>

Branch pipe assembly

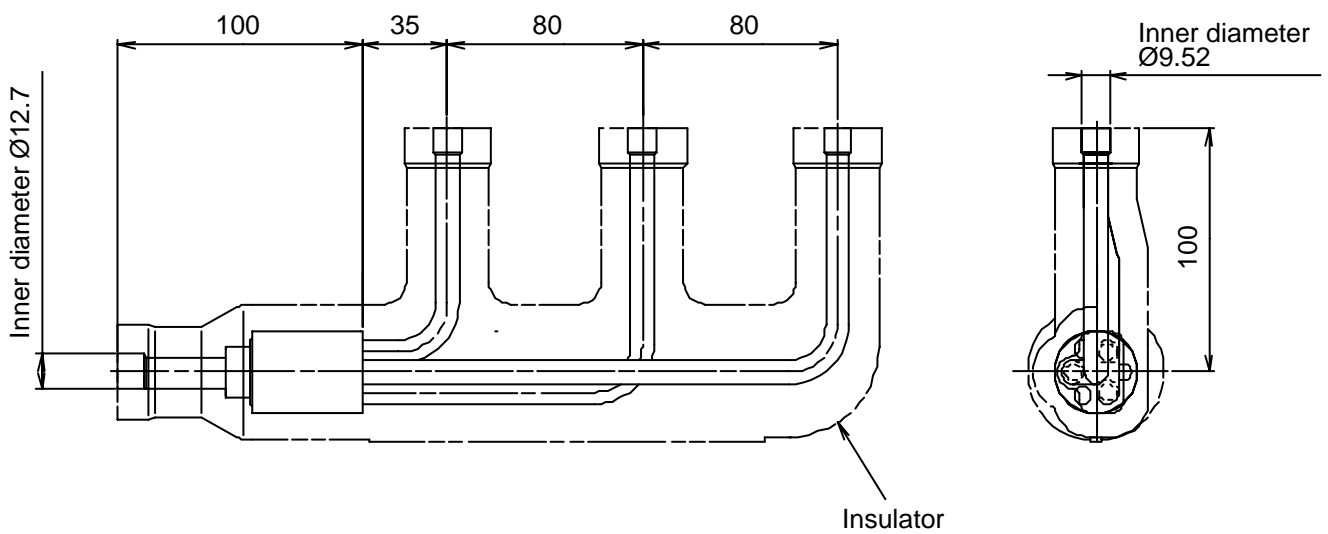

Gas side socket

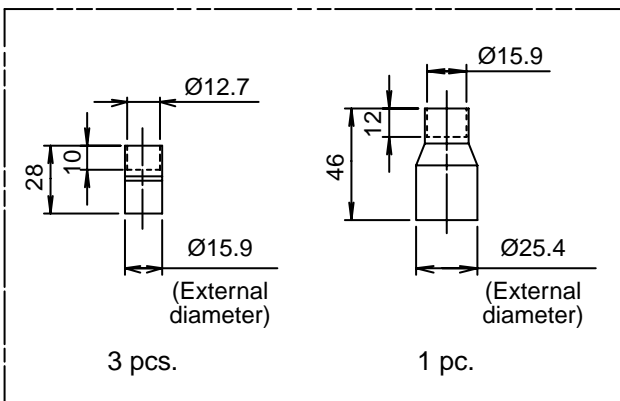

Liquid side socket

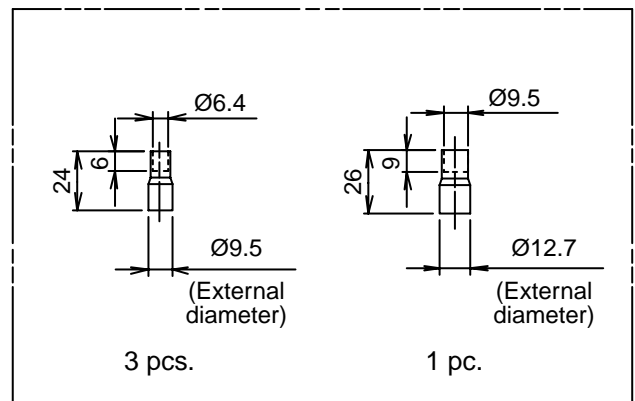

3. SYSTEMATIC REFRIGERATING CYCLE DIAGRAM

3-1. Indoor Unit

Single type (Combination of 1 indoor unit and 1 outdoor unit)

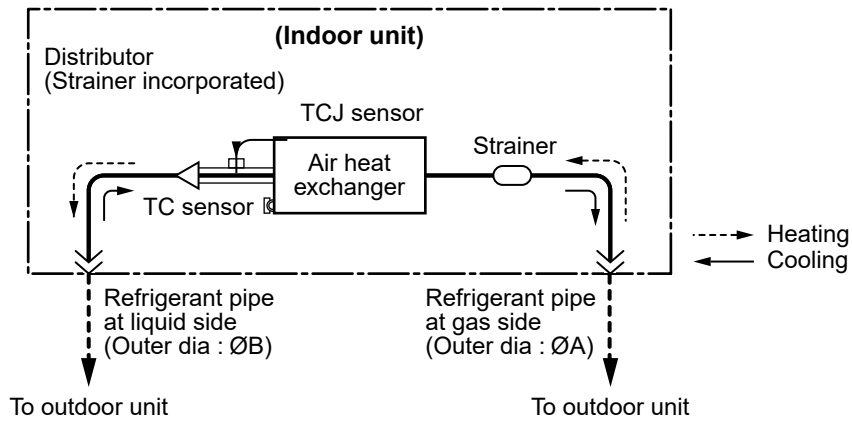

Dimension table

Indoor unit	Outer diameter of refrigerant pipe	
	Gas side ØA	Liquid side ØB
RM160 type	15.9	9.5

<Indoor unit to be connected to RAV-RM1601ATP*

- **Single type**
(Combination of one indoor unit and one outdoor unit)

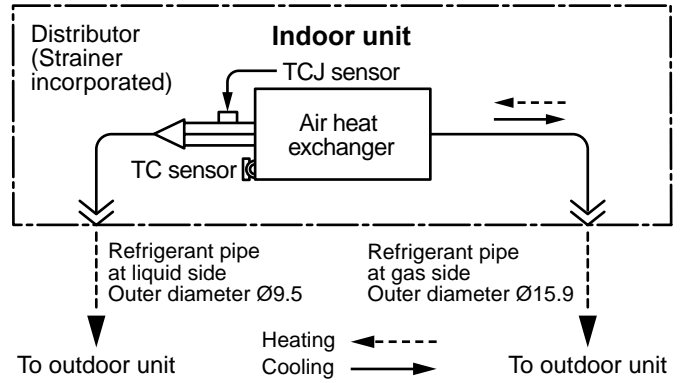

- **Twin type** (Combination of two indoor units and one outdoor unit)

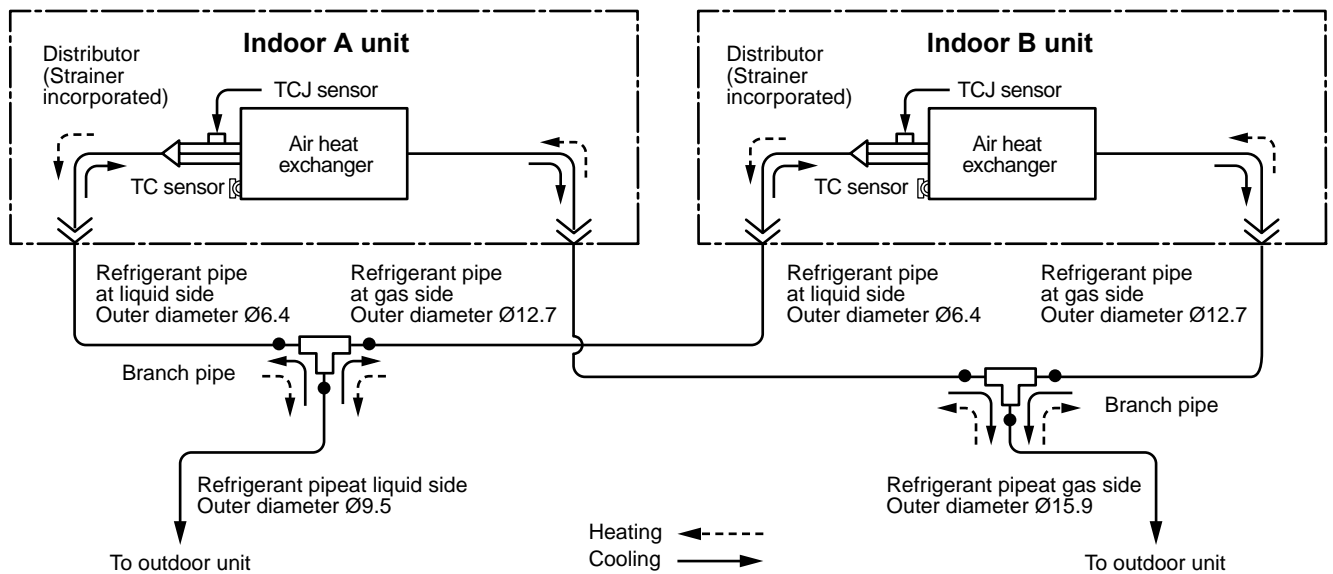

- **Triple type** (Combination of three indoor units and one outdoor unit)

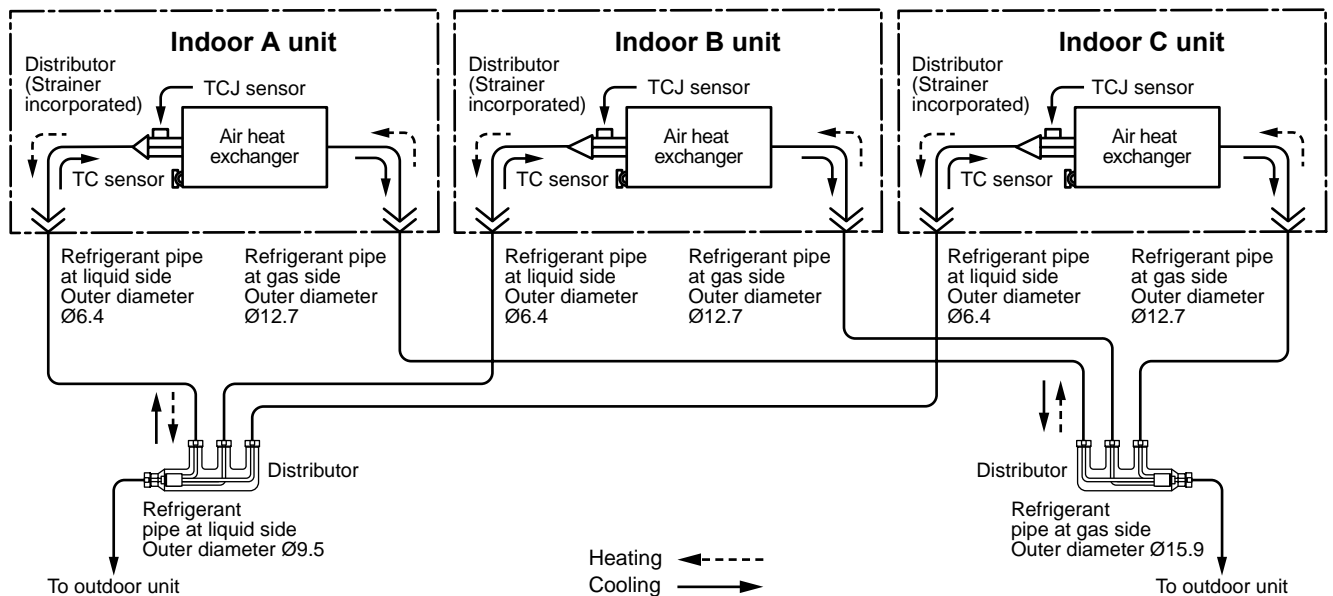

3-2. Outdoor Unit

RAV-GM1601AT*P*

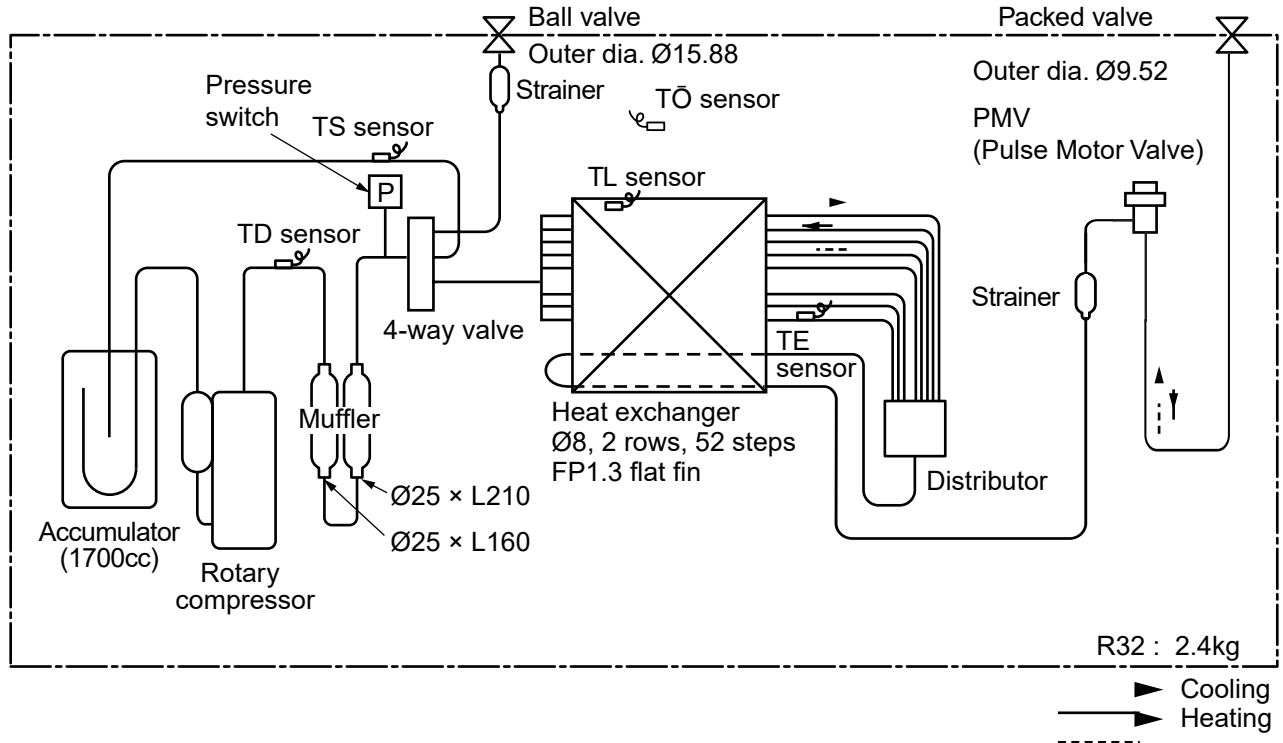

RAV-GM1601AT*P*

		Pressure				Pipe surface temperature (°C)				* Comp. Hz	Fan	Temp	
		(MPa)		(kg/cm ² G)		(TD)	(TS)	(TC)	(TE)			In	Out
		Pd	Ps	Pd	Ps								
Cooling	Standard	2.86	0.85	29.2	8.7	91	8	8	39	68	HIGH	27/19	35/-
	Overload	3.40	0.97	34.7	9.9	82	12	15	54	67	HIGH	32/23	46/-
	Low load	2.92	0.74	29.8	7.5	66	3	4	47	30	LOW	18/13	-15/-
Heating	Standard	2.97	0.63	50.3	6.4	88	1	49	3	68	HIGH	20/-	7/6
	Overload	3.10	1.12	30.6	11.4	86	19	52	16	27	LOW	27/-	24/18
	Low load	2.22	0.26	22.6	2.6	84	-18	36	-17	81	HIGH	15/-	-15/-

* 4 poles are provided to this compressor.

The compressor frequency (Hz) measured with a clamp meter is 2 times of revolutions (rps) of the compressor.

4. WIRING DIAGRAM

CAUTION : HIGH VOLTAGE
 The high voltage circuit is incorporated. Be careful to do the check service, as the electric shock may be caused in case of touching parts on the P.C.Board by hand.

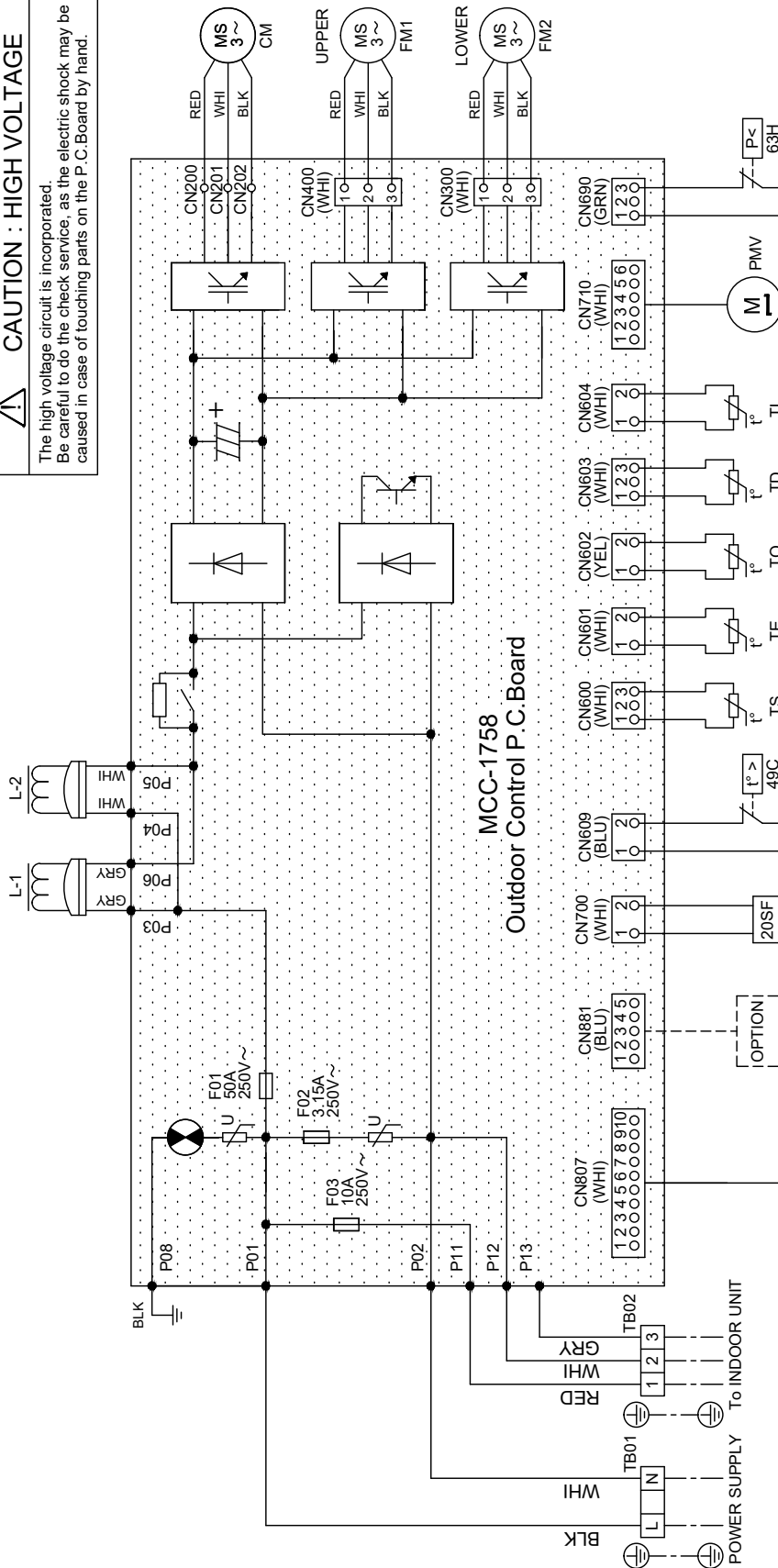

MCC-1758
Outdoor Control P.C. Board

Color Indication

BLK	: BLACK	GRN	: GREEN
BLU	: BLUE	WHI	: WHITE
RED	: RED	YEL	: YELLOW
GRY	: GRAY		

Field wiring

---	Field wiring
⊕	Protective earth
□	Terminal block
○	Terminal
○-○	Connector
⋮	P.C. Board

Symbol	Parts name	Symbol	Parts name
20SF	4-way valve coil	PMV	Pulse Motor Valve
63H	High pressure switch	TB01	Terminal block (power supply)
CM	Compressor	TB02	Terminal block (to indoor unit)
FM1	Fan Motor (UPPER)	TS	Pipe temp. sensor (Suction)
FM2	Fan Motor (LOWER)	TE	Heat exchange temp. sensor
CN***	Connector	TO	Air temp. sensor
F01	Fuse 50A 250V ~	TD	Pipe temp. sensor (Discharge)
F02	Fuse 3.15A 250V ~	TL	Liquid temp. sensor
F03	Fuse 10A 250V ~	L-1, L-2	Reactor
49C	Thermostat for Compressor		

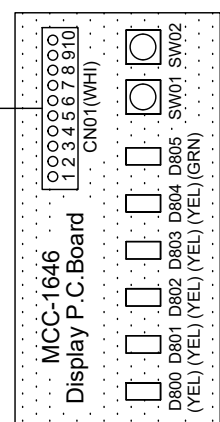

For D800 ~ D805 and SW01 ~ SW02, refer to the installation manual.

5. SPECIFICATIONS OF ELECTRICAL PARTS

No.	Parts name	Type	Specification
1	Compressor	DX380A2T-20M	3 phase, 4P, 3750W
2	Fan motor	ICF-280-A100-1	Output 100 W
3	4-way valve coil	DXQ-1490	-
4	PMV coil	CAM-MD12TF-18	-
5	High-pressure SW	ACB-4UB166W	OFF:4.15MPa
6	Reactor	CH-57-Z-T;R	8.88~10.01mH, 16A
7	P.C. board	MCC-1758	-
8	Fuse (Mounted on P.C. board)	-	AC250 V, 50 A
9	Fuse	-	AC250 V, 10 A
10	Fuse (Mounted on P.C. board)	-	AC250 V, 3.15 A
11	Outdoor temp. sensor (TO sensor)	-	10 kΩ at 25°C
12	Heat exchanger temp. sensor (TE sensor)	-	10 kΩ at 25°C
13	Suction temp. sensor (TS sensor)	-	10 kΩ at 25°C
14	Discharge temp. sensor (TD sensor)	-	50 kΩ at 25°C
15	Heat exchanger temp. sensor (TL sensor)	-	50 kΩ at 25°C
16	Compressor thermo. (Protection)	CS-12AL	OFF: 125 ± 4°C, ON: 90 ± 5°C

6. REFRIGERANT R32

This air conditioner adopted the R32 refrigerant which does not damage the ozone layer.

The working pressure of the refrigerant R32 is 1.6 times higher than conventional refrigerant (R22). The refrigerating oil is also changed in accordance with change of refrigerant, so be careful that water, dust, and existing refrigerant or refrigerating oil are not entered in the refrigerant cycle of the air conditioner using the new refrigerant during installation work or servicing time.

The next section describes the precautions for air conditioner using the new refrigerant.

Conforming to contents of the next section together with the general cautions included in this manual, perform the correct and safe work.

6-1. Safety During Installation/Servicing

As R32's pressure is about 1.6 times higher than that of R22, improper installation/servicing may cause a serious trouble. By using tools and materials exclusive for R32, it is necessary to carry out installation/servicing safely while taking the following precautions into consideration.

1. Never use refrigerant other than R32 in an air conditioner which is designed to operate with R32.
If other refrigerant than R32 is mixed, pressure in the refrigeration cycle becomes abnormally high, and it may cause personal injury, etc. by a rupture.
2. Confirm the used refrigerant name, and use tools and materials exclusive for the refrigerant R32. The refrigerant name R32 is indicated on the visible place of the outdoor unit of the air conditioner using R32 as refrigerant. A diameter of charge port for R32 is the same as that of the R410's. Be careful not to charge the refrigerant by mistake.
3. If a refrigeration gas leakage occurs during installation/servicing, be sure to ventilate fully. If the refrigerant gas comes into contact with fire, a poisonous gas may occur.
4. When installing or removing an air conditioner, do not allow air or moisture to remain in the refrigeration cycle. Otherwise, pressure in the refrigeration cycle may become abnormally high so that a rupture or personal injury may be caused.
5. After completion of installation work, check to make sure that there is no refrigeration gas leakage.
If the refrigerant gas leaks into the room, coming into contact with fire in the fan-driven heater, space heater, etc., a poisonous gas may occur.

6. When an air conditioning system charged with a large volume of refrigerant is installed in a small room, it is necessary to exercise care so that, even when refrigerant leaks, its concentration does not exceed the marginal level. If the refrigerant gas leakage occurs and its concentration exceeds the marginal level, an oxygen starvation accident may result.
7. Be sure to carry out installation or removal according to the installation manual. Improper installation may cause refrigeration trouble, water leakage, electric shock, fire, etc.
8. Unauthorized modifications to the air conditioner may be dangerous. If a breakdown occurs please call a qualified air conditioner technician or electrician.
Improper repair may result in water leakage, electric shock and fire, etc.

6-2. Refrigerant Piping Installation

6-2-1. Piping Materials and Joints Used

For the refrigerant piping installation, copper pipes and joints are mainly used.

Copper pipes and joints suitable for the refrigerant must be chosen and installed.

Furthermore, it is necessary to use clean copper pipes and joints whose interior surfaces are less affected by contaminants.

1. Copper Pipes

It is necessary to use seamless copper pipes which are made of either copper or copper alloy and it is desirable that the amount of residual oil is less than 40 mg/10 m.

Do not use copper pipes having a collapsed, deformed or discolored portion (especially on the interior surface).

Otherwise, the expansion valve or capillary tube may become blocked with contaminants.

As an air conditioner using R32 incurs pressure higher than when using R22, it is necessary to choose adequate materials.

Thicknesses of copper pipes used with R32 are as shown in Table 6-2-1. Never use copper pipes thinner than 0.8mm even when it is available on the market.

NOTE:

Refer to the "6-6. Instructions for Re-use Piping of R22 or R407C".

Table 6-2-1 Thicknesses of annealed copper pipes

		Thickness (mm)	
Nominal diameter	Outer diameter (mm)	R32	R22
1/4	6.4	0.80	0.80
3/8	9.5	0.80	0.80
1/2	12.7	0.80	0.80
5/8	15.9	1.00	1.00

1. Join

For copper pipes, flare joints or socket joints are used. Prior to use, be sure to remove all contaminants.

a) Flare Joints

Flare joints used to connect the copper pipes cannot be used for pipings whose outer diameter exceeds 20 mm. In such a case, socket joints can be used.

Sizes of flare pipe ends, flare joint ends and flare nuts are as shown in Tables 6-2-3 to 6-2-5 below.

b) Socket Joints

Socket joints are such that they are brazed for connections, and used mainly for thick pipings whose diameter is larger than 20 mm. Thicknesses of socket joints are as shown in Table 6-2-2.

Table 6-2-2 Minimum thicknesses of socket joints

Nominal diameter	Reference outer diameter of copper pipe jointed (mm)	Minimum joint thickness (mm)
1/4	6.4	0.50
3/8	9.5	0.60
1/2	12.7	0.70
5/8	15.9	0.80

6-2-2. Processing of Piping Materials

When performing the refrigerant piping installation, care should be taken to ensure that water or dust does not enter the pipe interior, that no other oil other than lubricating oils used in the installed air conditioner is used, and that refrigerant does not leak.

When using lubricating oils in the piping processing, use such lubricating oils whose water content has been removed. When stored, be sure to seal the container with an airtight cap or any other cover.

1. Flare Processing Procedures and Precautions

a) Cutting the Pipe

By means of a pipe cutter, slowly cut the pipe so that it is not deformed.

b) Removing Burrs and Chips

If the flared section has chips or burrs, refrigerant leakage may occur.

Carefully remove all burrs and clean the cut surface before installation.

c) Insertion of Flare Nut

d) Flare Processing

Make certain that a clamp bar and copper pipe have been cleaned.

By means of the clamp bar, perform the flare processing correctly.

Use either a flare tool for R410A/R32 or conventional flare tool.

Flare processing dimensions differ according to the type of flare tool.

When using a conventional flare tool, be sure to secure "dimension A" by using a gauge for size adjustment.

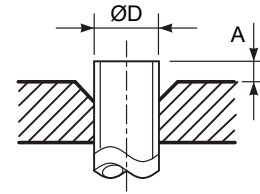

Fig. 6-2-1 Flare processing dimensions

Table 6-2-3 Dimensions related to flare processing for R410A or R32 / R22

Nominal diameter	Outer diameter (mm)	Thickness (mm)	A (mm)				
			Flare tool for R410A, R22 clutch type	Conventional flare tool (R410A or R32)		Conventional flare tool (R22)	
				Clutch type	Wing nut type	Clutch type	Wing nut type
1/4	6.4	0.8	0 to 0.5	1.0 to 1.5	1.5 to 2.0	0.5 to 1.0	1.0 to 1.5
3/8	9.5	0.8	0 to 0.5	1.0 to 1.5	1.5 to 2.0	0.5 to 1.0	1.0 to 1.5
1/2	12.7	0.8	0 to 0.5	1.0 to 1.5	2.0 to 2.5	0.5 to 1.0	1.5 to 2.0
5/8	15.9	1.0	0 to 0.5	1.0 to 1.5	2.0 to 2.5	0.5 to 1.0	1.5 to 2.0
3/4	19.1	1.2	0 to 0.5	1.0 to 1.5	2.0 to 2.5	—	—

Table 6-2-4 Flare and flare nut dimensions for R410A or R32

Nominal diameter	Outer diameter (mm)	Thickness (mm)	Dimension (mm)				Flare nut width (mm)
			A	B	C	D	
1/4	6.4	0.8	9.1	9.2	6.5	13	17
3/8	9.5	0.8	13.2	13.5	9.7	20	22
1/2	12.7	0.8	16.6	16.0	12.9	23	26
5/8	15.9	1.0	19.7	19.0	16.0	25	29
3/4	19.1	1.2	24.0	—	19.2	28	36

Table 6-2-5 Flare and flare nut dimensions for R22

Nominal diameter	Outer diameter (mm)	Thickness (mm)	Dimension (mm)				Flare nut width (mm)
			A	B	C	D	
1/4	6.4	0.8	9.1	9.2	6.5	13	17
3/8	9.5	0.8	13.0	13.5	9.7	20	22
1/2	12.7	0.8	16.2	16.0	12.9	20	24
5/8	15.9	1.0	19.4	19.0	16.0	23	27
3/4	19.1	1.0	23.3	24.0	19.2	34	36

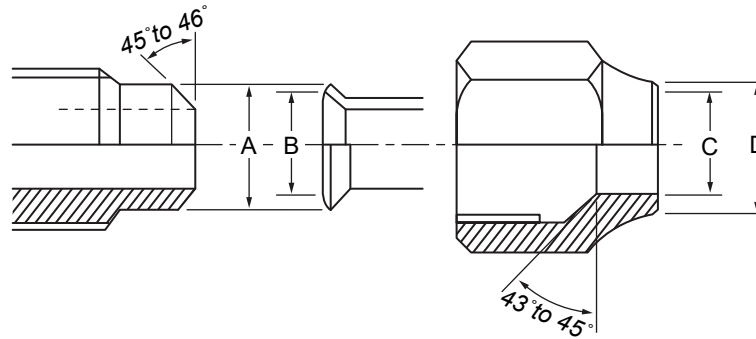

Fig. 6-2-2 Relations between flare nut and flare seal surface

2. Flare Connecting Procedures and Precautions

- a) Make sure that the flare and union portions do not have any scar or dust, etc.
- b) Correctly align the processed flare surface with the union axis.
- c) Tighten the flare with designated torque by means of a torque wrench.
 The tightening torque for R410A or R32 is the same as that for conventional R22.
 Incidentally, when the torque is weak, the gas leakage may occur.
 When it is strong, the flare nut may crack and may be made non-removable.
 When choosing the tightening torque, comply with values designated by manufacturers.
 Table 6-2-6 shows reference values.

NOTE

When applying oil to the flare surface, be sure to use oil designated by the manufacturer.
 If any other oil is used, the lubricating oils may deteriorate and cause the compressor to burn out.

Table 6-2-6 Tightening torque of flare for R410A or R32 [Reference values]

Nominal diameter	Outer diameter (mm)	Tightening torque N•m (kgf•m)	Tightening torque of torque wrenches available on the market N•m (kgf•m)
1/4	6.4	14 to 18 (1.4 to 1.8)	16 (1.6), 18 (1.8)
3/8	9.5	33 to 42 (3.3 to 4.2)	42 (4.2)
1/2	12.7	50 to 62 (5.0 to 6.2)	55 (5.5)
5/8	15.9	68 to 82 (6.8 to 8.2)	65 (6.5)
3/4	19.1	100 to 120 (10.0 to 12.0)	—

6-3. Tools

6-3-1. Required Tools

Refer to the "4. Tools"

6-4. Recharging of Refrigerant

When it is necessary to recharge refrigerant, charge the specified amount of new refrigerant according to the following steps.

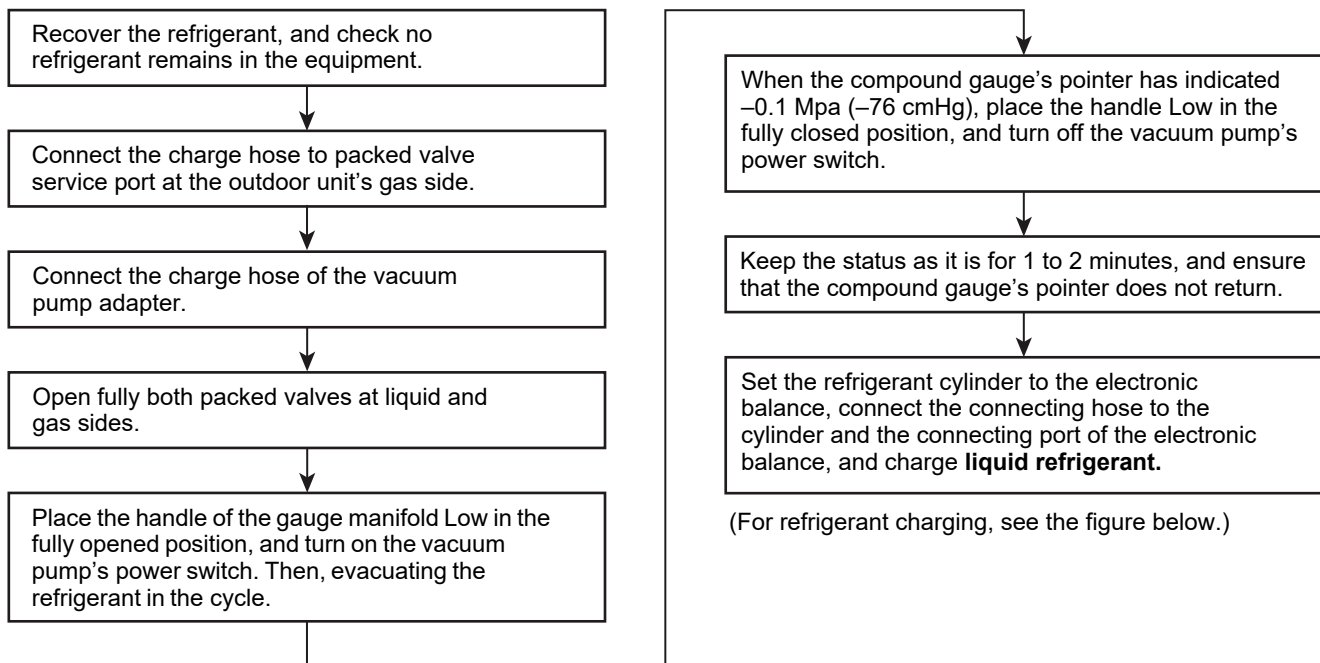

- 1) Never charge refrigerant exceeding the specified amount.
- 2) If the specified amount of refrigerant cannot be charged, charge refrigerant **bit by bit** in COOL mode.
- 3) Do not carry out additional charging.

When additional charging is carried out if refrigerant leaks, the refrigerant composition changes in the refrigeration cycle, that is characteristics of the air conditioner changes, refrigerant exceeding the specified amount is charged, and working pressure in the refrigeration cycle becomes abnormally high pressure, and may cause a rupture or personal injury.

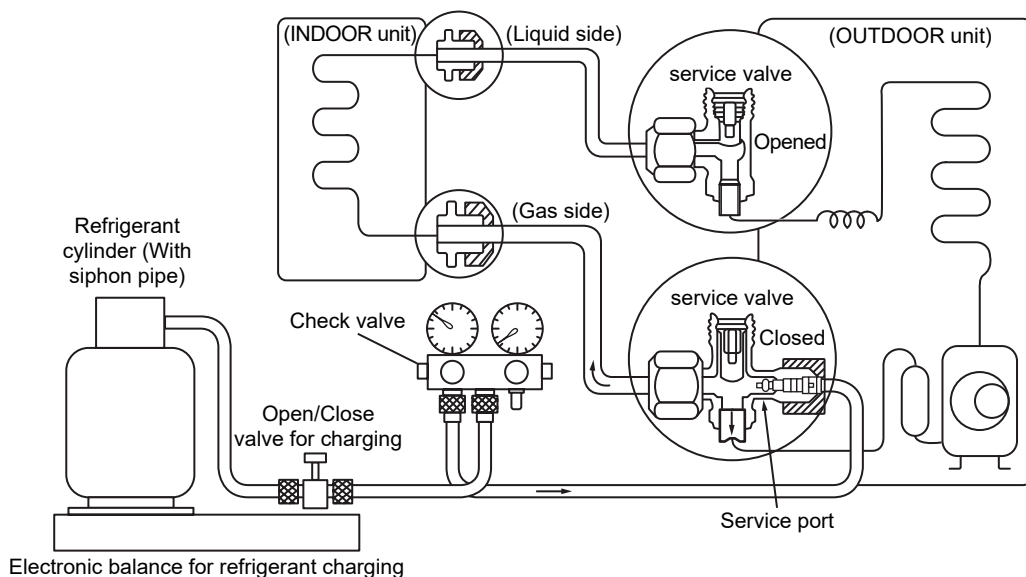

Fig. 6-4-1 Configuration of refrigerant charging

- 1) Be sure to make setting so that **liquid** can be charged.
- 2) When using a cylinder equipped with a siphon, liquid can be charged without turning it upside down.

R32 refrigerant is a Single-component refrigerant that does not change its composition.

Although it is possible to charge the refrigerant with either liquid or gas, charge it with liquid.

(If using gas for charging, composition of the refrigerant changes and then characteristics of the air conditioner change.)

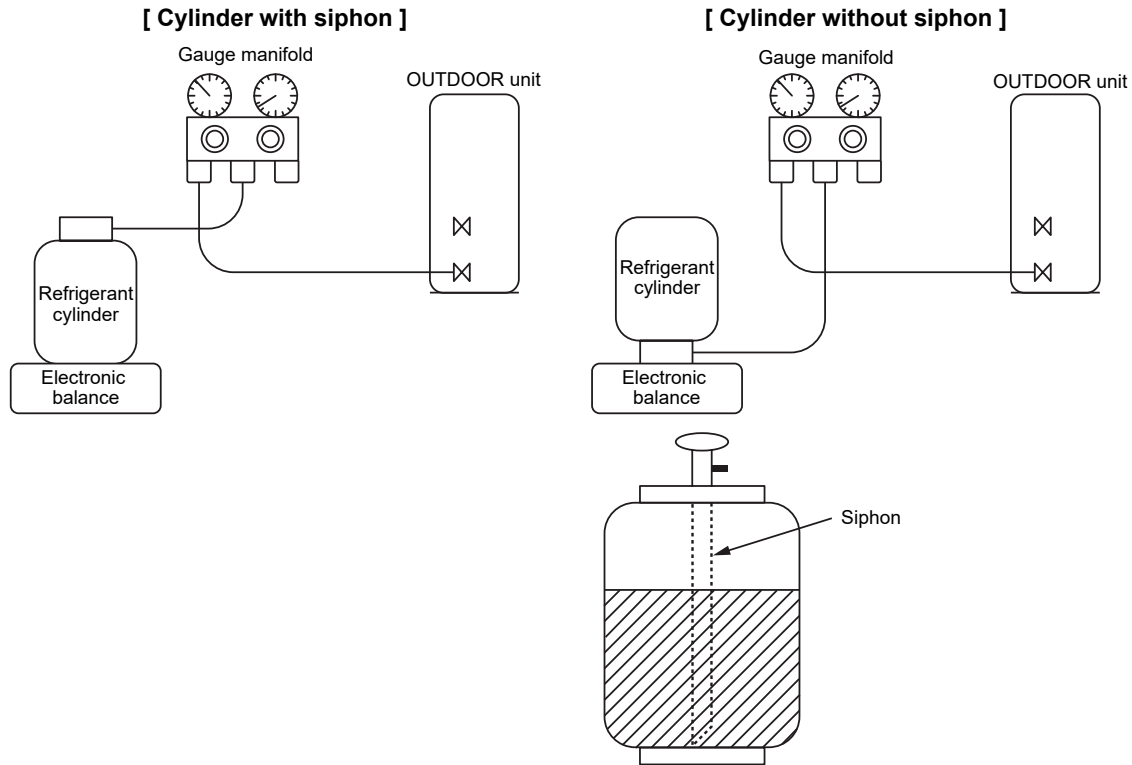

Fig. 6-4-2 Configuration of refrigerant charging when using a cylinder equipped with/without a siphon

6-5. Brazing of Pipes

6-5-1. Materials for Brazing

1. Silver brazing fill

Silver brazing filler is an alloy mainly composed of silver and copper.

It is used to join iron, copper or copper alloy, and is relatively expensive though it excels in solderability.

2. Phosphor bronze brazing filler

Phosphor bronze brazing filler is generally used to join copper or copper alloy.

3. Low temperature brazing filler

Low temperature brazing filler is generally called solder, and is an alloy of tin and lead. Since it is weak in adhesive strength, do not use it for refrigerant pipes.

- 1) Phosphor bronze brazing filler tends to react with sulfur and produce a fragile compound water solution, which may cause a gas leakage. Therefore, use any other type of brazing filler at a hot spring resort, etc., and coat the surface with a paint.

- 2) When performing brazing again at time of servicing, use the same type of brazing filler.

6-5-2. Flux

1. Reason why flux is necessary

- By removing the oxide film and any foreign matter on the metal surface, it assists the flow of brazing filler.
- In the brazing process, it prevents the metal surface from being oxidized.
- By reducing the brazing filler's surface tension, the brazing filler adheres better to the treated metal.

2. Characteristics required for flux

- Activated temperature of flux coincides with the brazing temperature.
- Due to a wide effective temperature range, flux is hard to carbonize.
- It is easy to remove slag after brazing.
- The corrosive action to the treated metal and brazing filler is minimum.
- It excels in coating performance and is harmless to the human body.

As the flux works in a complicated manner as described above, it is necessary to select an adequate type of flux according to the type and shape of treated metal, type of brazing filler and brazing method, etc.

3. Types of flux

• Noncorrosive flux

Generally, it is a compound of borax and boric acid.

It is effective in case where the brazing temperature is higher than 800°C.

• Activated flux

Most of fluxes generally used for silver brazing are this type.

It features an increased oxide film removing capability due to the addition of compounds such as potassium fluoride, potassium chloride and sodium fluoride to the borax-boric acid compound.

4. Piping materials for brazing and used brazing filler/flux

Piping material	Used brazing filler	Used flux
Copper - Copper	Phosphor copper	Do not use
Copper - Iron	Silver	Paste flux
Iron - Iron	Silver	Vapor flux

- 1) Do not enter flux into the refrigeration cycle.
- 2) When chlorine contained in the flux remains within the pipe, the lubricating oil deteriorates. Therefore, use a flux which does not contain chlorine. When adding water to the flux, use water which does not contain chlorine (e.g. distilled water or ion-exchange water).
- 3) Remove the flux after brazing.

6-5-3. Brazing

As brazing work requires sophisticated techniques, experiences based upon a theoretical knowledge, it must be performed by a person qualified. In order to prevent the oxide film from occurring in the pipe interior during brazing, it is effective to proceed with brazing while letting dry Nitrogen gas flow.

Never use gas other than Nitrogen gas.

1. Brazing method to prevent oxidation

- 1) Attach a reducing valve and a flow-meter to the Nitrogen gas cylinder.
- 2) Use a copper pipe to direct the piping material, and attach a flow-meter to the cylinder.
- 3) Apply a seal onto the clearance between the piping material and inserted copper pipe for Nitrogen in order to prevent backflow of the Nitrogen gas.
- 4) When the Nitrogen gas is flowing, be sure to keep the piping end open.
- 5) Adjust the flow rate of Nitrogen gas so that it is lower than 0.05 m³/Hr or 0.02 MPa (0.2kgf/cm²) by means of the reducing valve.
- 6) After performing the steps above, keep the Nitrogen gas flowing until the pipe cools down to a certain extent (temperature at which pipes are touchable with hands).
- 7) Remove the flux completely after brazing.

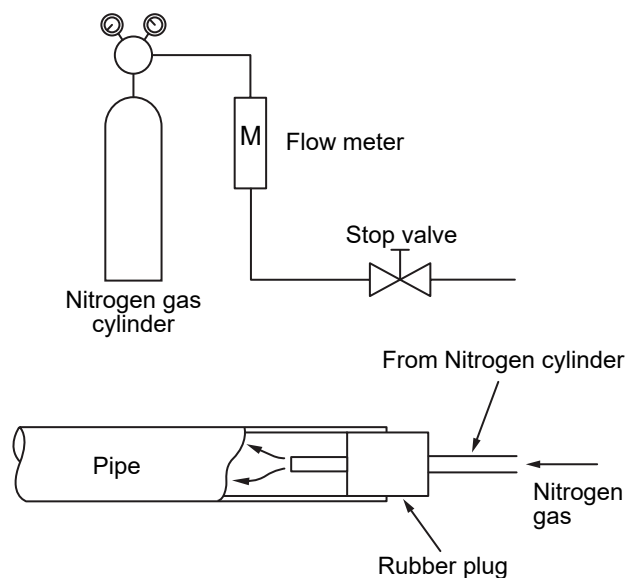

Fig. 6-5-1 Prevention of oxidation during brazing

6-6. Instructions for Re-use Piping of R22 or R407C

Instruction of Works:

The existing R22 and R407C piping can be reused for our super digital inverter R32 products installations.

WARNING

Confirming the existence of scratches or dents on the existing pipes and confirming the reliability of the pipe strength are conventionally referred to the local site.

If the specified conditions can be cleared, it is possible to update existing R22 and R407C pipes to those for R32 models.

6-6-1. Basic conditions needed to reuse existing pipes

Check and observe the presence of three conditions in the refrigerant piping works.

1. **Dry** (There is no moisture inside of the pipes.)
2. **Clean** (There is no dust inside of the pipes.)
3. **Tight** (There are no refrigerant leaks.)

6-6-2. Restrictions for use of existing pipes

In the following cases, the existing pipes should not be reused as they are. Clean the existing pipes or exchange them with new pipes.

1. When a scratch or dent is heavy, be sure to use new pipes for the refrigerant piping works.
2. When the existing pipe thickness is thinner than the specified "Pipe diameter and thickness," be sure to use new pipes for the refrigerant piping works.
 - The operating pressure of R32 is high. If there is a scratch or dent on the pipe or a thinner pipe is used, the pressure strength may be inadequate, which may cause the pipe to break in the worst case.

* Pipe diameter and thickness (mm)

Reference outside diameter (mm)	Wall thickness (mm)	Material
6.4	0.8	—
9.5	0.8	—
12.7	0.8	—
15.9	1.0	—

- In case the pipe diameter is $\varnothing 12.7$ mm or less and the thickness is less than 0.7 mm, be sure to use new pipes for the refrigerant piping works.
3. When the outdoor unit was left with the pipes disconnected, or the gas leaked from the pipes and the pipes were not repaired and refilled.
 - There is the possibility of rain water or air, including moisture, entering the pipe.
 4. When refrigerant cannot be recovered using a refrigerant recovery unit.
 - There is the possibility that a large quantity of dirty oil or moisture remains inside the pipes.

5. When a commercially available dryer is attached to the existing pipes.

There is the possibility that copper green rust has been generated.

6. When the existing air conditioner is removed after refrigerant has been recovered.

Check if the oil is judged to be clearly different from normal oil.

- The refrigerator oil is copper rust green in color: There is the possibility that moisture has mixed with the oil and rust has been generated inside the pipe.
- There is discolored oil, a large quantity of residue, or a bad smell.

A large quantity of shiny metal dust or other wear

7. When the air conditioner has a history of the compressor failing and being replaced.

- When discolored oil, a large quantity of residue, of foreign matter is observed, trouble will occur.

8. When temporary installation and removal of the air conditioner are repeated such as when leased, etc.

9. If the type of refrigerator oil of the existing air conditioner is other than the following oil (Mineral oil), Suniso, Freol-S, MS (Synthetic oil), alkyl benzene (HAB, Barrel-freeze), ester series, PVE only of ether series.

The winding-insulation of the compressor may deteriorate.

NOTE

The above descriptions are results have been confirmed by our company and represent our views on our air conditioners, but do not guarantee the use of the existing pipes of air conditioners that have adopted R32 or R410A in other companies.

6-6-3. Branching pipe for simultaneous operation system

In the concurrent twin triple system, when TOSHIBA has specified that branching pipe is to be used, it can be reused. Branching pipe model name: RBC-TWP30E, RBC-TWP50E, RBC-TRP100E
On the existing air conditioner for simultaneous operation system (twin system), there are cases of branch pipes being used that have insufficient compressive strength. In such case, please change the piping to a branch pipe for R32 or R410A.

6-6-4. Curing of pipes

When removing and opening the indoor or outdoor unit for a long time, cure the pipes as follows

- Otherwise rust may be generated when moisture or foreign matter due to condensation enters the pipes.
- The rust cannot be removed by cleaning, and new pipes are necessary.

Placement location	Term	Curing manner
Outdoors	1 month or more	Pinching
	Less than 1 month	Pinching or Taping
Indoors	Every time	

6-6-5. Final Installation Checks

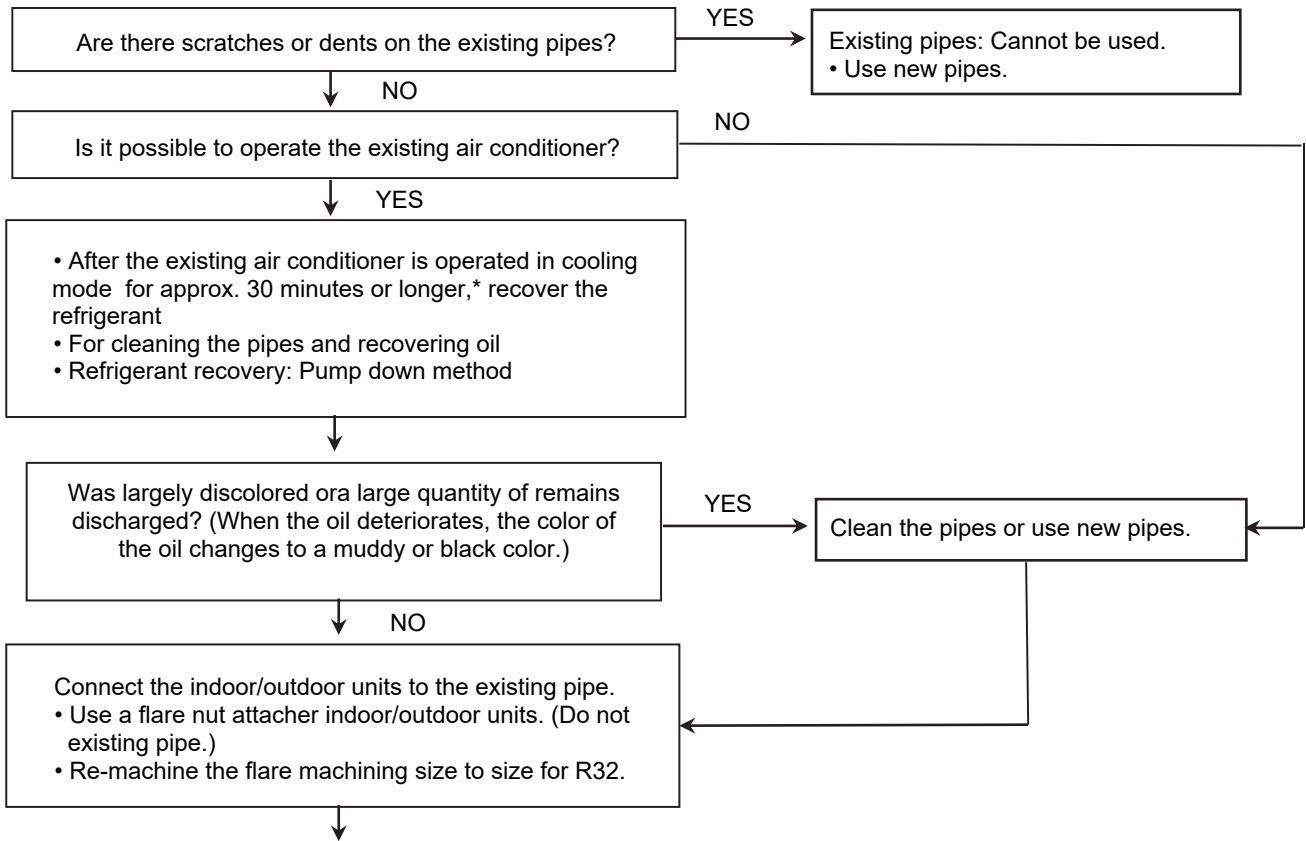

Existing piping

The following settings are required when using a pipe $\varnothing 19.1$ mm as the existing piping at the gas pipe side.

Steps taken to support existing piping

1. Set the circuit breaker to the ON position to turn on the power. 2. Check that the LED displays are placed in their initial status.

If not, place them in the initial status. 3. Hold down SW01 for at least 5 seconds, and check that D804 flashes slowly. (Fig. 5) 4. Press SW01 four times to set the LED displays (D800 to D805) to the "LED displays for existing piping settings" shown below. (Fig. 6)

(Fig. 5)

LED displays indicated when step 3 is taken					
D800	D801	D802	D803	D804	D805
○	●	●	●	◇	●

○: ON, ●: OFF, ◇: Slow flashing

(Fig. 6)

LED displays for existing piping settings					
D800	D801	D802	D803	D804	D805
●	●	○	●	◎	●

○: ON, ●: OFF, ◎: Rapid flashing

5. Press SW02 to set D805 to rapid flashing. (Each time SW02 is pressed, D805 is switched between rapid flashing and OFF.) (Fig. 7)

6. Hold down SW02 for at least 5 seconds, and check that D804 flashes slowly and that D805 lights. (Fig. 8)

(Fig. 7)

LED displays indicated when step 5 is taken					
D800	D801	D802	D803	D804	D805
●	●	○	●	◎	◎

○: ON, ●: OFF, ◎: Rapid flashing

(Fig. 8)

LED displays indicated when step 6 is taken					
D800	D801	D802	D803	D804	D805
●	●	○	●	◇	○

○: ON, ●: OFF, ◇: Slow flashing

7. Hold down SW01 and SW02 simultaneously for at least 5 seconds to return the LED displays to the initial status.

The existing piping is now supported by taking the above steps. In this status, the heating capacity may decrease during heating depending on the outside air temperature and indoor temperature.

* If there is any reason to doubt whether establishing support was successful in the course of this operation, hold down SW01 and SW02 simultaneously for at least 5 seconds to return to the initial status, and then repeat the setting steps.

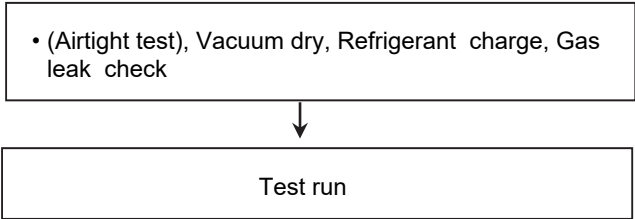

6-6-6. Handling of Existing Pipe

When using the existing pipe, carefully check it for the following:

- Wall thickness (within the specified range)
- Scratches and dents
- Water, oil, dirt, or dust in the pipe
- Flare looseness and leakage from welds
- Deterioration of copper pipe and heat insulator
- Before recovering the refrigerant in the existing system, perform a cooling operation for at least 30 minutes.

Cautions for using existing pipe

- Do not reuse a flare nut to prevent gas leaks. Replace it with the supplied flare nut and then process it to a flare.
- Blow nitrogen gas or use an appropriate means to keep the inside of the pipe clean. If discolored oil or much residue is discharged, wash the pipe.
- Check welds, if any, on the pipe for gas leaks.
- There may be a problem with the pressure resistance of the branching pipes of the existing piping. Replace them with branch pipes (sold separately).

When the pipe corresponds to any of the following, do not use it. Install a new pipe instead.

- The pipe has been opened (disconnected from indoor unit or outdoor unit) for a long period.
- The pipe has been connected to an outdoor unit that does not use refrigerant R22, R410A, R32 or R407.
- The existing pipe must have a wall thickness equal to or larger than the following thicknesses.

Reference outside diameter (mm)	Wall thickness (mm)	Material
6.4	0.8	—
9.5	0.8	—
12.7	0.8	—
15.9	1.0	—
19.1	1.2	—
22.2	1.0	Half hard
28.6	1.0	Half hard

- Do not use any pipe with a wall thickness less than these thicknesses due to insufficient pressure capacity.

6-6-7. Recovering Refrigerant

Use the refrigerant recovery equipment to recover the refrigerant.

6-7. Charging additional refrigerant

Amount of additional refrigerant shall be restricted by the following explanation to ensure the reliability.

Miss-charging leads to the abnormal high pressure in the refrigerant cycle, causing a rupture, a injury and a compressor malfunction.

6-7-1. [Assumed gas leak]

The refrigerant can be charged only when the amount of a leak such as a slow-leak found at the installation work can be ensured that it is within the additional limits shown in the following.

Recharge the refrigerant, as the amount of leakage is unknown when calling "Cooling is not good" or "Warming is not good".

6-7-2. [Limiting the additional charge]

- The maximum amount of additional refrigerant shall be up to 10 % of the normal amount of the refrigerant. If no improvement in symptoms can be found at the above limitation, recover all gases and recharge the normal amount of refrigerant.
- If the slow leak is found at the installation work and the connection pipe length is 15 m or less, tighten the flare nut at the leak point and do not add the refrigerant.

6-7-3. [Cautions on charging additional refrigerant]

- When adding, use a balance with an accuracy of more than 10 g scale. Do not use a health-meter etc.
- If the refrigerant gas leaks, find the leakage point and repair it securely. Though the refrigerant gas itself is innocuous, if it touch a fire source such as fan heater, stove or kitchen stove, noxious gas may occur.
- When charging the refrigerant, charge with liquid refrigerant. Work carefully and charge it little by little since it may be rapidly charged due to the liquid state.

6-8. Tolerance of Pipe Length and Pipe Head

■ Twin system

Refrigerant pipe specification	Pipe length (one way)	Total length (L + a or L + b)		50 m
		Branch pipe length (a, b)		15 m
		Maximum difference between indoor units (b - a, or a - b)		10 m
	Height difference	Between indoor units (Δh)		0.5 m
		Between indoor unit	When outdoor unit heigher (H)	30 m
		and outdoor unit	When outdoor unit lower (H)	30 m
Number of bent portions				10 m or less

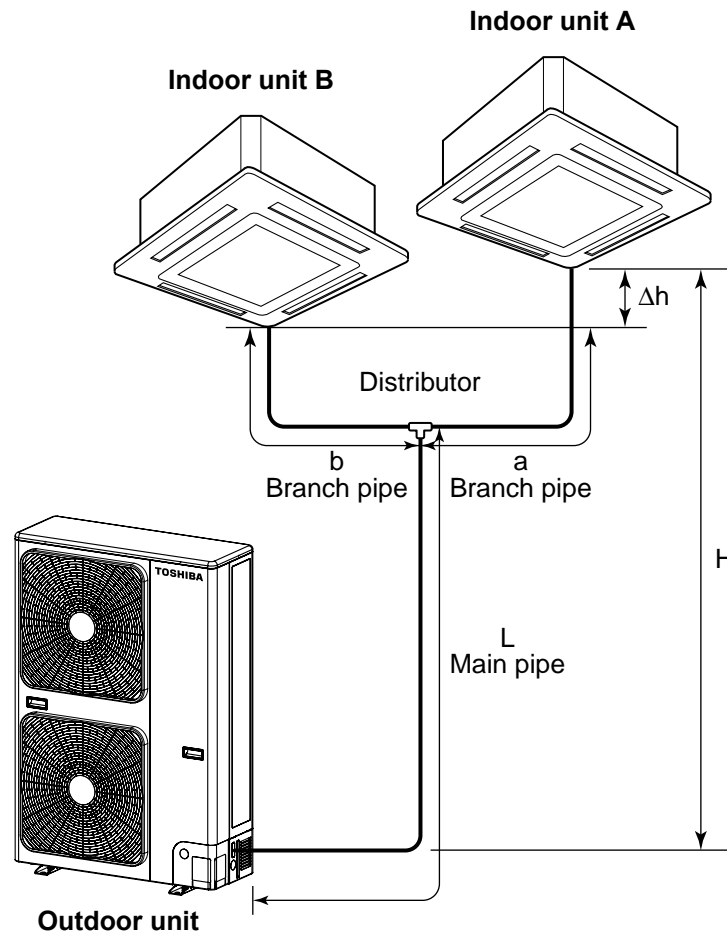

CAUTION

When planning a layout for Units A and B, comply with the following:

1. The lengths after branching ("a" and "b") should be equal if feasible.
Install Units A and B so that the difference of the branching lengths becomes less than 10m if the lengths cannot be equal due to the branch pipe position.
2. Install Units A and B on the same level.
If Units A and B cannot be installed on the same level, the difference in level should be limited to 0.5m or less.
3. Be certain to install Units A and B in the same room.
Units A and B cannot be operated independently each other.

■ Triple system

Refrigerant pipe specification	Pipe length (one way)	Total length (L + a, L + b, L + c)		50 m
		Branch pipe length (a, b, c)		15 m
		Maximum difference between indoor units (a - b , b - c , c - d)		10 m
	Height difference	Between indoor units (Δ h)		0.5 m
		Between indoor unit and outdoor unit	When outdoor unit heigher (H)	30 m
			When outdoor unit lower (H)	30 m
Number of bent portions				10 m or less

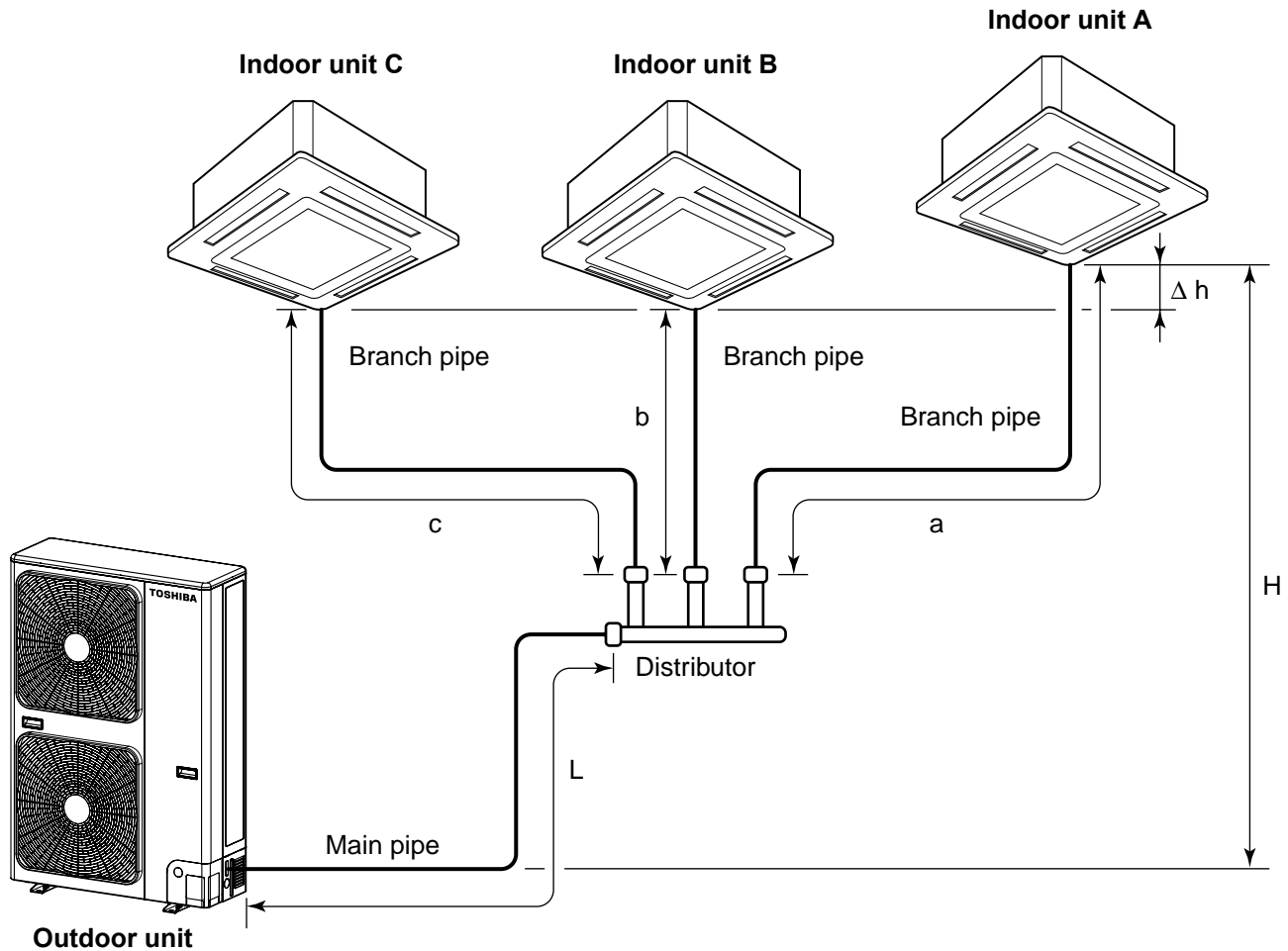

⚠ CAUTION

When planning a layout for Units A, B and C, comply with the following:

1. The lengths after branching ("a" and "b", "b" and "c", "a" and "c") should be equal if feasible.
Install Units A, B and C so that the difference of the branching lengths becomes less than 10m if the lengths cannot be equal due to the branch pipe position.
2. Install Units A, B and C on the same level.
If Units A, B and C cannot be installed on the same level, the difference in level should be limited to 0.5 m or less.
3. Be certain to install Units A and B and C in the same room.
Units A, B and C cannot be operated independently each other.

6-9. Additional Refrigerant Amount

■ Twin system

<Formula for Calculating Additional Refrigerant Amount>

Do not remove the refrigerant even if the additional refrigerant amount becomes minus result as a result of calculations by the following formula and operate the air conditioner as it is.

$$\begin{aligned} \text{Additional refrigerant amount (kg)} &= \text{Main piping additional refrigerant amount (kg)} \\ &\quad + \text{Branch piping additional refrigerant amount (kg)} \\ &= \alpha \times (L - 28) + \gamma \times (a + b - 4) \end{aligned}$$

α : Additional refrigerant amount per meter of actual main piping length (kg)

γ : Additional refrigerant amount per meter of actual branch piping length (kg)

L : Actual length of main piping (m)

a, b : Actual length of branch piping (m)

Standard piping length		Connecting pipe diameter			Additional refrigerant amount per Meter (kg/m)		
Main piping	Branch piping	L	a	b	α	β	γ
28 m	2 m	Ø9.5	Ø9.5	Ø9.5	0.035	—	0.035

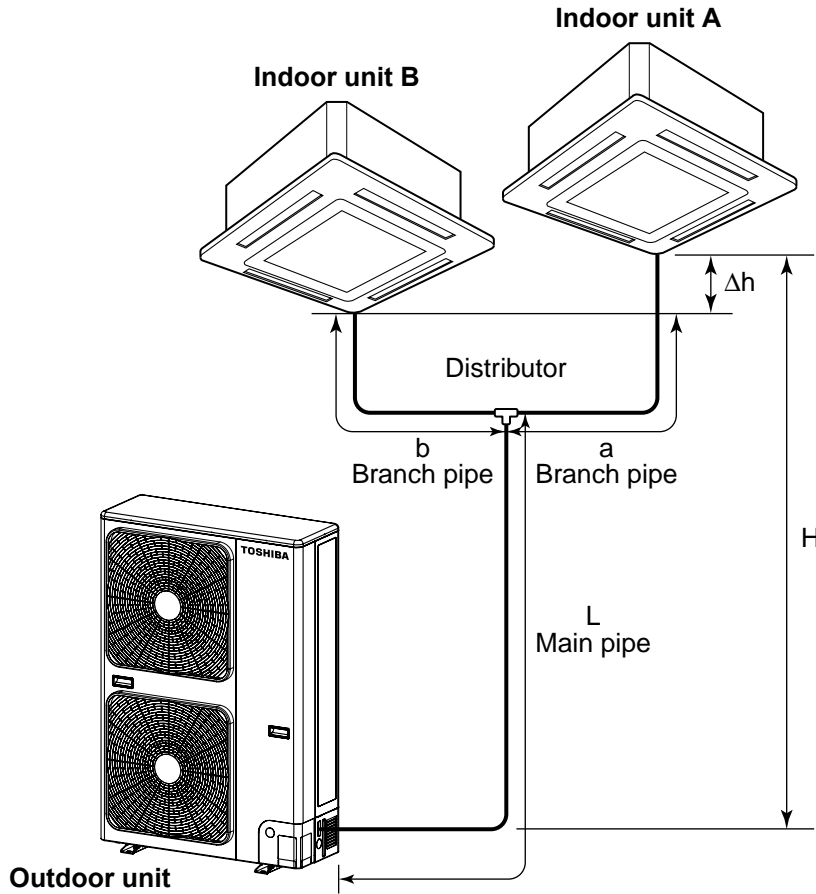

⚠ CAUTION

1. Be certain to wire the additional refrigerant amount, pipe length (actual length), head and other specification on the nameplate put on the outdoor unit for recording.
2. Seal the correct amount of additional refrigerant in the system.

■ Triple system

<Formula for Calculating Additional Refrigerant Amount>

Do not remove the refrigerant even if the additional refrigerant amount becomes minus result as a result of calculations by the following formula and operate the air conditioner as it is.

$$\begin{aligned} \text{Additional refrigerant amount (kg)} &= \text{Main piping additional refrigerant amount (kg)} \\ &+ \text{Branch piping additional refrigerant amount (kg)} \\ &= \{\alpha \times (L - 28)\} + \{\gamma \times (a + b + c - 6)\} \end{aligned}$$

α : Additional refrigerant amount per meter of actual main piping length (kg)

γ : Additional refrigerant amount per meter of actual branch piping length (kg)

L : Actual length of main piping (m)

a, b, c : Actual length of branch piping (m)

Connecting pipe diameter				Additional refrigerant amount per Meter (kg/m)		
L	a	b	c	α	β	γ
Ø9.5	Ø6.4	Ø6.4	Ø6.4	0.035	—	0.02

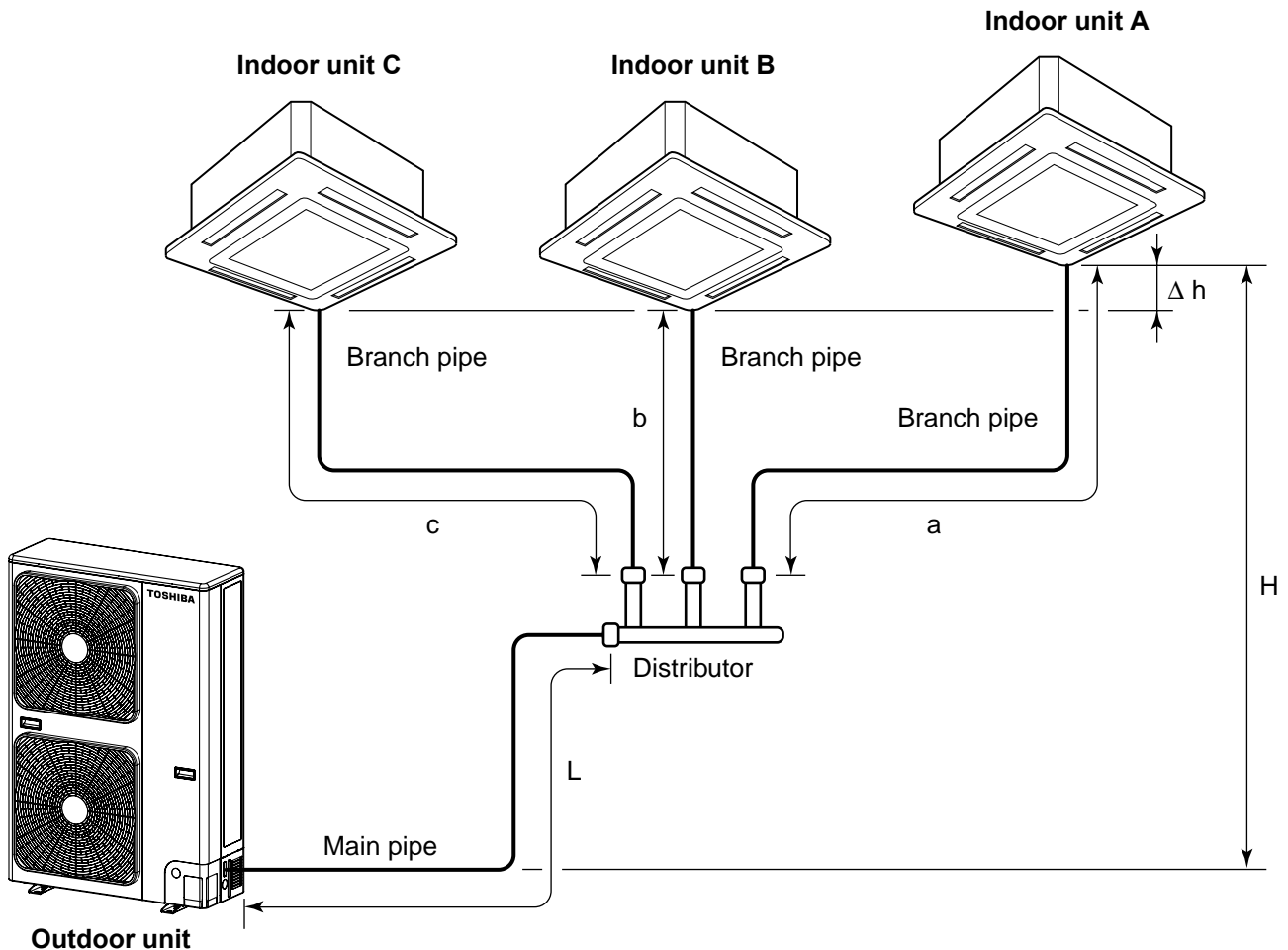

⚠ CAUTION

1. Be certain to wire the additional refrigerant amount, pipe length (actual length), head and other specification on the nameplate put on the outdoor unit for recording.
2. Seal the correct amount of additional refrigerant in the system.

6-10. Piping Materials and Sizes

■ Twin system

Use copper tube of Copper and copper alloy seamless pipes and tubes, with 40mg/10m or less in the amount of oil stuck on inner walls of pipe and 0.8mm in pipe wall thickness for diameters for diameters 6.4, 9.5 and 12.7mm and 1.0mm, for diameter 15.9mm. Never use pipes of thin wall thickness such as 0.7mm.

In parentheses () are wall thickness

Pipe side	Gas side	Main pipe	Ø15.9 (1.0)
		Branch pipe	Ø12.7 (0.8)
	Liquid side	Main pipe	Ø9.5 (0.8)
		Branch pipe	Ø6.4 (0.8)

■ Triple system

Use copper tube of Copper and copper alloy seamless pipes and tubes, with 40 mg/10 m or less in the amount of oil stuck on inner walls of pipe and 0.8 mm in pipe wall thickness for diameters 6.4, 9.5 and 12.7 mm and 1.0 mm, for diameter 15.9 mm. Never use pipes of thin wall thickness such as 0.7 mm.

<Between outdoor unit and distributor>

[Unit: mm]

Outdoor unit		
Main pipe	Gas side	Ø15.9 (1.0)
	Liquid side	Ø9.5 (0.8)

* (): Pipe wall thickness

<Between distributor and indoor unit>

[Unit: mm]

Indoor unit		RM56 type
Branch pipe	Gas side	Ø12.7 (0.8)
	Liquid side	Ø6.4 (0.8)

* (): Pipe wall thickness

6-11. Branch Pipe

■ Twin system

Now the refrigerant pipe is installed using branch pipes supplied as accessories.

- Bend and adjust the refrigerant piping so that the branch pipes and pipe after branching become horizontal.
- Fix the branch pipes onto a wall in a ceiling or onto a column.
- Provide a straight pipe longer than 500mm in length as the main piping of the branches.

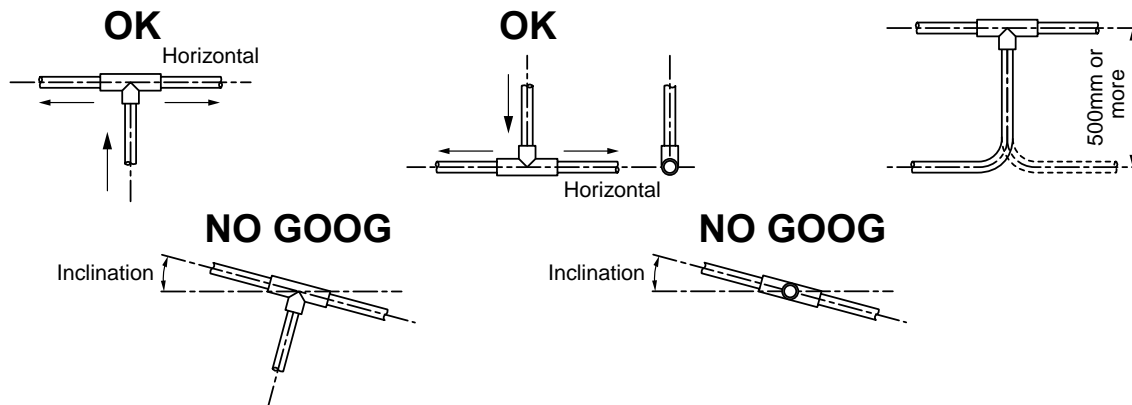

6-12. Distributor

■ Triple system

Now the refrigerant pipe is installed using distributor supplied as accessories.

- Bend and adjust the refrigerant piping so that the distributor and pipe after branching become horizontal.
- Fix the distributor onto a wall in a ceiling or onto a column.
- Provide a straight pipe longer than 500 mm in length as the main piping of the branches.

<How to install distributor>

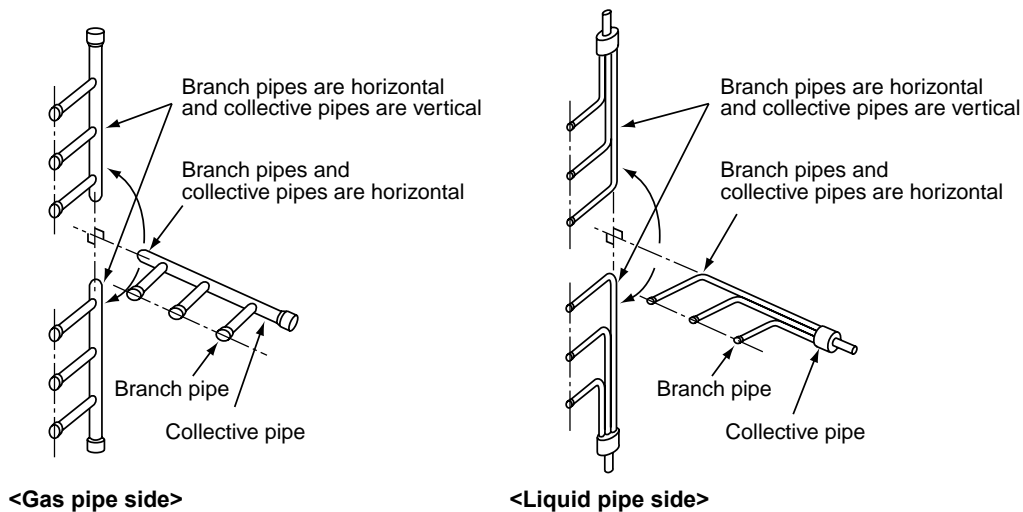

<Restrictions in length of the straight area of the branch pipe (main pipe side)>

Provide a straight area of 500 mm or more on the main pipe side of the branch pipe (for both gas pipe and liquid pipe sides).

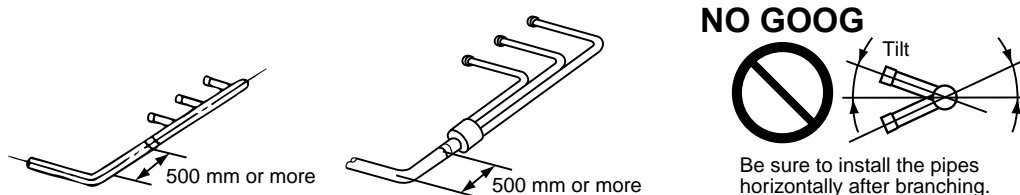

■ Air Purging

For the complete information, read the installation manual for outdoor units of air conditioner.

6-13. General safety precautions for using R32 refrigerant

6-13-1. Recovery

- When removing refrigerant from a system, either for servicing or decommissioning, it is recommended good practice that all refrigerants are removed safely.
- When transferring refrigerant into cylinders, ensure that only appropriate refrigerant recovery cylinders are employed.
- Ensure that the correct number of cylinders for holding the total system charge are available.
- All cylinders to be used are designated for the recovered refrigerant and labelled for that refrigerant (i.e. special cylinders for the recovery of refrigerant).
- Cylinders shall be complete with pressure relief valve and associated shut-off valves in good working order.
- Empty recovery cylinders are evacuated and, if possible, cooled before recovery occurs.
- The recovery equipment shall be in good working order with a set of instructions concerning the equipment that is at hand and shall be suitable for the recovery of flammable refrigerants.
- In addition, a set of calibrated weighing scales shall be available and in good working order.
- Hoses shall be complete with leak-free disconnect couplings and in good condition.
- Before using recovery machine check that it is satisfactory working order, has been properly maintained and that any associated electrical components are sealed to prevent ignition in the event of a refrigerant release.
- Consult manufacturer if in doubt.
- The recovered refrigerant shall be returned to the refrigerant supplier in the correct recovery cylinder, and the relevant Waste Transfer Note arranged.
- Do not mix refrigerants in recovery units and especially not in cylinders.
- If compressors or compressor oils are to be removed, ensure that they have been evacuated to an acceptable level to make certain that flammable refrigerant does not remain within the lubricant.
- The evacuation process shall be carried out prior to returning the compressor to the suppliers.
- Only electric heating to the compressor body shall be employed to accelerate this process.
- When oil is drained from a system, it shall be carried out safely.

6-13-3. Labelling

- Equipment shall be labelled stating that it has been de-commissioned and emptied of refrigerant.
- The label shall be dated and signed.
- Ensure that are labels on the equipment stating the equipment contains flammable refrigerant.

6-13-2. Decommissioning

- Before carrying out this procedure, it is essential that the technician is completely familiar with the equipment and all its details. Only a qualified installer (* 1) or qualified service person (* 1) is allowed to do this work.
- It is recommended good practice that all refrigerants are recovered safely.
- Prior to the task being carried out, an oil and refrigerant sample shall be taken in case analysis is required prior to re-use of reclaimed refrigerant.
- It is essential that electrical power is available before the task is commenced.

-
- a) Become familiar with the equipment and its operation.
 - b) Isolate system electrically.
 - c) Before attempting the procedure ensure that :
 - mechanical handling equipment is available, if required, for handling refrigerant cylinders;
 - all personal protective equipment is available and being used correctly;
 - the recovery process is supervised at all times by a competent person;
 - recovery equipment and cylinders conform to the appropriate standards.
 - d) Pump down refrigerant system, if possible.
 - e) If a vacuum is not possible, make a manifold so that refrigerant can be removed from the various parts of the system.
 - f) Make sure that cylinder is situated on the scales before recovery takes place.
 - g) Start the recovery machine and operate in accordance with manufacturers instructions.
 - h) Do not overfill cylinders (No more than 80%volume liquid charge).
 - i) Do not exceed the maximum working pressure of the cylinder, even temporarily.
 - j) When the cylinders have been filled correctly and the process complete, make sure that cylinders and the equipment are removed from site promptly and all isolation valves on the equipment are closed off.
 - k) Recovered refrigerant shall not be changed into another refrigerant system unless it has been cleaned and checked.
-

7. OUTDOOR CONTROL CIRCUIT

7-1. Outline of Main Controls

1. Pulse Modulating Valve (PMV) control

- 1) For PMV with 40 to 500 pulses during operation, respectively.
- 2) In cooling operation, PMV is controlled with the temperature difference between TS sensor and TC sensor.
- 3) In heating operation, PMV is controlled with the temperature difference between TS sensor and TE sensor.
- 4) For the temperature difference in items 2) and 3), -1 to 5K is aimed as the target in both cooling and heating operations.
- 5) When the cycle excessively rose in both cooling and heating operations, PMV is controlled by TD sensor.
The aimed value is usually 91°C in both cooling and heating operations.

REQUIREMENT

A sensor trouble may cause a liquid back-flow or abnormal overheat resulting in excessive shortening of the compressor life. In a case of trouble on the compressor, be sure to check there is no error in the resistance value an the refrigerating cycle of each sensor after repair and then start the operation.

2. Discharge temperature release control

- 1) When the discharge temperature did not fall or the discharge temperature rapidly went up by PMV control, this control lowers the compressor frequency. It subdivides the frequency control up to 0.6Hz to stabilize the cycle.
- 2) When the discharge temperature detected an abnormal stop zone, the compressor stops and then restarts after 2 minutes 30 seconds.
The error counting is cleared when the operation continued for 10 minutes. If the error is detected by 4 times without clearing, the error is determined and restarting is not performed.
* The cause is considered as excessively little amount of refrigerant, PMV error or clogging of the cycle.
- 3) For displayed contents of error, confirm on the check code list.

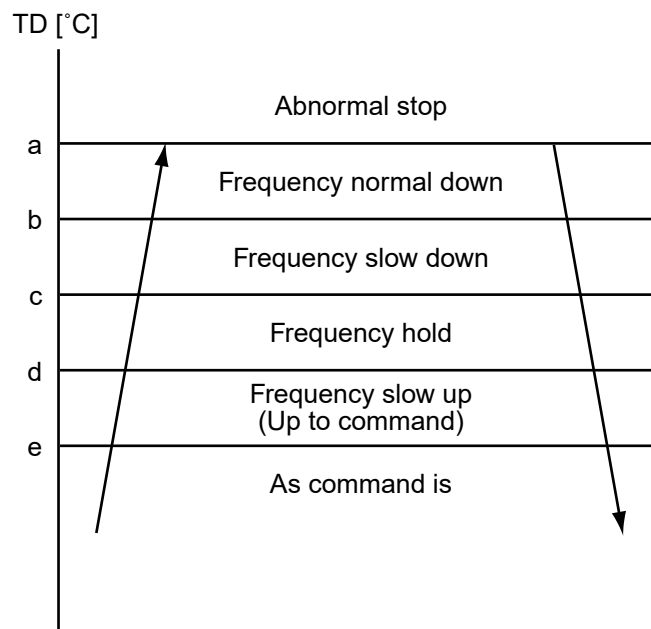

a	b	c	d	e
111	109	106	103	96

3. Current release control

The output frequency and the output voltage are controlled by AC current value detected by current transformer on the outdoor P.C. board so that input current of the inverter does not exceed the specified value.

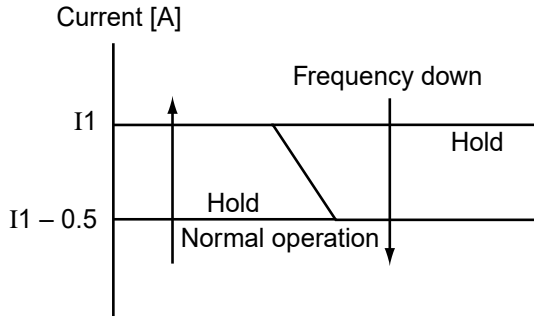

Model	GM160	
	COOL	HEAT
I1 value [A]	29	29

4. Outdoor fan control

Allocations of fan tap revolutions [rpm]

	W1	W2	W3	W4	W5	W6	W7	W8	W9	WA	WB	WC	WD	WE	WF
UPPER	250	280	330	360	410	460	520	580	650	700	760	830	860	940	980
LOWER	250	280	330	340	410	440	500	560	600	660	700	780	820	940	980

4-1. Cooling fan control

- 1) An outdoor fan is controlled by TL sensor, TO sensor and compressor frequency. An outdoor fan is controlled at 1-tap interval of DC fan control.
- 2) At the start time, the fan is fixed for 60 seconds only with the maximum fan tap corresponded to the zone in the following table but it is controlled with TL sensor temperature after then.

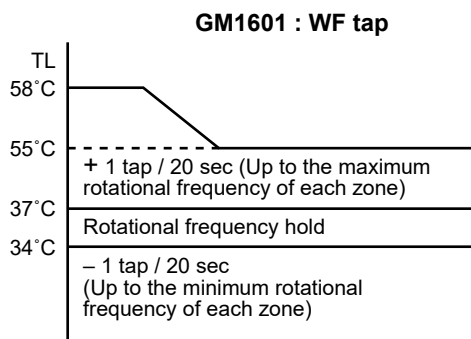

Temp. range	20.4Hz or lower		20.4Hz to 45.0Hz		45.0Hz or higher	
	Min.	Max.	Min.	Max.	Min.	Max.
$38^{\circ}\text{C} \leq \text{TO}$	W6	WC	W8	WF	WA	WF
$29^{\circ}\text{C} \leq \text{TO} < 38^{\circ}\text{C}$	W5	WB	W7	WE	W9	WE
$15^{\circ}\text{C} \leq \text{TO} < 29^{\circ}\text{C}$	W4	W8	W6	WA	W8	WC
$5^{\circ}\text{C} \leq \text{TO} < 15^{\circ}\text{C}$	W3	W6	W5	W8	W7	WA
$0^{\circ}\text{C} \leq \text{TO} < 5^{\circ}\text{C}$	W2	W4	W4	W6	W5	W8
$-4^{\circ}\text{C} \leq \text{TO} < 0^{\circ}\text{C}$	W2	W3	W3	W5	W4	W6
$\text{TO} < -4^{\circ}\text{C}$	OFF	W1	OFF	W1	W2	W7
TO error	OFF	WC	OFF	WF	W2	WF

4-2. Heating fan control

- 1) An outdoor fan is controlled by TE sensor, TO sensor and compressor frequency. (It is controlled with W1 for minimum and the maximum is controlled according to the following table.)
- 2) At the start time, the fan is fixed for 3 minutes only with the maximum fan tap corresponded to the zone in the following table but it is controlled with TE sensor temperature after then.
- 3) When a status $TE \geq 24^{\circ}\text{C}$ continues for 5 minutes, the operation stops. In this case, no error display appears and the status is same as the normal thermo-OFF. The can restarts after approx. 2 minutes 30 seconds and this continuous operation is not an error.
- 4) When the above status as 3) occurs frequently, it is considered that filter of the suction part of the indoor unit is dirty. Clean the filter and restart the operation.

TE	- 2 tap / 20 seconds (up to W1) Stop timer count
24°C	- 2 tap / 20 seconds (up to W1)
21°C	- 1 tap / 20 seconds (up to W1)
18°C	Rotational frequency hold
15°C	+ 1 tap / 20 seconds (up to Max. tap of each zone)

Temp. range	20.4 Hz or lower	20.4Hz to 45.0Hz	45.0Hz or higher
	Max.	Max.	Max.
$10^{\circ}\text{C} \leq \text{TO}$	WA	WB	WC
$5^{\circ}\text{C} \leq \text{TO} < 10^{\circ}\text{C}$	WC	WC	WC
$-3^{\circ}\text{C} \leq \text{TO} < 5^{\circ}\text{C}$	WC	WC	WE
$-10^{\circ}\text{C} \leq \text{TO} < -3^{\circ}\text{C}$	WE	WE	WE
$\text{TO} < -10^{\circ}\text{C}$	WE	WE	WE
TO error	WE	WE	WE

5. Coil heating control

- 1) This control function heats the compressor by turning on the stopped compressor instead of a case heater. It purposes to prevent stagnation of the refrigerant inside of the compressor.
- 2) As usual, turn on power of the compressor for the specified time before a test run after installation; otherwise a trouble of the compressor may be caused.
As same as a test run, it is recommended to turn on power of the compressor beforehand when starting operation after power of the compressor has been interrupted and left as it is for a long time.
- 3) A judgment for electricity is performed by TD and TO sensors.
If TO sensor is defective, a backup control is automatically performed by TE sensor.
For a case of defective TO sensor, judge it with outdoor LED display.
- 4) For every model, the power is turned off when TD is 30°C or more.

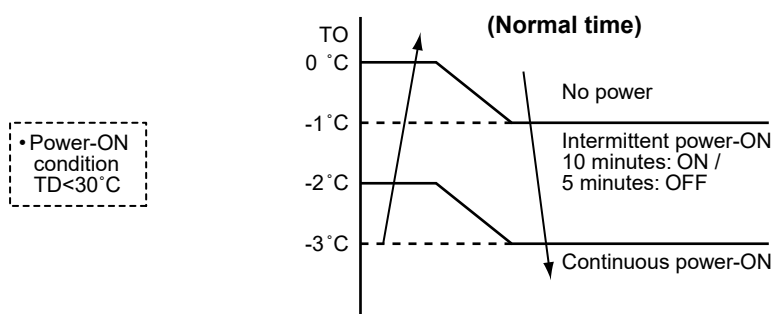

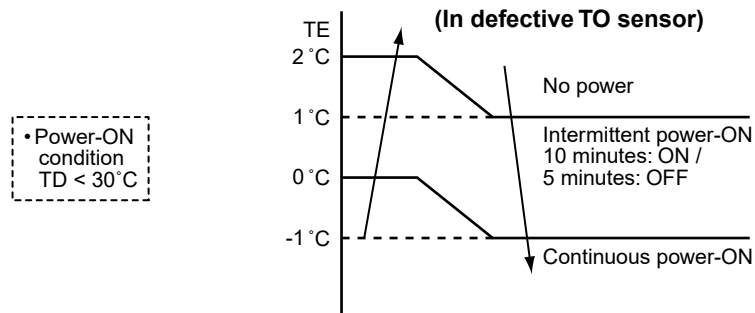

Output power	50W
--------------	-----

REQUIREMENT

While heating the coil, the power sound may be heard. However it is not a trouble.

6. Short intermittent operation preventive control

- For 3 to 10 minutes after operation start, in some cases, the compressor does not stop to protect the compressor even if receiving the thermostat-OFF signal from indoor. However it is not abnormal status. (The operation continuance differs according to the operation status.)
- When the operation stops by the remote controller, the operation does not continue.

7. Current release value shift control

- This control purposes to prevent troubles of the electronic parts such as the compressor driving elements and the compressor during cooling operation.
- The current release control value (I1) is selected from the following table according to TO sensor value.

Current release control value (I1)

Temperature range	[A]
$47^{\circ}\text{C} \leq \text{TO}$	13.6
$44^{\circ}\text{C} \leq \text{TO} < 47^{\circ}\text{C}$	24.0
$39^{\circ}\text{C} \leq \text{TO} < 44^{\circ}\text{C}$	26.0
TO error	13.6

8. Over-current protective control

- When the over-current protective circuit detected an abnormal current, stop the compressor.
- The compressor restarts after 2 minutes 30 seconds setting [1] as an error count.
- When the error count [8] was found, determine an error and restart operation is not performed.
- For the error display contents, confirm on the check code list.

9. High-pressure release control

- The operation frequency is controlled to restrain abnormal rising of high pressure by TL sensor in cooling operation and TC sensor in heating operation.
- When TL sensor in cooling operation or TC sensor in heating operation detects abnormal temperature of the stop zone, stop the compressor and the error count becomes +1.
- When the compressor stopped with 2), the operation restarts from the point of the normal operation zone (e point or lower) where it returned after 2 minutes 30 seconds.
- The error count when the compressor stopped with 2) is cleared after the operation continued for 10 minutes. If the error count becomes [10] without clearing, the error is determined and reactivation is not performed.
- For the error display contents, confirm on the check code list.

HEAT TC / COOL TL
[°C]

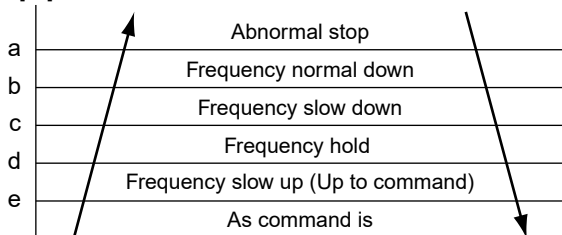

	[°C]	
	HEAT TC	COOL TL
a	61°C	62°C
b	57°C	62°C
c	54°C	60°C
d	52°C	58°C
e	48°C	54°C

10. Defrost control

- ① In heating operation, defrost operation is performed when TE sensor temperature satisfies any condition in A zone to D zone.
- ② The defrost operation is immediately finished if TE sensor temperature has become 12°C continuing for 3 seconds or more, or it also is finished when condition of 7°C < TE < 12°C has continued for 1 minute. The defrost operation is also finished when defrost operation has continued for 10 minutes even if TE sensor temperature has become 7°C or lower.
- ③ After defrost operation has finished, the compressor and the outdoor fan start heating operation after stopped for approx. 40 seconds.

Start of heating operation

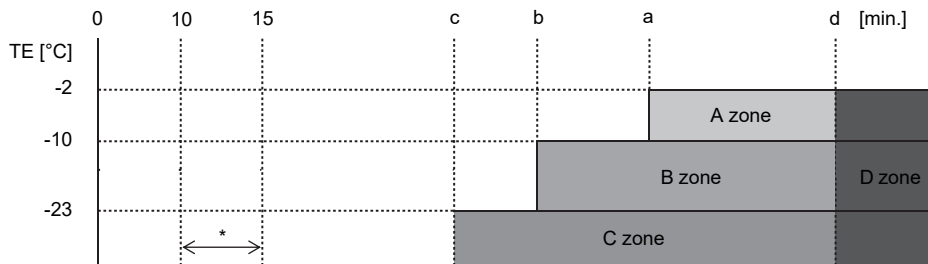

* From 10 minutes to 15 minutes after a heating operation started, the minimum value of TE is stored in memory as TEO and the minimum temperature of TO as ToO.

	At normal TO	At error TO
A zone	When status of [(TEO – TE) – (ToO – TO) ≥ 3°C] continued for 20 seconds	When status of [(TEO – TE) ≥ 3°C] continued for 20 seconds
B zone	When status of [(TEO – TE) – (ToO – TO) ≥ 2°C] continued for 20 seconds	When status of [(TEO – TE) ≥ 2°C] continued for 20 seconds
C zone	When status of TE ≤ –23C] continued for 20 seconds	
D zone	When compressor operation status with TE < – 2°C is added by d times	

a	55
b	45
c	39
d	150

11. High-pressure switch

- 1) When the high-pressure switch operates, the operation of the compressor is terminated.
- 2) The compressor restarts after 5 minutes using [1] as an error count. After restart, the error count is cleared when operation continues for 10 minutes or more.
- 3) An error is confirmed with the error count [10].
- 4) For the indicated contents of error, confirm using the check code table.

12. Control of compressor case thermo

- 1) The compressor stops when the case thermo of the compressor operated.
- 2) When the case thermo operated for approx. 80 seconds, H04 error code is displayed on the wired remote controller. → Refer to the Check Code.
- 3) When the case thermo is reset, the operation restarts.

7-2. Outdoor Print Circuit Board

RAV-GM1601AT*P*

<MCC-1758>

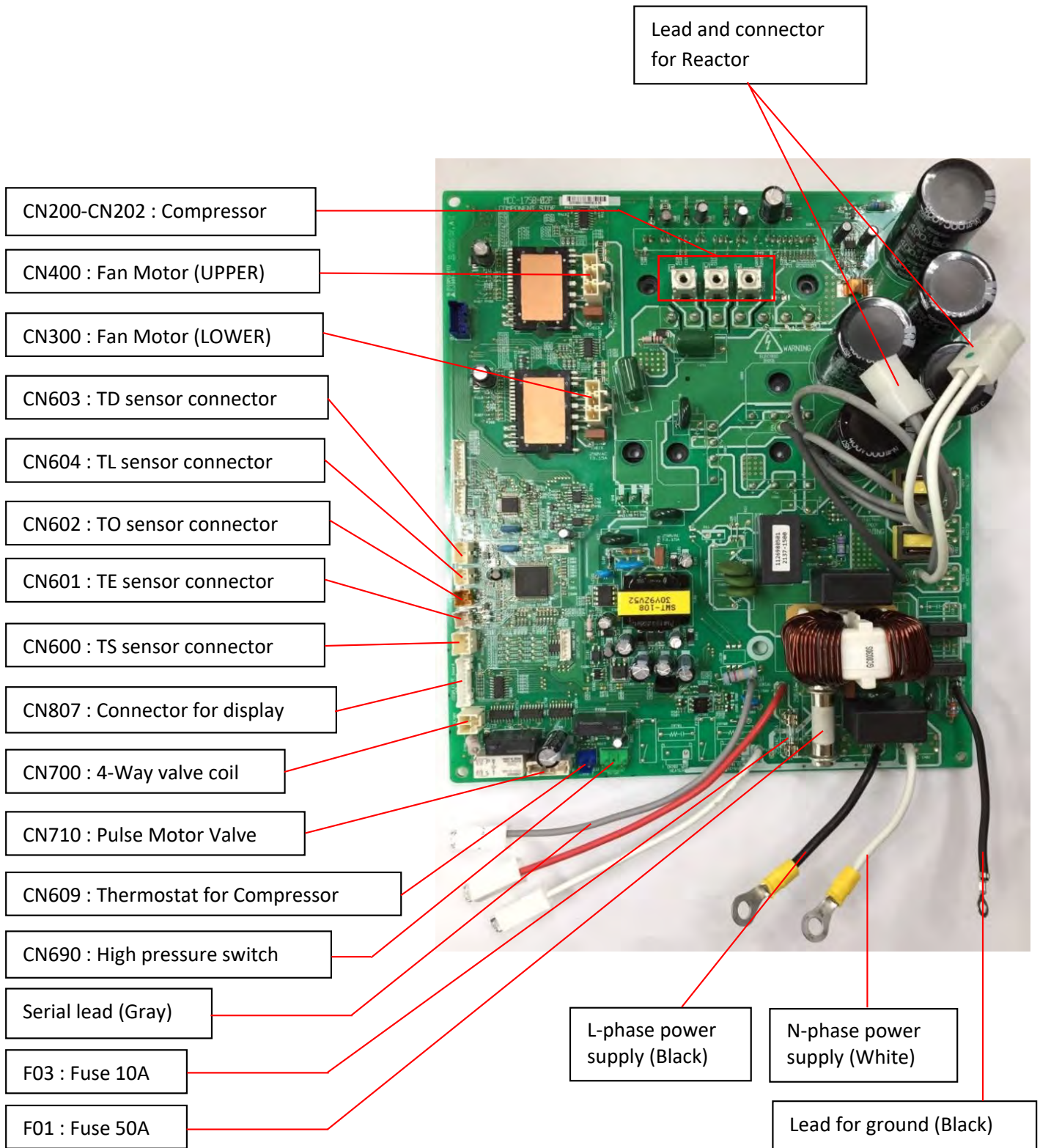

8. TROUBLESHOOTING

8-1. Summary of Troubleshooting

<Wired remote controller type>

1. Before troubleshooting

- 1) Required tools/instruments
 - ⊕ and ⊖ screwdrivers, spanners, radio cutting pliers, nippers, push pins for reset switch
 - Tester, thermometer, pressure gauge, etc.
- 2) Confirmation the following points before check
 - a) The following operations are normal.
 1. Compressor does not operate.
 - When 3-minutes delay (3 minutes after compressor OFF)
 - When the outdoor unit is in standby mode due to the room temperature reached the setup temperature
 - When the timer is operating
 - When indoor fan only operation mode
 - When an overflow error is detected in the indoor unit
 - When outside high-temperature operation controlled is in heating operation
 - When Thermo-OFF setting by Application Control Kit (TCB-PCOS1E2)
 2. Indoor fan does not rotate.
 - When cool air discharge prevention control is working in heating operation
 3. Outdoor fan does not rotate or air volume changes.
 - When high-temperature release operation control is working in heating operation
 - When outside low-temperature operation control is working in cooling operation
 - When defrost operation is being performed
 4. ON/OFF operation cannot be performed from remote controller.
 - When the control operation is being performed from outside/remote side
 - When automatic address is being set up
(When the power is turned on at the first time or when indoor unit address setting is changed, the operation will be performed after power-ON in 5 minutes or before.)
 - When the test run is being performed by operation of the outdoor controller
 - b) Did you return the cabling to the initial positions?
 - c) Are indoor unit and remote controller connected correctly?

2. Troubleshooting procedure

When a trouble occurred, check the parts along with the following procedure.



NOTE

Microcomputer misdiagnosis may also be caused by power condition problem and outer noise other than the checked items. If there is any noise source, change the cables of the remote controller to shield cables.

<Wireless remote controller type>

1. Before troubleshooting

- 1) Required tools/instruments
 - ⊕ and ⊖ screwdrivers, spanners, radio cutting pliers, nippers, etc.
 - Tester, thermometer, pressure gauge, etc.
- 2) Confirmation the following points before check
 - a) The following operations are normal.
 1. Compressor does not operate.
 - When 3-minutes delay (3 minutes after compressor OFF)
 - When the outdoor unit in standby status due to the room temperature reached the setup temperature
 - When the timer is operating
 - When indoor fan only operation mode
 - When an overflow error is detected on the indoor unit
 - When outside high-temperature operation controlled is in heating operation
 - When Thermo-OFF setting by Application Control Kit (TCB-PCOS1E2)
 2. Indoor fan does not rotate.
 - Does not cool air discharge preventive control work in heating operation?
 3. Outdoor fan does not rotate or air volume changes.
 - When high-temperature release operation control is working in heating operation
 - When outside low-temperature operation control is working in cooling operation
 - When defrost operation is being performed
 4. ON/OFF operation cannot be performed from remote controller.
 - When forced operation is being performed
 - When the control operation is being performed from outside/remote side
 - When automatic address being set up
 - When the test run is being performed by operation of the outdoor controller
 - b) Did you return the cabling to the initial positions?
 - b) Are connecting cables between indoor unit and receiving unit correct?

2. Troubleshooting procedure

(When the power is turned on at the first time or when indoor unit address setting is changed, the operation will be performed after power-ON in 5 minutes or before.)

When a trouble occurred, check the parts along with the following procedure.

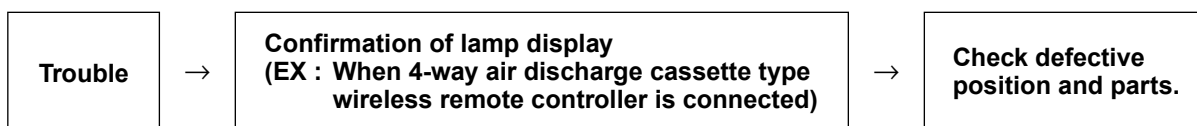

1) Outline of judgment

The primary judgment to check where a trouble occurred in indoor unit or outdoor unit is performed with the following method.

The errors can be identified by lamp indication of indoor unit (sensors of the receiving unit)

The indoor unit monitors operating status of the air conditioner, and the blocked contents of self-diagnosis are displayed restricted to the following cases if a protective circuit works.

8-2. Troubleshooting

8-2-1. Outline of judgment

The following method can be done to check whether the problem occurred in indoor or outdoor unit.

The error is indicated by indication lamp on the display of the indoor unit. (sensors of the receiving part)

The indoor unit monitors the operating status of the air conditioner, and the blocked contents of self-diagnosis are displayed restricted to the following cases if a protective circuit works.

● : OFF, ○ : ON, ◐ : Flash (0.5 sec.)

Lamp indication	Check code	Cause of trouble	
Operation Timer Ready ● ● ● No indication at all	—	Power supply OFF or miswiring between receiving unit and indoor unit	
Operation Timer Ready ◐ ● ● Flash	E01	Receiving error } Receiving unit } Sending error } Communication stop } Miswiring or wire connection error between receiving unit and indoor unit	
	E02		
	E03		
	E08	Duplicated indoor unit No.	Setup error
	E09	Duplicated header units of remote controller	
	E10	Communication error between CPUs on indoor unit P.C. board	
	E11	Communication error between Application control kit and indoor unit P.C. board	
E18	Wire connection error between indoor units, Indoor power OFF (Communication stop between indoor master and follower or between main and sub indoor twin)		
Operation Timer Ready ● ● ◐ Flash	E04	Miswiring between indoor unit and outdoor unit or connection error (Communication stop between indoor and outdoor units)	
Operation Timer Ready ● ◐ ◐ Alternate flash	P10	Overflow was detected. } Indoor DC fan error } Protective device of indoor unit worked.	
	P12		
Operation Timer Ready ◐ ● ◐ Alternate flash	P03	Outdoor unit discharge temp. sensor error } Case thermostat operation, High pressure protective operation, High pressure SW system error, Power supply error, } Power supply error } Heat sink overheat error } Gas leak detection } Protective device of outdoor unit worked.	
	P04		
	P05		
	P07		
	P15		
	P19	4-way valve inverse error (Indoor or outdoor unit detected)	
	P20	High pressure protective operation } Outdoor unit fan system error } Short-circuit of compressor drive element } Position detection circuit error } Protective device of outdoor unit worked.	
	P22		
	P26		
P29			
P31	Stopped because of error of other indoor units in a group (Check codes of E03/L03/L07/L08)		

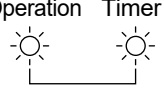
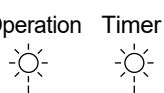
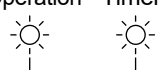
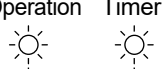
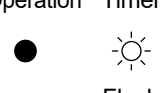
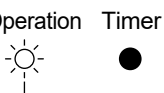
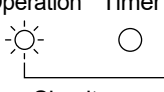
Lamp indication	Check code	Cause of trouble occurrence
Operation Timer Ready  Alternate flash	F01	Heat exchanger sensor (TCJ) error } Indoor unit sensor error Heat exchanger sensor (TC) error } Heat exchanger sensor (TA) error }
	F02	
	F10	
Operation Timer Ready  Alternate flash	F04	Discharge temp. sensor (TD) error } Sensor error of outdoor unit Temp. sensor (TE, TS, TL) error } Heat exchanger temp. sensor (TL) error } Outside air temp. sensor (TO) error } Suction temp. sensor (TS) error } Heat sink temp. sensor (TH) error } Miss-mounting of temp. sensor (TE, TS) }
	F06	
	F07	
	F08	
	F12	
	F13	
	F15	
Operation Timer Ready  Simultaneous flash	F29	Indoor EEPROM error
Operation Timer Ready  Simultaneous flash	F31	Outdoor EEPROM error
Operation Timer Ready  Flash	H01	Compressor break down } Outdoor compressor system error Compressor lock }
	H02	
	H03	Outdoor unit current detection circuit error
	H04	Case thermostat operation
Operation Timer Ready  Simultaneous flash	L03	Duplicated header indoor units } → AUTO address * If group construction and address are not normal power supply turned on, automatically goes to address setup mode. There is indoor unit of group connection } in individual indoor unit. Unsetting of group address Missed setting (Unset indoor capacity)
	L07	
	L08	
	L09	
Operation Timer Ready  Simultaneous flash	L10	Outdoor unit unset model type of service P.C. board
	L20	Duplicated indoor central addresses
	L29	Outdoor P.C. board part error was detected (EEPROM error, Heat sink temp. sensor (TH) error) Outdoor unit unset model type of service P.C. board. Outdoor Heat sink overheat error, Gas leak detection, or 4-way valve system error.
	L30	Outside interlock error

8-2-2. Others (Other than Check Code)

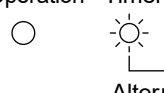
Lamp indication	Check code	Cause of trouble occurrence
Operation Timer Ready  Simultaneous flash	—	During test run
Operation Timer Ready  Alternate flash	—	Disagreement of cool/heat (Automatic cool/heat setting to automatic cool/heat prohibited model, or setting of heating to cooling-only model)

8-2-3. Monitor Function of Remote Controller Switch

■ Calling of sensor temperature display

<Contents>

Each data of the remote controller, indoor unit and outdoor unit can be shown by calling the service monitor mode from the remote controller.

<Procedure>

- 1 Push **TEST** + **CL** buttons simultaneously for 4 seconds to call the service monitor mode.

The service monitor shows up, the master indoor unit No. is displayed at first and then the temperature CODE No. **00** is displayed.



- 2 Push temperature set **TEMP** buttons and then change the CODE No. of data to be monitored.

The CODE No. list is shown below.

<RBC-AMT32E>

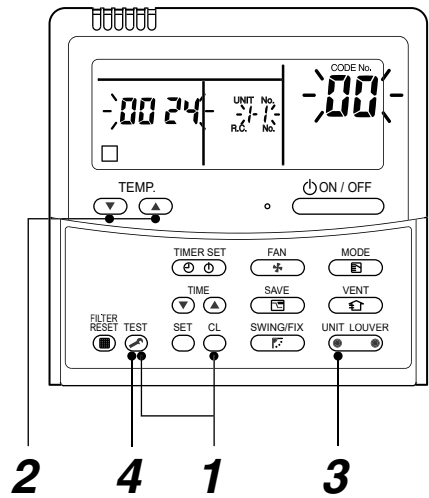

<Operation procedure>

1 → 2 → 3 → 4

Returned to usual display

	CODE No.	Data name	Unit
Indoor unit data	01	Room temperature (Remote controller)	°C
	02	Indoor suction temperature (TA)	°C
	03	Indoor heat exchanger (Coil) temperature (TCJ)	°C
	04	Indoor heat exchanger (Coil) temperature (TC)	°C
	* 07	Indoor fan revolution frequency	rpm
	* F2	Indoor fan calculated operation time	×100h
	F3	Filter sign time	×1h
	* F8	Indoor discharge temperature*1 (4-way only)	°C

	CODE No.	Data name	Unit
Outdoor unit data	60	Outdoor heat exchanger (Coil) temperature (TE)	°C
	61	Outside temperature (TO)	°C
	62	Compressor discharge temperature (TD)	°C
	63	Compressor suction temperature (TS)	°C
	65	Heat sink temperature (TH)	°C
	6A	Operation current (× 1/10)	A
	* 6D	Outdoor heat exchanger (Coil) temperature (TL)	°C
	* 70	Compressor operation frequency	rps
	* 72	Outdoor fan revolution frequency (Lower)	rpm
	* 73	Outdoor fan revolution frequency (Upper)	rpm
F1	Compressor calculated operation time	×100h	

- The CODE No. with * marks in the above table are displayed only on the indoor units of 1 series models and later. (1 series indoor units mean RAV-RM1601UTP-E for example.).
- The indoor discharge temperature of CODE No. [F8] is the estimated value from TC or TCJ sensor. Use this value to check discharge temperature at test run. (A discharge temperature sensor is not provided to this model.)
- The data value of each item is not the real time, but value delayed by a few seconds to ten-odd seconds.



- 3 Push **UNIT LOUVER** button to select the indoor unit to be monitored. Each data of the indoor unit and its outdoor units can be monitored.



- 4 Pushing **TEST** button to returns to the usual display.

8-2-4. Check Code List (Outdoor)

○ : ON, ◎ : Flash, ● : OFF
 ALT (Alternate): Alternate flashing when there are two flashing LED/SIM (Simultaneous): Simultaneous flashing when there are two flashing LED

Central Control indication	Remote Controller indication	Sensor lamp part		Defected position	Detection	Explanation of error contents	Automatic Reset	Operation continuation
		Block indication	Flash					
19	F04	◎	◎	Outdoor unit Discharge temp. sensor (TD) error	Outdoor	Disconnection, short of discharge temp. sensor (TD) was detected	X	X
18	F06	◎	◎	Outdoor unit heat exchanger temp. sensor (TE) error	Outdoor	Disconnection, short of outdoor unit heat exchanger temp. sensor (TE) was detected.	X	X
18	F07	◎	◎	Outdoor unit Heat exchanger t temp. sensor (TL) error	Outdoor	Disconnection, short of outside heat exchanger temp. Sensor (TL) was detected.	X	X
1b	F08	◎	◎	Outdoor unit Outside air temp. sensor (TO) error	Outdoor	Disconnection, short of outside air temp. Sensor (TO) was detected.	○	○
A2	F12	◎	◎	Outdoor unit Suction temp. sensor (TS) error	Outdoor	Disconnection, short of suction temp. Sensor (TS) was detected.	X	X
43	F13	◎	◎	Outdoor unit Heat sink temp. sensor (TH) error	Outdoor	Disconnection, short of heat sink temp. Sensor (TH) (P.C. board installed) was detected.	X	X
18	F15	◎	◎	Outdoor unit Miss-mounting of temp. sensor (TE, TS)	Outdoor	Miss-mounting of outdoor heat exchanger temp. sensor (TE) and suction temp. sensor(TS) was detected.	X	X
1F	H01	●	●	Outdoor unit Compressor break down	Outdoor	Reached release point at min-Hz during compressor operating.	X	X
1d	H02	●	●	Outdoor unit Compressor lock	Outdoor	Compressor lock was detected.	X	X
17	H03	●	●	Outdoor unit Current detection circuit error	Outdoor	Current detection circuit error.	X	X
44	H04	●	●	Outdoor unit case thermostat operated	Outdoor	Case thermostat operated.	X	X
88	L10	◎	◎	Outdoor unit Unset model type of service P.C. board	Outdoor	When outdoor service P.C. board was used, model type select jumper setting was inappropriate.	X	X
1C	L29	◎	◎	Outdoor unit error	Outdoor	1) Outdoor P.C. board part error was detected (EEPROM error, Heat sink temp. sensor (TH) error) 2) Outdoor unit Unset model type of service P.C. board. 3) Outdoor Heat sink overheat error, Gas leak detection, or 4-way valve system error.	X	X
1E	P03	◎	◎	Outdoor unit Discharge temp. error	Outdoor	Error was detected by discharge temp. release control.	X	X
21	P04	◎	◎	Outdoor unit High pressure SW system error	Outdoor	High pressure protection switch operated.	X	X
AF	P05	◎	◎	Power supply error	Outdoor	Power supply voltage error.	X	X
1C	P07	◎	◎	Outdoor unit Heat sink overheat error	Outdoor	Abnormal overheat was detected by outdoor heat sink temp. sensor (TH).	X	X
AE	P15	◎	◎	Gas leak detection	Outdoor	Abnormal overheat of discharge temp. sensor (TD) or suction temp. sensor (TS) was detected.	X	X
22	P20	◎	◎	Outdoor High pressure protective operation	Outdoor	Error was detected by high pressure release control from indoor / outdoor heat exchanger temp. sensor.	X	X
1A	P22	◎	◎	Outdoor unit Outdoor fan system error	Outdoor	Error (Over-current, lock, etc.) was detected on outdoor fan drive circuit.	X	X
14	P26	◎	◎	Outdoor unit Short-circuit of compressor drive element	Outdoor	Short-circuited protective operation of compressor drive circuit element (G-Tr / IGBT) operated.	X	X
16	P29	◎	◎	Outdoor unit Position detection circuit error	Outdoor	Position detection error of compressor motor was detected.	X	X
97	E01	◎	●	No remote controller master unit	Remote controller	Signal was not received from indoor unit.	-	-
-	E02	◎	●	Remote controller communication error	Remote controller	Main remote controller was not set. (including 2 remote controllers)	-	-
97	E03	◎	●	Regular communication error between indoor and remote controller	Indoor	Signal cannot be sent to indoor unit.	○	X
04	E04	●	◎	Indoor/Outdoor serial error	Indoor	Serial communication error between indoor and outdoor	○	X
96	E08	◎	●	Duplicated indoor addresses	Indoor	Same address as yours was detected.	○	X
99	E09	◎	●	Duplicated main remote controllers	Remote controller	In 2-remote controller control, both were set as master. (In 2-remote controller warning and follower unit continues operation.)	X	X
CF	E10	◎	●	Communication error between CPU	Indoor	MCU communication error between main motor and micro computer	○	△

Central Control indication	Remote Controller Indication	Sensor lamp part		Defected position	Detection	Explanation of error contents	Automatic Reset	Operation continuation
		Block indication	Flash					
4B	E11	○ ● ● ●		Communication error between Application control kit and indoor unit	Indoor	Communication error between Application control kit and indoor unit P.C. board	○	X
97,99	E18	○ ● ● ●		Regular communication error between master and follower indoor units	Indoor	Regular communication cannot be performed between master and follower indoor units. Communication between twin master (Main unit) and follower (sub unit) cannot be performed.	○	X
96	L03	○ ● ● ●	SIM	Duplicated indoor master units	Indoor	There are multiple master units in a group.	X	X
99	L07	○ ● ● ●	SIM	There is group cable in individual indoor unit.	Indoor	When even one group connection indoor unit exists in individual indoor unit	X	X
99	L08	○ ● ● ●	SIM	Unset indoor group address	Indoor	Indoor address group was unset.	X	X
46	L09	○ ● ● ●	SIM	Unset indoor capacity	Indoor	Capacity of indoor unit was unset.	X	X
66	L30	○ ○ ○ ●	SIM	Outside error input to indoor unit (Interlock)	Indoor	Abnormal stop by CN80 outside error input	X	X
08	P19	○ ● ● ●	ALT	4-way valve inverse error	Indoor Outdoor	In heating operation, error was detected by temp. down of indoor heat exchanger or temp. up of TE, TS.	○	X

◇ When this warning was detected before group construction/address check finish at power supply was turned on, the mode shifts automatically to AUTO address setup mode.

Error mode detected by indoor unit

Operation of diagnostic function				Judgment and measures
Check code	Cause of errors	Status of air conditioner	Condition	
E03	No communication from remote controller (including wireless) and communication adapter	Stop (Automatically reset)	Displayed when error is detected	1. Check cables of remote controller and communication adapters. • Remote controller LCD display OFF (Disconnection) • Central remote controller [97] check code
E04	The serial signal is not output from outdoor unit to indoor unit. • Miswiring of inter-unit wire • Defective serial sending circuit on outdoor P.C. board • Defective serial receiving circuit on indoor P.C. board	Stop (Automatically reset)	Displayed when error is detected	1. Outdoor unit does not completely operate. • Inter-unit wire check, correction of miswiring • Check outdoor P.C. board. Correct wiring of P.C. board. 2. When outdoor unit normally operates Check P.C. board (Indoor receiving / Outdoor sending).
E08	Duplicated indoor unit address	Stop	Displayed when error is detected	1. Check whether remote controller connection (Group/Individual) was changed or not after power supply turned on (Finish of group construction/Address check). * If group construction and address are not normal when the power has been turned on, the mode automatically shifts to address setup mode. (Resetting of address)
L03	Duplicated indoor master unit			
L07	There is group wire in individual indoor unit.			
L08	Unset indoor group address			
L09	Unset indoor capacity	Stop	Displayed when error is detected	1. Set indoor capacity (CODE No. (DN) = 11)
L30	Abnormal input of outside interlock	Stop	Displayed when error is detected	1. Check outside devices. 2. Check indoor P.C. board.
P10	Float switch operation • Float circuit, Disconnection, Coming-off, Float switch contact error	Stop	Displayed when error is detected	1. Trouble of drain pump 2. Clogging of drain pump 3. Check float switch. 4. Check indoor P.C. board. 5. Check Application control kit of indoor unit
P12	Indoor DC fan error	Stop	Displayed when error is detected	1. Position detection error 2. Over-current protective circuit of indoor fan driving unit operated. 3. Indoor fan locked. 4. Check indoor P.C. board.
P19	4-way valve system error • After heating operation has started, indoor heat exchangers temp. is down.	Stop (Automatically reset)	Displayed when error is detected	1. Check 4-way valve. 2. Check PMV 3. Check indoor heat exchanger (TC/TCJ). 4. Check indoor P.C. board.
P31	Own unit stops while warning is output to other indoor units.	Stop (Follower unit) (Automatically reset)	Displayed when error is detected	1. Judge follower unit while header unit is [E03], [L03], [L07] or [L08]. 2. Check indoor P.C. board.
F01	Coming-off, disconnection or short of indoor heat exchanger temp. sensor (TCJ)	Stop (Automatically reset)	Displayed when error is detected	1. Check indoor heat exchanger temp. sensor (TCJ). 2. Check indoor P.C. board.
F02	Coming-off, disconnection or short of indoor heat exchanger temp. sensor (TC)	Stop (Automatically reset)	Displayed when error is detected	1. Check indoor heat exchanger temp. sensor (TC). 2. Check indoor P.C. board.
F10	Coming-off, disconnection or short of indoor heat exchanger temp. sensor (TA)	Stop (Automatically reset)	Displayed when error is detected	1. Check indoor heat exchanger temp. sensor (TA). 2. Check indoor P.C. board.
F29	Indoor EEPROM error • EEPROM access error	Stop (Automatically reset)	Displayed when error is detected	1. Check indoor EEPROM. (including socket insertion) 2. Check indoor P.C. board.
E10	Communication error between indoor MCU • Communication error between fan driving MCU and main MCU	Stop (Automatically reset)	Displayed when error is detected	1. Check indoor P.C. board.
E11	Communication error between Application and indoor unit	Stop (Automatically reset)	Displayed when error is detected	1. Check power supply / communication harness 2. Check indoor P.C. board
E18	Regular communication error between indoor master and follower units and between main and sub units	Stop (Automatically reset)	Displayed when error is detected	1. Check remote controller wiring. 2. Check indoor power supply wiring. 3. Check indoor P.C. board.

Error mode detected by outdoor unit

Operation of diagnostic function				Judgment and measures
Check code	Cause of errors	Status of air conditioner	Condition	
Indoor unit				
F04	Disconnection, short of discharge temp. sensor (TD)	Stop	Displayed when error is detected	1. Check discharge temp. sensor (TD). 2. Check outdoor P.C. board
F06	Disconnection, short of heat exchanger temp. sensor (TE)	Stop	Displayed when error is detected	1. Check heat exchanger temp. sensor (TE). 2. Check outdoor P.C. board .
F07	Disconnection, short of heat exchanger temp. sensor (TL)	Stop	Displayed when error is detected	1. Check heat exchanger temp. sensor (TL). 2. Check outdoor P.C. board .
F12	Disconnection, short of suction temp. sensor (TS)	Stop	Displayed when error is detected	1. Check suction temp. sensor (TS). 2. Check outdoor P.C. board.
F15	Miss-mounting of outdoor temp. sensor (TE, TS)	Stop	Displayed when error is detected	1. Check temp. sensor (TE, TS). 2. Check outdoor P.C. board.
F08	Disconnection, short of outside air temp. sensor (TO)	Continue	Displayed when error is detected	1. Check outside air temp. sensor (TO). 2. Check outdoor P.C. board.
F13	Disconnection, short of heat sink temp. sensor (TH)	Stop	Displayed when error is detected	1. Check outdoor P.C. board
F31	Outdoor EEPROM error	Stop	Displayed when error is detected	1. Check outdoor P.C. board.
L10	Unset model type of service P.C. board	Stop	Displayed when error is detected	1. Outdoor service P.C. board. Check model type setting jumper wire.
P07	Heat sink overheat error * Heat sink temp. sensor detected over specified temperature.	Stop	Displayed when error is detected	1. Check screw tightening between P.C. board and heat sink and check radiator grease. 2. Check heat sink blast path.
P15	Detection of gas leak * Discharge temp. sensor (TD), Suction temp. sensor (TS) detected temperature over specified temp.	Stop	Displayed when error is detected	1. Check gas leak, recharge 2. Check full open of service valve. 3. Check PMV (Pulse Motor Valve). 4. Check broken pipe. 5. Check discharge temp. sensor (TD), suction temp. sensor (TS).
P19	4-way valve inverse error * After heating operation has started, indoor heat exchanger temp. drops under the specified temp. * After heating operation has started, outdoor heat exchanger / suction temp. rises over the specified temp.	Stop	Displayed when error is detected	1. Check operation of 4-way valve. 2. Check outdoor heat exchanger (TE), suction temp. sensor (TS). 3. Check indoor heat exchanger sensor (TC). 4. Check 4-way valve coil. 5. Check PMV (Pulse Motor Valve).
H01	Compressor break down * Although operation has started, operation frequency decreases and operation stops.	Stop	Displayed when error is detected	1. Check power supply voltage. (50 Hz : AC 198 to 264 V, 60 Hz : AC 198 to 242 V) 2. Overload operation of refrigerating cycle
H02	Compressor lock * Over-current detection after compressor start-up	Stop	Displayed when error is detected	1. Compressor problem (Lock, etc.): Replace compressor. 2. Compressor wiring error (Open phase)

Operation of diagnostic function				Judgment and measures
Check code	Cause of errors	Status of air conditioner	Condition	
Indoor unit				
H03	Current detection circuit error	Stop	Displayed when error is detected	1. Check outdoor P.C. board. (AC current detection circuit)
H04	Case thermostat operation *Abnormal overheat of compressor	Stop	Displayed when error is detected	1. Check case thermostat and its connector 2. Check gas leak, recharge 3. Check full open of service valve 4. Check PMV (Pulse Motor Valve) 5. Check broken pipe
P03	Discharge temp. error * Discharge temp. (TD) over specified value was detected.	Stop	Displayed when error is detected	1. Check refrigerating cycle (Gas leak) 2. Check PMV (Pulse Motor Valve) 3. Check discharge temp. sensor (TD).
P04	High pressure SW system error	Stop	Displayed when error is detected	1. Check service valves are fully opened. (Gas side, Liquid side) 2. Check outdoor fan operation. 3. Check motor error of outdoor fan. 4. Check clogging of outdoor PMV. 5. Check clogging of heat exchanger in indoor/outdoor units. 6. Short-circuit of suction/discharge air in outdoor unit. 7. Check outdoor P.C. board error. 8. Check fan system error (Cause of air volume drop) at indoor side. 9. Check PMV opening status in indoor unit.
P05	Power supply voltage error	Stop	Displayed when error is detected	1. Check power supply voltage. 50 Hz : AC 198 to 264 V, 60 Hz : AC 198 to 242 V
P20	High pressure protective operation • During cooling operation, outdoor temp. sensor (TL) detected temperature over specified temp. • During heating operation, indoor temp. sensor (TC, TCJ) detected temperature over specified temp.	Stop	Displayed when error is detected	1. Check outdoor heat exchanger sensor (TL). 2. Check indoor heat exchanger sensor (TC, TCJ). 3. Check full open of service valve. 4. Check indoor/outdoor fan. 5. Check PMV (Pulse Motor Valve). 6. Check clogging and short circuit of indoor/outdoor heat exchanger. 7. Overcharge of refrigerant. Recharge
P22	Outdoor fan system error	Stop	Displayed when error is detected	1. Check lock of fan motor. 2. Check power supply voltage. 50 Hz : AC 198 to 264 V, 60 Hz : AC 198 to 242 V 3. Check outdoor P.C. board.
P26	Short-circuit error of compressor driving element	Stop	Displayed when error is detected	1. When performing operation while taking-off compressor wire. If P26 error occurs, check control P.C. board. 2. When performing operation while taking-off compressor wire. If an error does not occurs, compressor is layer short.
P29	Position detection circuit error	Stop	Displayed when error is detected	1. Check control P.C. board.

Error mode detected by remote controller or central controller (TCC-LINK)

Operation of diagnostic function				Judgment and measures
Check code	Cause of errors	Status of air conditioner	Condition	
Not displayed at all (Operation on remote controller cannot be operated.)	No communication with master indoor unit <ul style="list-style-type: none"> Remote controller wiring is not correct. Power of indoor unit is not turned on. Automatic address cannot be completed. 	Stop	—	Power supply error of remote controller, Indoor EEPROM error 1. Check remote controller inter-unit wiring. 2. Check remote controller. 3. Check indoor power wiring. 4. Check indoor P.C. board. 5. Check indoor EEPROM. (including socket insertion) → Automatic address repeating phenomenon generates.
E01 *1	No communication with master indoor unit <ul style="list-style-type: none"> Disconnection of inter-unit wire between remote controller and master indoor unit (Detected by remote controller side) 	Stop (Automatically reset) * If center exists, operation continues.	Displayed when error is detected	Receiving error from remote controller 1. Check remote controller inter-unit wiring. 2. Check remote controller. 3. Check indoor power wiring. 4. Check indoor P.C. board.
E02	Signal send error to indoor unit (Detected by remote controller side)	Stop (Automatically reset) * If center exists, operation continues.	Displayed when error is detected	Error sending of remote controller 1. Check sending circuit inside the remote controller. → Replace remote controller.
E09	There are multiple main remote controllers. (Detected by remote controller side)	Stop (Sub unit continues operation.)	Displayed when error is detected	1. In 2-remote controllers (including wireless), there are multiple main units. Check that there are 1 main remote controller and other sub remote controllers.
L20 ----- Central controller L20	Duplicated indoor central addresses on communication of central control system (Detected by indoor/central controller side)	Stop (Automatically reset)	Displayed when error is detected	1. Check setting of central control system network address. (Network adapter SW01) 2. Check network adapter P.C. board.
— ----- *2 ----- Central controller (Send) C05 (Receive) C06	Communication circuit error of central control system (Detected by central controller side)	Continues (By remote controller)	Displayed when error is detected	1. Check communication wire / miswiring 2. Check communication (U3, U4 terminals) 3. Check network adapter P.C. board. 4. Check central controller (such as central control remote controller, etc.) 5. Check terminal resistance. (TCC-LINK)
----- Central controller P30	Indoor Gr sub unit error (Detected by central controller side)	Continuation/Stop (According to each case)	Displayed when error is detected	Check the check code of the corresponding unit from remote controller.

*1 The check code cannot be displayed by the wired remote controller.
(Usual operation of air conditioner becomes unavailable.)

For the wireless models, an error is notified by indication lamp.

*2 This trouble is related to communication of remote controller (A, B), central system (TCC-LINK U3, U4), and [E01], [E02], [E03], [E09] or [E18] is displayed or no check display on the remote controller according to the contents.

Contents Error Display

- * When the errors were overlapped, the latest error is displayed.
- * When D800 to D804 are slowly flashing or D805 is flashing, push and hold SW01 and SW02 simultaneously for 5 seconds or more. The error display changes to the error which is generated.

TROUBLESHOOTING

You can perform fault diagnosis of the outdoor unit with the LEDs on the Sub P.C.Board of the outdoor unit in addition to using the check codes displayed on the wired remote controller of the indoor unit. Use the LEDs and check codes for various checks. Details of the check codes displayed on the wired remote controller of the indoor unit are described in the Installation Manual of the indoor unit.

LED displays and check codes

No.	Error	Display					
		D800	D801	D802	D803	D804	D805
1	Normal	●	●	●	●	●	○
2	Discharge temperature sensor (TD) error	◎	●	●	●	●	○
3	Heat exchanger temperature sensor (TE) error	●	◎	●	●	●	○
4	Heat exchanger temperature sensor (TL) error	◎	◎	●	●	●	○
5	Outside temperature sensor (TO) error	●	●	◎	●	●	○
6	Suction temperature sensor (TS) error	◎	●	◎	●	●	○
7	Heat sink temperature sensor (TH) error	●	◎	◎	●	●	○
8	Miss-mounting of sensor (TE, TS)	◎	◎	◎	●	●	○
9	EEPROM error	●	◎	●	◎	●	○
10	Compressor breakdown	◎	◎	●	◎	●	○
11	Compressor lock	●	●	◎	◎	●	○
12	Current detection circuit error	◎	●	◎	◎	●	○
13	Case thermostat activated	●	◎	◎	◎	●	○
14	Unset model type	●	●	●	●	◎	○
15	Communication error between MCUs	◎	●	●	●	◎	○
16	Discharge temperature sensor error	●	◎	●	●	◎	○
17	High pressure SW error	◎	◎	●	●	◎	○
18	Power supply voltage error	●	●	◎	●	◎	○
19	Heatsink overheating error	●	◎	◎	●	◎	○
20	Gas leak detected	◎	◎	◎	●	◎	○
21	4-way valve reversal error	●	●	●	◎	◎	○
22	High pressure protective activated	◎	●	●	◎	◎	○
23	Fan system error	●	◎	●	◎	◎	○
24	Compressor driver device short circuit	◎	◎	●	◎	◎	○
25	Position detection circuit error	●	●	◎	◎	◎	○

○ : ON, ● : OFF, ◎ : Rapid flashing (5 times/sec.)

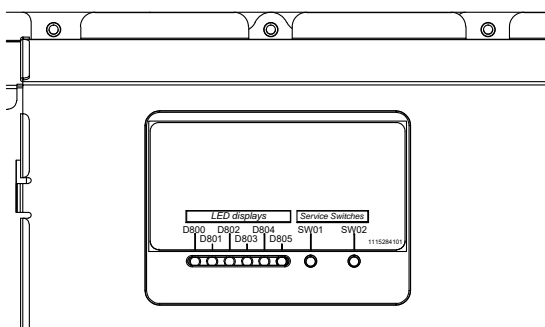

* The LEDs and switches are located at the Sub P.C.Board of the outdoor unit as shown in the figure on the left.

LED displays					
○ D800 (Yellow)	○ D801 (Yellow)	○ D802 (Yellow)	○ D803 (Yellow)	○ D804 (Yellow)	○ D805 (Green)

8-2-5. Diagnostic Procedure for Each Check Code (Outdoor Unit)

- 1) This section describes the diagnostic method for each check code displayed on the wired remote controller.
- 2) In some cases, a check code indicates multiple symptoms.
In this case, confirm LED display on the outdoor P.C. board to narrow the contents to be confirmed.
- 3) The check code on the remote controller is displayed only when the same trouble occurred continuously by multiple times while LED of the outdoor P.C. board displays even a trouble which occurred once.
Therefore the display on the remote controller may differ from that of LED.

How to check LED display on the outdoor P.C. board

[Service switch operation]

Currently occurring trouble indication

Even if only one of D800 to D804 is rapidly flashing then trouble has arisen. If any of D800 to D801 is slowly flashing or D805 is flashing then press and hold down SW01 and SW02 at the same time for at least 5 seconds.

D800 (YEL)	D801 (YEL)	D802 (YEL)	D803 (YEL)	D804 (YEL)	D805 (GRN)	
●	●	●	●	●	○	No trouble
◎	●	●	●	●	○	Trouble detected (Example. Discharge temp. trouble)

● : Go OFF ○ Go ON ◎ Flash (5 times/sec)

Latest trouble indication







- The following operation results in the latest trouble being indicated. It is retained in the memory and hence can be confirmed even when the power supply has been turned off. (Excluding outside air temperature sensor (TO) trouble)
 - 1) Confirm D800 to D804 are off (or rapidly flashing) and that D805 is lit up. If D800 to D804 are slowly flashing or D805 is flashing then push and hold down SW01 and SW02 at the same time for at least 5 seconds.
D800 to D804 will turn off (or be rapidly flashing) and D805 will change to flashing.
 - 2) Push and hold down SW01 for at least 5 seconds. D804 will start slowly flashing.
 - 3) Push SW01 several times until reaching the LED indication (D800 to D804) of 'Latest (including current) trouble indication'.
 - 4) Push SW02. The latest trouble will be indicated.
 - 5) Ensure to carry out step 1) to set the LEDs to the initial state (current occurring trouble) when finished and then exit.

Latest (including current) trouble indication

D800 (YEL)	D801 (YEL)	D802 (YEL)	D803 (YEL)	D804 (YEL)	D805 (GRN)
○	●	●	●	●	◎

● : Go OFF ○ Go ON ◎ Flash (5 times/sec)

Check code	Outdoor LED display	Check and troubleshooting (Item without special mention indicates part of outdoor unit.)
[E04]	—	<p>[Indoor/Outdoor communication trouble]</p> <pre> graph TD Q1{{Is setting of group address of remote controller correct?}} -- NO --> A1[Check check code [14].] Q1 -- YES --> Q2{{Are inner wiring of indoor unit and inter-unit wires (1, 2, 3) correct?}} Q2 -- NO --> A2[Correct wiring and inter-unit wires.] Q2 -- YES --> Q3{{Are connection and wiring of terminal blocks (1, 2, 3) correct?}} Q3 -- NO --> A3[Correct wiring of connectors and terminal blocks.] Q3 -- YES --> A4[Check control P.C. board. Failure → Replace] </pre>

Check code	Outdoor LED display	Check and troubleshooting (Item without special mention indicates part of outdoor unit.)
[F04]		<p>[Discharge temp. sensor (TD) trouble]</p> <pre> graph TD Q1{Is connection of CN603 correct? Is resistance value of TD sensor correct?} -- NO --> A1[Correct connector. Replace TD sensor] Q1 -- YES --> A2[Check outdoor P.C. board. Failure → Replace] </pre>
[F06]		<p>[Heat exchanger temp. sensor (TE) trouble]</p> <pre> graph TD Q2{Is connection of CN601 correct? Is resistance value of TE sensor correct?} -- NO --> A3[Correct connector. Replace TE sensor] Q2 -- YES --> A4[Check outdoor P.C. board. Failure → Replace] </pre>
[F07]		<p>[Heat exchanger temp. sensor (TL) trouble]</p> <pre> graph TD Q3{Is connection of CN604 correct? Is resistance value of TL sensor correct?} -- NO --> A5[Correct connector. Replace TL sensor] Q3 -- YES --> A6[Check outdoor P.C. board. Failure → Replace] </pre>
[F08]		<p>[Outside temp. sensor (TO) trouble]</p> <pre> graph TD Q4{Is connection of CN602 correct? Is resistance value of TO sensor correct?} -- NO --> A7[Correct connector. Replace TO sensor] Q4 -- YES --> A8[Check outdoor P.C. board. Failure → Replace] </pre>
[F12]		<p>[Suction temp. sensor (TS) trouble]</p> <pre> graph TD Q5{Is connection of CN600 correct? Is resistance value of TS sensor correct?} -- NO --> A9[Correct connector. Replace TS sensor] Q5 -- YES --> A10[Check outdoor P.C. board. Failure → Replace] </pre>
[F13]		<p>[Heat sink temp. sensor (TH) trouble]</p> <pre> graph TD A11[Check outdoor P.C. board. Failure → Replace * When replacing outdoor P.C.board, replace the fuse.] </pre>

Check code	Outdoor LED display	Check and troubleshooting (Item without special mention Indicates part of outdoor unit.)
[F15]		<p>[Miswiring of heat exchanger sensor (TE, TS)]</p> <pre> graph TD Q1{{Is mounting status of TE and TS sensors correct?}} -- NO --> A1[Correct sensor mounting.] Q1 -- YES --> Q2{{Is connection of CN600 correct? Is resistance value of TS sensor correct?}} Q2 -- NO --> A2[Correct connector. Replace TS sensor] Q2 -- YES --> Q3{{Is connection of CN601 correct? Is resistance value of TE sensor correct?}} Q3 -- NO --> A3[Correct connector. Replace TE sensor] Q3 -- YES --> A4[Check outdoor P.C. board. Failure → Replace] </pre>
[F31]		<p>[EEPROM trouble]</p> <pre> graph TD A[Check outdoor P.C. board. Failure → Replace] </pre>
[H01]		<p>[Compressor break down]</p> <pre> graph TD Q1{{Is power supply voltage normal? AC198 to 264V}} -- NO --> A1[Correct power supply line.] Q1 -- YES --> Q2{{Is wire connection correct? Compressor lead (P.C. board side, Compressor side), Reactor lead, Power supply lead}} Q2 -- NO --> A2[Check wire connection and correct it.] Q2 -- YES --> Q3{{Does an abnormal overload happen?}} Q3 -- NO --> A3[Remove and improve the cause of overload.] Q3 -- YES --> A4[Check outdoor P.C. board. Failure → Replace. * When replacing outdoor P.C.board, replace the fuse.] </pre>

Check code	Outdoor LED display	Check and troubleshooting (Item without special mention Indicates part of outdoor unit.)
[H02]	●●○○●○	<p>[Compressor lock]</p> <pre> graph TD Q1{{Is power supply voltage normal? AC198 to 264V}} -- NO --> A1[Correct power supply line.] Q1 -- YES --> Q2{{Is wire connection correct? Compressor lead (P.C. board side, Compressor side), Reactor lead, Power supply lead}} Q2 -- NO --> A2[Check wire connection and correct it.] Q2 -- YES --> Q3{{Is compressor under correct conditions?}} Q3 -- YES --> A3[Check outdoor P.C. board. Failure -> Replace * When replacing outdoor P.C.board, replace the fuse.] Q3 -- NO --> Q4{{Is there refrigerant stagnation?}} Q4 -- NO --> A4[Compressor lock -> Replace] Q4 -- YES --> Q5{{Does PMV correctly operate?}} Q5 -- NO --> A5[Check TE, TS sensors and PMV. Failure -> Replace] Q5 -- YES --> A3 </pre>
[H03]	○○●○○●○	<p>[Current detection circuit trouble]</p> <pre> graph TD Q1{{Wiring or connector connection on P.C.board normal?}} -- NO --> A1[Correct connector connection or cabling.] Q1 -- YES --> A2[Check outdoor P.C.board (MCC-1758). Failure -> Replace] </pre>
[H04]	●○○○○●○	<p>[Case thermostat operation]</p> <pre> graph TD Q1{{Are CN609 connection and case thermostat correct?}} -- NO --> A1[Correct connector. Case thermostat trouble -> Replace] Q1 -- YES --> Q2{{When shorting the case thermostat, can you perform the cooling/heating operation?}} Q2 -- NO --> A2[Check outdoor P.C. board. Failure -> Replace * When replacing outdoor P.C.board, replace the fuse.] Q2 -- YES --> Q3{{Is there gas leak? Is there refrigerant shortage?}} Q3 -- YES --> A3[Fault part repair. Recharge refrigerant.] Q3 -- NO --> Q4{{Is service valve fully opened?}} Q4 -- NO --> A4[Open service valve fully.] Q4 -- YES --> Q5{{Is PMV normal?}} Q5 -- NO --> A5[Replace the PMV.] Q5 -- YES --> A6[Check crushed or broken pipe. Fault part repair] </pre>



Check code	Outdoor LED display	Check and troubleshooting (Item without special mention indicates part of outdoor unit.)
[L10]	●●●●○	<p>[Heat sink temp. sensor (TH) trouble]</p> <div style="border: 1px solid black; padding: 5px; margin: 10px 0;"> Cut jumper line according to the explanation sheet packaged with the service P.C. board. </div>
[L29]	○●●●○	<p>[Communication trouble MCUs]</p> <div style="border: 1px solid black; padding: 5px; margin: 10px 0;"> Check outdoor P.C.board Failure → Replace </div>
[P03]	○●●●●	<p>[Discharge temp. trouble]</p> <pre> graph TD Q1{Is there gas leak? Is there refrigerant shortage?} -- NO --> A1[Fault part repair. Recharge refrigerant.] Q1 -- YES --> Q2{Is PMV normal?} Q2 -- NO --> A2[Replace the PMV.] Q2 -- YES --> Q3{Does an abnormal overload happen?} Q3 -- YES --> A3[Remove and improve the cause of overload.] Q3 -- NO --> Q4{Is connection of CN603 correct? Is resistance value of TD sensor correct?} Q4 -- NO --> A4[Replace TD sensor.] Q4 -- YES --> A5[Check outdoor P.C. board. Failure → Replace] </pre>
[P05]	●●○●○	<p>[Powersupply trouble] Voltage failure</p> <pre> graph TD A[Check the same items as [P04] trouble.] --> B{Does the supply voltage drop or rise (AC198 to 264V)?} B -- YES --> C[Confirmation of electrical work etc.] B -- NO --> D[Check outdoor P.C.board Failure → Replace] </pre>

Check code	Outdoor LED display	Check and troubleshooting (Item without special mention indicates part of outdoor unit.)
[P07]	●○○●○○○	<p>[Heat sink overheating trouble]</p> <pre> graph TD Q1{{Is there any looseness in the screw stop of the motor drive element IC201 of the outdoor P.C. board, the sub heat sink, and the diode bridge? Are radiation grease properly applied?}} A1[Apply radiation grease to objective, retightening of screw] Q2{{Does something block the ventilation around the heatsink? Does something block air flow from the fan? (Short circuit etc.)}} A2[Remove blocking matter, Short circuit improvement] A3[Check outdoor P.C. board. Failure -> Replace. * When replacing outdoor P.C.board, replace the fuse.] Q1 -- YES --> A1 Q1 -- NO --> Q2 Q2 -- YES --> A3 Q2 -- NO --> A2 </pre>
[P15]	○○○●○○○	<p>[Gas leak detection]</p> <pre> graph TD Q1{{Is there gas leak? Is there refrigerant shortage?}} A1[Fault part repair. Recharge refrigerant.] Q2{{Is PMV normal?}} A2[Replace the PMV.] Q3{{Is service valve fully opened?}} A3[Open service valve fully.] Q4{{Is there crushed pipe?}} A4[Correct and replace piping.] Q5{{Check temp. sensor. TD sensor CN603 TS sensor CN600}} A5[Correct connector. Sensor trouble -> Replace] A6[Check outdoor P.C. board. Failure -> Replace] Q1 -- YES --> A1 Q1 -- NO --> Q2 Q2 -- YES --> Q3 Q2 -- NO --> A2 Q3 -- YES --> Q4 Q3 -- NO --> A3 Q4 -- YES --> A4 Q4 -- NO --> Q5 Q5 -- Trouble --> A5 Q5 -- OK --> A6 </pre>

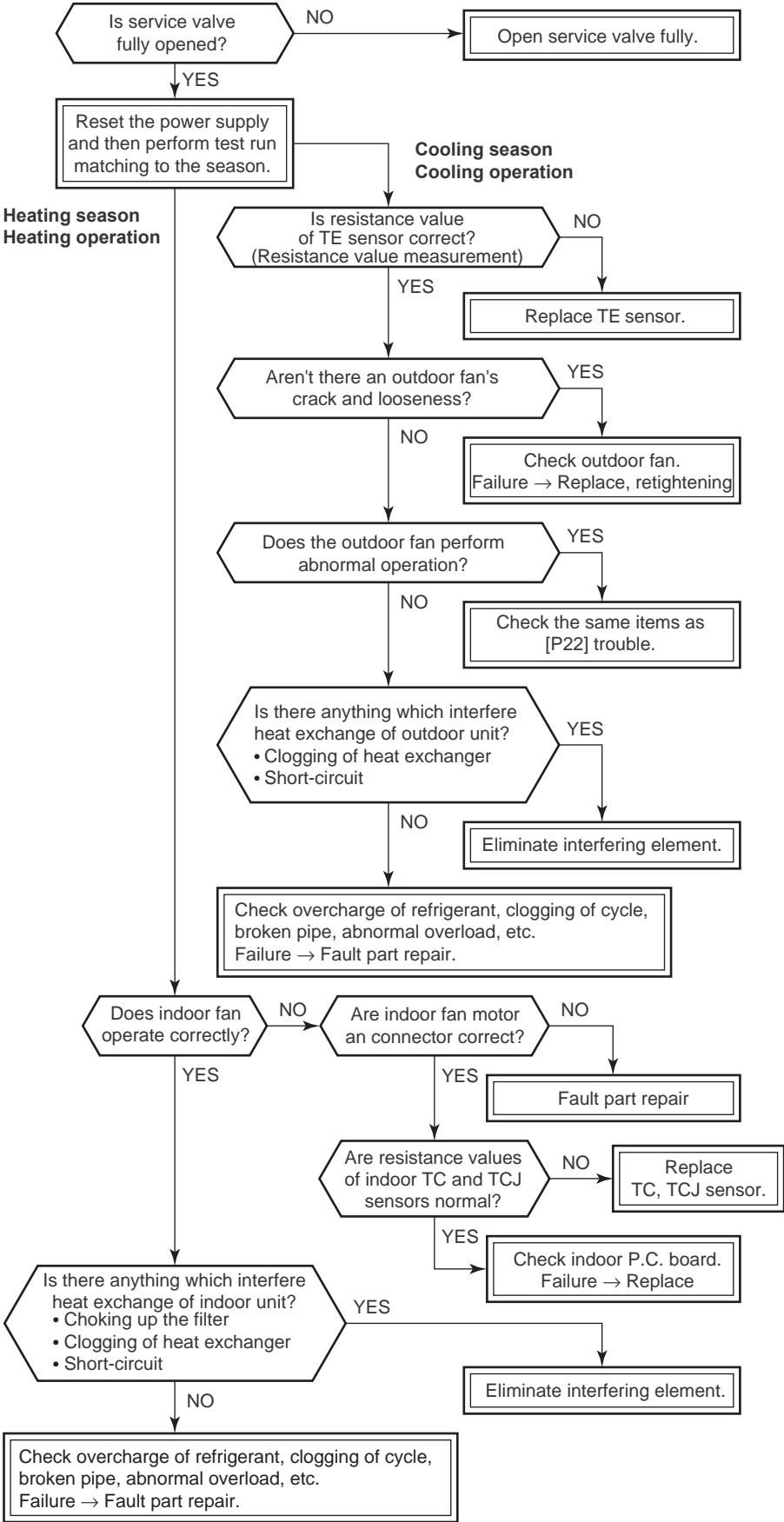
Check code	Outdoor LED display	Check and troubleshooting (Item without special mention indicates part of outdoor unit.)																					
[P19]	●●●◎◎○	<p>[4-way valve inverse trouble]</p> <pre> graph TD Q1{{Does 4-way valve work correctly? (Check pipe temp. etc. in cooling/heating operation.)}} Q2{{Is the coil resistance value of 4-way valve normal?}} Q3{{Temperature sensor normal? TE sensor CN601 TS sensor CN600}} Q4{{Is the flow of the refrigerant by the PMV normal?}} Q5{{Indoor TC, TCJ sensor normal?}} Q6{{The voltage variation due to the confirmation of 4-way valve relay operation, refer to below?}} Q7{{Check outdoor P.C.board}} R1[Replace 4-way valve coil] R2[Replace TE, TS sensor] R3[Check 4-way valve. Defect R Replace] R4[Check PMV and replace] R5[Replace TC, TCJ sensor] R6[Check indoor P.C.board Failure -> Replace] Q1 -- NO --> Q2 Q1 -- YES --> Q3 Q2 -- NO --> R1 Q2 -- YES --> Q6 Q3 -- NO --> R2 Q3 -- YES --> Q4 Q4 -- NO --> R4 Q4 -- YES --> Q5 Q5 -- NO --> R5 Q5 -- YES --> R6 Q6 -- NG --> R3 Q6 -- NO --> Q7 Q7 -- OK --> R6 </pre> <p>[4-way valve relay operation check] Service switches SW01 and SW02 can be used to check the operation of the 4-way valve relay. Use to check whether there are any problems with the 4-way valve or 4-way valve coil.</p> <p>[Method of operation]</p> <ol style="list-style-type: none"> 1) Push ensure that D800 to D804 are off (or rapidly flashing) and that D805 is lit up. If D800 to D804 are slowly flashing or D805 is flashing then push and hold down SW01 and SW02 at the same time for at least 5 seconds. D800 to D804 will turn off (or rapidly flash) and D805 turn on. 2) Push and hold down SW01 for at least 5 seconds. D804 will start slowly flashing. 3) Push SW01 until reaching the below [4-way valve resistance value relay operation] LED indication. <table border="1" data-bbox="521 1526 1430 1705"> <thead> <tr> <th></th> <th>D800</th> <th>D801</th> <th>D802</th> <th>D803</th> <th>D804</th> <th>Remark</th> </tr> </thead> <tbody> <tr> <td>4-way valve resistance Value relay operation</td> <td>○</td> <td>●</td> <td>○</td> <td>○</td> <td>◎</td> <td>Heating on</td> </tr> <tr> <td></td> <td>●</td> <td>○</td> <td>○</td> <td>○</td> <td>◎</td> <td>Cooling on</td> </tr> </tbody> </table> <p>●: Go OFF ○ Go ON Flash (5 times/sec)</p> <ol style="list-style-type: none"> 4) Push SW02 until D805 starts rapidly flashing. 5) Push and hold down SW02 for at least 5 seconds. D804 will start slowly flashing, D805 will turn on, and the 4-way valve resistance value relay operation will turn on. 6) Push and hold down SW01 and SW02 at the same time for at least 5 seconds or wait 2 minutes to return to normal control. 		D800	D801	D802	D803	D804	Remark	4-way valve resistance Value relay operation	○	●	○	○	◎	Heating on		●	○	○	○	◎	Cooling on
	D800	D801	D802	D803	D804	Remark																	
4-way valve resistance Value relay operation	○	●	○	○	◎	Heating on																	
	●	○	○	○	◎	Cooling on																	

Check code	Outdoor LED display	Check and troubleshooting (Item without special mention indicates part of outdoor unit.)
[P20] [P04]		<p>[High pressure protective operation]</p> 

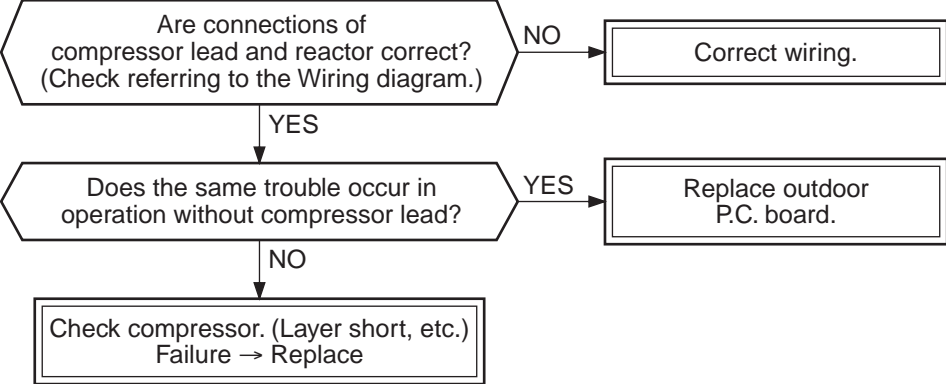
Check code	Outdoor LED display	Check and troubleshooting (Item without special mention indicates part of outdoor unit.)												
[P22]	● ○ ● ○ ○ ○ ○ ○	<p>[Fan system trouble]</p> <pre> graph TD Q1{{Is power supply voltage normal? AC198 to 264V}} -- NO --> A1[Check wiring construction. Ask repair of power supply.] Q1 -- YES --> Q2{{Rotate shaft of the fan motor by hands during power-OFF. Can it rotate smoothly? Is coil resistance of fan motor correct? Between red and white lead wire : 12 to 20Ω Between white and black lead wire : 12 to 20Ω Between black and red lead wire : 12 to 20Ω}} Q2 -- NO --> A2[Replace fan motor.] Q2 -- YES --> Q3{{Is not the fuse (near the terminal block) blows?}} Q3 -- NO --> A3[Replace fuse.] Q3 -- YES --> A4[Check outdoor P.C.board Failure → Replace] </pre> <p>[Confirmation of independent operation of outdoor fan] Service switches SW01 and SW02 can be used to check the operation of the fan motor. Use to check whether there are any problems with the fan motor.</p> <p>[Method of operation]</p> <ol style="list-style-type: none"> ush ensure that D800 to D804 are off (or rapidly flashing) and that D805 is lit up. If D800 to D804 are slowly flashing or D805 is flashing then please push and hold down SW01 and SW02 at the same time for at least 5 seconds. D800 to D804 will turn off (or rapidly flash) and D805 turn on. Push and hold down SW01 for at least 5 seconds. D804 will start slowly flashing. ush SW01 until reaching the below [Confirmation of independent operation of outdoor fan] LED indication. <table border="1" data-bbox="558 1265 1325 1352"> <thead> <tr> <th data-bbox="558 1265 889 1352">Confirmation of independent operation of outdoor fan</th> <th data-bbox="889 1265 979 1352">D800</th> <th data-bbox="979 1265 1068 1352">D801</th> <th data-bbox="1068 1265 1157 1352">D802</th> <th data-bbox="1157 1265 1247 1352">D803</th> <th data-bbox="1247 1265 1325 1352">D804</th> </tr> </thead> <tbody> <tr> <td data-bbox="558 1352 889 1352"></td> <td data-bbox="889 1352 979 1352">○</td> <td data-bbox="979 1352 1068 1352">○</td> <td data-bbox="1068 1352 1157 1352">●</td> <td data-bbox="1157 1352 1247 1352">○</td> <td data-bbox="1247 1352 1325 1352">◎</td> </tr> </tbody> </table> <p>● : Go OFF ○ Go ON ◎ Flash (5 times/sec)</p> <ol style="list-style-type: none"> Push SW02 until D805 starts rapidly flashing. Push and hold down SW02 for at least 5 seconds. D804 will start slowly flashing, D805 will turn on, and the Fan motor operation will turn on. Push and hold down SW01 and SW02 at the same time for at least 5 seconds or wait 2 minutes to return to normal control. 	Confirmation of independent operation of outdoor fan	D800	D801	D802	D803	D804		○	○	●	○	◎
Confirmation of independent operation of outdoor fan	D800	D801	D802	D803	D804									
	○	○	●	○	◎									

Check code	Outdoor LED display	Check and troubleshooting (Item without special mention Indicates part of outdoor unit.)
[P26]		<p>[Short-circuit of compressor drive element]</p>  <pre> graph TD Q1{{Are connections of compressor lead and reactor correct? (Check referring to the Wiring diagram.)}} A1[Correct wiring.] Q2{{Does the same trouble occur in operation without compressor lead?}} A2[Replace outdoor P.C. board.] A3[Check compressor. (Layer short, etc.) Failure -> Replace] Q1 -- NO --> A1 Q1 -- YES --> Q2 Q2 -- YES --> A2 Q2 -- NO --> A3 </pre>
[P29]		<p>[Position detection circuit trouble]</p> <div style="border: 1px solid black; padding: 5px; margin: 10px 0;"> <p>Check outdoor P.C. board. Failure → Replace * When replacing outdoor P.C.board, replace the fuse.</p> </div>
— No code		<p>[Other trouble] --- Compressor step-out from sudden changes in load etc. * outdoor LED indication occurs but it automatically restarts and does not confirm any trouble. * May occur also when the compressor is open phase and wiring disconnected.</p>

8-2-6. Diagnostic Procedure for Each Check Code (Outdoor Unit)

Temperature sensor Temperature – Resistance value characteristic table

TA, TC, TCJ, TE, TS, TO sensors

TD, TL sensors

Representative value

Representative value

Temperature (°C)	Resistance value (kΩ)		
	(Minimum value)	(Standard value)	(Maximum value)
0	32.33	33.80	35.30
10	19.63	20.35	21.09
20	12.23	12.59	12.95
25	9.75	10.00	10.25
30	7.764	7.990	8.218
40	5.013	5.192	5.375
50	3.312	3.451	3.594
60	2.236	2.343	2.454
70	1.540	1.623	1.709
80	1.082	1.146	1.213
90	0.7740	0.8237	0.8761
100	0.5634	0.6023	0.6434

Temperature (°C)	Resistance value (kΩ)		
	(Minimum value)	(Standard value)	(Maximum value)
0	150.5	161.3	172.7
10	92.76	99.05	105.6
20	58.61	62.36	66.26
25	47.01	49.93	52.97
30	37.93	40.22	42.59
40	25.12	26.55	28.03
50	17.00	17.92	18.86
60	11.74	12.34	12.95
70	8.269	8.668	9.074
80	5.925	6.195	6.470
90	4.321	4.507	4.696
100	3.205	3.336	3.468

TA, TC, TCJ, TE, TS, TO sensors

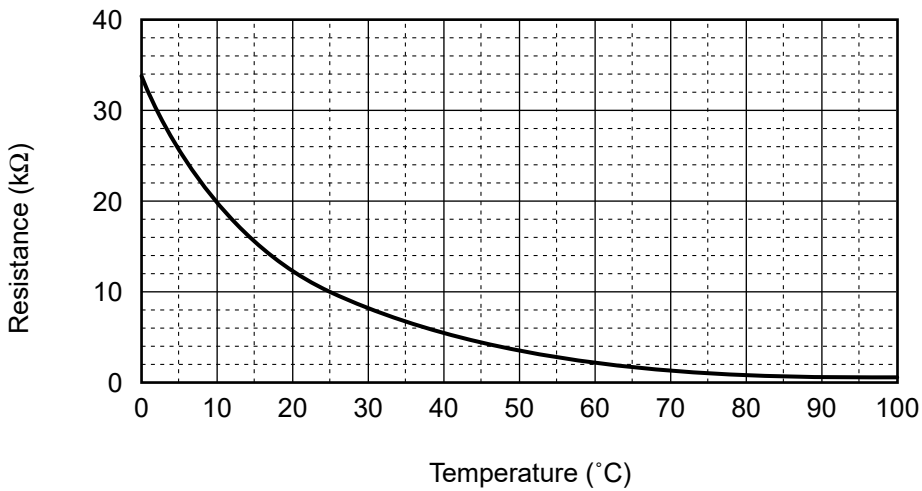

TD, TL sensors

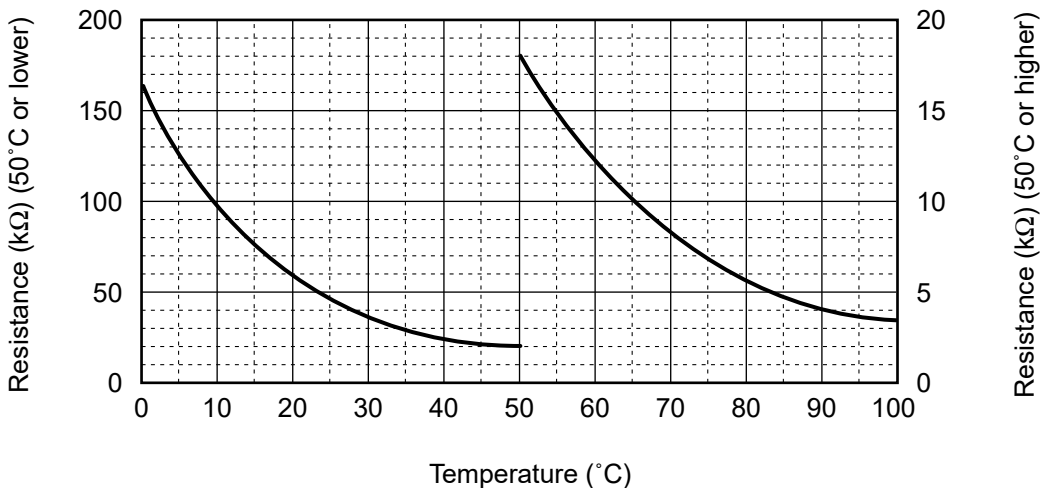

* As TH sensor (Outdoor unit heat sink temp. sensor) is incorporated in the outdoor control P.C. board, the resistance value cannot be measured.

8-3. Table Inspection of outdoor unit main parts

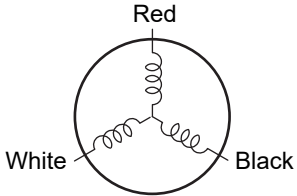
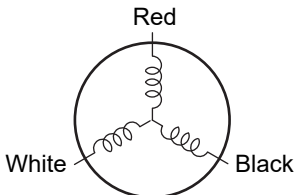
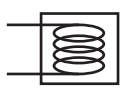
No.	Parts name	Checking procedure						
1	Compressor (Model : DX380A2T-20M)	<p>Measure the resistance value of each winding by using the tester.</p> <div style="display: flex; align-items: center; justify-content: center;">  <table border="1" style="margin-left: 20px;"> <thead> <tr> <th data-bbox="966 332 1208 388">Position</th> <th data-bbox="1208 332 1450 388">Resistance value</th> </tr> </thead> <tbody> <tr> <td data-bbox="966 388 1208 445">Red – White</td> <td data-bbox="1208 388 1450 445" rowspan="3" style="text-align: center; vertical-align: middle;">0.40Ω</td> </tr> <tr> <td data-bbox="966 445 1208 502">White – Black</td> </tr> <tr> <td data-bbox="966 502 1208 560">Black – Red</td> </tr> </tbody> </table> </div> <p style="text-align: right;">Under 20°C</p>	Position	Resistance value	Red – White	0.40Ω	White – Black	Black – Red
Position	Resistance value							
Red – White	0.40Ω							
White – Black								
Black – Red								
2	Outdoor fan motor (Model : ICF-280-A100-1)	<p>Measure the resistance value of each winding by using the tester.</p> <div style="display: flex; align-items: center; justify-content: center;">  <table border="1" style="margin-left: 20px;"> <thead> <tr> <th data-bbox="966 700 1208 755">Position</th> <th data-bbox="1208 700 1450 755">Resistance value</th> </tr> </thead> <tbody> <tr> <td data-bbox="966 755 1208 812">Red – White</td> <td data-bbox="1208 755 1450 812" rowspan="3" style="text-align: center; vertical-align: middle;">14.8±1.5Ω</td> </tr> <tr> <td data-bbox="966 812 1208 870">White – Black</td> </tr> <tr> <td data-bbox="966 870 1208 927">Black – Red</td> </tr> </tbody> </table> </div> <p style="text-align: right;">Under 20°C</p>	Position	Resistance value	Red – White	14.8±1.5Ω	White – Black	Black – Red
Position	Resistance value							
Red – White	14.8±1.5Ω							
White – Black								
Black – Red								
3	4-way valve coil (Cooling/heating switching) (Model : DXQ-1490)	<p>Measure the resistance value of each winding by using the tester.</p> <div style="display: flex; align-items: center; justify-content: center;">  <table border="1" style="margin-left: 20px;"> <thead> <tr> <th data-bbox="966 1067 1450 1125">Resistance value</th> </tr> </thead> <tbody> <tr> <td data-bbox="966 1125 1450 1182" style="text-align: center;">9.1±0.36% Ω</td> </tr> </tbody> </table> </div> <p>Connector : White</p> <p style="text-align: right;">Under 20°C</p>	Resistance value	9.1±0.36% Ω				
Resistance value								
9.1±0.36% Ω								

9. SETUP AT LOCAL SITE AND OTHERS

9-1. Calling of Error History

<Contents>

The error contents in the past can be called.

<Procedure>

- 1** Push **SET** + **TEST** buttons simultaneously for **4 seconds or more to call the service check mode.**
Service Check goes on, the **CODE No.** **01** is displayed, and then the content of the latest alarm is displayed. The number and error contents of the indoor unit in which an error occurred are displayed.
- 2** In order to monitor another error history, push the set temperature **TEMP.** buttons to change the error history No. (CODE No.).
CODE No. **01** (Latest) → **CODE No.** **04** (Old)
NOTE : 4 error histories are stored in memory.
- 3** Pushing **TEST** button returns the display to usual display.

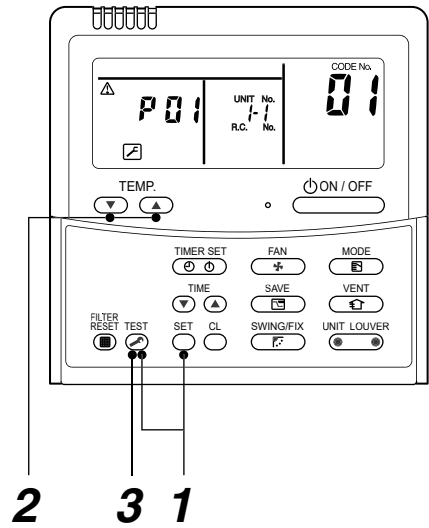

<Operation procedure>

1 → 2 → 3

Returned to usual display

REQUIREMENT

Do not push **CL** button, otherwise all the error histories of the indoor unit are deleted.

9-2. Group Control Operation

In a group control, operation of maximum 8 indoor units can be controlled by a remote controller. The indoor unit connected with outdoor unit (Individual/Master of twin) controls room temperature according to setting on the remote controller.

<System example>

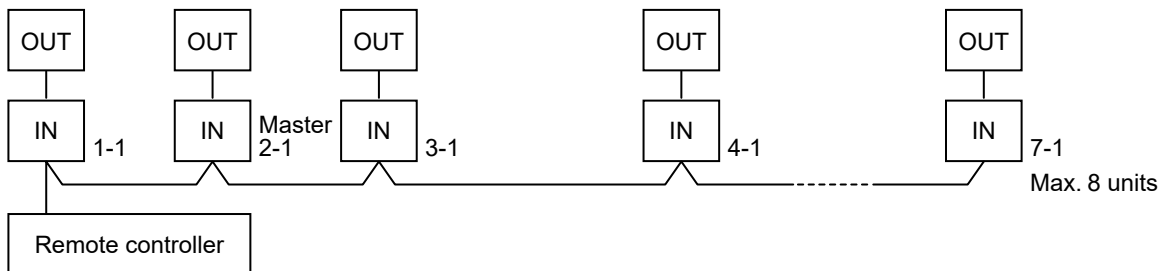

1. Display range on remote controller
The setup range (Operation mode/Air volume select/Setup temp) of the indoor unit which was set to the master unit is reflected on the remote controller.
2. Address setup
Turn on power of the indoor unit to be controlled in a group within 3 minutes after setting of automatic address. If power of the indoor unit is not turned on within 3 minutes (completion of automatic address setting), the system is rebooted and the automatic address setting will be judged again.
 - 1) Connect 3 In/Out cables surely.
 - 2) Check line address/indoor address/group address of the unit one by one.
 - 3) The unit No. (line/indoor gout address) which have been set once keep the present status as a rule if the unit No. is not duplicated with one of another unit.

■ Indoor unit power-ON sequence

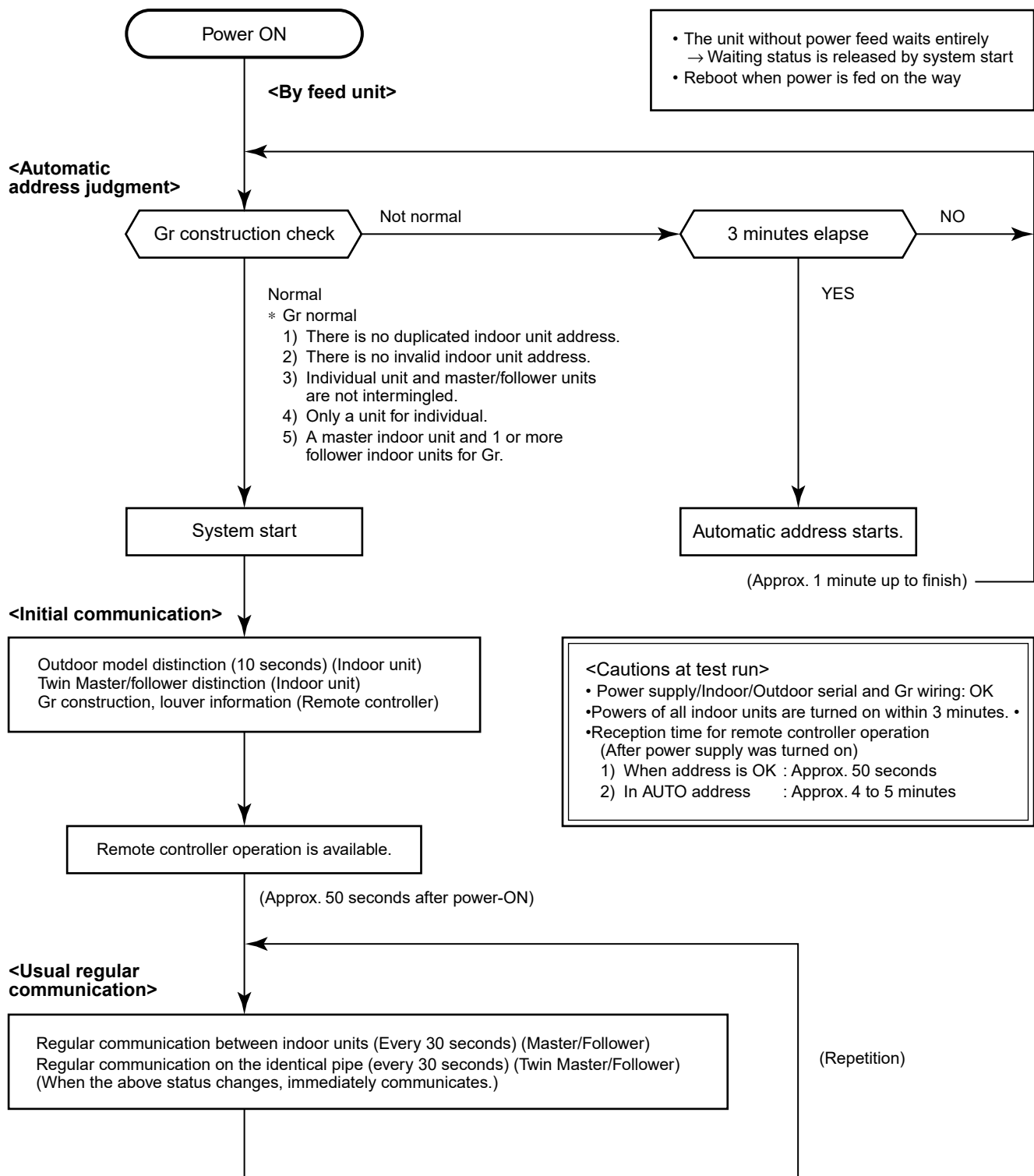

In a group operation, if the indoor unit which was fed power after judgment of automatic address cannot receive regular communication from the master unit and regular communication on identical pipe within 120 seconds after power was turned on, it reboots (system reset).

→ The operation starts from judgment of automatic address (Gr construction check) again.
 (If the address of the master unit was determined in the previous time, the power fed to the master unit and reboot works, the master unit may change though the indoor unit line address is not changed.)

9-3. Outdoor Unit

Various status displays and operations can be accessed using the push buttons (service switches) on the outdoor Control P.C. board and LED display.

Service switch (SW01 and SW02) operation

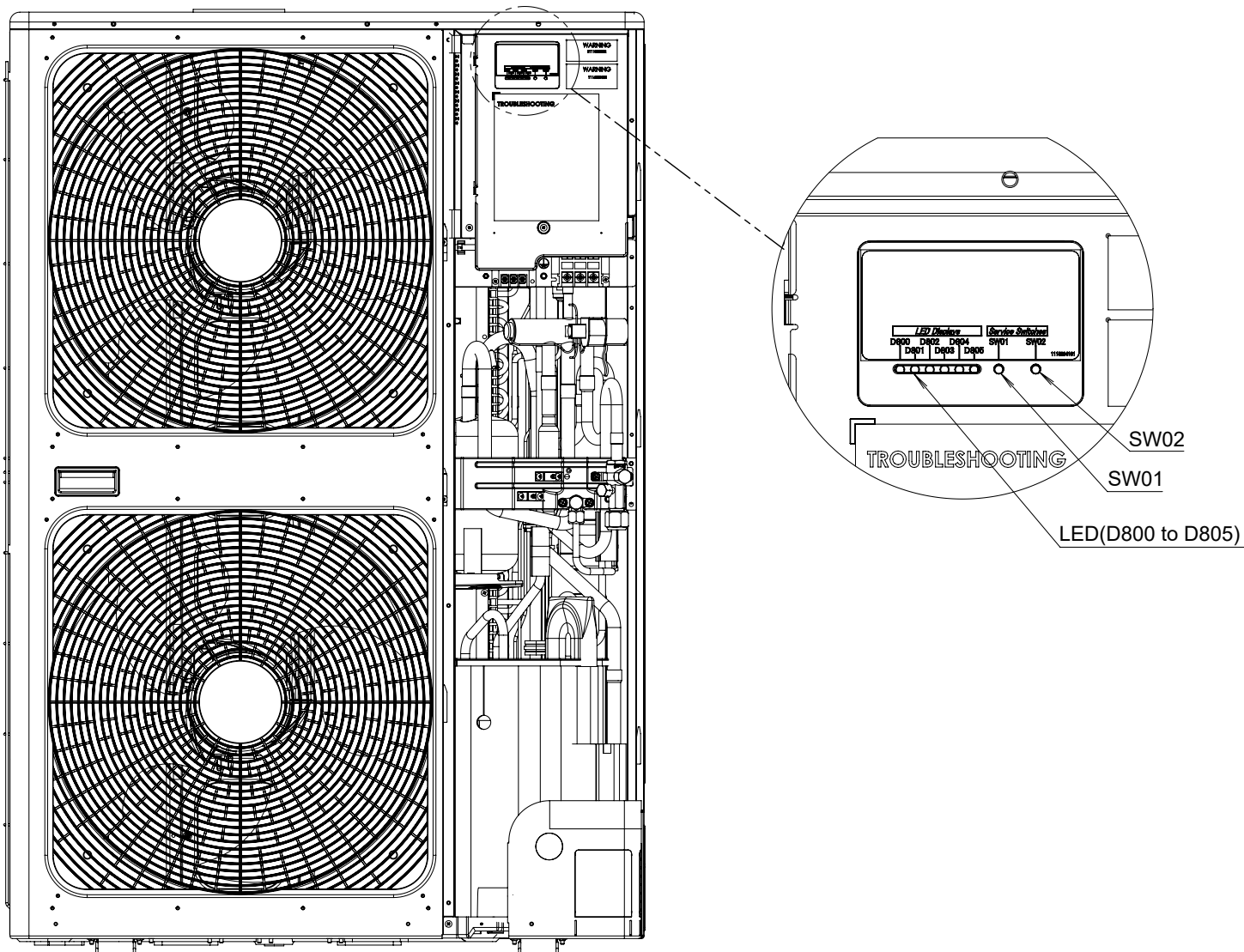

Concerning the LED display

- The LED display has 4 patterns.
○ : Go ON ● : Go OFF ◎
- The initial state of the LED display is as shown on the right with D805 lit up.
If not in the initial state (D805 flashing) then it can be returned to the initial state by pushing and holding down SW01 and SW02 at the same time for 5 seconds.

LED display: Initial state

D800 to D804 : Go Off and flash (5 times/sec)
D805 : Go ON

	D800	D801	D802	D803	D804	D805
LED	○ (Yellow)	○ (Yellow)	○ (Yellow)	○ (Yellow)	○ (Yellow)	○ (Green)

1. Various settings available via the outdoor unit (Existing pipe, Maximum frequency change, Snow guard fan control, Cooling only setup, etc.)

(1) Service switch setting

Various settings can be made using the service switches

[Method of operation]

- 1) Ensure the LED display shows the initial status. If not then ensure to restore the initial status.
- 2) Press SW01 for at least 5 seconds. D804 will start slowly flashing.
- 3) Push SW01 several times until reaching the required LED display function.

Functions	LED display					Control content
Existing pipe setting	D800 ●	D801 ●	D802 ○	D803 ●	D804 ◎	Activate when existing Ø19.1 piping is used. Note that in this case, depending on the outdoor and indoor air temperature, the heating capacity may drop.
Cooling only setting	D800 ○	D801 ○	D802 ●	D803 ●	D804 ◎	Cooling only setting. (Can also be changed using the DN code [0F] on the wired remote control).
Snow guard fan control	D800 ●	D801 ○	D802 ●	D803 ●	D804 ◎	The snow guard fan control enables snow to be diverted from the path of the fan and heat exchanger, thereby protecting the fan motor. And even when the compressor is not in use but the external temperature is less than 7°C ensure the outdoor fan is going using W3.
Maximum frequency change	D800 ●	D801 ●	D802 ●	D803 ○	D804 ◎	Enable this if you wish to lower the maximum compressor frequency. It will lower the maximum frequency during both cooling and heating. Note however it does reduce the maximum capacity. Maximum compressor frequency (rps)

	Cooling	Heating
Standard status	90.0	87.6
When setting is valid	65.4	65.4

○: Go ON ● Go OFF ◎ Flash (5 times/sec)

- 4) Push SW01 until D805 starts rapidly flashing.
 - 5) Press and hold down SW02 for at least 5 seconds. D804 will start slowly flashing and D805 will light up, and the various settings will take effect.
 - 6) To make more settings repeat steps 3) to 5).
 - 7) To invalidate any settings made in steps 1 to 3 press SW01 to turn off D805.
 - 8) Press and hold down SW02 for at least 5 seconds. D804 will start to slowly flash and D805 will turn off and the various settings will be invalidated.
- * If any unclear point arises during an operation then can return to step 1 by pressing and holding down SW01 and SW02 at the same time for at least 5 seconds.

Various settings confirmation method

Whether the various settings are in effect or not can be confirmed.

- 1) Ensure the LED display shows the initial status. If not then ensure to restore the initial status.
- 2) Push SW01 for at least 5 seconds. D804 will start slowly flashing.
- 3) Push SW01 several times until reaching the desired function on the LED display. If the setting is valid D804 and D805 will rapidly flash. (If the setting is invalid then D804 will rapidly flash but D805 will turn off.)
- 4) Push and hold down SW01 and SW02 at the same time for at least 5 seconds to return the LED display to the initial state.

Returning to the factory default settings

The factory default settings can be restored using the following procedure.

- 1) Ensure the LED display shows the initial state. If not then ensure to return it to the initial state.
- 2) Push and hold down SW01 for at least 5 seconds and confirm that D804 is slowly flashing.
- 3) Push SW01 several times until reaching the LED display (D800 to D805) shown on the right or 'Returning to the default factory setting LED display'.
- 4) Push and hold down SW02 for at least 5 seconds and confirm that D804 is slowly flashing.
- 5) Push and hold down SW01 and SW02 at the same time for at least 5 seconds to return to the initial state LED display.

Return to default factory setting LED display					
D800	D801	D802	D803	D804	D805
●	●	●	●	◎	●
○: Go ON ●: Go OFF ◎: Flash (5 times/sec)					

Sub-P.C. board switch and LED arrangement diagram

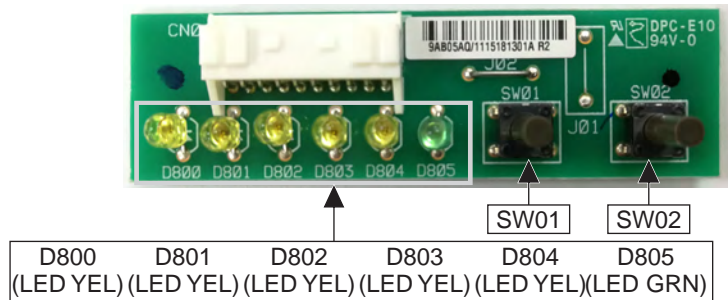

2. Service support functions (LED display and switch operation)

(1) LED display switching (SW01 and SW02 operation)

(1)-1. Display switch list

Service switches SW01 and SW02 can be used to change the display content of LEDs D800 to D805 on the outdoor unit.

[Method of Operation]

- 1) Ensure the LED display shows the initial state. If not then ensure to return it to the initial state.
- 2) Push SW01 several times until reaching the desired display item.

LED display						Control content
D800	D801	D802	D803	D804	D805	Trouble indication (Current trouble) Displays the current trouble. Will not appear if no trouble has occurred. (Refer to (1)-2-1)
●	●	●	●	●	◎	
D800	D801	D802	D803	D804	D805	Trouble indication (Latest trouble: latest and including current trouble) Previous trouble can be checked using this setting, for example, after previous trouble has been resolved (and even after the power has been turned off). * If trouble is currently occurring then the same content will be displayed. * TO sensor trouble only and thus this setting does not display. (Check using the current trouble setting). (Refer to (1)-2-2)
○	●	●	●	●	◎	
D800	D801	D802	D803	D804	D805	Discharge temperature sensor (TD) indication Displays the discharge temperature sensor (TD) value. (Refer to (1)-3)
●	○	●	●	●	◎	
D800	D801	D802	D803	D804	D805	Outdoor heat exchanger temperature sensor (TE) indication Displays the outdoor heat exchanger temperature sensor (TE) value. (Refer to (1)-3)
○	○	●	●	●	◎	
D800	D801	D802	D803	D804	D805	Outdoor heat exchanger temperature sensor (TL) indication Displays the outdoor heat exchanger sensor (TL) value. (Refer to (1)-3)
●	○	○	●	●	◎	
D800	D801	D802	D803	D804	D805	Inlet temperature sensor (TS) indication. Displays the inlet temperature sensor (TS) value. (Refer to (1)-3)
●	●	○	●	●	◎	
D800	D801	D802	D803	D804	D805	Outdoor external temperature sensor (TO) indication. Displays the outdoor external temperature sensor (TO) value. (Refer to (1)-3)
○	●	○	●	●	◎	
D800	D801	D802	D803	D804	D805	Heat sink temperature sensor (TH) indication. Displays the heat sink temperature sensor (TH) value. (Refer to (1)-3)
○	○	○	●	●	◎	
D800	D801	D802	D803	D804	D805	Current indication. Displays the outdoor unit current value. (Refer to (1)-3)
○	●	●	○	●	◎	
D800	D801	D802	D803	D804	D805	Compressor operation frequency indication. Displays the operating frequency of the compressor. (Refer to (1)-3)
●	○	●	○	●	◎	
D800	D801	D802	D803	D804	D805	PMV opening indication. Displays the degree to which the PMV is open. (Refer to (1)-3)
○	○	●	○	●	◎	
D800	D801	D802	D803	D804	D805	Indoor suction temperature sensor (TA) indication. Displays the indoor suction temperature sensor (TA) value. (Refer to (1)-3)
●	●	○	○	●	◎	
D800	D801	D802	D803	D804	D805	Indoor heat exchange temperature sensor (TC) indication. Displays the indoor heat exchange temperature sensor (TC) value. (Refer to (1)-3)
○	●	○	○	●	◎	
D800	D801	D802	D803	D804	D805	Indoor heat exchanger sensor (TCJ) indication. Displays the indoor heat exchanger sensor (TCJ) value. (Refer to (1)-3)
●	○	○	○	●	◎	
D800	D801	D802	D803	D804	D805	Refrigerant leak indication. Displays if a certain amount of refrigerant has leaked. (Refer to (1)-4)
●	●	●	○	●	◎	

○: Go ON ● Go OFF ◎ Flash (5 times/sec)

- 3) Push SW02 to switch to the desired display item.
- 4) To access the other display items repeat steps 1) to 3).
- 5) Before exiting ensure to perform step 1) and set the LED to the initial state (current abnormality indication).

(1)-2. Trouble display

Current and the latest trouble (latest and including the present trouble) can be checked using the lighting status of the LEDs D800 to D805 on the outdoor unit.

(1)-2-1. Current trouble indication

LED indication						Name of trouble	Wired remote control trouble code
D800	D801	D802	D803	D804	D805		
●	●	●	●	●	○	Normal	—
◎	●	●	●	●	○	Discharge temp. sensor (TD) trouble	F04
●	◎	●	●	●	○	Heat exchanger temp. sensor (TE) trouble	F06
◎	◎	●	●	●	○	Heat exchanger temp. sensor (TL) trouble	F07
●	●	◎	●	●	○	Outside temp. sensor (TO) trouble	F08
◎	●	◎	●	●	○	Suction temp. sensor (TS) trouble	F12
●	◎	◎	●	●	○	Heat sink temp. sensor (TH) trouble	F13
◎	◎	◎	●	●	○	Miss-mounting of sensor (TE, TS)	F15
●	◎	●	◎	●	○	EEPROM trouble	F31
◎	◎	●	◎	●	○	Compressor break down	H01
●	●	◎	◎	●	○	Compressor lock	H02
◎	●	◎	◎	●	○	Current detection circuit trouble	H03
●	◎	◎	◎	●	○	Case thermostat operation	H04
●	●	●	●	◎	○	Unset model type	L10
◎	◎	●	●	◎	○	Communication trouble between MCUs	L29
●	◎	●	●	◎	○	Discharge temp. sensor trouble	P03
◎	◎	●	●	◎	○	High pressure SW operation	P04
●	●	◎	●	◎	○	Power supply trouble	P05
●	◎	◎	●	◎	○	Heat sink overheat trouble	P07
◎	◎	◎	●	◎	○	Gas leak detection	P15
●	●	●	◎	◎	○	4-way valve reversal trouble	P19
◎	●	●	◎	◎	○	High pressure protective operation	P20
●	◎	●	◎	◎	○	Fan system trouble	P22
◎	◎	●	◎	◎	○	Short-circuit of compressor drive element	P26
●	●	◎	◎	◎	○	Position detection circuit trouble	P29

○: Go ON ● Go OFF ◎ Flash (5 times/sec)

(1)-2-2. Latest (including current) trouble indication

LED indication						Name of trouble
D800	D801	D802	D803	D804	D805	
●	●	●	●	●	◇	Normal
◎	●	●	●	●	◇	Discharg temp. sensor (TD) trouble
●	◎	●	●	●	◇	Heat exchanger temp. sensor (TE) trouble
◎	◎	●	●	●	◇	Heat exchanger temp. sensor (TL) trouble
●	●	◎	●	●	◇	Outside temp. sensor (TO) trouble
◎	●	◎	●	●	◇	Suction temp. sensor (TS) trouble
●	◎	◎	●	●	◇	Heat sink temp. sensor (TH) trouble
◎	◎	◎	●	●	◇	Miswiring of heat exchanger temp. sensor (TE, TS)
●	◎	●	◎	●	◇	EEPROM trouble
◎	◎	●	◎	●	◇	Compressor break down
●	●	◎	◎	●	◇	Compressor lock
◎	●	◎	◎	●	◇	Current detection circuit trouble
●	◎	◎	◎	●	◇	Case thermostat operation
●	●	●	●	◎	◇	Unset model type
◎	●	●	●	◎	◇	Communication trouble between MCUs
●	◎	●	●	◎	◇	Discharge temp. sensor trouble
◎	◎	●	●	◎	◇	High pressure SW operation
●	●	◎	●	◎	◇	Power supply trouble
●	◎	◎	●	◎	◇	Heat sink overheat trouble
◎	◎	◎	●	◎	◇	Gas leak detection
●	●	●	◎	◎	◇	4-way valve reversal trouble
◎	●	●	◎	◎	◇	High pressure protective operation
●	◎	●	◎	◎	◇	Fan system trouble
◎	◎	●	◎	◎	◇	Short-circuit of compressor drive element
●	●	◎	◎	◎	◇	Position detection circuit trouble

○: Go ON ● Go OFF ◎ Flash (5 times/sec) ◇ flashing (1 time/sec)

(1)-3. Sensor, current, compressor operation frequency, PMV opening indication

Interface (CDB) P.C. board detected values (for example temperature and current sensor values) can be easily checked.

* Temperature sensors ... TD, TE, TL, TS, TO, TH, TA, TC, TCJ

* Current Current sensor (CT) value detected

LED indication						Temperature sensor (°C)	Current (A)	Compressor frequency (rps)	Degree of PMV opening (pls)
D800 (YEL)	D801 (YEL)	D802 (YEL)	D803 (YEL)	D804 (YEL)	D805 (GRN)				
●	●	●	●	●	◇	Less than -25	0 ~	0 ~	0 ~ 19
○	●	●	●	●	◇	-25 ~	1 ~	5 ~	20 ~ 39
●	○	●	●	●	◇	-20 ~	2 ~	10 ~	40 ~ 59
○	○	●	●	●	◇	-15 ~	3 ~	15 ~	60 ~ 79
●	●	○	●	●	◇	-10 ~	4 ~	20 ~	80 ~ 99
○	●	○	●	●	◇	-5 ~	5 ~	25 ~	100 ~ 119
●	○	○	●	●	◇	0 ~	6 ~	30 ~	120 ~ 139
○	○	○	●	●	◇	5 ~	7 ~	35 ~	140 ~ 159
●	●	●	○	●	◇	10 ~	8 ~	40 ~	160 ~ 179
○	●	●	○	●	◇	15 ~	9 ~	45 ~	180 ~ 199
●	○	●	○	●	◇	20 ~	10 ~	50 ~	200 ~ 219
○	○	●	○	●	◇	25 ~	11 ~	55 ~	220 ~ 239
●	●	○	○	●	◇	30 ~	12 ~	60 ~	240 ~ 259
○	●	○	○	●	◇	35 ~	13 ~	65 ~	260 ~ 279
●	○	○	○	●	◇	40 ~	14 ~	70 ~	280 ~ 299
○	○	○	○	●	◇	45 ~	15 ~	75 ~	300 ~ 319
●	●	●	●	○	◇	50 ~	16 ~	80 ~	320 ~ 339
○	●	●	●	○	◇	55 ~	17 ~	85 ~	340 ~ 359
●	○	●	●	○	◇	60 ~	18 ~	90 ~	360 ~ 379
○	○	●	●	○	◇	65 ~	19 ~	95 ~	380 ~ 399
●	●	○	●	○	◇	70 ~	20 ~	100 ~	400 ~ 419
○	●	○	●	○	◇	75 ~	21 ~	105 ~	420 ~ 439
●	○	○	●	○	◇	80 ~	22 ~	110 ~	440 ~ 459
○	○	○	●	○	◇	85 ~	23 ~	115 ~	460 ~ 479
●	●	●	○	○	◇	90 ~	24 ~	120 ~	480 ~ 499
○	●	●	○	○	◇	95 ~	25 ~	125 ~	500
●	○	●	○	○	◇	100 ~	26 ~	130 ~	—
○	○	●	○	○	◇	105 ~	27 ~	135 ~	—
●	●	○	○	○	◇	110 ~	28 ~	140 ~	—
○	●	○	○	○	◇	115 ~	29 ~	145 ~	—
●	○	○	○	○	◇	120 ~	30 ~	150 ~	—
○	○	○	○	○	◇	Sensor trouble	31 or more	155 or more	—

○: Go ON ● Go OFF ◇ flashing (1 time/sec)

(1)-4. Refrigerant leak detection function

Monitors the amount of refrigerant being circulated based on the temperature sensors, compressor rotation speed, PMV opening during operation, and detects any refrigerant leaks during operation and indicates it using the LEDs on the outdoor unit.

CAUTION

- * Detects any slow leaks at the stages of not cool not heat and trouble stoppages' during operation but may not detect fast leaks sometimes.
- * Refrigerant leaks may even be detected because of refrigerant circulation failures due to PMV (Pulse Motor Valve) blockages, operation failures, capillary blockages, strainer blockages, etc.
- * Refrigerant leak detection may not be possible depending on the external air temperature conditions during operation.

If any refrigerant leaks are detected ensure to identify where the leak is, recover the remaining refrigerant, and then recharge with the correct amount using the appropriate methods.

[Confirmation method]

- 1) Ensure the LED display shows the initial state. If not then it can be returned to the initial state by pushing and holding down SW01 and SW02 at the same time for at least 5 seconds.
- 2) Push SW01 several times until reaching the 'refrigerant leak indication' LED display.

D800	D801	D802	D803	D804	D805	Refrigerant leak indication
●	●	●	○	●	◎	Displays if a certain amount of refrigerant has leaked.

○: Go ON ● Go OFF ◎ Flash (5 times/sec)

- 3) Briefly pushing SW02 enables the presence of a leak to be detected using the LED display.

D800	D801	D802	D803	D804	D805	Judgment
●	●	●	●	●	◇	No refrigeration leak detected
○	●	●	●	●	◇	Refrigeration leak detected

○: Go ON ● Go OFF ◇ Flash (1 time/sec)

- 4) Before exiting, push and hold down SW01 and SW02 at the same time for at least 5 seconds and set the LED to the initial state.

(2) Maintenance inspections Special operations (SW01 and SW02 operations)

The following special maintenance and inspection operations can be carried out using the service switches SW01 and SW02.

[Method of operation]

- 1) Ensure the LED display shows the initial state. If not then please ensure to return it to the initial state.
- 2) Push and hold down SW01 for at least 5 seconds. D804 will start slowly flashing.
- 3) Push SW01 until reaching the LED display function you wish to set.

Special operations	LED display	Control content															
Refrigerant recovery operation	<table border="1"> <tr> <td>D800</td><td>D801</td><td>D802</td><td>D803</td><td>D804</td> </tr> <tr> <td>○</td><td>●</td><td>●</td><td>●</td><td>◎</td> </tr> </table>	D800	D801	D802	D803	D804	○	●	●	●	◎	The outdoor unit performs cooling operations. Indoor units do not operate with just this operation and hence do any fan only operations in advance. (Refer to 1.)					
D800	D801	D802	D803	D804													
○	●	●	●	◎													
PMV fully open operation	<table border="1"> <tr> <td>D800</td><td>D801</td><td>D802</td><td>D803</td><td>D804</td> </tr> <tr> <td>○</td><td>●</td><td>○</td><td>●</td><td>◎</td> </tr> </table>	D800	D801	D802	D803	D804	○	●	○	●	◎	PMV (Puls Motor Valve) fully opens. Perform step 6) below or returns to normal control after 2 minutes. (⇒ Note 1)					
D800	D801	D802	D803	D804													
○	●	○	●	◎													
PMV fully closed operation	<table border="1"> <tr> <td>D800</td><td>D801</td><td>D802</td><td>D803</td><td>D804</td> </tr> <tr> <td>●</td><td>○</td><td>○</td><td>●</td><td>◎</td> </tr> </table>	D800	D801	D802	D803	D804	●	○	○	●	◎	PMV (Puls Motor Valve) fully closed. Perform step 6) below or returns to normal control after 2 minutes. (⇒ Note 1)					
D800	D801	D802	D803	D804													
●	○	○	●	◎													
PMV intermediate open operation	<table border="1"> <tr> <td>D800</td><td>D801</td><td>D802</td><td>D803</td><td>D804</td> </tr> <tr> <td>○</td><td>○</td><td>○</td><td>●</td><td>◎</td> </tr> </table>	D800	D801	D802	D803	D804	○	○	○	●	◎	Sets the PMV (Puls Motor Valve) to intermediate open (500 pulses). Perform step 6) below or returns to normal control after 2 minutes. (⇒ Note 1)					
D800	D801	D802	D803	D804													
○	○	○	●	◎													
Indoor heating test command	<table border="1"> <tr> <td>D800</td><td>D801</td><td>D802</td><td>D803</td><td>D804</td> </tr> <tr> <td>○</td><td>●</td><td>●</td><td>○</td><td>◎</td> </tr> </table>	D800	D801	D802	D803	D804	○	●	●	○	◎	Performs a heating test run. Carrying out step 6) below returns to normal control. (⇒ Note 2)					
D800	D801	D802	D803	D804													
○	●	●	○	◎													
Indoor cooling test run command	<table border="1"> <tr> <td>D800</td><td>D801</td><td>D802</td><td>D803</td><td>D804</td> </tr> <tr> <td>●</td><td>○</td><td>●</td><td>○</td><td>◎</td> </tr> </table>	D800	D801	D802	D803	D804	●	○	●	○	◎	Performs a cooling test run. Carrying out step 6) below returns to normal control. (⇒ Note 2)					
D800	D801	D802	D803	D804													
●	○	●	○	◎													
Forced fan motor operation	<table border="1"> <tr> <td>D800</td><td>D801</td><td>D802</td><td>D803</td><td>D804</td> </tr> <tr> <td>○</td><td>○</td><td>●</td><td>○</td><td>◎</td> </tr> </table>	D800	D801	D802	D803	D804	○	○	●	○	◎	Forcibly operates the fan motor. Perform step 6) below or returns to normal control after 2 minutes. (⇒ Note 1)					
D800	D801	D802	D803	D804													
○	○	●	○	◎													
4 way valve relay operation	<table border="1"> <tr> <td>D800</td><td>D801</td><td>D802</td><td>D803</td><td>D804</td> </tr> <tr> <td>○</td><td>●</td><td>○</td><td>○</td><td>◎</td> </tr> <tr> <td>●</td><td>○</td><td>○</td><td>○</td><td>◎</td> </tr> </table>	D800	D801	D802	D803	D804	○	●	○	○	◎	●	○	○	○	◎	Turns on the 4 way valve relay. Perform step 6) below or returns to normal control after 2 minutes. (⇒ Note 1)
D800	D801	D802	D803	D804													
○	●	○	○	◎													
●	○	○	○	◎													

○ : Go ON ● Go OFF ◎ Flash (5 times/sec)

Note 1 : The operations can take place while the equipment is on but it is better if it has been turned off first. A sudden change in pressure could occur while the operations are taking place, which can be dangerous.

Note 2 : Trial indoor cooling operation request/trial indoor heating operation request

Cooling/Heating test operations can only take place from the outdoor unit when combined with the following indoor units. ensure to utilize the outdoor unit.
 Test runs supported : 5 series or later indoor units
 Not supported : Indoor units other than above. In addition, any when twin connections include any other indoor units than above.

Caution) Forced test operations using this setting cannot be cancelled using the indoor remote control. Refer to (6) below.

- 4) Push SW02 until D805 starts rapidly flashing.
 - 5) Push and hold down SW02 for at least 5 seconds. D804 will start slowly flashing and D805 will turn on and the special operation will take effect.
 - 6) To invalidate any of the various settings push and hold down SW01 and SW02 at the same time for at least 5 seconds. D800 to D804 will be off (or rapidly flashing) and D805 lit up (initial state: current trouble indication) and the special operation will have been disabled (normal control).
- * If any uncertainty arises then push and hold down SW01 and SW02 at the same time for at least 5 seconds. You will return to step 1).

3. Outdoor application operati

Optional connector kit (TCB-PCOS1E2)

(1) Peak-cut control

- Saves the power of the outdoor unit by the external peak-cut signal to suppress temporary peak power dissipation.
- The power saving can be switched to three levels: 75%, 50%, and operation stop.

(2) Night operation

- Reduces the capacity of the air conditioner by the input signal from a commercially available timer (procured locally) regardless of the outside air temperature or load to reduce operating noise.

(3) Compressor output

- Turns on the no-voltage contact output while the compressor is operating.

10. ADDRESS SETUP

10-1. Address Setup Procedure

When an outdoor unit and an indoor unit are connected, or when an outdoor unit is connected to each indoor unit respectively in the group operation even if multiple refrigerant lines are provided, the automatic address setup completes with power-ON of the outdoor unit. The operation of the remote controller is not accepted while automatic address works. (Approx. 4 to 5 minutes)

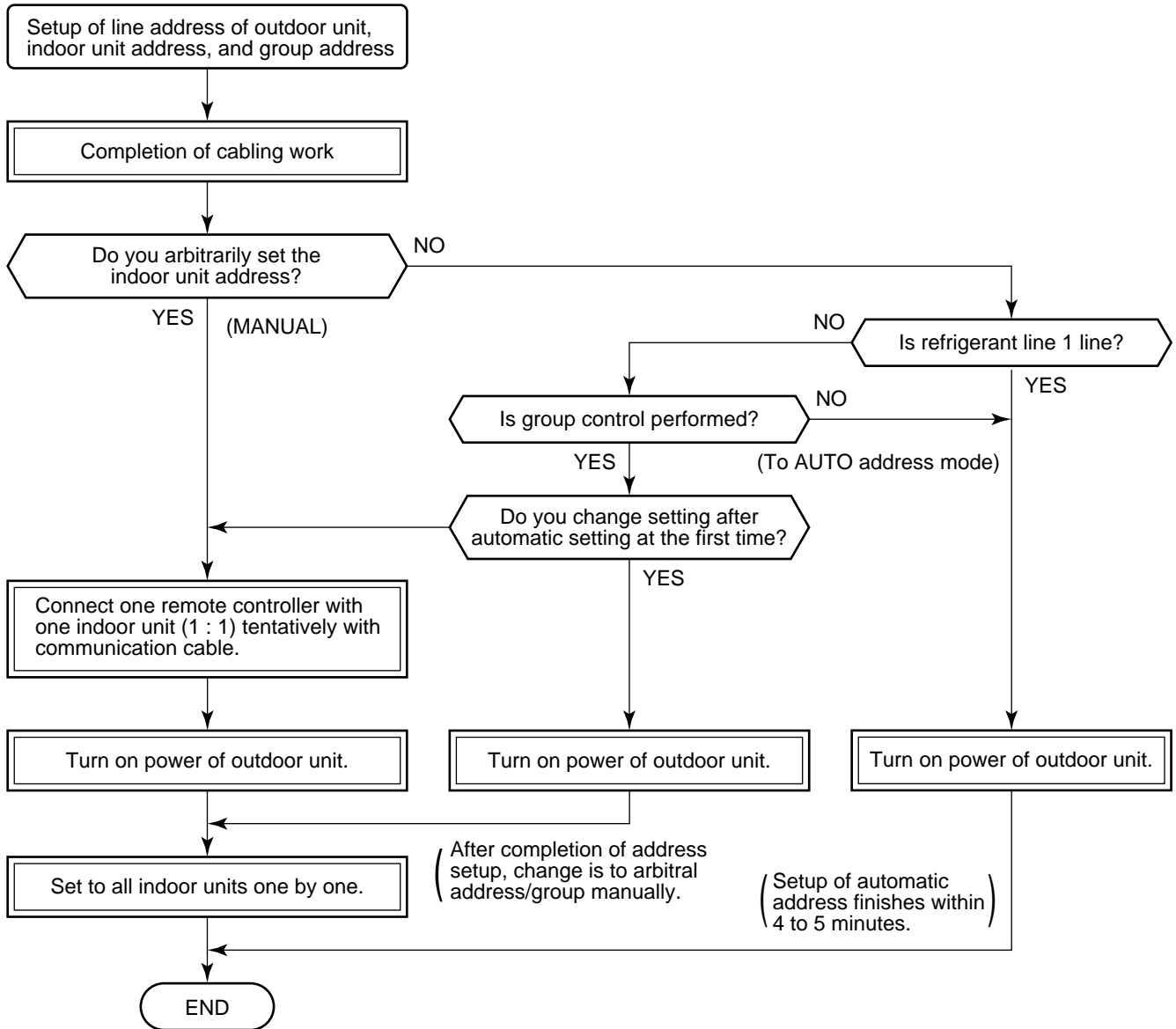

- When the following addresses are not stored in the neutral memory (IC503) on the indoor P.C. board, a test run operation cannot be performed. (Unfixed data at shipment from factory)

	Item code	Data at shipment	Setup data range
Line address	12	0099	0001 (No. 1 unit) to 0064 (No. 64 unit)
Indoor unit address	13	0099	0001 (No. 1 unit) to 0064 (No. 64 unit) Max. value of indoor units in the identical refrigerant line
Group address	14	0099	0000 : Individual (Indoor units which are not controlled in a group) 0001 : Master unit (1 indoor unit in group control) 0002 : Sub unit (Indoor units other than master unit in group control)

10-2. Address Setup & Group Control

<Terminology>

Indoor unit No. : N - n = Outdoor unit line address N (Max. 30) - Indoor unit address n (Max. 64)

Group address : 0 = Single (Not group control)
 1 = Master unit in group control
 2 = Sub unit in group control

Master unit (= 1) : The representative of multiple indoor units in group operation sends/receives signals to/from the remote controllers and sub indoor units.
 (* It has no relation with an indoor unit which communicates serially with the outdoor units.)
 The operation mode and setup temperature range are displayed on the remote controller LCD. (Except air direction adjustment of louver)

Sub unit (= 2) : Indoor units other than master unit in group operation
 Basically, sub units do not send/receive signals to/from the remote controllers.
 (Except errors and response to demand of service data)

Header unit (Representative unit) (Master Twin)

: This unit communicates with the indoor unit (follower) which serial-communicates with the outdoor units and sends/receives signal (Command from compressor) to/from the outdoor units as the representative of the cycle control in the indoor units of the identical line address within the minimum unit which configures one of the refrigerating cycles of Twin.

Follower unit (Subordinate unit) (Sub Twin)

: Indoor units excluding the header unit in Twin

This unit communicates with (Header) indoor unit in the identical line address and performs control synchronized with (Header) indoor unit.

This unit does not perform the signal send/receive operation with the outdoor units. :
 No judgment for serial signal error.

10-2-1. System Configuration

1. Single

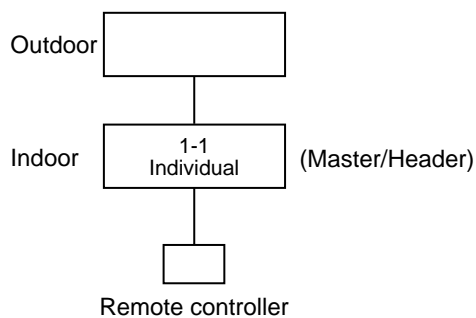

2. Twin

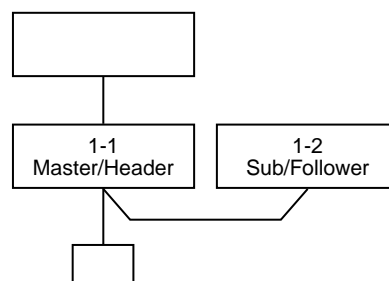

3. Triple

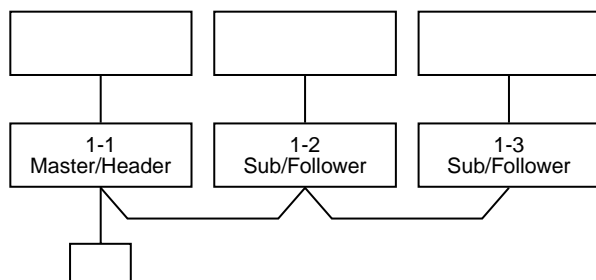

4. Single group operation

- Each indoor unit controls the outdoor unit individually.

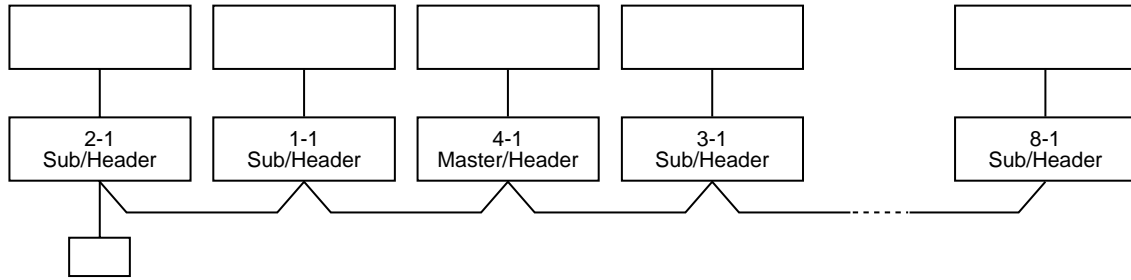

5. Multiple groups operation (Manual address setting)

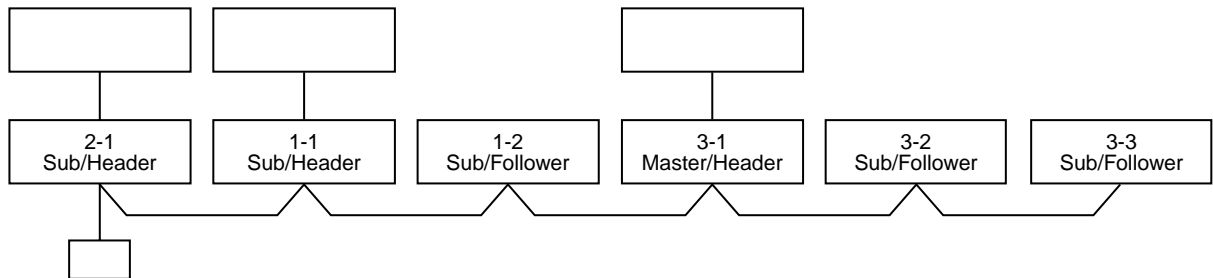

- Header unit: The header unit receives the indoor unit data (thermo status) of the follower (Without identical line address & indoor/outdoor serial) and then finally controls the outdoor compressor matching with its own thermo status. The header unit sends this command information to the follower unit.
- Follower unit: The follower unit receives the indoor unit data from the header (With identical line address & indoor/outdoor serial) and then performs the thermo operation synchronized with the header unit. The follower unit sends own thermo ON/OFF demand to the header unit.

(Example)

No. 1-1 header unit sends/receives signal to/from No. 1-2 and No. 1-3 follower units. (It is not influenced by the line 2 or 3 address indoor unit.)

10-2-2. Automatic Address Example from Unset Address (No miswiring)

1. Standard (One outdoor unit)

1) Single

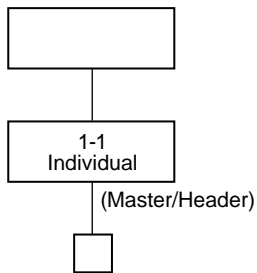

2) Twin

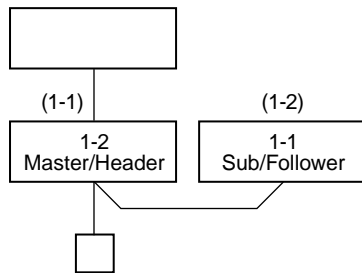

3) Triple

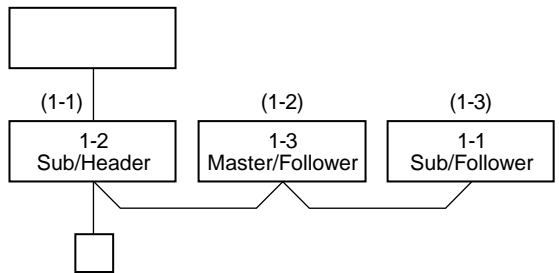

Only turning on source power supply (Automatic completion)

2. Group operation

(Multiple outdoor units = Multiple indoor units with serial communication only, without twin)

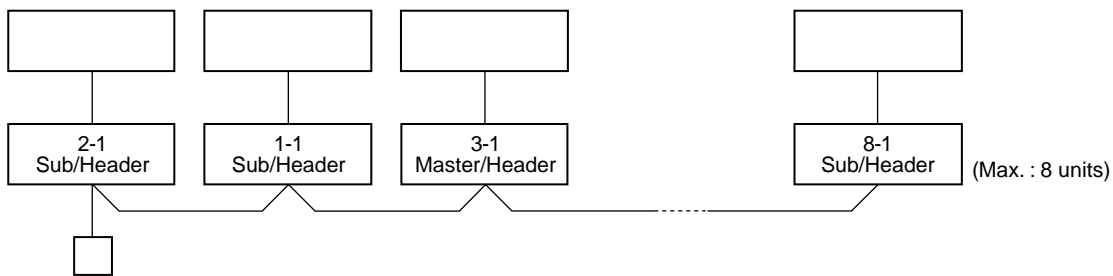

Only turning on source power supply (Automatic completion)

3. Multiple groups operation

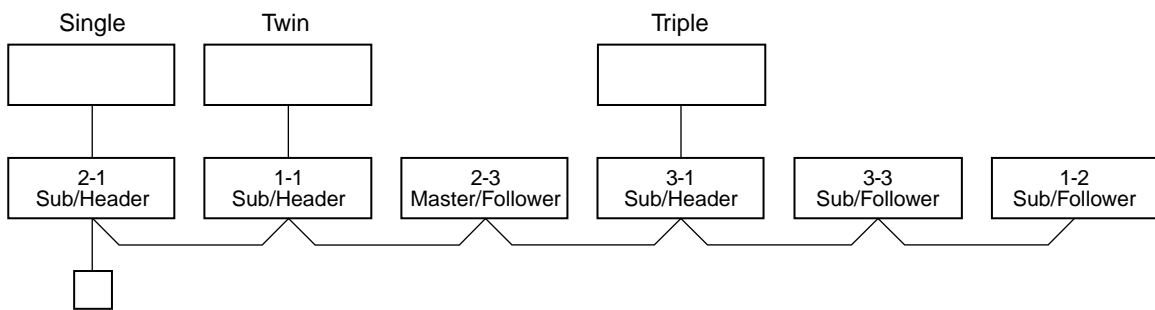

Change is necessary
Manually change addresses of the multiple follower units
simultaneously from the remote controller.

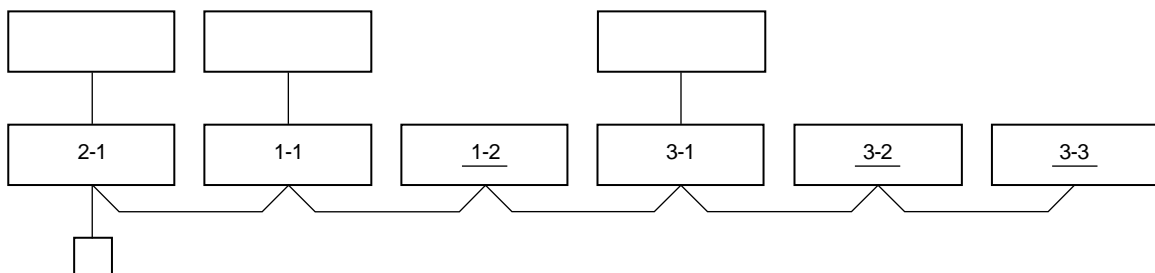

10-3. Remote Controller Wiring

- Strip off approx. 9 mm the wire to be connected.
- For single system, use non polarity, 2 core wire is used for wiring of the remote controller. (0.5 mm² to 2.0 mm² wires)
- For the synchronous twin, triple system, use 2-core shield wire (Vinyl cord for microphone 0.5 to 2.0 mm²) to conform to the EMC standard.

Wiring diagram

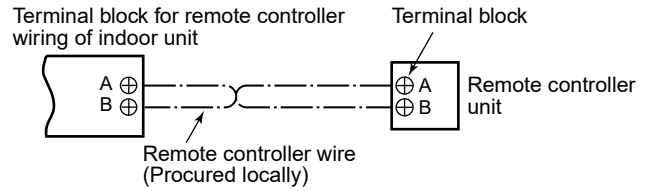

* For details of wiring/installation of the remote controller, refer to the Installation Manual enclosed with the remote controller.

Single system

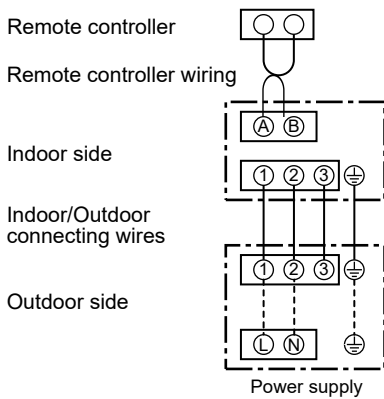

Simultaneous twin system

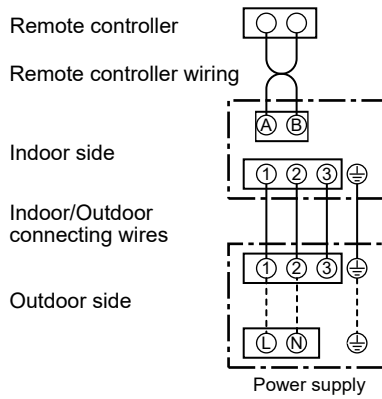

10-4. Address Setup (Manual setting from remote controller)

In case that addresses of the indoor units will be determined prior to piping work after cabling work

- Set an indoor unit per a remote controller.
- Turn on power supply.

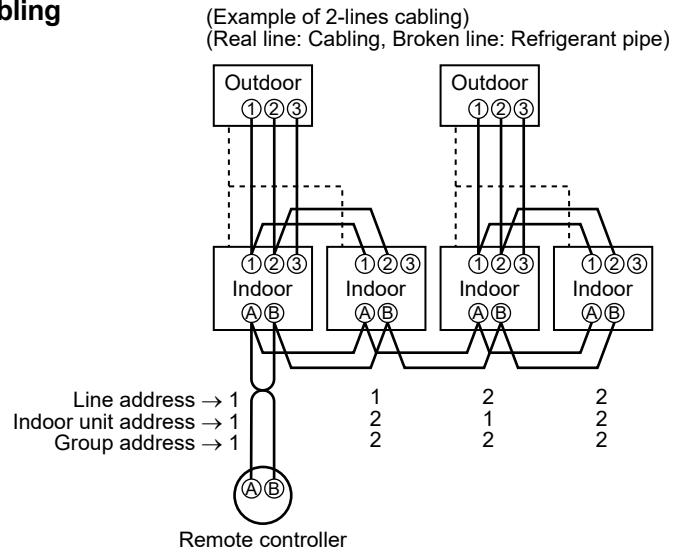

For the above example, perform setting by connecting singly the wired remote controller without remote controller inter-unit cable.

Group address
 Individual : 0000
 Master unit : 0001
 Sub unit : 0002 } In case of group control

- 1** Push **SET** + **CL** + **TEST** buttons simultaneously for 4 seconds or more.
- 2** (← Line address)
Using the temperature setup **▼** / **▲** buttons, set **12** to the CODE No.
- 3** Using timer time **▼** / **▲** buttons, set the line address.
- 4** Push **SET** button. (OK when display goes on.)
- 5** (← Indoor unit address)
Using the temperature setup **▼** / **▲** buttons, set **13** to the CODE No.
- 6** Using timer time **▼** / **▲** buttons, set **1** to the line address.
- 7** Push **SET** button. (OK when display goes on.)
- 8** (← Group address)
Using the temperature setup **▼** / **▲** buttons, set **14** to the CODE No.
- 9** Using timer time **▼** / **▲** buttons, set **0000** to Individual, **0001** to Master unit, and **0002** to sub unit.
- 10** Push **SET** button. (OK when display goes on.)
- 11** Push **TEST** button.
Setup completes. (The status returns to the usual stop status.)

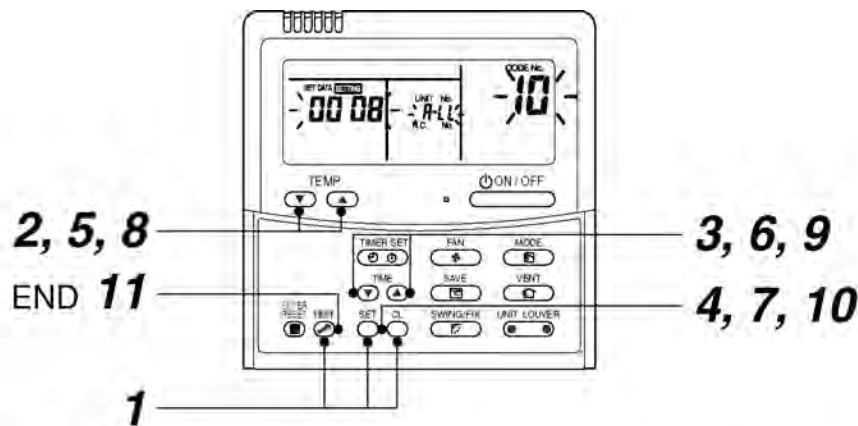

<Operation procedure>

1 → 2 → 3 → 4 → 5 → 6 → 7 → 8 → 9 → 10 → 11 END

10-5. Confirmation of Indoor Unit No. Position

1. To know the indoor unit addresses though position of the indoor unit body is recognized

- In case of individual operation (Wired remote controller : indoor unit = 1 : 1)
(Follow to the procedure during operation)

<Procedure>

- 1** Push **ON/OFF** button if the unit stops.
- 2** Push **UNIT LOUVER** button.

Unit No. **1-1** is displayed on LCD.

(It disappears after several seconds.)

The displayed unit No. indicate line address and indoor unit address.

(When other indoor units are connected to the identical remote controller (Group control unit), other unit numbers are also displayed every pushing **UNIT LOUVER** button.

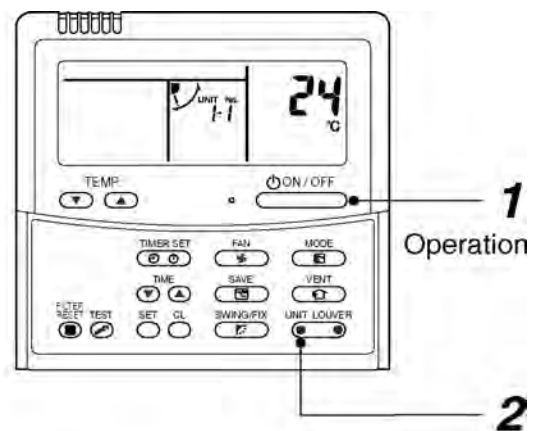

<Operation procedure>

1 → 2 END

2. To know the position of indoor unit body by address

- To confirm the unit No. in the group control
(Follow to the procedure during operation) (in this procedure, the indoor units in group control stop.)

<Procedure>

The indoor unit numbers in the group control are successively displayed, and fan, louver, and drain pump of the corresponding indoor unit are turned on.
(Follow to the procedure during operation)

- 1** Push **VENT** and **TEST** buttons simultaneously for 4 seconds or more.
 - Unit No. **ALL** is displayed.
 - Fans and louvers of all the indoor units in the group control operate.
- 2** Every pushing **UNIT LOUVER** button, the unit numbers in the group control are successively displayed.
 - The unit No. displayed at the first time indicates the master unit address.
 - Fan and louver of the selected indoor unit only operate.
- 3** Push **TEST** button to finish the procedure.
All the indoor units in the group control stop.

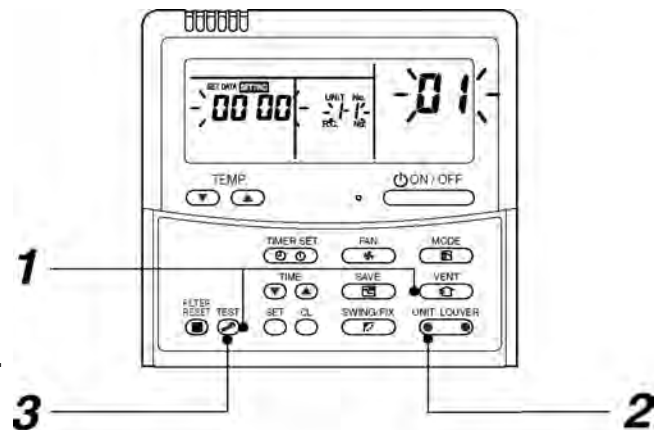

<Operation procedure>

1 → 2 → 3 END

<Maintenance/Check list>

Aiming in environmental preservation, it is strictly recommended to clean and maintain the indoor/outdoor units of the operating air conditioning system regularly to secure effective operation of the air conditioner.

It is also recommended to maintain the units once a year regularly when operating the air conditioner for a long time.

Check periodically signs of rust or scratches, etc. on coating of the outdoor units.

Repair the defective position or apply the rust resisting paint if necessary.

If an indoor unit operates for approx. 8 hours or more per day, usually it is necessary to clean the indoor/outdoor units once three months at least.

These cleaning and maintenance should be carried out by a qualified dealer.

Although the customer has to pay the charge for the maintenance, the life of the unit can be prolonged.

Failure to clean the indoor/outdoor units regularly will cause shortage of capacity, freezing, water leakage or trouble on the compressor.

Part name	Object		Contents of check	Contents of maintenance
	Indoor	Outdoor		
Heat exchanger	○	○	• Blocking with dust, damage check	• Clean it when blocking is found.
Fan motor	○	○	• Audibility for sound	• When abnormal sound is heard
Filter	○	—	• Visual check for dirt and breakage	• Clean with water if dirty • Replace if any breakage
Fan	○	○	• Visual check for swing and balance • Check adhesion of dust and external appearance.	• Replace fan when swinging or balance is remarkably poor. • If a large dust adheres, clean it with brush or water.
Suction/Discharge grille	○	—	• Visual check for dirt and scratch	• Repair or replace it if deformation or damage is found.
Drain pan	○	—	• Check blocking by dust and dirt of drain water.	• Clean drain pan, Inclination check
Face panel, Louver	○	—	• Check dirt and scratch.	• Cleaning/Coating with repair painting
External appearance	—	○	• Check rust and peeling of insulator • Check peeling and floating of coating film	• Coating with repair painting

11. REPLACEMENT OF THE SERVICE P.C. BOARD(MCC-1646)

⚠ WARNING

Don't open the inverter cover before 1 minute after power has been turned off because an electric shock may be occurred.

Assembly steps:

- 1** LED side of P.C.Board (MCC-1646) shall be inserted to hook① along the guide② of mold.
- 2** Switch side of P.C.Board (MCC-1646) shall be pressed to hook③ along guide④ of mold.
- 3** After assembly, push SW01 and SW02 to check that switches can be click (sound or feeling of click).

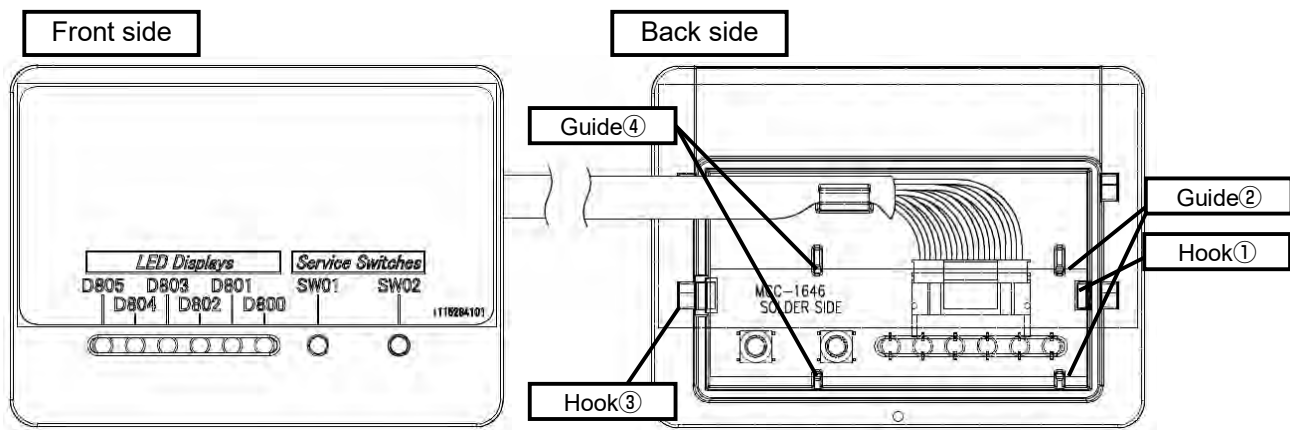

12. HOW TO EXCHANGE COMPRESSOR

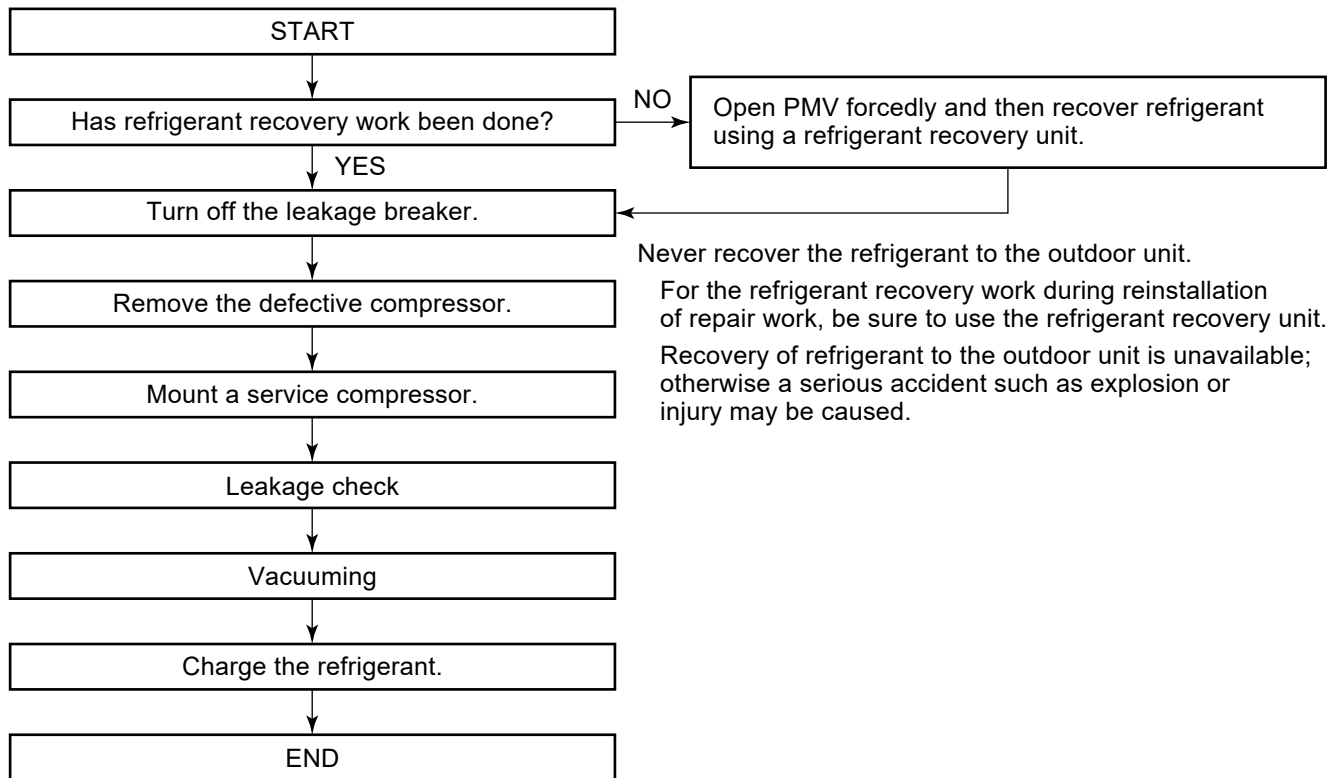

12-1. Exchanging Procedure of Compressor (Outline)





12-2. Exchange of Compressor





For exchange of compressors, refer to (11) Compressor in Section of 13. **Detachments.**

13. DETACHMENTS

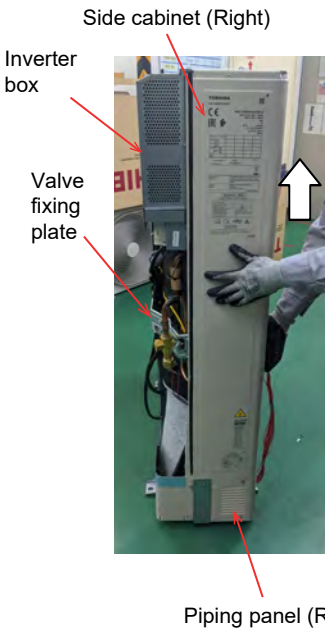
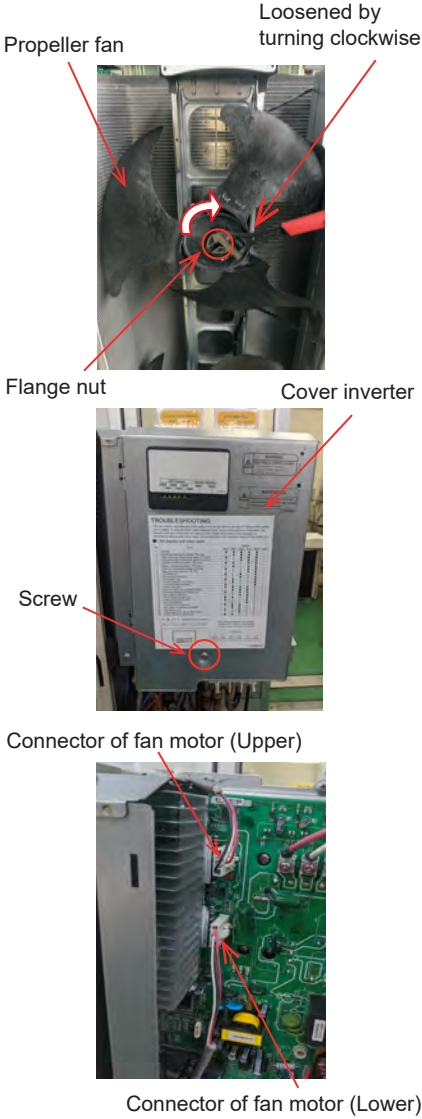

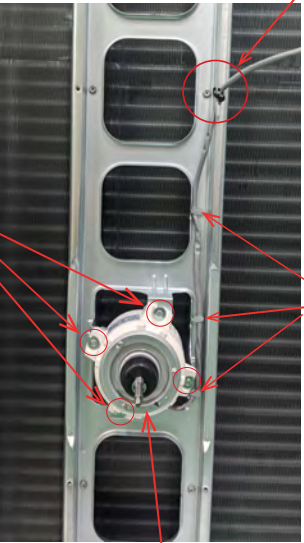
No.	Part name	Procedure	Remarks
①	Common procedure Front panel Top cover	<hr/> <p style="text-align: center;">CAUTION</p> <p>Be sure to put on the gloves at working time; otherwise an injury may be caused by a part, etc.</p> <hr/> <p>1. Detachment</p> <ol style="list-style-type: none"> 1) Stop operation of the air conditioner and then turn off switch of the breaker. 2) Remove the front panel. (Hexagonal screw $\varnothing 4 \times 10$, 2 pcs.) * After removing screws, remove the front panel while pulling it downward. 3) Remove the power wire and indoor/outdoor connecting wire from the cord clamp and the terminals. 4) Remove the top plate. (Hexagonal screw $\varnothing 4 \times 10$, 5 pcs.) <p>2. Attachment</p> <ol style="list-style-type: none"> 1) Attach the top plate. (Hexagonal screw $\varnothing 4 \times 10$, 5 pcs.) 2) Connect the power supply wire and the indoor/outdoor connecting wire to the terminal and fix it with cord clamp. <hr/> <p style="text-align: center;">CAUTION</p> <p>Using bundling band on the market, be sure to fix the power wire and indoor/outdoor connecting wire along the crossover pipe so that they do not come to contact with the compressor, valve at gas side, pipe at gas side and discharge pipe.</p> <hr/> <ol style="list-style-type: none"> 3) Attach the front panel. (Hexagonal screw $\varnothing 4 \times 10$, 2 pcs.) 	 <p style="text-align: center;">Front panel Top plate</p> 

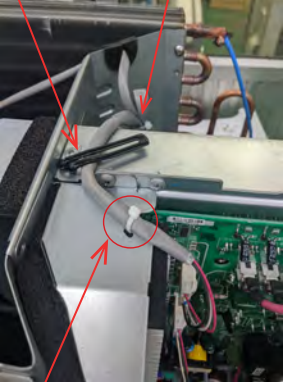

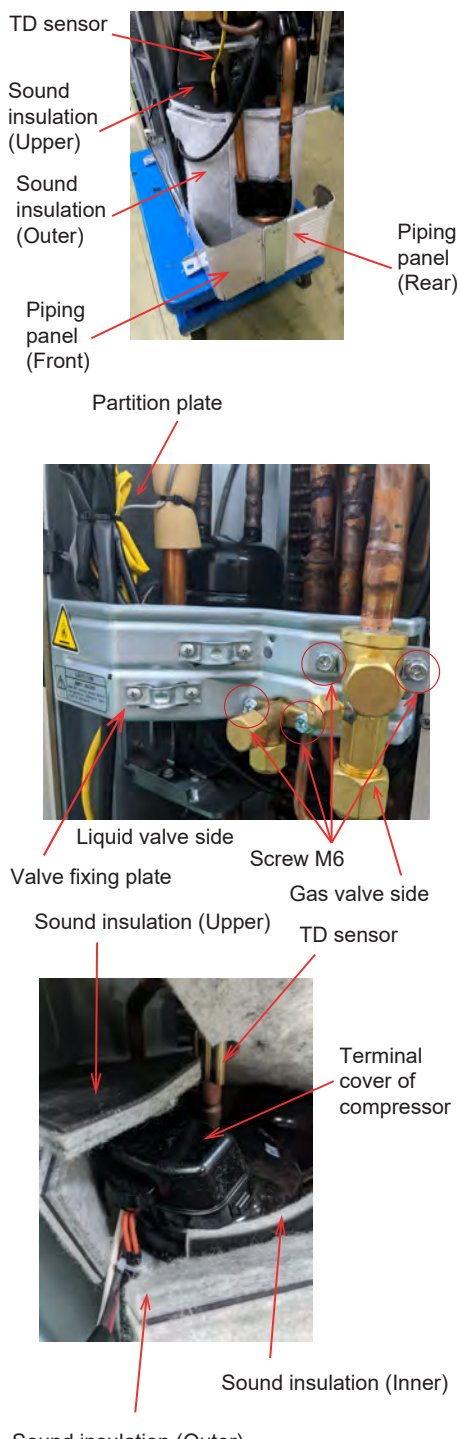

No.	Part name	Procedure	Remarks
②	Plate-stay (Fin guard)	<p>1. Detachment</p> <ol style="list-style-type: none"> 1. Following to work of Detachment ① 2. Remove screws for the Plate-stay(Fin-Guard) ($\varnothing 4 \times 10$, 7 pcs.), ($\varnothing 4 \times 14$, 2 pcs.) <p>2. Attachment</p> <p>Attachment the Plate-stay (Fin guard) in the reverse process of "1.Detachment".</p>	 <p>Plate-stay (Fin guard)</p>  <p>Plate-stay (Fin guard)</p>
③	Air-outlet cabinet	<p>1. Detachment</p> <ol style="list-style-type: none"> 1) Following to work of Detachment of ① and ②. 2) Remove the screws from the air-out cabinet and the partition plate. ($\varnothing 4 \times 10$, 4 pcs.) 3) Remove the screws from the Air-out cabinet and the base plate, ($\varnothing 4 \times 10$, 2 pcs.) 4) Remove the screws from the Air-out cabinet and the motor base, ($\varnothing 4 \times 10$, 2 pcs.) 5) Remove the screws from the Air-out cabinet and the heat exchanger, ($\varnothing 4 \times 8$, 2 pcs.) 	<p>Hear exchanger Motor base</p>  <p>Air-out cabinet Partition plate Base plate</p>

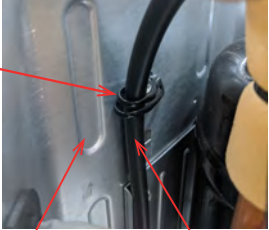

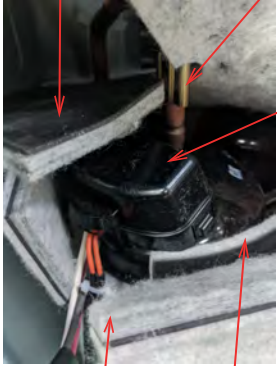
No.	Part name	Procedure	Remarks
④	Side cabinet (right)	<p>1. Detachment</p> <ol style="list-style-type: none"> 1) Following to work of Detachment of ①. 2) Remove the screws from the side panel (right) and the inverter box. (Ø4 × 10, 2 pcs.) 3) Remove the screws from the side panel (right) and the valve fixing plate, (Ø4 × 10, 2 pcs.) 4) Remove the screws from the side panel (right) and the piping panel (rear), (Ø4 × 10, 2 pcs.) 5) Remove the screws from the side panel (right) and the base plate, (Ø4 × 8, 2 pcs.) 6) Remove the screws from the side panel (right) and the heat exchanger, (Ø4 × 8, 3 pcs.) 7) Slide the side cabinet (right) upward and then remove it from hook of Inverter box. <p>2. Attachment</p> <p>Attachment the side cabinet (right) in the reverse process of "1. Detachment".</p>	
⑤	Fan motor	<p>1. Detachment</p> <ol style="list-style-type: none"> 1) Following to work of Detachment of ①, ② and ③ 2) Make sure that the fan motor and the propeller fan stop. 3) Remove flange nut from the fan motor and propeller fan. 4) Remove propeller fan. 5) Remove inverter box cover from inverter box (Ø4 × 8, 1 pcs.) 6) Remove the connector of fan motor from the inverter box. 7) Remove fan motor lead from the fan motor lead fixing rubber at the partition plate. 8) For fan motor lead (Upper), Cut the white binding band 1 pcs. and remove fan motor lead from core clamp on Inverter box. 9) For fan motor lead (Lower), Remove them from Cable clamp 2 position. 10) Cut the binding band at base motor. 11) Loose the 3 claws (Each motor) on the base motor. 12) Remove the fixing screws (4 Positions / each) while holding the fan motor so as not to fall it. 	

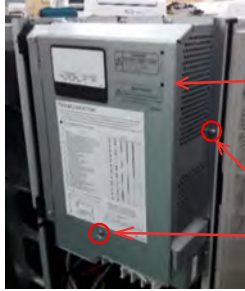
No.	Part name	Procedure	Remarks
⑤	Fan motor (Continued)	<p>2. Attachment Attachment the fan motor in the reverse process of "1. Detachment".</p> <p>* Precaution when assembling the fan motor.</p> <ul style="list-style-type: none"> • Tighten the flange nut to 4.95 N.m (50 kgf.cm) • To prevent the fan motor leads from coming in contact with the propeller fan ensure to adjust the length of the fan motor lead fixing rubber so that the fan motor lead has no slack. Attach the fan motor lead fixing rubber to the partition plate so that the projection is on the refrigerant cycle side. • Ensure to bundle again with a commercially available cable clamp where the cable clamp was removed.  	   

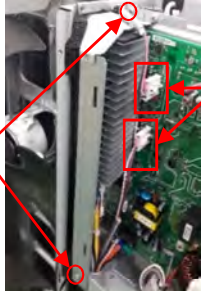
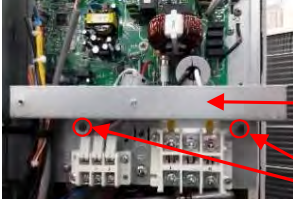
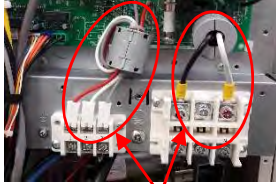
No.	Part name	Procedure	Remarks
⑥	Compressor and Compressor lead	<p style="text-align: center;">⚠ WARNING</p> <p>When removing the welding part of the suction / discharge pipe of the compressor, remove them after recovering the refrigerant in a well-ventilated place. If recovery is insufficient the refrigerant and refrigerating machine oil may squirt, cause injury.</p> <p>1. Remove broken compressor</p> <ol style="list-style-type: none"> 1) Recover refrigerant gas. 2) Following to work of Detachment ① ,② ③ and ④ 3) Remove the piping panel (front). <ol style="list-style-type: none"> 3.1) Remove screws of the piping panel (front) and base plate (Ø4 × 10, 2 pcs.). 3.2) Remove screws of the piping panel (front) and the piping plate (rear) (Ø4 × 10, 1 pcs.). 4) Remove screws of the piping panel (rear) and base plate (Ø4 × 10, 2 pcs.). 5) Remove the valve fixing plate <ol style="list-style-type: none"> 5.1) Remove bolt for liquid valve side and valve fixing plate (M6 x 15, 2 pcs.). 5.2) Remove bolt for gas valve side and valve fixing plate (M6 x 15, 2 pcs.). 6) Remove the valve fixing plate and the partition plate (Ø4 × 10, 1 pcs.) 7) Remove the sound insulation board (Upper, Inner and Outer). 8) Remove TD sensor from discharge pipe. 9) Remove terminal cover of compressor (2 Claws), compressor lead and compressor case thermostat (1 Claw). 10) Remove the compressor lead from partition plate. 11) Remove the discharge and suction pipes connected to the compressor using a burner. 	 <p>TD sensor</p> <p>Sound insulation (Upper)</p> <p>Sound insulation (Outer)</p> <p>Piping panel (Front)</p> <p>Piping panel (Rear)</p> <p>Partition plate</p> <p>Liquid valve side</p> <p>Valve fixing plate</p> <p>Sound insulation (Upper)</p> <p>Screw M6</p> <p>Gas valve side</p> <p>TD sensor</p> <p>Terminal cover of compressor</p> <p>Sound insulation (Outer)</p> <p>Sound insulation (Inner)</p>

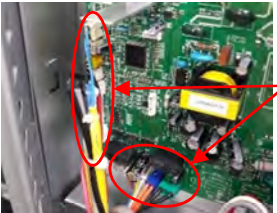
No.	Part name	Procedure	Remarks
⑥	Compressor and Compressor lead (Continued)	<p style="text-align: center;">⚠ WARNING</p> <p>Ensure extreme caution when removing piping by melting the weld with a burner as fire may result if there is any oil within the piping.</p> <hr/> <p style="text-align: center;">⚠ CAUTION</p> <p>Carefully avoid contact with the 4-way valve and PMV with the flame (could result in a malfunction)</p> <hr/> <p>12) Pull off the discharge pipe and the suction pipe of the refrigerating cycle upward.</p> <p>13) Take off the compressor nuts which fix the compressor to the bottom plate.(3 pcs.)</p> <p>14) Pull out the compressor toward you.</p> <hr/> <p style="text-align: center;">⚠ CAUTION</p> <p>The compressor is 15 kg or more. Ensure two worker carry out the work.</p> <hr/> <p>NOTE:</p> <ul style="list-style-type: none"> As shown in the right figure, mount the sound insulation board (rolling in, rolling out) by passing through it between the piping and the partition plate. Fix TD sensor to discharge pipe so that TD sensor does not directly come to contact with the discharge pipe. <p>3. Attachment</p> <p>1) Attach the compressor in the reverse process of "1.Detachment".</p> <ul style="list-style-type: none"> Also ensure to replace the compressor lead after replacing the compressor . Install the sound insulation board (Inner,Outer) through the space between the compressor and the piping, and between the pipes and partition plate as shown on the right. <p>3. Vacuum</p> <p>1) Connect the vacuum pump to the charge port of the liquid and gas pipe valves and the check joint on the high pressure side, and then operate the vacuum pump.</p>	 <p>Cord clamp Partition plate Compressor lead</p>  <p>Discharge pipe (Remove here) Suction pipe (Remove here)</p> <p>Bolt of compressor (3 pcs.)</p>  <p>Sound insulation (Upper) TD sensor</p> <p>Terminal cover of compressor</p> <p>Sound insulation (Inner)</p> <p>Sound insulation (Outer)</p>

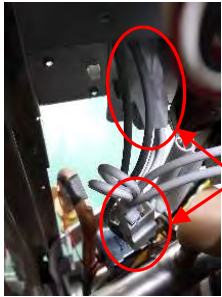
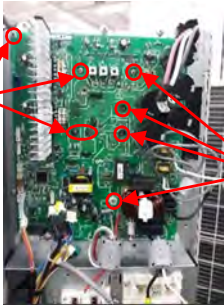
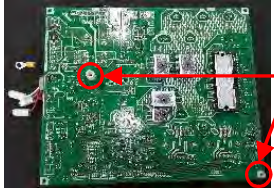
No.	Part name	Procedure	Remarks
⑦	P.C.board	<p>1. Detachment</p> <p>1) Carry out work of 1 of ①</p> <hr/> <p style="text-align: center;">⚠WARNING</p> <p style="text-align: center;">Never disassemble the inverter for 1 minute after power has been turned off because an electric shock may be caused.</p> <hr/> <p>2) Take off screws to open inverter box cover, remove connector from P.C.board and then remove inverter box cover.</p> <p>3) Remove upper and lower fan motor connector from P.C.board and then take off screws to remove inverter box side cover.</p> <p>4) Take off screws to remove partition cover and then remove lead wires from terminal.</p> <p>5) Take off screws to remove compressor wire out from terminal at P.C.board.</p> <p>6) Remove all connectors at bottom left of P.C.board.</p>	 <p>Inverter box cover</p> <p>Screw</p>  <p>Connector</p>  <p>Screw</p> <p>Connector</p>  <p>Partition cover</p> <p>Screw</p>  <p>Lead wires</p>  <p>Compressor wire</p> <p>Screw</p>  <p>Connectors</p>

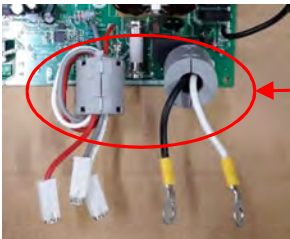
No.	Part name	Procedure	Remarks
⑦	P.C.board (Continued)	<p>7) At the back of inverter box, disconnect reactor connector from reactor. Pull reactor wires pass through hole of inverter box.</p> <p>8) Take off screws that fix P.C.board and remove P.C.board out of inverter box. (Beware: Do not damage edge spacers).</p> <p>9) Remove two spacers, Heatsink Fan and two clamp filters from P.C.board.</p> <p>2.Attachment</p> <p>Attachment the P.C.board in the reverse process of "1. Detachment".</p> <hr/> <p style="text-align: center;">⚠CAUTION</p> <p>Apply thermal grease at mating surface between heat sink fan and Fan IPM chips.</p> <p>Be sure that all the connectors are connected correctly and securely inserted. If the components bent during this procedure, straighten them so they do not touch other parts.</p> <hr/>	 <p>Connectors</p>  <p>Screw</p> <p>Screw</p>  <p>Spacer</p>  <p>Heatsink Fan</p>  <p>Clamp filter</p>

14. EXPLODED VIEWS AND PARTS LIST

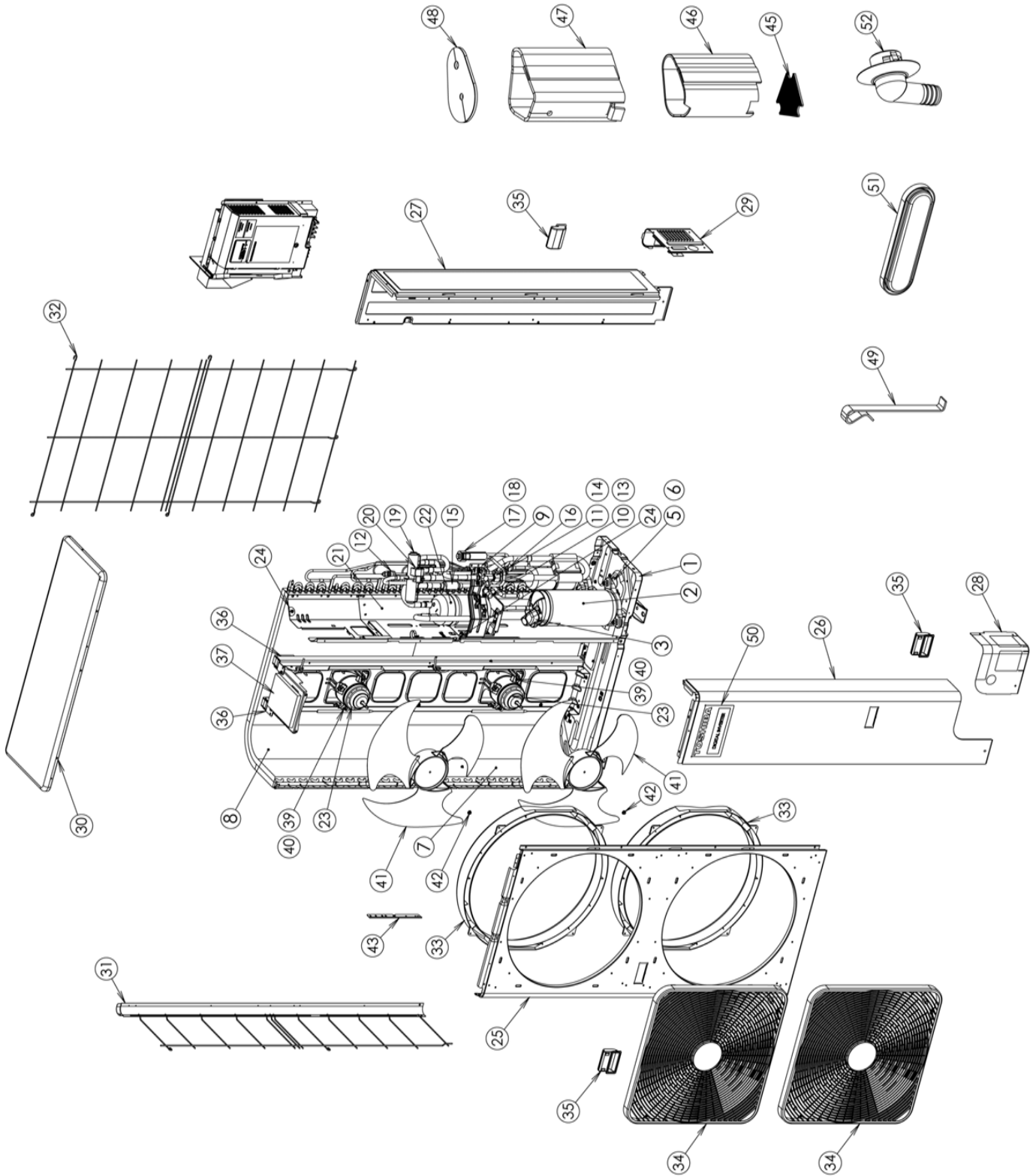

Location No.	Part No.	Description	Model name RAV-GM		
			1601ATP-E	1601ATJP-E	1601ATP-TR
1	43T42373	BASE PLATE ASSEMBLY	1	1	1
2	43T41547	COMPRESSOR(DX380A2T-20M)	1	1	1
3	43T60504	TEMPERATURE SENSOR	1	1	1
5	43T49357	RUBBER,CUSHION	3	3	3
6	43T97326	COMPRESSOR NUT	3	3	3
7	43T43626	DOWN CONDENSER ASSEMBLY	1	-	1
7	43T43628	DOWN CONDENSER ASSEMBLY	-	1	-
8	43T43627	UPPER CONDENSER ASSEMBLY	1	-	1
8	43T43629	UPPER CONDENSER ASSEMBLY	-	1	-
9	43T00781	VALVE FIXING PLATE COATING	1	1	1
10	43T46380	VALVE;PACKED 9.52 DIA	1	1	1
11	43T46381	VALVE;BALL 15.88 DIA	1	1	1
12	43T63373	SWITCH PRESSURE	1	1	1
13	43T47404	BONNET, 9.52 DIA	1	1	1
14	43T47410	BONNET (15.9D)	1	1	1
15	43T47392	STRAINER	1	1	1
16	43T47414	STRAINER	1	1	1
17	43T46387	VALVE,PULSE,MODULATING	1	1	1
18	43T63351	COIL-PMV	1	1	1
19	43T46512	4WAY VALVE	1	1	1
20	43T63383	4 WAY VALVE COIL ASSEMBLY	1	1	1
21	43T04442	PARTITION SERVICE ASSEMBLY	1	1	1
22	43T48324	ACCUMULATOR ASSEMBLY	1	1	1
23	43T60520	MOTOR FAN ASSEMBLY	1	1	1
24	43T96305	BUSHING	1	1	1
25	43T00786	AIR OUTLET CABINET	1	1	1
26	43T04443	FRONT PANEL ASSEMBLY	1	1	1
27	43T00785	RIGHT PANEL ASSEMBLY	1	1	1
28	43T00608	ASM-COAT-P-P-FR	1	1	1
29	43T00609	ASM-COAT-P-P-BK	1	1	1
30	43T00564	UPPER CABINET ASSEMBLY	-	1	-
30	43T00803	UPPER CABINET ASSEMBLY	1	-	1
31	43T00726	GUARD FIN ASSEMBLY	1	1	1
32	43T00727	GUARD FIN BACK	1	1	1
33	43T22313	BELLMOUTH	1	1	1
34	43T19372	FAN GUARD	1	1	1
35	43T71302	HANDLE	1	1	1
36	43T39413	PLATE SUPPORT MOTOR ASSEMBLY	1	1	1
37	43T39412	BASE MOTOR ASSEMBLY	1	1	1
39	43T97309	HEXAGON HEAD SCREW	4	4	4
40	43T22321	COLLAR	4	4	4
41	43T20352	FAN-PR(PB522)	1	1	1
42	43047669	NUT, FLANGE	1	1	1
43	43T43630	COAT PLATE COND ASSEMBLY	1	1	1
45	43T04389	INSULATION SOUND UNDERSIDE	1	1	1
46	43T04312	SOUND-INSU(IS)	1	1	1
47	43T04387	INSULATION SOUND OUTSIDE	1	1	1
48	43T04439	INSULATION SOUND UPPERSIDE	1	1	1
49	43T19333	HOLDER, SENSOR	1	1	1
50	43T85553	MARK-T	1	1	1
51	43089160	CAP, WATERPROOF	5	5	5
52	43T79305	DRAIN NIPPLE	1	1	1

<Inverter assembly GM1601

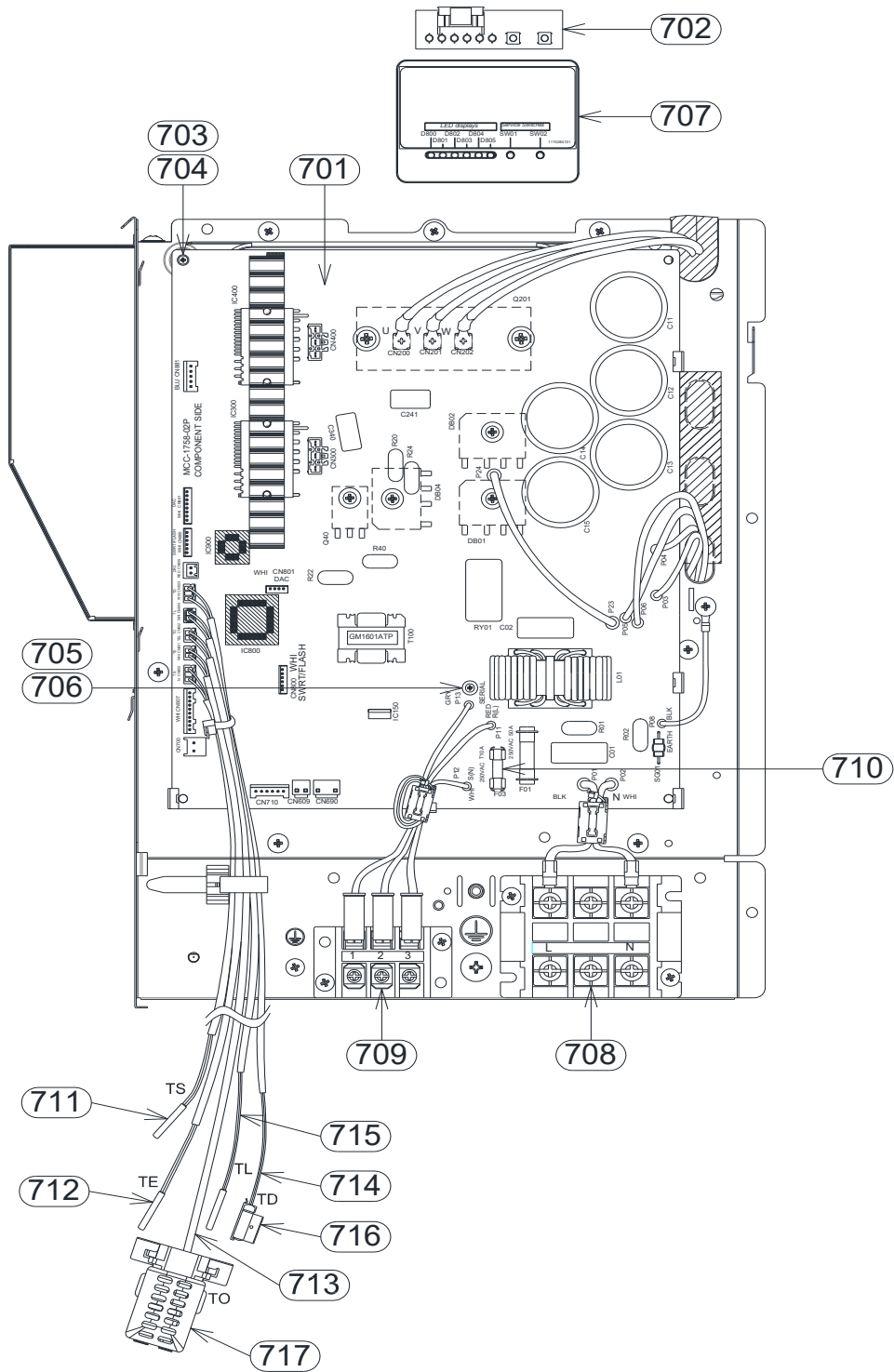

Location No.	Part No.	Description	Model name RAV-GM		
			1601ATP-E	1601ATJP-E	1601ATP-TR
701	43T6W755	PC BOARD ASSY (MCC-1758)	1	1	1
702	43T6V418	PC BOARD ASSY(MCC-1646)-LED	1	1	1
703	43T96306	COLLAR	1	1	1
704	43T96307	BUSHING	1	1	1
705	43T61315	SPACER(BUSH)	1	1	1
706	43T61316	SPACER(COLLAR)	1	1	1
707	43T61321	BASE, PC BOARD	1	1	1
708	43T60424	ASM-SERV-Terminal block,3P,60A	1	1	1
709	43T60331	TERMINAL, 3P	1	1	1
710	43T60413	FUSE	1	1	1
711	43T50336	TEMPERATURE SENSOR	1	1	1
712	43T50385	TEMPERATURE SENSOR,TE	1	1	1
713	43T50337	TEMPERATURE SENSOR,TO	1	1	1
714	43T50376	SENSOR-TD	1	1	1
715	43T50335	TEMPERATURE SENSOR	1	1	1
716	43T63323	HOLDER,SENSOR	1	1	1
717	43T63335	SENSOR HOLDER	1	1	1

WARNINGS ON REFRIGERANT LEAKAGE

Check of Concentration Limit

The room in which the air conditioner is to be installed requires a design that in the event of refrigerant gas leaking out, its concentration will not exceed a set limit.

The refrigerant R32 which is used in the air conditioner is safe, without the toxicity or combustibility of ammonia, and is not restricted by laws to be imposed which protect the ozone layer. However, since it contains more than air, it poses the risk of suffocation if its concentration should rise excessively. Suffocation from leakage of R32 is almost non-existent.

If a conditioner system is to be installed in a small room, select a suitable model and installation procedure so that if the refrigerant accidentally leaks out, its concentration does not reach the limit (and in the event of an emergency, measures can be made before injury can occur).

In a room where the concentration may exceed the limit, create an opening with adjacent rooms, or install mechanical ventilation combined with a gas leak detection device.

The concentration is as given below.

$$\frac{\text{Total amount of refrigerant (kg)}}{\text{Min. volume of the indoor unit installed room (m}^3\text{)}} \leq \text{Concentration limit (kg/m}^3\text{)}$$

Refrigerant concentration limit shall be in accordance with local regulations.

Toshiba Carrier (Thailand) Co., Ltd.

**144/9 MOO 5, BANGKADI INDUSTRIAL PARK, TIVANON ROAD, TAMBOL BANGKADI,
AMPHUR MUANG, PATHUMTHANI 12000, THAILAND.**