

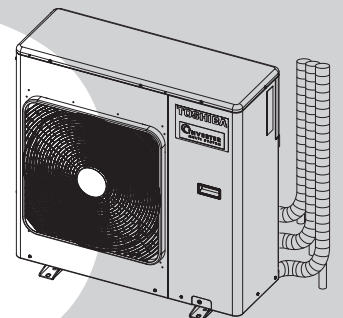
# TOSHIBA

## SERVICE MANUAL

# AIR-CONDITIONER

SPLIT TYPE

***RAS-3M26U2AVG-E***  
***RAS-3M26U2AVG-TR***



**R32**

***INVERTER***



*Revised on June, 2020*

# CONTENTS

% G5: 9HM DF975I HCBG ..... 1

&" GD97 = 75HCBG ..... 7

' " F9: F= 9F5BH' F32' ..... &1

(" 7CBGHFI 7HCB' J=9K G' ..... 89

)" K =B; ' 8=; F5A' ..... 30

\*" GD97 = 75HCBG' C: ' 9 @7HF 75 @D5FHG' ..... 1

+" F9: F= 9F5BH' 7M7 @' 8=; F5A' ..... 2

, " 7CBHFC@6 @C7?' 8=; F5A' ..... 5

- " CD9F5HCB' 89G7F=DHCB' ..... 6

%" =BGH5 @5HCB' DFC798I F9' ..... 53

%%" <CK 'HC' 8=; BCG9'H<9'HF CI 6 @' ..... 63




%&" <CK 'HC' F9D@79'H<9'A5=B'D5FHG' ..... , 7

% " 9LD@C898'J=9K G'5B8'D5FHG @GH' ..... 101

# 1. SAFETY PRECAUTIONS




The important contents concerned to the safety are described on the product itself and on this Service Manual. Please read this Service Manual after understanding the described items thoroughly in the following contents (Indications/Illustrated marks), and keep them.





## [Explanation of indications]

Indication	Explanation
 <b>DANGER</b>	Indicates contents assumed that an imminent danger causing a death or serious injury of the repair engineers and the third parties when an incorrect work has been executed.
 <b>WARNING</b>	Indicates possibilities assumed that a danger causing a death or serious injury of the repair engineers, the third parties, and the users due to troubles of the product after work when an incorrect work has been executed.
 <b>CAUTION</b>	Indicates contents assumed that an injury or property damage (*) may be caused on the repair engineers, the third parties, and the users due to troubles of the product after work when an incorrect work has been executed.

\* Property damage : Enlarged damage concerned to property, furniture, and domestic animal/pet

## [Explanation of illustrated marks]

Mark	Explanation
	Indicates prohibited items (Forbidden items to do) The sentences near an illustrated mark describe the concrete prohibited contents.
	Indicates mandatory items (Compulsory items to do) The sentences near an illustrated mark describe the concrete mandatory contents.
	Indicates cautions (including danger/warning) The sentences or illustration near or in an illustrated mark describe the concrete cautious contents.

	Read the precautions in this manual carefully before operating the unit.		This appliance is filled with R32. (Flammable Material)
	Information included in the Operation Manual and/or Installation Manual.		Service personnel should be handing this equipment with reference to the Installation Manual.

### For general public use

Power supply cord of outdoor unit shall be more than 1.5 mm<sup>2</sup> (H07RN-F or 60245IEC66) polychloroprene sheathed flexible cord.

- Read this “SAFETY PRECAUTIONS” carefully before servicing.
- The precautions described below include the important items regarding safety. Observe them without fail.
- After the servicing work, perform a trial operation to check for any problem.
- Turn off the main power supply switch (or breaker) before the unit maintenance.

#### ■ Important information regarding the refrigerant used

This product contains fluorinated greenhouse gases covered by the Kyoto Protocol. Do not vent gases into the atmosphere. Refrigerant type: **R32**

GWP<sup>(1)</sup> value: **675\***

<sup>(1)</sup>GWP = global warming potential

The refrigerant quantity is indicated on the unit name plate.

\* This value is based on F gas regulation 517/2014

---



---

 **CAUTION**

---



---

**New Refrigerant Air Conditioner Installation**

- **THIS AIR CONDITIONER ADOPTS THE NEW HFC REFRIGERANT (R32 WHICH DOES NOT DESTROY OZONE LAYER).**

R32 refrigerant is apt to be affected by impurities such as water, oxidizing membrane, and oils because the working pressure of R32 refrigerant is approx. 1.6 times of refrigerant R22. Accompanied with the adoption of the new refrigerant, the refrigeration machine oil has also been changed. Therefore, during installation work, be sure that water, dust, former refrigerant, or refrigeration machine oil does not enter into the new type refrigerant R32 air conditioner circuit.

To prevent mixing of refrigerant or refrigerating machine oil, the sizes of connecting sections of charging port on main unit and installation tools are different from those used for the conventional refrigerant units. Accordingly, special tools are required for the new refrigerant (R32) units. For connecting pipes, use new and clean piping materials with high pressure fittings made for R32 only, so that water and/or dust does not enter. Moreover, do not use the existing piping because there are some problems with pressure fittings and possible impurities in existing piping.

---



---

 **CAUTION**

---



---

**TO DISCONNECT THE APPLIANCE FROM THE MAIN POWER SUPPLY**

This appliance must be connected to the main power supply by means of a circuit breaker or a switch with a contact separation of at least 3 mm in all poles.

---



---

 **DANGER**

---



---

- **The manufacturer shall not assume any liability for the damage caused by not observing the description of this manual.**
- **Ask an authorized dealer or qualified installation professional to install/maintain the air conditioner.**  
INAPPROPRIATE SERVICING MAY RESULT IN WATER LEAKAGE, ELECTRIC SHOCK OR FIRE.
- **TURN OFF MAIN POWER SUPPLY BEFORE ATTEMPTING ANY ELECTRICAL WORK.**  
MAKE SURE ALL POWER SWITCHES ARE OFF. FAILURE TO DO SO MAY CAUSE ELECTRIC SHOCK.

 **DANGER: HIGH VOLTAGE**

---



---

The high voltage circuit is incorporated. Be careful to do the check service, as the electric shock may be caused in case of touching parts on the P.C. board by hand.

---



---

- **CORRECTLY CONNECT THE CONNECTING CABLE. IF THE CONNECTING CABLE IS INCORRECTLY CONNECTED, ELECTRIC PARTS MAY BE DAMAGED.**
  - **CHECK THAT THE EARTH WIRE IS NOT BROKEN OR DISCONNECTED BEFORE SERVICE AND INSTALLATION. FAILURE TO DO SO MAY CAUSE ELECTRIC SHOCK.**
  - **DO NOT INSTALL NEAR CONCENTRATIONS OF COMBUSTIBLE GAS OR GAS VAPORS. FAILURE TO FOLLOW THIS INSTRUCTION CAN RESULT IN FIRE OR EXPLOSION.**
  - **TO PREVENT THE INDOOR UNIT FROM OVERHEATING AND CAUSING A FIRE HAZARD, PLACE THE UNIT WELL AWAY (MORE THAN 2 M) FROM HEAT SOURCES SUCH AS RADIATORS, HEAT RESISTORS, FURNACE, STOVES, ETC.**
  - **WHEN MOVING THE AIR-CONDITIONER FOR INSTALLATION IN ANOTHER PLACE, BE VERY CAREFUL NOT TO ALLOW THE SPECIFIED REFRIGERANT (R410A) TO BECOME MIXED WITH ANY OTHER GASEOUS BODY INTO THE REFRIGERATION CIRCUIT. IF AIR OR ANY OTHER GAS IS MIXED IN THE REFRIGERANT, THE GAS PRESSURE IN THE REFRIGERATION CIRCUIT WILL BECOME ABNORMALLY HIGH AND IT MAY RESULT IN THE PIPE BURSTING AND POSSIBLE PERSONNEL INJURIES.**
  - **IN THE EVENT THAT THE REFRIGERANT GAS LEAKS OUT OF THE PIPE DURING THE SERVICE WORK AND THE INSTALLATION WORK, IMMEDIATELY LET FRESH AIR INTO THE ROOM. IF THE REFRIGERANT GAS IS HEATED, SUCH AS BY FIRE, GENERATION OF POISONOUS GAS MAY RESULT.**
- 
-

## **WARNING**

- Never modify this unit by removing any of the safety guards or bypassing any of the safety interlock switches.
- Do not install in a place which cannot bear the weight of the unit. Personal injury and property damage can result if the unit falls.
- Before doing the electrical work, attach an approved plug to the power supply cord. Also, make sure the equipment is properly earthed.
- Appliance shall be installed in accordance with national wiring regulations. If you detect any damage, do not install the unit. Contact your dealer immediately.
- Do not use any refrigerant different from the one specified for complement or replacement. Otherwise, abnormally high pressure may be generated in the refrigeration cycle, which may result in a failure or explosion of the product or an injury to your body.
- Do not use means to accelerate the defrosting process or to clean, other than those recommended by the manufacturer.
- The appliance shall be stored in a room without continuously operating ignition sources (for example: open flames, an operating gas appliance or an operating electric heater).
- Be aware that refrigerants may not contain an odour.
- Do not pierce or burn as the appliance is pressurized. Do not expose the appliance to heat, flame, sparks, or other sources or ignition. Else, it may explode and cause injury or death.
- For R32 model, use pipes, flare nut and tools which is specified for R32 refrigerant. Using of existing (R22) piping, flare nut and tools may cause abnormally high pressure in the refrigerant cycle (piping), and possibly result in explosion and injury.
- Thickness of copper pipes used R32 must be more than 0.8mm. Never use copper pipes thinner than 0.8mm.
- Do not perform flare connection inside a building or dwelling or room, when joining the heat exchanger of indoor unit with interconnection piping. Refrigerant connection inside a building or dwelling or room must be made by brazing or welding. Joint connection of indoor unit by flaring method can only be made at outdoor or at outside of building or dwelling or room. Flare connection may cause gas leak and flammable atmosphere.
- After completion of installation or service, confirm there is no leakage of refrigerant gas. It may generate toxic gas when the refrigerant contacts with fire.
- Minimum floor area for installation the Multi System air conditioner, When combined with the indoor product, shall be installed in a room with a floor area follow as below table.

Refrigerant amount (kg)	Minimum floor area, When combined with indoor product. (m <sup>2</sup> )			
	BI-FLOW CONSOLE	HIGH-WALL	4-WAY CASSETTE	DUCT
≤1.84	-	-	-	-
1.92	32	4	2	2
2.12	39	4	3	3
2.32	46	5	3	3
2.39	49	5	4	4
2.52	54	6	4	4
2.72	63	7	5	5
2.92	73	8	5	5
3.19	87	10	6	6

**When combined the Bi-Flow console with outdoor unit RAS-5M34\* model, The maximum pipe length for the total unit should be limited at 46 m.**

\* Model series.

- Comply with national gas regulations.

 **CAUTION**

- 
- Exposure of unit to water or other moisture before installation could result in electric shock. Do not store it in a wet basement or expose to rain or water.
  - After unpacking the unit, examine it carefully for possible damage.
  - Do not install the unit at place where leakage of flammable gas may occur. In case gas leaks and accumulates at surrounding of the unit, it may cause of fire.
  - Do not install in a place that can increase the vibration of the unit. Do not install in a place that can amplify the noise level of the unit or where noise and discharged air might disturb neighbors.
  - To avoid personal injury, be careful when handling parts with sharp edges.
  - Please read this installation manual carefully before installing the unit. It contains further important instructions for proper installation.
  - The manufacturer shall not assume any liability for the damage caused by not observing the description of this manual.
-

## 2. SPECIFICATIONS

The indoor and outdoor units that can be used in combination are shown in the tables below.

Table of models that can be used in combination

Type	Outdoor unit	Combinations of indoor unit models that can be connected
Heat pump	RAS-3M26U2AVG-E, -TR	Refer to page 8 to 19

### NOTES

A 1-room connection is not an option for the indoor units (you cannot connect only one indoor unit).

Be sure to connect indoor unit in two or more.

### 2-1. Specifications

#### <Heat Pump Models>

#### RAS-3M26U2AVG-E, -TR

Unit model		Outdoor	RAS-3M26U2AVG-E, -TR		
		Connection indoor unit of this specification	RAS-B16PKVSG-E,-TR(x2) + B13PKVSG-E,-TR		
Cooling Capacity		(kW)	7.5		
Cooling Capacity range		(kW)	4.1 to 9.0		
Heating Capacity		(kW)	9.0		
Heating Capacity range		(kW)	2.0 to 11.2		
Power supply		220-240V, 1Ph, 50Hz			
Electric characteristics	Total	Operation mode		Cooling Heating	
		Running current	(A)	9.57 / 9.15 / 8.77	10.53 / 10.07 / 9.65
		Power consumption	(W)	2000	2200
		Power factor	(%)	95	95
		Starting current	(A)	9.57	
COP (Cooling/Heating)		3.75 / 4.09			
Operating noise	Outdoor (Cooling/Heating)	Sound pressure level	(dBA) 48 / 49		
		Sound power level	(dBA) 63 / 64		
Outdoor unit	Dimension	Height	(mm) 890		
		Width	(mm) 900		
		Depth	(mm) 320		
	Net weight	(kg)	72		
	Compressor	Motor output	(W)	2000	
		Type	Twin rotary type with DC-inverter variable speed control		
		Model	DX220A2T-20L		
	Fan motor output	(W)	60		
	Air flow rate (Cooling/Heating)	(m <sup>3</sup> /h)	2507 / 2507		
	Type	Flare connection			
Name of refrigerant	R32				
Weight of refrigerant	(kg)	1.92			
Piping connection	Outdoor unit	A unit liquid side/gas side	Ø6.35 / Ø12.7		
		B unit liquid side/gas side	Ø6.35 / Ø12.7		
		C unit liquid side/gas side	Ø6.35 / Ø9.52		
	Maximum length (per unit)	(m)	25		
	Maximum length (total)	(m)	70		
	Maximum chargeless length	(m)	40		
Maximum height difference	(m)	15			
Wiring connection	Power supply / interconnection		3 Wires : includes earth / 4 Wires : includes earth		
Usable temperature range	Outdoor (Cooling/Heating)		(°C) -10 to 46°C / -15 to 24°C		

- For performance when each indoor unit is combined with other unit, refer to the separate table.
- The specifications may be subject to change without notice for purpose of improvement.

**Combination of indoor units****Outdoor Unit : RAS-3M262AVG-E, -TR**

Operation mode : Cooling

Power supply voltage : 220V

Operatin status	Indoor unit					Unit capacity (kW)					Cooling capacity (kW)			Power consumption (W)			Operating current (A)			Power factor (%)			EER			
	A	B	C	D	E	ΣkBTU	A	B	C	D	E	Min	Rate	Max	Min	Rate	Max	Min	Rate	Max	Min	Rate	Max	Min	Rate	Max
1 unit	05	-	-	-	-	5	1.50	-	-	-	-	1.4	1.5	2.0	630	640	650	3.77	3.78	3.48	76	77	85	2.34		
	07	-	-	-	-	7	2.00	-	-	-	-	1.4	2.0	2.5	640	650	700	3.83	3.84	3.74	76	77	85	3.08		
	10	-	-	-	-	10	2.70	-	-	-	-	1.4	2.7	3.2	640	750	950	3.83	4.43	4.64	76	77	93	3.60		
	13	-	-	-	-	13	3.70	-	-	-	-	1.4	3.7	4.4	640	1200	1520	3.68	6.20	7.20	79	88	96	3.08		
	16	-	-	-	-	16	4.50	-	-	-	-	1.4	4.5	5.0	640	1650	2000	3.68	7.98	9.28	79	94	98	2.73		
	18	-	-	-	-	18	5.00	-	-	-	-	1.4	5.0	5.2	640	1950	2100	3.68	9.33	9.74	79	95	98	2.56		
	22	-	-	-	-	22	6.00	-	-	-	-	2.4	6.0	6.8	640	2020	2500	3.68	9.67	11.60	79	95	98	2.97		
	24	-	-	-	-	24	7.10	-	-	-	-	2.4	7.1	7.2	660	2390	2960	3.80	11.44	13.73	79	95	98	2.97		
2 units	05	05	-	-	-	10	1.50	1.50	-	-	-	2.5	3.0	4.0	640	750	1000	3.64	3.59	4.64	80	95	98	4.00		
	07	05	-	-	-	12	2.00	1.50	-	-	-	2.5	3.5	4.5	640	850	1200	3.64	4.07	5.57	80	95	98	4.12		
	10	05	-	-	-	15	2.70	1.50	-	-	-	2.5	4.2	5.2	640	1100	1550	3.64	5.26	7.19	80	95	98	3.82		
	13	05	-	-	-	18	3.70	1.50	-	-	-	2.5	5.2	6.0	640	1450	1950	3.64	6.94	9.04	80	95	98	3.59		
	16	05	-	-	-	21	4.35	1.45	-	-	-	2.5	5.8	6.5	640	1700	2200	3.64	8.13	10.20	80	95	98	3.41		
	18	05	-	-	-	23	4.54	1.36	-	-	-	2.5	5.9	6.6	640	1740	2250	3.64	8.33	10.44	80	95	98	3.39		
	22	05	-	-	-	27	5.04	1.26	-	-	-	2.5	6.3	6.9	640	1900	2400	3.64	9.09	11.13	80	95	98	3.32		
	24	05	-	-	-	29	5.20	1.10	-	-	-	2.5	6.3	6.9	640	1900	2400	3.64	9.09	11.13	80	95	98	3.32		
	07	07	-	-	-	14	2.00	2.00	-	-	-	2.5	4.0	6.3	640	950	1900	3.64	4.55	8.81	80	95	98	4.21		
	10	07	-	-	-	17	2.70	2.00	-	-	-	2.5	4.7	6.3	640	1200	2100	3.64	5.74	9.74	80	95	98	3.92		
	13	07	-	-	-	20	3.70	2.00	-	-	-	2.6	5.7	6.5	660	1600	2220	3.75	7.66	10.30	80	95	98	3.56		
	16	07	-	-	-	23	4.08	1.82	-	-	-	2.7	5.9	6.6	660	1700	2220	3.75	8.13	10.30	80	95	98	3.47		
	18	07	-	-	-	25	4.50	1.80	-	-	-	2.9	6.3	6.9	670	1900	2400	3.81	9.09	11.13	80	95	98	3.32		
	22	07	-	-	-	29	4.73	1.58	-	-	-	2.9	6.3	7.1	670	1900	2400	3.81	9.09	11.13	80	95	98	3.32		
	24	07	-	-	-	31	5.31	1.49	-	-	-	3.0	6.8	7.4	690	2200	2450	3.92	10.53	11.36	80	95	98	3.09		
	10	10	-	-	-	20	2.70	2.70	-	-	-	2.5	5.4	6.3	640	1500	2100	3.64	7.18	9.74	80	95	98	3.60		
	13	10	-	-	-	23	3.41	2.49	-	-	-	2.7	5.9	6.6	660	1700	2220	3.75	8.13	10.30	80	95	98	3.47		
	16	10	-	-	-	26	3.94	2.36	-	-	-	2.9	6.3	6.9	670	2000	2400	3.81	9.57	11.13	80	95	98	3.15		
	18	10	-	-	-	28	4.09	2.21	-	-	-	2.9	6.3	7.1	670	1900	2400	3.81	9.09	11.13	80	95	98	3.32		
	22	10	-	-	-	32	4.69	2.11	-	-	-	3.0	6.8	7.4	690	2200	2450	3.92	10.53	11.36	80	95	98	3.09		
	24	10	-	-	-	34	5.22	1.98	-	-	-	3.2	7.2	7.8	700	2300	2500	3.98	11.00	11.60	80	95	98	3.13		
	13	13	-	-	-	26	3.15	3.15	-	-	-	2.9	6.3	7.1	670	2000	2400	3.81	9.57	11.13	80	95	98	3.15		
	16	13	-	-	-	29	3.73	3.07	-	-	-	3.0	6.8	7.4	690	2200	2450	3.92	10.53	11.36	80	95	98	3.09		
	18	13	-	-	-	31	3.91	2.89	-	-	-	3.0	6.8	7.4	690	2200	2450	3.92	10.53	11.36	80	95	98	3.09		
	22	13	-	-	-	35	4.45	2.75	-	-	-	3.2	7.2	7.8	700	2300	2500	3.98	11.00	11.60	80	95	98	3.13		
	24	13	-	-	-	37	4.73	2.47	-	-	-	3.2	7.2	8.4	700	2300	2550	3.98	11.00	11.83	80	95	98	3.13		
	16	16	-	-	-	32	3.60	3.60	-	-	-	3.2	7.2	7.8	700	2300	2500	3.98	11.00	11.60	80	95	98	3.13		
	18	16	-	-	-	34	3.79	3.41	-	-	-	3.2	7.2	7.8	700	2300	2500	3.98	11.00	11.60	80	95	98	3.13		
	22	16	-	-	-	38	4.17	3.13	-	-	-	3.2	7.3	8.4	700	2400	2550	3.98	11.48	11.83	80	95	98	3.04		
	24	16	-	-	-	40	4.47	2.83	-	-	-	3.2	7.3	8.4	700	2400	2550	3.98	11.48	11.83	80	95	98	3.04		
	18	18	-	-	-	36	3.60	3.60	-	-	-	3.2	7.2	8.4	700	2300	2550	3.98	11.00	11.83	80	95	98	3.13		
	22	18	-	-	-	40	4.04	3.36	-	-	-	3.2	7.4	8.4	700	2400	2550	3.98	11.48	11.83	80	95	98	3.08		
	24	18	-	-	-	42	4.34	3.06	-	-	-	3.2	7.4	8.4	700	2400	2550	3.98	11.48	11.83	80	95	98	3.08		
	3 units	05	05	05	-	-	15	1.50	1.50	1.50	-	-	3.8	4.5	5.5	950	1070	1390	4.80	5.12	6.45	90	95	98	4.21	
		07	05	05	-	-	17	2.00	1.50	1.50	-	-	3.8	5.0	6.0	950	1180	1620	4.80	5.65	7.51	90	95	98	4.24	
		10	05	05	-	-	20	2.70	1.50	1.50	-	-	3.8	5.7	6.7	950	1480	1940	4.80	7.08	9.00	90	95	98	3.85	
13		05	05	-	-	23	3.59	1.46	1.46	-	-	3.8	6.5	8.0	950	1585	2540	4.80	7.58	11.78	90	95	98	4.10		
16		05	05	-	-	26	4.32	1.44	1.44	-	-	3.8	7.2	8.4	950	1885	2720	4.80	9.02	12.62	90	95	98	3.82		
18		05	05	-	-	28	4.63	1.39	1.39	-	-	3.8	7.4	8.6	950	1975	2750	4.80	9.45	12.76	90	95	98	3.75		
22		05	05	-	-	32	4.93	1.23	1.23	-	-	3.8	7.4	8.6	950	1975	2750	4.80	9.45	12.76	90	95	98	3.75		
24		05	05	-	-	34	5.20	1.10	1.10	-	-	3.8	7.4	8.6	950	1975	2750	4.80	9.45	12.76	90	95	98	3.75		
07		07	05	-	-	19	2.00	2.00	1.50	-	-	3.8	5.5	6.5	950	1290	1850	4.80	6.17	8.58	90	95	98	4.26		
10		07	05	-	-	22	2.70	2.00	1.50	-	-	3.8	6.2	7.3	950	1480	2220	4.80	7.08	10.30	90	95	98	4.19		
13		07	05	-	-	25	3.55	1.92	1.44	-	-	3.8	6.9	8.4	950	1750	2720	4.80	8.37	12.62	90	95	98	3.94		
16		07	05	-	-	28	4.16	1.85	1.39	-	-	3.8	7.4	8.6	950	1975	2750	4.80	9.45	12.76	90	95	98	3.75		
18		07	05	-	-	30	4.35	1.74	1.31	-	-	3.8	7.4	8.6	950	1975	2750	4.80	9.45	12.76	90	95	98	3.75		
22		07	05	-	-	34	4.67	1.56	1.17	-	-	3.8	7.4	8.8	950	1975	2770	4.80	9.45	12.85	90	95	98	3.75		
24		07	05	-	-	36	4.96	1.40	1.05	-	-	3.8	7.4	8.8	950	1975	2770	4.80	9.45	12.85	90	95	98	3.75		
10		10	05	-	-	25	2.70	2.70	1.50	-	-	3.8	6.9	8.4	950	1750	2720	4.80	8.37	12.62	90	95	98	3.94		
13		10	05	-	-	28	3.47	2.53	1.41	-	-	3.8	7.4	8.6	950	1975	2750	4.80	9.45	12.76	90	95	98	3.75		
16		10	05	-	-	31	3.83	2.30	1.28	-	-	3.8	7.4	8.6	950	1975	2750	4.80	9.45	12.76	90	95	98	3.75		
18		10	05	-	-	33	4.02	2.17	1.21	-	-	3.8	7.4	8.8	950	1975	2770	4.80	9.45	12.85	90	95	98	3.75		
22		10	05	-	-	37	4.35	1.96	1.09	-	-	3.8	7.4	8.8	950	1975	2770	4.80	9.45	12.85	90	95	98	3.75		
24		10	05	-	-	39	4.65	1.77	0.98	-	-	3.8	7.4	8.8	950	1975	2770	4.80	9.45	12.85	90	95	98	3.75		
13		13	05	-	-	31	3.08	3.08	1.25	-	-	3.8	7.4	8.6	950	1975	2750	4.80	9.45	12.76	90	95	98	3.75		
16		13	05	-	-	34	3.43	2.82	1.14	-	-	3.8	7.4	8.8	950	1975	2770	4.80	9.45	12.85	90	95	98	3.75		
18		13	05	-	-	36	3.63	2.68	1.09	-	-	3.8														



Operation mode : Cooling Power supply voltage : 220V

Operatin status	Indoor unit					Unit capacity (kW)					Cooling capacity (kW)			Power consumption (W)			Operating current (A)			Power factor (%)			EER	
	A	B	C	D	E	ΣkBTU	A	B	C	D	E	Min	Rate	Max	Min	Rate	Max	Min	Rate	Max	Min	Rate	Max	Rate
3 units (continued)	22	10	07	-	-	39	4.15	1.87	1.38	-	-	4.0	7.4	8.8	970	1975	2770	4.90	9.45	12.85	90	95	98	3.75
	24	10	07	-	-	41	4.45	1.69	1.25	-	-	4.0	7.4	8.8	970	1975	2770	4.90	9.45	12.85	90	95	98	3.75
	13	13	07	-	-	33	2.91	2.91	1.57	-	-	4.0	7.4	8.8	970	1975	2770	4.90	9.45	12.85	90	95	98	3.75
	16	13	07	-	-	36	3.26	2.68	1.45	-	-	4.0	7.4	8.8	970	1975	2770	4.90	9.45	12.85	90	95	98	3.75
	18	13	07	-	-	38	3.46	2.56	1.38	-	-	4.0	7.4	8.8	970	1975	2770	4.90	9.45	12.85	90	95	98	3.75
	22	13	07	-	-	42	3.79	2.34	1.26	-	-	4.0	7.4	8.8	970	1975	2770	4.90	9.45	12.85	90	95	98	3.75
	24	13	07	-	-	44	4.10	2.14	1.16	-	-	4.0	7.4	8.8	970	1975	2770	4.90	9.45	12.85	90	95	98	3.75
	16	16	07	-	-	39	3.03	3.03	1.35	-	-	4.0	7.4	8.8	970	1975	2770	4.90	9.45	12.85	90	95	98	3.75
	18	16	07	-	-	41	3.22	2.90	1.29	-	-	4.0	7.4	8.8	970	1975	2770	4.90	9.45	12.85	90	95	98	3.75
	22	16	07	-	-	45	3.60	2.70	1.20	-	-	4.1	7.5	9.0	980	2000	2800	4.95	9.57	12.99	90	95	98	3.75
	24	16	07	-	-	47	3.92	2.48	1.10	-	-	4.1	7.5	9.0	980	2000	2800	4.95	9.57	12.99	90	95	98	3.75
	10	10	10	-	-	30	2.47	2.47	2.47	-	-	3.9	7.4	8.6	960	1975	2750	4.85	9.45	12.76	90	95	98	3.75
	13	10	10	-	-	33	3.01	2.20	2.20	-	-	4.0	7.4	8.8	970	1975	2770	4.90	9.45	12.85	90	95	98	3.75
	16	10	10	-	-	36	3.36	2.02	2.02	-	-	4.0	7.4	8.8	970	1975	2770	4.90	9.45	12.85	90	95	98	3.75
	18	10	10	-	-	38	3.56	1.92	1.92	-	-	4.0	7.4	8.8	970	1975	2770	4.90	9.45	12.85	90	95	98	3.75
	22	10	10	-	-	42	3.89	1.75	1.75	-	-	4.0	7.4	8.8	970	1975	2770	4.90	9.45	12.85	90	95	98	3.75
	24	10	10	-	-	44	4.20	1.60	1.60	-	-	4.0	7.4	8.8	970	1975	2770	4.90	9.45	12.85	90	95	98	3.75
	13	13	10	-	-	36	2.71	2.71	1.98	-	-	4.0	7.4	8.8	970	1975	2770	4.90	9.45	12.85	90	95	98	3.75
	16	13	10	-	-	39	3.06	2.51	1.83	-	-	4.0	7.4	8.8	970	1975	2770	4.90	9.45	12.85	90	95	98	3.75
	18	13	10	-	-	41	3.25	2.40	1.75	-	-	4.0	7.4	8.8	970	1975	2770	4.90	9.45	12.85	90	95	98	3.75
	22	13	10	-	-	45	3.63	2.24	1.63	-	-	4.1	7.5	9.0	980	2000	2800	4.95	9.57	12.99	90	95	98	3.75
	24	13	10	-	-	47	3.94	2.06	1.50	-	-	4.1	7.5	9.0	980	2000	2800	4.95	9.57	12.99	90	95	98	3.75
	16	16	10	-	-	42	2.85	2.85	1.71	-	-	4.0	7.4	8.8	970	1975	2770	4.90	9.45	12.85	90	95	98	3.75
	18	16	10	-	-	44	3.03	2.73	1.64	-	-	4.0	7.4	8.8	970	1975	2770	4.90	9.45	12.85	90	95	98	3.75
	22	16	10	-	-	48	3.41	2.56	1.53	-	-	4.1	7.5	9.0	980	2000	2800	4.95	9.57	12.99	90	95	98	3.75
	24	16	10	-	-	50	3.72	2.36	1.42	-	-	4.1	7.5	9.0	980	2000	2800	4.95	9.57	12.99	90	95	98	3.75
	13	13	13	-	-	39	2.47	2.47	2.47	-	-	4.0	7.4	8.8	970	1975	2770	4.90	9.45	12.85	90	95	98	3.75
	16	13	13	-	-	42	2.80	2.30	2.30	-	-	4.0	7.4	8.8	970	1975	2770	4.90	9.45	12.85	90	95	98	3.75
	18	13	13	-	-	44	2.98	2.21	2.21	-	-	4.0	7.4	8.8	970	1975	2770	4.90	9.45	12.85	90	95	98	3.75
	22	13	13	-	-	48	3.36	2.07	2.07	-	-	4.1	7.5	9.0	980	2000	2800	4.95	9.57	12.99	90	95	98	3.75
	24	13	13	-	-	50	3.67	1.91	1.91	-	-	4.1	7.5	9.0	980	2000	2800	4.95	9.57	12.99	90	95	98	3.75
	16	16	13	-	-	45	2.66	2.66	2.19	-	-	4.1	7.5	9.0	980	2000	2800	4.95	9.57	12.99	90	95	98	3.75
	18	16	13	-	-	47	2.84	2.56	2.10	-	-	4.1	7.5	9.0	980	2000	2800	4.95	9.57	12.99	90	95	98	3.75
	22	16	13	-	-	51	3.17	2.38	1.95	-	-	4.1	7.5	9.0	980	2000	2800	4.95	9.57	12.99	90	95	98	3.75
	24	16	13	-	-	53	3.48	2.21	1.81	-	-	4.1	7.5	9.0	980	2000	2800	4.95	9.57	12.99	90	95	98	3.75
	16	16	16	-	-	48	2.50	2.50	2.50	-	-	4.1	7.5	9.0	980	2000	2800	4.95	9.57	12.99	90	95	98	3.75
	18	16	16	-	-	50	2.68	2.41	2.41	-	-	4.1	7.5	9.0	980	2000	2800	4.95	9.57	12.99	90	95	98	3.75
	22	16	16	-	-	54	3.00	2.25	2.25	-	-	4.1	7.5	9.0	980	2000	2800	4.95	9.57	12.99	90	95	98	3.75

\* Applicable FCU are "PKV" series and "BKV" series only.

• The above specification values are those under the conditions that the indoor DB/WB=27/19°C and the outdoor DB/WB=35/24°C.

Operation mode : Cooling

Power supply voltage : 230V

Operatin status	Indoor unit					Unit capacity (kW)					Cooling capacity (kW)			Power consumption (W)			Operating current (A)			Power factor (%)			EER	
	A	B	C	D	E	ΣkBTU	A	B	C	D	E	Min	Rate	Max	Min	Rate	Max	Min	Rate	Max	Min	Rate		Max
1 unit	05	-	-	-	-	5	1.50	-	-	-	-	1.4	1.5	2.0	630	640	650	3.60	3.61	3.32	76	77	85	2.34
	07	-	-	-	-	7	2.00	-	-	-	-	1.4	2.0	2.5	640	650	700	3.66	3.67	3.58	76	77	85	3.08
	10	-	-	-	-	10	2.70	-	-	-	-	1.4	2.7	3.2	640	750	950	3.66	4.23	4.44	76	77	93	3.60
	13	-	-	-	-	13	3.70	-	-	-	-	1.4	3.7	4.4	640	1200	1520	3.52	5.93	6.88	79	88	96	3.08
	16	-	-	-	-	16	4.50	-	-	-	-	1.4	4.5	5.0	640	1650	2000	3.52	7.63	8.87	79	94	98	2.73
	18	-	-	-	-	18	5.00	-	-	-	-	1.4	5.0	5.2	640	1950	2100	3.52	8.92	9.32	79	95	98	2.56
	22	-	-	-	-	22	6.00	-	-	-	-	2.4	6.0	6.8	640	2020	2500	3.52	9.24	11.09	79	95	98	2.97
	24	-	-	-	-	24	7.10	-	-	-	-	2.4	7.1	7.2	660	2390	2960	3.63	10.94	13.13	79	95	98	2.97
2 units	05	05	-	-	-	10	1.50	1.50	-	-	-	2.5	3.0	4.0	640	750	1000	3.48	3.43	4.44	80	95	98	4.00
	07	05	-	-	-	12	2.00	1.50	-	-	-	2.5	3.5	4.5	640	850	1200	3.48	3.89	5.32	80	95	98	4.12
	10	05	-	-	-	15	2.70	1.50	-	-	-	2.5	4.2	5.2	640	1100	1550	3.48	5.03	6.88	80	95	98	3.82
	13	05	-	-	-	18	3.70	1.50	-	-	-	2.5	5.2	6.0	640	1450	1950	3.48	6.64	8.65	80	95	98	3.59
	16	05	-	-	-	21	4.35	1.45	-	-	-	2.5	5.8	6.5	640	1700	2200	3.48	7.78	9.76	80	95	98	3.41
	18	05	-	-	-	23	4.54	1.36	-	-	-	2.5	5.9	6.6	640	1740	2250	3.48	7.96	9.98	80	95	98	3.39
	22	05	-	-	-	27	5.04	1.26	-	-	-	2.5	6.3	6.9	640	1900	2400	3.48	8.70	10.65	80	95	98	3.32
	24	05	-	-	-	29	5.20	1.10	-	-	-	2.5	6.3	6.9	640	1900	2400	3.48	8.70	10.65	80	95	98	3.32
	07	07	-	-	-	14	2.00	2.00	-	-	-	2.5	4.0	6.3	640	950	1900	3.48	4.35	8.43	80	95	98	4.21
	10	07	-	-	-	17	2.70	2.00	-	-	-	2.5	4.7	6.3	640	1200	2100	3.48	5.49	9.32	80	95	98	3.92
	13	07	-	-	-	20	3.70	2.00	-	-	-	2.6	5.7	6.5	660	1600	2220	3.59	7.32	9.85	80	95	98	3.56
	16	07	-	-	-	23	4.08	1.82	-	-	-	2.7	5.9	6.6	660	1700	2220	3.59	7.78	9.85	80	95	98	3.47
	18	07	-	-	-	25	4.50	1.80	-	-	-	2.9	6.3	6.9	670	1900	2400	3.64	8.70	10.65	80	95	98	3.32
	22	07	-	-	-	29	4.73	1.58	-	-	-	2.9	6.3	7.1	670	1900	2400	3.64	8.70	10.65	80	95	98	3.32
	24	07	-	-	-	31	5.31	1.49	-	-	-	3.0	6.8	7.4	690	2200	2450	3.75	10.07	10.87	80	95	98	3.09
	10	10	-	-	-	20	2.70	2.70	-	-	-	2.5	5.4	6.3	640	1500	2100	3.48	6.86	9.32	80	95	98	3.60
	13	10	-	-	-	23	3.41	2.49	-	-	-	2.7	5.9	6.6	660	1700	2220	3.59	7.78	9.85	80	95	98	3.47
	16	10	-	-	-	26	3.94	2.36	-	-	-	2.9	6.3	6.9	670	2000	2400	3.64	9.15	10.65	80	95	98	3.15
	18	10	-	-	-	28	4.09	2.21	-	-	-	2.9	6.3	7.1	670	1900	2400	3.64	8.70	10.65	80	95	98	3.32
	22	10	-	-	-	32	4.69	2.11	-	-	-	3.0	6.8	7.4	690	2200	2450	3.75	10.07	10.87	80	95	98	3.09
	24	10	-	-	-	34	5.22	1.98	-	-	-	3.2	7.2	7.8	700	2300	2500	3.80	10.53	11.09	80	95	98	3.13
	13	13	-	-	-	26	3.15	3.15	-	-	-	2.9	6.3	7.1	670	2000	2400	3.64	9.15	10.65	80	95	98	3.15
	16	13	-	-	-	29	3.73	3.07	-	-	-	3.0	6.8	7.4	690	2200	2450	3.75	10.07	10.87	80	95	98	3.09
	18	13	-	-	-	31	3.91	2.89	-	-	-	3.0	6.8	7.4	690	2200	2450	3.75	10.07	10.87	80	95	98	3.09
	22	13	-	-	-	35	4.45	2.75	-	-	-	3.2	7.2	7.8	700	2300	2500	3.80	10.53	11.09	80	95	98	3.13
	24	13	-	-	-	37	4.73	2.47	-	-	-	3.2	7.2	8.4	700	2300	2550	3.80	10.53	11.31	80	95	98	3.13
	16	16	-	-	-	32	3.60	3.60	-	-	-	3.2	7.2	7.8	700	2300	2500	3.80	10.53	11.09	80	95	98	3.13
	18	16	-	-	-	34	3.79	3.41	-	-	-	3.2	7.2	7.8	700	2300	2500	3.80	10.53	11.09	80	95	98	3.13
	22	16	-	-	-	38	4.17	3.13	-	-	-	3.2	7.3	8.4	700	2400	2550	3.80	10.98	11.31	80	95	98	3.04
	24	16	-	-	-	40	4.47	2.83	-	-	-	3.2	7.3	8.4	700	2400	2550	3.80	10.98	11.31	80	95	98	3.04
	18	18	-	-	-	36	3.60	3.60	-	-	-	3.2	7.2	8.4	700	2300	2550	3.80	10.53	11.31	80	95	98	3.13
	22	18	-	-	-	40	4.04	3.36	-	-	-	3.2	7.4	8.4	700	2400	2550	3.80	10.98	11.31	80	95	98	3.08
	24	18	-	-	-	42	4.34	3.06	-	-	-	3.2	7.4	8.4	700	2400	2550	3.80	10.98	11.31	80	95	98	3.08
	3 units	05	05	05	-	-	15	1.50	1.50	1.50	-	-	3.8	4.5	5.5	950	1070	1390	4.59	4.90	6.17	90	95	98
07		05	05	-	-	17	2.00	1.50	1.50	-	-	3.8	5.0	6.0	950	1180	1620	4.59	5.40	7.19	90	95	98	4.24
10		05	05	-	-	20	2.70	1.50	1.50	-	-	3.8	5.7	6.7	950	1480	1940	4.59	6.77	8.61	90	95	98	3.85
13		05	05	-	-	23	3.59	1.46	1.46	-	-	3.8	6.5	8.0	950	1585	2540	4.59	7.25	11.27	90	95	98	4.10
16		05	05	-	-	26	4.32	1.44	1.44	-	-	3.8	7.2	8.4	950	1885	2720	4.59	8.63	12.07	90	95	98	3.82
18		05	05	-	-	28	4.63	1.39	1.39	-	-	3.8	7.4	8.6	950	1975	2750	4.59	9.04	12.20	90	95	98	3.75
22		05	05	-	-	32	4.93	1.23	1.23	-	-	3.8	7.4	8.6	950	1975	2750	4.59	9.04	12.20	90	95	98	3.75
24		05	05	-	-	34	5.20	1.10	1.10	-	-	3.8	7.4	8.6	950	1975	2750	4.59	9.04	12.20	90	95	98	3.75
07		07	05	-	-	19	2.00	2.00	1.50	-	-	3.8	5.5	6.5	950	1290	1850	4.59	5.90	8.21	90	95	98	4.26
10		07	05	-	-	22	2.70	2.00	1.50	-	-	3.8	6.2	7.3	950	1480	2220	4.59	6.77	9.85	90	95	98	4.19
13		07	05	-	-	25	3.55	1.92	1.44	-	-	3.8	6.9	8.4	950	1750	2720	4.59	8.01	12.07	90	95	98	3.94
16		07	05	-	-	28	4.16	1.85	1.39	-	-	3.8	7.4	8.6	950	1975	2750	4.59	9.04	12.20	90	95	98	3.75
18		07	05	-	-	30	4.35	1.74	1.31	-	-	3.8	7.4	8.6	950	1975	2750	4.59	9.04	12.20	90	95	98	3.75
22		07	05	-	-	34	4.67	1.56	1.17	-	-	3.8	7.4	8.8	950	1975	2770	4.59	9.04	12.29	90	95	98	3.75
24		07	05	-	-	36	4.96	1.40	1.05	-	-	3.8	7.4	8.8	950	1975	2770	4.59	9.04	12.29	90	95	98	3.75
10		10	05	-	-	25	2.70	2.70	1.50	-	-	3.8	6.9	8.4	950	1750	2720	4.59	8.01	12.07	90	95	98	3.94
13		10	05	-	-	28	3.47	2.53	1.41	-	-	3.8	7.4	8.6	950	1975	2750	4.59	9.04	12.20	90	95	98	3.75
16		10	05	-	-	31	3.83	2.30	1.28	-	-	3.8	7.4	8.6	950	1975	2750	4.59	9.04	12.20	90	95	98	3.75
18		10	05	-	-	33	4.02	2.17	1.21	-	-	3.8	7.4	8.8	950	1975	2770	4.59	9.04	12.29	90	95	98	3.75
22		10	05	-	-	37	4.35	1.96	1.09	-	-	3.8	7.4	8.8	950	1975	2770	4.59	9.04	12.29	90	95	98	3.75
24		10	05	-	-	39	4.65	1.77	0.98	-	-	3.8	7.4	8.8	950	1975	2770	4.59	9.04	12.29	90	95	98	3.75
13		13	05	-	-	31	3.08	3.08	1.25	-	-	3.8	7.4	8.6	950	1975	2750	4.59	9.04	12.20	90	95	98	3.75
16		13	05	-	-	34	3.43	2.82	1.14	-	-	3.8	7.4	8.8	950	1975	2770	4.59	9.04	12.29	90	95	98	3.75

Operation mode : Cooling Power supply voltage : 230V

Operatin status	Indoor unit					Unit capacity (kW)					Cooling capacity (kW)			Power consumption (W)			Operating current (A)			Power factor (%)			EER	
	A	B	C	D	E	ΣkBTU	A	B	C	D	E	Min	Rate	Max	Min	Rate	Max	Min	Rate	Max	Min	Rate		Max
3 units (continued)	16	13	07	-	-	36	3.26	2.68	1.45	-	-	4.0	7.4	8.8	970	1975	2770	4.69	9.04	12.29	90	95	98	3.75
	18	13	07	-	-	38	3.46	2.56	1.38	-	-	4.0	7.4	8.8	970	1975	2770	4.69	9.04	12.29	90	95	98	3.75
	22	13	07	-	-	42	3.79	2.34	1.26	-	-	4.0	7.4	8.8	970	1975	2770	4.69	9.04	12.29	90	95	98	3.75
	24	13	07	-	-	44	4.10	2.14	1.16	-	-	4.0	7.4	8.8	970	1975	2770	4.69	9.04	12.29	90	95	98	3.75
	16	16	07	-	-	39	3.03	3.03	1.35	-	-	4.0	7.4	8.8	970	1975	2770	4.69	9.04	12.29	90	95	98	3.75
	18	16	07	-	-	41	3.22	2.90	1.29	-	-	4.0	7.4	8.8	970	1975	2770	4.69	9.04	12.29	90	95	98	3.75
	22	16	07	-	-	45	3.60	2.70	1.20	-	-	4.1	7.5	9.0	980	2000	2800	4.73	9.15	12.42	90	95	98	3.75
	24	16	07	-	-	47	3.92	2.48	1.10	-	-	4.1	7.5	9.0	980	2000	2800	4.73	9.15	12.42	90	95	98	3.75
	10	10	10	-	-	30	2.47	2.47	2.47	-	-	3.9	7.4	8.6	960	1975	2750	4.64	9.04	12.20	90	95	98	3.75
	13	10	10	-	-	33	3.01	2.20	2.20	-	-	4.0	7.4	8.8	970	1975	2770	4.69	9.04	12.29	90	95	98	3.75
	16	10	10	-	-	36	3.36	2.02	2.02	-	-	4.0	7.4	8.8	970	1975	2770	4.69	9.04	12.29	90	95	98	3.75
	18	10	10	-	-	38	3.56	1.92	1.92	-	-	4.0	7.4	8.8	970	1975	2770	4.69	9.04	12.29	90	95	98	3.75
	22	10	10	-	-	42	3.89	1.75	1.75	-	-	4.0	7.4	8.8	970	1975	2770	4.69	9.04	12.29	90	95	98	3.75
	24	10	10	-	-	44	4.20	1.60	1.60	-	-	4.0	7.4	8.8	970	1975	2770	4.69	9.04	12.29	90	95	98	3.75
	13	13	10	-	-	36	2.71	2.71	1.98	-	-	4.0	7.4	8.8	970	1975	2770	4.69	9.04	12.29	90	95	98	3.75
	16	13	10	-	-	39	3.06	2.51	1.83	-	-	4.0	7.4	8.8	970	1975	2770	4.69	9.04	12.29	90	95	98	3.75
	18	13	10	-	-	41	3.25	2.40	1.75	-	-	4.0	7.4	8.8	970	1975	2770	4.69	9.04	12.29	90	95	98	3.75
	22	13	10	-	-	45	3.63	2.24	1.63	-	-	4.1	7.5	9.0	980	2000	2800	4.73	9.15	12.42	90	95	98	3.75
	24	13	10	-	-	47	3.94	2.06	1.50	-	-	4.1	7.5	9.0	980	2000	2800	4.73	9.15	12.42	90	95	98	3.75
	16	16	10	-	-	42	2.85	2.85	1.71	-	-	4.0	7.4	8.8	970	1975	2770	4.69	9.04	12.29	90	95	98	3.75
	18	16	10	-	-	44	3.03	2.73	1.64	-	-	4.0	7.4	8.8	970	1975	2770	4.69	9.04	12.29	90	95	98	3.75
	22	16	10	-	-	48	3.41	2.56	1.53	-	-	4.1	7.5	9.0	980	2000	2800	4.73	9.15	12.42	90	95	98	3.75
	24	16	10	-	-	50	3.72	2.36	1.42	-	-	4.1	7.5	9.0	980	2000	2800	4.73	9.15	12.42	90	95	98	3.75
	13	13	13	-	-	39	2.47	2.47	2.47	-	-	4.0	7.4	8.8	970	1975	2770	4.69	9.04	12.29	90	95	98	3.75
	16	13	13	-	-	42	2.80	2.30	2.30	-	-	4.0	7.4	8.8	970	1975	2770	4.69	9.04	12.29	90	95	98	3.75
	18	13	13	-	-	44	2.98	2.21	2.21	-	-	4.0	7.4	8.8	970	1975	2770	4.69	9.04	12.29	90	95	98	3.75
	22	13	13	-	-	48	3.36	2.07	2.07	-	-	4.1	7.5	9.0	980	2000	2800	4.73	9.15	12.42	90	95	98	3.75
	24	13	13	-	-	50	3.67	1.91	1.91	-	-	4.1	7.5	9.0	980	2000	2800	4.73	9.15	12.42	90	95	98	3.75
	16	16	13	-	-	45	2.66	2.66	2.19	-	-	4.1	7.5	9.0	980	2000	2800	4.73	9.15	12.42	90	95	98	3.75
	18	16	13	-	-	47	2.84	2.56	2.10	-	-	4.1	7.5	9.0	980	2000	2800	4.73	9.15	12.42	90	95	98	3.75
	22	16	13	-	-	51	3.17	2.38	1.95	-	-	4.1	7.5	9.0	980	2000	2800	4.73	9.15	12.42	90	95	98	3.75
	24	16	13	-	-	53	3.48	2.21	1.81	-	-	4.1	7.5	9.0	980	2000	2800	4.73	9.15	12.42	90	95	98	3.75
	16	16	16	-	-	48	2.50	2.50	2.50	-	-	4.1	7.5	9.0	980	2000	2800	4.73	9.15	12.42	90	95	98	3.75
	18	16	16	-	-	50	2.68	2.41	2.41	-	-	4.1	7.5	9.0	980	2000	2800	4.73	9.15	12.42	90	95	98	3.75
	22	16	16	-	-	54	3.00	2.25	2.25	-	-	4.1	7.5	9.0	980	2000	2800	4.73	9.15	12.42	90	95	98	3.75

\* Applicable FCU are "PKV" series and "BKV" series only.

• The above specification values are those under the conditions that the indoor DB/WB=27/19°C and the outdoor DB/WB=35/24°C.

Operatin status	Operation mode : Cooling										Power supply voltage : 240V															
	Indoor unit						Unit capacity (kW)					Cooling capacity (kW)			Power consumption (W)			Operating current (A)			Power factor (%)			EER		
	A	B	C	D	E	ΣkBTU	A	B	C	D	E	Min	Rate	Max	Min	Rate	Max	Min	Rate	Max	Min	Rate	Max	Min	Rate	Max
1 unit	05	-	-	-	-	5	1.50	-	-	-	-	1.4	1.5	2.0	630	640	650	3.45	3.46	3.19	76	77	85	2.34		
	07	-	-	-	-	7	2.00	-	-	-	-	1.4	2.0	2.5	640	650	700	3.51	3.52	3.43	76	77	85	3.08		
	10	-	-	-	-	10	2.70	-	-	-	-	1.4	2.7	3.2	640	750	950	3.51	4.06	4.26	76	77	93	3.60		
	13	-	-	-	-	13	3.70	-	-	-	-	1.4	3.7	4.4	640	1200	1520	3.38	5.68	6.60	79	88	96	3.08		
	16	-	-	-	-	16	4.50	-	-	-	-	1.4	4.5	5.0	640	1650	2000	3.38	7.31	8.50	79	94	98	2.73		
	18	-	-	-	-	18	5.00	-	-	-	-	1.4	5.0	5.2	640	1950	2100	3.38	8.55	8.93	79	95	98	2.56		
	22	-	-	-	-	22	6.00	-	-	-	-	2.4	6.0	6.8	640	2020	2500	3.38	8.86	10.63	79	95	98	2.97		
	24	-	-	-	-	24	7.10	-	-	-	-	2.4	7.1	7.2	660	2390	2960	3.48	10.48	12.59	79	95	98	2.97		
2 units	05	05	-	-	-	10	1.50	1.50	-	-	-	2.5	3.0	4.0	640	750	1000	3.33	3.29	4.25	80	95	98	4.00		
	07	05	-	-	-	12	2.00	1.50	-	-	-	2.5	3.5	4.5	640	850	1200	3.33	3.73	5.10	80	95	98	4.12		
	10	05	-	-	-	15	2.70	1.50	-	-	-	2.5	4.2	5.2	640	1100	1550	3.33	4.82	6.59	80	95	98	3.82		
	13	05	-	-	-	18	3.70	1.50	-	-	-	2.5	5.2	6.0	640	1450	1950	3.33	6.36	8.29	80	95	98	3.59		
	16	05	-	-	-	21	4.35	1.45	-	-	-	2.5	5.8	6.5	640	1700	2200	3.33	7.46	9.35	80	95	98	3.41		
	18	05	-	-	-	23	4.54	1.36	-	-	-	2.5	5.9	6.6	640	1740	2250	3.33	7.63	9.57	80	95	98	3.39		
	22	05	-	-	-	27	5.04	1.26	-	-	-	2.5	6.3	6.9	640	1900	2400	3.33	8.33	10.20	80	95	98	3.32		
	24	05	-	-	-	29	5.20	1.10	-	-	-	2.5	6.3	6.9	640	1900	2400	3.33	8.33	10.20	80	95	98	3.32		
	07	07	-	-	-	14	2.00	2.00	-	-	-	2.5	4.0	6.3	640	950	1900	3.33	4.17	8.08	80	95	98	4.21		
	10	07	-	-	-	17	2.70	2.00	-	-	-	2.5	4.7	6.3	640	1200	2100	3.33	5.26	8.93	80	95	98	3.92		
	13	07	-	-	-	20	3.70	2.00	-	-	-	2.6	5.7	6.5	660	1600	2220	3.44	7.02	9.44	80	95	98	3.56		
	16	07	-	-	-	23	4.08	1.82	-	-	-	2.7	5.9	6.6	660	1700	2220	3.44	7.46	9.44	80	95	98	3.47		
	18	07	-	-	-	25	4.50	1.80	-	-	-	2.9	6.3	6.9	670	1900	2400	3.49	8.33	10.20	80	95	98	3.32		
	22	07	-	-	-	29	4.73	1.58	-	-	-	2.9	6.3	7.1	670	1900	2400	3.49	8.33	10.20	80	95	98	3.32		
	24	07	-	-	-	31	5.31	1.49	-	-	-	3.0	6.8	7.4	690	2200	2450	3.59	9.65	10.42	80	95	98	3.09		
	10	10	-	-	-	20	2.70	2.70	-	-	-	2.5	5.4	6.3	640	1500	2100	3.33	6.58	8.93	80	95	98	3.60		
	13	10	-	-	-	23	3.41	2.49	-	-	-	2.7	5.9	6.6	660	1700	2220	3.44	7.46	9.44	80	95	98	3.47		
	16	10	-	-	-	26	3.94	2.36	-	-	-	2.9	6.3	6.9	670	2000	2400	3.49	8.77	10.20	80	95	98	3.15		
	18	10	-	-	-	28	4.09	2.21	-	-	-	2.9	6.3	7.1	670	1900	2400	3.49	8.33	10.20	80	95	98	3.32		
	22	10	-	-	-	32	4.69	2.11	-	-	-	3.0	6.8	7.4	690	2200	2450	3.59	9.65	10.42	80	95	98	3.09		
	24	10	-	-	-	34	5.22	1.98	-	-	-	3.2	7.2	7.8	700	2300	2500	3.65	10.09	10.63	80	95	98	3.13		
	13	13	-	-	-	26	3.15	3.15	-	-	-	2.9	6.3	7.1	670	2000	2400	3.49	8.77	10.20	80	95	98	3.15		
	16	13	-	-	-	29	3.73	3.07	-	-	-	3.0	6.8	7.4	690	2200	2450	3.59	9.65	10.42	80	95	98	3.09		
	18	13	-	-	-	31	3.91	2.89	-	-	-	3.0	6.8	7.4	690	2200	2450	3.59	9.65	10.42	80	95	98	3.09		
	22	13	-	-	-	35	4.45	2.75	-	-	-	3.2	7.2	7.8	700	2300	2500	3.65	10.09	10.63	80	95	98	3.13		
	24	13	-	-	-	37	4.73	2.47	-	-	-	3.2	7.2	8.4	700	2300	2550	3.65	10.09	10.84	80	95	98	3.13		
	16	16	-	-	-	32	3.60	3.60	-	-	-	3.2	7.2	7.8	700	2300	2500	3.65	10.09	10.63	80	95	98	3.13		
	18	16	-	-	-	34	3.79	3.41	-	-	-	3.2	7.2	7.8	700	2300	2500	3.65	10.09	10.63	80	95	98	3.13		
	22	16	-	-	-	38	4.17	3.13	-	-	-	3.2	7.3	8.4	700	2400	2550	3.65	10.53	10.84	80	95	98	3.04		
	24	16	-	-	-	40	4.47	2.83	-	-	-	3.2	7.3	8.4	700	2400	2550	3.65	10.53	10.84	80	95	98	3.04		
	18	18	-	-	-	36	3.60	3.60	-	-	-	3.2	7.2	8.4	700	2300	2550	3.65	10.09	10.84	80	95	98	3.13		
	22	18	-	-	-	40	4.04	3.36	-	-	-	3.2	7.4	8.4	700	2400	2550	3.65	10.53	10.84	80	95	98	3.08		
24	18	-	-	-	42	4.34	3.06	-	-	-	3.2	7.4	8.4	700	2400	2550	3.65	10.53	10.84	80	95	98	3.08			
3 units	05	05	05	-	-	15	1.50	1.50	1.50	-	-	3.8	4.5	5.5	950	1070	1390	4.40	4.69	5.91	90	95	98	4.21		
	07	05	05	-	-	17	2.00	1.50	1.50	-	-	3.8	5.0	6.0	950	1180	1620	4.40	5.18	6.89	90	95	98	4.24		
	10	05	05	-	-	20	2.70	1.50	1.50	-	-	3.8	5.7	6.7	950	1480	1940	4.40	6.49	8.25	90	95	98	3.85		
	13	05	05	-	-	23	3.59	1.46	1.46	-	-	3.8	6.5	8.0	950	1585	2540	4.40	6.95	10.80	90	95	98	4.10		
	16	05	05	-	-	26	4.32	1.44	1.44	-	-	3.8	7.2	8.4	950	1885	2720	4.40	8.27	11.56	90	95	98	3.82		
	18	05	05	-	-	28	4.63	1.39	1.39	-	-	3.8	7.4	8.6	950	1975	2750	4.40	8.66	11.69	90	95	98	3.75		
	22	05	05	-	-	32	4.93	1.23	1.23	-	-	3.8	7.4	8.6	950	1975	2750	4.40	8.66	11.69	90	95	98	3.75		
	24	05	05	-	-	34	5.20	1.10	1.10	-	-	3.8	7.4	8.6	950	1975	2750	4.40	8.66	11.69	90	95	98	3.75		
	07	07	05	-	-	19	2.00	2.00	1.50	-	-	3.8	5.5	6.5	950	1290	1850	4.40	5.66	7.87	90	95	98	4.26		
	10	07	05	-	-	22	2.70	2.00	1.50	-	-	3.8	6.2	7.3	950	1480	2220	4.40	6.49	9.44	90	95	98	4.19		
	13	07	05	-	-	25	3.55	1.92	1.44	-	-	3.8	6.9	8.4	950	1750	2720	4.40	7.68	11.56	90	95	98	3.94		
	16	07	05	-	-	28	4.16	1.85	1.39	-	-	3.8	7.4	8.6	950	1975	2750	4.40	8.66	11.69	90	95	98	3.75		
	18	07	05	-	-	30	4.35	1.74	1.31	-	-	3.8	7.4	8.6	950	1975	2750	4.40	8.66	11.69	90	95	98	3.75		
	22	07	05	-	-	34	4.67	1.56	1.17	-	-	3.8	7.4	8.8	950	1975	2770	4.40	8.66	11.78	90	95	98	3.75		
	24	07	05	-	-	36	4.96	1.40	1.05	-	-	3.8	7.4	8.8	950	1975	2770	4.40	8.66	11.78	90	95	98	3.75		
	10	10	05	-	-	25	2.70	2.70	1.50	-	-	3.8	6.9	8.4	950	1750	2720	4.40	7.68	11.56	90	95	98	3.94		
	13	10	05	-	-	28	3.47	2.53	1.41	-	-	3.8	7.4	8.6	950	1975	2750	4.40	8.66	11.69	90	95	98	3.75		
	16	10	05	-	-	31	3.83	2.30	1.28	-	-	3.8	7.4	8.6	950	1975	2750	4.40	8.66	11.69	90	95	98	3.75		
	18	10	05	-	-	33	4.02	2.17	1.21	-	-	3.8	7.4	8.8	950	1975	2770	4.40	8.66	11.78	90	95	98	3.75		
	22	10	05	-	-	37	4.35	1.96	1.09	-	-	3.8	7.4	8.8	950	1975	2770	4.40	8.66	11.78	90	95	98	3.75		
	24	10	05	-	-	39	4.65	1.77	0.98	-	-	3.8	7.4	8.8	950	1975	2770	4.40	8.66	11.78	90	95	98	3.75		
	13	13	05	-	-	31	3.08	3.08	1.25	-	-	3.8	7.4	8.6	950	1975	2750	4.40	8.66	11.69	90	95	98	3.75		
	16	13	05	-	-	34	3.43	2.82	1.14	-	-	3.8	7.4	8.8	950	1975	2770	4.40	8.66	11.78	90	95	98	3.75		
	18	13	05	-	-	36																				

Operation mode : Cooling

Power supply voltage : 240V

Operatin status	Indoor unit					Unit capacity (kW)					Cooling capacity (kW)			Power consumption (W)			Operating current (A)			Power factor (%)			EER	
	A	B	C	D	E	ΣkBTU	A	B	C	D	E	Min	Rate	Max	Min	Rate	Max	Min	Rate	Max	Min	Rate		Max
3 units (continued)	16	13	07	-	-	36	3.26	2.68	1.45	-	-	4.0	7.4	8.8	970	1975	2770	4.49	8.66	11.78	90	95	98	3.75
	18	13	07	-	-	38	3.46	2.56	1.38	-	-	4.0	7.4	8.8	970	1975	2770	4.49	8.66	11.78	90	95	98	3.75
	22	13	07	-	-	42	3.79	2.34	1.26	-	-	4.0	7.4	8.8	970	1975	2770	4.49	8.66	11.78	90	95	98	3.75
	24	13	07	-	-	44	4.10	2.14	1.16	-	-	4.0	7.4	8.8	970	1975	2770	4.49	8.66	11.78	90	95	98	3.75
	16	16	07	-	-	39	3.03	3.03	1.35	-	-	4.0	7.4	8.8	970	1975	2770	4.49	8.66	11.78	90	95	98	3.75
	18	16	07	-	-	41	3.22	2.90	1.29	-	-	4.0	7.4	8.8	970	1975	2770	4.49	8.66	11.78	90	95	98	3.75
	22	16	07	-	-	45	3.60	2.70	1.20	-	-	4.1	7.5	9.0	980	2000	2800	4.54	8.77	11.90	90	95	98	3.75
	24	16	07	-	-	47	3.92	2.48	1.10	-	-	4.1	7.5	9.0	980	2000	2800	4.54	8.77	11.90	90	95	98	3.75
	10	10	10	-	-	30	2.47	2.47	2.47	-	-	3.9	7.4	8.6	960	1975	2750	4.44	8.66	11.69	90	95	98	3.75
	13	10	10	-	-	33	3.01	2.20	2.20	-	-	4.0	7.4	8.8	970	1975	2770	4.49	8.66	11.78	90	95	98	3.75
	16	10	10	-	-	36	3.36	2.02	2.02	-	-	4.0	7.4	8.8	970	1975	2770	4.49	8.66	11.78	90	95	98	3.75
	18	10	10	-	-	38	3.56	1.92	1.92	-	-	4.0	7.4	8.8	970	1975	2770	4.49	8.66	11.78	90	95	98	3.75
	22	10	10	-	-	42	3.89	1.75	1.75	-	-	4.0	7.4	8.8	970	1975	2770	4.49	8.66	11.78	90	95	98	3.75
	24	10	10	-	-	44	4.20	1.60	1.60	-	-	4.0	7.4	8.8	970	1975	2770	4.49	8.66	11.78	90	95	98	3.75
	13	13	10	-	-	36	2.71	2.71	1.98	-	-	4.0	7.4	8.8	970	1975	2770	4.49	8.66	11.78	90	95	98	3.75
	16	13	10	-	-	39	3.06	2.51	1.83	-	-	4.0	7.4	8.8	970	1975	2770	4.49	8.66	11.78	90	95	98	3.75
	18	13	10	-	-	41	3.25	2.40	1.75	-	-	4.0	7.4	8.8	970	1975	2770	4.49	8.66	11.78	90	95	98	3.75
	22	13	10	-	-	45	3.63	2.24	1.63	-	-	4.1	7.5	9.0	980	2000	2800	4.54	8.77	11.90	90	95	98	3.75
	24	13	10	-	-	47	3.94	2.06	1.50	-	-	4.1	7.5	9.0	980	2000	2800	4.54	8.77	11.90	90	95	98	3.75
	16	16	10	-	-	42	2.85	2.85	1.71	-	-	4.0	7.4	8.8	970	1975	2770	4.49	8.66	11.78	90	95	98	3.75
	18	16	10	-	-	44	3.03	2.73	1.64	-	-	4.0	7.4	8.8	970	1975	2770	4.49	8.66	11.78	90	95	98	3.75
	22	16	10	-	-	48	3.41	2.56	1.53	-	-	4.1	7.5	9.0	980	2000	2800	4.54	8.77	11.90	90	95	98	3.75
	24	16	10	-	-	50	3.72	2.36	1.42	-	-	4.1	7.5	9.0	980	2000	2800	4.54	8.77	11.90	90	95	98	3.75
	13	13	13	-	-	39	2.47	2.47	2.47	-	-	4.0	7.4	8.8	970	1975	2770	4.49	8.66	11.78	90	95	98	3.75
	16	13	13	-	-	42	2.80	2.30	2.30	-	-	4.0	7.4	8.8	970	1975	2770	4.49	8.66	11.78	90	95	98	3.75
	18	13	13	-	-	44	2.98	2.21	2.21	-	-	4.0	7.4	8.8	970	1975	2770	4.49	8.66	11.78	90	95	98	3.75
	22	13	13	-	-	48	3.36	2.07	2.07	-	-	4.1	7.5	9.0	980	2000	2800	4.54	8.77	11.90	90	95	98	3.75
	24	13	13	-	-	50	3.67	1.91	1.91	-	-	4.1	7.5	9.0	980	2000	2800	4.54	8.77	11.90	90	95	98	3.75
	16	16	13	-	-	45	2.66	2.66	2.19	-	-	4.1	7.5	9.0	980	2000	2800	4.54	8.77	11.90	90	95	98	3.75
	18	16	13	-	-	47	2.84	2.56	2.10	-	-	4.1	7.5	9.0	980	2000	2800	4.54	8.77	11.90	90	95	98	3.75
	22	16	13	-	-	51	3.17	2.38	1.95	-	-	4.1	7.5	9.0	980	2000	2800	4.54	8.77	11.90	90	95	98	3.75
	24	16	13	-	-	53	3.48	2.21	1.81	-	-	4.1	7.5	9.0	980	2000	2800	4.54	8.77	11.90	90	95	98	3.75
	16	16	16	-	-	48	2.50	2.50	2.50	-	-	4.1	7.5	9.0	980	2000	2800	4.54	8.77	11.90	90	95	98	3.75
	18	16	16	-	-	50	2.68	2.41	2.41	-	-	4.1	7.5	9.0	980	2000	2800	4.54	8.77	11.90	90	95	98	3.75
	22	16	16	-	-	54	3.00	2.25	2.25	-	-	4.1	7.5	9.0	980	2000	2800	4.54	8.77	11.90	90	95	98	3.75

\* Applicable FCU are "PKV" series and "BKV" series only.

• The above specification values are those under the conditions that the indoor DB/WB=27/19°C and the outdoor DB/WB=35/24°C.

Operation mode : Heating Power supply voltage : 220V

Table with columns: Operatin status, Indoor unit (A-E, ΣkBTU), Unit capacity (kW) (A-E), Heating capacity (kW) (Min, Rate, Max), Power consumption (W) (Min, Rate, Max), Operating current (A) (Min, Rate, Max), Power factor (%), COP. Rows are categorized by unit status (1 unit, 2 units, 3 units) and include various model and load configurations.

\* Applicable FCU are "PKV" series and "BKV" series only.

• The above specification values are those under the conditions that the indoor DB/WB=20/-°C and the outdoor DB/WB=7/6°C.

Operation mode : Heating Power supply voltage : 220V

Operatin status	Indoor unit					Unit capacity (kW)					Heating capacity (kW)			Power consumption (W)			Operating current (A)			Power factor (%)			COP Rate	
	A	B	C	D	E	ΣkBTU	A	B	C	D	E	Min	Rate	Max	Min	Rate	Max	Min	Rate	Max	Min	Rate		Max
3 units (continued)	16	13	07	-	-	36	3.71	3.37	1.82	-	-	2.0	8.9	11.0	380	2175	2830	2.16	10.41	13.13	80	95	98	4.09
	18	13	07	-	-	38	3.90	3.25	1.75	-	-	2.0	8.9	11.0	380	2175	2830	2.16	10.41	13.13	80	95	98	4.09
	22	13	07	-	-	42	4.24	3.03	1.63	-	-	2.0	8.9	11.0	380	2175	2830	2.16	10.41	13.13	80	95	98	4.09
	24	13	07	-	-	44	4.56	2.82	1.52	-	-	2.0	8.9	11.0	380	2175	2830	2.16	10.41	13.13	80	95	98	4.09
	16	16	07	-	-	39	3.57	3.57	1.75	-	-	2.0	8.9	11.0	380	2175	2830	2.16	10.41	13.13	80	95	98	4.09
	18	16	07	-	-	41	3.76	3.45	1.69	-	-	2.0	8.9	11.0	380	2175	2830	2.16	10.41	13.13	80	95	98	4.09
	22	16	07	-	-	45	4.14	3.26	1.60	-	-	2.0	9.0	11.2	380	2200	2900	2.16	10.53	13.45	80	95	98	4.09
	24	16	07	-	-	47	4.47	3.04	1.49	-	-	2.0	9.0	11.2	380	2200	2900	2.16	10.53	13.45	80	95	98	4.09
	10	10	10	-	-	30	2.97	2.97	2.97	-	-	2.0	8.9	10.8	380	2175	2750	2.16	10.41	12.76	80	95	98	4.09
	13	10	10	-	-	33	3.42	2.74	2.74	-	-	2.0	8.9	11.0	380	2175	2830	2.16	10.41	13.13	80	95	98	4.09
	16	10	10	-	-	36	3.63	2.64	2.64	-	-	2.0	8.9	11.0	380	2175	2830	2.16	10.41	13.13	80	95	98	4.09
	18	10	10	-	-	38	3.81	2.54	2.54	-	-	2.0	8.9	11.0	380	2175	2830	2.16	10.41	13.13	80	95	98	4.09
	22	10	10	-	-	42	4.15	2.37	2.37	-	-	2.0	8.9	11.0	380	2175	2830	2.16	10.41	13.13	80	95	98	4.09
	24	10	10	-	-	44	4.48	2.21	2.21	-	-	2.0	8.9	11.0	380	2175	2830	2.16	10.41	13.13	80	95	98	4.09
	13	13	10	-	-	36	3.18	3.18	2.54	-	-	2.0	8.9	11.0	380	2175	2830	2.16	10.41	13.13	80	95	98	4.09
	16	13	10	-	-	39	3.38	3.07	2.46	-	-	2.0	8.9	11.0	380	2175	2830	2.16	10.41	13.13	80	95	98	4.09
	18	13	10	-	-	41	3.56	2.97	2.37	-	-	2.0	8.9	11.0	380	2175	2830	2.16	10.41	13.13	80	95	98	4.09
	22	13	10	-	-	45	3.94	2.81	2.25	-	-	2.0	9.0	11.2	380	2200	2900	2.16	10.53	13.45	80	95	98	4.09
	24	13	10	-	-	47	4.26	2.63	2.11	-	-	2.0	9.0	11.2	380	2200	2900	2.16	10.53	13.45	80	95	98	4.09
	16	16	10	-	-	42	3.26	3.26	2.37	-	-	2.0	8.9	11.0	380	2175	2830	2.16	10.41	13.13	80	95	98	4.09
	18	16	10	-	-	44	3.45	3.16	2.30	-	-	2.0	8.9	11.0	380	2175	2830	2.16	10.41	13.13	80	95	98	4.09
	22	16	10	-	-	48	3.82	3.00	2.18	-	-	2.0	9.0	11.2	380	2200	2900	2.16	10.53	13.45	80	95	98	4.09
	24	16	10	-	-	50	4.14	2.81	2.05	-	-	2.0	9.0	11.2	380	2200	2900	2.16	10.53	13.45	80	95	98	4.09
	13	13	13	-	-	39	2.97	2.97	2.97	-	-	2.0	8.9	11.0	380	2175	2830	2.16	10.41	13.13	80	95	98	4.09
	16	13	13	-	-	42	3.16	2.87	2.87	-	-	2.0	8.9	11.0	380	2175	2830	2.16	10.41	13.13	80	95	98	4.09
	18	13	13	-	-	44	3.34	2.78	2.78	-	-	2.0	8.9	11.0	380	2175	2830	2.16	10.41	13.13	80	95	98	4.09
	22	13	13	-	-	48	3.71	2.65	2.65	-	-	2.0	9.0	11.2	380	2200	2900	2.16	10.53	13.45	80	95	98	4.09
	24	13	13	-	-	50	4.03	2.49	2.49	-	-	2.0	9.0	11.2	380	2200	2900	2.16	10.53	13.45	80	95	98	4.09
16	16	13	-	-	45	3.09	3.09	2.81	-	-	2.0	9.0	11.2	380	2200	2900	2.16	10.53	13.45	80	95	98	4.09	
18	16	13	-	-	47	3.27	3.00	2.73	-	-	2.0	9.0	11.2	380	2200	2900	2.16	10.53	13.45	80	95	98	4.09	
22	16	13	-	-	51	3.60	2.83	2.57	-	-	2.0	9.0	11.2	380	2200	2900	2.16	10.53	13.45	80	95	98	4.09	
24	16	13	-	-	53	3.92	2.66	2.42	-	-	2.0	9.0	11.2	380	2200	2900	2.16	10.53	13.45	80	95	98	4.09	
16	16	16	-	-	48	3.00	3.00	3.00	-	-	2.0	9.0	11.2	380	2200	2900	2.16	10.53	13.45	80	95	98	4.09	
18	16	16	-	-	50	3.18	2.91	2.91	-	-	2.0	9.0	11.2	380	2200	2900	2.16	10.53	13.45	80	95	98	4.09	
22	16	16	-	-	54	3.50	2.75	2.75	-	-	2.0	9.0	11.2	380	2200	2900	2.16	10.53	13.45	80	95	98	4.09	

\* Applicable FCU are "PKV" series and "BKV" series only.

• The above specification values are those under the conditions that the indoor DB/WB=20/-°C and the outdoor DB/WB=7/6°C.

Operation mode : Heating Power supply voltage : 230V

Operatin status	Indoor unit						Unit capacity (kW)					Heating capacity (kW)			Power consumption (W)			Operating current (A)			Power factor (%)			COP Rate		
	A	B	C	D	E	ΣkBTU	A	B	C	D	E	Min	Rate	Max	Min	Rate	Max	Min	Rate	Max	Min	Rate	Max		Min	Rate
1 unit	05	-	-	-	-	5	2.00	-	-	-	-	0.8	2.0	2.7	300	600	900	1.79	3.00	3.99	73	87	98	98	3.33	
	07	-	-	-	-	7	2.70	-	-	-	-	0.8	2.7	4.8	300	900	1980	1.79	4.50	8.78	73	87	98	98	3.00	
	10	-	-	-	-	10	4.00	-	-	-	-	0.8	4.0	5.2	300	1450	1980	1.79	6.64	8.78	73	95	98	98	2.76	
	13	-	-	-	-	13	5.00	-	-	-	-	0.8	5.0	6.5	310	2050	2750	1.85	9.38	12.20	73	95	98	98	2.44	
	16	-	-	-	-	16	5.50	-	-	-	-	0.8	5.5	6.9	310	2400	3000	1.85	10.98	13.31	73	95	98	98	2.29	
	18	-	-	-	-	18	6.00	-	-	-	-	0.8	6.0	7.1	310	2630	3200	1.85	12.04	14.20	73	95	98	98	2.28	
	22	-	-	-	-	22	7.00	-	-	-	-	1.8	7.0	8.2	330	2620	3200	1.97	11.99	14.20	73	95	98	98	2.67	
24	-	-	-	-	24	8.10	-	-	-	-	1.8	8.1	8.6	330	3080	3300	1.97	14.10	14.64	73	95	98	98	2.63		
2 units	05 05	-	-	-	-	10	2.00	2.00	-	-	-	2.0	4.0	6.4	320	850	1400	1.86	3.89	6.21	75	95	98	98	4.71	
	07 05	-	-	-	-	12	2.70	2.00	-	-	-	2.0	4.7	6.9	320	1050	1540	1.86	4.81	6.83	75	95	98	98	4.48	
	10 05	-	-	-	-	15	4.00	2.00	-	-	-	2.0	6.0	7.4	320	1350	1680	1.86	6.18	7.45	75	95	98	98	4.44	
	13 05	-	-	-	-	18	5.00	2.00	-	-	-	2.0	7.0	8.9	320	1560	2120	1.86	7.14	9.41	75	95	98	98	4.49	
	16 05	-	-	-	-	21	5.50	2.00	-	-	-	2.0	7.5	9.5	320	1700	2300	1.86	7.78	10.20	75	95	98	98	4.41	
	18 05	-	-	-	-	23	5.70	1.90	-	-	-	2.0	7.6	9.8	320	1850	2400	1.86	8.47	10.65	75	95	98	98	4.11	
	22 05	-	-	-	-	27	5.99	1.71	-	-	-	2.0	7.7	11.2	320	1980	2760	1.86	9.06	12.24	75	95	98	98	3.89	
	24 05	-	-	-	-	29	6.34	1.56	-	-	-	2.0	7.9	11.2	320	1980	2770	1.86	9.06	12.29	75	95	98	98	3.99	
	07 07	-	-	-	-	14	2.70	2.70	-	-	-	1.5	5.4	7.4	320	1400	2900	1.86	6.41	12.87	75	95	98	98	3.86	
	10 07	-	-	-	-	17	4.00	2.70	-	-	-	1.5	6.7	8.9	320	1950	3050	1.86	8.92	13.53	75	95	98	98	3.44	
	13 07	-	-	-	-	20	4.81	2.59	-	-	-	1.5	7.4	9.5	320	2300	3200	1.86	10.53	14.20	75	95	98	98	3.22	
	16 07	-	-	-	-	23	5.10	2.50	-	-	-	1.5	7.6	9.5	320	2300	3200	1.86	10.53	14.20	75	95	98	98	3.30	
	18 07	-	-	-	-	25	5.45	2.45	-	-	-	1.5	7.9	9.5	320	2450	3200	1.86	11.21	14.20	75	95	98	98	3.22	
	22 07	-	-	-	-	29	5.70	2.20	-	-	-	1.5	7.9	9.8	320	2450	3200	1.86	11.21	14.20	75	95	98	98	3.22	
	24 07	-	-	-	-	31	6.23	2.08	-	-	-	1.5	8.3	10.1	320	2500	3250	1.86	11.44	14.42	75	95	98	98	3.32	
	10 10	-	-	-	-	20	3.60	3.60	-	-	-	1.5	7.2	9.5	320	2200	3200	1.86	10.07	14.20	75	95	98	98	3.27	
	13 10	-	-	-	-	23	4.22	3.38	-	-	-	1.5	7.6	9.5	320	2300	3200	1.86	10.53	14.20	75	95	98	98	3.30	
	16 10	-	-	-	-	26	4.57	3.33	-	-	-	1.5	7.9	9.5	320	2450	3200	1.86	11.21	14.20	75	95	98	98	3.22	
	18 10	-	-	-	-	28	4.74	3.16	-	-	-	1.5	7.9	9.8	320	2450	3200	1.86	11.21	14.20	75	95	98	98	3.22	
	22 10	-	-	-	-	32	5.28	3.02	-	-	-	1.5	8.3	10.1	320	2500	3250	1.86	11.44	14.42	75	95	98	98	3.32	
	24 10	-	-	-	-	34	5.76	2.84	-	-	-	1.5	8.6	10.4	320	2550	3250	1.86	11.67	14.42	75	95	98	98	3.37	
	13 13	-	-	-	-	26	3.95	3.95	-	-	-	1.5	7.9	9.8	320	2450	3200	1.86	11.21	14.20	75	95	98	98	3.22	
	16 13	-	-	-	-	29	4.35	3.95	-	-	-	1.5	8.3	10.1	320	2500	3250	1.86	11.44	14.42	75	95	98	98	3.32	
	18 13	-	-	-	-	31	4.53	3.77	-	-	-	1.5	8.3	10.1	320	2500	3250	1.86	11.44	14.42	75	95	98	98	3.32	
	22 13	-	-	-	-	35	5.02	3.58	-	-	-	1.5	8.6	10.4	320	2550	3250	1.86	11.67	14.42	75	95	98	98	3.37	
	24 13	-	-	-	-	37	5.32	3.28	-	-	-	1.5	8.6	10.8	320	2550	3250	1.86	11.67	14.42	75	95	98	98	3.37	
	16 16	-	-	-	-	32	4.30	4.30	-	-	-	1.5	8.6	10.4	320	2550	3250	1.86	11.67	14.42	75	95	98	98	3.37	
	18 16	-	-	-	-	34	4.49	4.11	-	-	-	1.5	8.6	10.4	320	2550	3250	1.86	11.67	14.42	75	95	98	98	3.37	
	22 16	-	-	-	-	38	4.82	3.78	-	-	-	1.5	8.6	10.8	320	2550	3250	1.86	11.67	14.42	75	95	98	98	3.37	
	24 16	-	-	-	-	40	5.12	3.48	-	-	-	1.5	8.6	10.8	320	2550	3250	1.86	11.67	14.42	75	95	98	98	3.37	
	18 18	-	-	-	-	36	4.30	4.30	-	-	-	1.5	8.6	10.8	320	2550	3250	1.86	11.67	14.42	75	95	98	98	3.37	
	22 18	-	-	-	-	40	4.63	3.97	-	-	-	1.5	8.6	10.8	320	2550	3250	1.86	11.67	14.42	75	95	98	98	3.37	
	24 18	-	-	-	-	42	4.94	3.66	-	-	-	1.5	8.6	10.8	320	2550	3250	1.86	11.67	14.42	75	95	98	98	3.37	
	3 units	05 05 05	-	-	-	-	15	2.00	2.00	2.00	-	-	2.0	6.0	9.5	380	1220	1400	2.07	5.58	6.21	80	95	98	98	4.92
		07 05 05	-	-	-	-	17	2.70	2.00	2.00	-	-	2.0	6.7	10.0	380	1400	1540	2.07	6.41	6.83	80	95	98	98	4.79
		10 05 05	-	-	-	-	20	4.00	2.00	2.00	-	-	2.0	8.0	10.8	380	1850	1680	2.07	8.47	7.45	80	95	98	98	4.32
13 05 05		-	-	-	-	23	4.94	1.98	1.98	-	-	2.0	8.9	11.2	380	2180	1790	2.07	9.98	7.94	80	95	98	98	4.08	
16 05 05		-	-	-	-	26	5.15	1.87	1.87	-	-	2.0	8.9	11.2	380	2180	2400	2.07	9.98	10.65	80	95	98	98	4.08	
18 05 05		-	-	-	-	28	4.80	1.60	1.60	-	-	2.0	8.0	10.8	380	1850	2730	2.07	8.47	12.11	80	95	98	98	4.32	
22 05 05		-	-	-	-	32	5.66	1.62	1.62	-	-	2.0	8.9	11.2	380	2180	2870	2.07	9.98	12.73	80	95	98	98	4.08	
24 05 05		-	-	-	-	34	5.96	1.47	1.47	-	-	2.0	8.9	11.2	380	2180	2770	2.07	9.98	12.29	80	95	98	98	4.08	
07 07 05		-	-	-	-	19	2.70	2.70	2.00	-	-	2.0	7.4	10.8	380	1600	1680	2.07	7.32	7.45	80	95	98	98	4.63	
10 07 05		-	-	-	-	22	4.00	2.70	2.00	-	-	2.0	8.7	11.2	380	2180	2120	2.07	9.98	9.41	80	95	98	98	3.99	
13 07 05		-	-	-	-	25	4.59	2.48	1.84	-	-	2.0	8.9	11.2	380	2180	2400	2.07	9.98	10.65	80	95	98	98	4.08	
16 07 05		-	-	-	-	28	4.80	2.36	1.75	-	-	2.0	8.9	11.2	380	2180	2730	2.07	9.98	12.11	80	95	98	98	4.08	
18 07 05		-	-	-	-	30	4.99	2.25	1.66	-	-	2.0	8.9	11.2	380	2180	2730	2.07	9.98	12.11	80	95	98	98	4.08	
22 07 05		-	-	-	-	34	5.32	2.05	1.52	-	-	2.0	8.9	11.2	380	2180	2770	2.07	9.98	12.29	80	95	98	98	4.08	
24 07 05		-	-	-	-	36	5.63	1.88	1.39	-	-	2.0	8.9	11.2	380	2180	2780	2.07	9.98	12.33	80	95	98	98	4.08	
10 10 05		-	-	-	-	25	3.56	3.56	1.78	-	-	2.0	8.9	11.2	380	2180	2730	2.07	9.98	12.11	80	95	98	98	4.08	
13 10 05		-	-	-	-	28	4.05	3.24	1.62	-	-	2.0	8.9	11.2	380	2180	2870	2.07	9.98	12.73	80	95	98	98	4.08	
16 10 05		-	-	-	-	31	4.26	3.10	1.55	-	-	2.0	8.9	11.2	380	2180	2770	2.07	9.98	12.29	80	95	98	98	4.08	
18 10 05		-	-	-	-	33	4.45	2.97	1.48	-	-	2.0	8.9	11.2	380	2180	2770	2.07	9.98	12.29	80	95	98	98	4.08	
22 10 05		-	-	-	-	37	4.79	2.74	1.37	-	-	2.0	8.9	11.2	380	2180	2780	2.07	9.98	12.33	80	95	98	98	4.08	
24 10 05		-	-	-	-	39	5.11	2.52	1.26	-	-	2.0	8.9	11.2	380	2180	2790	2.07	9.98	12.38	80	95	98	98	4.08	



Operation mode : Heating Power supply voltage : 230V

Operatin status	Indoor unit					Unit capacity (kW)					Heating capacity (kW)			Power consumption (W)			Operating current (A)			Power factor (%)			COP Rate		
	A	B	C	D	E	ΣkBTU	A	B	C	D	E	Min	Rate	Max	Min	Rate	Max	Min	Rate	Max	Min	Rate		Max	Min
3 units (continued)	16	13	07	-	-	36	3.71	3.37	1.82	-	-	2.0	8.9	11.0	380	2175	2830	2.07	9.95	12.56	80	95	98	4.09	
	18	13	07	-	-	38	3.90	3.25	1.75	-	-	2.0	8.9	11.0	380	2175	2830	2.07	9.95	12.56	80	95	98	4.09	
	22	13	07	-	-	42	4.24	3.03	1.63	-	-	2.0	8.9	11.0	380	2175	2830	2.07	9.95	12.56	80	95	98	4.09	
	24	13	07	-	-	44	4.56	2.82	1.52	-	-	2.0	8.9	11.0	380	2175	2830	2.07	9.95	12.56	80	95	98	4.09	
	16	16	07	-	-	39	3.57	3.57	1.75	-	-	2.0	8.9	11.0	380	2175	2830	2.07	9.95	12.56	80	95	98	4.09	
	18	16	07	-	-	41	3.76	3.45	1.69	-	-	2.0	8.9	11.0	380	2175	2830	2.07	9.95	12.56	80	95	98	4.09	
	22	16	07	-	-	45	4.14	3.26	1.60	-	-	2.0	9.0	11.2	380	2200	2900	2.07	10.07	12.87	80	95	98	4.09	
	24	16	07	-	-	47	4.47	3.04	1.49	-	-	2.0	9.0	11.2	380	2200	2900	2.07	10.07	12.87	80	95	98	4.09	
	10	10	10	-	-	30	2.97	2.97	2.97	-	-	2.0	8.9	10.8	380	2175	2750	2.07	9.95	12.20	80	95	98	4.09	
	13	10	10	-	-	33	3.42	2.74	2.74	-	-	2.0	8.9	11.0	380	2175	2830	2.07	9.95	12.56	80	95	98	4.09	
	16	10	10	-	-	36	3.63	2.64	2.64	-	-	2.0	8.9	11.0	380	2175	2830	2.07	9.95	12.56	80	95	98	4.09	
	18	10	10	-	-	38	3.81	2.54	2.54	-	-	2.0	8.9	11.0	380	2175	2830	2.07	9.95	12.56	80	95	98	4.09	
	22	10	10	-	-	42	4.15	2.37	2.37	-	-	2.0	8.9	11.0	380	2175	2830	2.07	9.95	12.56	80	95	98	4.09	
	24	10	10	-	-	44	4.48	2.21	2.21	-	-	2.0	8.9	11.0	380	2175	2830	2.07	9.95	12.56	80	95	98	4.09	
	13	13	10	-	-	36	3.18	3.18	2.54	-	-	2.0	8.9	11.0	380	2175	2830	2.07	9.95	12.56	80	95	98	4.09	
	16	13	10	-	-	39	3.38	3.07	2.46	-	-	2.0	8.9	11.0	380	2175	2830	2.07	9.95	12.56	80	95	98	4.09	
	18	13	10	-	-	41	3.56	2.97	2.37	-	-	2.0	8.9	11.0	380	2175	2830	2.07	9.95	12.56	80	95	98	4.09	
	22	13	10	-	-	45	3.94	2.81	2.25	-	-	2.0	9.0	11.2	380	2200	2900	2.07	10.07	12.87	80	95	98	4.09	
	24	13	10	-	-	47	4.26	2.63	2.11	-	-	2.0	9.0	11.2	380	2200	2900	2.07	10.07	12.87	80	95	98	4.09	
	16	16	10	-	-	42	3.26	3.26	2.37	-	-	2.0	8.9	11.0	380	2175	2830	2.07	9.95	12.56	80	95	98	4.09	
	18	16	10	-	-	44	3.45	3.16	2.30	-	-	2.0	8.9	11.0	380	2175	2830	2.07	9.95	12.56	80	95	98	4.09	
	22	16	10	-	-	48	3.82	3.00	2.18	-	-	2.0	9.0	11.2	380	2200	2900	2.07	10.07	12.87	80	95	98	4.09	
	24	16	10	-	-	50	4.14	2.81	2.05	-	-	2.0	9.0	11.2	380	2200	2900	2.07	10.07	12.87	80	95	98	4.09	
	13	13	13	-	-	39	2.97	2.97	2.97	-	-	2.0	8.9	11.0	380	2175	2830	2.07	9.95	12.56	80	95	98	4.09	
	16	13	13	-	-	42	3.16	2.87	2.87	-	-	2.0	8.9	11.0	380	2175	2830	2.07	9.95	12.56	80	95	98	4.09	
	18	13	13	-	-	44	3.34	2.78	2.78	-	-	2.0	8.9	11.0	380	2175	2830	2.07	9.95	12.56	80	95	98	4.09	
	22	13	13	-	-	48	3.71	2.65	2.65	-	-	2.0	9.0	11.2	380	2200	2900	2.07	10.07	12.87	80	95	98	4.09	
	24	13	13	-	-	50	4.03	2.49	2.49	-	-	2.0	9.0	11.2	380	2200	2900	2.07	10.07	12.87	80	95	98	4.09	
16	16	13	-	-	45	3.09	3.09	2.81	-	-	2.0	9.0	11.2	380	2200	2900	2.07	10.07	12.87	80	95	98	4.09		
18	16	13	-	-	47	3.27	3.00	2.73	-	-	2.0	9.0	11.2	380	2200	2900	2.07	10.07	12.87	80	95	98	4.09		
22	16	13	-	-	51	3.60	2.83	2.57	-	-	2.0	9.0	11.2	380	2200	2900	2.07	10.07	12.87	80	95	98	4.09		
24	16	13	-	-	53	3.92	2.66	2.42	-	-	2.0	9.0	11.2	380	2200	2900	2.07	10.07	12.87	80	95	98	4.09		
16	16	16	-	-	48	3.00	3.00	3.00	-	-	2.0	9.0	11.2	380	2200	2900	2.07	10.07	12.87	80	95	98	4.09		
18	16	16	-	-	50	3.18	2.91	2.91	-	-	2.0	9.0	11.2	380	2200	2900	2.07	10.07	12.87	80	95	98	4.09		
22	16	16	-	-	54	3.50	2.75	2.75	-	-	2.0	9.0	11.2	380	2200	2900	2.07	10.07	12.87	80	95	98	4.09		

\* Applicable FCU are "PKV" series and "BKV" series only.

• The above specification values are those under the conditions that the indoor DB/WB=20/-°C and the outdoor DB/WB=7/6°C.

Operation mode : Heating Power supply voltage : 240V

Operatin status	Indoor unit						Unit capacity (kW)					Heating capacity (kW)			Power consumption (W)			Operating current (A)			Power factor (%)		COP Rate		
	A	B	C	D	E	ΣkBTU	A	B	C	D	E	Min	Rate	Max	Min	Rate	Max	Min	Rate	Max	Min	Rate		Max	Min
1 unit	05	-	-	-	-	5	2.00	-	-	-	-	0.8	2.0	2.7	300	600	900	1.71	2.87	3.83	73	87	98	3.33	
	07	-	-	-	-	7	2.70	-	-	-	-	0.8	2.7	4.8	300	900	1980	1.71	4.31	8.42	73	87	98	3.00	
	10	-	-	-	-	10	4.00	-	-	-	-	0.8	4.0	5.2	300	1450	1980	1.71	6.36	8.42	73	95	98	2.76	
	13	-	-	-	-	13	5.00	-	-	-	-	0.8	5.0	6.5	310	2050	2750	1.77	8.99	11.69	73	95	98	2.44	
	16	-	-	-	-	16	5.50	-	-	-	-	0.8	5.5	6.9	310	2400	3000	1.77	10.53	12.76	73	95	98	2.29	
	18	-	-	-	-	18	6.00	-	-	-	-	0.8	6.0	7.1	310	2630	3200	1.77	11.54	13.61	73	95	98	2.28	
	22	-	-	-	-	22	7.00	-	-	-	-	1.8	7.0	8.2	330	2620	3200	1.88	11.49	13.61	73	95	98	2.67	
	24	-	-	-	-	24	8.10	-	-	-	-	1.8	8.1	8.6	330	3080	3300	1.88	13.51	14.03	73	95	98	2.63	
2 units	05	05	-	-	-	10	2.00	2.00	-	-	-	2.0	4.0	6.4	320	850	1400	1.78	3.73	5.95	75	95	98	4.71	
	07	05	-	-	-	12	2.70	2.00	-	-	-	2.0	4.7	6.9	320	1050	1540	1.78	4.61	6.55	75	95	98	4.48	
	10	05	-	-	-	15	4.00	2.00	-	-	-	2.0	6.0	7.4	320	1350	1680	1.78	5.92	7.14	75	95	98	4.44	
	13	05	-	-	-	18	5.00	2.00	-	-	-	2.0	7.0	8.9	320	1560	2120	1.78	6.84	9.01	75	95	98	4.49	
	16	05	-	-	-	21	5.50	2.00	-	-	-	2.0	7.5	9.5	320	1700	2300	1.78	7.46	9.78	75	95	98	4.41	
	18	05	-	-	-	23	5.70	1.90	-	-	-	2.0	7.6	9.8	320	1850	2400	1.78	8.11	10.20	75	95	98	4.11	
	22	05	-	-	-	27	5.99	1.71	-	-	-	2.0	7.7	11.2	320	1980	2760	1.78	8.68	11.73	75	95	98	3.89	
	24	05	-	-	-	29	6.34	1.56	-	-	-	2.0	7.9	11.2	320	1980	2770	1.78	8.68	11.78	75	95	98	3.99	
	07	07	-	-	-	14	2.70	2.70	-	-	-	1.5	5.4	7.4	320	1400	2900	1.78	6.14	12.33	75	95	98	3.86	
	10	07	-	-	-	17	4.00	2.70	-	-	-	1.5	6.7	8.9	320	1950	3050	1.78	8.55	12.97	75	95	98	3.44	
	13	07	-	-	-	20	4.81	2.59	-	-	-	1.5	7.4	9.5	320	2300	3200	1.78	10.09	13.61	75	95	98	3.22	
	16	07	-	-	-	23	5.10	2.50	-	-	-	1.5	7.6	9.5	320	2300	3200	1.78	10.09	13.61	75	95	98	3.30	
	18	07	-	-	-	25	5.45	2.45	-	-	-	1.5	7.9	9.5	320	2450	3200	1.78	10.75	13.61	75	95	98	3.22	
	22	07	-	-	-	29	5.70	2.20	-	-	-	1.5	7.9	9.8	320	2450	3200	1.78	10.75	13.61	75	95	98	3.22	
	24	07	-	-	-	31	6.23	2.08	-	-	-	1.5	8.3	10.1	320	2500	3250	1.78	10.96	13.82	75	95	98	3.32	
	10	10	-	-	-	20	3.60	3.60	-	-	-	1.5	7.2	9.5	320	2200	3200	1.78	9.65	13.61	75	95	98	3.27	
	13	10	-	-	-	23	4.22	3.38	-	-	-	1.5	7.6	9.5	320	2300	3200	1.78	10.09	13.61	75	95	98	3.30	
	16	10	-	-	-	26	4.57	3.33	-	-	-	1.5	7.9	9.5	320	2450	3200	1.78	10.75	13.61	75	95	98	3.22	
	18	10	-	-	-	28	4.74	3.16	-	-	-	1.5	7.9	9.8	320	2450	3200	1.78	10.75	13.61	75	95	98	3.22	
	22	10	-	-	-	32	5.28	3.02	-	-	-	1.5	8.3	10.1	320	2500	3250	1.78	10.96	13.82	75	95	98	3.32	
	24	10	-	-	-	34	5.76	2.84	-	-	-	1.5	8.6	10.4	320	2550	3250	1.78	11.18	13.82	75	95	98	3.37	
	13	13	-	-	-	26	3.95	3.95	-	-	-	1.5	7.9	9.8	320	2450	3200	1.78	10.75	13.61	75	95	98	3.22	
	16	13	-	-	-	29	4.35	3.95	-	-	-	1.5	8.3	10.1	320	2500	3250	1.78	10.96	13.82	75	95	98	3.32	
	18	13	-	-	-	31	4.53	3.77	-	-	-	1.5	8.3	10.1	320	2500	3250	1.78	10.96	13.82	75	95	98	3.32	
	22	13	-	-	-	35	5.02	3.58	-	-	-	1.5	8.6	10.4	320	2550	3250	1.78	11.18	13.82	75	95	98	3.37	
	24	13	-	-	-	37	5.32	3.28	-	-	-	1.5	8.6	10.8	320	2550	3250	1.78	11.18	13.82	75	95	98	3.37	
	16	16	-	-	-	32	4.30	4.30	-	-	-	1.5	8.6	10.4	320	2550	3250	1.78	11.18	13.82	75	95	98	3.37	
	18	16	-	-	-	34	4.49	4.11	-	-	-	1.5	8.6	10.4	320	2550	3250	1.78	11.18	13.82	75	95	98	3.37	
	22	16	-	-	-	38	4.82	3.78	-	-	-	1.5	8.6	10.8	320	2550	3250	1.78	11.18	13.82	75	95	98	3.37	
	24	16	-	-	-	40	5.12	3.48	-	-	-	1.5	8.6	10.8	320	2550	3250	1.78	11.18	13.82	75	95	98	3.37	
	18	18	-	-	-	36	4.30	4.30	-	-	-	1.5	8.6	10.8	320	2550	3250	1.78	11.18	13.82	75	95	98	3.37	
	22	18	-	-	-	40	4.63	3.97	-	-	-	1.5	8.6	10.8	320	2550	3250	1.78	11.18	13.82	75	95	98	3.37	
	24	18	-	-	-	42	4.94	3.66	-	-	-	1.5	8.6	10.8	320	2550	3250	1.78	11.18	13.82	75	95	98	3.37	
	3 units	05	05	05	-	-	15	2.00	2.00	2.00	-	-	2.0	6.0	9.5	380	1220	1400	1.98	5.35	5.95	80	95	98	4.92
		07	05	05	-	-	17	2.70	2.00	2.00	-	-	2.0	6.7	10.0	380	1400	1540	1.98	6.14	6.55	80	95	98	4.79
		10	05	05	-	-	20	4.00	2.00	2.00	-	-	2.0	8.0	10.8	380	1850	1680	1.98	8.11	7.14	80	95	98	4.32
		13	05	05	-	-	23	4.94	1.98	1.98	-	-	2.0	8.9	11.2	380	2180	1790	1.98	9.56	7.61	80	95	98	4.08
		16	05	05	-	-	26	5.15	1.87	1.87	-	-	2.0	8.9	11.2	380	2180	2400	1.98	9.56	10.20	80	95	98	4.08
		18	05	05	-	-	28	4.80	1.60	1.60	-	-	2.0	8.0	10.8	380	1850	2730	1.98	8.11	11.61	80	95	98	4.32
		22	05	05	-	-	32	5.66	1.62	1.62	-	-	2.0	8.9	11.2	380	2180	2870	1.98	9.56	12.20	80	95	98	4.08
24		05	05	-	-	34	5.96	1.47	1.47	-	-	2.0	8.9	11.2	380	2180	2770	1.98	9.56	11.78	80	95	98	4.08	
07		07	05	-	-	19	2.70	2.70	2.00	-	-	2.0	7.4	10.8	380	1600	1680	1.98	7.02	7.14	80	95	98	4.63	
10		07	05	-	-	22	4.00	2.70	2.00	-	-	2.0	8.7	11.2	380	2180	2120	1.98	9.56	9.01	80	95	98	3.99	
13		07	05	-	-	25	4.59	2.48	1.84	-	-	2.0	8.9	11.2	380	2180	2400	1.98	9.56	10.20	80	95	98	4.08	
16		07	05	-	-	28	4.80	2.36	1.75	-	-	2.0	8.9	11.2	380	2180	2730	1.98	9.56	11.61	80	95	98	4.08	
18		07	05	-	-	30	4.99	2.25	1.66	-	-	2.0	8.9	11.2	380	2180	2730	1.98	9.56	11.61	80	95	98	4.08	
22		07	05	-	-	34	5.32	2.05	1.52	-	-	2.0	8.9	11.2	380	2180	2770	1.98	9.56	11.78	80	95	98	4.08	
24		07	05	-	-	36	5.63	1.88	1.39	-	-	2.0	8.9	11.2	380	2180	2780	1.98	9.56	11.82	80	95	98	4.08	
10		10	05	-	-	25	3.56	3.56	1.78	-	-	2.0	8.9	11.2	380	2180	2730	1.98	9.56	11.61	80	95	98	4.08	
13		10	05	-	-	28	4.05	3.24	1.62	-	-	2.0	8.9	11.2	380	2180	2870	1.98	9.56	12.20	80	95	98	4.08	
16		10	05	-	-	31	4.26	3.10	1.55	-	-	2.0	8.9	11.2	380	2180	2770	1.98	9.56	11.78	80	95	98	4.08	
18		10	05	-	-	33	4.45	2.97	1.48	-	-	2.0	8.9	11.2	380	2180	2770	1.98	9.56	11.78	80	95	98	4.08	
22		10	05	-	-	37	4.79	2.74	1.37	-	-	2.0	8.9	11.2	380	2180	2780	1.98	9.56	11.82	80	95	98	4.08	
24		10	05	-	-	39	5.11	2.52	1.26	-	-	2.0	8.9	11.2	380	2180	2790	1.98	9.56	11.86	80	95	98	4.08	
13		13	05	-	-	31	3.71	3.71	1.48	-	-	2.0	8.9	11.2	380	2180	2770	1.98	9.56	11.78	80	95	98	4.08	
16		13	05	-	-	34	3.92	3.56	1.42	-	-	2.0	8.9	11.2	380	2180	2780	1.98	9.56	11.82	80	95	98	4.08	
18		13	05	-	-	36	4.11	3.42	1.37	-	-	2.0	8.9	11.2	380	2180	2780	1.98	9.56	11.82					

Operation mode : Heating Power supply voltage : 240V

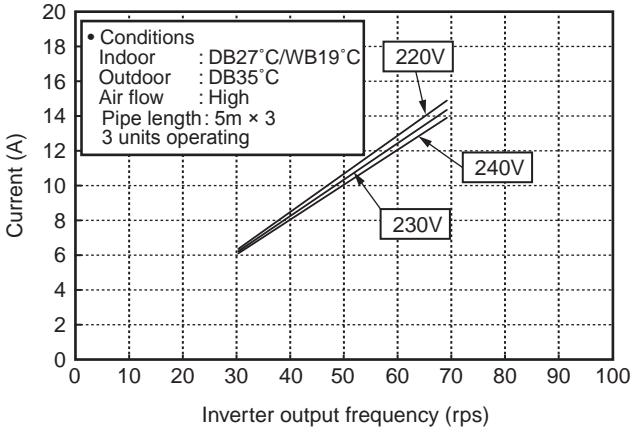
Operatin status	Indoor unit					Unit capacity (kW)					Heating capacity (kW)			Power consumption (W)			Operating current (A)			Power factor (%)			COP Rate				
	A	B	C	D	E	ΣkBTU	A	B	C	D	E	Min	Rate	Max	Min	Rate	Max	Min	Rate	Max	Min	Rate		Max	Min	Rate	Max
3 units (continued)	16	13	07	-	-	36	3.71	3.37	1.82	-	-	2.0	8.9	11.0	380	2175	2830	1.98	9.54	12.03	80	95	98	4.09			
	18	13	07	-	-	38	3.90	3.25	1.75	-	-	2.0	8.9	11.0	380	2175	2830	1.98	9.54	12.03	80	95	98	4.09			
	22	13	07	-	-	42	4.24	3.03	1.63	-	-	2.0	8.9	11.0	380	2175	2830	1.98	9.54	12.03	80	95	98	4.09			
	24	13	07	-	-	44	4.56	2.82	1.52	-	-	2.0	8.9	11.0	380	2175	2830	1.98	9.54	12.03	80	95	98	4.09			
	16	16	07	-	-	39	3.57	3.57	1.75	-	-	2.0	8.9	11.0	380	2175	2830	1.98	9.54	12.03	80	95	98	4.09			
	18	16	07	-	-	41	3.76	3.45	1.69	-	-	2.0	8.9	11.0	380	2175	2830	1.98	9.54	12.03	80	95	98	4.09			
	22	16	07	-	-	45	4.14	3.26	1.60	-	-	2.0	9.0	11.2	380	2200	2900	1.98	9.65	12.33	80	95	98	4.09			
	24	16	07	-	-	47	4.47	3.04	1.49	-	-	2.0	9.0	11.2	380	2200	2900	1.98	9.65	12.33	80	95	98	4.09			
	10	10	10	-	-	30	2.97	2.97	2.97	-	-	2.0	8.9	10.8	380	2175	2750	1.98	9.54	11.69	80	95	98	4.09			
	13	10	10	-	-	33	3.42	2.74	2.74	-	-	2.0	8.9	11.0	380	2175	2830	1.98	9.54	12.03	80	95	98	4.09			
	16	10	10	-	-	36	3.63	2.64	2.64	-	-	2.0	8.9	11.0	380	2175	2830	1.98	9.54	12.03	80	95	98	4.09			
	18	10	10	-	-	38	3.81	2.54	2.54	-	-	2.0	8.9	11.0	380	2175	2830	1.98	9.54	12.03	80	95	98	4.09			
	22	10	10	-	-	42	4.15	2.37	2.37	-	-	2.0	8.9	11.0	380	2175	2830	1.98	9.54	12.03	80	95	98	4.09			
	24	10	10	-	-	44	4.48	2.21	2.21	-	-	2.0	8.9	11.0	380	2175	2830	1.98	9.54	12.03	80	95	98	4.09			
	13	13	10	-	-	36	3.18	3.18	2.54	-	-	2.0	8.9	11.0	380	2175	2830	1.98	9.54	12.03	80	95	98	4.09			
	16	13	10	-	-	39	3.38	3.07	2.46	-	-	2.0	8.9	11.0	380	2175	2830	1.98	9.54	12.03	80	95	98	4.09			
	18	13	10	-	-	41	3.56	2.97	2.37	-	-	2.0	8.9	11.0	380	2175	2830	1.98	9.54	12.03	80	95	98	4.09			
	22	13	10	-	-	45	3.94	2.81	2.25	-	-	2.0	9.0	11.2	380	2200	2900	1.98	9.65	12.33	80	95	98	4.09			
	24	13	10	-	-	47	4.26	2.63	2.11	-	-	2.0	9.0	11.2	380	2200	2900	1.98	9.65	12.33	80	95	98	4.09			
	16	16	10	-	-	42	3.26	3.26	2.37	-	-	2.0	8.9	11.0	380	2175	2830	1.98	9.54	12.03	80	95	98	4.09			
	18	16	10	-	-	44	3.45	3.16	2.30	-	-	2.0	8.9	11.0	380	2175	2830	1.98	9.54	12.03	80	95	98	4.09			
	22	16	10	-	-	48	3.82	3.00	2.18	-	-	2.0	9.0	11.2	380	2200	2900	1.98	9.65	12.33	80	95	98	4.09			
	24	16	10	-	-	50	4.14	2.81	2.05	-	-	2.0	9.0	11.2	380	2200	2900	1.98	9.65	12.33	80	95	98	4.09			
	13	13	13	-	-	39	2.97	2.97	2.97	-	-	2.0	8.9	11.0	380	2175	2830	1.98	9.54	12.03	80	95	98	4.09			
	16	13	13	-	-	42	3.16	2.87	2.87	-	-	2.0	8.9	11.0	380	2175	2830	1.98	9.54	12.03	80	95	98	4.09			
	18	13	13	-	-	44	3.34	2.78	2.78	-	-	2.0	8.9	11.0	380	2175	2830	1.98	9.54	12.03	80	95	98	4.09			
	22	13	13	-	-	48	3.71	2.65	2.65	-	-	2.0	9.0	11.2	380	2200	2900	1.98	9.65	12.33	80	95	98	4.09			
	24	13	13	-	-	50	4.03	2.49	2.49	-	-	2.0	9.0	11.2	380	2200	2900	1.98	9.65	12.33	80	95	98	4.09			
16	16	13	-	-	45	3.09	3.09	2.81	-	-	2.0	9.0	11.2	380	2200	2900	1.98	9.65	12.33	80	95	98	4.09				
18	16	13	-	-	47	3.27	3.00	2.73	-	-	2.0	9.0	11.2	380	2200	2900	1.98	9.65	12.33	80	95	98	4.09				
22	16	13	-	-	51	3.60	2.83	2.57	-	-	2.0	9.0	11.2	380	2200	2900	1.98	9.65	12.33	80	95	98	4.09				
24	16	13	-	-	53	3.92	2.66	2.42	-	-	2.0	9.0	11.2	380	2200	2900	1.98	9.65	12.33	80	95	98	4.09				
16	16	16	-	-	48	3.00	3.00	3.00	-	-	2.0	9.0	11.2	380	2200	2900	1.98	9.65	12.33	80	95	98	4.09				
18	16	16	-	-	50	3.18	2.91	2.91	-	-	2.0	9.0	11.2	380	2200	2900	1.98	9.65	12.33	80	95	98	4.09				
22	16	16	-	-	54	3.50	2.75	2.75	-	-	2.0	9.0	11.2	380	2200	2900	1.98	9.65	12.33	80	95	98	4.09				

\* Applicable FCU are "PKV" series and "BKV" series only.

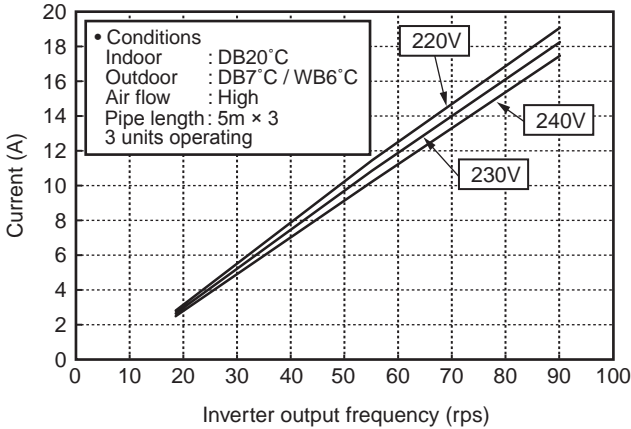
• The above specification values are those under the conditions that the indoor DB/WB=20/-°C and the outdoor DB/WB=7/6°C.

2-3-1. Operation Characteristic Curve

<Cooling>

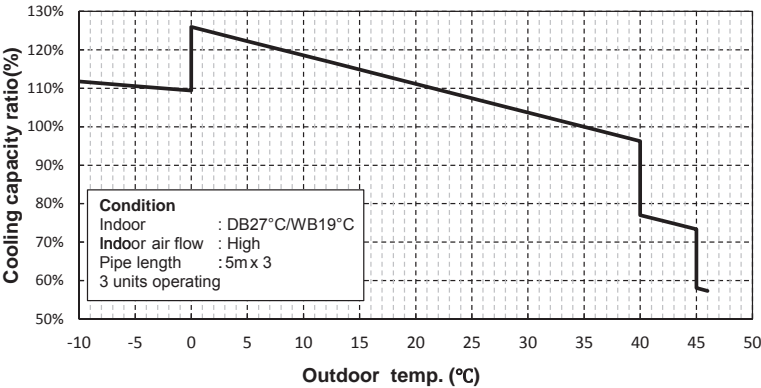


<Heating>

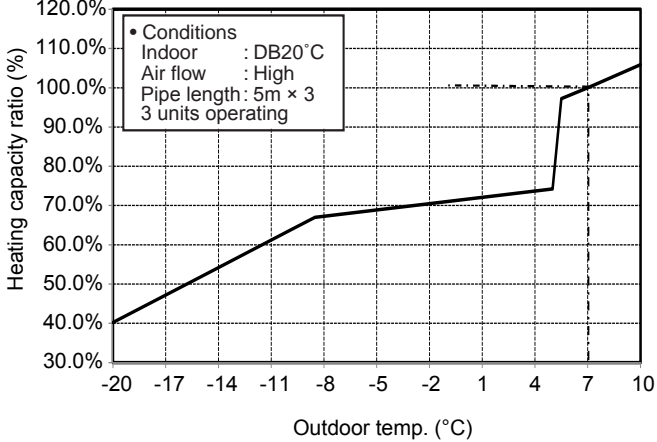


2-3-2. Capacity Variation Ratio According to Outdoor Temperature

<Cooling>

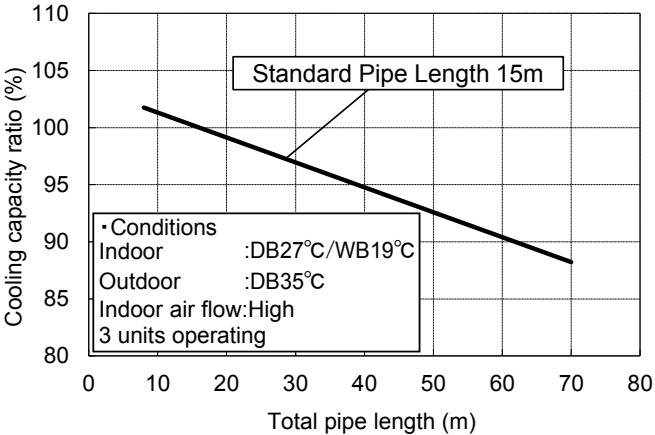


<Heating>

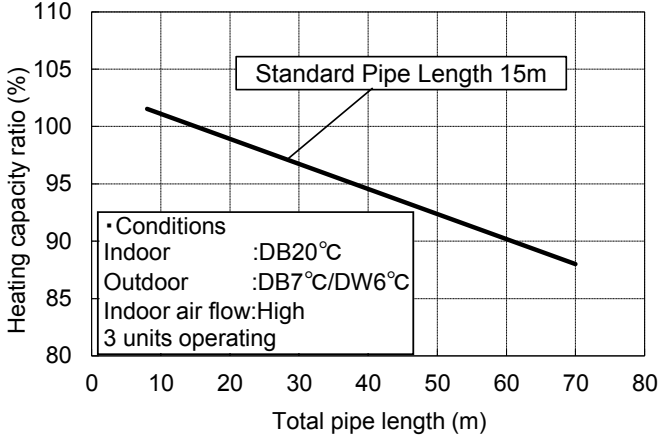


2-3-3. Capacity Variation Ratio According to Pipe Length

<Cooling>



<Heating>



### 3. REFRIGERANT R32

This air conditioner adopts the new refrigerant HFC (R32) which does not damage the ozone layer.

The next section describes the precautions for air conditioner using the new refrigerant. Conforming to contents of the next section together with the general cautions included in this manual, perform the correct and safe work.

#### 3-1. Safety During Installation/Service

The basic installation servicing work procedures are the same as conventional R410A models.

As R32's pressure is about 1.6 times higher than that of R22, improper installation/servicing may cause a serious trouble. By using tools and materials exclusive for R32, it is necessary to carry out installation/servicing safely while taking the following precautions into consideration.

1. Never use refrigerant other than R32 in an air conditioner which is designed to operate with R32. If other refrigerant than R32 is mixed, pressure in the refrigeration cycle becomes abnormally high, and it may cause personal injury, etc. by a rupture.
2. Confirm the used refrigerant name, and use tools and materials exclusive for the refrigerant. The refrigerant name R32 is indicated on the visible place of the outdoor unit of the air conditioner using R32 as refrigerant. To prevent mischarging, the diameter of the service port differs from that of R22. R32 and other HFCs are heavier than air, and therefore they are inclined to settle near the floor surface. If the gas fills up the room or the bottom part of a room, it may also cause oxygen deficiency and may reach its combustion concentration.

**In order to prevent oxygen deficiency and R32 combustion, keep the room well-ventilated for a healthy work environment.**

In particular, using HFCs in a basement room or confined area creates a higher risk; be sure to furnish the room with local exhaust ventilation. If a refrigerant leak is confirmed in a room an inadequately ventilated location, do not use a flame until the area has been ventilated appropriately and the work environment has been improved.

**The same applies in case of brazing, ensure appropriate ventilation to prevent oxygen deficiency and R32 combustion.**

Check that there are no dangerous or combustible items nearby, and ensure a fire extinguisher is close at hand.

Keep a sufficient distance away from causes of fire (ignition sources) such as gas-burning equipment and electric heaters in places where installation, repairs, or similar work on air-conditioning equipment is performed.

3. If a refrigeration gas leakage occurs during installation/servicing, be sure to ventilate fully. If the refrigerant gas comes into contact with fire, a poisonous gas may occur.
4. When installing or removing an air conditioner, do not allow air moisture dust or oil to remain in the refrigeration cycle. Otherwise, pressure in the refrigeration cycle may become abnormally high so that a rupture or personal injury may be caused.
5. After completion of installation work, check to make sure that there is no refrigeration gas leakage. If the refrigerant gas leaks into the room, coming into contact with fire in the fan-driven heater, space heater, etc., a poisonous gas may occur
6. When an air conditioning system charged with a large volume of refrigerant is installed in a small room, it is necessary to exercise care so that, even when refrigerant leaks, its concentration does not exceed the marginal level. If the refrigerant gas leakage occurs and its concentration exceeds the marginal level, an oxygen starvation accident may result.
7. Be sure to carry out installation or removal according to the installation manual. Improper installation may cause refrigeration trouble, water leakage, electric shock, fire, etc.
8. Unauthorized modifications to the air conditioner may be dangerous. If a breakdown occurs please call a qualified air conditioner technician or electrician. Improper repair's may result in water leakage, electric shock and fire, etc.

#### 3-2. Refrigerant Piping Installation

##### 3-2-1. Piping Materials and Joints Used

For the refrigerant piping installation, copper pipes and joints are mainly used. Copper pipes and joints suitable for the refrigerant must be chosen and installed. Furthermore, it is necessary to use clean copper pipes and joints whose interior surfaces are less affected by contaminants.

##### 1. Copper Pipes

It is necessary to use seamless copper pipes which are made of either copper or copper alloy and it is desirable that the amount of residual oil is less than 40 mg/10 m. Do not use copper pipes having a collapsed, deformed or discolored portion (especially on the interior surface).

Otherwise, the expansion valve or capillary tube may become blocked with contaminants.

As an air conditioner using R32 incurs pressure higher than when using R22, it is necessary to choose adequate materials.

Thicknesses of copper pipes used with R32 are as shown in Table 3-2-1. Never use copper pipes thinner than 0.8 mm even when it is available on the market.

**Table 3-2-1 Thicknesses of annealed copper pipes**

		Thickness (mm)	
Nominal diameter	Outer diameter (mm)	R32	R22
1/4	6.35	0.80	0.80
3/8	9.52	0.80	0.80
1/2	12.70	0.80	0.80
5/8	15.88	1.00	1.00

## 2. Joints

For copper pipes, flare joints or socket joints are used. Prior to use, be sure to remove all contaminants.

### a) Flare Joints

Flare joints used to connect the copper pipes cannot be used for pipings whose outer diameter exceeds 20 mm. In such a case, socket joints can be used.

Sizes of flare pipe ends, flare joint ends and flare nuts are as shown in Tables 3-2-3 to 3-2-6 below.

### b) Socket Joints

Socket joints are such that they are brazed for connections, and used mainly for thick pipings whose diameter is larger than 20 mm.

Thicknesses of socket joints are as shown in Table 3-2-2.

**Table 3-2-2 Minimum thicknesses of socket joints**

Nominal diameter	Reference outer diameter of copper pipe jointed (mm)	Minimum joint thickness (mm)
1/4	6.35	0.50
3/8	9.52	0.60
1/2	12.70	0.70
5/8	15.88	0.80

## 3-2-2. Processing of Piping Materials

When performing the refrigerant piping installation, care should be taken to ensure that water or dust does not enter the pipe interior, that no other oil than lubricating oils used in the installed air-water heat pump is used, and that refrigerant does not leak. When using lubricating oils in the piping processing, use such lubricating oils whose water content has been removed. When stored, be sure to seal the container with an airtight cap or any other cover.

### 1. Flare processing procedures and precautions

#### a) Cutting the Pipe

By means of a pipe cutter, slowly cut the pipe so that it is not deformed.

#### b) Removing Burrs and Chips

If the flared section has chips or burrs, refrigerant leakage may occur.

Carefully remove all burrs and clean the cut surface before installation.

#### c) Insertion of Flare Nut

d) Flare Processing

Make certain that a clamp bar and copper pipe have been cleaned.

By means of the clamp bar, perform the flare processing correctly.

Use either a flare tool for R32 or conventional flare tool.

Flare processing dimensions differ according to the type of flare tool. When using a conventional flare tool, be sure to secure "dimension A" by using a gauge for size adjustment.

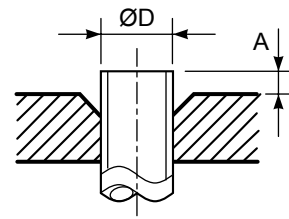


Fig. 3-2-1 Flare processing dimensions

Table 3-2-3 Dimensions related to flare processing for R32(R410A)

Nominal diameter	Outer diameter (mm)	Thickness (mm)	A (mm)		
			Flare tool for R32 clutch type	Conventional flare tool	
				Clutch type	Wing nut type
1/4	6.35	0.8	0 to 0.5	1.0 to 1.5	1.5 to 2.0
3/8	9.52	0.8	0 to 0.5	1.0 to 1.5	1.5 to 2.0
1/2	12.70	0.8	0 to 0.5	1.0 to 1.5	2.0 to 2.5
5/8	15.88	1.0	0 to 0.5	1.0 to 1.5	2.0 to 2.5

Table 3-2-4 Dimensions related to flare processing for R22

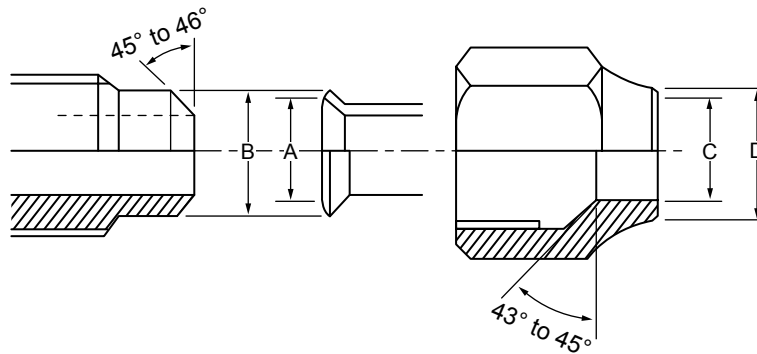
Nominal diameter	Outer diameter (mm)	Thickness (mm)	A (mm)		
			Flare tool for R22 clutch type	Conventional flare tool	
				Clutch type	Wing nut type
1/4	6.35	0.8	0 to 0.5	0.5 to 1.0	1.0 to 1.5
3/8	9.52	0.8	0 to 0.5	0.5 to 1.0	1.0 to 1.5
1/2	12.70	0.8	0 to 0.5	0.5 to 1.0	1.5 to 2.0
5/8	15.88	1.0	0 to 0.5	0.5 to 1.0	1.5 to 2.0

Table 3-2-5 Flare and flare nut dimensions for R32(R410A)

Nominal diameter	Outer diameter (mm)	Thickness (mm)	Dimension (mm)				Flare nut width (mm)
			A	B	C	D	
1/4	6.35	0.8	9.1	9.2	6.5	13	17
3/8	9.52	0.8	13.2	13.5	9.7	20	22
1/2	12.70	0.8	16.6	16.0	12.9	23	26
5/8	15.88	1.0	19.7	19.0	16.0	25	29

**Table 3-2-6 Flare and flare nut dimensions for R22**

Nominal diameter	Outer diameter (mm)	Thickness (mm)	Dimension (mm)				Flare nut width (mm)
			A	B	C	D	
1/4	6.35	0.8	9.0	9.2	6.5	13	17
3/8	9.52	0.8	13.0	13.5	9.7	20	22
1/2	12.70	0.8	16.2	16.0	12.9	20	24
5/8	15.88	1.0	19.7	19.0	16.0	23	27
3/4	19.05	1.0	23.3	24.0	19.2	34	36



**Fig. 3-2-2 Relations between flare nut and flare seal surface**

**2. Flare Connecting Procedures and Precautions**

- a) Make sure that the flare and union portions do not have any scar or dust, etc.
- b) Correctly align the processed flare surface with the union axis.
- c) Tighten the flare with designated torque by means of a torque wrench. The tightening torque for R32 is the same as that for conventional R22. Incidentally, when the torque is weak, the gas leakage may occur. When it is strong, the flare nut may crack and may be made non-removable. When choosing the tightening torque, comply with values designated by manufacturers. Table 3-2-7 shows reference values.

**NOTE :**

When applying oil to the flare surface, be sure to use oil designated by the manufacturer. If any other oil is used, the lubricating oils may deteriorate and cause the compressor to burn out.

**Table 3-2-7 Tightening torque of flare for R32(R410A) [Reference values]**

Nominal diameter	Outer diameter (mm)	Tightening torque N•m (kgf•cm)	Tightening torque of torque wrenches available on the market N•m (kgf•cm)
1/4	6.35	14 to 18 (140 to 180)	16 (160), 18 (180)
3/8	9.52	33 to 42 (330 to 420)	42 (420)
1/2	12.70	50 to 62 (500 to 620)	55 (550)
5/8	15.88	63 to 77 (630 to 770)	65 (650)



### 3-3. Tools

#### 3-3-1. Required Tools

The service port diameter of packed valve of the outdoor unit in the air-water heat pump using R32 is changed to prevent mixing of other refrigerant. To reinforce the pressure-resisting strength, flare processing dimensions and opposite side dimension of flare nut (For Ø12.7 copper pipe) of the refrigerant piping are lengthened.

The used refrigerating oil is changed, and mixing of oil may cause a trouble such as generation of sludge, clogging of capillary, etc. Accordingly, the tools to be used are classified into the following three types.

1. Tools exclusive for R32(R410A) (Those which cannot be used for conventional refrigerant (R22))
2. Tools exclusive for R32(R410A), but can be also used for conventional refrigerant (R22)
3. Tools commonly used for R32(R410A) and for conventional refrigerant (R22)

The table below shows the tools exclusive for R32(R410A) and their interchangeability.

**Tools exclusive for R32(R410A) (The following tools for R32(R410A) are required.)**

Tools whose specifications are changed for R32 and their interchangeability

No.	Used tool	Usage	R32 air-water heat pump installation		Conventional air-water heat pump installation
			Existence of new equipment for R32	Whether conventional equipment can be used	Whether new equipment can be used with conventional refrigerant
1	Flare tool	Pipe flaring	Yes	*(Note 1)	○
2	Copper pipe gauge for adjusting projection margin	Flaring by conventional flare tool	Yes	*(Note 1)	*(Note 1)
3	Torque wrench (For Ø12.7)	Connection of flare nut	Yes	×	×
4	Gauge manifold	Evacuating, refrigerant charge, run check, etc.	Yes	×	×
5	Charge hose				
6	Vacuum pump adapter	Vacuum evacuating	Yes	×	○
7	Electronic balance for refrigerant charging	Refrigerant charge	Yes	×	○
8	Refrigerant cylinder	Refrigerant charge	Yes	×	×
9	Leakage detector	Gas leakage check	Yes	×	○
10	Charging cylinder	Refrigerant charge	(Note 2)	×	×

**(Note 1)** When flaring is carried out for R32(R410A) using the conventional flare tools, adjustment of projection margin is necessary. For this adjustment, a copper pipe gauge, etc. are necessary.

**(Note 2)** Charging cylinder for R32(R410A) is being currently developed.

**General tools (Conventional tools can be used.)**

In addition to the above exclusive tools, the following equipments which serve also for R22 are necessary as the general tools.

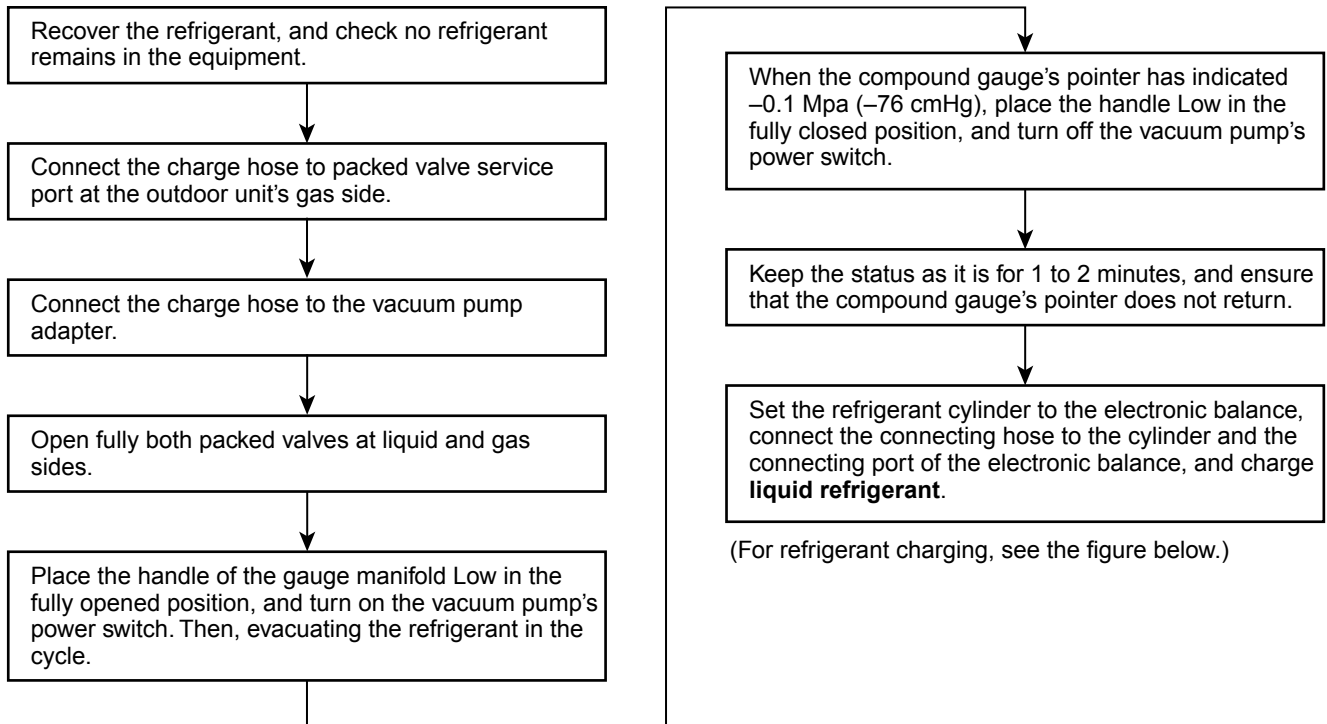
- |   |                             |  |
|---|-----------------------------|--|
| 1. Vacuum pump<br>Use vacuum pump by attaching vacuum pump adapter. | 4. Reamer                   | 9. Hole core drill (Ø65)               |
| 2. Torque wrench (For Ø6.35, Ø9.52)                                 | 5. Pipe bender              | 10. Hexagon wrench (Opposite side 4mm) |
| 3. Pipe cutter  | 6. Level vial               | 11. Tape measure                       |
|   | 7. Screwdriver (+, -)       | 12. Metal saw                          |
|   | 8. Spanner or Monkey wrench |  |

Also prepare the following equipments for other installation method and run check.

- |                |                                 |
|----------------|---------------------------------|
| 1. Clamp meter | 3. Insulation resistance tester |
| 2. Thermometer | 4. Electroscopes                |

### 3-4. Recharging of Refrigerant

When it is necessary to recharge refrigerant, charge the specified amount of new refrigerant according to the following steps.



1. Never charge refrigerant exceeding the specified amount.
2. If the specified amount of refrigerant cannot be charged, charge refrigerant **bit by bit** in COOL mode.
3. Do not carry out additional charging.

When additional charging is carried out if refrigerant leaks, the refrigerant composition changes in the refrigeration cycle, that is characteristics of the air conditioner changes, refrigerant exceeding the specified amount is charged, and working pressure in the refrigeration cycle becomes abnormally high pressure, and may cause a rupture or personal injury.

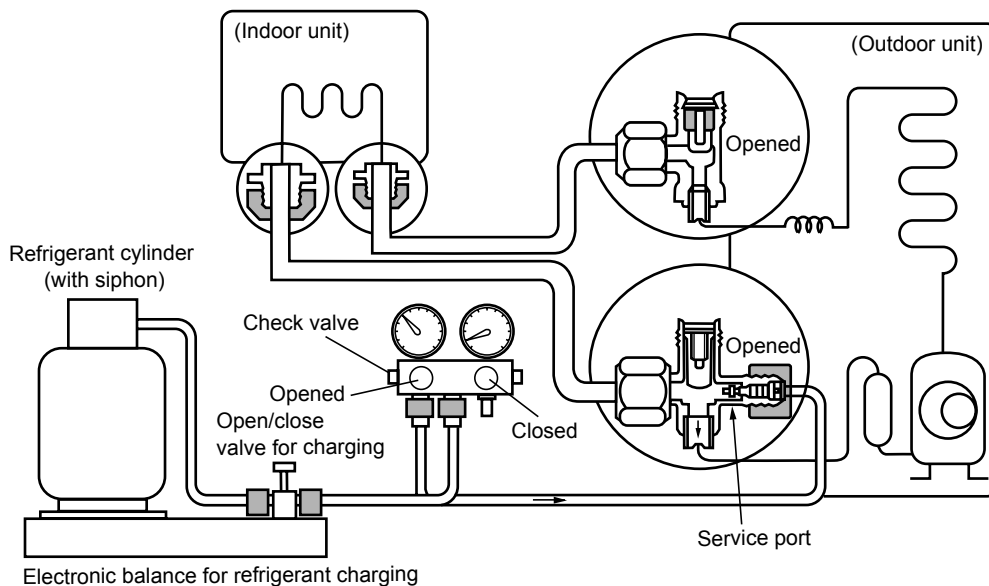
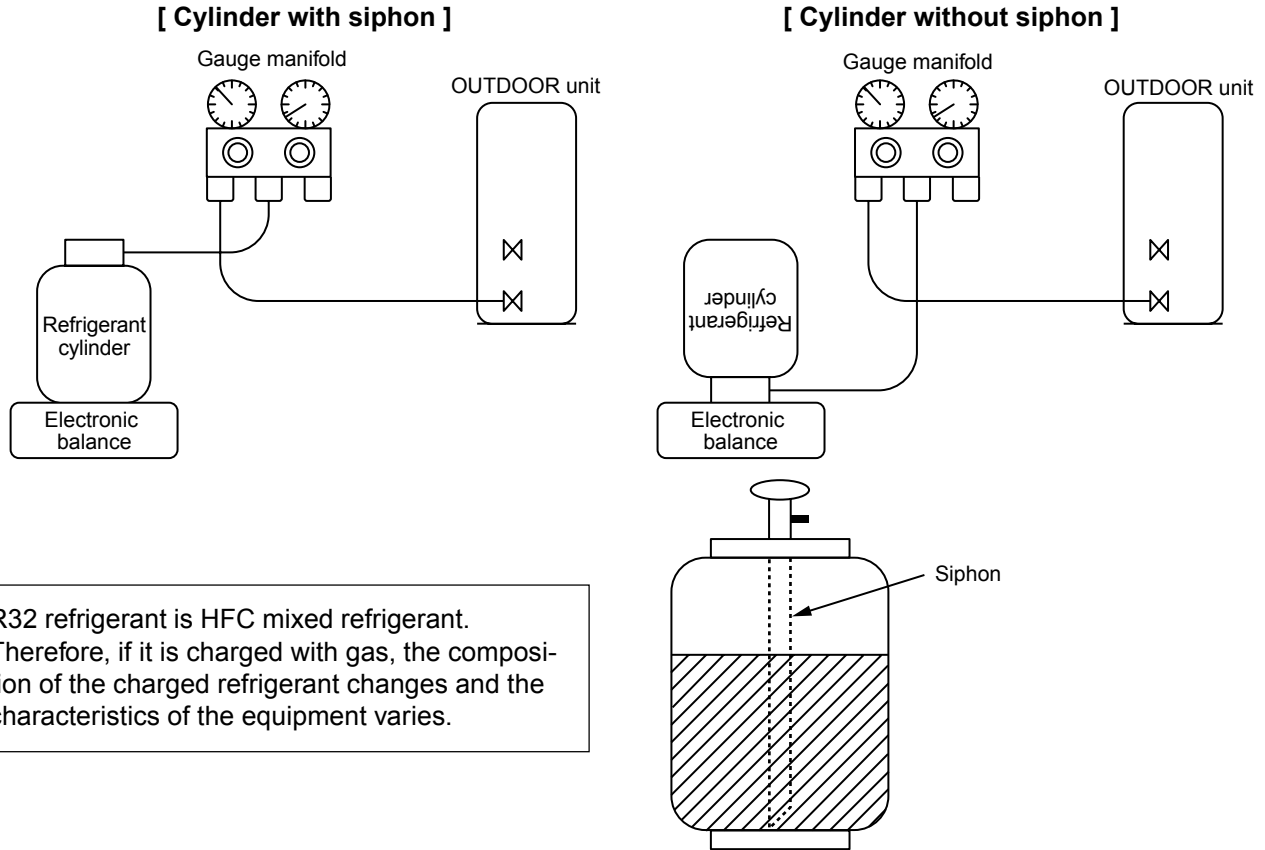


Fig. 3-4-1 Configuration of refrigerant charging

1. Be sure to make setting so that **liquid** can be charged.
2. When using a cylinder equipped with a siphon, liquid can be charged without turning it upside down.

It is necessary for charging refrigerant under condition of liquid because R32 is mixed type of refrigerant. Accordingly, when charging refrigerant from the refrigerant cylinder to the equipment, charge it turning the cylinder upside down if cylinder is not equipped with siphon.



R32 refrigerant is HFC mixed refrigerant. Therefore, if it is charged with gas, the composition of the charged refrigerant changes and the characteristics of the equipment varies.

Fig. 3-4-2

### 3-5. Brazing of Pipes

#### 3-5-1. Materials for Brazing

##### 1. Silver brazing filler

Silver brazing filler is an alloy mainly composed of silver and copper. It is used to join iron, copper or copper alloy, and is relatively expensive though it excels in solderability.

##### 2. Phosphor bronze brazing filler

Phosphor bronze brazing filler is generally used to join copper or copper alloy.

##### 3. Low temperature brazing filler

Low temperature brazing filler is generally called solder, and is an alloy of tin and lead. Since it is weak in adhesive strength, do not use it for refrigerant pipes.

1. Phosphor bronze brazing filler tends to react with sulfur and produce a fragile compound water solution, which may cause a gas leakage. Therefore, use any other type of brazing filler at a hot spring resort, etc., and coat the surface with a paint.
2. When performing brazing again at time of servicing, use the same type of brazing filler.

#### 3-5-2. Flux

##### 1. Reason why flux is necessary

- By removing the oxide film and any foreign matter on the metal surface, it assists the flow of brazing filler.
- In the brazing process, it prevents the metal surface from being oxidized.
- By reducing the brazing filler's surface tension, the brazing filler adheres better to the treated metal.

**2. Characteristics required for flux**

- Activated temperature of flux coincides with the brazing temperature.
- Due to a wide effective temperature range, flux is hard to carbonize.
- It is easy to remove slag after brazing.
- The corrosive action to the treated metal and brazing filler is minimum.
- It excels in coating performance and is harmless to the human body.

As the flux works in a complicated manner as described above, it is necessary to select an adequate type of flux according to the type and shape of treated metal, type of brazing filler and brazing method, etc.

**3. Types of flux**

• **Noncorrosive flux**

Generally, it is a compound of borax and boric acid.

It is effective in case where the brazing temperature is higher than 800°C.

• **Activated flux**

Most of fluxes generally used for silver brazing are this type.

It features an increased oxide film removing capability due to the addition of compounds such as potassium fluoride, potassium chloride and sodium fluoride to the borax-boric acid compound.

**4. Piping materials for brazing and used brazing filler/flux**

Piping material	Used brazing filler	Used flux
Copper - Copper	Phosphor copper	Do not use
Copper - Iron	Silver	Paste flux
Iron - Iron	Silver	Vapor flux

1. Do not enter flux into the refrigeration cycle.
2. When chlorine contained in the flux remains within the pipe, the lubricating oil deteriorates. Therefore, use a flux which does not contain chlorine.
3. When adding water to the flux, use water which does not contain chlorine (e.g. distilled water or ion-exchange water).
4. Remove the flux after brazing.

**3-5-3. Brazing**

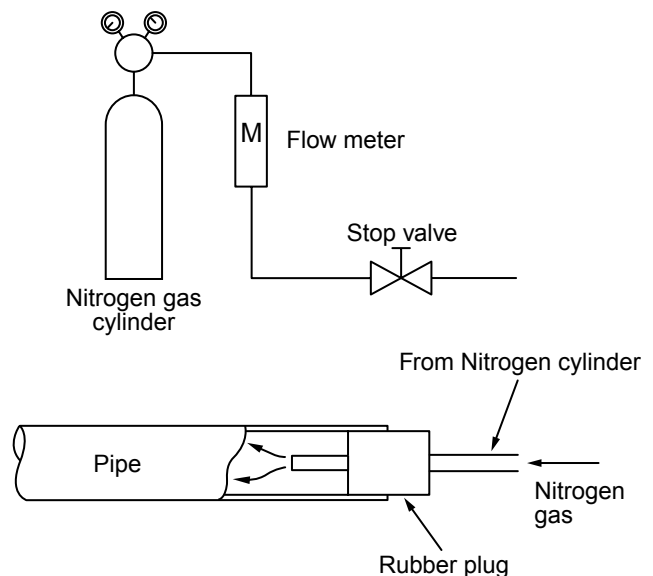
As brazing work requires sophisticated techniques, experiences based upon a theoretical knowledge, it must be performed by a person qualified.

In order to prevent the oxide film from occurring in the pipe interior during brazing, it is effective to proceed with brazing while letting dry Nitrogen gas (N<sub>2</sub>) flow.

**Never use gas other than Nitrogen gas.**

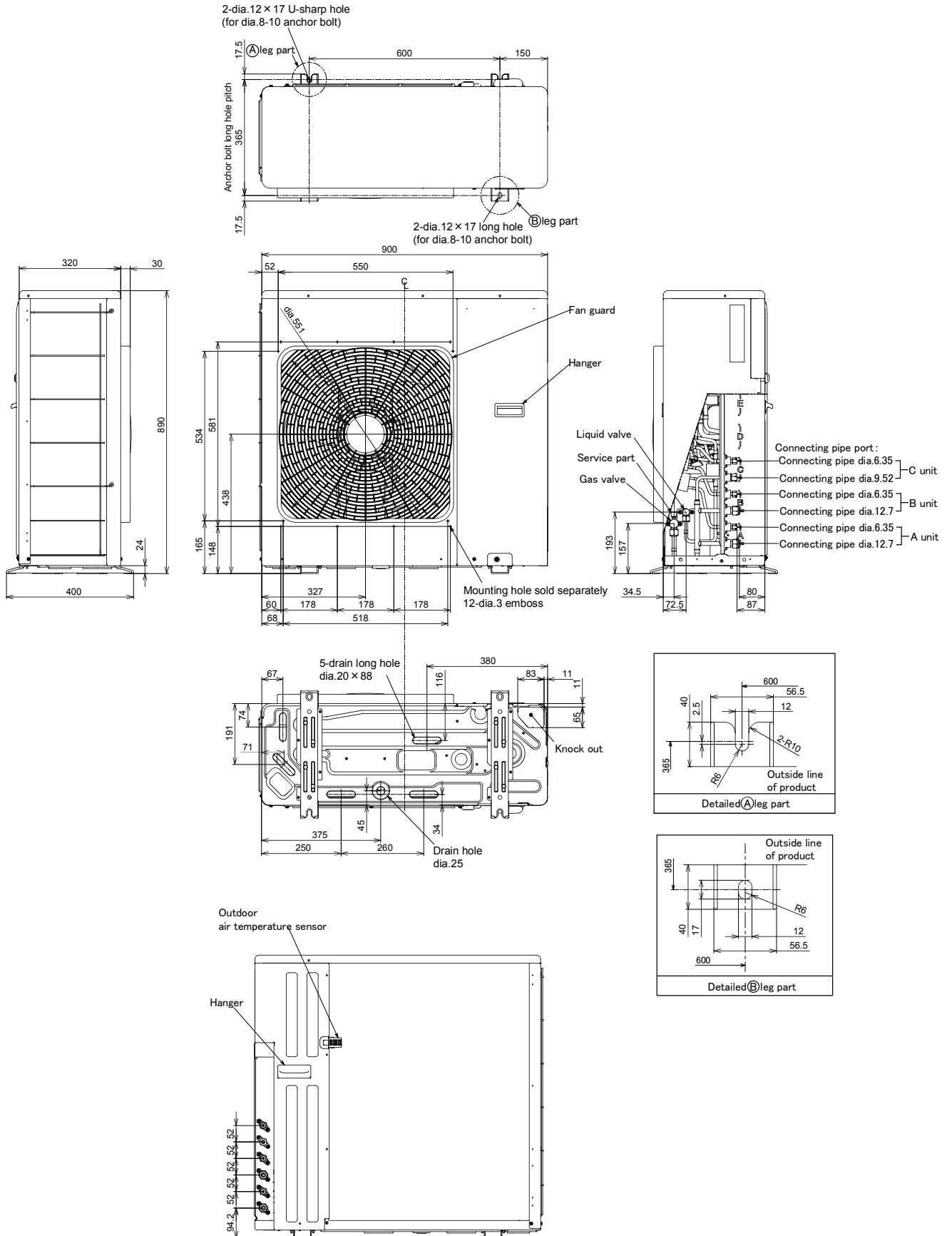
**1. Brazing method to prevent oxidation**

- 1) Attach a reducing valve and a flow-meter to the Nitrogen gas cylinder.
- 2) Use a copper pipe to direct the piping material, and attach a flow-meter to the cylinder.
- 3) Apply a seal onto the clearance between the piping material and inserted copper pipe for Nitrogen in order to prevent backflow of the Nitrogen gas.
- 4) When the Nitrogen gas is flowing, be sure to keep the piping end open.
- 5) Adjust the flow rate of Nitrogen gas so that it is lower than 0.05 m<sup>3</sup>/Hr or 0.02 MPa (0.2kgf/cm<sup>2</sup>) by means of the reducing valve.
- 6) After performing the steps above, keep the Nitrogen gas flowing until the pipe cools down to a certain extent (temperature at which pipes are touchable with hands).
- 7) Remove the flux completely after brazing.

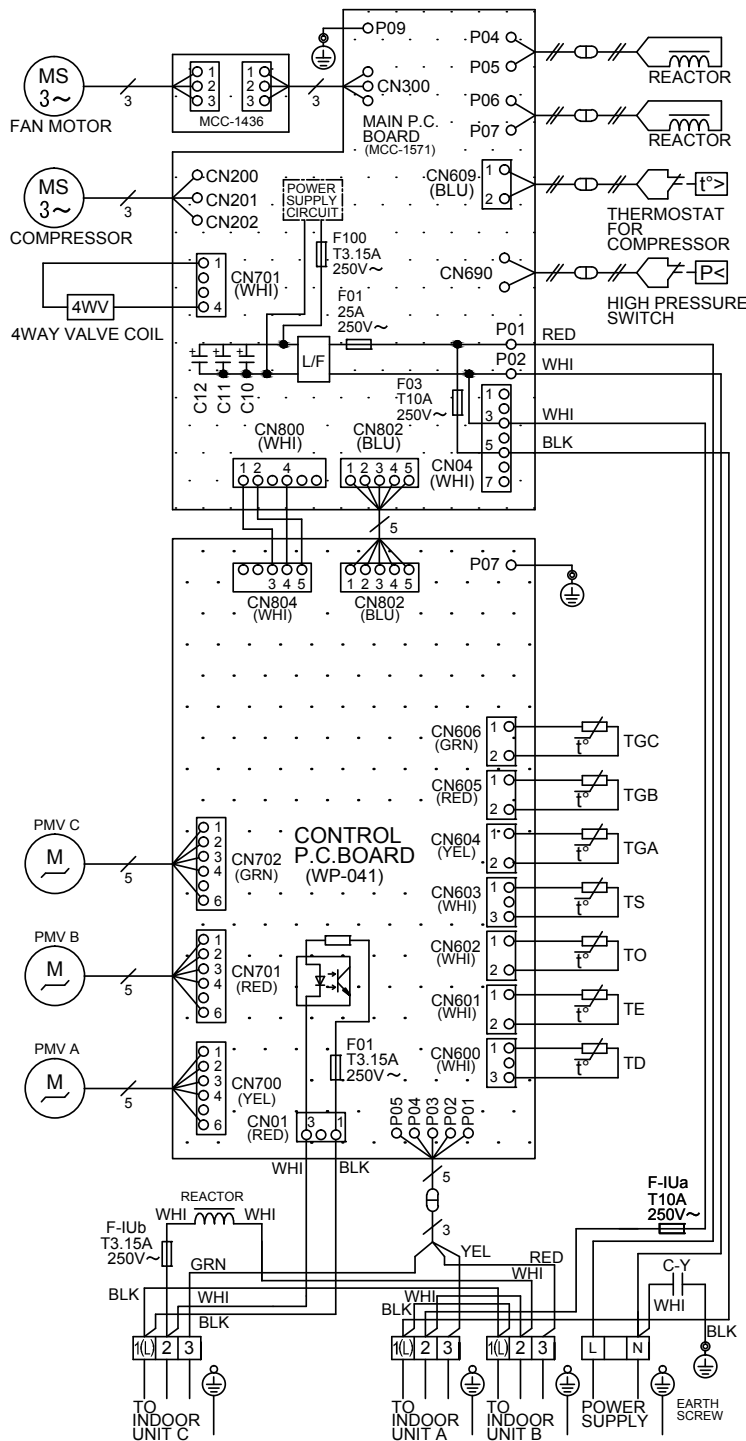


**Fig. 3-5-1 Prevention of oxidation during brazing**

### 4. CONSTRUCTION VIEWS



### 5. WIRING DIAGRAM



**WIRING DIAGRAM**

TERMINAL OF COMPRESSOR

WHITE(S) BLACK(C)

THE SIGN IN ( ) IS DISPLAYED IN THE TERMINAL COVER.



Symbol	Part name
PMV	PULSE MOTOR VALVE
TD	DISCHARGE PIPE TEMP. SENSOR
TE	CONDENSER PIPE TEMP. SENSOR
TO	OUTDOOR TEMP. SENSOR
TS	SUCTION PIPE TEMP. SENSOR
TGA-TGC	GAS SIDE PIPE TEMP. SENSOR A-C
L / F	LINE FILTER
F-IUa, F-IUb	PROTECTION CONNECTING FUSE a, b
C-Y	Y-CAPACITOR

**CAUTION : HIGH VOLTAGE**

The high voltage circuit is incorporated. Be careful to do the check service, as the electric shock may be caused in case of touching parts on the P.C. board by hand.

**COLOR IDENTIFICATION**

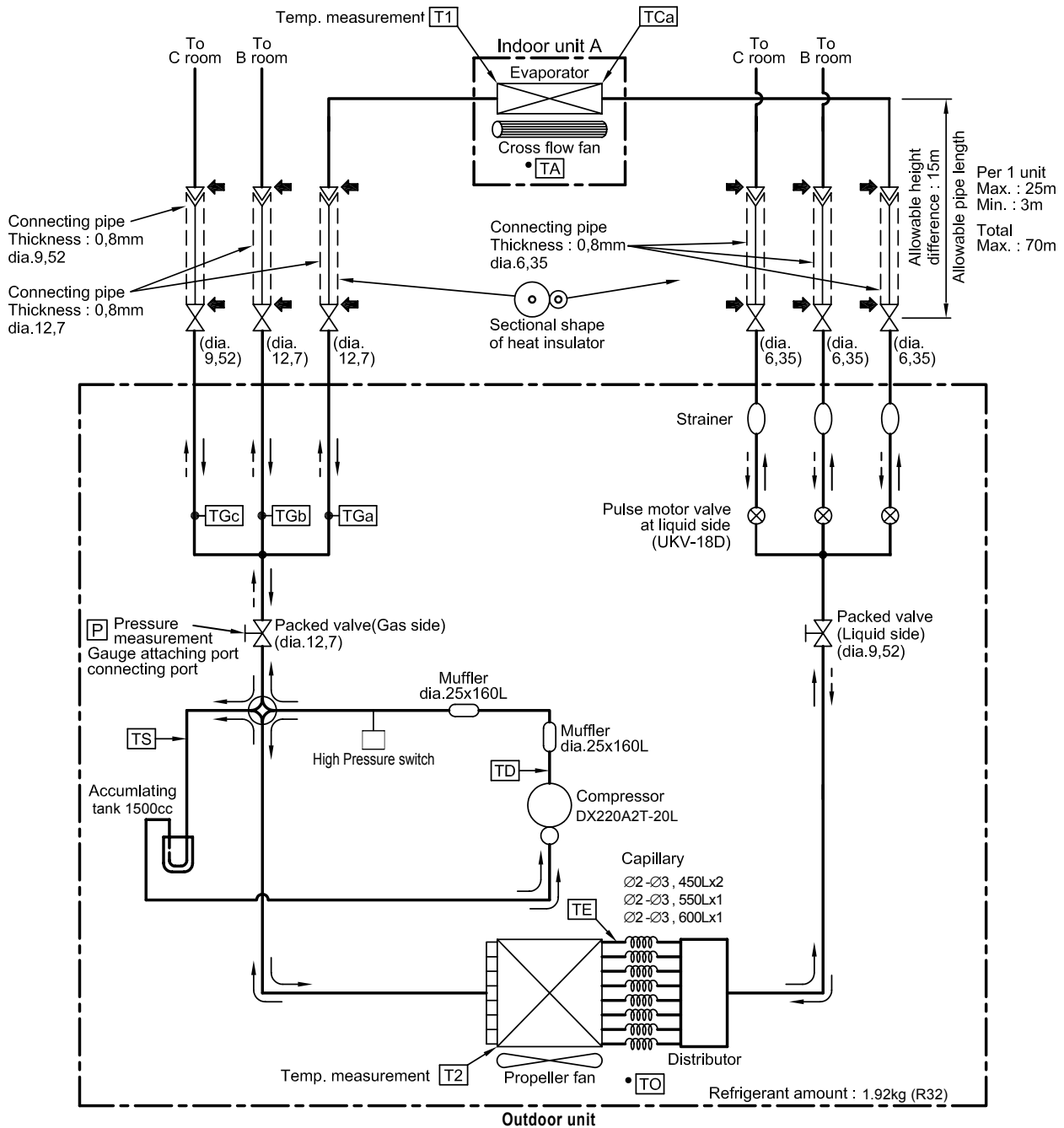
BLK:BLACK	GRN:GREEN
BLU:BLUE	WHI:WHITE
RED:RED	YEL:YELLOW
GRY:GRAY	

## 6. SPECIFICATIONS OF ELECTRICAL PARTS

No.	Parts name	Model name	Rating
1	Compressor	DX220A2T-20L	3 Phases (4-Poles) ; 2000 W
2	Outdoor fan motor	ICF-280-A60-1	Output 60 W
3	Reactor	CH-56-3Z-T	5.8 mH, 18.5 A
4	Reactor	CH-76-2VK	9.9 mH, 1 A
5	4-way valve coil	STF-H01AP1874A1	AC 200–240 V
6	PMV coil	UKV-A039	DC 12 V
7	P.C. board (Main PCB)	MCC-1571	AC 220–240 V
8	P.C. board (Control PCB)	WP-041	AC 220–240 V
9	P.C. board (Fan motor connection)	MCC-1436	AC 220–240V
10	Fuse (Mounted on P.C. board MCC-1571)	—	AC 250V, 25 A
11	Fuse (Mounted on P.C. board MCC-1571)	—	AC 250V, 10 A
12	Fuse (Mounted on P.C. board MCC-1571, WP-041)	—	AC 250V, 3.15 A
13	Outdoor temp. sensor (TO sensor)	—	10 k $\Omega$ (25°C)
14	Evaporator temp. sensor (TE sensor)	—	10 k $\Omega$ (25°C)
15	Discharge temp. sensor (TD sensor)	—	50 k $\Omega$ (25°C)
16	Suction temp. sensor (TS sensor)	—	10 k $\Omega$ (25°C)
17	Temp. sensor at A room gas side (TGa-sensor)	—	10 k $\Omega$ (25°C)
18	Temp. sensor at B room gas side (TGb-sensor)	—	10 k $\Omega$ (25°C)
19	Temp. sensor at C room gas side (TGc-sensor)	—	10 k $\Omega$ (25°C)
20	Compressor thermo.	CS-12AL	ON: 90°C, OFF: 125°C
21	High-pressure SW	ACB-4UB83W	OFF : 4.15MPa
22	Terminal block (3P)	—	AC 250 V, 20 A
23	Terminal block (9P)	—	AC 250 V, 20 A

## 7. REFRIGERANT CYCLE DIAGRAM

### 7.1 Refrigerant cycle diagram



#### NOTE :

- You need not add refrigerant if the piping length is 40m or less.
- If the length exceeds 41m, add 20g of refrigerant per 1 meter over.
- Connection of only one indoor unit is unavailable. Two or more indoor units should be connected.



## 7-2. Operation Data

### Outdoor Unit: RAS-3M26U2AVG-E,-TR

#### <Cooling>

Operation condition					Cooling mode (Indoor unit high fan speed)				Heating mode (Indoor unit high fan speed)			
Temperature condition					Indoor 27 / 19°C, Outdoor 35 / 24°C				Indoor 20 / - °C, Outdoor 7 / 6°C			
Operating status	Indoor unit				Standard pressure	Heat exchanger pipe temperature		Compressor revolution	Standard pressure	Heat exchanger pipe temperature		Compressor revolution
	A	B	C	E		T1 (°C)	T2 (°C)			T1 (°C)	T2 (°C)	
1 unit	05	-	-	-	0.9~1.1	15~17	36~42	16	2.1~2.3	36~38	3~5	30
	07	-	-	-	0.9~1.1	15~17	36~42	16	2.1~2.3	36~38	3~5	30
	10	-	-	-	0.8~1.0	12~14	36~42	23	2.7~2.9	44~46	2~4	44
	13	-	-	-	0.7~0.9	10~12	36~44	37	3.2~3.4	52~54	2~4	53
	16	-	-	-	0.6~0.8	9~11	36~46	50	3.6~3.9	53~55	2~4	56
	18	-	-	-	0.6~0.8	10~12	36~47	52	3.6~3.9	53~55	2~4	60
	22	-	-	-	0.6~0.8	8~10	36~47	53	3.6~3.9	53~55	2~4	68
	24	-	-	-	0.6~0.8	8~10	36~47	70	3.6~3.9	53~55	2~4	78
2 units	05	05	-	-	0.7~0.9	9~11	46~48	41	2.8~3.0	46~48	0~2	61
	07	05	-	-	0.7~0.9	9~11	46~48	43	2.8~3.0	45~47	0~2	62
	10	05	-	-	0.8~1.0	9~11	46~48	43	2.8~3.0	45~47	0~2	62
	13	05	-	-	0.8~1.0	10~12	46~48	46	2.8~3.0	45~47	0~2	64
	16	05	-	-	0.8~1.0	10~12	46~48	49	2.8~3.0	45~47	0~2	65
	18	05	-	-	0.8~1.0	10~12	46~48	52	2.9~3.1	46~48	0~2	67
	22	05	-	-	0.8~1.0	10~12	47~50	56	2.9~3.1	46~48	0~2	68
	24	05	-	-	0.7~0.9	9~11	50~52	59	3.0~3.2	47~49	-1~1	70
	07	07	-	-	0.8~1.0	10~12	47~49	43	2.8~3.0	45~47	0~2	62
	10	07	-	-	0.8~1.0	10~12	47~49	43	2.8~3.0	45~47	0~2	62
	13	07	-	-	0.8~1.0	10~12	47~49	46	2.8~3.0	45~47	0~2	64
	16	07	-	-	0.8~1.0	10~12	47~49	49	2.8~3.0	45~47	0~2	65
	18	07	-	-	0.8~1.0	10~12	47~49	52	2.9~3.1	46~48	0~2	67
	22	07	-	-	0.8~1.0	10~12	49~51	56	2.9~3.1	46~48	0~2	68
	24	07	-	-	0.7~0.9	9~11	51~53	59	3.0~3.2	47~49	-1~1	70
	10	10	-	-	0.8~1.0	10~12	47~49	43	2.8~3.0	45~47	0~2	62
	13	10	-	-	0.8~1.0	10~12	47~49	49	2.8~3.0	45~47	0~2	65
	16	10	-	-	0.8~1.0	10~12	49~51	52	2.9~3.1	46~48	0~2	67
	18	10	-	-	0.8~1.0	10~12	49~51	56	2.9~3.1	46~48	0~2	68
	22	10	-	-	0.7~0.9	9~11	51~53	59	3.0~3.2	47~49	-1~1	70
	24	10	-	-	0.7~0.9	9~11	51~53	62	3.1~3.3	48~50	-1~1	71
	13	13	-	-	0.8~1.0	10~12	47~49	35	2.8~3.0	45~47	0~2	68
	16	13	-	-	0.7~0.9	9~11	51~53	59	3.0~3.2	47~49	-1~1	70
	18	13	-	-	0.7~0.9	9~11	51~53	62	3.1~3.3	48~50	-1~1	71
	22	13	-	-	0.7~0.9	9~11	51~53	62	3.1~3.3	48~50	-1~1	71
	24	13	-	-	0.7~0.9	9~11	51~53	62	3.1~3.3	48~50	-1~1	71
	16	16	-	-	0.7~0.9	9~11	52~54	62	3.1~3.3	48~50	-1~1	71
	18	16	-	-	0.7~0.9	9~11	52~54	62	3.1~3.3	48~50	-1~1	71
	22	16	-	-	0.7~0.9	9~11	52~54	62	3.1~3.3	48~50	-1~1	71
	24	16	-	-	0.7~0.9	9~11	52~54	62	3.1~3.3	48~50	-1~1	71
	18	18	-	-	0.7~0.9	9~11	52~54	62	3.1~3.3	48~50	-1~1	71
	22	18	-	-	0.7~0.9	9~11	52~54	62	3.1~3.3	48~50	-1~1	71
24	18	-	-	0.7~0.9	9~11	52~54	62	3.1~3.3	48~50	-1~1	71	
3 units	05	05	05	-	0.7~0.9	10~12	50~52	58	2.4~2.6	40~42	0~2	57
	07	05	05	-	0.7~0.9	10~12	50~52	59	2.4~2.6	40~42	-1~1	57
	10	05	05	-	0.8~1.0	11~13	51~53	60	2.4~2.6	39~41	-1~1	58
	13	05	05	-	0.8~1.0	11~13	51~53	60	2.3~2.5	38~40	-1~1	59
	16	05	05	-	0.8~1.0	11~13	51~53	60	2.3~2.5	38~40	-1~1	59
	18	05	05	-	0.8~1.0	11~13	51~53	60	2.3~2.5	38~40	-1~1	59
	22	05	05	-	0.8~1.0	11~13	51~53	60	2.3~2.5	38~40	-1~1	59
	24	05	05	-	0.8~1.0	11~13	51~53	60	2.3~2.5	38~40	-1~1	59
	07	07	05	-	0.8~1.0	11~13	51~53	60	2.3~2.5	38~40	-1~1	59
	10	07	05	-	0.8~1.0	11~13	51~53	60	2.3~2.5	38~40	-1~1	59
	13	07	05	-	0.8~1.0	11~13	51~53	60	2.3~2.5	38~40	-1~1	59
	16	07	05	-	0.8~1.0	11~13	51~53	60	2.3~2.5	38~40	-1~1	59
	18	07	05	-	0.8~1.0	11~13	51~53	60	2.3~2.5	38~40	-1~1	59
	22	07	05	-	0.8~1.0	11~13	51~53	60	2.3~2.5	38~40	-1~1	59
	24	07	05	-	0.8~1.0	11~13	51~53	60	2.3~2.5	38~40	-1~1	59
	10	10	05	-	0.8~1.0	11~13	51~53	60	2.3~2.5	38~40	-1~1	59
	13	10	05	-	0.8~1.0	11~13	51~53	60	2.3~2.5	38~40	-1~1	59
	16	10	05	-	0.8~1.0	11~13	51~53	60	2.3~2.5	38~40	-1~1	59
	18	10	05	-	0.8~1.0	11~13	51~53	60	2.3~2.5	38~40	-1~1	59
	22	10	05	-	0.8~1.0	11~13	51~53	60	2.3~2.5	38~40	-1~1	59
	24	10	05	-	0.8~1.0	11~13	51~53	60	2.3~2.5	38~40	-1~1	59
	13	13	05	-	0.8~1.0	11~13	51~53	60	2.5~2.7	37~39	-2~0	60
	16	13	05	-	0.8~1.0	11~13	51~53	60	2.3~2.5	38~40	-1~1	59
	18	13	05	-	0.8~1.0	11~13	51~53	60	2.3~2.5	38~40	-1~1	59
	22	13	05	-	0.8~1.0	11~13	51~53	60	2.5~2.7	37~39	-2~0	60
	24	13	05	-	0.8~1.0	11~13	51~53	60	2.5~2.7	37~39	-2~0	60
	16	16	05	-	0.8~1.0	11~13	51~53	60	2.5~2.7	37~39	-2~0	60
	18	16	05	-	0.8~1.0	11~13	51~53	60	2.5~2.7	37~39	-2~0	60
	22	16	05	-	0.8~1.0	11~13	51~53	60	2.5~2.7	37~39	-2~0	60
	24	16	05	-	0.8~1.0	11~13	51~53	60	2.5~2.7	37~39	-2~0	60
	07	07	07	-	0.8~1.0	11~13	51~53	60	2.3~2.5	38~40	-1~1	72
	10	07	07	-	0.8~1.0	11~13	51~53	60	2.3~2.5	38~40	-1~1	72
13	07	07	-	0.8~1.0	11~13	51~53	60	2.3~2.5	38~40	-1~1	72	
16	07	07	-	0.8~1.0	11~13	51~53	60	2.3~2.5	38~40	-1~1	72	
18	07	07	-	0.8~1.0	11~13	51~53	60	2.3~2.5	38~40	-1~1	72	
22	07	07	-	0.8~1.0	11~13	51~53	60	2.3~2.5	38~40	-1~1	72	
24	07	07	-	0.8~1.0	11~13	51~53	60	2.3~2.5	38~40	-1~1	73	
10	10	07	-	0.8~1.0	11~13	51~53	60	2.3~2.5	38~40	-1~1	72	
13	10	07	-	0.8~1.0	11~13	51~53	60	2.3~2.5	38~40	-1~1	72	
16	10	07	-	0.8~1.0	11~13	51~53	60	2.3~2.5	38~40	-1~1	72	

#### NOTES:

1. Measure surface temperature of heat exchanger pipe around of heat exchanger path U bent. (Thermistor thermometer)
2. Connecting piping condition : 5 meters × 3 units (5 m / each indoor unit)

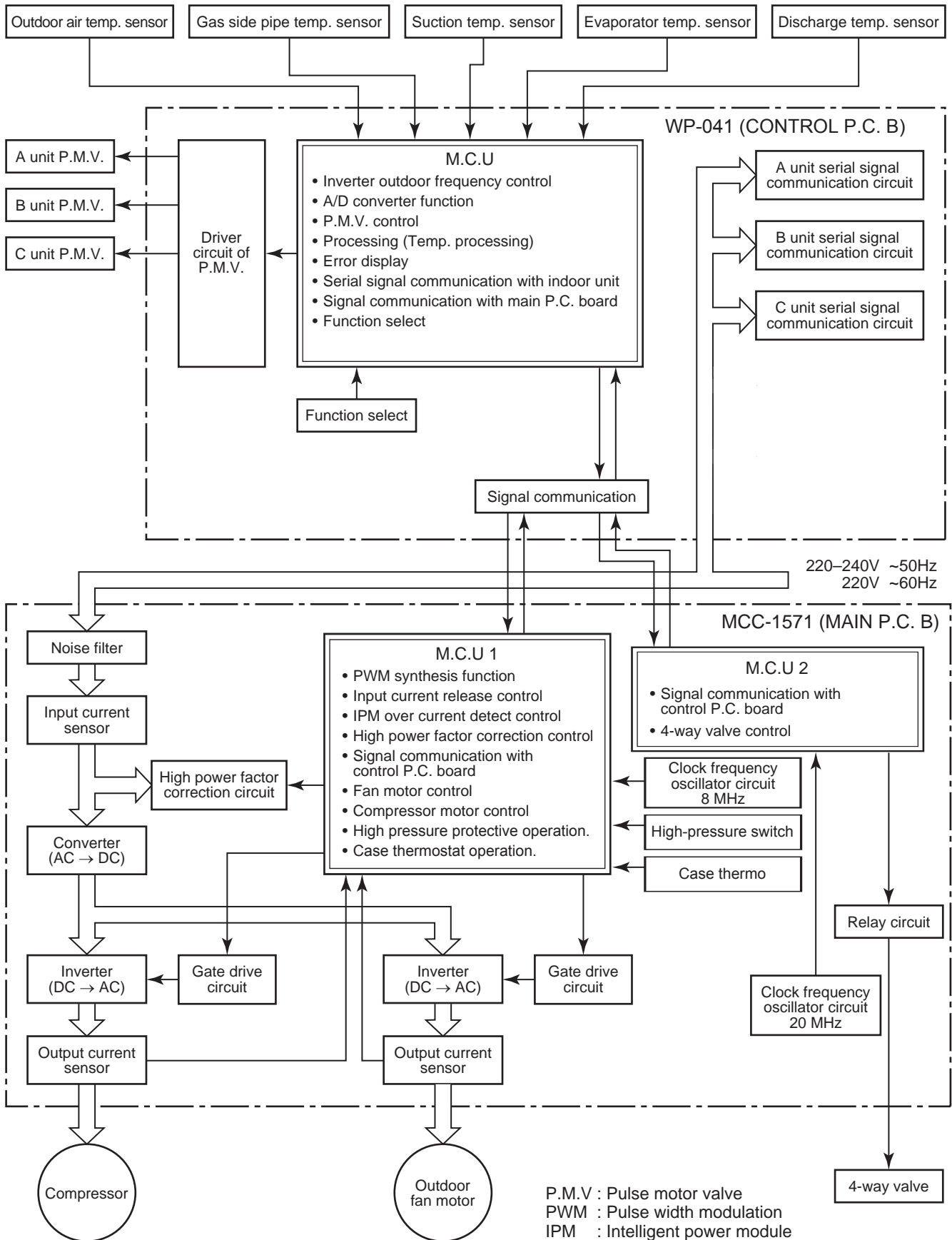
Operation condition					Cooling mode (Indoor unit high fan speed)				Heating mode (Indoor unit high fan speed)				
Temperature condition					Indoor 27 / 19°C, Outdoor 35 / 24°C				Indoor 20 / - °C, Outdoor 7 / 6°C				
Operating status	Indoor unit				Standard pressure	Heat exchanger pipe temperature		Compressor revolution	Standard pressure	Heat exchanger pipe temperature		Compressor revolution	
	A	B	C	E	P (MPa)	T1 (°C)	T2 (°C)	(rps)	P (MPa)	T1 (°C)	T2 (°C)	(rps)	
3 units (continued)	18	10	07	-	-	0.8~1.0	11~13	51~53	60	2.5~2.7	37~39	-2~0	72
	22	10	07	-	-	0.8~1.0	11~13	51~53	60	2.3~2.5	38~40	-1~1	73
	24	10	07	-	-	0.8~1.0	11~13	51~53	60	2.3~2.5	38~40	-1~1	73
	13	13	07	-	-	0.8~1.0	11~13	51~53	60	2.5~2.7	37~39	-2~0	72
	16	13	07	-	-	0.8~1.0	11~13	51~53	60	2.5~2.7	37~39	-2~0	73
	18	13	07	-	-	0.8~1.0	11~13	51~53	60	2.5~2.7	37~39	-2~0	73
	22	13	07	-	-	0.8~1.0	11~13	51~53	60	2.5~2.7	37~39	-2~0	73
	24	13	07	-	-	0.8~1.0	11~13	51~53	60	2.5~2.7	37~39	-2~0	73
	16	16	07	-	-	0.8~1.0	11~13	51~53	60	2.5~2.7	37~39	-2~0	73
	18	16	07	-	-	0.8~1.0	11~13	51~53	60	2.5~2.7	37~39	-2~0	73
	22	16	07	-	-	0.8~1.0	11~13	51~53	60	2.5~2.7	37~39	-2~0	73
	24	16	07	-	-	0.8~1.0	11~13	51~53	60	2.5~2.7	37~39	-2~0	73
	10	10	10	-	-	0.8~1.0	11~13	51~53	60	2.3~2.5	38~40	-1~1	72
	13	10	10	-	-	0.8~1.0	11~13	51~53	60	2.3~2.5	38~40	-1~1	72
	16	10	10	-	-	0.8~1.0	11~13	51~53	60	2.5~2.7	37~39	-2~0	72
	18	10	10	-	-	0.8~1.0	11~13	51~53	60	2.5~2.7	37~39	-2~0	73
	22	10	10	-	-	0.8~1.0	11~13	51~53	60	2.5~2.7	37~39	-2~0	73
	24	10	10	-	-	0.8~1.0	11~13	51~53	60	2.5~2.7	37~39	-2~0	73
	13	13	10	-	-	0.8~1.0	11~13	51~53	60	2.5~2.7	37~39	-2~0	73
	16	13	10	-	-	0.8~1.0	11~13	51~53	60	2.5~2.7	37~39	-2~0	73
	18	13	10	-	-	0.8~1.0	11~13	51~53	60	2.5~2.7	37~39	-2~0	73
	22	13	10	-	-	0.8~1.0	11~13	51~53	60	2.5~2.7	37~39	-2~0	73
	24	13	10	-	-	0.8~1.0	11~13	51~53	60	2.5~2.7	37~39	-2~0	73
	16	16	10	-	-	0.8~1.0	11~13	51~53	60	2.5~2.7	37~39	-2~0	73
	18	16	10	-	-	0.8~1.0	11~13	51~53	60	2.5~2.7	37~39	-2~0	73
	22	16	10	-	-	0.8~1.0	11~13	51~53	60	2.5~2.7	37~39	-2~0	73
	24	16	10	-	-	0.8~1.0	11~13	51~53	60	2.5~2.7	37~39	-2~0	73
	13	13	13	-	-	0.8~1.0	11~13	51~53	60	2.5~2.7	37~39	-2~0	73
	16	13	13	-	-	0.8~1.0	11~13	51~53	60	2.5~2.7	37~39	-2~0	73
	18	13	13	-	-	0.8~1.0	11~13	51~53	60	2.5~2.7	37~39	-2~0	73
	22	13	13	-	-	0.8~1.0	11~13	51~53	60	2.5~2.7	37~39	-2~0	73
	24	13	13	-	-	0.8~1.0	11~13	51~53	60	2.5~2.7	37~39	-2~0	73
	16	16	13	-	-	0.8~1.0	11~13	51~53	60	2.5~2.7	37~39	-2~0	73
	22	16	13	-	-	0.8~1.0	11~13	51~53	60	2.5~2.7	37~39	-2~0	73
	24	16	13	-	-	0.8~1.0	11~13	51~53	60	2.5~2.7	37~39	-2~0	73
	16	16	16	-	-	0.8~1.0	11~13	51~53	60	2.5~2.7	37~39	-2~0	73
	18	16	16	-	-	0.8~1.0	11~13	51~53	60	2.5~2.7	37~39	-2~0	73
	22	16	16	-	-	0.8~1.0	11~13	51~53	60	2.5~2.7	37~39	-2~0	73

**NOTES:**

1. Measure surface temperature of heat exchanger pipe around of heat exchanger path U bent. (Thermistor thermometer)
2. Connecting piping condition : 5 meters × 3 units (5 m / each indoor unit)

### 8. CONTROL BLOCK DIAGRAM

#### 8-1. Outdoor Unit (Inverter Assembly)



## 9. OPERATION DESCRIPTION

### 9-1. Outline of Air Conditioner Control

This air conditioner is a capacity-variable type air conditioner, which uses DC motor for the indoor fan motor and the outdoor fan motor. And the capacity-proportional control compressor which can change the motor speed in the range from 12 to 100 rps is mounted.

The DC motor drive circuit is mounted to the indoor unit. The compressor and the inverter to control fan motor are mounted to the outdoor unit.

The entire air conditioner is mainly controlled by the indoor unit controller.

The indoor unit controller drives the indoor fan motor based upon command sent from the remote controller, and transfers the operation command to the outdoor unit controller.

The outdoor unit controller receives operation command from the indoor unit side, and controls the outdoor fan and the pulse motor valve. (PMV)

Besides, detecting revolution position of the compressor motor, the outdoor unit controller controls speed of the compressor motor by controlling output voltage of the inverter and switching timing of the supply power (current transfer timing) so that motors drive according to the operation command.

And then, the outdoor unit controller transfers reversely the operating status information of the outdoor unit to control the indoor unit controller.

---

**As the compressor adopts four-pole brushless DC motor, the frequency of the supply power from inverter to compressor is two-times cycles of the actual number of revolution.**

---

#### 1. Role of indoor unit controller

The indoor unit controller judges the operation commands from the remote controller and assumes the following functions.

- Judgment of suction air temperature of the indoor heat exchanger by using the indoor temp. sensor. (TA sensor)
- Judgment of the indoor heat exchanger temperature by using heat exchanger sensor (TC sensor) (Prevent-freezing control, etc.)
- Louver motor control
- Indoor fan motor operation control
- LED (Light Emitting Diode) display control
- Transferring of operation command signal (Serial signal) to the outdoor unit
- Reception of information of operation status (Serial signal including outside temp. data) to the outdoor unit and judgment/display of error
- Air purifier operation control

#### 2. Role of outdoor unit controller

Receiving the operation command signal (Serial signal) from the indoor unit controller, the outdoor unit performs its role.

- Compressor operation control
  - Operation control of outdoor fan motor
  - P.M.V. control
  - 4-way valve control
- } Operations followed to judgment of serial signal from indoor side.

- Detection of inverter input current and current release operation
- Over-current detection and prevention operation to IGBT module (Compressor stop function)
- Compressor and outdoor fan stop function when serial signal is off (when the serial signal does not reach the board assembly of outdoor control by trouble of the signal system)
- Transferring of operation information (Serial signal) from outdoor unit controller to indoor unit controller
- Detection of outdoor temperature and operation revolution control
- Defrost control in heating operation (Temp. measurement by outdoor heat exchanger and control for 4-way valve and outdoor fan)

#### 3. Contents of operation command signal (Serial signal) from indoor unit controller to outdoor unit controller

The following three types of signals are sent from the indoor unit controller.

- Operation mode set on the remote controller
- Compressor revolution command signal defined by indoor temperature and set temperature (Correction along with variation of room temperature and correction of indoor heat exchanger temperature are added.)
- Temperature of indoor heat exchanger
- For these signals ([Operation mode] and [Compressor revolution] indoor heat exchanger temperature), the outdoor unit controller monitors the input current to the inverter, and performs the followed operation within the range that current does not exceed the allowable value.

#### 4. Contents of operation command signal (Serial signal) from outdoor unit controller to indoor unit controller

The following signals are sent from the outdoor unit controller.

- The current operation mode
  - The current compressor revolution
  - Outdoor temperature
  - Existence of protective circuit operation
- For transferring of these signals, the indoor unit controller monitors the contents of signals, and judges existence of trouble occurrence. Contents of judgment are described below.
- Whether distinction of the current operation status meets to the operation command signal
  - Whether protective circuit operates
- When no signal is received from the outdoor unit controller, it is assumed as a trouble.

**9-2. Operation Description**

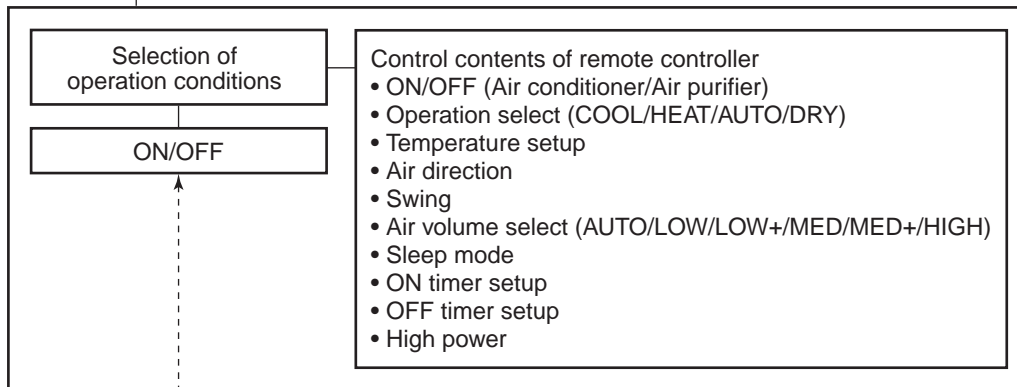
- 1. Basic operation ..... 38
  - 1. Operation control ..... 38
  - 2. Operating mode selection when performing 2-room operation ..... 39
  - 3. Cooling/Heating operation ..... 39
- 2. Outdoor fan motor control ..... 40
- 3. Capacity control ..... 41
- 4. Current release control ..... 41
- 5. Winding/Coil heating control ..... 42
- 6. Defrost control (Only in heating operation) ..... 42
- 7. Compressor protective control ..... 42
- 8. Discharge temperature control ..... 43
- 9. Pulse motor valve (PMV) control ..... 43
- 10. High-pressure switch/Compressor case thermostat control ..... 43

**9-3. Service switch (SW801, SW802) operations ..... 44**

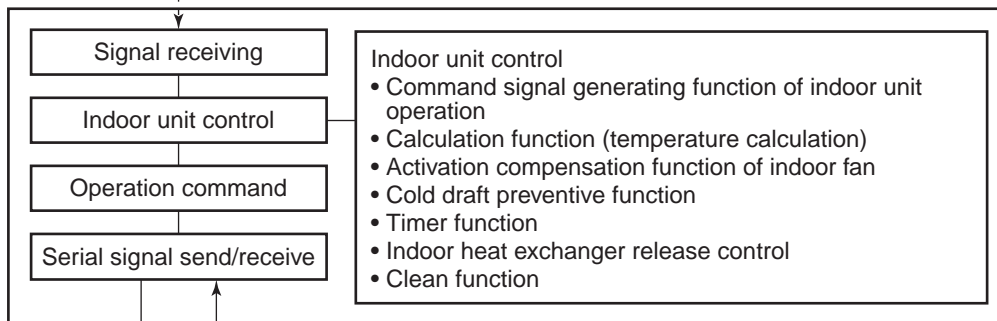
**9-4. Intermittent Operation Control for Indoor Fans of the Indoor Unit  
at Thermo-off Side in Heating Operation..... 52**

Item	Operation flow and applicable data, etc.	Description
<p>1. Basic operation</p>	<p><b>1. Operation control</b></p> <p>Receiving the user's operation condition setup, the operation statuses of indoor/outdoor units are controlled.</p> <ol style="list-style-type: none"> <li>1) The operation conditions are selected by the remote controller as shown in the below.</li> <li>2) A signal is sent by ON button of the remote controller.</li> <li>3) The signal is received by a sensor of the indoor unit and processed by the indoor controllers as shown in the below.</li> <li>4) The indoor controller controls the indoor fan motor and louver motor.</li> <li>5) The indoor controller sends the operation command to the outdoor controller, and sends/receives the control status with a serial signal.</li> <li>6) The outdoor controller controls the operation as shown in the below, and also controls the compressor, outdoor fan motor, 4-way valve and pulse motor valve.</li> </ol>	

**Remote controller**

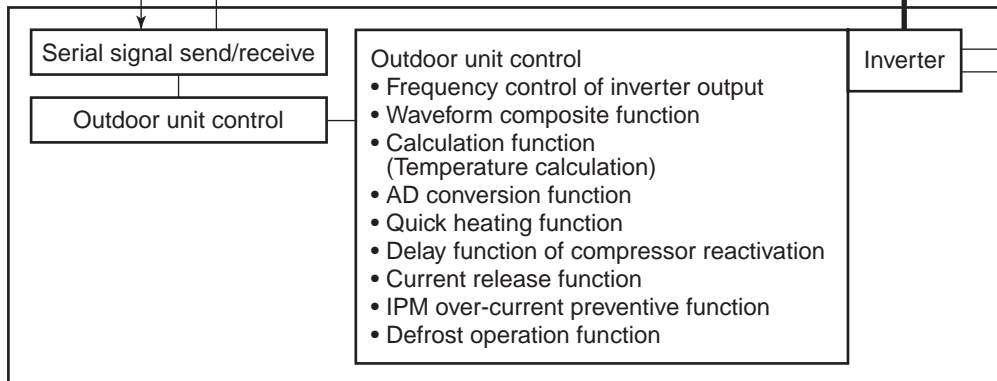


**Indoor unit**

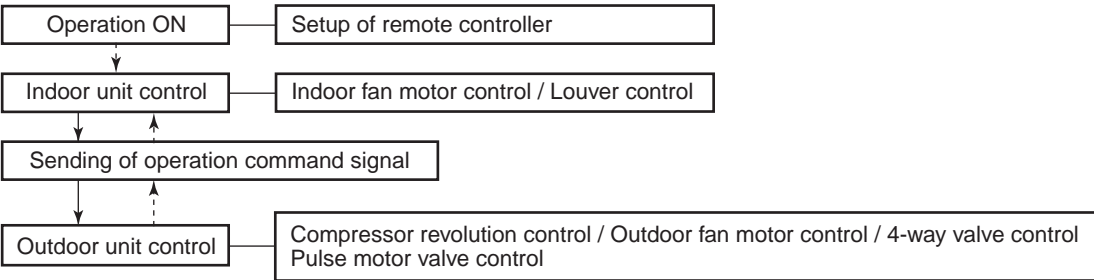


- Indoor fan motor
- Louver motor
- Moving panel motor
- Air purifier

**Outdoor unit**

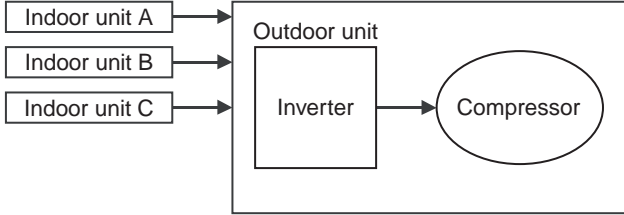


- Compressor
- Outdoor fan motor
- 4-way valve
- Pulse motor valve (P.M.V.)

Item	Operation flow and applicable data, etc.	Description																																																																																																																																					
1. Basic operation	<p><b>2. Operating mode selection when performing 2-room operation</b></p> <p>1) The outdoor unit operating mode conforms to the instructions of the indoor unit that was pushed first.</p> <p>2) When combined operation consisting of cooling (dry) and heating, fan (air purification) and heating, or cleaning operation and heating is performed, operation conforms to the instructions of the indoor unit that was pushed first as shown in the following table.</p> <p>3) The indoor fan stops for the indoor unit that was pushed last and which instructions are ignored.</p> <p>4) When three or four indoor units are operated concurrently, the priority is also given to operating mode of the indoor unit which was pushed first as same as the case when two indoor units are operated concurrently.</p> <table border="1" data-bbox="331 504 1428 1413"> <thead> <tr> <th>No.</th> <th>Indoor unit</th> <th>Set operating mode</th> <th>Actual indoor unit operation</th> <th>Actual outdoor unit operation</th> </tr> </thead> <tbody> <tr> <td rowspan="2">1</td> <td>Pushed first</td> <td>Cooling (dry)</td> <td>Cooling (dry)</td> <td rowspan="2">Cooling</td> </tr> <tr> <td>Pushed last</td> <td>Cooling (dry)</td> <td>Cooling (dry)</td> </tr> <tr> <td rowspan="2">2</td> <td>Pushed first</td> <td>Heating</td> <td>Heating</td> <td rowspan="2">Heating</td> </tr> <tr> <td>Pushed last</td> <td>Heating</td> <td>Heating</td> </tr> <tr> <td rowspan="2">3</td> <td>Pushed first</td> <td>Fan (solo air purification)</td> <td>Fan (solo air purification)</td> <td rowspan="2">Stopped</td> </tr> <tr> <td>Pushed last</td> <td>Fan (solo air purification)</td> <td>Fan (solo air purification)</td> </tr> <tr> <td rowspan="2">4</td> <td>Pushed first</td> <td>Fan (solo air purification)</td> <td>Fan (solo air purification)</td> <td rowspan="2">Cooling</td> </tr> <tr> <td>Pushed last</td> <td>Cooling (dry)</td> <td>Cooling (dry)</td> </tr> <tr> <td rowspan="2">5</td> <td>Pushed first</td> <td>Cooling (dry)</td> <td>Cooling (dry)</td> <td rowspan="2">Cooling</td> </tr> <tr> <td>Pushed last</td> <td>Fan (solo air purification)</td> <td>Fan (solo air purification)</td> </tr> <tr> <td rowspan="2">6</td> <td>Pushed first</td> <td>Cooling (dry)</td> <td>Cooling (dry)</td> <td rowspan="2">Cooling</td> </tr> <tr> <td>Pushed last</td> <td>Heating</td> <td>Fan stopped</td> </tr> <tr> <td rowspan="2">7</td> <td>Pushed first</td> <td>Heating</td> <td>Heating</td> <td rowspan="2">Heating</td> </tr> <tr> <td>Pushed last</td> <td>Cooling (dry)</td> <td>Fan stopped</td> </tr> <tr> <td rowspan="2">8</td> <td>Pushed first</td> <td>Fan (solo air purification)</td> <td>Fan (solo air purification)</td> <td rowspan="2">Stopped</td> </tr> <tr> <td>Pushed last</td> <td>Heating</td> <td>Fan stopped</td> </tr> <tr> <td rowspan="2">9</td> <td>Pushed first</td> <td>Heating</td> <td>Heating</td> <td rowspan="2">Heating</td> </tr> <tr> <td>Pushed last</td> <td>Fan (solo air purification)</td> <td>Fan stopped</td> </tr> <tr> <td rowspan="2">10</td> <td>Pushed first</td> <td>Cleaning operation</td> <td>Cleaning operation</td> <td rowspan="2">Stopped</td> </tr> <tr> <td>Pushed last</td> <td>Cleaning operation</td> <td>Cleaning operation</td> </tr> <tr> <td rowspan="2">11</td> <td>Pushed first</td> <td>Cleaning operation</td> <td>Cleaning operation</td> <td rowspan="2">Cooling</td> </tr> <tr> <td>Pushed last</td> <td>Cooling (dry)</td> <td>Cooling (dry)</td> </tr> <tr> <td rowspan="2">12</td> <td>Pushed first</td> <td>Cooling (dry)</td> <td>Cooling (dry)</td> <td rowspan="2">Cooling</td> </tr> <tr> <td>Pushed last</td> <td>Cleaning operation</td> <td>Cleaning operation</td> </tr> <tr> <td rowspan="2">13</td> <td>Pushed first</td> <td>Cleaning operation</td> <td>Cleaning operation</td> <td rowspan="2">Stopped</td> </tr> <tr> <td>Pushed last</td> <td>Fan (solo air purification)</td> <td>Fan (solo air purification)</td> </tr> <tr> <td rowspan="2">14</td> <td>Pushed first</td> <td>Fan (solo air purification)</td> <td>Fan (solo air purification)</td> <td rowspan="2">Stopped</td> </tr> <tr> <td>Pushed last</td> <td>Cleaning operation</td> <td>Cleaning operation</td> </tr> <tr> <td rowspan="2">15</td> <td>Pushed first</td> <td>Cleaning operation</td> <td>Cleaning operation</td> <td rowspan="2">Stopped</td> </tr> <tr> <td>Pushed last</td> <td>Heating</td> <td>Fan stopped</td> </tr> <tr> <td rowspan="2">16</td> <td>Pushed first</td> <td>Heating</td> <td>Heating</td> <td rowspan="2">Heating</td> </tr> <tr> <td>Pushed last</td> <td>Cleaning operation</td> <td>Fan stopped</td> </tr> </tbody> </table>	No.	Indoor unit	Set operating mode	Actual indoor unit operation	Actual outdoor unit operation	1	Pushed first	Cooling (dry)	Cooling (dry)	Cooling	Pushed last	Cooling (dry)	Cooling (dry)	2	Pushed first	Heating	Heating	Heating	Pushed last	Heating	Heating	3	Pushed first	Fan (solo air purification)	Fan (solo air purification)	Stopped	Pushed last	Fan (solo air purification)	Fan (solo air purification)	4	Pushed first	Fan (solo air purification)	Fan (solo air purification)	Cooling	Pushed last	Cooling (dry)	Cooling (dry)	5	Pushed first	Cooling (dry)	Cooling (dry)	Cooling	Pushed last	Fan (solo air purification)	Fan (solo air purification)	6	Pushed first	Cooling (dry)	Cooling (dry)	Cooling	Pushed last	Heating	Fan stopped	7	Pushed first	Heating	Heating	Heating	Pushed last	Cooling (dry)	Fan stopped	8	Pushed first	Fan (solo air purification)	Fan (solo air purification)	Stopped	Pushed last	Heating	Fan stopped	9	Pushed first	Heating	Heating	Heating	Pushed last	Fan (solo air purification)	Fan stopped	10	Pushed first	Cleaning operation	Cleaning operation	Stopped	Pushed last	Cleaning operation	Cleaning operation	11	Pushed first	Cleaning operation	Cleaning operation	Cooling	Pushed last	Cooling (dry)	Cooling (dry)	12	Pushed first	Cooling (dry)	Cooling (dry)	Cooling	Pushed last	Cleaning operation	Cleaning operation	13	Pushed first	Cleaning operation	Cleaning operation	Stopped	Pushed last	Fan (solo air purification)	Fan (solo air purification)	14	Pushed first	Fan (solo air purification)	Fan (solo air purification)	Stopped	Pushed last	Cleaning operation	Cleaning operation	15	Pushed first	Cleaning operation	Cleaning operation	Stopped	Pushed last	Heating	Fan stopped	16	Pushed first	Heating	Heating	Heating	Pushed last	Cleaning operation	Fan stopped	
No.	Indoor unit	Set operating mode	Actual indoor unit operation	Actual outdoor unit operation																																																																																																																																			
1	Pushed first	Cooling (dry)	Cooling (dry)	Cooling																																																																																																																																			
	Pushed last	Cooling (dry)	Cooling (dry)																																																																																																																																				
2	Pushed first	Heating	Heating	Heating																																																																																																																																			
	Pushed last	Heating	Heating																																																																																																																																				
3	Pushed first	Fan (solo air purification)	Fan (solo air purification)	Stopped																																																																																																																																			
	Pushed last	Fan (solo air purification)	Fan (solo air purification)																																																																																																																																				
4	Pushed first	Fan (solo air purification)	Fan (solo air purification)	Cooling																																																																																																																																			
	Pushed last	Cooling (dry)	Cooling (dry)																																																																																																																																				
5	Pushed first	Cooling (dry)	Cooling (dry)	Cooling																																																																																																																																			
	Pushed last	Fan (solo air purification)	Fan (solo air purification)																																																																																																																																				
6	Pushed first	Cooling (dry)	Cooling (dry)	Cooling																																																																																																																																			
	Pushed last	Heating	Fan stopped																																																																																																																																				
7	Pushed first	Heating	Heating	Heating																																																																																																																																			
	Pushed last	Cooling (dry)	Fan stopped																																																																																																																																				
8	Pushed first	Fan (solo air purification)	Fan (solo air purification)	Stopped																																																																																																																																			
	Pushed last	Heating	Fan stopped																																																																																																																																				
9	Pushed first	Heating	Heating	Heating																																																																																																																																			
	Pushed last	Fan (solo air purification)	Fan stopped																																																																																																																																				
10	Pushed first	Cleaning operation	Cleaning operation	Stopped																																																																																																																																			
	Pushed last	Cleaning operation	Cleaning operation																																																																																																																																				
11	Pushed first	Cleaning operation	Cleaning operation	Cooling																																																																																																																																			
	Pushed last	Cooling (dry)	Cooling (dry)																																																																																																																																				
12	Pushed first	Cooling (dry)	Cooling (dry)	Cooling																																																																																																																																			
	Pushed last	Cleaning operation	Cleaning operation																																																																																																																																				
13	Pushed first	Cleaning operation	Cleaning operation	Stopped																																																																																																																																			
	Pushed last	Fan (solo air purification)	Fan (solo air purification)																																																																																																																																				
14	Pushed first	Fan (solo air purification)	Fan (solo air purification)	Stopped																																																																																																																																			
	Pushed last	Cleaning operation	Cleaning operation																																																																																																																																				
15	Pushed first	Cleaning operation	Cleaning operation	Stopped																																																																																																																																			
	Pushed last	Heating	Fan stopped																																																																																																																																				
16	Pushed first	Heating	Heating	Heating																																																																																																																																			
	Pushed last	Cleaning operation	Fan stopped																																																																																																																																				
	<p><b>3. Cooling/Heating operation</b></p> <p>The operations are performed in the following parts by controls according to cooling/heating conditions.</p> <p>1) Receiving the operation ON signal of the remote controller, the cooling or heating operation signal starts being transferred from the indoor controller to the outdoor unit.</p> <p>2) At the indoor unit side, the indoor fan is operated according to the contents of "2. Indoor fan motor control" and the louver according to the contents of "10. Louver control", respectively.</p> <p>3) The outdoor unit controls the outdoor fan motor, compressor, pulse motor valve (PMV) and 4-way valve according to the operation signal sent from the indoor unit.</p> <p>*1. The relay of 4-way valve is turned on, for a few seconds when 4-way valve is driven.</p>  <pre> graph TD     A[Operation ON] --&gt; B[Indoor unit control]     C[Setup of remote controller] --- B     B --&gt; D[Sending of operation command signal]     D --&gt; E[Outdoor unit control]     E --&gt; D     F[Indoor fan motor control / Louver control] --- B     G[Compressor revolution control / Outdoor fan motor control / 4-way valve control / Pulse motor valve control] --- E     </pre>																																																																																																																																						

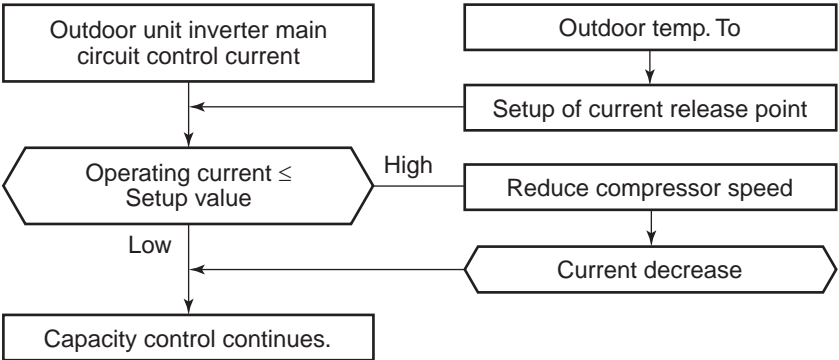
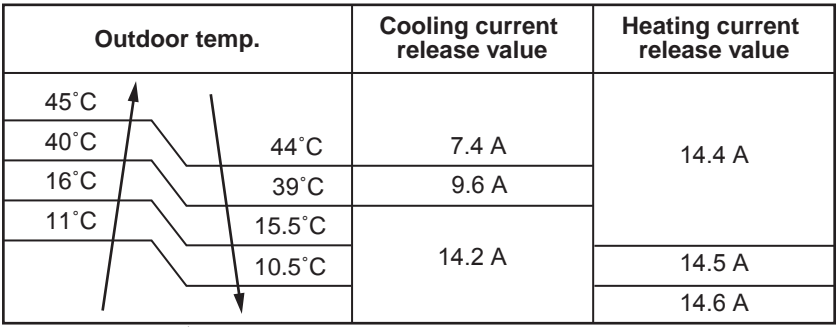
Item	Operation flow and applicable data, etc.	Description																																																												
<p>2. Outdoor fan motor control</p>	<p>The blowing air volume at the outdoor unit side is controlled. Receiving the operation command from the controller of indoor unit, the controller of outdoor unit controls fan speed.</p> <p>* For the fan motor, a DC motor with non-stage variable speed system is used. However, it is limited to 8 stages for reasons of controlling.</p> <pre> graph TD     A[Air conditioner ON (Remote controller)] --&gt; B[Indoor unit controller]     B --&gt; C[1) Outdoor unit operation command (Outdoor fan control)]     C --&gt; D{2) Fan speed ≥ 400 when the motor stopped.}     D -- YES --&gt; E[OFF status of fan motor continues.]     D -- NO --&gt; F[Fan motor ON]     F --&gt; G{3) Fan lock}     G -- YES --&gt; H[Air conditioner OFF]     H --&gt; I[Alarm display]     G -- NO --&gt; J[4) Motor operates as shown in the table below.]                     </pre>	<ol style="list-style-type: none"> <li>1) The operation command sent from the remote controller is processed by the indoor unit controller and transferred to the controller of the outdoor unit.</li> <li>2) When strong wind blows at outdoor side, the operation of air conditioner continues with the fan motor stopped.</li> <li>3) Whether the fan is locked or not is detected, and the operation of air conditioner stops and an alarm is displayed if the fan is locked.</li> <li>4) According to each operation mode, by the conditions of outdoor temperature (To) and compressor revolution, the speed of the outdoor fan shown in the table is selected.</li> </ol>																																																												
<b>Cooling and Dry operation</b>																																																														
<table border="1"> <thead> <tr> <th colspan="2">Compressor revolution (rps)</th> <th>~20.3</th> <th>~50.3</th> <th>~61.6</th> <th>61.6~</th> </tr> </thead> <tbody> <tr> <td rowspan="10">Outdoor temp. sensor To</td> <td rowspan="7">Normal operation</td> <td>To ≥ 38°C</td> <td>450</td> <td>600</td> <td>780</td> <td>780</td> </tr> <tr> <td>28°C ≤ To &lt; 38°C</td> <td>450</td> <td>550</td> <td>600</td> <td>780</td> </tr> <tr> <td>15°C ≤ To &lt; 28°C</td> <td>300</td> <td>550</td> <td>550</td> <td>600</td> </tr> <tr> <td>10°C ≤ To &lt; 15°C</td> <td>300</td> <td>550</td> <td>550</td> <td>550</td> </tr> <tr> <td>5°C ≤ To &lt; 10°C</td> <td>390</td> <td>450</td> <td>450</td> <td>550</td> </tr> <tr> <td>0°C ≤ To &lt; 5°C</td> <td>390</td> <td>300</td> <td>300</td> <td>450</td> </tr> <tr> <td>To &lt; 0°C</td> <td>0</td> <td>0~300</td> <td>0~300</td> <td>0~390</td> </tr> <tr> <td rowspan="2">Sleep operation</td> <td>To ≥ 38°C</td> <td>450</td> <td>550</td> <td>600</td> <td>780</td> </tr> <tr> <td>To &lt; 38°C</td> <td>450</td> <td>550</td> <td>550</td> <td>600</td> </tr> <tr> <td colspan="2">To abnormal</td> <td>450</td> <td>550</td> <td>600</td> <td>780</td> </tr> </tbody> </table>			Compressor revolution (rps)		~20.3	~50.3	~61.6	61.6~	Outdoor temp. sensor To	Normal operation	To ≥ 38°C	450	600	780	780	28°C ≤ To < 38°C	450	550	600	780	15°C ≤ To < 28°C	300	550	550	600	10°C ≤ To < 15°C	300	550	550	550	5°C ≤ To < 10°C	390	450	450	550	0°C ≤ To < 5°C	390	300	300	450	To < 0°C	0	0~300	0~300	0~390	Sleep operation	To ≥ 38°C	450	550	600	780	To < 38°C	450	550	550	600	To abnormal		450	550	600	780
Compressor revolution (rps)		~20.3	~50.3	~61.6	61.6~																																																									
Outdoor temp. sensor To	Normal operation	To ≥ 38°C	450	600	780	780																																																								
		28°C ≤ To < 38°C	450	550	600	780																																																								
		15°C ≤ To < 28°C	300	550	550	600																																																								
		10°C ≤ To < 15°C	300	550	550	550																																																								
		5°C ≤ To < 10°C	390	450	450	550																																																								
		0°C ≤ To < 5°C	390	300	300	450																																																								
		To < 0°C	0	0~300	0~300	0~390																																																								
	Sleep operation	To ≥ 38°C	450	550	600	780																																																								
		To < 38°C	450	550	550	600																																																								
	To abnormal		450	550	600	780																																																								
To : Outdoor temp sensor																																																														
<b>Heating operation</b>																																																														
<table border="1"> <thead> <tr> <th colspan="2">Compressor revolution (rps)</th> <th>~20.3</th> <th>~33.5</th> <th>33.5~</th> </tr> </thead> <tbody> <tr> <td rowspan="9">Outdoor temp. sensor To</td> <td rowspan="4">Normal operation</td> <td>To ≥ 10°C</td> <td>500</td> <td>550</td> <td>550</td> </tr> <tr> <td>0°C ≤ To &lt; 10°C</td> <td>500</td> <td>550</td> <td>650</td> </tr> <tr> <td>-5°C ≤ To &lt; 0°C</td> <td>550</td> <td>650</td> <td>780</td> </tr> <tr> <td>To &lt; -5°C</td> <td>550</td> <td>650</td> <td>780</td> </tr> <tr> <td rowspan="4">Sleep operation</td> <td>To ≥ 10°C</td> <td>500</td> <td>500</td> <td>550</td> </tr> <tr> <td>0°C ≤ To &lt; 10°C</td> <td>500</td> <td>550</td> <td>550</td> </tr> <tr> <td>-5°C ≤ To &lt; 0°C</td> <td>550</td> <td>550</td> <td>550</td> </tr> <tr> <td>To &lt; -5°C</td> <td>550</td> <td>550</td> <td>550</td> </tr> <tr> <td colspan="2">To abnormal</td> <td>500</td> <td>550</td> <td>650</td> </tr> </tbody> </table>			Compressor revolution (rps)		~20.3	~33.5	33.5~	Outdoor temp. sensor To	Normal operation	To ≥ 10°C	500	550	550	0°C ≤ To < 10°C	500	550	650	-5°C ≤ To < 0°C	550	650	780	To < -5°C	550	650	780	Sleep operation	To ≥ 10°C	500	500	550	0°C ≤ To < 10°C	500	550	550	-5°C ≤ To < 0°C	550	550	550	To < -5°C	550	550	550	To abnormal		500	550	650															
Compressor revolution (rps)		~20.3	~33.5	33.5~																																																										
Outdoor temp. sensor To	Normal operation	To ≥ 10°C	500	550	550																																																									
		0°C ≤ To < 10°C	500	550	650																																																									
		-5°C ≤ To < 0°C	550	650	780																																																									
		To < -5°C	550	650	780																																																									
	Sleep operation	To ≥ 10°C	500	500	550																																																									
		0°C ≤ To < 10°C	500	550	550																																																									
		-5°C ≤ To < 0°C	550	550	550																																																									
		To < -5°C	550	550	550																																																									
	To abnormal		500	550	650																																																									
To : Outdoor temp sensor																																																														

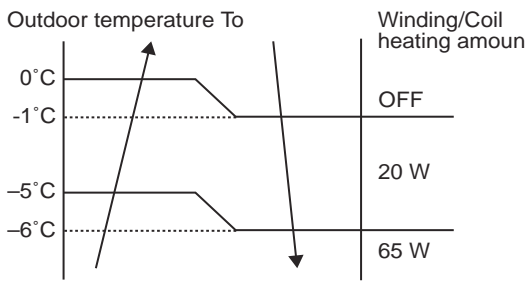
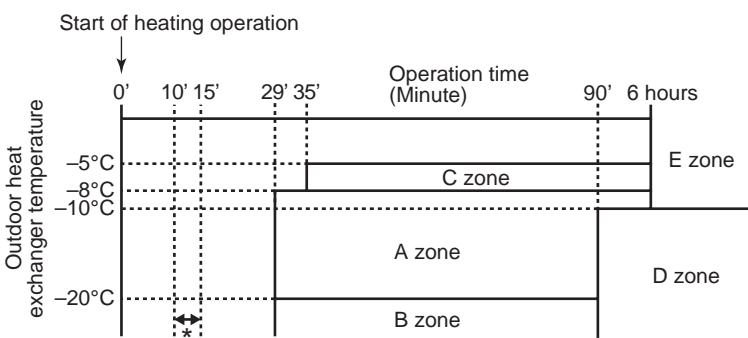


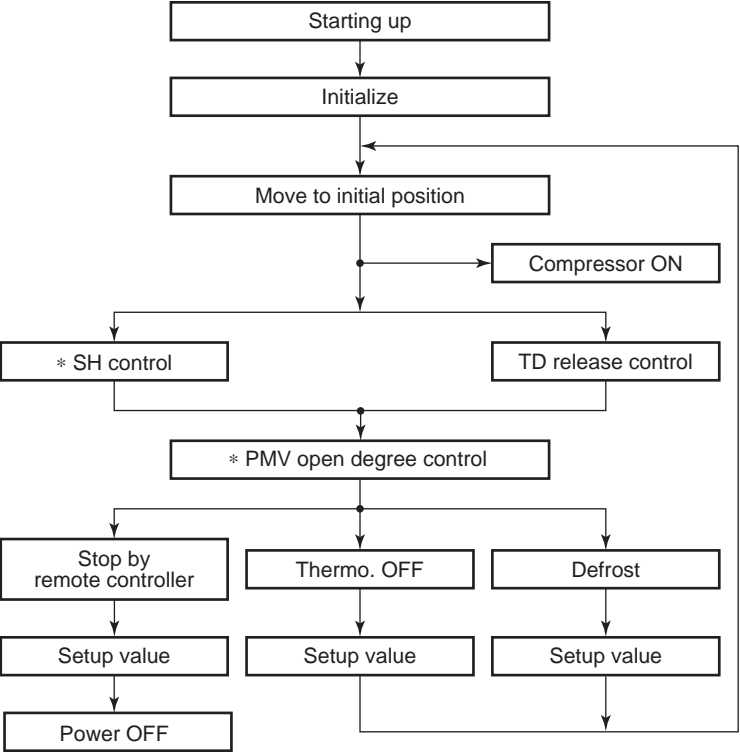
Item	Operation flow and applicable data, etc.	Description
3. Capacity control	<p>1) The indoor units from A to C determine the respective instruction revolutions from the difference between the remote controller setting temperature (Ts) and the indoor temperature (Ta), and transmit this to the outdoor unit.</p> <p>2) The outdoor unit receives the instructions from the indoor units, and the inverter operates the compressor at the calculated revolutions.</p> <p>3) The compressor operation range in each operating mode is shown in the left table.</p> 	

Operation mode	No. of operating unit	Combination of indoor units	Compressor revolution (rps)	Operation mode	No. of operating unit	Combination of indoor units	Compressor revolution (rps)
COOL	1 unit	M05	12 to 22.1	HEAT	1 unit	M05	12 to 42.5
		M07	12 to 22.1			M07	12 to 42.5
		M10	12 to 22.1			M10	12 to 42.5
		M13	12 to 34.1			M13	12 to 51.5
		M16	12 to 43.1			M16	12 to 54.4
		M18	12 to 44.9			M18	12 to 69.4
		M22	12 to 56.2			M22	12 to 73.6
		M24	12 to 80.2			M24	12 to 100.5
	2 units	○ *	12 to 53.3		2 units	○ *	12 to 73.6
	3 units	○ *	24.5 to 56.2		3 units	○ *	14.4 to 73.6

\* : In case that any multiple indoor units are combined.

4. Current release control	<p>This function prevents troubles on the electronic parts of the compressor driving inverter.</p> <p>This function also controls drive circuit of the compressor speed so that electric power of the compressor drive circuit does not exceed the specified value.</p> 	<p>1) The input current of the outdoor unit is detected in the inverter section of the outdoor unit.</p> <p>2) According to the detected outdoor temperature, the specified value of the current is selected.</p> <p>3) Whether the current value exceeds the specified value or not is judged.</p> <p>4) If the current value exceeds the specified value, this function reduces the compressor speed and controls speed up to the closest one commanded from the indoor unit within the range which does not exceed the specified value.</p>																		
	<table border="1"> <thead> <tr> <th>Outdoor temp.</th> <th>Cooling current release value</th> <th>Heating current release value</th> </tr> </thead> <tbody> <tr> <td>45°C</td> <td rowspan="2">7.4 A</td> <td rowspan="4">14.4 A</td> </tr> <tr> <td>40°C</td> <td>44°C</td> </tr> <tr> <td>16°C</td> <td>39°C</td> </tr> <tr> <td>11°C</td> <td>15.5°C</td> </tr> <tr> <td></td> <td>14.2 A</td> <td>14.5 A</td> </tr> <tr> <td></td> <td></td> <td>14.6 A</td> </tr> </tbody> </table> 	Outdoor temp.	Cooling current release value	Heating current release value	45°C	7.4 A	14.4 A	40°C	44°C	16°C	39°C	11°C	15.5°C		14.2 A	14.5 A			14.6 A	
Outdoor temp.	Cooling current release value	Heating current release value																		
45°C	7.4 A	14.4 A																		
40°C			44°C																	
16°C	39°C																			
11°C	15.5°C																			
	14.2 A	14.5 A																		
		14.6 A																		

Item	Operation flow and applicable data, etc.	Description										
<p>5. Winding/Coil heating control</p>	<p>When the outdoor temperature is low, the windings/ coils are heated to ensure compressor reliability.</p> 	<p>Winding/Coil heating is performed when the following conditions are met.</p> <p><b>Condition 1 :</b> When the discharge sensor temperature (Td) is less than 30°C.</p> <p><b>Condition 2 :</b> When the outdoor sensor temperature (To) is as shown in the left figure.</p>										
<p>6. Defrost control (Only in heating operation)</p>	<p>(This function removes frost adhered to the outdoor heat exchanger.) The temperature sensor of the outdoor heat exchanger (Te sensor) judges the frosting status of the outdoor heat exchanger and the defrost operation is performed with 4-way valve reverse defrost system.</p>  <p>* The minimum value of Te sensor 10 to 15 minutes after start of operation is stored in memory as Te0 and Te1. (-10°C &lt; Te1 ≤ 10°C)</p> <p style="text-align: center;"><b>Table 1</b></p> <table border="1" data-bbox="167 1377 933 1724"> <tr> <td><b>A zone</b></td> <td>When Te0 - TE ≥ 2.5 continued for 2 minutes in A zone, defrost operation starts.</td> </tr> <tr> <td><b>B zone</b></td> <td>When the operation continued for 2 minutes in B zone, defrost operation starts.</td> </tr> <tr> <td><b>C zone</b></td> <td>When Te0 - TE ≥ 3 continued for 2 minutes in C zone, defrost operation starts.</td> </tr> <tr> <td><b>D zone</b></td> <td>When the operation continued for 2 minutes in D zone, defrost operation starts.</td> </tr> <tr> <td><b>E zone</b></td> <td>When Te1 - TE ≥ 1 continued for 2 minutes in E zone, defrost operation starts.</td> </tr> </table>	<b>A zone</b>	When Te0 - TE ≥ 2.5 continued for 2 minutes in A zone, defrost operation starts.	<b>B zone</b>	When the operation continued for 2 minutes in B zone, defrost operation starts.	<b>C zone</b>	When Te0 - TE ≥ 3 continued for 2 minutes in C zone, defrost operation starts.	<b>D zone</b>	When the operation continued for 2 minutes in D zone, defrost operation starts.	<b>E zone</b>	When Te1 - TE ≥ 1 continued for 2 minutes in E zone, defrost operation starts.	<p>The necessity of defrost operation is detected by the outdoor heat exchanger temperature. The conditions to detect the necessity of defrost operation differ in A, B, C, D or E zone each. (Table 1)</p> <p><b>&lt;Defrost operation&gt;</b></p> <ul style="list-style-type: none"> <li>Defrost operation in A to E zones</li> </ul> <ol style="list-style-type: none"> <li>Stop operation of the compressor for 30 seconds.</li> <li>Invert (OFF) 4-way valve 10 seconds after stop of the compressor.</li> <li>The outdoor fan stops at the same time when the compressor stops.</li> <li>When temperature of the indoor heat exchanger becomes 38°C or lower, stop the indoor fan.</li> </ol> <p><b>&lt;Finish of defrost operation&gt;</b></p> <ul style="list-style-type: none"> <li>Returning conditions from defrost operation to heating operation</li> </ul> <ol style="list-style-type: none"> <li>Temperature of outdoor heat exchanger rises to +8°C or higher.</li> <li>Temperature of outdoor heat exchanger is kept at +5°C or higher for 80 seconds.</li> <li>Defrost operation continues for 10 minutes.</li> </ol> <p><b>&lt;Returning from defrost operation&gt;</b></p> <ol style="list-style-type: none"> <li>Stop operation of the compressor for approx. 60 seconds.</li> <li>Invert (ON) 4-way valve approx. 40 seconds after stop of the compressor.</li> <li>The outdoor fan starts rotating at the same time when the compressor starts.</li> </ol>
<b>A zone</b>	When Te0 - TE ≥ 2.5 continued for 2 minutes in A zone, defrost operation starts.											
<b>B zone</b>	When the operation continued for 2 minutes in B zone, defrost operation starts.											
<b>C zone</b>	When Te0 - TE ≥ 3 continued for 2 minutes in C zone, defrost operation starts.											
<b>D zone</b>	When the operation continued for 2 minutes in D zone, defrost operation starts.											
<b>E zone</b>	When Te1 - TE ≥ 1 continued for 2 minutes in E zone, defrost operation starts.											
<p>7. Compressor protective control</p>	<ol style="list-style-type: none"> <li>This control purposes to raise the operation frequency until 36Hz for 2 minutes in order to protect the compressor (Prevention of oil accumulation in the refrigerating cycle) when the status that the operation frequency is 36Hz or less has continued for 10 hours was calculated. The operation frequency follows the normal indoor command after controlling.</li> <li>Although the compressor may stop by THERMO-OFF control when the room temperature varies and then attains the set temperature by this control, it is not abnormal.</li> <li>During this control works, it stopping the operation by the remote controller, the operation does not continue.</li> </ol>											

Item	Operation flow and applicable data, etc.	Description														
<p>8. Discharge temperature control</p> <table border="1" data-bbox="172 331 914 667"> <thead> <tr> <th>Td value</th> <th>Control operation</th> </tr> </thead> <tbody> <tr> <td>120°C</td> <td>Judges as an error and stops the compressor.</td> </tr> <tr> <td>115°C</td> <td>Reduce the compressor speed.</td> </tr> <tr> <td>111°C</td> <td>Reduce slowly compressor speed.</td> </tr> <tr> <td>108°C</td> <td>Keeps the compressor speed.</td> </tr> <tr> <td>101°C</td> <td>If the operation is performed with lower speed than one commanded by the serial signal, speed is slowly raised up to the commanded speed.</td> </tr> <tr> <td></td> <td>Operates with speed commanded by the serial signal.</td> </tr> </tbody> </table>	Td value	Control operation	120°C	Judges as an error and stops the compressor.	115°C	Reduce the compressor speed.	111°C	Reduce slowly compressor speed.	108°C	Keeps the compressor speed.	101°C	If the operation is performed with lower speed than one commanded by the serial signal, speed is slowly raised up to the commanded speed.		Operates with speed commanded by the serial signal.		<p><b>1. Purpose</b> This function detects error on the refrigerating cycle or error on the compressor, and performs protective control.</p> <p><b>2. Operation</b></p> <ul style="list-style-type: none"> <li>Control of the compressor speed The speed control is performed as described in the left table based upon the discharge temperature.</li> </ul>
Td value	Control operation															
120°C	Judges as an error and stops the compressor.															
115°C	Reduce the compressor speed.															
111°C	Reduce slowly compressor speed.															
108°C	Keeps the compressor speed.															
101°C	If the operation is performed with lower speed than one commanded by the serial signal, speed is slowly raised up to the commanded speed.															
	Operates with speed commanded by the serial signal.															
<p>9. Pulse motor valve (PMV) control</p>  <p>* SH (Super Heat amount) = Ts (Temperature of suction pipe of the compressor) – Tc or Te (Heat exchanger temperature at evaporation side)</p> <p>* PMV: Pulse Motor Valve</p>	<p>This function controls throttle amount of the refrigerant in the refrigerating cycle. According to operating status of the air conditioner, this function also controls the open degree of valve with an expansion valve with pulse motor.</p>	<ol style="list-style-type: none"> <li>When starting the operation, move the valve once until it fits to the stopper. (Initialize) * In this time, "Click" sound may be heard.</li> <li>Adjust the open degree of valve by super heat amount. (SH control)</li> <li>If the discharge temperature was excessively up, adjust the open degree of valve so that it is in the range of set temperature. (Discharge temp. control)</li> <li>When defrost operation is performed, the open degree of PMV is adjusted according to each setup conditions during preparation for defrost and during defrost operation (4-way valve is inverted.).</li> <li>When turning off the compressor by thermo. OFF or STOP by remote controller, the open degree of the PMV is adjusted to the setup value.</li> </ol>														
<p>10. High-pressure switch/ Compressor case thermostat control</p>	<ol style="list-style-type: none"> <li>When the high-pressure switch or the compressor case thermostat operates, the operation of the compressor is terminated.</li> <li>The compressor restarts after 2 minutes 30 seconds using [1] as an error count. After restart, the error count is cleared when operation continues for 10 minutes or more.</li> <li>An error is confirmed with the error count [10].</li> <li>For the indicated contents of error, confirm using the check code table.</li> </ol>															

**9-3. Service switch (SW801, SW802) operations**

Various displays and various operations are enabled by push buttons (service) switches and LED on the outdoor control P.C. board.

9-3-1. LED display

5 patterns are provided for LED display.

○:ON (○\*:3 sec ON/0.5 sec OFF), ●:OFF, ⊙:Rapid Flashing(5 times/sec), ◇:Slow Flashing(1 time/sec)

D800 (Yellow)	D801 (Yellow)	D802 (Yellow)	D803 (Yellow)	D804 (Yellow)	D805 (Green)
●/○(*)/⊙	●/○(*)/⊙	●/○(*)/⊙	●/○(*)/⊙	●/○(*)/⊙/◇	●/○/⊙/◇

In the initial status of LED display, D805 is ON as below.

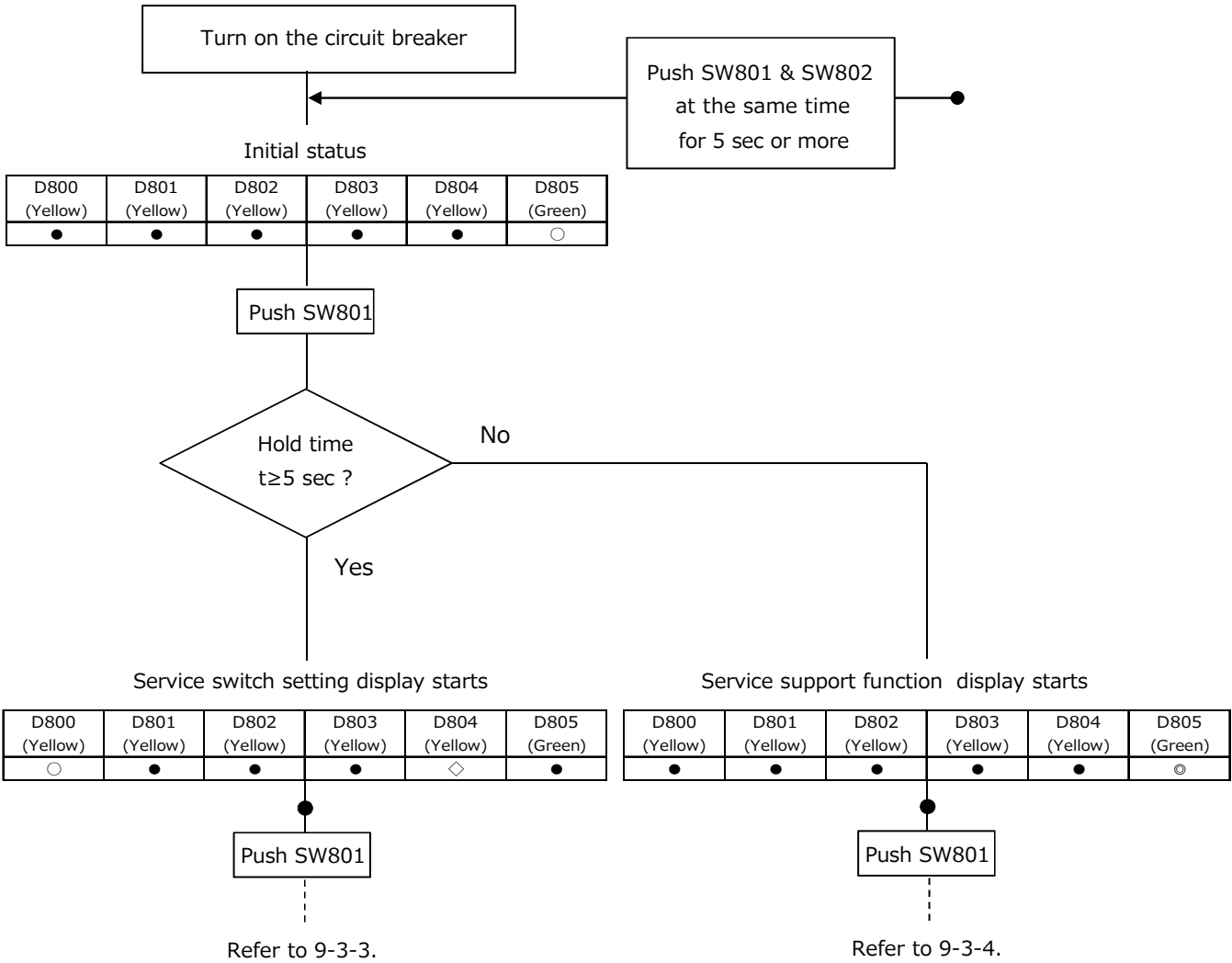
Normal						Error occurring					
D800 (Yellow)	D801 (Yellow)	D802 (Yellow)	D803 (Yellow)	D804 (Yellow)	D805 (Green)	D800 (Yellow)	D801 (Yellow)	D802 (Yellow)	D803 (Yellow)	D804 (Yellow)	D805 (Green)
●	●	●	●	●	○	●/○*	●/○*	●/○*	●/○*	●/○*	○
○:ON ●:OFF						○:ON ○*:3 sec ON/0.5 sec OFF ●:OFF					

When the initial status does not appear (in case of flashing of D804 or D805), LED display can be returned to the initial status by pushing and holding the service switches SW801 and SW802 for 5 seconds or more simultaneously.

9-3-2. Service switch setting and service support function

You can choose service switch setting and service support function.

Operating method is as below.



9-3-3. Service switch setting

Various settings are available by setting service switches.

[Operating method]

- 1) Check LED display is the initial status. If it is not so, set the initial status.
  - 2) Push and hold SW801 for 5 seconds or more and then check D804 flashes slowly (1 times/sec).
  - 3) Push SW801 several times and then stop it at the LED display of function item to be set up.
  - 4) Push SW802 and then D805 will flash rapidly (5 times/sec). (D805 is turned off by pressing the SW802 again.)
  - 5) Push and hold SW802 for 5 seconds or more. D804 changes to slow flashing, D805 changes to lighting and then various settings are validated.
  - 6) When you want to continue the settings, moreover repeat items from 3) to 5).
  - 7) To invalidate various settings, execute items 1) to 3), push SW802 and then D805 will turn off.
  - 8) Push and hold SW802 for 5 seconds or more. D804 changes to slow flashing, D805 is turned off and then various settings are invalidated.
- \* If an unknown point generated on the way of the operation, push and hold SW801 and SW802 for 5 seconds or more simultaneously. You can return to the item 1).

[Confirmation method of various settings]

You can confirm that various settings are validated.

- 1) Check LED displays are in the initial status. If it are not so, return them to the initial status.
- 2) Push and hold SW801 for 5 seconds or more. D804 changes to slow flashing.
- 3) Push SW801 several times and then stop it at the point where LED display (D800 to D804) to be checked. If the setting became valid, D804 and D805 flash rapidly. (When the setup was invalid, D804 flashes rapidly and D805 goes off.)
- 4) Push SW801 and SW802 for 5 seconds or more simultaneously to return LED display to the initial status.

No.	Display					Item	Control contents																								
	D800 (YL)	D801 (YL)	D802 (YL)	D803 (YL)	D804 (YL)			D805 (GN)																							
1	○	●	●	●		Refrigerant collection operation  At shipment from factory (default) D805 (Green) ●	<p>○:ON (○*:3 sec ON/0.5 sec OFF)●:OFF ◎:Rapid Flashing(5 times/sec)◇:Slow Flashing(1 time/sec)</p> <p>The outdoor unit performs cooling operation. As the indoor unit does not operate by this switch setting only, carry out the operation beforehand. (Before switch setting, you have to operate in cooling mode of all indoor units.) During the check, the display is kept as below. *Operation is up to 10 minutes. *After the collection is finished, promptly stop the operation of all the indoor unit. (There are cases that the compressor restarts.)</p> <table border="1"> <tr> <td>D800 (Yellow)</td> <td>D801 (Yellow)</td> <td>D802 (Yellow)</td> <td>D803 (Yellow)</td> <td>D804 (Yellow)</td> <td>D805 (Green)</td> </tr> <tr> <td>○</td> <td>●</td> <td>●</td> <td>●</td> <td>◇</td> <td>○</td> </tr> </table>	D800 (Yellow)	D801 (Yellow)	D802 (Yellow)	D803 (Yellow)	D804 (Yellow)	D805 (Green)	○	●	●	●	◇	○												
D800 (Yellow)	D801 (Yellow)	D802 (Yellow)	D803 (Yellow)	D804 (Yellow)	D805 (Green)																										
○	●	●	●	◇	○																										
2	●	●	○	●		Miswiring (mis piping) check  At shipment from factory (default) D805 (Green) ●	<p>The outdoor unit performs cooling operation. As the indoor unit does not operate by this switch setting only, carry out the operation beforehand. (Before switch setting, you have to operate in cooling mode of all indoor units.) During the check, the display is kept as below. *Operation is up to 30 minutes. *You cannot check wiring/piping when the external temperature is 5°C or less. *During the check, the compressor and the fan of the outdoor/indoor unit repeat ON/OFF.</p> <table border="1"> <tr> <td>D800 (Yellow)</td> <td>D801 (Yellow)</td> <td>D802 (Yellow)</td> <td>D803 (Yellow)</td> <td>D804 (Yellow)</td> <td>D805 (Green)</td> </tr> <tr> <td>●</td> <td>●</td> <td>○</td> <td>●</td> <td>◇</td> <td>○</td> </tr> </table>	D800 (Yellow)	D801 (Yellow)	D802 (Yellow)	D803 (Yellow)	D804 (Yellow)	D805 (Green)	●	●	○	●	◇	○												
D800 (Yellow)	D801 (Yellow)	D802 (Yellow)	D803 (Yellow)	D804 (Yellow)	D805 (Green)																										
●	●	○	●	◇	○																										
3	○	●	○	●		Fan motor operation check  At shipment from factory (default) D805 (Green) ●	<p>Operate the fan motor forcedly. The motor rotates at 500rpm and operation is 2 minutes. During the check, the display is kept as below.</p> <table border="1"> <tr> <td>D800 (Yellow)</td> <td>D801 (Yellow)</td> <td>D802 (Yellow)</td> <td>D803 (Yellow)</td> <td>D804 (Yellow)</td> <td>D805 (Green)</td> </tr> <tr> <td>○</td> <td>●</td> <td>○</td> <td>●</td> <td>◇</td> <td>○</td> </tr> </table>	D800 (Yellow)	D801 (Yellow)	D802 (Yellow)	D803 (Yellow)	D804 (Yellow)	D805 (Green)	○	●	○	●	◇	○												
D800 (Yellow)	D801 (Yellow)	D802 (Yellow)	D803 (Yellow)	D804 (Yellow)	D805 (Green)																										
○	●	○	●	◇	○																										
4	●	○	○	●		PMV operation check  At shipment from factory (default) D805 (Green) ●	<p>PMV is initialized to order from unit A. (only one time) Checking its operation sound and you can see that it is operating. During the check, the display is kept as below.</p> <table border="1"> <tr> <td>D800 (Yellow)</td> <td>D801 (Yellow)</td> <td>D802 (Yellow)</td> <td>D803 (Yellow)</td> <td>D804 (Yellow)</td> <td>D805 (Green)</td> </tr> <tr> <td>●</td> <td>○</td> <td>○</td> <td>●</td> <td>◇</td> <td>○</td> </tr> </table>	D800 (Yellow)	D801 (Yellow)	D802 (Yellow)	D803 (Yellow)	D804 (Yellow)	D805 (Green)	●	○	○	●	◇	○												
D800 (Yellow)	D801 (Yellow)	D802 (Yellow)	D803 (Yellow)	D804 (Yellow)	D805 (Green)																										
●	○	○	●	◇	○																										
5	○	○	○	●		Cooling only setting  At shipment from factory (default) D805 (Green) ●	<p>When using the air conditioner as a cooling-only conditioner, set the switch. (If the heating mode is selected by remote control, outdoor unit will remain stop. If mixed with indoor unit cooling and heating, outdoor unit performs cooling operation.) When the setting is finished, the display is as below.</p> <table border="1"> <tr> <td>D800 (Yellow)</td> <td>D801 (Yellow)</td> <td>D802 (Yellow)</td> <td>D803 (Yellow)</td> <td>D804 (Yellow)</td> <td>D805 (Green)</td> </tr> <tr> <td>○</td> <td>○</td> <td>○</td> <td>●</td> <td>◇</td> <td>○</td> </tr> </table>	D800 (Yellow)	D801 (Yellow)	D802 (Yellow)	D803 (Yellow)	D804 (Yellow)	D805 (Green)	○	○	○	●	◇	○												
D800 (Yellow)	D801 (Yellow)	D802 (Yellow)	D803 (Yellow)	D804 (Yellow)	D805 (Green)																										
○	○	○	●	◇	○																										
6	●	●	●	○		Heating only setting  At shipment from factory (default) D805 (Green) ●	<p>When using the air conditioner as a heating-only conditioner, set the switch. (If the cooling mode is selected by remote control, outdoor unit will remain stop. If mixed with indoor unit cooling and heating, outdoor unit performs heating operation.) When the setting is finished, the display is as below.</p> <table border="1"> <tr> <td>D800 (Yellow)</td> <td>D801 (Yellow)</td> <td>D802 (Yellow)</td> <td>D803 (Yellow)</td> <td>D804 (Yellow)</td> <td>D805 (Green)</td> </tr> <tr> <td>●</td> <td>●</td> <td>●</td> <td>○</td> <td>◇</td> <td>○</td> </tr> </table>	D800 (Yellow)	D801 (Yellow)	D802 (Yellow)	D803 (Yellow)	D804 (Yellow)	D805 (Green)	●	●	●	○	◇	○												
D800 (Yellow)	D801 (Yellow)	D802 (Yellow)	D803 (Yellow)	D804 (Yellow)	D805 (Green)																										
●	●	●	○	◇	○																										
7	●	○	●	○		Power save function  At shipment from factory (default) D805 (Green) ●	<p>When using the power save function, set the switch. The current limit is enabled. When the setting is finished, the display is as below.</p> <table border="1"> <tr> <td>D800 (Yellow)</td> <td>D801 (Yellow)</td> <td>D802 (Yellow)</td> <td>D803 (Yellow)</td> <td>D804 (Yellow)</td> <td>D805 (Green)</td> </tr> <tr> <td>●</td> <td>○</td> <td>●</td> <td>○</td> <td>◇</td> <td>○</td> </tr> </table>	D800 (Yellow)	D801 (Yellow)	D802 (Yellow)	D803 (Yellow)	D804 (Yellow)	D805 (Green)	●	○	●	○	◇	○												
D800 (Yellow)	D801 (Yellow)	D802 (Yellow)	D803 (Yellow)	D804 (Yellow)	D805 (Green)																										
●	○	●	○	◇	○																										
8	○	○	●	○		Select current limit  At shipment from factory (default) D805 (Green) ●	<p>If you enabled the power save function, you have to choose two of the current limit value. When the setting is finished, the display is as below.</p> <p>(1)8.5A</p> <table border="1"> <tr> <td>D800 (Yellow)</td> <td>D801 (Yellow)</td> <td>D802 (Yellow)</td> <td>D803 (Yellow)</td> <td>D804 (Yellow)</td> <td>D805 (Green)</td> </tr> <tr> <td>○</td> <td>○</td> <td>●</td> <td>○</td> <td>◇</td> <td>○</td> </tr> </table> <p>(2)11.0A</p> <table border="1"> <tr> <td>D800 (Yellow)</td> <td>D801 (Yellow)</td> <td>D802 (Yellow)</td> <td>D803 (Yellow)</td> <td>D804 (Yellow)</td> <td>D805 (Green)</td> </tr> <tr> <td>○</td> <td>○</td> <td>●</td> <td>○</td> <td>◇</td> <td>●</td> </tr> </table>	D800 (Yellow)	D801 (Yellow)	D802 (Yellow)	D803 (Yellow)	D804 (Yellow)	D805 (Green)	○	○	●	○	◇	○	D800 (Yellow)	D801 (Yellow)	D802 (Yellow)	D803 (Yellow)	D804 (Yellow)	D805 (Green)	○	○	●	○	◇	●
D800 (Yellow)	D801 (Yellow)	D802 (Yellow)	D803 (Yellow)	D804 (Yellow)	D805 (Green)																										
○	○	●	○	◇	○																										
D800 (Yellow)	D801 (Yellow)	D802 (Yellow)	D803 (Yellow)	D804 (Yellow)	D805 (Green)																										
○	○	●	○	◇	●																										

\*1. Item and setting is displaying.  
\*2. Item and setting is selecting.

9-3-4. Service support function

Various displays are available by setting service switches. [Operating method]

- 1) Check LED display is the initial status. If it is not so, set the initial status.
- 2) Push SW801 several times and stop it at the item that you want to check.

○:ON (○\*:3 sec ON/0.5 sec OFF)●:OFF

◎:Rapid Flashing(5 times/sec) ◇:Slow Flashing(1 time /sec)

No.	Display						Item	Description
	D800 (YL)	D801 (YL)	D802 (YL)	D803 (YL)	D804 (YL)	D805 (GN)		
0	●	●	●	●	●		Error display (Error which is occurring at present)	The error which is occurring at present is displayed. LED goes off while an error does not occur. (Refer to table A)
1	○	●	●	●	●		Error display (The latest error: The latest error including this moment)	After error status was eliminated, if you want to check the error which occurred before, call this setting and check it. (Even after turning off the power supply once, you can recheck it.) * This error display displays only the errors related to compressor stop. * In the case that an error occurred at present, the same contents as that at present is displayed. (Refer to table B)
2	●	○	●	●	●		Miswiring (mis piping) display	You can check the room judged as error by operating the miswiring (mis piping) check. (Refer to table C)
3	○	○	●	●	●		Discharge temperature sensor (TD) display	The detected value of the discharge temperature (TD) is displayed. (Refer to table C)
4	●	●	○	●	●		Outdoor heat exchanger temperature sensor (TE) display	The detected value of the outdoor heat exchanger temperature sensor (TE) is displayed. (Refer to table C)
5	○	●	○	●	●		Suction temperature sensor (TS) display	The detected value of the suction temperature sensor (TS) is displayed. (Refer to table C)
6	●	○	○	●	●		Outside temperature sensor (TO) display	The detected value of the outside temperature sensor (TO) is displayed. (Refer to table C)
7	○	○	○	●	●		Current display	The current value which flows to the outdoor unit is displayed. (Refer to table C)
8	●	●	●	○	●		Compressor operation frequency display	The operation frequency of the compressor is displayed. (Refer to table C)
9	○	●	●	○	●		PMV opening display (unit A)	The opening of PMV (Electronic expansion valve) is displayed. (Refer to table C)
10	●	○	●	○	●	◎	PMV opening display (unitB)	The opening of PMV (Electronic expansion valve) is displayed. (Refer to table C)
11	○	○	●	○	●		PMV opening display (unit C)	The opening of PMV (Electronic expansion valve) is displayed. (Refer to table C)
12	●	○	○	○	●		Gas temperature sensor (TG) display (unit A)	The detected value of the gas temperature sensor (TG) is displayed. (Refer to table C)
13	○	○	○	○	●		Gas temperature sensor (TG) display (unit B)	The detected value of the gas temperature sensor (TG) is displayed. (Refer to table C)
14	●	●	●	●	○		Gas temperature sensor (TG) display (unit C)	The detected value of the gas temperature sensor (TG) is displayed. (Refer to table C)
15	○	○	●	●	○		Indoor suction temperature sensor (TA) display (unit A)	The detected value of the indoor suction temperature sensor (TA) is displayed. (Refer to table C)
16	●	●	○	●	○		Indoor suction temperature sensor (TA) display (unit B)	The detected value of the indoor suction temperature sensor (TA) is displayed. (Refer to table C)
17	○	●	○	●	○		Indoor suction temperature sensor (TA) display (unit C)	The detected value of the indoor suction temperature sensor (TA) is displayed. (Refer to table C)
24	●	●	●	○	○		Indoor heat exchanger temperature sensor (TC/TCJ) display (unit A)	The detected value of the indoor heat exchanger temperature sensor (TC) is displayed. Only while you press the SW802, the detected value of the indoor heat exchanger temperature sensor (TCJ) is displayed. (Refer to table C)
25	○	●	●	○	○		Indoor heat exchanger temperature sensor (TC/TCJ) display (unit B)	The detected value of the indoor heat exchanger temperature sensor (TC) is displayed. Only while you press the SW802, the detected value of the indoor heat exchanger temperature sensor (TCJ) is displayed. (Refer to table C)
26	●	○	●	○	○		Indoor heat exchanger temperature sensor (TC/TCJ) display (unit C)	The detected value of the indoor heat exchanger temperature sensor (TC) is displayed. Only while you press the SW802, the detected value of the indoor heat exchanger temperature sensor (TCJ) is displayed. (Refer to table C)

- 3) Pushing SW802, the display changes to next item. To see other display contents, repeat that.
- 4) To finish LED display, be sure to execute item 1) to return LED to the initial status (error display of current occurrence) and then finish LED display.

[Error display]

The error which is occurring at present and the latest error (including error that is occurring now) can be confirmed by checking display on the outdoor control P.C. board.

A. Error display which occurs at present

○: ON (○\*: 3 sec ON/0.5 sec OFF) ●: OFF

◎: Rapid Flashing(5 times/sec) ◇: Slow Flashing(1 time/sec)

Display						Indoor check code	Description
D800 (YL)	D801 (YL)	D802 (YL)	D803 (YL)	D804 (YL)	D805 (GN)		
●	●	●	●	●		-	Normal operation (no error)
○*	●	●	●	●		1C	Compressor case thermostat error
●	○*	●	●	●		21	High pressure switch error
○*	○*	●	●	●		1C	Compressor system error
●	●	○*	●	●		1D	Compressor lock
○*	●	○*	●	●		1F	Compressor breakdown
●	○*	○*	●	●		14	Driving element short circuit
○*	○*	○*	●	●		16	Position detection circuit error
●	●	●	○*	●		17	Current detection circuit error
○*	●	●	○*	●		1C	Communication error between MCU
●	○*	●	○*	●		1A	Fan system error
○*	○*	●	○*	●	○	1E	Discharge temperature error
●	●	○*	○*	●		19	Discharge temperature sensor (TD) error
○*	●	○*	○*	●		1B	Outdoor air temperature sensor (TO) error
*1	●	●	●	○*		1C	Gas pipe (unit A) temperature sensor (TGa) error
*2	○*	●	●	○*		1C	Gas pipe (unit B) temperature sensor (TGb) error
*2	●	○*	●	○*		1C	Gas pipe (unit C) temperature sensor (TGc) error
○*	●	○*	●	○*		-	PMV error (SH≥20)
●	○*	○*	●	○*		-	PMV error (SH≤-8)
●	●	●	○*	○*		20	PMV leakage error (unit A)
○*	●	●	○*	○*		20	PMV leakage error (unit B)
●	○*	●	○*	○*		20	PMV leakage error (unit C)
○*	●	○*	○*	○*		-	Miswiring (mispiping) check error

\*1: Back-up operation is performed without error display of the indoor unit.

\*2: Operated normally when the air conditioners in other rooms are driven.

B. Error display of the latest error (including error which occurs at present)

○: ON (\*: 3 sec ON/0.5 sec OFF) ●: OFF

◎: Rapid Flashing(5 times/sec) ◇: Slow Flashing(1 time/sec)

Display						Indoor check code	Description
D800 (YL)	D801 (YL)	D802 (YL)	D803 (YL)	D804 (YL)	D805 (GN)		
●	●	●	●	●		-	Normal operation (no error)
◎	●	●	●	●		1C	Compressor case thermostat error
●	◎	●	●	●		21	High pressure switch error
◎	◎	●	●	●		1C	Compressor system error
●	●	◎	●	●		1D	Compressor lock
◎	●	◎	●	●		1F	Compressor breakdown
●	◎	◎	●	●		14	Driving element short circuit
◎	◎	◎	●	●		16	Position detection circuit error
●	●	●	◎	●		17	Current detection circuit error
◎	●	●	◎	●		1C	Communication error between MCU
●	◎	●	◎	●		1A	Fan system error
◎	◎	●	◎	●	◇	1E	Discharge temperature error
●	●	◎	◎	●		19	Discharge temperature sensor (TD) error
◎	●	◎	◎	●		1B	Outdoor air temperature sensor (TO) error
●	●	●	●	◎		1C	Gas pipe (unit A) temperature sensor (TGa) error
◎	●	●	●	◎		1C	Gas pipe (unit B) temperature sensor (TGb) error
●	◎	●	●	◎		1C	Gas pipe (unit C) temperature sensor (TGc) error
◎	●	◎	●	◎		-	PMV error (SH≥20)
●	◎	◎	●	◎		-	PMV error (SH≤-8)
●	●	●	◎	◎		20	PMV leakage error (unit A)
◎	●	●	◎	◎		20	PMV leakage error (unit B)
●	◎	●	◎	◎		20	PMV leakage error (unit C)
◎	●	◎	◎	◎		-	Miswiring (mispiping) check error



C. Sensor, current, compressor operation frequency, PMV opening, Miswiring (mispiping) check display

Using the service display function, you can check a variety of information.

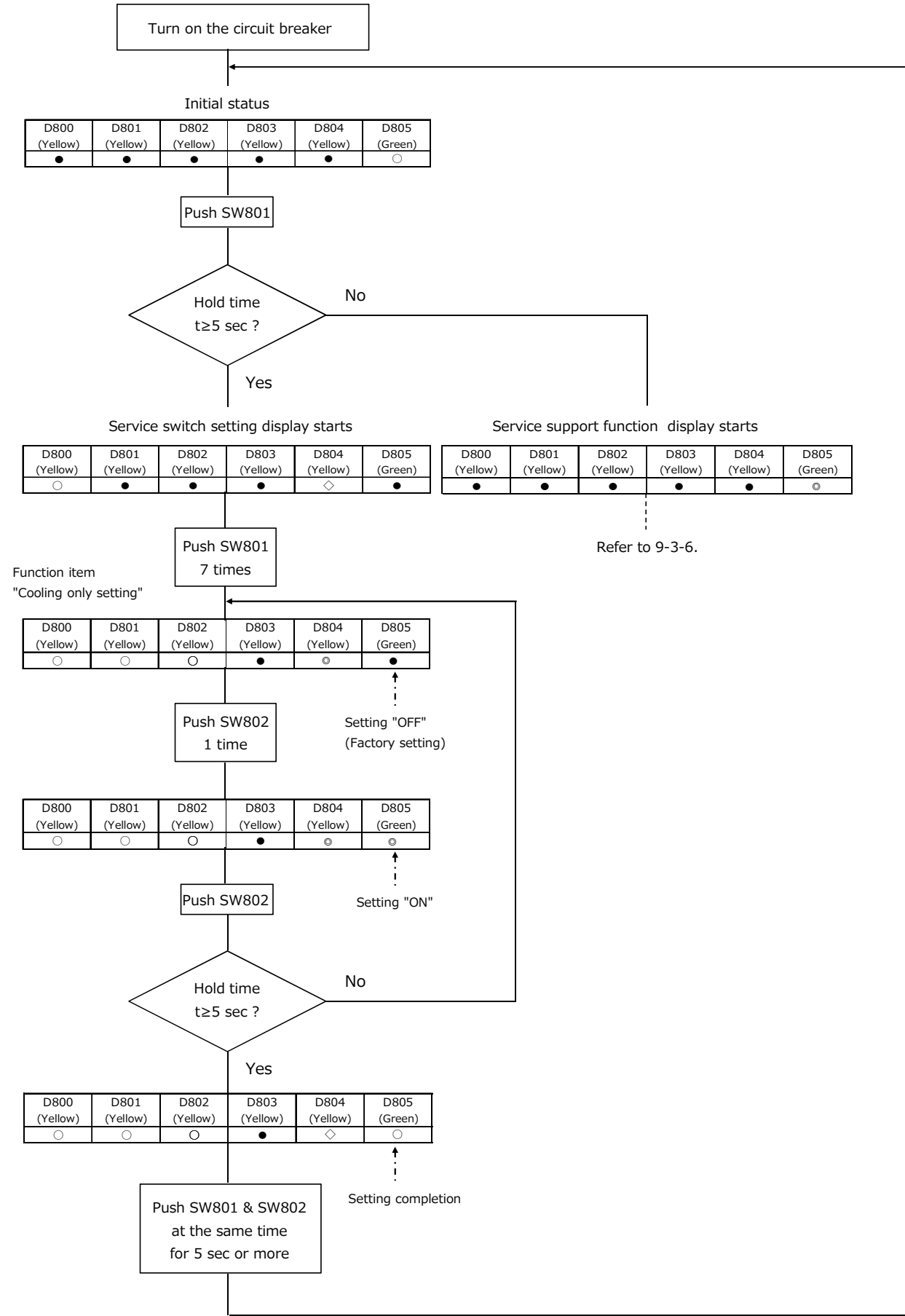
○:ON (○\*:3 sec ON/0.5 sec OFF)●:OFF  
 ◎:Rapid Flashing(5 times/sec) ◇:Slow Flashing(1 time/sec)

No.	display						Contents				
	D800 (YL)	D801 (YL)	D802 (YL)	D803 (YL)	D804 (YL)	D805 (GN)	Temp. sensor (°C)	Current (A)	Compressor frequency (rps)	PMV opening (pls)	Miswiring (mispiping) check
0	●	●	●	●	●		-26 or less	0~0.9	0~4.9	0~19	No error
1	○	●	●	●	●		-25~-21	1~1.9	5~9.9	20~39	Trouble in unit A
2	●	○	●	●	●		-20~-16	2~2.9	10~14.9	40~59	Trouble in unit B
3	○	○	●	●	●		-15~-11	3~3.9	15~19.9	60~79	Trouble in unit A and B
4	●	●	○	●	●		-10~-6	4~4.9	20~24.9	80~99	Trouble in unit C
5	○	●	○	●	●		-5~-1	5~5.9	25~29.9	100~119	Trouble in unit A and C
6	●	○	○	●	●		0~4	6~6.9	30~34.9	120~139	Trouble in unit B and C
7	○	○	○	●	●		5~9	7~7.9	35~39.9	140~159	Trouble in unit A,B and C
8	●	●	●	○	●		10~14	8~8.9	40~44.9	160~179	-
9	○	●	●	○	●		15~19	9~9.9	45~49.9	180~199	-
10	●	○	●	○	●		20~24	10~10.9	50~54.9	200~219	-
11	○	○	●	○	●		25~29	11~11.9	55~59.9	220~239	-
12	●	●	○	○	●		30~34	12~12.9	60~64.9	240~259	-
13	○	●	○	○	●		35~39	13~13.9	65~69.9	260~279	-
14	●	○	○	○	●		40~44	14~14.9	70~74.9	280~299	-
15	○	○	○	○	●	◇	45~49	15~15.9	75~79.9	300~319	-
16	●	●	●	●	○		50~54	16~16.9	80~84.9	320~339	-
17	○	●	●	●	○		55~59	17~17.9	85~89.9	340~359	-
18	●	○	●	●	○		60~64	18~18.9	90~94.9	360~379	-
19	○	○	●	●	○		65~69	19~19.9	95~99.9	380~399	-
20	●	●	○	●	○		70~74	20~20.9	100~104.9	400~419	-
21	○	●	○	●	○		75~79	21~21.9	105~109.9	420~439	-
22	●	○	○	●	○		80~84	22~22.9	110~114.9	440~459	-
23	○	○	○	●	○		85~89	23~23.9	115~119.9	460~479	-
24	●	●	●	○	○		90~94	24~24.9	120~124.9	480~499	-
25	○	●	●	○	○		95~99	25~25.9	125~129.9	500	-
26	●	○	●	○	○		100~104	26~26.9	130~134.9	-	-
27	○	○	●	○	○		105~109	27~27.9	135~139.9	-	-
28	●	●	○	○	○		110~114	28~28.9	140~144.9	-	-
29	○	●	○	○	○		115~119	29~29.9	145~149.9	-	-
30	●	○	○	○	○		120 or more	30~30.9	150~154.9	-	-
31	○	○	○	○	○		Sensor error	31 or more	155~ or more	-	-

(Note 1) Basically carry out the service switch settings while the machine stops. If carry out during the operation, the pressure may change suddenly and a danger may grow.

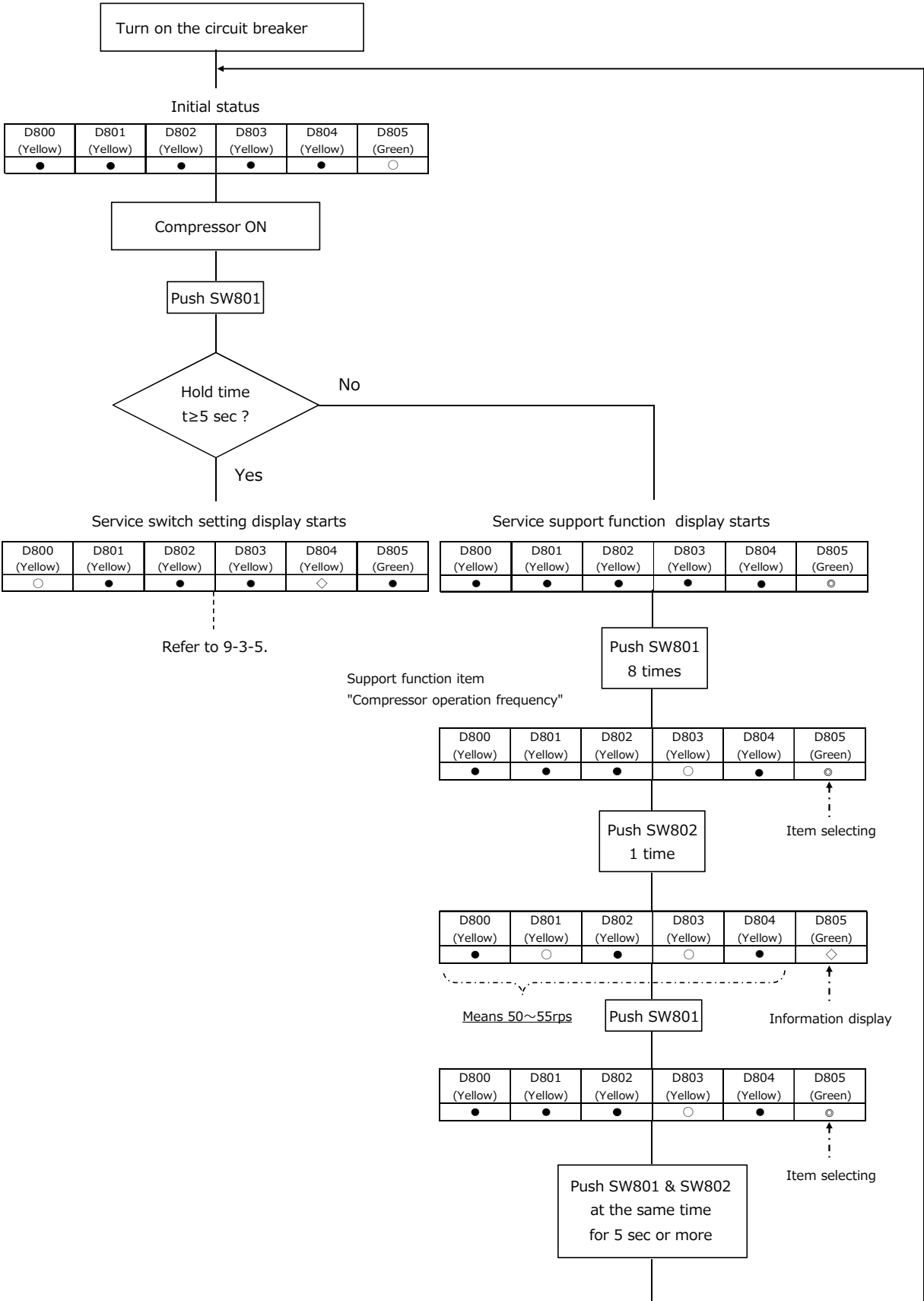
9-3-5. How to set the SERVICE SWITCH SETTING.  
 If you want to set the "COOLING ONLY SETTING OFF ⇒ ON" .

○:ON, ●:OFF, ◎:Rapid Flashing(5 times/sec), ◇:Slow Flashing(1 time/sec)



9-3-6. How to set the SERVICE SUPPORT FUNCTION.  
 If you want to check the "COMPRESSOR FREQUENCY" .

○:ON, ●:OFF, ◎:Rapid Flashing(5 times/sec), ◇:Slow Flashing(1 time/sec)



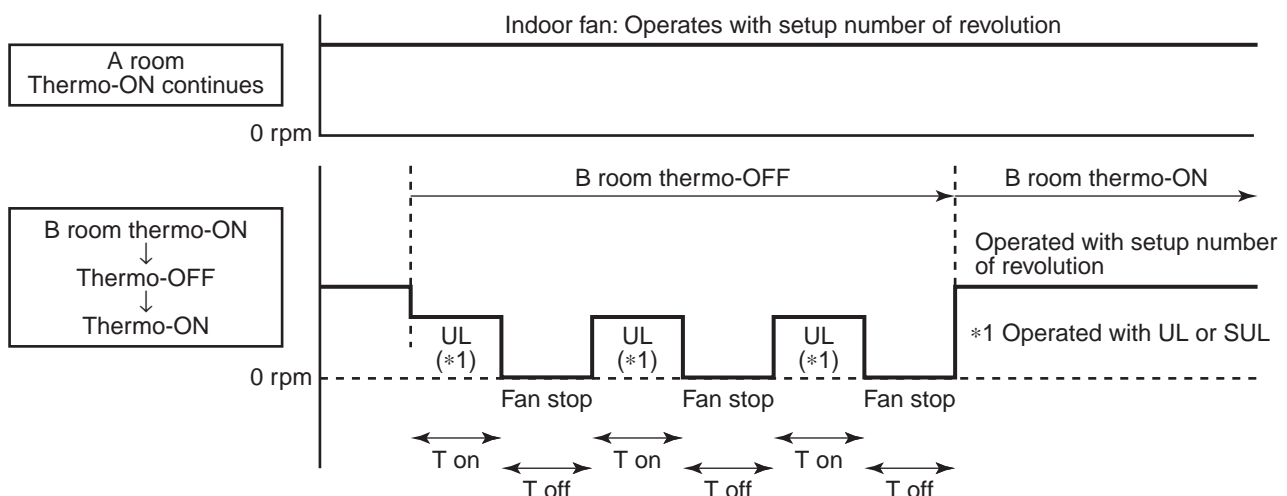
### 9-4. Intermittent Operation Control for Indoor Fans of the Indoor Unit at Thermo-off Side in Heating Operation

While heating operation is executed in two rooms, if room temperature reached the setup temperature in one room and thermo-off occurred, the following operations start. (Refer to the figure below.)

1. The indoor unit of the room (A room) in which thermo-off did not occur starts a continuous operation with the setup number of revolution.
2. The indoor unit of the room (B room) in which thermo-off occurred starts intermittent operation of the indoor fan. The indoor fan operates with number of revolution of UL or SUL. Fan-ON time is 2 minutes and Fan-OFF time is 2 to 4 minutes.

However if temperature of the indoor heat exchanger becomes over 55°C or more in B room, the indoor fan stops the intermittent operation and starts continuous operation.

While heating operation is executed in 2 rooms, if room temperature reached the setup temperature in both rooms and thermo-off occurred, both indoor units start intermittent operation of the indoor fan.



\* In case which Tc sensor temperature exceeds 55°C in B room, the fan stops intermittent operation and starts continuous operation with UL or SUL (\*1).

T on=2 min.

T off time	
To < 5°C	2 min.
5 ≤ To < 10	3 min.
10 ≤ To	4 min.

## R32 (R410A) Model








### Refrigerant

### Outdoor Unit Control Valve

In the case of an air conditioner using R32, in order to prevent any other refrigerant from being charged accidentally, the service port diameter of the outdoor unit control valve has been changed. (1/2 UNF 20 threads per inch)

- In order to increase the pressure resisting strength of the refrigerant piping flare processing diameter and size of opposite side of flare nuts has been changed. (for copper pipes with nominal dimensions 1/2 and 5/8)

### New tools for R32 (R410A)

New tools for R32 (R410A)	Applicable to R22 model		Changes
Gauge manifold	✗		As pressure is high, it is impossible to measure by means of conventional gauge. In order to prevent any other refrigerant from being charged, each port diameter has been changed.
Charge hose	✗		In order to increase pressure resisting strength, hose materials and port size have been changed (to 1/2 UNF 20 threads per inch). When purchasing a charge hose, be sure to confirm the port size.
Electronic balance for refrigerant charging	○		As pressure is high and gasification speed is fast, it is difficult to read the indicated value by means of charging cylinder, as air bubbles occur.
Torque wrench (nominal diam. 1/2, 5/8)	✗		The size of opposite sides of flare nuts have been increased. Incidentally, a common wrench is used for nominal diameters 1/4 and 3/8.
Flare tool (clutch type)	○		By increasing the clamp bar's receiving hole, strength of spring in the tool has been improved.
Gauge for projection adjustment	—	—	Used when flare is made by using conventional flare tool.
Vacuum pump adapter	○		Connected to conventional vacuum pump. It is necessary to use an adapter to prevent vacuum pump oil from flowing back to the charge hose. The charge hose connecting part has two ports—one for conventional refrigerant (7/16 UNF 20 threads per inch) and one for R32 (R410A). If the vacuum pump oil (mineral) mixes with R32 (R410A) a sludge may occur and damage the equipment.
Gas leakage detector	✗		Exclusive for HFC refrigerant.







- Incidentally, the “refrigerant cylinder” comes with the refrigerant designation R32 (R410A) and protector coating in the U.S.’s ARI specified rose color (ARI color code: PMS 507).
- Also, the “charge port and packing for refrigerant cylinder” require 1/2 UNF 20 threads per inch corresponding to the charge hose’s port size.

## CAUTION

- Incorrect wiring connection may cause electrical parts to burn out.
- Be sure to comply with local regulations/codes when running the wire from outdoor unit to indoor unit. (Size of wire and wiring method etc.)
- Every wire must be securely connected.
- If incorrect or incomplete wiring is carried out, fire or smoke may result.
- Prepare the power supply for the exclusive use of the air conditioner.

## 10-2. Outdoor Unit

### 10-2-1. Accessory and Installation Parts

Installation manual	1		Rubber cap (Water-proof)	5		CD-ROM (Installation manual) *1	1	
F-GAS label	1		Drain nipple	1		Product specification	1	

\*1 Part that do not exist in RAS-3M26U2AVG-TR

### 10-2-2. Refrigerant Piping

- Piping kit used for the conventional refrigerant cannot be used.
- **Use copper pipe with 0.8 mm or more thickness.**
- Flare nut and flare works are also different from those of the conventional refrigerant. Take out the flare nut attached to the main unit of the air conditioner, and use it.

### 10-2-3. Installation Place

- A place which provides the spaces around the outdoor unit.
- A place where the operation noise and discharged air do not disturb your neighbors.
- A place which is not exposed to a strong wind.
- A place which does not block a passageway.
- When the outdoor unit is to be installed in an elevated position, be sure to secure its feet.
- There must be sufficient spaces for carrying the unit into and out of the site.
- A place where the drain water does not raise any problem.
- A place which can bear the weight of the outdoor unit and does not allow an increase in noise level and vibration.

### 10-2-4. Installation Parts (Local Supply)

Parts name	Parts name			Q'ty
Refrigerant piping *1	Indoor unit (abbreviation)	Liquid side (O.D.)	Gas side (O.D.)	1 ea.
	05, 07, 10, 13	6.35 mm	9.52 mm	
	16, 18, 22, 24	6.35 mm	12.7 mm	
Putty, PVC tapes				1 ea.

\*1 Refrigerant piping covered with insulating material (Polyethylene foam, 6 mm thick).

When duct-type or cassette-type unit is to be installed, it shall be covered with thicker insulating material (Polyethylene foam, 10 mm thick).

\* Example of indoor unit class: RAS-B10PKVSG-E is abbreviated as "10".

Indoor unit class		Standard connecting pipe diameter
Unit C	05 or 07 or 10 or 13 or 16 <sup>*2</sup>	6.35, 9.52 mm
Unit B	05 <sup>*3</sup> or 07 <sup>*3</sup> or 10 <sup>*3</sup> or 13 <sup>*3</sup> or 16 or 18 or 22 or 24	6.35, 12.7 mm
Unit A	05 <sup>*3</sup> or 07 <sup>*3</sup> or 10 <sup>*3</sup> or 13 <sup>*3</sup> or 16 or 18 or 22 or 24	6.35, 12.7 mm
Total	54	-

All combinations that do not exceed the "Total" number can be installed.

2 or more indoor units must be connected to an outdoor unit.

When 2 indoor units are connected to an outdoor unit, note that some combinations of indoor units are not compatible.

For the further details, refer to the catalogue.

\*2 Need the reducer (12.7 to 9.52 mm).

\*3 Need the expander (9.52 to 12.7 mm).

- Locally procured.

## 10-2-5. Installation

### ■ Installation Location

- A place which can bear the weight of the outdoor unit and does not cause an increase in noise level and vibration.
- A place where the operation noise and air discharge do not disturb neighbours.
- A place which is not exposed to strong wind.
- A place free of combustible gas.
- A place which does not block a passageway.
- A place where the drain water does not cause any problems.
- A place where there are no obstructions near its air intake or air discharge.

Installation in the following places may result in trouble:

- A place with a lot of machine oil.
  - A place with saline-rich atmosphere such as a coastal area.
  - A place with high level of sulfide gas.
  - A place where high-frequency waves are likely to be generated, such as from audio equipment, welders, or medical equipment.
- Do not install the unit in such places.

### ⚠ CAUTION

When the outdoor unit is installed in a place where the drain water might cause any problems, Seal the water leakage point tightly using a silicone adhesive or caulking compound.

### ■ Precautions for Installation

- When the outdoor unit is to be installed in an elevated position, be sure to secure its feet.
- If the outdoor unit is to be mounted on a wall, make sure the base plate supporting it is sturdy enough.
- The base plate should be designed and manufactured to maintain its strength over a long period of time, and sufficient consideration should be given to ensure that the outdoor unit will not fall.
- When the outdoor unit is installed in a place that is always exposed to strong wind such as a coastal area or on a high story of a building, secure the normal fan operation using a duct or a wind shield.
- Especially in windy areas, install the unit in such a way as to prevent the admission of wind.
- When the outdoor unit is to be mounted high on a wall, take particular care to ensure that parts do not fall, and that the installer is protected.
- When doing installation work at ground level, it is usual to make wiring and pipe connections to the indoor units first, and then to make connections to the outdoor units.  
However, if outdoor work is difficult, you can change the procedure. For example, by making adjustments to the wiring and piping lengths on the inside (rather than the outside).
- When using an air conditioner under low outside temperature conditions (Outside temp: -5 °C or lower) In COOL mode, prepare a duct or wind shield so that it is not affected by the wind.

### Necessary Space for Installation

If you need to install the outdoor unit in a location where there are some obstructions or a wall, secure sufficient space as shown in the figure below. The cooling/heating effect may be reduced by 10%.

### NOTE

For installation, at least 3 dimensions should be kept free from obstacles (walls).

### Upper side view (Unit: mm)

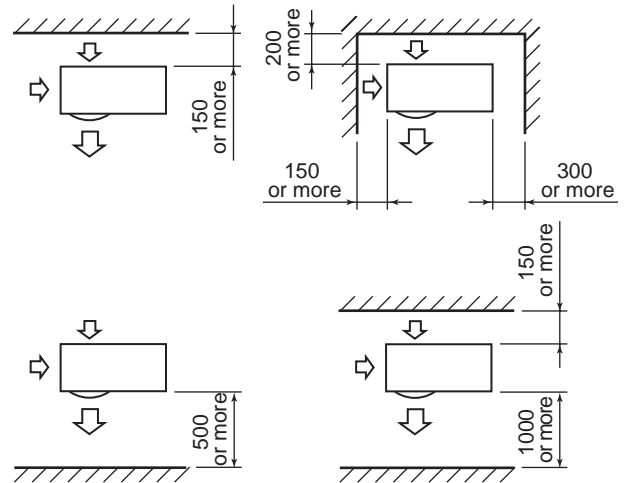


Fig. 10-2-1

### Side view (Unit: mm)

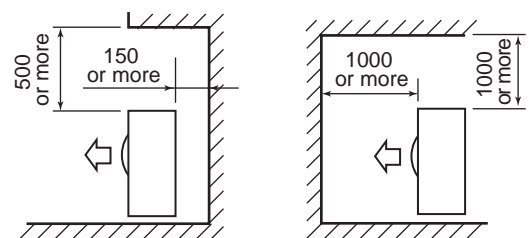


Fig. 10-2-2

### Draining Off the Water from the Outdoor Unit

Install 5 waterproof rubber caps and the drain nipple to drain off the water from the outdoor unit.

- Seal the knock-out holes and screw/thread areas tightly using a silicon adhesive or a caulking compound.
- Use a drain pan to apply a centralized drain.

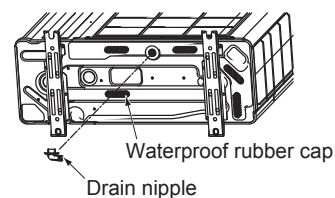


Fig. 10-2-3

### Installation in Regions with Snowfall and Cold Temperatures

Do not use waterproof rubber caps or a drain nipple.

- If you need to install the outdoor unit in a location where there is a possibility of the drain freezing, pay close attention so that the drain does not become frozen.
- To protect the outdoor unit from snow, install the outdoor unit on a holding frame, and attach a snow protection hood and plate.
- Keep the outdoor unit at least 500 mm above the snow accumulation line.

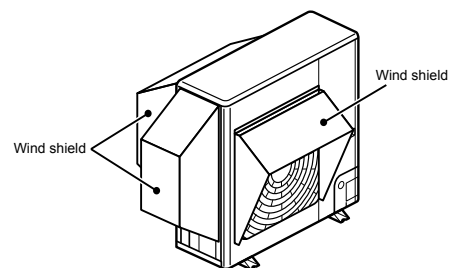
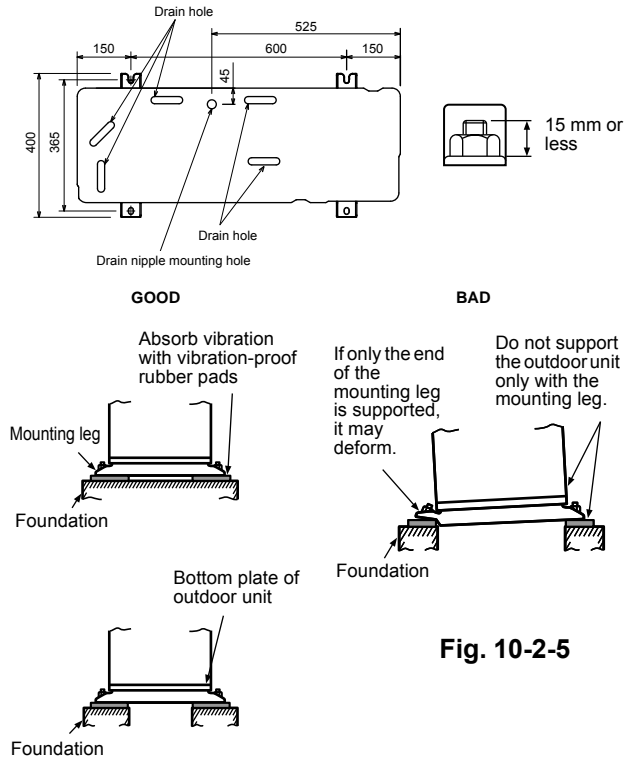


Fig. 10-2-4

**Fixing the Outdoor Unit**

**Fix the outdoor unit using attachment bolts.**

- Use 8 mm or 10 mm anchor bolts and nuts.
- Do not allow the attachment bolts to protrude by more than 15 mm.
- Install the outdoor unit at ground level.
- Attach the vibration-proof rubber pads under the fixing legs.



**Fig. 10-2-5**

Support the bottom surface of the mounting leg that is in contact with and underneath the bottom plate of the outdoor unit.

**◆ Refrigerant piping**

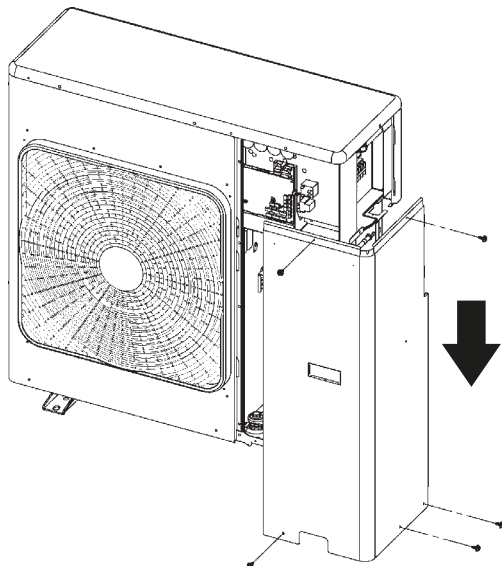
**! CAUTION**

Install in rooms that are 5 m<sup>3</sup> or larger. If a leak of refrigerant gas occurs inside the room, an oxygen deficiency may occur.

**■ Detaching the Valve cover**

**Remove the 5 screws.**

- Pull the front panel in the direction of the arrow, and remove it.

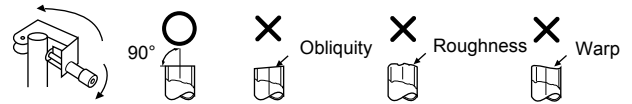


**Fig. 10-2-6**

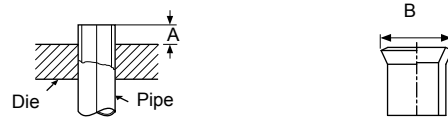
**■ Refrigerant Piping Connection**

**Flaring**

1. Cut the pipe with a pipe cutter.



2. Remove the burr inside of the pipe. When removing the burr, be careful so that chips do not fall into the pipe.
3. Remove the flare nuts attached to the outdoor/indoor unit, then insert them into each of the pipes.
4. Flare the pipes. See the following table for the projection margin (A) and flaring size (B).



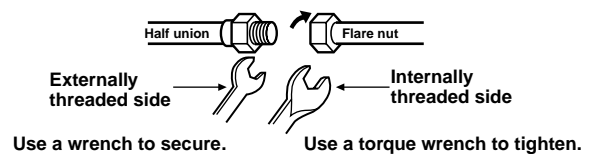
Pipe		A		B
Outside diameter	Thickness	Rigid (clutch type) R32 tool	Imperial (wing nut type) R32 tool	
mm	mm	mm	mm	mm
6.35	0.8	0 to 0.5	1.5 to 2.0	9.1
9.52	0.8	0 to 0.5	1.5 to 2.0	13.2
12.7	0.8	0 to 0.5	2.0 to 2.5	16.6

**! CAUTION**

- Do not scratch the inner surface of the flared part when removing burrs.
- Flare processing under the condition of scratches on the inner surface of flare processing part will cause refrigerant gas leak.

**<Tightening connection>**

Align the centers of the connecting pipes and tighten the flare nut as far as possible with your fingers. Then tighten the nut with a spanner and torque wrench as shown in the figure.



**Fig. 10-2-7**

**! CAUTION**

- Do not apply excess torque.
- Otherwise, the nut may crack depending on the conditions.



(Unit : N•m)

Outer dia. of copper pipe	Tightening torque
Ø6.35 mm	16 to 18 (1.6 to 1.8 kgf•m)
Ø9.52 mm	30 to 42 (3.0 to 4.2 kgf•m)
Ø12.70 mm	50 to 62 (5.0 to 6.2 kgf•m)

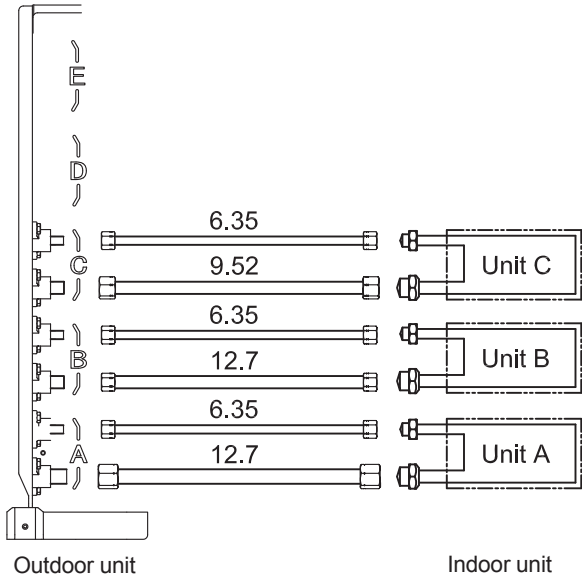


Fig. 10-2-8

Connectable capacity class			Total
A	B	C	
05, 07, 10, 13 (with reducer)		16 (with expander)	54
16, 18, 22, 24		05, 07, 10, 13	

**Tightening torque of flare pipe connections**

The operating pressure of R32 is higher than that of R22.

It is therefore necessary to firmly tighten the flare pipe connecting sections (which connect the indoor and outdoor units) up to the specified tightening torque. Incorrect connections may cause not only a gas leakage, but also damage to the refrigerant cycle.

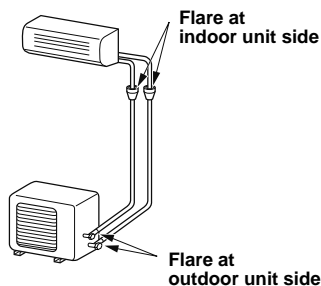


Fig. 10-2-9

**Pipe connection**

1. Piping connections to the outdoor unit should be arranged in the sequence A, B, C starting from the bottom.  
(For each piping connection, the gas pipe is on the bottom and the liquid pipe is on the top.)
2. When multiple indoor units are to be connected to the outdoor unit, make the ends of the pipes and wires from each indoor unit to ensure that they will be connected to the outdoor unit correctly.  
(Problems caused by indoor units being connected to the outdoor unit incorrectly are very common in multiple-unit installations.)
3. The length and height difference of the connecting pipes between the indoor and outdoor units must be within the ranges indicated below.

- Total piping length :  
Non. Additional refrigerant ..... 40 m  
Additional refrigerant ..... 70 m  
..... 41 to 70 m  
Additional 20 g of refrigerant..... Per every 1 m
- Minimum piping length :  
A or B or C = 3 m or more
- Maximum indoor piping length :  
A or B or C = 25 m or less
- Maximum piping height difference :  
A or B or C = 15 m or less
- Maximum piping/height difference between 2 units = 15 m or less

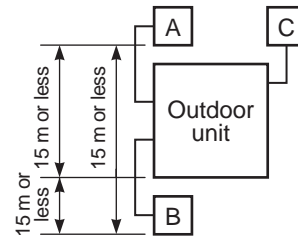


Fig. 10-2-10

4. Connect 2 or more indoor units for heat pump.
5. If the outdoor units is to be mounted on a wall, make sure that the platform supporting it is sufficiently strong.  
The platform should be designed and manufactured to maintain its strength over a long period of time, and sufficient consideration should be given to ensuring that the outdoor unit will not fall.
6. When the outdoor unit is to be mounted high on a wall, take particular care to ensure that parts do not fall installer is protected.
7. When doing installation work on level ground, it is usual to wiring and piping connections to the indoor units. And/then make to the outdoor unit. However if outdoor work is difficult it is possible instead to make changes to the procedure.

For example by making adjustments to the wiring and piping length on the inside (rather than the outside).

**⚠ CAUTION**

• **KEEP IMPORTANT 6 POINTS FOR PIPING WORK.**

- (1) Take away dust and moisture (inside of the connecting pipes).
- (2) Tighten the connections (between pipes and unit).
- (3) Evacuate the air in the connecting pipes using a VACUUM PUMP.
- (4) Check gas leak (connected points).
- (5) Be sure to fully open the packed valves before operation.
- (6) Reusable mechanical connectors and flared joints are not allowed indoors. When mechanical connectors are reused indoors, sealing parts shall be renewed. When flared joints are reused indoors, the flare part shall be refabricated.

■ **Air Purge**

From the sake of environmental protection, use a vacuum pump to extract the air during installation.

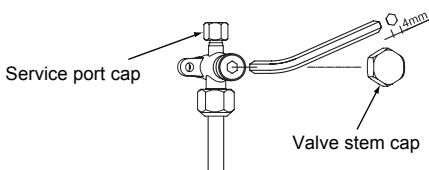
\* Prepare a 4 mm hexagon wrench.

1. Connect a charge hose.
  - Make sure that the Handle Hi of the gauge manifold valve is closed fully.
  - Connect the port of the gauge manifold valve and the service port (Valve core (Setting Pin)) using the charge hose.

**NOTE**

If a control valve or charge valve is attached to the charge hose, leak of R32 refrigerant can be avoided.

2. Open the Handle Low of the gauge manifold valve fully, then operate the vacuum pump.
  - Loosen the flare nut of the at the gas end a little to make sure that air is taken in, then tighten the nut.
  - If you find air is not taken in, make sure that the charge hose is connected to the port(s) securely.
  - Perform extraction for about 15 or more minutes and make sure that the compound pressure gauge reading is  $-101 \text{ kPa}$  ( $-76 \text{ cmHg}$ ).
  - If the compound pressure gauge reading is not  $-101 \text{ kPa}$  ( $-76 \text{ cmHg}$ ), there is a possibility air is being taken in from the port(s).
  - Make sure that the charge hose is connected to the port(s) securely.
3. Close the Handle Low of the gauge manifold valve fully, then stop operating the vacuum pump.
  - Leave the gauge and pump as they are for 1 or 2 minutes, then make sure that the compound pressure gauge reading stays at  $-101 \text{ kPa}$  ( $-76 \text{ cmHg}$ ).
  - You need not add refrigerant.
4. Disconnect the charge hose from the service port, then open the valve stem fully using a 4 mm hexagon wrench.



Hexagon wrench is required.

5. Tighten the service valve stem cap and service port cap securely.

**⚠ CAUTION**

Use a torque wrench and tighten the nut at the specified torque value.

6. Tighten all the caps on the valves securely, then perform a gas leak inspection.
  - The cap with the 9.52 mm outer diameter is available in two sizes in accordance with the type of packed valve for which the cap is used. The tightening torque depends on the width across flats of the cap so check it in the table below.

Service valve		Tighten torque			
		Valve stem cap		Service port cap	
mm		N•m	kgf•m	N•m	kgf•m
Liquid side (9.52)	H19 mm	14 to 18	1.4 to 1.8	-	-
	H22 mm	33 to 42	3.3 to 4.2	-	-
Gas side (12.7)		33 to 42	3.3 to 4.2	14 to 18	1.4 to 1.8

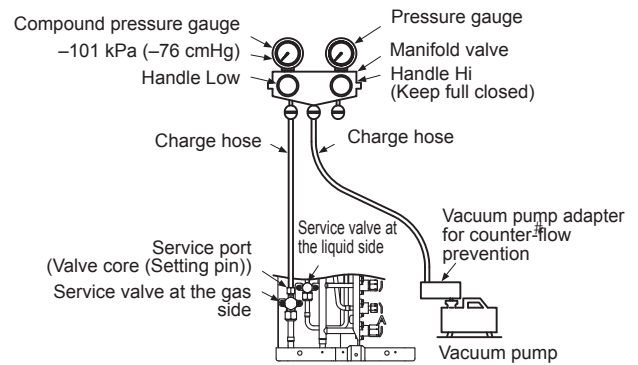
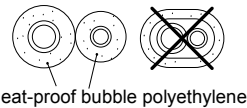


Fig. 10-2-11

■ **Insulation of the Refrigerant Pipes**

- Insulate the refrigerant pipes for liquid and gas separately.

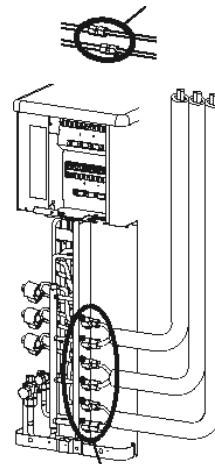


Underground piping: 10t (Laying the pipes on the wall, ceiling, or under the floor)

■ **Gas Leak Inspection**

- Perform a gas leak inspection for the flare nut connections, valve stem connection, and service port cap without fail.
- Use a leak detector exclusively manufactured for R32.

Flare nut connections (Indoor unit)



Check places for outdoor unit

Fig. 10-2-12

■ **Performing Additional Installation of an Indoor Unit**

1. Collect refrigerant from the outdoor unit.
2. Turn off the circuit breaker.
3. Perform additional installation referring to the procedure from "Refrigerant Piping Connection" on the previous page.

**10-2-6. Electrical Work**

For the air conditioner that has no power cord, connect a power cord to it as mentioned below.

Model	3 Units Multi
	RAS-3M26U2AVG-E,-TR
Power supply	220 – 240 V, ~50 Hz
Maximum running current	16.1A
Installation fuse rating	20 A breaker or fuse (All types can be used.)
Power cord	H07 RN-F or 245 IEC 66 (2.5 mm <sup>2</sup> or more)

**⚠ WARNING**

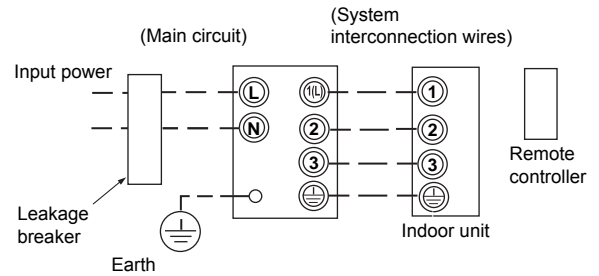
- Be sure to comply with local regulations/ codes when running the wire from the outdoor unit to the indoor unit. (Size of wire and wiring method etc.)
- A lack of electrical capacitance or incorrect wiring may cause an electric shock or a fire.
- To make sure that the wiring connection are secure, use designated cables.
- Fix the cables securely so that no external force applied to the cables may effect the terminals.
- If wiring connections are incomplete or cables are not fixed securely, it may cause a fire.
- Be sure to ground the outdoor unit.
- Incomplete grounding may lead to an electric shock.

**⚠ CAUTION**

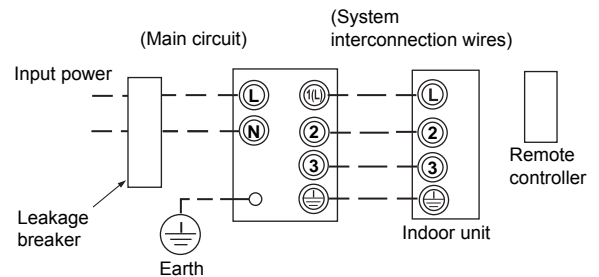
- Use a circuit breaker of a type that is not tripped by shock waves.
- Incorrect/incomplete wiring will cause electrical fires or smoke.
- Prepare the power source for exclusive use with the air conditioner.
- This product can be connected to the main power.  
Fixed wire connections:  
A switch that disconnects all poles and has a contact separation of at least 3 mm must be incorporated into the fixed wiring.

◆ **Wiring connection**

- The dash lines show on-site wiring.
- **For indoor unit RAS-M series.**



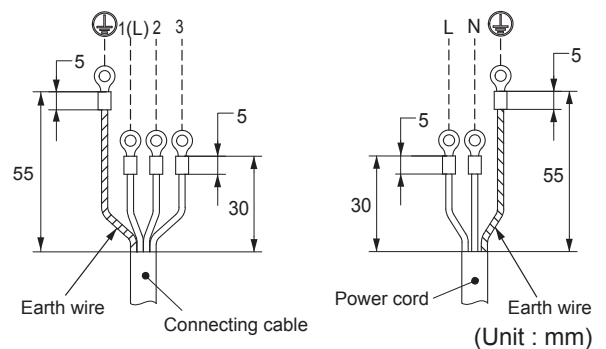
- **For indoor unit RAS-B series.**



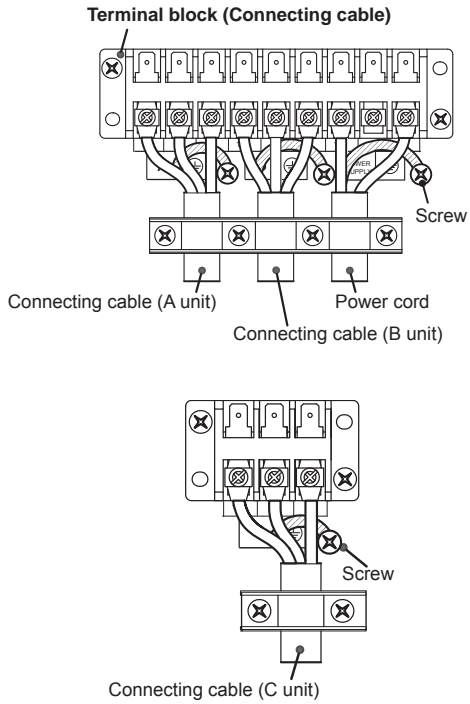
**Fig. 10-2-13**

- Connect the indoor/outdoor connecting cables to the identical terminal numbers on the terminal block of each unit.
  - Incorrect connection may cause a failure.
1. Detach the front panel from the outdoor unit.
  2. Remove the cord clamp.
  3. Connect the wires for the power source and each indoor unit.
    - Connect the connecting cable to the terminal as identified by the matching numbers on the terminal block of the indoor and the outdoor unit.
  4. Fix the wiring connections for the power source and each indoor unit securely using a cord clamp.
  5. Attach the front panel to the outdoor unit.

◆ **Stripping length power cord and connecting cable**



**Fig. 10-2-14**



**Fig. 10-2-15**

### 10-2-7. Grounding

**This air conditioner must be grounded without fail.**

- Grounding is necessary not only to safeguard against the possibility of receiving an electric shock but also to absorb both static, which is generated by high frequencies and held in the surface of the outdoor unit, and noise since the air conditioner incorporates a frequency conversion device (called an inverter) in the outdoor unit.
- If the air conditioner is not grounded, users may receive an electric shock if they touch the surface of the outdoor unit and that unit is charged with static.

### 10-2-8. Miswiring (Miswiring) Check

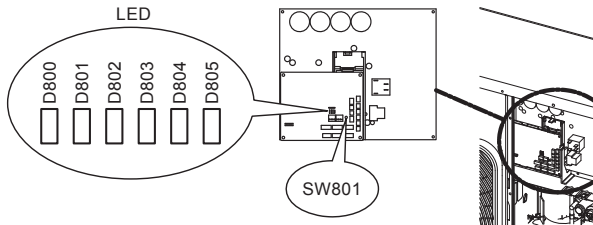
Make sure that the wiring and piping for each room have the same alphabetical codes (A, B, C). Connect and secure the power cord. Use the power cord/cables with thickness, type and protective devices specified in this manual. Insulate the unused cords (conductors) with PVC tape.

#### CAUTION



**Electric current is applied on the control board. Beware of electric shock.**

1. Detach the front panel of the outdoor unit. Do not remove the air discharge grille.



2. Turn on the circuit breaker to supply electricity.

In the initial LED display status, D805 is lighted as below.

○ : ON, ● : OFF, ⊙ : Rapid Flashing (5 times/sec.), ◇ : Slow Flashing (1 time/sec.)

D800	D801	D802	D803	D804	D805
●	●	●	●	●	○

Start running all the indoor units connected to the outdoor unit in the cooling mode. (The indoor unit in the room that doesn't operate the cooling mode cannot be checked.)

3. After 5 minutes, hold down SW801 for at least 5 seconds, and check that D800 is lighted and D804 light is flashing (1 time/sec.).

D800	D801	D802	D803	D804	D805
○	●	●	●	◇	●

4. Press the SW801 4 times until the LED is displayed as below.

D800	D801	D802	D803	D804	D805
●	●	○	●	⊙	●

5. Press SW802 for 1 times. Then D805 light is flashing (5 times/sec.).

D800	D801	D802	D803	D804	D805
●	●	○	●	⊙	⊙

6. Hold down SW802 for at least 5 seconds. Then the wiring/piping check starts automatically. (The LED display is lighted for a moment.)

D800	D801	D802	D803	D804	D805
●	●	○	●	◇	○

- If no problems are detected, the checking operation returns to the normal operation automatically. The LED is displayed as below.

D800	D801	D802	D803	D804	D805
●	●	●	●	●	○

7. The below is displayed when the error is detected. (\* Repetition of 3 sec ON / 0.5 sec OFF)

D800	D801	D802	D803	D804	D805
○*	○*	○*	○*	○*	○

Press the SW801 3 times until the LED is displayed as below, to check the room judged as error.

D800	D801	D802	D803	D804	D805
●	○	●	●	●	⊙

Incorrect wiring/piping can be checked by pressing SW802. The LED is displayed as below. Turn off the circuit breaker, then check wiring/piping again.

○ : ON, ● : OFF, ◇ : Slow Flashing (1 time/sec.)

Check results						Description
D800	D801	D802	D803	D804	D805	
●	●	●	●	●	◇	Normal operation (no error)
○	●	●	●	●	◇	Trouble in unit A
●	○	●	●	●	◇	Trouble in unit B
●	●	○	●	●	◇	Trouble in unit C
○	○	●	●	●	◇	Trouble in units A and B
○	●	○	●	●	◇	Trouble in units A and C
●	○	○	●	●	◇	Trouble in units B and C
○	○	○	●	●	◇	Trouble in units A, B, and C
○	○	○	○	○	◇	Trouble in all units service valve stays closed

- The D800 LED represents unit. A.
- The D801 LED represents unit. B.
- The D802 LED represents unit. C

8. When you want to start over the operation of the SW801 and SW802, press the SW801 and the SW802 at the same time for 5 sec. (The procedure will set back to step 3.) However, do not execute the operation during the check. If by any chance the check is stopped by the operation, start over the check after turning off the power once.

#### 9. Notes

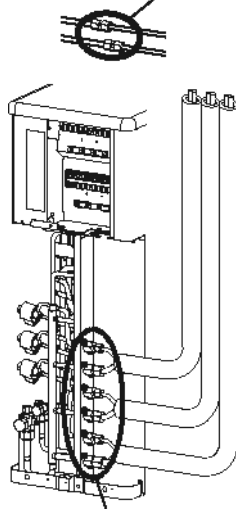
- It sometimes takes about 30 minutes maximum for the check.
- During the check, the compressor and the fan of the outdoor/indoor unit repeat ON/OFF.
- You cannot check wiring/piping when the external temperature is 5°C or less. Also, there is a possibility to misjudge if the indoor temperature becomes too low by cooling operation. In that case, execute the cooling operation for per room and check if the connection is normal.

### 10-3. Test Operation

#### 10-3-1. Gas Leak Test

Check the flare nut connections for gas leaks with a gas leak detector and/or soapy water.

Check places for indoor unit



Check places for outdoor unit

Fig. 10-3-1

#### 10-3-2. Test Operation

To switch the TEST RUN (COOL) mode, press RESET button for 10 sec.  
(The beeper will make a short beep.)

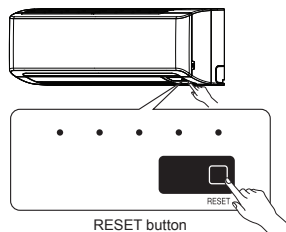


Fig. 10-3-2

#### 10-3-3. Setting the Auto Restart

This product is designed so that, after a power failure, it can restart automatically in the same operating mode as before the power failure.

#### NOTE

The product was shipped with Auto Restart function in the OFF position. Turn it ON as required.

- 1) Push and hold the RESET button for about 3 seconds. After 3 seconds, three short electric beeps will be heard to inform you that the Auto Restart has been selected.
- 2) To cancel the Auto Restart, follow the steps described in the section Auto Restart Function of the Owner's Manual.

#### 10-3-4. Remote Control A-B Selection

- When two indoor units are installed in the same room or adjacent two rooms, if operating a unit, two units may receive the remote control signal simultaneously and operate. In this case, the operation can be preserved by setting either one remote control to B setting. (Both are set to A setting in factory shipment.)
- The remote control signal is not received when the settings of indoor unit and remote control are different.
- There is no relation between A setting/B setting and A room/B room when connecting the piping and cables.

##### <Remote control A-B selection>

To separate using of remote control for each indoor unit in case of 2 air conditioners are installed nearby.

##### <Remote Control B Setup>

1. Press [RESET] button on the indoor unit to turn the air conditioner ON.
2. Point the remote control at the indoor unit.
3. Push and hold [CHECK] button on the Remote Control by the tip of the pencil. "00" will be shown on the display (Picture ①)
4. Press [MODE] during pushing [CHECK]. "B" will show on the display and "00" will disappear and the air conditioner will turn OFF. The Remote Control B is memorized [Picture ②].

- NOTE :**
1. Repeat previous step to reset Remote Control to be A.
  2. Remote Control A has not "A" display.
  3. Default setting of Remote Control from factory is A.

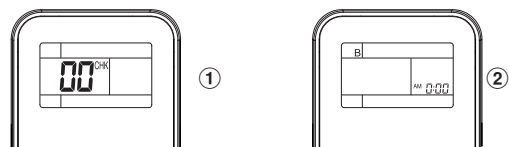


Fig. 10-3-3

## 11. HOW TO DIAGNOSE THE TROUBLE

The pulse modulating circuits are mounted to both indoor and outdoor units.

Therefore, diagnose troubles according to the trouble diagnosis procedure as described below.

(Refer to the check points in servicing written on the wiring diagrams attached to the indoor/outdoor units.)

Table 11-1

No.	Troubleshooting Procedure	Page
1	First Confirmation	64
2	Primary Judgment	65
3	Judgment by Flashing LED of Indoor Unit	65
4	Self-Diagnosis by Remote Controller (Check Code)	66
5	Judgment of Trouble by Symptom	73
6	Trouble Diagnosis by Outdoor LED	75
7	Inspection of the Main Parts	83
8	How to Simply Judge Whether Outdoor Fan Motor is Good or Bad	84

### NOTE

A large-capacity electrolytic capacitor is used in the outdoor unit controller (inverter). Therefore, if the power supply is turned off, charge (charging voltage DC280V to 373V) remains and discharging takes a lot of time (for more than 5 minutes). After turning off the power source, if touching the charging section before discharging, an electrical shock may be caused.

Discharge the electrolytic capacitor completely by using solder iron, etc.

### **⚠ WARNING**

The electrolytic capacitor may not normally discharge according to error contents and the voltage may remain. Therefore, be sure to discharge the capacitor.

### **⚠ WARNING**

For discharging, never use a screwdriver and others for short-circuiting between + and – electrodes, As the electrolytic capacitor is one with a large capacity, it is very dangerous because a large electric spark will occur.

### <Discharging method>

Connect the discharge resistance (approx. 100Ω/40W) or plug of the soldering iron to voltage between + and – of C13 on the main P.C. board MCC-1571, and then perform discharging.

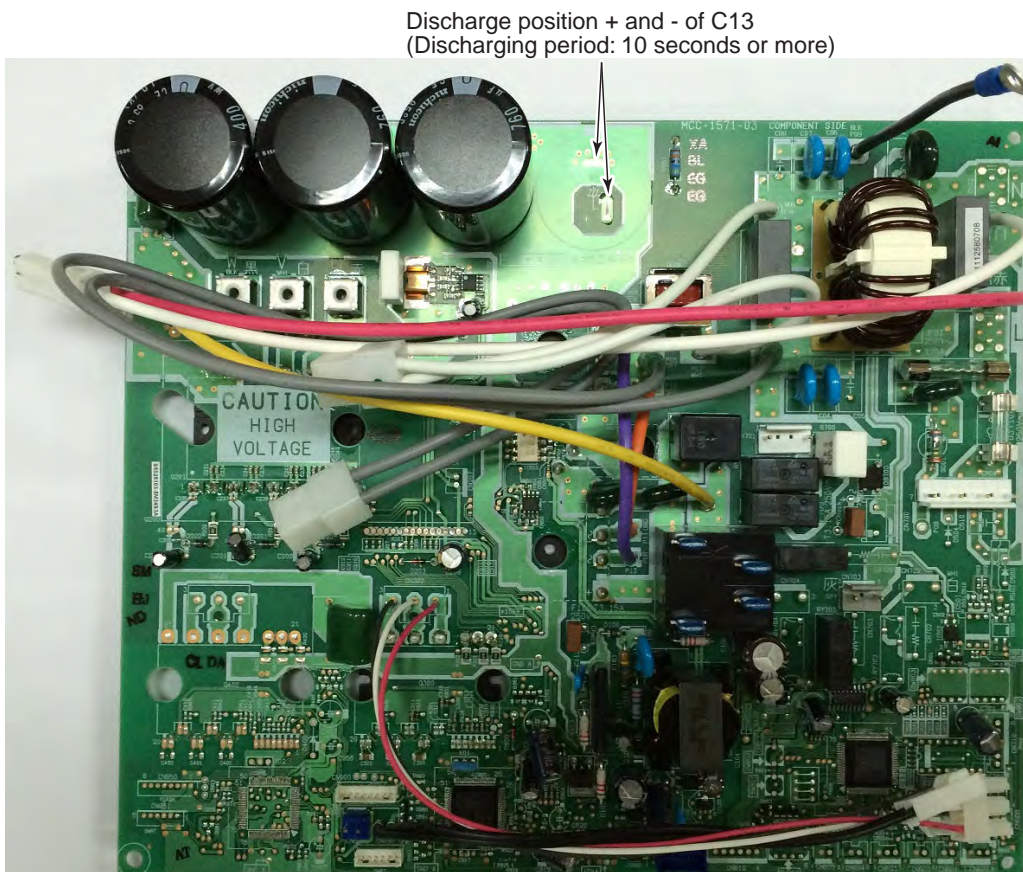


Fig. 11-1

**11-1. First Confirmation**

**11-1-1. Confirmation of Power Supply**

Confirm that the power breaker operates (ON) normally.

**11-1-2. Confirmation of Power Voltage**

Confirm that power voltage is AC 220–240 ±10%.

If power voltage is not in this range, the unit may not operate normally.

**11-1-3. Operation Which is not a Trouble (Program Operation)**

For controlling the air conditioner, the program operations are built in the microcomputer as described in the following table.

If a claim is made for running operation, check whether or not it meets to the contents in the following table.

When it does, we inform you that it is not trouble of equipment, but it is indispensable for controlling and maintaining of air conditioner.

**Table 11-1-1**

No.	Operation of air conditioner	Description
1	When power breaker is turned "ON", the operation lamp (Green) of the indoor unit flashes.	The OPERATION lamp of the indoor unit flashes when power source is turned on. If "START/STOP" button is operated once, flashing stops. (Flashes also in power failure)
2	Compressor may not operate even if the room temperature is within range of compressor-ON.	The compressor does not operate while compressor restart delay timer (3-minutes timer) operates. The same phenomenon is found after power source has been turned on because 3-minutes timer operates.
3	In DRY and SLEEP MODE, FAN (air flow) display does not change even though FAN (air flow select) button is operated.	The air flow indication is fixed to [AUTO].
4	Increasing of compressor motor speed stops approx. 30 seconds after operation started, and then compressor motor speed increases again approx. 30 seconds after.	For smooth operation of the compressor, the compressor motor speed is restricted to Max. 33 rps for 2 minutes and Max. 57 rps for 2 minutes to 4 minutes, respectively after the operation has started.
5	The set value of the remote control should be below the room temperature.	If the set value is above the room temperature, Cooling operation is not performed. And check whether battery of the remote control is consumed or not.
6	In AUTO mode, the operation mode is changed.	After selecting Cool or Heat mode, select an operation mode again if the compressor keeps stop status for 15 minutes.
7	In HEAT mode, the compressor motor speed does not increase up to the maximum speed or decreases before the temperature arrives at the set temperature.	The compressor motor speed may decrease by high-temp. release control (Release protective operation by temp.-up of the indoor heat exchanger) or current release control.
8	Cool, Dry, or Heat operation cannot be performed.	When the unit in other room operates previously in different mode, Fan Only operation is performed because of first-push priority control. (Cool operation and Dry operation can be concurrently performed.)



### 11-2. Primary Judgment

To diagnose the troubles, use the following methods.

- 1) Judgment by flashing LED of indoor unit
- 2) Self-diagnosis by service check remote controller
- 3) Judgment of trouble by every symptom

Firstly use the method (1) for diagnosis. Then, use the method (2) or (3) to diagnose the details of troubles.

For any trouble occurred at the outdoor unit side, detailed diagnosis is possible by 6-serial LED on the control P.C. board.

### 11-3. Judgment by Flashing LED of Indoor Unit

While the indoor unit monitors the operation status of the air conditioner, if the protective circuit operates, the contents of self-diagnosis are displayed with block on the indoor unit indication section.

Table 11-3-1

	Item	Check code	Block display	Description for self-diagnosis
<div style="border: 1px solid black; padding: 5px; width: fit-content; margin-bottom: 5px;">Indoor indication lamp flashes.</div> <div style="text-align: center;">↓</div> <div style="border: 1px solid black; padding: 5px; width: fit-content; margin-bottom: 5px;">Which lamp does flash?</div> <div style="text-align: center;">↓</div> <div style="text-align: center;">→</div>	<b>A</b>	—	OPERATION (Green) Flashing display (1 Hz)	Power failure (when power is ON)
	<b>B</b>	00	OPERATION (Green) Flashing display (5 Hz)	Protective circuit operation for indoor P.C. board
	<b>C</b>	01	OPERATION (Green) TIMER (Orange) Flashing display (5 Hz)	Protective circuit operation for connecting cable and serial signal system
	<b>D</b>	02	OPERATION (Green) Flashing display (5 Hz)	Protective circuit operation for outdoor P.C. board
	<b>E</b>	03	OPERATION (Green) TIMER (Orange) Flashing display (5 Hz)	Protective circuit operation for others (including compressor)

#### NOTE

- The contents of items B and C and a part of item E are displayed when air conditioner operates.
- When item B and C, and item B and a part of item E occur concurrently, priority is given to the block of item B.
- The check codes can be confirmed on the remote controller for servicing.

### 11-4. Self-Diagnosis by Remote Controller (Check Code)

1. If the lamps are indicated as shown B to E in Table 11-3-1, execute the self-diagnosis by the remote controller.
2. When the remote controller is set to the service mode, the indoor controller diagnoses the operation condition and indicates the information of the self-diagnosis on the display of the remote controller with the check codes.

If a fault is detected, all lamps on the indoor unit will flash at 5Hz and it will beep for 10 seconds (Beep, Beep, Beep ...). The timer lamp usually flashes (5Hz) during self-diagnosis.

#### 11-4-1. How to Use Remote Controller in Service Mode

**1** Press [CHECK] button with a tip of pencil to set the remote controller to the service mode.

- “00” is indicated on the display of the remote controller.

**2** Press [ON ▲] or [OFF ▲] button

If there is no fault with a code, the indoor unit will beep once (Beep) and the display of the remote controller will change as follows :

→ 00 → 01 → 02 ... 1d → 1E → 33 →

- The TIMER indicator of the indoor unit flashes continuously. (5 times per 1 sec.)
- Check the unit with all 52 check codes ( 00 to 33 ) as shown in Table-11-4-1.
- Press [ON▼] or [OFF ▼] button to change the check code backward.

If there is a fault, the indoor unit will beep for 10 seconds (Beep, Beep, Beep...).

Note the check code on the display of the remote controller.

- 2-digits alphanumeric will be indicated on the display.
- All indicators on the indoor unit will flash. (5 times per 1 sec.)

**3** Press [CLR] button. After service finish for clear service code in memory.

- "7F" is indicated on the display of the remote control.

**4** Press [⏻] button to release the service mode.

- The display of the remote controller returns to as it was before service mode was engaged.

Alphanumeric characters are used for the check codes.

5 is 5.	6 is 6.
A is A.	B is B.
C is C.	D is D.

Fig. 11-4-1

**11-4-2 Caution at Servicing**

1. After using the service mode of remote controller finished, press the [ ⏻ ] button to reset the remote controller to normal function.
2. After finished the diagnosis by the remote controller, turn OFF power supply and turn its ON again to reset the air conditioner to normal operation. However, the check codes are not deleted from memory of the microcomputer.
3. After servicing finished, press [ CLR ] button of remote controller under service mode status to send code "7F" to the indoor unit. The check code stored in memory is cleared.

Table 11-4-1

Block distinction		Operation of diagnosis function				Action and Judgment
Check code	Block	Check code	Cause of operation	Air conditioner status	Display flashing error	
00	Indoor	01	TA sensor ; The room temperature sensor is short-Circuit or disconnection.	Operation continues.	Flashes when error is detected.	1. Check the sensor TA and connection. 2. In case of the sensor and its connection is normal, check the P.C. board.
		02	TC sensor ; The heat exchanger temperature sensor of the indoor unit is out of place, disconnection, short-circuit or migration.	Operation continues.	Flashes when error is detected.	1. Check the sensor TC and connection. 2. In case of the sensor and its connection is normal, check the P.C. board.
		11	Fan motor of the indoor unit is failure, lock-rotor, short-circuit, disconnection, etc. Or its circuit on P.C. board has problem.	All OFF	Flashes when error is detected.	1. Check the fan motor and connection. 2. In case of the motor and its connection is normal, check the P.C. board.
		12	Other trouble on the indoor P.C. board.	Depend on cause of failure.	Depend on cause of failure.	Replace P.C. board.

Block distinction		Operation of diagnosis function				Action and Judgment
Check code	Block	Check code	Cause of operation	Air conditioner status	Display flashing error	
01	Serial signal and connecting cable.	04	1) Defective wiring of the connecting cable or miss-wiring. 2) Operation signal has not send from the indoor unit when operation start. 3) Outdoor unit has not send return signal to the indoor unit when operation started. 4) Return signal from the outdoor unit is stop during operation. <ul style="list-style-type: none"> <li>• Some protector (hardware, if exist) of the outdoor unit open circuit of signal.</li> <li>• Signal circuit of indoor P.C. board or outdoor P.C. board is failure in some period.</li> </ul>	Indoor unit operates continue. Outdoor unit stop.	Flashes when error is detected. Flashing stop and outdoor unit start to operate when the return signal from the outdoor unit is normal.	1) to 3) The outdoor unit never operate. <ul style="list-style-type: none"> <li>• Check connecting cable and correct if defective wiring.</li> <li>• Check 25A fuse of inverter P.C. board.</li> <li>• Check 3.15A fuse of inverter P.C. board.</li> <li>• Check operation signal of the indoor unit by using diode. Measure voltage at terminal block of the indoor unit between No.2 and No.3 (or L2 and S) If signal is varied 15-60V continuously, replace inverter P.C. board. If signal is not varied, replace indoor P.C. board.</li> </ul> 4) The outdoor unit abnormal stop at some time. <ul style="list-style-type: none"> <li>• If the other check codes are found concurrently, check them together.</li> <li>• Check protector (hardware) such as Hi-Pressure switch, Thermal-Relay, etc.</li> <li>• Check refrigerant amount or any possibility case which may caused high temperature or high pressure.</li> <li>• Check operation signal of the indoor unit by using diode. Measure voltage at terminal block of the indoor unit between No.2 and No.3 (or L2 and S) If signal is varied 15-60V continuously, replace inverter P.C. board. If signal is not varied, replace indoor P.C. board.</li> </ul>

**Note : Operation signal of the indoor unit shall be measured in the sending period as picture below.**

**Sending signal of the indoor unit when have not return signal from the outdoor unit.**

\* Signal send only 1 minute and stop. Because of return signal from outdoor unit has not received.  
 \*\* Signal resend again after 3 minutes stop. And the signal will send continuously.  
 \*\*\* 1 minute after resending, the indoor unit display flashes error.

Block distinction		Operation of diagnosis function				Action and Judgment
Check code	Block	Check code	Cause of operation	Air conditioner status	Display flashing error	
02	Outdoor	14	Current on inverter circuit is over limit in short time. <ul style="list-style-type: none"> <li>• Inverter P.C. board is failure, IGBT shortage, etc.</li> <li>• Compressor current is higher than limitation, lock rotor, etc.</li> </ul>	All OFF	Flashes after error is detected 8 times*.	<ol style="list-style-type: none"> <li>1. Remove connecting lead wire of the compressor, and operate again.</li> <li>2. If outdoor fan does not operate or operate but stop after some period, replace the inverter P.C. board.</li> <li>3. If outdoor fan operates normally, measure 3-Phase output of inverter P.C. board (150-270VAC) at the connecting lead wire of compressor.</li> <li>4. If 3-Phase output is abnormal, replace inverter P.C.Board.</li> <li>5. If 3-Phase output is normal, replace compressor. (lock rotor, etc.)</li> </ol>
		15	Compressor position-detect circuit error or short-circuit between winding of compressor.	All OFF	Flashes after error is detected 8 times*.	<ol style="list-style-type: none"> <li>1. Remove connecting lead wire of the compressor, and operate again.</li> <li>2. If outdoor fan does not operate or operation but stop after some period, replace the inverter P.C. board.</li> <li>3. If outdoor fan operates normally, measure resistance of compressor winding. If circuit is shortage, replace the compressor.</li> </ol>
		17	Current-detect circuit of inverter P.C. board error.	All OFF	Flashes after error is detected 4 times*.	Even if trying to operate again, all operations stop, replace inverter P.C. board.
		18	TE or TS sensor; abnormal. Out of place, disconnection, shortage, or misconnection (TE sensor is connected to TS connector, TS sensor is connected to TE sensor connector)  TE sensor; Outdoor heat exchanger temperature sensor  TS sensor; Suction pipe temperature sensor	All OFF	Flashes after error is detected 4 times*.	<ol style="list-style-type: none"> <li>1. Check sensors, TE, TS connection. In case of sensors and it's connection is normal, check the inverter P.C. board</li> <li>2. Check 4way valve operation/position. In case TE, TS detected temperature relationship are different from normal operation, "18" might be detected.</li> </ol>
		19	TD sensor ; Discharge pipe temperature sensor is disconnection or shortage.	All OFF	Flashes after error is detected 4 times*.	<ol style="list-style-type: none"> <li>1. Check sensors TD and connection.</li> <li>2. In case of the sensor and its connection is normal, check the inverter P.C. board.</li> </ol>
		1A	Outdoor fan failure or its drive-circuit on the inverter P.C. board failure.	All OFF	Flashes after error is detected 8 times*.	<ol style="list-style-type: none"> <li>1. Check the motor, measure winding resistance, shortage or lock rotor.</li> <li>2. Check the inverter P.C. board.</li> </ol>
		1b	TO sensor ; The outdoor temperature sensor is disconnection or shortage.	Operation continues.	Record error after detected 4 times*. But does not flash display.	<ol style="list-style-type: none"> <li>1. Check sensors TO and connection.</li> <li>2. In case of the sensor and its connection is normal, check the inverter P.C. board.</li> </ol>

Block distinction		Operation of diagnosis function				Action and Judgment
Check code	Block	Check code	Cause of operation	Air conditioner status	Display flashing error	
02	Outdoor	11	<p>Compressor drive output error. (Relation of voltage, current and frequency is abnormal)</p> <ul style="list-style-type: none"> <li>• Overloading operation of compressor caused by over-charge refrigerant, P.M.V. failure, etc.</li> <li>• Compressor failure (High current).</li> <li>• TE or TS sensor; abnormal. Out of place, disconnection, shortage, or misconnection (TE sensor is connected to TS connector, TS sensor is connected to TE sensor connector)</li> </ul> <p>TE sensor; Outdoor heat exchanger temperature sensor TS sensor; Suction pipe temperature sensor</p>	All OFF	Flashes after error is detected 8 times*.	<ol style="list-style-type: none"> <li>1. Check installation conditions such as packed valve opening, refrigerant amount and power supply (rate <math>\pm 10\%</math>, both of operation and non operation condition).</li> <li>2. (In case of P.M.V. exists) Check P.M.V. by measure the resistance of the coil and confirm its operation (sound of initial operation, etc.)</li> <li>3. Observe any possibility cause which may affect operation load of compressor.</li> <li>4. Operate again. If compressor operation is failure when 20 seconds passed (count time from operation starting of compressor), replace compressor.</li> <li>5. Check sensors, TE, TS connection. In case of sensors and it's connection is normal, check the inverter P.C. board.</li> <li>6. Check 4way valve operation/position. In case TE, TS detected temperature relationship are different from normal operation, "1C" might be detected.</li> </ol>
<p>* 4 or 8 times ; When first error is detected, error is count as 1 time, then once operation is stop and re-started. After re-starting operation within 6 minutes, if same error is detected, error count is add (count become 2 times) When error count comes 4, 8, 11 or 18 times, record error to check code. But after re-starting operation, if no error is detected and air conditioner can operate more than 6 minutes, error count is cleared.</p>						
03	The others (including compressor)	07	<p>Return signal of the outdoor unit has been sent when operation start. But after that, signal is stop some time.</p> <ul style="list-style-type: none"> <li>• Instantaneous power failure.</li> <li>• Some protector (hardware) of the outdoor unit open circuit of signal.</li> <li>• Signal circuit of indoor P.C. board or outdoor P.C. board is failure in some period.</li> </ul>	Indoor unit operates continue. Outdoor unit stop.	Flashes when error is detected. Flashing stop and outdoor unit start to operate when the return signal from the outdoor unit is normal.	<ol style="list-style-type: none"> <li>1. Check power supply (Rate <math>\pm 10\%</math>)</li> <li>2. If the air conditioner repeat operates and stop with interval of approx. 10 to 40 minutes. <ul style="list-style-type: none"> <li>• (In case of these exist) Check protector (hardware) such as Hi-Pressure switch, Thermal-Relay, etc.</li> <li>• Check refrigerant amount, packed valve opening and any possibility cause which may affect high temperature or high pressure.</li> </ul> </li> <li>3. Check operation signal of the indoor unit by using diode. Measure voltage at terminal block of the indoor unit between No.2 and No.3 (or L2 and S) If signal is varied 15-60V continuously, replace inverter P.C. board. If signal is not varied, replace indoor P.C. board.</li> </ol>

Block distinction		Operation of diagnosis function				Action and Judgment
Check code	Block	Check code	Cause of operation	Air conditioner status	Display flashing error	
03	The others (including compressor)	1d	Compressor does not rotate. Because of missed wiring, missed phase or shortage.	All OFF	Flashes after error is detected 8 times*.	<ol style="list-style-type: none"> <li>1. Remove connecting lead wire of the compressor, and operate again.</li> <li>2. If outdoor fan does not operate or operation but stop after some period, replace the inverter P.C. board.</li> <li>3. If outdoor fan operates normally, measure 3-Phase output of inverter P.C. board (150-270VAC) at the connecting lead wire of compressor.</li> <li>4. If 3-Phase output is abnormal, replace inverter P.C.Board.</li> <li>5. If 3-Phase output is normal, measure resistance of compressor winding.</li> <li>6. If winding is shortage, replace the compressor.</li> </ol>
		1E	Discharge temperature exceeded 117°C.	All OFF	Flashes after error is detected 4 times*.	<ol style="list-style-type: none"> <li>1. Check sensors TD.</li> <li>2. Check refrigerant amount.</li> <li>3. (In case of P.M.V. exists) Check P.M.V. by measure the resistance of the coil and confirm its operation (sound of initial operation, etc.)</li> <li>4. Observe any possibility cause which may affect high temperature of compressor.</li> </ol>
		1F	Compressor is high current though operation Hz is decreased to minimum limit. <ul style="list-style-type: none"> <li>● Installation problem.</li> <li>● Instantaneous power failure.</li> <li>● Refrigeration cycle problem.</li> <li>● Compressor break down.</li> <li>● Compressor failure (High current).operation, etc.)</li> </ul>	All OFF	Flashes after error is detected 8 times*.	<ol style="list-style-type: none"> <li>1. Check installation conditions such as packed valve opening, refrigerant amount and power supply (rate <math>\pm 10\%</math>, both of operation and non operation condition).</li> <li>2. (In case of P.M.V. exists) Check P.M.V. by measure the resistance of the coil and confirm its operation (sound of initial operation, etc.)</li> <li>3. Observe any possibility cause which may affect high current of compressor.</li> <li>4. If 1, 2 and 3 are normal, replace compressor.</li> </ol>

Block distinction		Operation of diagnosis function				Action and Judgment
Check code	Block	Check code	Cause of operation	Air conditioner status	Display flashing error	
03	The others (including compressor)	21	<p>Return signal of the outdoor unit has been sent when operation start. But after that, signal is stop some time.</p> <ul style="list-style-type: none"> <li>Instantaneous power failure.</li> <li>Some protector (hardware) of the outdoor unit open circuit of signal.</li> <li>Signal circuit of indoor P.C. board or outdoor P.C. board is failure in some period.</li> <li>TE, TC high temperature TE for cooling operation TC for heating operation. (TE only exists in the Heat Pump system)</li> <li>TE or TS sensor; abnormal. Out of place, disconnection, shortage, or misconnection (TE sensor is connected to TS connector, TS sensor is connected to TE sensor connector)  TE sensor; Outdoor heat exchanger temperature sensor TS sensor; Suction pipe temperature sensor</li> </ul>	Indoor unit operates continue. Outdoor unit stop.	Flashes when error is detected 11 times*. Flashing stop and outdoor unit start to operate when the return signal from the outdoor unit is normal.	<ol style="list-style-type: none"> <li>Check power supply (Rate <math>\pm 10\%</math>)</li> <li>If the air conditioner repeat operat and stop with interval of approx. 10 to 40 minutes. <ul style="list-style-type: none"> <li>(In case of these exist) Check protector (hardware) such as Hi-Pressure switch, Thermal-Relay, etc.</li> <li>Check refrigerant amount, packed valve opening and any possibility cause which may affect high temperature or high pressure.</li> </ul> </li> <li>Check operation signal of the indoor unit by using diode. Measure voltage at terminal block of the indoor unit between No.2 and No.3 (or L2 and S) If signal is varied 15-60V continuously, replace inverter P.C. board. If signal is not varied, replace indoor P.C. board.</li> <li>Check and clean heat exchanger area Indoor and Outdoor unit.</li> <li>Check sensors, TE, TS connection. In case of sensors and it's connection is normal, check the inverter P.C. board.</li> <li>Check 4way valve operation/position. In case TE, TS detected temperature relationship are different from normal operation, "21" might be detected.</li> </ol>
<p>* 4, 8 or 11 times ; When first error is detected, error is count as 1 time, then once operation is stop and re-started. After re-starting operation within 6 minutes, if same error is detected, error count is add (count become 2 times) When error count comes 4, 8, 11 or 18 times, record error to check code. But after re-starting operation, if no error is detected and air conditioner can operate more than 6 minutes, error count is cleared.</p>						



## 11-5. Judgment of Trouble by Symptom

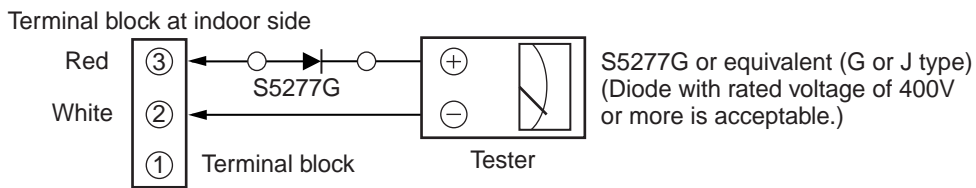
### 11-5-1. Wiring Failure (Interconnecting and Serial Signal)

#### Wire)(1) Outdoor unit does not operate

- 1) Is the voltage between ② and ③ of the indoor terminal block varied?
- 2) Confirm that transmission from indoor unit to outdoor unit is correctly performed based upon the following diagram.

#### NOTE

- Measurement should be performed 2 minutes and 30 seconds after starting of the operation.
- Be sure to prepare a diode for judgment.



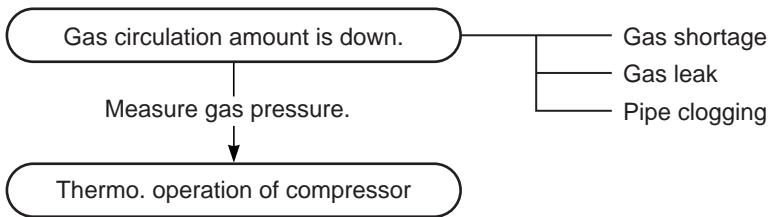
Normal time : Voltage swings between DC15 and 60V. .... Inverter Assembly check

Abnormal time : Voltage does not vary.

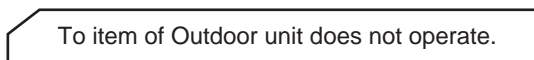
#### (2) Outdoor unit stops in a little while after operation started

**<Check procedure> Select phenomena described below.**

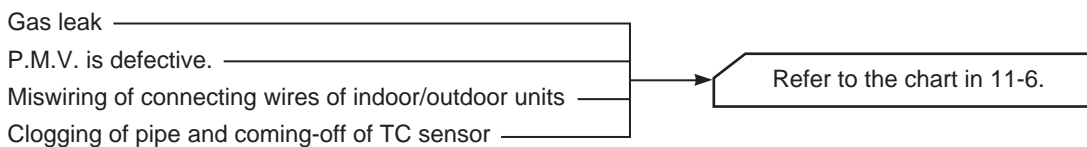
- 1) The outdoor unit stops 10 to 20 minutes after operation started, and 10 minutes or more are required to restart the unit.



- 2) If the unit stops once, it does not operate until the power will be turned on again.



- 3) The outdoor unit stops 10 minutes to 1 hour after operation started, and an alarm is displayed. (Discharge temp. error check code 03, 1E Sensor temp. error check code 02, 1C)



## Service Support Function (LED Display, Switch Operation)

### 1. Outline

A various setup and operation check can be performed by the push down button switches (SW801, SW802) on the outdoor control P.C. board WP-041.

### Operation part

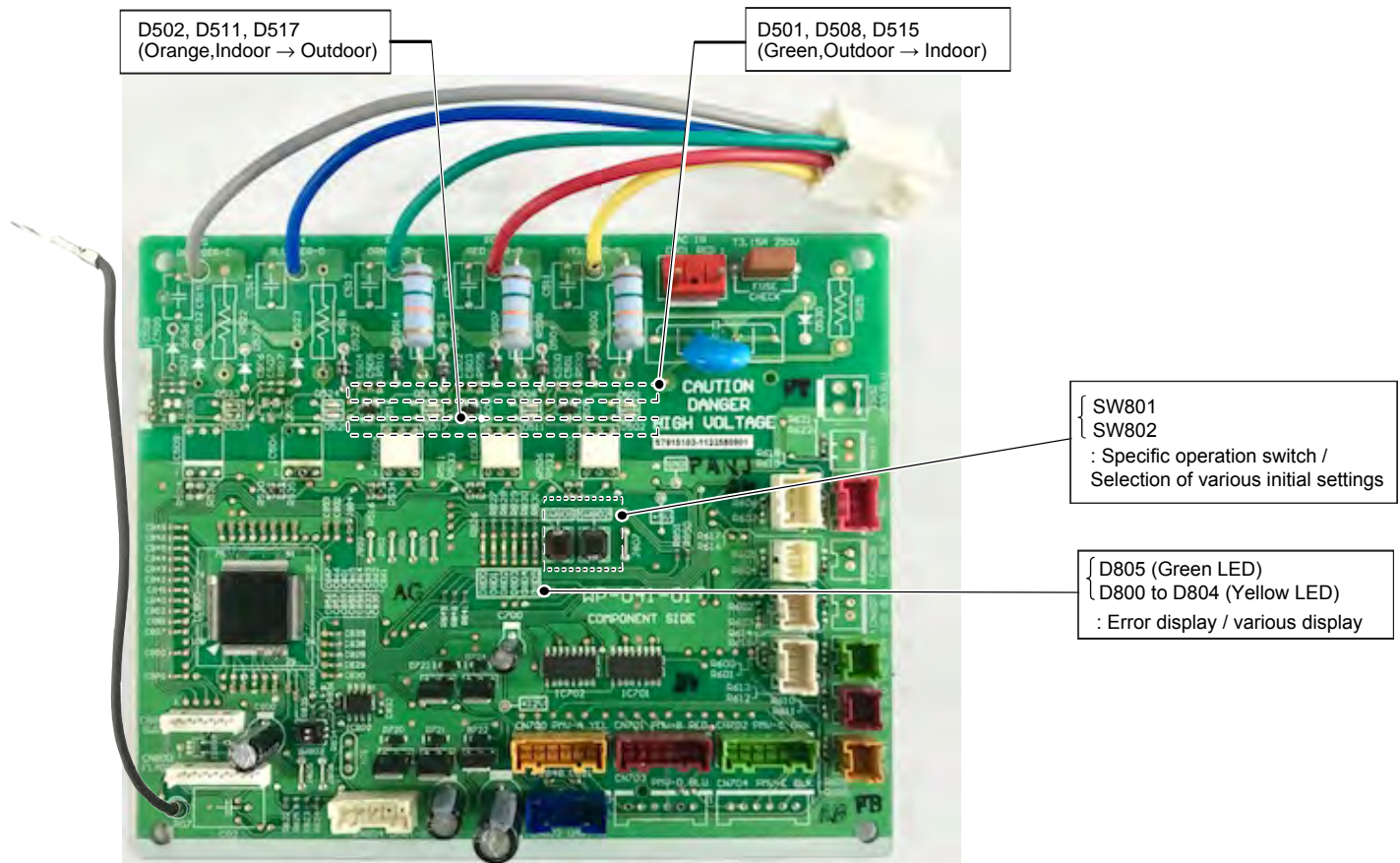
Part No.	Specifications	Operation contents
SW801 SW802	Push down button switch	Performs the specific operation to check maintenance and various initial settings.

### Display part

Part No.	Specifications	Operation contents
D502, D511, D517	Orange LED	Indoor/Outdoor communication (Serial communication) signal display (Receive signal from indoor signal)
D501, D508, D515	Green LED	Indoor/Outdoor communication (Serial communication) signal display (Send signal from outdoor signal)
D805	Green LED	(1) Power-ON display When the power of the outdoor unit is turned on, D805 LED goes on. (2) Error display When the outdoor controller detects some errors, some LEDs go on or flash according to the error as described in Error display table. (Refer to 11-6)
D800 to D804	Yellow LED	(3) Specific operation display When SW801 is pushed and a specific operation is operated, some LEDs go on or flash.

\* Every LED is colorless when it goes off.

### Control P.C.B WP-041



### 11-6. Trouble Diagnosis by Outdoor LED

For the outdoor unit, the self-diagnosis is possible by LED (Green) and five LEDs (Yellow). Green LED (D805) and Yellow LEDs (D800 to D804) are provided on the display P.C. board WP-041.

1. In the initial LED display status, Green LED(D805) is lighted as below.

Normal						Error occurring					
D800 (Yellow)	D801 (Yellow)	D802 (Yellow)	D803 (Yellow)	D804 (Yellow)	D805 (Green)	D800 (Yellow)	D801 (Yellow)	D802 (Yellow)	D803 (Yellow)	D804 (Yellow)	D805 (Green)
●	●	●	●	●	○	●/○*	●/○*	●/○*	●/○*	●/○*	○

○:ON ●:OFF ○:ON ○\*:3 sec ON/0.5 sec OFF ●:OFF

- If there is an error, Yellow LED are lighted according to the error as described in the below table.
- When there are two or more errors, LEDs flash cyclically.
- When D804 or D805 are flashing (rapid or slow), push and hold SW801 and SW802 simultaneously for 5 seconds or more. (Display returns to the error display.)

○:ON (○\*:3 sec ON/0.5 sec OFF) ●:OFF

◎:Rapid Flashing(5 times/sec) ◇:Slow Flashing(1 time/sec)

Display						Indoor check code	Description
D800 (YL)	D801 (YL)	D802 (YL)	D803 (YL)	D804 (YL)	D805 (GN)		
●	●	●	●	●	○	-	Normal operation (no error)
○*	●	●	●	●	○	1C	Compressor case thermostat error
●	○*	●	●	●	○	21	High pressure switch error
○*	○*	●	●	●	○	1C	Compressor system error
●	●	○*	●	●	○	1D	Compressor lock
○*	●	○*	●	●	○	1F	Compressor breakdown
●	○*	○*	●	●	○	14	Driving element short circuit
○*	○*	○*	●	●	○	16	Position detection circuit error
●	●	●	○*	●	○	17	Current detection circuit error
○*	●	●	○*	●	○	1C	Communication error between MCU
●	○*	●	○*	●	○	1A	Fan system error
○*	○*	●	○*	●	○	1E	Discharge temperature error
●	●	○*	○*	●	○	19	Discharge temperature sensor (TD) error
*1 ○*	●	○*	○*	●	○	1B	Outdoor air temperature sensor (TO) error
●	○*	○*	○*	●	○	18	Suction temperature sensor (TS) error
○*	○*	○*	○*	●	○	18	Heat exchanger temperature sensor (TE) error
*2 ●	●	●	●	○*	○	1C	Gas pipe (unit A) temperature sensor (TGa) error
*2 ○*	●	●	●	○*	○	1C	Gas pipe (unit B) temperature sensor (TGb) error
*2 ●	○*	●	●	○*	○	1C	Gas pipe (unit C) temperature sensor (TGc) error
○*	●	○*	●	○*	○	-	PMV error (SH≥20)
●	○*	○*	●	○*	○	-	PMV error (SH≤-8)
●	●	●	○*	○*	○	20	PMV leakage error (unit A)
○*	●	●	○*	○*	○	20	PMV leakage error (unit B)
●	○*	●	○*	○*	○	20	PMV leakage error (unit C)
○*	●	○*	○*	○*	○	-	Miswiring (mispiping) check error
●	○*	○*	○*	○*	○	1C	Communication error between MCU
○*	○*	○*	○*	○*	○	1C	Communication error between MCU

- \*1: Back-up operation is performed without error display of the indoor unit.
- \*2: Operated normally when the air conditioners in other rooms are driven.

- The D800 LED represents unit A.
- The D801 LED represents unit B.
- The D802 LED represents unit C.

○:ON (○\*:3 sec ON / 0.5 sec OFF) ●:OFF

Check code	Outdoor LED display	Check and troubleshooting (Item without special mention indicates part of outdoor unit.)
[1C]	○*●●●●○	<p><b>[Case thermo operation, Power supply error ]</b></p> <pre> graph TD     Q1{{Is AC mains voltage correct? (198 to 264V)}} -- NO --&gt; A1[Confirm power supply construction. etc.]     Q1 -- YES --&gt; Q2{{Are CN609 of P.C. board MCC-1571 connection and case thermostat correct?}}     Q2 -- NO --&gt; A2[Correct connector. Case thermostat error → Replace.]     Q2 -- YES --&gt; Q3{{Short each pins of CN609. Can compressor operate?}}     Q3 -- NO --&gt; A3[Check outdoor P.C.B MCC-1571. Defect → Replace.]     Q3 -- YES --&gt; Q4{{Is there gas leak? Is there refrigerant shortage?}}     Q4 -- YES --&gt; A4[Repair defective position. Recharge refrigerant.]     Q4 -- NO --&gt; Q5{{Is service valve fully opened?}}     Q5 -- NO --&gt; A5[Open service valve fully.]     Q5 -- YES --&gt; Q6{{Is PMV under correct conditions?}}     Q6 -- NO --&gt; A6[Correct defective position. Replace defective part.]     Q6 -- YES --&gt; A7[Check crushed or broken pipe. Defect → Correct and Replace.]                     </pre>
[14]	●○*○*●●○	<p><b>[Short-circuit of compressor drive element]</b></p> <pre> graph TD     Q1{{Are connections of compressor lead and reactor correct? (Check referring to the Wiring diagram.)}} -- NO --&gt; A1[Correct wiring.]     Q1 -- YES --&gt; Q2{{Does the same error occur in operation without compressor lead?}}     Q2 -- YES --&gt; A2[Replace outdoor P.C.B MCC-1571.]     Q2 -- NO --&gt; A3[Check compressor. (Rare short, etc.) Defect → Replace.]                     </pre>
[16]	○*○*○*●●○	<p><b>[Position detection circuit error]</b></p> <div data-bbox="507 1720 965 1809" style="border: 1px solid black; padding: 5px; margin: 10px auto; width: fit-content;"> <p>Check outdoor P.C.B MCC-1571. Defect → Replace.</p> </div>
[17]	●●●○*●○	<p><b>[Current detection circuit error]</b></p> <div data-bbox="507 1955 965 2045" style="border: 1px solid black; padding: 5px; margin: 10px auto; width: fit-content;"> <p>Check outdoor P.C.B MCC-1571. Defect → Replace.</p> </div>

○:ON (○\*:3 sec ON / 0.5 sec OFF) ●:OFF

Check code	Outdoor LED display	Check and troubleshooting (Item without special mention indicates part of outdoor unit.)
[18]	<p>●○*○*○*●○</p> <p>○*○*○*○*●○</p>	<p>* There is a possibility that it is one of the following errors. Confirm LED on outdoor P.C. board to judge which error it is. Heat exchanger temp. sensor (TE) error, Suction temp. sensor (TS) error</p> <p><b>[Suction temp. sensor (TS) error]</b></p> <p><b>[Heat exchanger temp. sensor (TE) error]</b></p>
[19]	●●○*○*●○	<p><b>[Discharge temp. sensor (TD) error]</b></p>
[1A]	●○*●○*●○	<p><b>[Fan system error]</b></p>
[1B]	○*●○*○*●○	<p><b>[Outside temp. sensor (TO) error]</b></p>

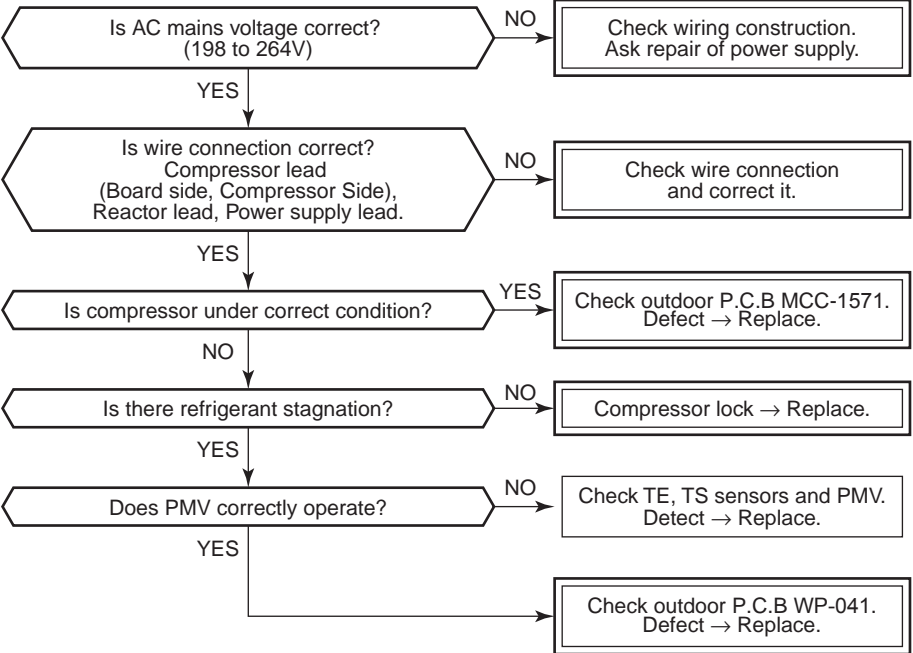
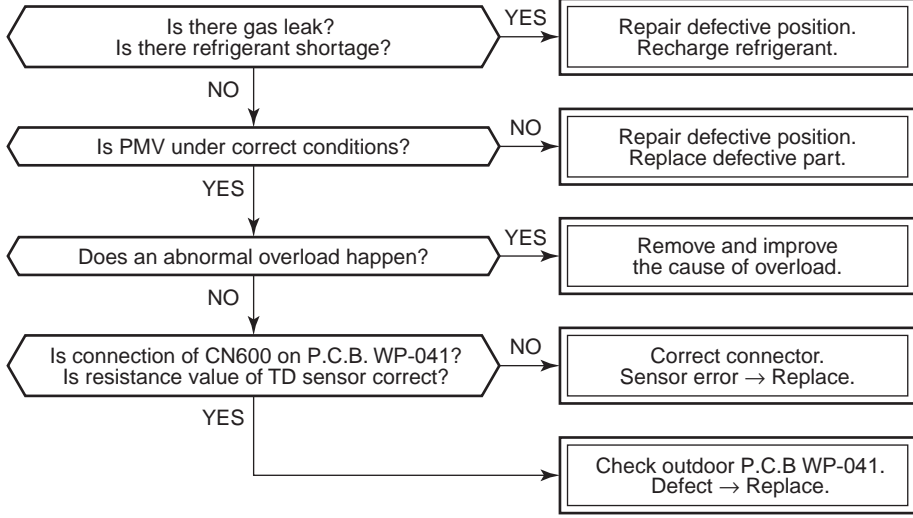
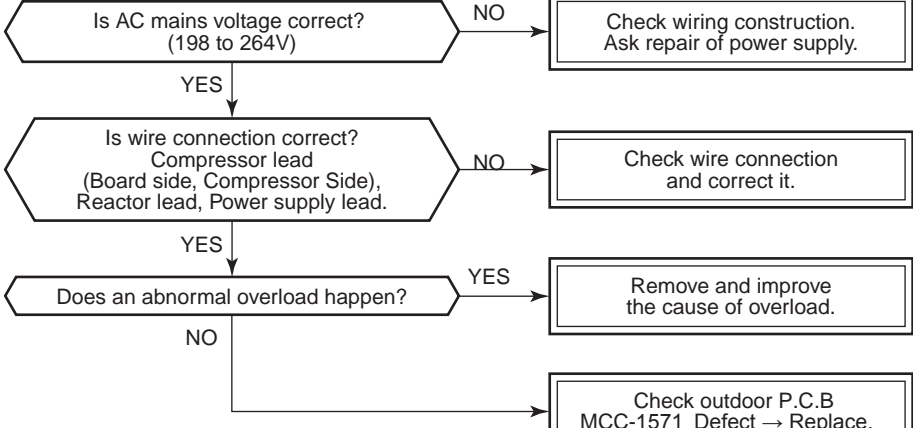
○:ON (○\*:3 sec ON / 0.5 sec OFF) ●:OFF

Check code	Outdoor LED display	Check and troubleshooting (Item without special mention indicates part of outdoor unit.)
[1C]	○*○*●●●○	<p>* There is a possibility that it is one of the following errors. Confirm LED on display P.C. board to judge which error it is. Compressor system error, Compressor lock, Gas side temp. sensor (TGa to TGc) error, Gas leakage, PMV error</p> <p><b>[Compressor system error, Compressor lock]</b></p> <pre> graph TD     Q1{{Is AC mains voltage correct? (198 to 264V)}} -- NO --&gt; A1[Check wiring construction. Ask repair of power supply.]     Q1 -- YES --&gt; Q2{{Is wire connection correct? Compressor lead (Board side, Compressor Side), Reactor lead, Power supply lead.}}     Q2 -- NO --&gt; A2[Check wire connection and correct it.]     Q2 -- YES --&gt; Q3{{Is compressor under correct condition?}}     Q3 -- YES --&gt; S1((1))     Q3 -- NO --&gt; Q4{{Is there refrigerant stagnation?}}     Q4 -- NO --&gt; A3[Compressor lock → Replace.]     Q4 -- YES --&gt; Q5{{Does PMV correctly operate?}}     Q5 -- NO --&gt; A4[Check TE, TS sensor and PMV. Detect → Replace..]     Q5 -- YES --&gt; S2((1))     S1 --&gt; Q6{{Are the power devices on P.C. board MCC-1571 screwed without looseness? (Rear sides of (Q201, Q300, Q650, DB01, DB02) Are radiation grease properly applied these?}}     Q6 -- NO --&gt; A5[Apply radiation grease to objective parts. Retightening of screws.]     Q6 -- YES --&gt; Q7{{Does something block the ventilation around the heat sink? Does something air flow from the fan?}}     Q7 -- YES --&gt; A6[Remove blocking matter. Correct short-circuit.]     Q7 -- NO --&gt; A7[Check outdoor P.C.B MCC-1571 and WP-041. Defect → Replace]     </pre>

○:ON (○\*:3 sec ON / 0.5 sec OFF) ●:OFF

Check code	Outdoor LED display	Check and troubleshooting (Item without special mention indicates part of outdoor unit.)
[1C] (Continued)	●●●●○*○	<p><b>[A room gas side temp. sensor (TGa) error]</b></p>
	○*●●●○*○	<p><b>[B room gas side temp. sensor (TGb) error]</b></p>
	●○*●●○*○	<p><b>[C room gas side temp. sensor (TGc) error]</b></p>
	○*●●○*●○	<p><b>Communication error between MCUs</b></p>
	●○*○*○*○*○	<p><b>[Communication error between MCUs]</b></p>
	○*○*○*○*○*○	<p><b>[Communication error between MCUs]</b></p>

○:ON (○\*:3 sec ON / 0.5 sec OFF) ●:OFF

Check code	Outdoor LED display	Check and troubleshooting (Item without special mention indicates part of outdoor unit.)
[1D]	●●○*●●○	<p><b>[Compressor lock]</b></p> 
[1E]	○*○*●○*●○	<p><b>[Discharge temp. error]</b></p> 
[1F]	○*●○*●●○	<p><b>[Compressor break down]</b></p> 



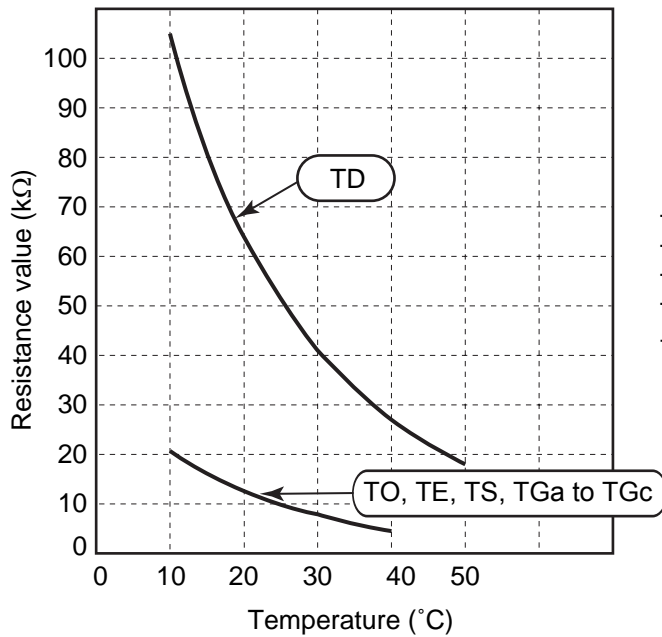
○:ON (○\*:3 sec ON / 0.5 sec OFF) ●:OFF

Check code	Outdoor LED display	Check and troubleshooting (Item without special mention indicates part of outdoor unit.)
[20]	<p>●●●○*○*○</p>	<p>* There is a possibility that it is one of the following errors. Confirm LED on outdoor P.C. board to judge which error it is. PMV error for A room, B room, C room.</p> <p><b>[PMV error for A room]</b></p>
	<p>○*●●○*○*○</p>	<p><b>[PMV error for B room]</b></p>
	<p>●○*●○*○*○</p>	<p><b>[PMV error for C room]</b></p>

Check code	Outdoor LED display	Check and troubleshooting (Item without special mention indicates part of outdoor unit.)
[21]	<p>* There is a possibility that it is one of the following errors. Confirm LED on outdoor P.C. board to judge which error it is. (1) high-pressure SW system error, (2) power supply error (Vdc), (3) high-pressure protective operation, (4) case thermo operation.</p> <p>● ○ * ● ● ● ○</p>	<p><b>[High pressure SW system error]</b> High pressure protective operation.</p> <pre> graph TD     Q1{{Doesn't high pressure switch operate?}} -- NO --&gt; Q2{{Is circuit wiring normal?}}     Q1 -- YES --&gt; Q3{{Are parts of high pressure switch normal?}}     Q2 -- NO --&gt; A1[Wiring check, Correct.]     Q3 -- NO --&gt; A2[Parts check Defective -&gt; Replace]     Q3 -- YES --&gt; Q4{{Is service valve fully opened?}}     Q4 -- NO --&gt; A3[Open service valve fully.]     Q4 -- YES --&gt; A4[Reset the power supply and then do a trial operation according to the season.]          A4 --&gt; B[Cooling operation.]     A4 --&gt; C[Heating operation.]          B --&gt; Q5{{Does cooling outdoor fan normally operate?}}     Q5 -- NO --&gt; Q6{{Is there no fan breakage or coming-off?}}     Q5 -- YES --&gt; Q7{{Is there any element which blocks heat exchanger of the outdoor unit?}}     Q6 -- YES --&gt; A5[Repair defective position. Connection of connectors, IPDU, Fan motor, Wiring.]     Q6 -- NO --&gt; A6[Overcharge of refrigerant/ Clogging/Pipe breakage/ Abnormal overload]     Q7 -- YES --&gt; A7[Elimination of blocking element]     Q7 -- NO --&gt; A6          C --&gt; Q8{{Does the heating indoor fan normally operate?}}     Q8 -- NO --&gt; Q9{{Are connections of connectors, capacitors and fan motor normal?}}     Q8 -- YES --&gt; Q10{{Is there any element which blocks indoor heat exchanger?}}     Q9 -- YES --&gt; Q10     Q9 -- NO --&gt; A8[Repair defective position.]     Q10 -- YES --&gt; A7     Q10 -- NO --&gt; A6          A6 --&gt; Q11{{Are characteristics of TC and TCJ sensor resistance value normal?}}     Q11 -- YES --&gt; A9[Check indoor P.C. board Defective -&gt; Replace]     Q11 -- NO --&gt; A10[Replace TC or TCJ sensor.]     </pre>

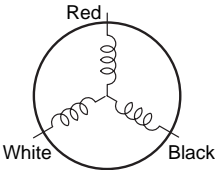
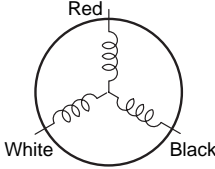
11-7. Inspection of the Main Parts

[1] Sensor characteristic table



TD : Discharge temp. sensor  
 TO : Outdoor temp. sensor  
 TE : Outdoor heat exchanger temp. sensor  
 TS : Suction temp. sensor  
 TGa to TGc : Gas side temp. sensor

Outdoor Unit

No.	Part name	Checking procedure																													
1	Compressor (Model : DX220A2T-20L)	Measure the resistance value of each winding by using the tester. <div style="display: flex; align-items: center; justify-content: center;">  <table border="1" style="margin-left: 20px;"> <thead> <tr> <th>Position</th> <th>Resistance value</th> </tr> </thead> <tbody> <tr> <td>Red - White</td> <td rowspan="3" style="text-align: center; vertical-align: middle;"><math>0.58 \pm 0.03\Omega</math></td> </tr> <tr> <td>White - Black</td> </tr> <tr> <td>Black - Red</td> </tr> </tbody> </table> <p style="text-align: right; margin-right: 20px;">at 20°C</p> </div>	Position	Resistance value	Red - White	$0.58 \pm 0.03\Omega$	White - Black	Black - Red																							
Position	Resistance value																														
Red - White	$0.58 \pm 0.03\Omega$																														
White - Black																															
Black - Red																															
2	Outdoor fan motor (Model : ICF-280-A60-1)	Measure the resistance value of winding by using the tester. <div style="display: flex; align-items: center; justify-content: center;">  <table border="1" style="margin-left: 20px;"> <thead> <tr> <th>Position</th> <th>Resistance value</th> </tr> </thead> <tbody> <tr> <td>Red - White</td> <td rowspan="3" style="text-align: center; vertical-align: middle;"><math>32.6 \pm 3.3\Omega</math></td> </tr> <tr> <td>White - Black</td> </tr> <tr> <td>Black - Red</td> </tr> </tbody> </table> <p style="text-align: right; margin-right: 20px;">For details, refer to Section 11-10.</p> </div>	Position	Resistance value	Red - White	$32.6 \pm 3.3\Omega$	White - Black	Black - Red																							
Position	Resistance value																														
Red - White	$32.6 \pm 3.3\Omega$																														
White - Black																															
Black - Red																															
3	Compressor thermo. Bimetal type (Model : CS-12AL)	Check conduction by using the tester.																													
4	High pressure switch (Model : ACB-4UB83W)	Check conduction by using the tester.																													
5	Outdoor temperature sensor (TO), pipe temperature sensor (TGa, TGb, TGc), discharge temperature sensor (TD), suction temperature sensor (TS), evaporator temperature sensor (TE)	Disconnect the connector, and measure resistance value with the tester. (Normal temperature) <table border="1" style="margin-left: 20px; width: 100%;"> <thead> <tr> <th rowspan="2">Sensor</th> <th colspan="5">Temperature</th> </tr> <tr> <th>10°C</th> <th>20°C</th> <th>25°C</th> <th>40°C</th> <th>50°C</th> </tr> </thead> <tbody> <tr> <td>TD (kΩ)</td> <td>105</td> <td>64</td> <td>51</td> <td>27</td> <td>18</td> </tr> <tr> <td>TO, TE, TS (kΩ)</td> <td>20.6</td> <td>12.6</td> <td>10.0</td> <td>5.1</td> <td>3.4</td> </tr> <tr> <td>TGa to TGc (kΩ)</td> <td>20.0</td> <td>12.5</td> <td>10.0</td> <td>5.3</td> <td>3.6</td> </tr> </tbody> </table>	Sensor	Temperature					10°C	20°C	25°C	40°C	50°C	TD (kΩ)	105	64	51	27	18	TO, TE, TS (kΩ)	20.6	12.6	10.0	5.1	3.4	TGa to TGc (kΩ)	20.0	12.5	10.0	5.3	3.6
Sensor	Temperature																														
	10°C	20°C	25°C	40°C	50°C																										
TD (kΩ)	105	64	51	27	18																										
TO, TE, TS (kΩ)	20.6	12.6	10.0	5.1	3.4																										
TGa to TGc (kΩ)	20.0	12.5	10.0	5.3	3.6																										

## 11-8. How to Simply Judge Whether Outdoor Fan Motor is Good or Bad

### 1. Symptom

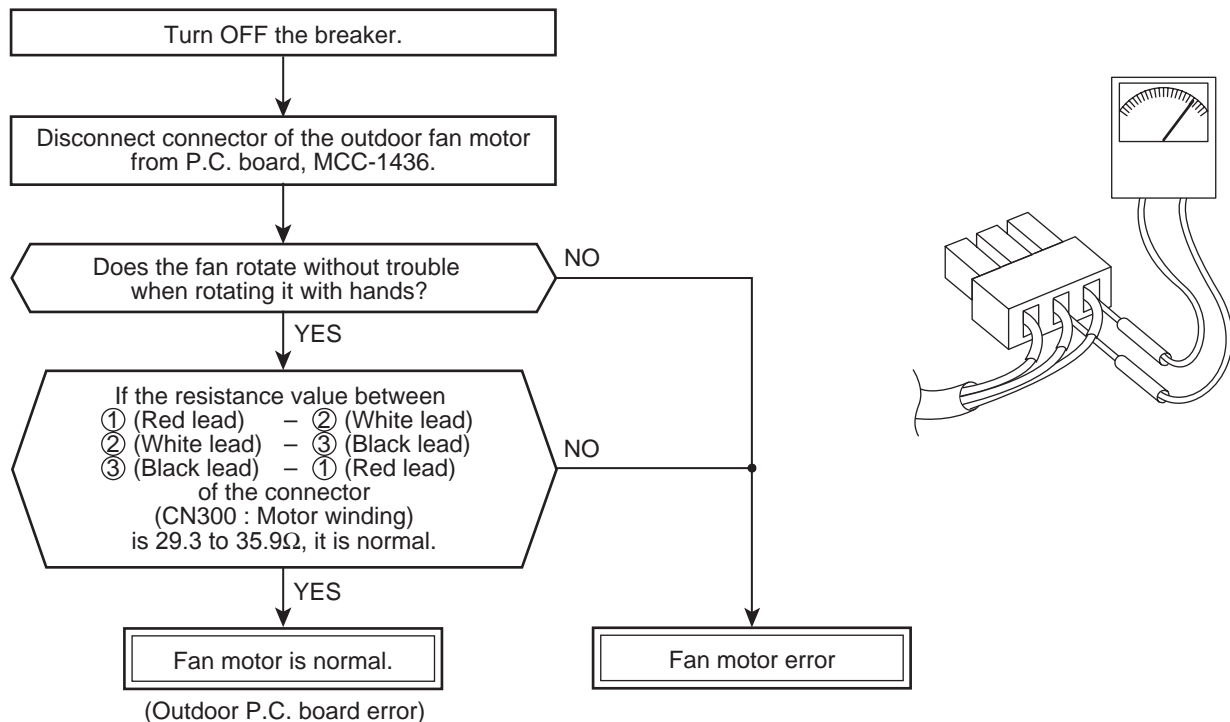
- Outdoor fan motor does not rotate.
  - Outdoor fan motor stops within several tens seconds though it started rotating.
  - Outdoor fan motor rotates or does not rotate according to the position where the fan stopped, etc.
- Remote controller check code “02 : Outdoor block, 1A : Outdoor fan drive system error”

### 2. Cause

The following causes are considered when the outdoor fan motor does not normally rotate.

- 1) Mechanical lock of the outdoor fan motor
- 2) Winding error of the outdoor fan motor
- 3) Position-detect circuit error inside of the outdoor fan motor
- 4) Motor drive circuit error of the outdoor P.C. board

### 3. How to simply judge whether outdoor fan motor is good or bad

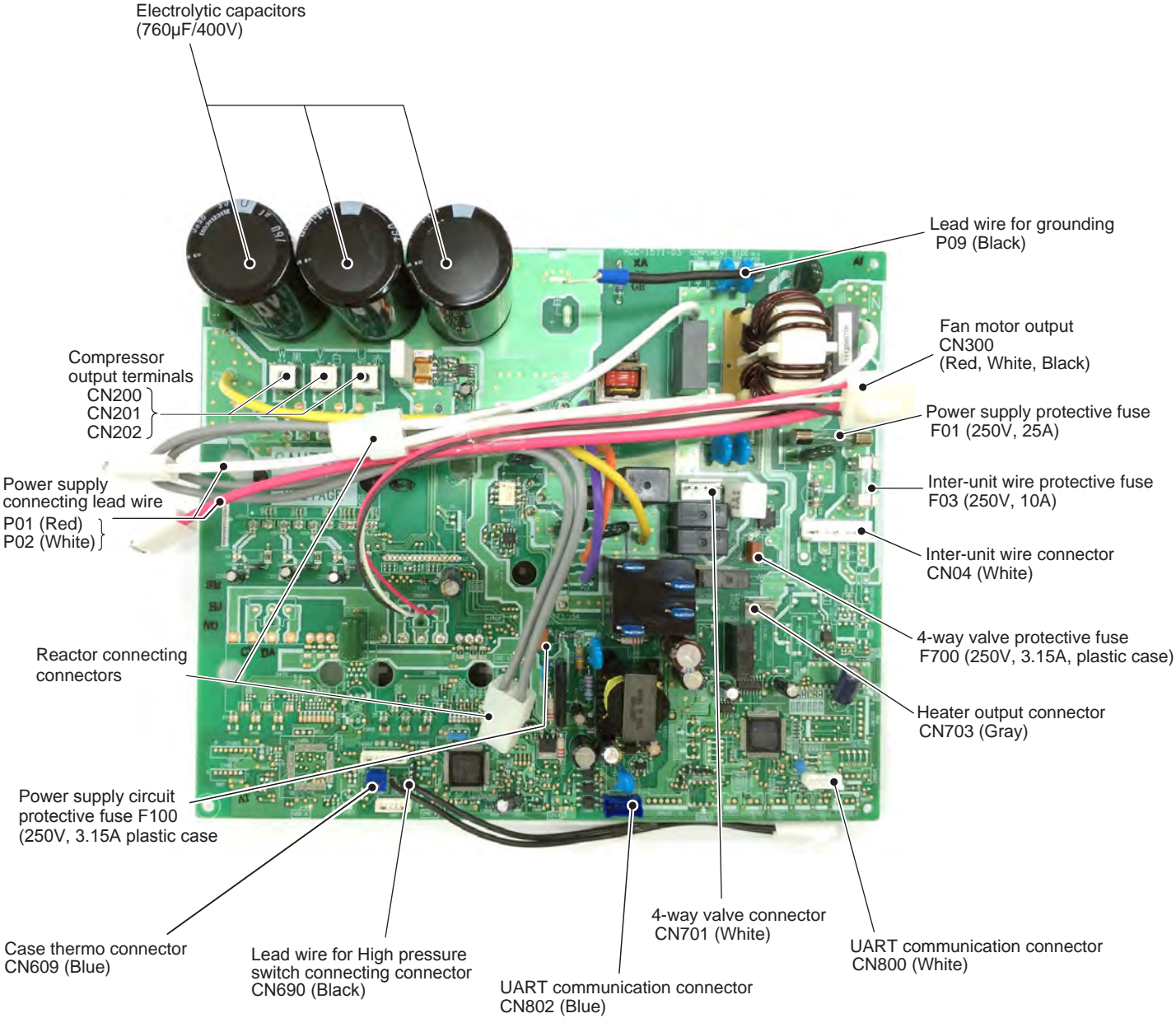


### NOTE

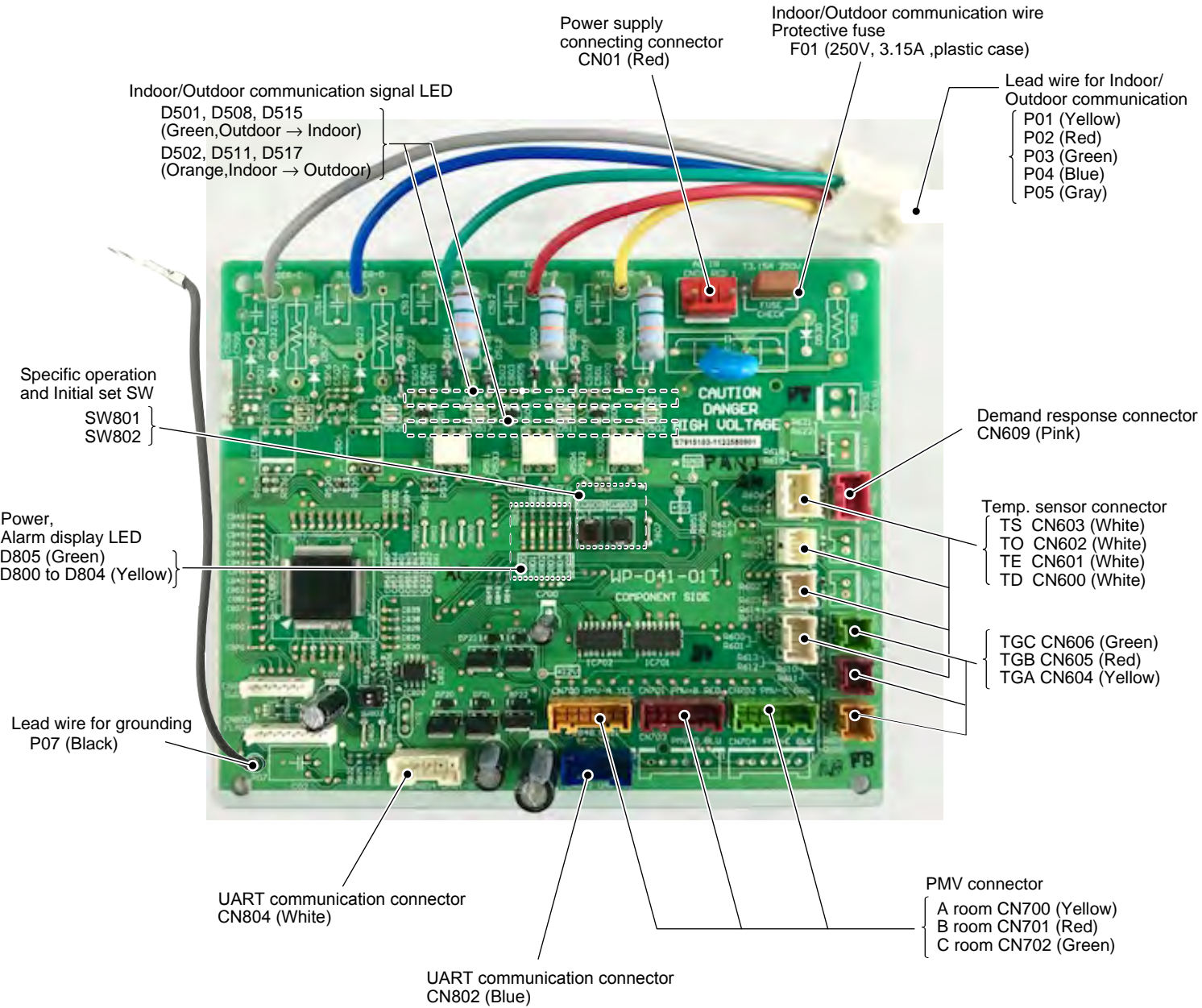
However, GND circuit error inside of the motor may be accepted in some cases when the above check is performed.

When the fan motor does not become normal even if P.C. board is replaced, replace the outdoor fan motor.

<MCC-1571>

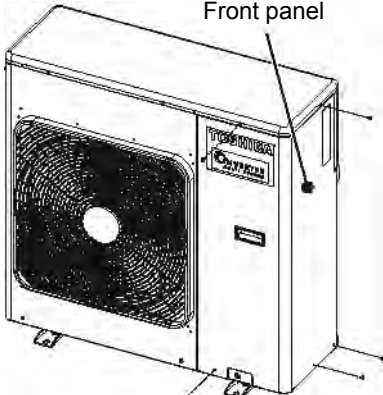
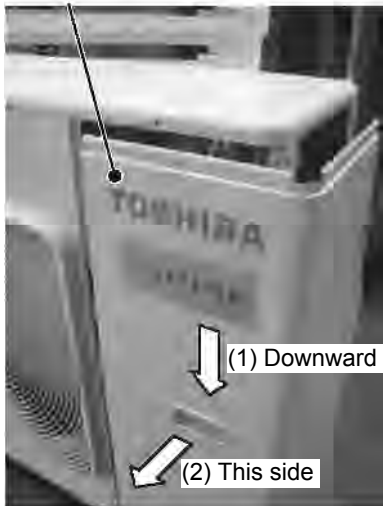
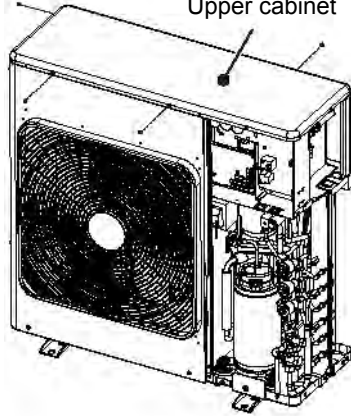


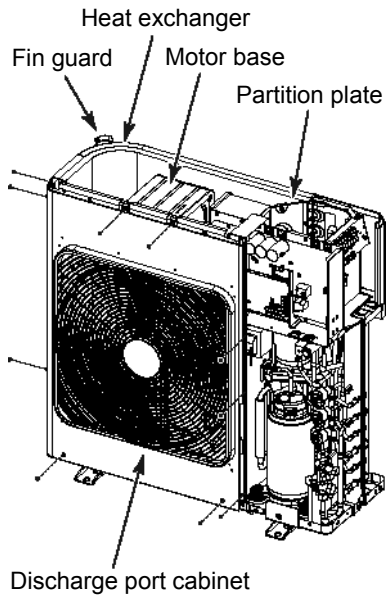
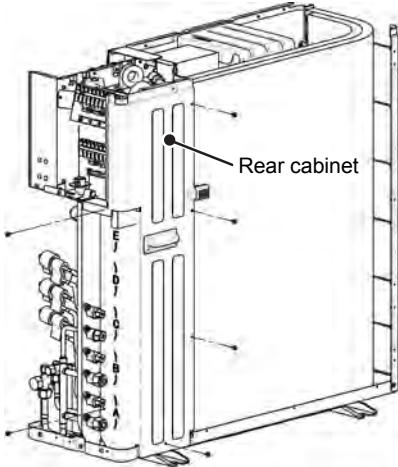
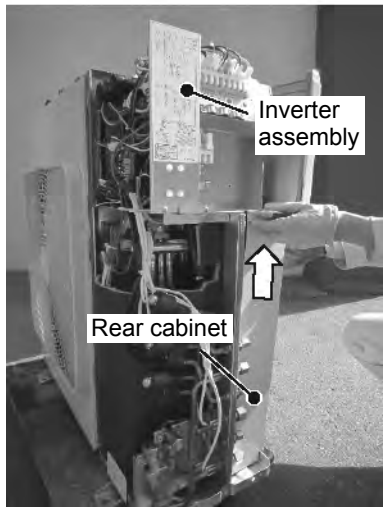
<WP-041>



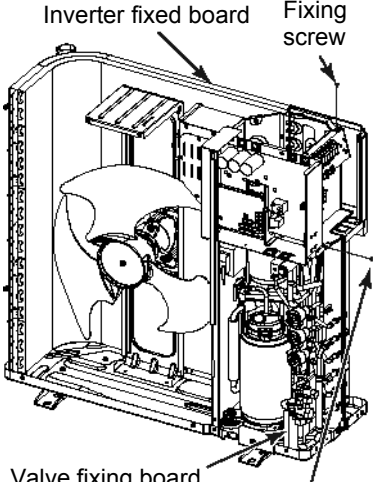
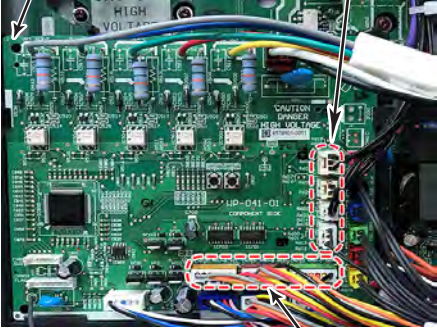
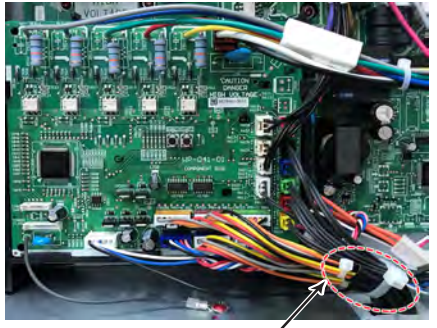
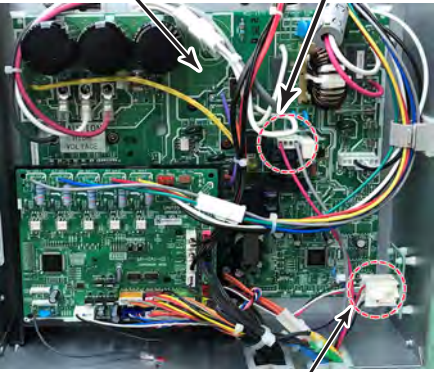
## 12. HOW TO REPLACE THE MAIN PARTS

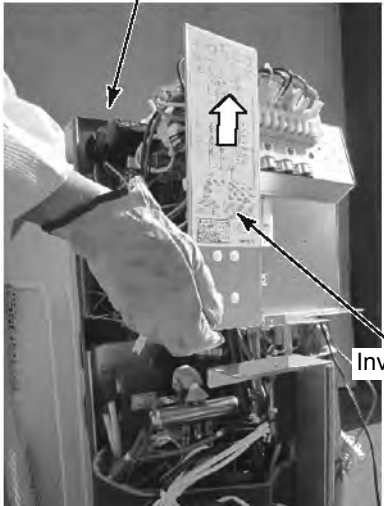
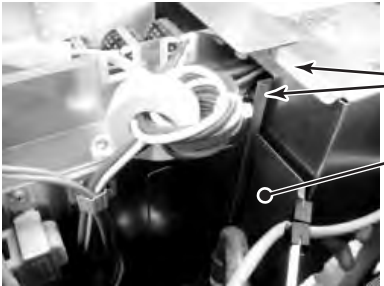

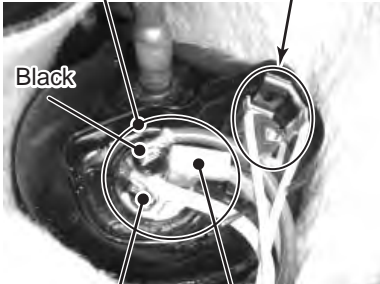
### 12-1. Outdoor Unit

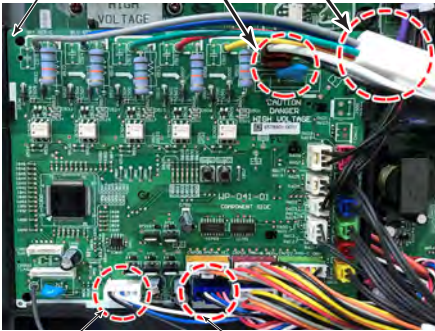
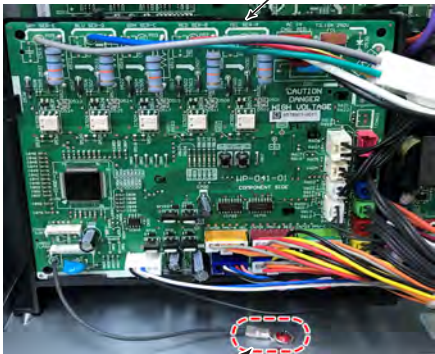
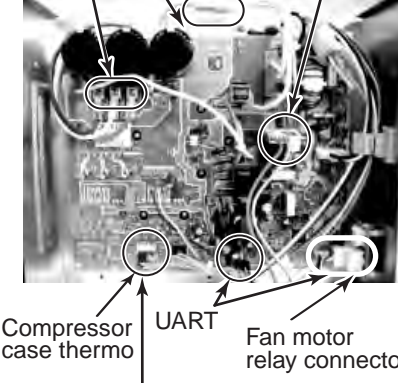
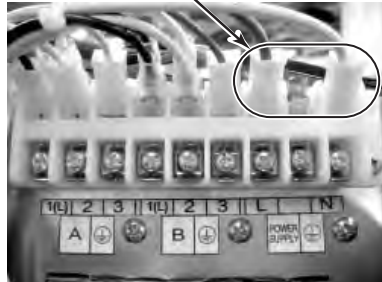
No.	Part name	Procedure	Remarks
①	Common procedure	<p style="text-align: center;"><b>CAUTION</b></p> <hr/> <p>Never forget to put on the gloves at working time; otherwise an injury will be caused by the parts etc.</p> <hr/> <p><b>1. Detachment</b></p> <ol style="list-style-type: none"> <li>1) Stop operation of the air conditioner, and turn off the switch of the breaker.</li> <li>2) Remove the front panel. (Hexagonal screw <math>\varnothing 4 \times 10</math>, 5 pcs.) <ul style="list-style-type: none"> <li>• After taking off screws, draw the front panel ② to this side and remove it while pulling the front panel downward ①.</li> </ul> </li> <li>3) Remove the power supply cable and the indoor/outdoor connecting wire from the cord clamp and the terminal.</li> <li>4) Remove the upper cabinet. (Hexagonal screw <math>\varnothing 4 \times 10</math>, 4 pcs.)</li> </ol> <p><b>2. Attachment</b></p> <ol style="list-style-type: none"> <li>1) Connect the power supply cable and the indoor/outdoor connecting wire to the terminal and then fix them with the cord clamp.</li> <li>2) Mount the front panel. (Hexagonal screw <math>\varnothing 4 \times 10</math>, 5 pcs.)</li> </ol>	<p style="text-align: center;">Front panel</p>  <p style="text-align: center;">Front panel</p>  <p style="text-align: center;">Upper cabinet</p> 

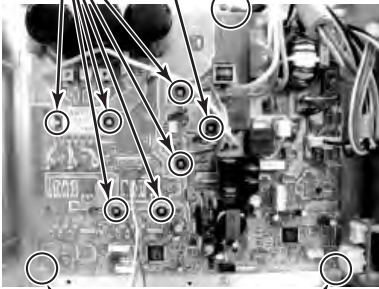
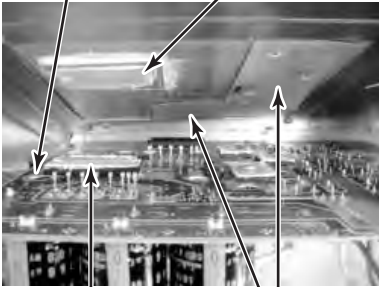
No.	Part name	Procedure	Remarks
②	Discharge port cabinet	<p><b>1. Detachment</b></p> <ol style="list-style-type: none"> <li>1) Perform work of Detachment 1 of ① .</li> <li>2) Take off screws for the discharge port cabinet and the partition plate. (ST1T Ø4 × 8, 3 pcs.)</li> <li>3) Take off screws for the discharge port cabinet and the bottom plate. (Hexagonal screw Ø4 × 10, 2 pcs.)</li> <li>4) Take off screws for the discharge port cabinet and the motor base. (ST1T Ø4 × 8, 2 pcs.)</li> <li>5) Take off screw for the discharge port cabinet and the heat exchanger. (ST1T Ø4 × 8, 1 pc.)</li> <li>6) Take off screws for the discharge port cabinet and the fin guard. (Hexagonal screw Ø4 × 10, 2 pcs.)</li> </ol>	
③	Rear cabinet	<p><b>1. Detachment</b></p> <ol style="list-style-type: none"> <li>1) Perform work of Detachment 1 of ① .</li> <li>2) Take off screw for the rear cabinet and the valve fixed board. (Hexagonal screw Ø4 × 10, 2 pcs.)</li> <li>3) Take off screw for the rear cabinet and the anchor board. (Hexagonal screw Ø4 × 10, 1 pc.)</li> <li>4) Take off screws for the rear cabinet and the heat exchanger. (Hexagonal screw Ø4 × 10, 3 pcs.)</li> <li>5) Remove the rear cabinet by shifting it obliquely backward and upward.</li> </ol>	 

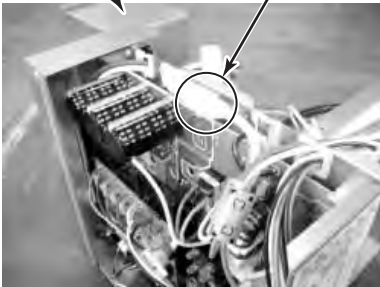
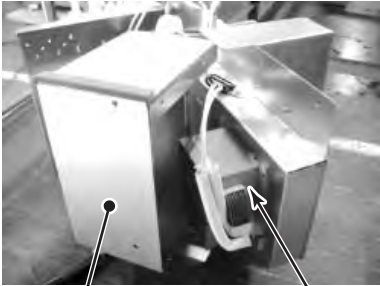
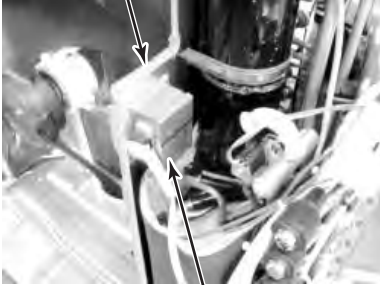



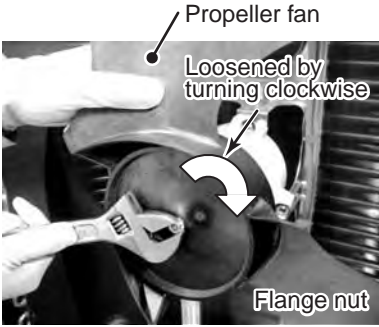
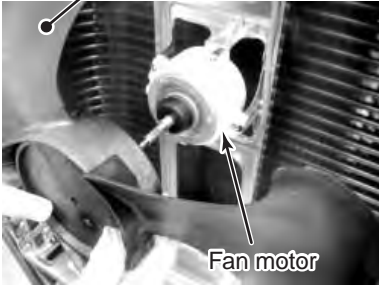
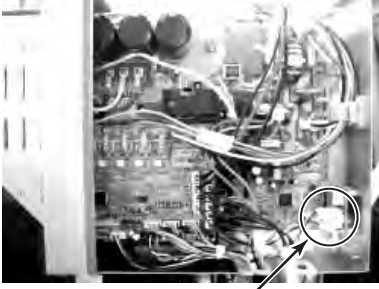
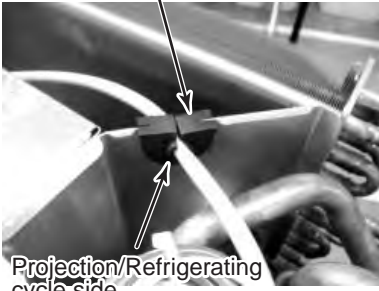
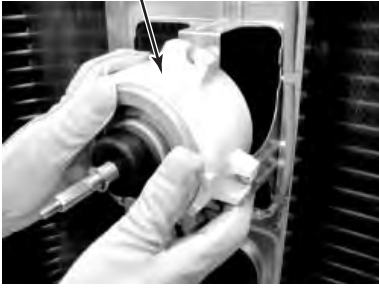
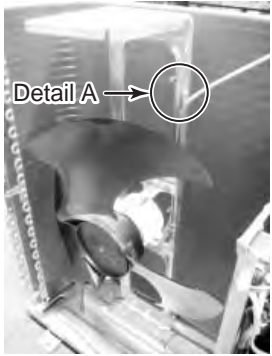
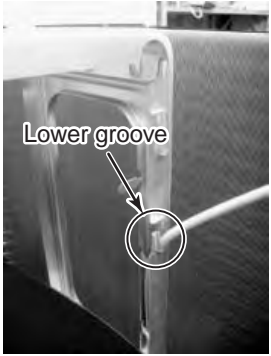
No.	Part name	Procedure	Remarks
④	Inverter assembly	<p>1) Perform works Detachment 1 of ① and ③ .</p> <hr/> <p style="text-align: center;"><b>⚠ WARNING</b></p> <hr/> <p>Never disassemble the inverter until 5 minutes after the power supply was turned off because there is a fear that an electric shock may occur.</p> <hr/> <p><b>NOTE)</b></p> <hr/> <p>When working, be sure to use the insulate tools and put on the insulated gloves.</p> <hr/> <p>2) Take off screw for the inverter assembly and the valve fixed board. (ST1T Ø4 × 8, 1 pc.)</p> <p>3) Take off the screw fixed to the terminal fixed board in order to remove the inverter fixed board. (ST1T Ø4 × 8, 1 pc.)</p> <p>4) Remove the connectors that are connected from CDB P.C. board to the other parts.            CN600: TD sensor (3P, White)            CN601: TE sensor (2P, White)            CN602: TO sensor (2P, White)            CN603: TS sensor (3P, White)            CN604: TGa sensor (2P, Yellow)            CN605: TGb sensor (2P, Red)            CN606: TGc sensor (2P, Green)            CN609: Demand response connector (3P, Pink)            CN700: PMV coil (6P, Yellow)            CN701: PMV coil (6P, Red)            CN702: PMV coil (6P, Green)</p> <p>5) Cut the bundling band that binds the PMV coil and the relay lead wire.</p> <p>6) Remove the connectors, relay connector and the lead wire that are connected from IPDU P.C. board to the other parts.            CN701 : 4-way valve coil (2P, White)            Relay connector for reactor to mount the partition plate (2P: White)            CN609 : Compressor case thermo. (2P: White)            CN690 : Relay connector for High pressure switch (2P: White)</p> <p>7) Remove connectors that are connected from the fan motor to the fan motor relay P.C. board.</p> <ul style="list-style-type: none"> <li>• Unlock the lock of the housing unit and then remove the connectors.</li> </ul>	<p>Inverter fixed board    Fixing screw</p>  <p>Valve fixing board    Fixing screw</p> <p>CDB P.C. board    Temperature sensor</p>  <p>PMV coil</p>  <p>Bundling band</p> <p>IPDU P.C. board    4-way coil</p>  <p>Fan motor relay connector</p>

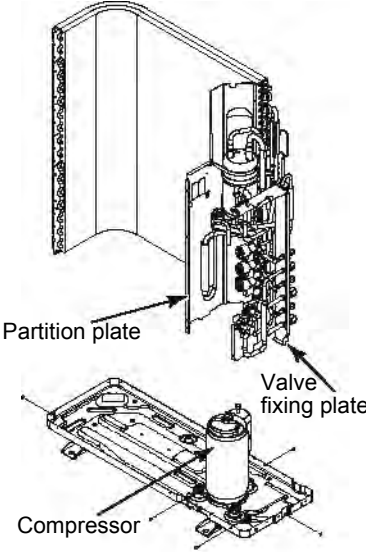
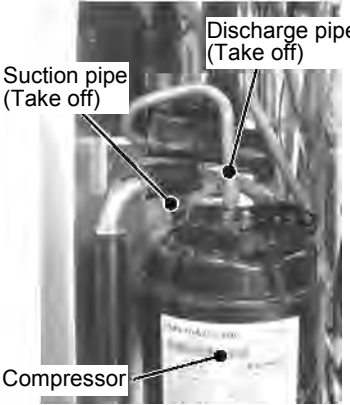

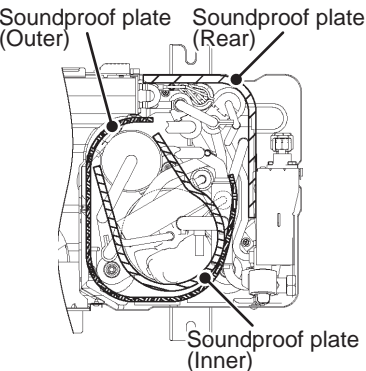
No.	Part name	Procedure	Remarks
④	Inverter assembly (Continued)	<p>8) Remove the soundproof plate (upper).</p> <p>9) Remove the terminal cover of the compressor and then remove the compressor lead of the compressor.</p> <p>10) Pull up the inverter assembly and then remove it.</p> <p style="text-align: center;">Reactor cover side</p>  <p style="text-align: right;">Inverter box side</p> <p>* Hold up both the reactor cover side and the inverter box side and then remove the inverter assembly upward.</p> <p>* Caution to mount the inverter assembly When mounting the inverter assembly to the partition plate, be sure to do hooking.</p>  <p style="text-align: right;">Hook Partition cover</p> <p><b>NOTE)</b></p> <hr/> <p>Using the bundling band on the market, be sure to bind the portions which were bound before.</p> <hr/>	<p>Soundproof plate (upper)</p>  <p>Compressor lead    Case thermo</p>  <p>Black    White    Red</p>

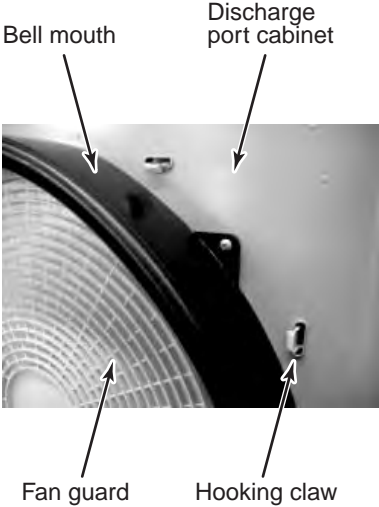
No.	Part name	Procedure	Remarks
⑤	CDB P.C. board	<p>1) Perform works of Detachment 1 of ① and 4) of ④ .</p> <p style="text-align: center;"><b>⚠ CAUTION</b></p> <hr/> <p>Never disassemble the inverter until 5 minutes after the power supply was turned off because there is a fear that an electric shock may occur.</p> <hr/> <p>2) Remove the connector and the relay connector that are connected from CDB P.C. board to IPDU P.C. board, power supply and the inter-unit wire.</p> <p>CN802: UART (5P, Blue)            CN804: UART (5P, White)            CN01: Power supply (3P, Red)            Terminal relay connector (6P, White)</p> <p>* Unlock the lock of the housing unit and then remove the connectors.</p> <p>3) Remove the earth wire of CDB P.C. board (Truss head B tight Ø4 × 6, 1 pc.)</p> <p>4) Remove CDB P.C. board from CDB fixed board.</p> <p>5) Mount a new CDB P.C. board.</p> <p>* When connecting the connectors on CDB P.C. board to support CDB fixed board with hand.</p>	<p>Power supply connector      Terminal relay connector</p> <p>CDB P.C. board</p>  <p>UART (CN804)      UART (CN802)</p> <p>CDB fixed board</p>  <p>Earth screw</p>
⑥	IPDU P.C. board	<p>1) Perform works of Detachment 1 of ① , 3) of ② , ④ and 2), 3) of ⑤ .</p> <p style="text-align: center;"><b>⚠ CAUTION</b></p> <hr/> <p>Never disassemble the inverter until 5 minutes after the power supply was turned off because there is a fear that an electric shock may occur.</p> <hr/> <p>2) Take off screw for CDB fixed board and the inverter box. (ST1T Ø4 × 8, 1 pc.)</p> <p>3) Remove CDB P.C. board assembly.</p> <p>4) Remove the connectors connected to IPDU P.C. board. (4-way valve coil, compressor case thermo, UART × 2, Inter-unit wire)</p> <p>5) Remove the relay connector for fan motor, reactor, and High pressure switch.</p> <p>6) Remove the lead wire connected to IPDU P.C. board.</p> <p>(Tightening torque: 1.47 ± 0.1 N•m)</p> <p>Compressor lead      U : CN200, Red                                             V : CN201, White                                             W : CN202, Black</p> <p>Remove the power supply cable from the power supply terminal block.</p> <p>Power supply lead L: Red            Power supply lead N: White</p>	<p>Reactor relay connector</p> <p>Compressor lead      IPDU P.C. board      4-way valve coil</p>  <p>Compressor case thermo      UART      Fan motor relay connector</p> <p>High pressure switch relay connector</p> <p>Power supply terminal block</p> 

No.	Part name	Procedure	Remarks
⑥	IPDU P.C. board (Continued)	<p>7) Remove the earth wire of IPDU P.C. board. (Truss head B tight screw Ø4 × 6, 1 pc.).</p> <p>8) Take off fixing screws for IPDU P.C. board. (Flange nut to fix element Ø3 × 16, 7 pcs.: Pan head S tight screw to fix P.C. board Ø3 × 20, 1 pc.)</p> <p>9) Remove IPDU P.C. board. (3 supporters)</p> <p><b>NOTE)</b></p> <hr/> <p>Be careful that IPDU P.C. board is difficult to be taken out by radiating grease for the heat sink.</p> <hr/> <p>10) Mount a new IPDU P.C. board.</p> <p><b>NOTE)</b></p> <hr/> <ul style="list-style-type: none"> <li>• Take note that the compressor lead V: CN201 (white) and the reactor lead CN05, CN06 are correctly attached. (For the compressor lead, the transparent sleeve is attached to the circular terminal, and for the reactor lead, the transparent sleeve is not attached to the circular terminal.)</li> <li>• Be sure not to forget to attach the Sub heat sink and also the radiating sheet. (If you apply a little amount of radiating grease beforehand to the rear side of the insulation sheet, the attaching work to the heat sink will become easy.)</li> </ul> <hr/>	<p>Fixing screws for element (7 positions)</p> <p>Earth screw</p>  <p>IPDU P.C. board fixing screw</p> <p>Supporters (3 positions)</p> <p>IPDU P.C. board</p> <p>Radiating grease</p>  <p>Sub heat sink</p> <p>Radiating sheet</p>

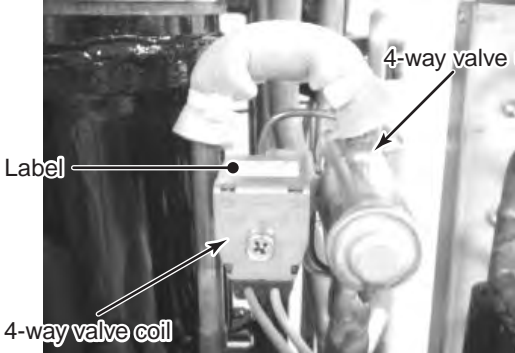
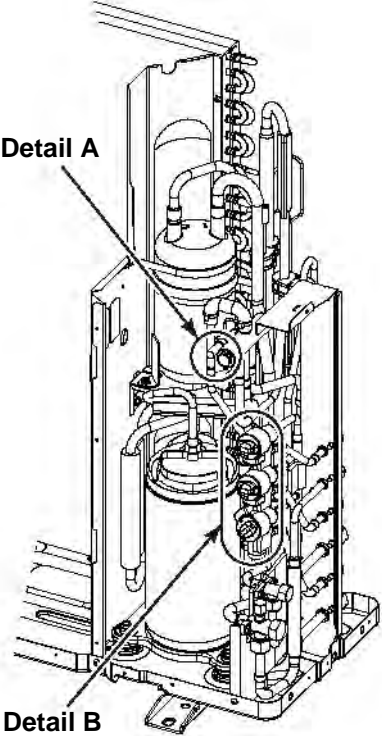
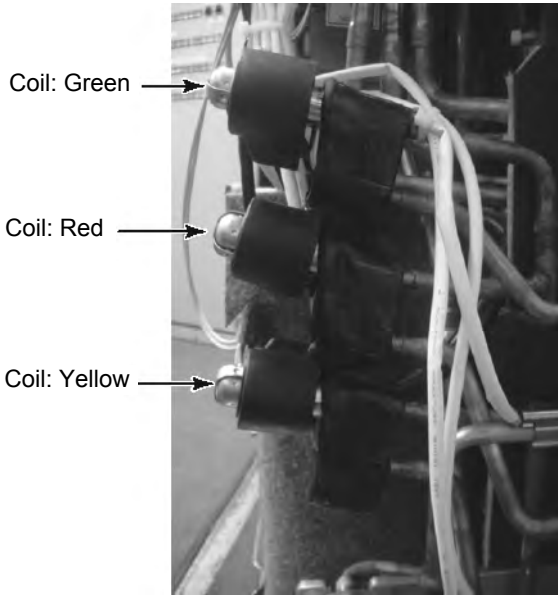
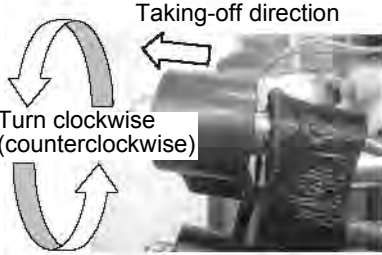


No.	Part name	Procedure	Remarks
⑦	Replacement of reactor	<p><b>1. Reactor to be attached to the inverter assembly</b></p> <ol style="list-style-type: none"> <li>1) Perform works of Detachment 1 of ① and ④ .</li> <li>2) Remove the relay connector of the reactor.</li> <li>3) Remove the reactor cover. (Truss head B tight screw Ø4 × 6, 4 pcs.)</li> <li>4) Remove the reactor. (ST1T Ø4 × 6, 2 pcs.)</li> <li>5) Mount a new reactor.</li> </ol> <p><b>2. Reactor to be attached to the partition plate</b></p> <ol style="list-style-type: none"> <li>1) Perform works of Detachment 1 of ① and ④ .</li> <li>2) Remove the reactor from the partition plate. (ST1T Ø4 × 8, 2 pcs.)</li> <li>3) Mount a new reactor.</li> </ol> <p>* Caution to mount the inverter assembly. When mounting the inverter assembly to the partition plate, be sure to attach the hooks certainly.</p>	<div style="display: flex; flex-direction: column; align-items: center;"> <div style="display: flex; justify-content: space-around; width: 100%;"> <span>Reactor cover</span> <span>Reactor relay connector</span> </div>     <div style="display: flex; justify-content: space-around; width: 100%;"> <span>Reactor cover</span> <span>Reactor</span> </div>   <div style="display: flex; justify-content: center; width: 100%;"> <span>Partition plate</span> </div>  <div style="display: flex; justify-content: center; width: 100%;"> <span>Reactor</span> </div>   <div style="display: flex; justify-content: center; width: 100%;"> <span>Hooks</span> </div>  <div style="display: flex; justify-content: center; width: 100%;"> <span>Partition plate</span> </div> </div>

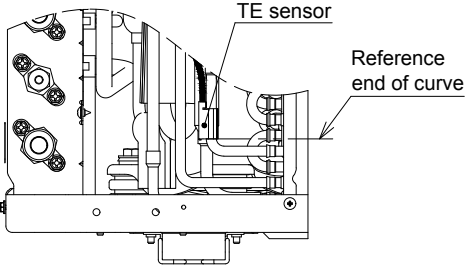
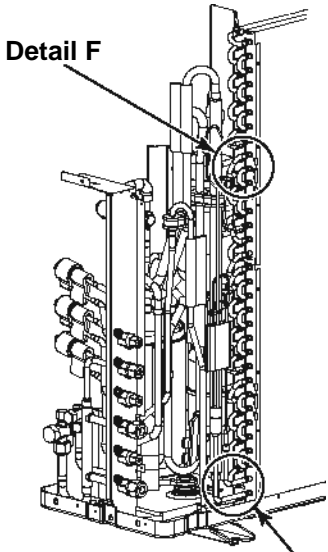

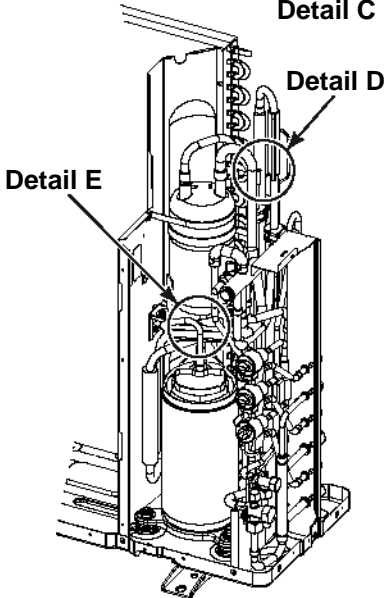

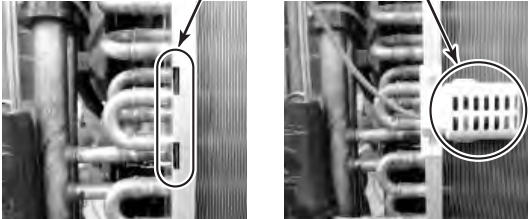
No.	Part name	Procedure	Remarks
⑧	Fan motor	<p>1) Perform works of Detachment 1 of ① and ② .</p> <p>2) Take off flange nut which fixes the fan motor and the propeller fan.                      * The flange nut is loosened by turning it clockwise.                      (To tighten the flange nut, turn it counterclockwise.)</p> <p>3) Remove the propeller fan.</p> <p>4) Remove the relay connector for fan motor from the inverter.</p> <p>5) Remove the fan motor lead from the fan motor lead fixing rubber of the penetrating part of the partition plate.</p> <p>6) Take off the fixing screws (4 pcs. each) while supporting the fan motor so that it does not fall.                      * Caution to assembly of fan motor</p> <ul style="list-style-type: none"> <li>• Tighten the flange nut with 4.95N•m (50kgf•cm).</li> <li>• Adjust length of the fan motor lead fixing rubber so that the slackened fan motor lead does not come to contact with the propeller fan.</li> </ul> <p>Put in the fan motor lead fixing rubber to the partition plate so that the projection comes to the refrigerating cycle side.</p> <ul style="list-style-type: none"> <li>• <b>There provided at 2 positions the grooves to pass the fan motor lead wire into the motor base. Use the lower groove.</b></li> </ul>	    
		<p>Motor base</p>  <p>Detail A</p>  <p>Lower groove</p>	
		<p><b>CAUTION</b></p> <hr/> <p>Using the metal band of the motor base, be sure to fix the fan motor lead to the motor base so that the fan motor lead does not come to contact with the propeller fan.</p> <hr/>	

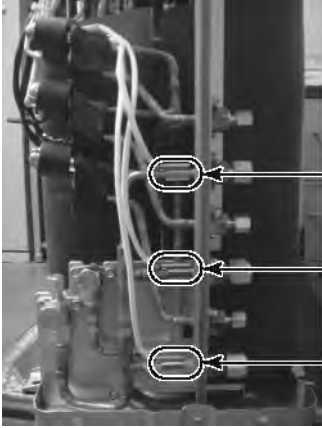
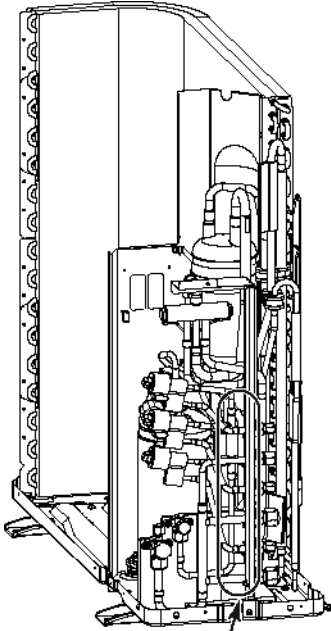
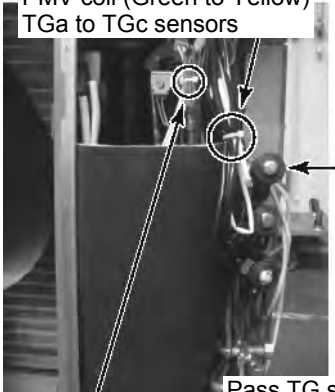
No.	Part name	Procedure	Remarks
⑨	Compressor assembly	<p><b>1. Removal of defective compressor</b></p> <ol style="list-style-type: none"> <li>1) Perform work of Detachment 1 of ① .</li> <li>2) Recover the refrigerant gas from the outdoor unit.</li> <li>3) Perform works of ② , ③ and ④ .</li> <li>4) Remove the soundproof plate and TD sensor.</li> <li>5) Take off fixing screw for the anchor board and the partition plate. (ST1T Ø4 × 8, 1 pc.)</li> <li>6) Take off fixing screws for the anchor board and the heat exchanger. (ST1T Ø4 × 8, 2 pcs.)</li> <li>7) Take off fixing screws for the anchor board and the valve fixing plate. (ST1T Ø4 × 8, 2 pcs.)</li> <li>8) Using a burner, remove the welded parts (discharge pipe, suction pipe) connected to the compressor.</li> </ol> <p><b>NOTE)</b></p> <hr/> <p>Take care that the electric parts, sensors, compressor, and etc. are not caught by flame. (Otherwise operation trouble may occur.)</p> <hr/> <p>9) Pull out the refrigerating cycle upward.</p> <p><b>NOTE)</b></p> <hr/> <p>Pull out the refrigerating cycle by two or more persons.</p> <hr/> <p>10) Take off the compressor bolts (3 pcs.) which fix the compressor to the compressor fixing plate.</p> <p>11) Remove the compressor from the compressor fixing plate.</p> <p><b>NOTE)</b></p> <hr/> <p>A compressor weighs approx. 15kg. Treat a compressor by two or more personals.</p> <hr/> <p>* Caution to assemble compressor</p> <ul style="list-style-type: none"> <li>• Tighten the compressor bolt with 5N•m (50kgf•cm).</li> <li>• Be sure not to burn lead wire of the coil.</li> <li>• Take care there is no missing of sensor.</li> </ul>	  <p>* Mount the soundproof plate by passing between the compressor and pipes and between pipes and the partition plate in order of upper, inner, outer and rear sides.</p>  

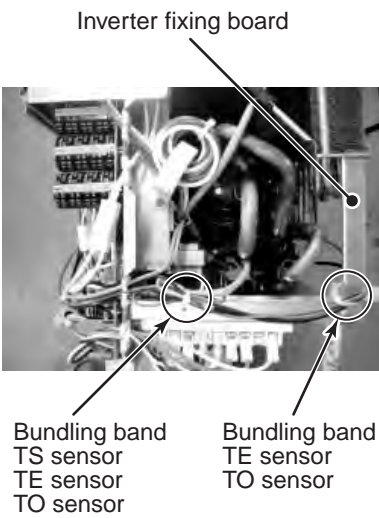
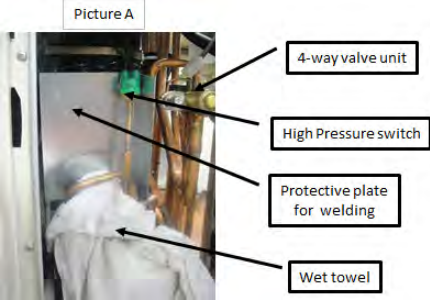
No.	Part name	Procedure	Remarks
⑩	Fan guard	<p><b>1. Detachment</b></p> <p>1) Perform works of Detachment 1 of ① and ② .</p> <p style="text-align: center;"><b>CAUTION</b></p> <hr/> <p>Work on the cardboard, cloth, and etc. in order to prevent damage on the product.</p> <hr/> <p>2) Take off the discharge port cabinet and put it as the fan guard side directs downward.</p> <p>3) Take off the hooking claws (8 positions) of the fan guard.</p> <p><b>2. Attachment</b></p> <p>1) Push the hooking claws (8 positions) with hands from the front side and then fix the claws.</p> <p style="text-align: center;"><b>CAUTION</b></p> <hr/> <p>Check all the hooking claws are fixed at each specified position.</p> <hr/>	



No.	Part name	Procedure	Remarks
⑪	4-way valve coil	<p>* <b>Attachment</b></p> <p>Mount 4-way valve coil so that the label side directs upper side of the cabinet.</p> <p><b>Detail A</b></p> 	
⑫	PMV Coil: Green Coil: Red Coil: Yellow	<p><b>1. Detachment</b></p> <ol style="list-style-type: none"> <li>1) Perform work of Detachment 1 of ⑪ .</li> <li>2) Turn the coil clockwise (counterclockwise) and then remove it from PMV main unit. (All 4 pcs.)</li> </ol> <p><b>2. Attachment</b></p> <ol style="list-style-type: none"> <li>1) Mount the PMV coil so that the coil lead wire taking-out part directs downward.</li> </ol> <p style="text-align: center;"><b>CAUTION</b></p> <hr/> <p>Coil: Mount yellow coil only so that lead wire taking-out part directs upward.</p> <hr/> <ol style="list-style-type: none"> <li>2) Match the positioning projection of coil with the concave part of PMV unit surely and fix it.</li> </ol> <p><b>Detail B</b></p> 	 <p>PMV sideways</p> <p>Projection of PMV coil</p>  <p>Concave part of PMV</p> 

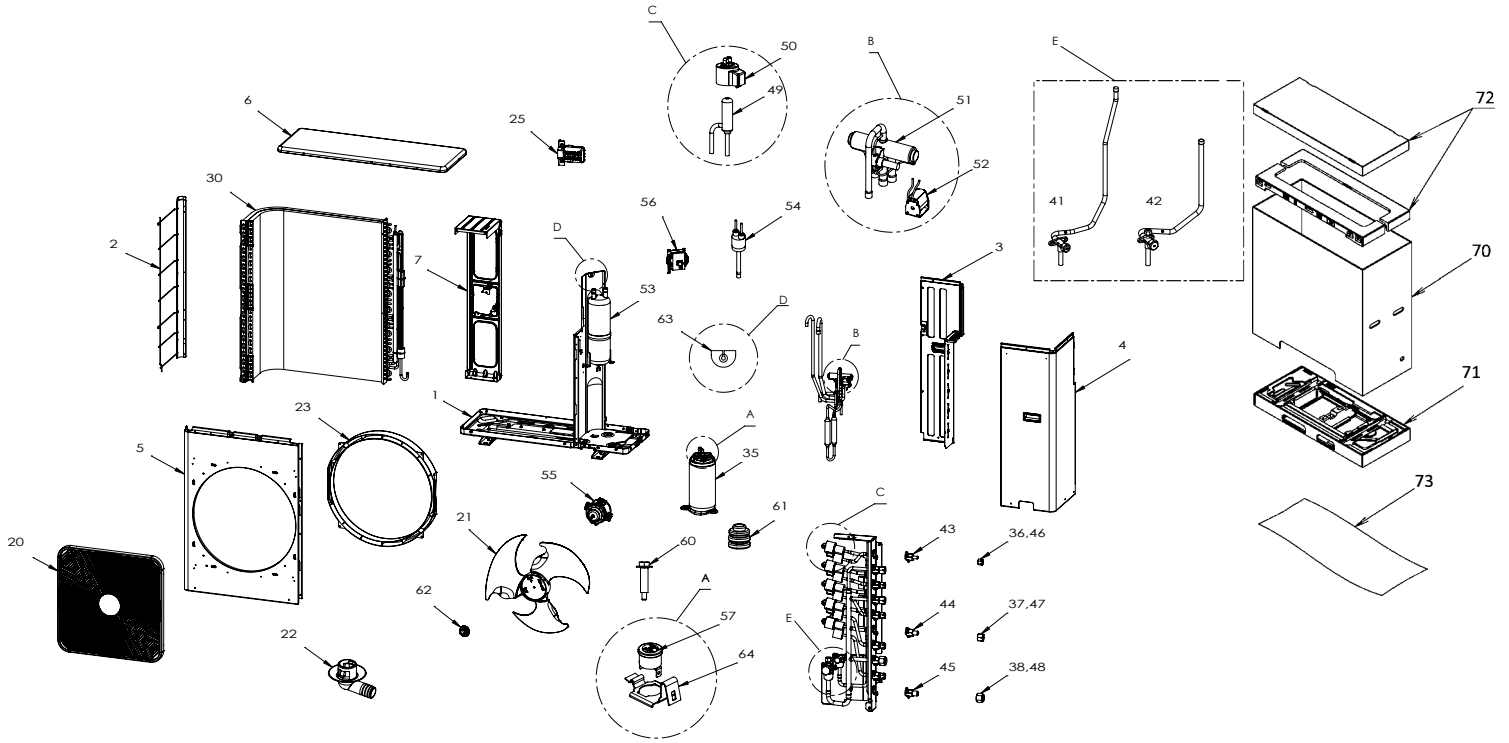
No.	Part name	Procedure	Remarks
⑬	TE sensor (Outdoor heat exchange temperature)	<p>* <b>Attachment</b></p> <p>Mount TE sensor on the straight part of the condenser discharge port pipe so that the lead wire directs upward and the sensor directs the liquid store tank.</p> <p><b>Detail C</b></p>  <p>TE sensor Reference end of curve</p>	 <p><b>Detail F</b></p>
⑭	TS sensor (Suction temperature)	<p>* <b>Attachment</b></p> <p>Insert TS sensor into the sensor holder welded to the suction pipe and then mount it.</p> <p><b>Detail D</b></p> 	 <p><b>Detail C</b> <b>Detail D</b> <b>Detail E</b></p>
⑮	TD sensor (Discharge temperature)	<p>* <b>Attachment</b></p> <p>Mount TD sensor on the straight part of the discharge pipe so that the lead wire directs upward and the sensor directs upward of the cabinet.</p> <p><b>Detail E</b></p> 	<p><b>NOTE</b></p> <hr/> <p>At working time (finish time), be sure not to damage the cover of the sensor lead wire with edge of sheet metal, etc.</p> <p>If the cover of the sensor lead wire is damaged, it is dangerous because an electric shock or fire may be caused.</p> <hr/>
⑯	TO sensor (Outside temperature)	<p>* <b>Attachment</b></p> <p>Insert TO sensor holder claw into the heat exchange terminal block hole and then mount it.</p> <p><b>Detail F</b> Heat exchange terminal block hole TO sensor holder</p> 	<p><b>NOTE</b></p> <hr/> <p>After replacing of parts, check the sensors are mounted at the specified positions.</p> <p>If there are incorrect mounted positions, control of the product does not operate correctly and a trouble may be caused.</p> <hr/>

No.	Part name	Procedure	Remarks
⑰	TG sensor TGc: Green TGb: Red TGa: Yellow	<p><b>* Attachment</b></p> <p>Mount these sensors on the directly arranged part of the header connecting pipe at gas side so that the cabinet turns toward the front side and the sensors turn toward upper cabinet.</p> <p><b>NOTE)</b></p> <hr/> <p>When mounting the sensors, check paint color of the sensor lead tube part and the pipe color. Mount the sensors to the position of same color.</p> <hr/> <p><b>Detail G</b></p>  <p>TGc: Green                      TGb: Red                      TGa: Yellow</p>	 <p><b>Detail G</b></p> <p><b>NOTE)</b></p> <hr/> <p>At working time (finish time), be sure not to damage the cover of the sensor lead wire with edge of sheet metal, etc.</p> <p>If the cover of the sensor lead wire is damaged, it is dangerous because an electric shock or fire may be caused.</p> <hr/> <p><b>NOTE)</b></p> <hr/> <p>After replacing of parts, check the sensors are mounted at the specified positions.</p> <p>If there are incorrect mounted positions, control of the product does not operate correctly and a trouble may be caused.</p> <hr/>
⑱	Sensor wiring process	<ul style="list-style-type: none"> <li>Using bundling band, bind PMV coil (Green to Yellow) with Tga to Tgc.</li> <li>For Td sensor, bind the case thermo and reactor lead by bundling band.</li> </ul> <p>Bundling band                      PMV coil (Green to Yellow)                      TGa to TGc sensors</p>  <p>Bundling band                      Td sensor                      Case thermo                      Reactor lead</p> <p>Pass TG sensor through the upper side of connecting pipe of PMV unit (Green) and then bind it with lead wire of PMV coil.</p> <p><b>NOTE)</b></p> <hr/> <p>Using the bundling band being on the market, be sure to bind the position which was bound.</p> <hr/>	<p>At working time (finish time), be sure not to damage the cover of the sensor lead wire with edge of sheet metal, etc.</p> <p>If the cover of the sensor lead wire is damaged, it is dangerous because an electric shock or fire may be caused.</p> <hr/> <p><b>NOTE)</b></p> <hr/> <p>After replacing of parts, check the sensors are mounted at the specified positions.</p> <p>If there are incorrect mounted positions, control of the product does not operate correctly and a trouble may be caused.</p> <hr/>

No.	Part name	Procedure	Remarks
⑱	Sensor wiring process (Continued)	<ul style="list-style-type: none"> <li>* Bind TS sensor, TE sensor and TO sensor with the bundling band.</li> <li>* Pass TE sensor and TO sensor through upper part of the inverter fixing board and then bind them with the bundling band.</li> </ul> <p><b>NOTE)</b></p> <hr/> <p>Using the bundling band being on the market, be sure to bind the position which was bound.</p> <hr/>	 <p style="text-align: center;">Inverter fixing board</p> <p style="text-align: center;">Bundling band TS sensor TE sensor TO sensor</p> <p style="text-align: center;">Bundling band TE sensor TO sensor</p>
⑲	Pressure switch	<ol style="list-style-type: none"> <li>1. Detachment                         <ol style="list-style-type: none"> <li>1) Perform work of Detachment 1 of 1.</li> <li>2) Recover the refrigerant gas from the outdoor unit.</li> <li>3) Perform works of 2, 3 and 4.</li> <li>4) Remove the soundproof plate, TD sensor, Reactor on the partition plate and butyl on the pipe of pressure switch.</li> <li>5) Using a burner, remove the welded parts of the pipe of pressure switch.</li> </ol> </li> </ol> <p><b>NOTE)</b></p> <hr/> <p>Take care that the electric parts, 4-way valve unit, butyle, compressor, accum tank, and etc. are not caught by flame.                      (Otherwise operation trouble may occur.)</p> <hr/> <ol style="list-style-type: none"> <li>2. Attachment                         <ul style="list-style-type: none"> <li>• Be sure not to burn lead wire of the pressure switch.</li> <li>• Take care there is no missing of sensor.</li> </ul> </li> </ol> <p><b>NOTE)</b></p> <hr/> <p>Take care that the body of the pressure is not be 100°C or more.                      For cooling pressure switch, use the wet towel and etc.                      Use the protective plate for the welding.</p> <hr/>	 <p style="text-align: center;">Picture A</p> <p style="text-align: right;">4-way valve unit</p> <p style="text-align: right;">High Pressure switch</p> <p style="text-align: right;">Protective plate for welding</p> <p style="text-align: right;">Wet towel</p>

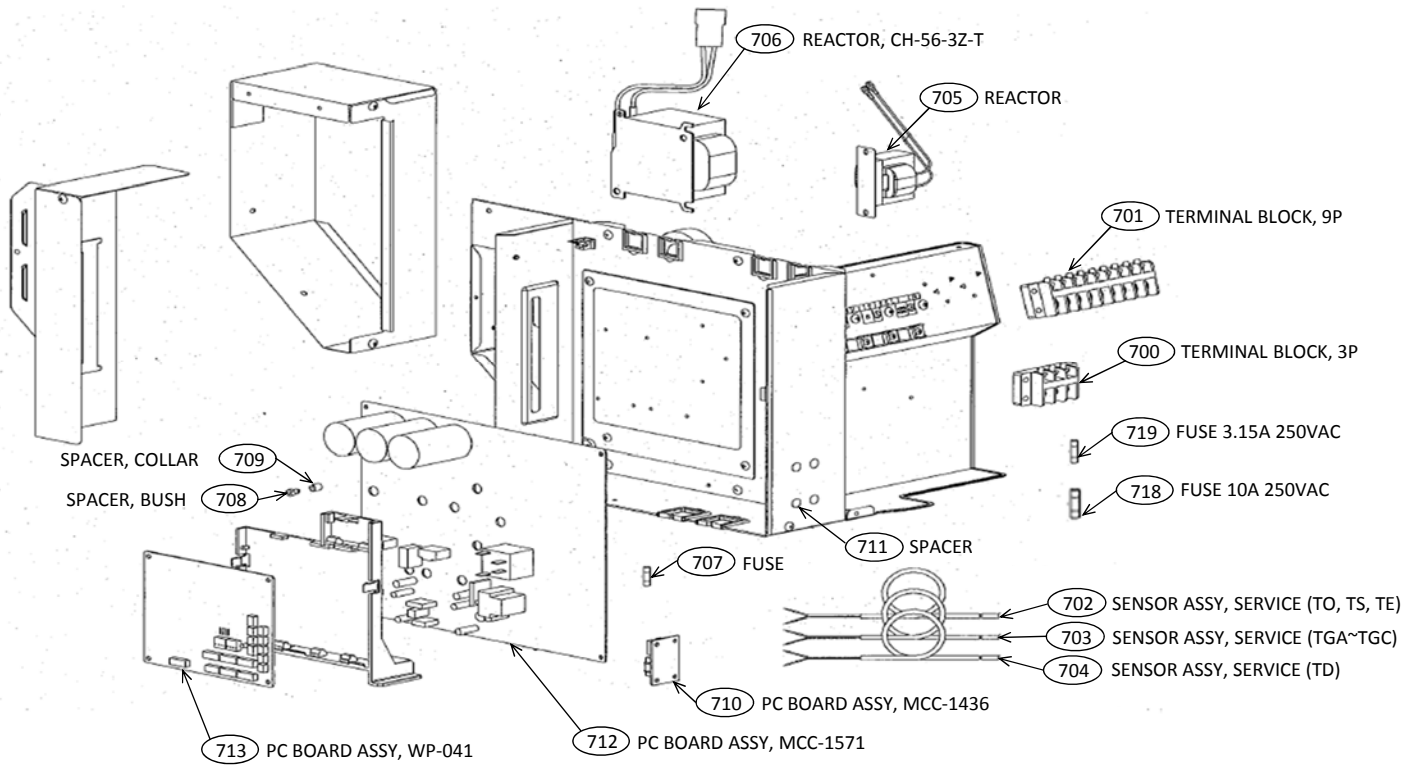
### 13. EXPLODED VIEWS AND PARTS LIST

#### 13-1. Outdoor Unit



Location No.	Part No.	Description	Location No.	Part No.	Description
1	43T42363	BASE PLATE ASSEMBLY	46	43T97311	NUT, FLARE, 1/4 IN
2	43T19346	FIN GUARD ASSEMBLY	47	43T97312	NUT, FLARE, 3/8 IN
3	43T00661	ASM-CABI-BACK	48	43T97317	NUT, FLARE, 1/2 IN
4	43T00659	ASM-PANEL-FRONT	49	43T46439	BODY-PMV
5	43T00551	AIR OUTLET CABINET	50	43T46440	COIL-PMV
6	43T00803	UPPER CABINET ASSEMBLY	51	43T46383	VALVE-4WAY
7	43T39342	MOTOR BASE	52	43T63344	COIL-V-4WAY
20	43T19372	FAN GUARD(TOSHIBA)	53	43T48310	ACCUMULATOR ASSEMBLY
21	43T20329	PROPELLER FAN	54	43T63380	HIGH PRESSURE SWITCH ASSEMBLY
22	43T79305	DRAIN NIPPLE	55	43T21429	FAN MOTOR; ICF-280-A60-1
23	43T22313	BELLMOUTH	56	43T58307	REACTOR
30	43T43639	CONDENSER ASSEMBLY	57	43T54319	BIMETAL-THERMO
35	43T41539	COMPRESSOR	60	43T47385	BOLT, COMPRESSOR
36	43T47403	BONNET, 6.35 DIA	61	43T49346	RUBBER CUSHION
37	43T47404	BONNET, 9.52 DIA	62	43T47001	NUT FLANGE
38	43T47405	BONNET, 12.7 DIA	63	43T96305	BUSHING
41	43T46509	VALVE;PACKED 9.52 DIA	64	43T50307	HOLDER-THERMO
42	43T46511	VALVE;PACKED 12.7 DIA	70	43T91323	CARTON-BOX
43	43T46501	SOCKET 6.35 DIA	71	43T91318	FIBERBOARD UNDER ASSEMBLY
44	43T46500	SOCKET 9.52 DIA	72	43T91324	FIBERBOARD UPPER ASSEMBLY
45	43T46499	SOCKET 12.7 DIA	73	43T91301	PE SHEET

13-2. Inverter Assembly



Location No.	Part No.	Description	Location No.	Part No.	Description
700	43T60427	TERMINAL BLOCK	708	43T61315	SPACER(BUSH)
701	43T60452	SERV-TERMINAL	709	43T61316	SPACER(COLLAR)
702	43T50347	SENSOR ASSY, SERVICE	710	43T6V587	ASM-PCB(FAN-REL)
703	43T50356	SERVICE-SENSOR	711	43T61324	ASM-SPACER-SET
704	43T60433	SENSOR ASSY, SERVICE	712	43T6W379	PC-BOARD
705	43T58341	REACTOR	713	43T6W382	PC-BOARD
706	43T58307	REACTOR	718	43T60490	FUSE
707	43T60413	FUSE	719	43T60361	FUSE

# **Toshiba Carrier (Thailand) Co., Ltd.**

**144/9 MOO 5, BANGKADI INDUSTRIAL PARK, TIVANON ROAD, TAMBOL BANGKADI,  
AMPHUR MUANG, PATHUMTHANI 12000, THAILAND.**