

TOSHIBA

SERVICE MANUAL

AIR-CONDITIONER (SPLIT TYPE)

OUTDOOR UNIT
<DIGITAL INVERTER>

RAV-GM1601AT8P-E
RAV-GM1601AT8JP-E
RAV-GM1601AT8P-TR

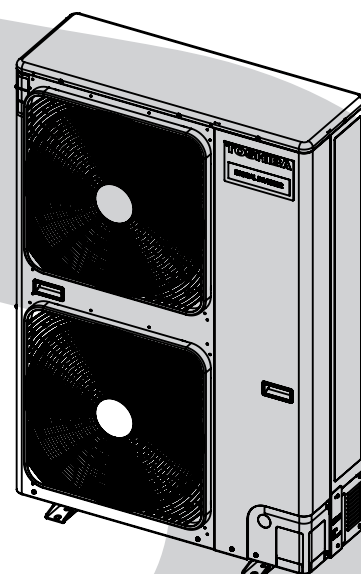

R32

INVERTER



Revised on May, 2020

Original instruction Adoption of R32 Refrigerant

This air conditioner adopts the HFC refrigerant (R32) which does not destroy the ozone layer.
This outdoor unit is designed exclusively for use with R32 refrigerant. Be sure to use in combination with a R32 refrigerant indoor unit.

CONTENTS

SAFETY CAUTION	4
1. SPECIFICATIONS	18
1-1. Outdoor Unit	18
1-2. Operation Characteristic Curve	20
2. CONSTRUCTION VIEWS (EXTERNAL VIEWS)	21
3. SYSTEMATIC REFRIGERATING CYCLE DIAGRAM	24
3-1. Indoor Unit	24
3-2. Outdoor Unit	26
3-3. Operation Data	26
4. WIRING DIAGRAM	27
5. SPECIFICATIONS OF ELECTRICAL PARTS	28
6. REFRIGERANT R32	29
6-1. Safety During Installation / Servicing	29
6-2. Refrigerant Piping Installation	29
6-3. Tools	33
6-4. Recharging of Refrigerant	33
6-5. Brazing of Pipes	34
6-6. Instructions for Re-use Piping of R22 or R410A	36
6-7. Charging additional refrigerant	39
6-8. Tolerance of Pipe Length and Pipe Head.....	40
6-9. Additional Refrigerant Amount	42
6-10. Piping Materials and Sizes	44
6-11. Branch Pipe	45
6-12. Distributor	45
6-13. General safety precautions for using R32 refrigerant	46
7. OUTDOOR CONTROL CIRCUIT	47
7-1. Outdoor unit control.....	47
7-2. Outline of Main Controls.....	50

8. TROUBLESHOOTING	55
8-1. Summary of Troubleshooting	55
8-2. Troubleshooting	57
8-3. Table Inspection of outdoor unit main parts	76
9. SETUP AT LOCAL SITE AND OTHERS	77
9-1. Calling of error history Unit	77
9-2. Others	79
10. ADDRESS SETUP	80
10-1. Address Setup Procedure	80
10-2. Address Setup & Group Control	81
10-3. Remote Controller Wiring	84
10-4. Address Setup (Manual setting from remote controller)	84
10-5. Confirmation of Indoor Unit No. Position	85
11. DETACHMENTS	87
12. EXPLODED VIEWS AND PARTS LIST	98

SAFETY CAUTION

Please read carefully through these instructions that contain important information which complies with the “Machinery” Directive (Directive 2006/42/EC), and ensure that you understand them.

Generic Denomination: Air Conditioner

Definition of Qualified Installer or Qualified Service Person

The air conditioner must be installed, maintained, repaired and removed by a qualified installer or qualified service person.

When any of these jobs is to be done, ask a qualified installer or qualified service person to do them for you.

A qualified installer or qualified service person is an agent who has the qualifications and knowledge described in the table below.

Agent	Qualifications and knowledge which the agent must have
Qualified installer (*1)	<ul style="list-style-type: none"> • The qualified installer is a person who installs, maintains, relocates and removes the air conditioners made by Toshiba Carrier Corporation. He or she has been trained to install, maintain, relocate and remove the air conditioners made by Toshiba Carrier Corporation or, alternatively, he or she has been instructed in such operations by an individual or individuals who have been trained and is thus thoroughly acquainted with the knowledge related to these operations. • The qualified installer who is allowed to do the electrical work involved in installation, relocation and removal has the qualifications pertaining to this electrical work as stipulated by the local laws and regulations, and he or she is a person who has been trained in matters relating to electrical work on the air conditioners made by Toshiba Carrier Corporation or, alternatively, he or she has been instructed in such matters by an individual or individuals who have been trained and is thus thoroughly acquainted with the knowledge related to this work. • The qualified installer who is allowed to do the refrigerant handling and piping work involved in installation, relocation and removal has the qualifications pertaining to this refrigerant handling and piping work as stipulated by the local laws and regulations, and he or she is a person who has been trained in matters relating to refrigerant handling and piping work on the air conditioners made by Toshiba Carrier Corporation or, alternatively, he or she has been instructed in such matters by an individual or individuals who have been trained and is thus thoroughly acquainted with the knowledge related to this work. • The qualified installer who is allowed to work at heights has been trained in matters relating to working at heights with the air conditioners made by Toshiba Carrier Corporation or, alternatively, he or she has been instructed in such matters by an individual or individuals who have been trained and is thus thoroughly acquainted with the knowledge related to this work.
Qualified service person (*1)	<ul style="list-style-type: none"> • The qualified service person is a person who installs, repairs, maintains, relocates and removes the air conditioners made by Toshiba Carrier Corporation. He or she has been trained to install, repair, maintain, relocate and remove the air conditioners made by Toshiba Carrier Corporation or, alternatively, he or she has been instructed in such operations by an individual or individuals who have been trained and is thus thoroughly acquainted with the knowledge related to these operations. • The qualified service person who is allowed to do the electrical work involved in installation, repair, relocation and removal has the qualifications pertaining to this electrical work as stipulated by the local laws and regulations, and he or she is a person who has been trained in matters relating to electrical work on the air conditioners made by Toshiba Carrier Corporation or, alternatively, he or she has been instructed in such matters by an individual or individuals who have been trained and is thus thoroughly acquainted with the knowledge related to this work. • The qualified service person who is allowed to do the refrigerant handling and piping work involved in installation, repair, relocation and removal has the qualifications pertaining to this refrigerant handling and piping work as stipulated by the local laws and regulations, and he or she is a person who has been trained in matters relating to refrigerant handling and piping work on the air conditioners made by Toshiba Carrier Corporation or, alternatively, he or she has been instructed in such matters by an individual or individuals who have been trained and is thus thoroughly acquainted with the knowledge related to this work. • The qualified service person who is allowed to work at heights has been trained in matters relating to working at heights with the air conditioners made by Toshiba Carrier Corporation or, alternatively, he or she has been instructed in such matters by an individual or individuals who have been trained and is thus thoroughly acquainted with the knowledge related to this work.

Definition of Protective Gear

When the air conditioner is to be transported, installed, maintained, repaired or removed, wear protective gloves and “safety” work clothing.



In addition to such normal protective gear, wear the protective gear described below when undertaking the special work detailed in the table below.

Failure to wear the proper protective gear is dangerous because you will be more susceptible to injury, burns, electric shocks and other injuries.

Work undertaken	Protective gear worn
All types of work	Protective gloves “Safety” working clothing
Electrical-related work	Gloves to provide protection for electricians Insulating shoes Clothing to provide protection from electric shock
Work done at heights (50 cm or more)	Helmets for use in industry
Transportation of heavy objects	Shoes with additional protective toe cap
Repair of outdoor unit	Gloves to provide protection for electricians



The important contents concerned to the safety are described on the product itself and on this Service Manual. Please read this Service Manual after understanding the described items thoroughly in the following contents (Indications/Illustrated marks), and keep them.

[Explanation of indications]

Indication	Explanation
 DANGER	Indicates contents assumed that an imminent danger causing a death or serious injury of the repair engineers and the third parties when an incorrect work has been executed.
 WARNING	Indicates possibilities assumed that a danger causing a death or serious injury of the repair engineers, the third parties, and the users due to troubles of the product after work when an incorrect work has been executed.
 CAUTION	Indicates contents assumed that an injury or property damage (*) may be caused on the repair engineers, the third parties, and the users due to troubles of the product after work when an incorrect work has been executed.

* Property damage : Enlarged damage concerned to property, furniture, and domestic animal/pet

[Explanation of illustrated marks]





Mark	Explanation
	Indicates prohibited items (Forbidden items to do) The sentences near an illustrated mark describe the concrete prohibited contents.
	Indicates mandatory items (Compulsory items to do) The sentences near an illustrated mark describe the concrete mandatory contents.
	Indicates cautions (Including danger/warning) The sentences or illustration near or in an illustrated mark describe the concrete cautious contents.









■ Warning Indications on the Air Conditioner Unit



[Confirmation of warning label on the main unit]

Confirm that labels are indicated on the specified positions
If removing the label during parts replace, stick it as the original.

Meaning of symbols displayed on the unit

	<p>WARNING (Risk of fire)</p>	<p>This mark is for R32 refrigerant only. Refrigerant type is written on nameplate of outdoor unit. In case that refrigerant type is R32, this unit uses a flammable refrigerant. If refrigerant leaks and comes in contact with fire or heating part, it will create harmful gas and there is risk of fire.</p>
	<p>Read the OWNER'S MANUAL carefully before operation.</p>	
	<p>Service personnel are required to carefully read the OWNER'S MANUAL and INSTALLATION MANUAL before operation.</p>	
	<p>Further information is available in the OWNER'S MANUAL, INSTALLATION MANUAL, and the like.</p>	



Warning indication	Description			
<table border="1" style="width: 100%;"> <tr> <td data-bbox="196 1226 349 1476" rowspan="2">  </td> <td data-bbox="349 1226 743 1310"> <p>WARNING</p> </td> </tr> <tr> <td data-bbox="349 1310 743 1476"> <p>ELECTRICAL SHOCK HAZARD Disconnect all remote electric power supplies before servicing.</p> </td> </tr> </table>		<p>WARNING</p>	<p>ELECTRICAL SHOCK HAZARD Disconnect all remote electric power supplies before servicing.</p>	<p>WARNING ELECTRICAL SHOCK HAZARD Disconnect all remote electric power supplies before servicing.</p>
		<p>WARNING</p>		
	<p>ELECTRICAL SHOCK HAZARD Disconnect all remote electric power supplies before servicing.</p>			
<table border="1" style="width: 100%;"> <tr> <td data-bbox="196 1539 349 1789" rowspan="2">  </td> <td data-bbox="349 1539 743 1623"> <p>WARNING</p> </td> </tr> <tr> <td data-bbox="349 1623 743 1789"> <p>Moving parts. Do not operate unit with grille removed. Stop the unit before the servicing.</p> </td> </tr> </table>		<p>WARNING</p>	<p>Moving parts. Do not operate unit with grille removed. Stop the unit before the servicing.</p>	<p>WARNING Moving parts. Do not operate unit with grille removed. Stop the unit before the servicing.</p>
		<p>WARNING</p>		
	<p>Moving parts. Do not operate unit with grille removed. Stop the unit before the servicing.</p>			
<table border="1" style="width: 100%;"> <tr> <td data-bbox="196 1852 349 2102" rowspan="2">  </td> <td data-bbox="349 1852 743 1936"> <p>CAUTION</p> </td> </tr> <tr> <td data-bbox="349 1936 743 2102"> <p>High temperature parts. You might get burned when removing this panel.</p> </td> </tr> </table>		<p>CAUTION</p>	<p>High temperature parts. You might get burned when removing this panel.</p>	<p>CAUTION High temperature parts. You might get burned when removing this panel.</p>
		<p>CAUTION</p>		
	<p>High temperature parts. You might get burned when removing this panel.</p>			

	<p style="text-align: center;">WARNING</p> <hr/> <p>Capacitor connected within this disconnect or downstream upon shutdown wait 5 minute to allow capacitors to discharge.</p>	<p>WARNING Open the service valves before the operation, otherwise there might be the burst.</p>
	<p style="text-align: center;">CAUTION</p> <hr/> <p style="text-align: center;">BURST HAZARD</p> <p>Open the service valves before the operation, otherwise there might be the burst.</p>	<p>CAUTION</p> <p>BURST HAZARD Open the service valves before the operation, otherwise there might be the burst.</p>
	<p style="text-align: center;">CAUTION</p> <hr/> <p>Do not touch the aluminum fins of the unit. Doing so may result in injury.</p>	<p>CAUTION</p> <p>Do not touch the aluminum fins of the unit. Doing so may result in injury.</p>

Precaution for Safety









The appliance shall be installed in accordance with national wiring regulations. Capacity shortages of the power circuit or an incomplete installation may cause an electric shock or fire.





DANGER





 Turn off breaker.	Before carrying out the installation, maintenance, repair or removal work, be sure to set the circuit breaker to the OFF position. Otherwise, electric shocks may result.
	Before opening the intake grille of the indoor unit or service panel of the outdoor unit, set the circuit breaker to the OFF position. Failure to set the circuit breaker to the OFF position may result in electric shocks through contact with the interior parts.
	Only a qualified installer (*1) or qualified service person (*1) is allowed to remove the intake grille of the indoor unit or service panel of the outdoor unit and do the work required.
	Before starting to repair the outdoor unit fan or fan guard, be absolutely sure to set the circuit breaker to the OFF position, and place a "Work in progress" sign on the circuit breaker.
 Prohibition	When cleaning the filter or other parts of the indoor unit, set the circuit breaker to OFF without fail, and place a "Work in progress" sign near the circuit breaker before proceeding with the work.
	Do not turn ON the circuit breaker under the condition of removing a cabinet, a panel, etc. Otherwise, it leads to an electric shock with a high voltage, resulting in loss of life.



WARNING

 General	Before starting to repair the air conditioner, read carefully through the Service Manual, and repair the air conditioner by following its instructions.
	Only qualified service person (*1) is allowed to repair the air conditioner. Repair of the air conditioner by unqualified person may give rise to a fire, electric shocks, injury, water leaks and/or other problems.
	Only a qualified installer (*1) or qualified service person (*1) is allowed to carry out the electrical work of the air conditioner. Under no circumstances must this work be done by an unqualified individual since failure to carry out the work properly may result in electric shocks and/or electrical leaks.
	Wear protective gloves and safety work clothing during installation, servicing and removal.
	When connecting the electrical wires, repairing the electrical parts or undertaking other electrical jobs, wear gloves to provide protection for electricians, insulating shoes and clothing to provide protection from electric shocks. Failure to wear this protective gear may result in electric shocks.
	Use wiring that meets the specifications in the Installation Manual and the stipulations in the local regulations and laws. Use of wiring which does not meet the specifications may give rise to electric shocks, electrical leakage, smoking and/or a fire.
	Only a qualified installer (*1) or qualified service person (*1) is allowed to undertake work at heights using a stand of 50 cm or more.
	When working at heights, use a ladder which complies with the ISO 14122 standard, and follow the procedure in the ladder's instructions. Also wear a helmet for use in industry as protective gear to undertake the work.
	When working at heights, put a sign in place so that no-one will approach the work location, before proceeding with the work. Parts and other objects may fall from above, possibly injuring a person below.
	Do not touch the aluminum fin of the outdoor unit. You may injure yourself if you do so. If the fin must be touched for some reason, first put on protective gloves and safety work clothing, and then proceed.
	Do not climb onto or place objects on top of the outdoor unit. You may fall or the objects may fall off of the outdoor unit and result in injury.
	When transporting the air conditioner, wear shoes with additional protective toe caps.
	When transporting the air conditioner, do not take hold of the bands around the packing carton. You may injure yourself if the bands should break.
	This air conditioner has passed the pressure test as specified in IEC 60335-2-40 Annex EE.



 Electric shock hazard	When you access inside of the electric cover to repair electric parts, wait for about five minutes after turning off the breaker. Do not start repairing immediately. Otherwise you may get electric shock by touching terminals of high-voltage capacitors. Natural discharge of the capacitor takes about five minutes.
 Prohibition	Place a "Work in progress" sign near the circuit breaker while the installation, maintenance, repair or removal work is being carried out. There is a danger of electric shocks if the circuit breaker is set to ON by mistake. When checking the electric parts, removing the cover of the electric parts box of Indoor Unit and/or front panel of Outdoor Unit inevitably to determine the failure, put a sign "Do not enter" around the site before the work. Failure to do this may result in third person getting electric shock. Before operating the air conditioner after having completed the work, check that the electrical parts box cover of the indoor unit and service panel of the outdoor unit are closed, and set the circuit breaker to the ON position. You may receive an electric shock if the power is turned on without first conducting these checks.
 Stay on protection	If, in the course of carrying out repairs, it becomes absolutely necessary to check out the electrical parts with the electrical parts box cover of one or more of the indoor units and the service panel of the outdoor unit removed in order to find out exactly where the trouble lies, wear insulated heat-resistant gloves, insulated boots and insulated work overalls, and take care to avoid touching any live parts. You may receive an electric shock if you fail to heed this warning. Only qualified service person (*1) is allowed to do this kind of work.
 Check earth wires.	Before troubleshooting or repair work, check the earth wire is connected to the earth terminals of the main unit, otherwise an electric shock is caused when a leak occurs. If the earth wire is not correctly connected, contact an electric engineer for rework. After completing the repair or relocation work, check that the ground wires are connected properly. Be sure to connect earth wire. (Grounding work) Incomplete grounding causes an electric shock. Do not connect ground wires to gas pipes, water pipes, and lightning rods or ground wires for telephone wires.
 Prohibition of modification.	Do not modify the products. Do not also disassemble or modify the parts. It may cause a fire, electric shock or injury.
 Use specified parts.	When any of the electrical parts are to be replaced, ensure that the replacement parts satisfy the specifications given in the Service Manual (or use the parts contained on the parts list in the Service Manual). Use of any parts which do not satisfy the required specifications may give rise to electric shocks, smoking and/or a fire. Replace components only with parts specified by the manufacturer. Other parts may result in the ignition of refrigerant in the atmosphere from a leak.
 Do not bring a child close to the equipment.	If, in the course of carrying out repairs, it becomes absolutely necessary to check out the electrical parts with the electrical parts box cover of one or more of the indoor units and the service panel of the outdoor unit removed in order to find out exactly where the trouble lies, place Keep out signs around the work site before proceeding. Third-party individuals may enter the work site and receive electric shocks if this warning is not heeded.
 Insulating measures	Connect the cut-off lead wires with crimp contact, etc., put the closed end side upward and then apply a water-cut method, otherwise a leak or production of fire is caused at the users' side.

 No fire	<p>When performing repairs using a gas burner, replace the refrigerant with nitrogen gas because the oil that coats the pipes may otherwise burn.</p> <p>When repairing the refrigerating cycle, take the following measures.</p> <ol style="list-style-type: none"> 1) Be attentive to fire around the cycle. When using a gas stove, etc., be sure to put out fire before work; otherwise the oil mixed with refrigerant gas may catch fire. 2) Do not use a welder in the closed room. When using it without ventilation, carbon monoxide poisoning may be caused. 3) Do not bring inflammables close to the refrigerant cycle, otherwise fire of the welder may catch the inflammables.
 Refrigerant	<p>The refrigerant used by this air conditioner is the R32.</p> <p>Check the used refrigerant name and use tools and materials of the parts which match with it. For the products which use R32 refrigerant, the refrigerant name is indicated at a position on the outdoor unit where is easy to see. To prevent miss-charging, the route of the service port is changed from one of the former R22.</p> <p>Be careful for miss-charging since a charging port of R32 is the same diameter as that of R410A.</p> <hr/> <p>Do not use any refrigerant different from the one specified for complement or replacement. Otherwise, abnormally high pressure may be generated in the refrigeration cycle, which may result in a failure or explosion of the product or an injury to your body.</p> <hr/> <p>For an air conditioner which uses R32, never use other refrigerant than R32. For an air conditioner which uses other refrigerant (R22, R410A etc.), never use R32. If different types of refrigerant are mixed, abnormal high pressure generates in the refrigerating cycle and an injury due to breakage may be caused. If the different type of refrigerants are mixed in, be sure to recharge the refrigerant</p> <hr/> <p>Do not charge refrigerant additionally. If charging refrigerant additionally when refrigerant gas leaks, the refrigerant composition in the refrigerating cycle changes resulted in change of air conditioner characteristics or refrigerant over the specified standard amount is charged and an abnormal high pressure is applied to the inside of the refrigerating cycle resulted in cause of breakage or injury. Therefore if the refrigerant gas leaks, recover the refrigerant in the air conditioner, execute vacuuming, and then newly recharge the specified amount of liquid refrigerant. In this time, never charge the refrigerant over the specified amount.</p> <hr/> <p>When recharging the refrigerant in the refrigerating cycle, do not mix the refrigerant or air other than R32 into the specified refrigerant. If air or others is mixed with the refrigerant, abnormal high pressure generates in the refrigerating cycle resulted in cause of injury due to breakage.</p> <hr/> <p>After the installation work, confirm that refrigerant gas does not leak. If refrigerant gas leaks into the room and flows near a fire source, such as a cooking range, it may generate noxious gases, causing a fire.</p> <hr/> <p>Never recover the refrigerant into the outdoor unit. When the equipment is moved or repaired, be sure to recover the refrigerant with recovering device. The refrigerant cannot be recovered in the outdoor unit; otherwise a serious accident such as breakage or injury is caused.</p>
 Assembly/ Wiring	<p>After repair work, surely assemble the disassembled parts, and connect and lead the removed wires as before. Perform the work so that the cabinet or panel does not catch the inner wires. If incorrect assembly or incorrect wire connection was done, a disaster such as a leak or fire is caused at user's side.</p>
 Insulator check	<p>After the work has finished, be sure to use an insulation tester set (500V Megger) to check the resistance is 1MΩ or more between the charge section and the non-charge metal section (Earth position). If the resistance value is low, a disaster such as a leak or electric shock is caused at user's side.</p>
 Ventilation	<p>When the refrigerant gas leaks during work, execute ventilation. If the refrigerant gas touches to a fire, it may generate noxious gases, causing a fire. A case of leakage of the refrigerant and the closed room full with gas is dangerous because a shortage of oxygen occurs. Be sure to execute ventilation.</p> <hr/> <p>If refrigerant gas has leaked during the installation work, ventilate the room immediately. If the leaked refrigerant gas comes in contact with fire, it may generate noxious gases, causing a fire.</p>

 Compulsion	<p>When the refrigerant gas leaks, find up the leaked position and repair it surely. If the leaked position cannot be found up and the repair work is interrupted, pump-down and tighten the service valve, otherwise the refrigerant gas may leak into the room. When gas touches to fire such as fan heater, stove or cooking stove, it may generate noxious gases, causing a fire though the refrigerant gas itself is innocuous. When installing equipment which includes a large amount of charged refrigerant such as a multi air conditioner in a sub-room, it is necessary that the density does not the limit even if the refrigerant leaks. If the refrigerant leaks and exceeds the limit density, an accident of shortage of oxygen is caused.</p> <p>Tighten the flare nut with a torque wrench in the specified manner. Excessive tighten of the flare nut may cause a crack in the flare nut after a long period, which may result in refrigerant leakage.</p> <p>Nitrogen gas must be used for the airtight test.</p> <p>The charge hose must be connected in such a way that it is not slack.</p> <p>For the installation/moving/reinstallation work, follow to the Installation Manual. If an incorrect installation is done, a trouble of the refrigerating cycle, water leak, electric shock or fire is caused.</p> <p>Install the outdoor unit properly in a location that is durable enough to support the weight of the outdoor unit. Insufficient durability may cause the outdoor unit to fall, which may result in injury.</p>
 Check after repair	<p>Once the repair work has been completed, check for refrigerant leaks, and check the insulation resistance and water drainage. Then perform a trial run to check that the air conditioner is running properly.</p> <p>After repair work has finished, check there is no trouble. If check is not executed, a fire, electric shock or injury may be caused. For a check, turn off the power breaker.</p> <p>After repair work (installation of front panel and cabinet) has finished, execute a test run to check there is no generation of smoke or abnormal sound. If check is not executed, a fire or an electric shock is caused. Before test run, install the front panel and cabinet.</p>
 Do not operate the unit with the valve closed.	<p>Check the following matters before a test run after repairing piping.</p> <ul style="list-style-type: none"> • Connect the pipes surely and there is no leak of refrigerant. • The valve is opened. <p>Running the compressor under condition that the valve closes causes an abnormal high pressure resulted in damage of the parts of the compressor and etc. and moreover if there is leak of refrigerant at connecting section of pipes, the air is suctioned and causes further abnormal high pressure resulted in burst or injury.</p>
 Check after reinstallation	<p>Only a qualified installer (*1) or qualified service person (*1) is allowed to relocate the air conditioner. It is dangerous for the air conditioner to be relocated by an unqualified individual since a fire, electric shocks, injury, water leakage, noise and/or vibration may result.</p> <p>Check the following items after reinstallation.</p> <ol style="list-style-type: none"> 1) The earth wire is correctly connected. 2) The power cord is not caught in the product. 3) There is no inclination or unsteadiness and the installation is stable. <p>If check is not executed, a fire, an electric shock or an injury is caused.</p>
 Cooling check	<p>When the service panel of the outdoor unit is to be opened in order for the compressor or the area around this part to be repaired immediately after the air conditioner has been shut down, set the circuit breaker to the OFF position, and then wait at least 10 minutes before opening the service panel. If you fail to heed this warning, you will run the risk of burning yourself because the compressor pipes and other parts will be very hot to the touch. In addition, before proceeding with the repair work, wear the kind of insulated heat-resistant gloves designed to protect electricians.</p> <p>When the service panel of the outdoor unit is to be opened in order for the fan motor, reactor, inverter or the areas around these parts to be repaired immediately after the air conditioner has been shut down, set the circuit breaker to the OFF position, and then wait at least 10 minutes before opening the service panel.</p> <p>If you fail to heed this warning, you will run the risk of burning yourself because the fan motor, reactor, inverter heat sink and other parts will be very hot to the touch.</p> <p>In addition, before proceeding with the repair work, wear the kind of insulated heat-resistant gloves designed to protect electricians.</p>

 Installation	Only a qualified installer (*1) or qualified service person (*1) is allowed to install the air conditioner. If the air conditioner is installed by an unqualified individual, a fire, electric shocks, injury, water leakage, noise and/or vibration may result.
	Before starting to install the air conditioner, read carefully through the Installation Manual, and follow its instructions to install the air conditioner.
	Do not install the air conditioner in a location that may be subject to a risk of exposure to a combustible gas. If a combustible gas leaks and becomes concentrated around the unit, a fire may occur.
	When transporting the air conditioner, use a forklift and when moving the air conditioner by hand, move the unit with 4 people
	Install a circuit breaker that meets the specifications in the installation manual and the stipulations in the local regulations and laws.
	Install the circuit breaker where it can be easily accessed by the agent.
 Compulsion	Do not place any combustion appliance in a place where it is directly exposed to the wind of air conditioner, otherwise it may cause imperfect combustion.
	When carrying out the pump-down work shut down the compressor before disconnecting the refrigerant pipe. Disconnecting the refrigerant pipe with the service valve left open and the compressor still operating will cause air, etc. to be sucked in, raising the pressure inside the refrigeration cycle to an abnormally high level, and possibly resulting in reputing, injury, etc.
 Prohibition	When removing the welding parts of suction and discharge pipe for the compressor, remove them at the place ventilated well after recovering the refrigerant. Improper recovering may cause the spurt of the refrigerant and the refrigeration oil, causing an injury.
	Do not vent gases to the atmosphere. Venting gases to the atmosphere is prohibited by the law.

 **CAUTION**

 Wearing of gloves	Ensure wearing of gloves when performing any work in order to avoid injury from parts, etc. Failure to wear the proper protective gloves cause an injury due to the parts, etc.
 Confirm	When performing the welding work, check whether refrigerant leaks or remains. If the leakage refrigerant gas touches a fire source, it may generate noxious gases, causing a fire.

Explanations given to user

- If you have discovered that the fan grille is damaged, do not approach the outdoor unit but set the circuit breaker to the OFF position, and contact a qualified service person to have the repairs done.
Do not set the circuit breaker to the ON position until the repairs are completed.

Relocation

- Only a qualified installer (*1) or qualified service person (*1) is allowed to relocate the air conditioner.
It is dangerous for the air conditioner to be relocated by an unqualified individual since a fire, electric shocks, injury, water leakage, noise and/or vibration may result.
- When carrying out the pump-down work shut down the compressor before disconnecting the refrigerant pipe.
Disconnecting the refrigerant pipe with the service valve left open and the compressor still operating will cause air, etc. to be sucked in, raising the pressure inside the refrigeration cycle to an abnormally high level, and possibly resulting in reputing, injury, etc.

(*1) Refer to the "Definition of Qualified Installer or Qualified Service Person."

Declaration of Conformity

Manufacturer: **TOSHIBA CARRIER (THAILAND) CO., LTD.**
144 / 9 Moo 5, Bangkadi Industrial Park, Tivanon Road, Tambol Bangkadi,
Amphur Muang, Pathumthani 12000, Thailand

TCF holder: TOSHIBA CARRIER EUROPE S.A.S
Route de Thil 01120 Montluel FRANCE

Hereby declares that the machinery described below:

Generic Denomination: Air Conditioner
Model/type: RAV-GM1601AT8P-E
RAV-GM1601ATJ8P-E
RAV-GM1601AT8P-TR

Commercial name: Digital Inverter Series Air Conditioner

Complies with the provision of the Machinery Directive (Directive 2006/42/EC) and the regulations transposing into national law.

Note: This declaration becomes invalid if technical or operational modifications are introduced without the manufacturer's consent.

Specifications

Model	Sound power level (dBA)		Weight (kg)
	Cooling	Heating	
RAV-GM1601AT8P-E	70	72	94
RAV-GM1601AT8JP-E	70	72	94
RAV-GM1601AT8P-TR	70	72	94

Refrigerant R32

This air conditioner adopts a new HFC type refrigerant (R32) which does not deplete the ozone layer.

1. Safety Caution Concerned to Refrigerant R32

Be sure that water, dust, the former refrigerant or the former refrigerating oil is not mixed into the refrigerating cycle of the air conditioner with refrigerant R32 during installation work or service work. If an incorrect work or incorrect service is performed, there is a possibility to cause a serious accident. Use the tools and materials exclusive to R32 to purpose a safe work.

2. Safety and Cautions on Installation/Service

<Safety items>

When gas concentration and ignition energy are happened at the same time, R32 has a slight possibility of burning. Although it will not ignite under normal work environment conditions, be aware that the flame spreads if ignition should occur. It is necessary to carry out installation/servicing safely while taking the following precautions into consideration.

- 1) Never use refrigerant other than specified refrigerant (R32) in an air conditioner which is designed to operate with the specified refrigerant (R32).
If other refrigerant than R32 is used, it may cause personal injury, etc. by a malfunction, a fire, a rupture.
- 2) Since R32 is heavier than air, it tends to accumulate on the bottom (near the floor). Ventilate properly for the working environment to prevent its combustion. Especially in a basement or a closed room where is the high risk of the accumulation, ventilate the room with a local exhaust ventilation. If refrigerant leakage is confirmed in the room or the place where the ventilation is insufficient, do not work until the proper ventilation is performed and the work environment is improved.
- 3) When performing brazing work, be sure to check for leakage refrigerant or residual refrigerant. If the leakage refrigerant comes into contact with fire, a poisonous gas may occur or it may cause a fire. Keep adequate ventilation during the work.
- 4) When refrigerant gas leaks during work, execute ventilation. If the leakage refrigerant comes into contact with a fire, a poisonous gas may occur or it may cause a fire.
- 5) In places where installing / repairing air-conditioning equipment, etc., keep the source of ignition such as gas combustion equipment, petroleum combustion equipment, electric heater etc. away. Do not smoke in the place.
- 6) When installing or removing an air conditioner, do not mix air in the refrigerant cycle. If air or others is mixed with the refrigerant, abnormal high pressure generates in the refrigerating cycle, causing injury due to the breakage.
- 7) After installation work complete, confirm that refrigerant gas is not leaking on the flare connection part or others. If leaked refrigerant comes to contact with a fire, toxic gas may occur, causing a fire.
- 8) Perform the installation work and re-installation according to the installation manual. Pay attention especially to the area of application. Improper installation may cause refrigeration trouble or water leakage, electric shock and fire etc.
- 9) Unauthorized modifications to the air conditioner may be dangerous. If a breakdown occurs please call a qualified air conditioner technician or electrician. Improper repair may result in water leakage, electric shock and fire, etc.
- 10) Carry out the airtight test with nitrogen at a specified pressure. Do not use oxygen or acetylene gas absolutely as it may cause an explosion.
- 11) Always carry a refrigerant leakage detection sensor during the work and work while checking that no refrigerant leaks around working environment.
- 12) If the leakage refrigerant comes into contact with fire, it may cause a fire. Have a dry powder or CO₂ fire extinguisher adjacent to the charging area.

<Caution items>

- 1) The opposite side dimension of the air-conditioner's flared nut using R32 and the shape of the charge port are the same as those of R410A.
- 2) Be careful not to charge refrigerant by mistake. Should the different type of refrigerant mix in, be sure to recharge the refrigerant
- 3) Do not mix the other refrigerant or refrigerating oil with the refrigerant.
- 4) Since the pressure of R32 is higher 1.6 times of that of the former refrigerant (R22), use tools and parts with high pressure withstand specification similar to R410A.
- 5) In the installation time, use clean pipe materials and work with great attention so that water and others do not mix in because pipes are affected by impurities such as water, oxide film, oil, etc. Use the clean pipes. Be sure to braze while flowing nitrogen gas in the pipe.
(Never use gas other than nitrogen gas.)
- 6) For the earth protection, use a vacuum pump for air purge.
- 7) R32 refrigerant is Single-component refrigerant that does not change its composition. Although it is possible to charge the refrigerant with either liquid or gas, charge it with liquid.
(If using gas for charging, composition of the refrigerant changes and then characteristics of the air conditioner change.)

3. Pipe Materials

For the refrigerant pipes, copper pipe and joints are mainly used.
It is necessary to select the most appropriate pipes to conform to the standard.
Use clean material in which impurities adhere inside of pipe or joint to a minimum.

1) Copper pipe

<Piping>

The pipe thickness, flare finishing size, flare nut and others differ according to a refrigerant type. When using a long copper pipe for R32, it is recommended to select "Copper or copper-base pipe without seam" and one with bonded oil amount 40mg/10m or less.

Also do not use crushed, deformed, discolored (especially inside) pipes.
(Impurities cause clogging of expansion valves and capillary tubes.)

<Flare nut>

Use the flare nuts which are attached to the air conditioner unit.

Be sure to select the pipes with copper thickness in the table below since the pressure of an air conditioner using R32 is higher than that of R22.

Nominal diameter	Outer diameter (mm)	Thickness (mm) R410A or R32
1/2	6.4	0.80
3/8	9.5	0.80
1/2	12.7	0.80
5/8	15.9	1.00

Make sure not to use a thin copper pipe such as 0.7 mm copper thickness in the market.

2) Joint

The flare joint and socket joint are used for joints of the copper pipe.
The joints are rarely used for installation of the air conditioner.
However clear impurities when using them.

4. Tools

Tools exclusive for R32/R410A (The following tools for R32/R410A are required.)

○: R32/R410A tools available

△: Partly unavailable, ×: R32/R410A tools unavailable

No	Installation/service tools		Use	Applicability to R32 air conditioner or not	Applicability to R22 air conditioner or not
	Tools / Equipment	specification			
1	Flare tool	Clutch type	Pipe flaring	○	○
2	Copper pipe gauge for adjusting projection margin	—	Flaring by conventional flare tool	○	—
3	Torque wrench	—	Tightening of flare nut	○	×
4	Gauge manifold	Port size 1/2"-20UNF (5/16" Flare)	Evacuating, refrigerant charge, run check, etc.	○ Note 2	×
5	Charge hose	High-voltage		○	×
6	Vacuum pump	—	Vacuum drying	○ Note 3 1/2"-20UNF(5/16" Flare)	△ Connection diameter 1/4"
7	Vacuum pump adapter	—	Vacuum drying	○ Note 4 1/2"-20UNF(5/16" Flare)	△ Connection diameter 1/4"
8	Electronic balance for refrigerant charging	For 10 kg or 20 kg cylinder	Refrigerant charge	○	○
9	Leakage detector	—	Gas leakage check	○ Note 5	○ Note 5
10	Refrigerant cylinder	—	Refrigerant charge	× Note 6	×
11	Refrigerant recovery cylinder	Exclusive for R32	Refrigerant recovery container	× Note 7	×
12	Refrigerant recovery device	—	Refrigerant recovery device	○ Note 8	△ Connection diameter 1/4"

Note 1 When flaring is carried out for R32/R410A using the conventional flare tools, adjustment of projection margin is necessary. For this adjustment, a copper pipe gauge, etc. are necessary.

Note 2 When saturation temperature is described, the gauge manifold differs for R32/R410A .

If saturation temperature reading is required, special tools exclusive for R32 are required.

Note 3 Since R32 has a slight possibility of burning, be sure to use the tools corresponding to R32.

Note 4 Like R410, a Vacuum pump adapter needs installing to prevent a Vacuum pump oil (mineral oil) from flowing backward into the Charge hose. Mixing of the Vacuum pump oil into R32 refrigerant may cause a trouble such as generation of sludge, clogging of capillary, etc.

Note 5 Be sure to use those tools after confirming they correspond to each refrigerant.

Note 6 For a refrigerant cylinder exclusive for R32, the paint color (or label color) of the cylinder is set the specified color (light blue) together with the indication of the refrigerant name.

Note 7 Although the container specification is the same as R410A, use a recovering container exclusive for R32 to avoid mixing with other refrigerants.

Note 8 Be careful for miss-charging of the refrigerant during work. Miss-charging of the refrigerant type may cause not only damage of the equipments but also a fire etc.

General tools

In addition to the above exclusive tools, the following equipments are necessary as the general tools.

- | | |
|-----------------------|-----------------------------|
| 1) Pipe cutter | 6) Spanner or Monkey wrench |
| 2) Reamer | 7) Hole core drill |
| 3) Pipe bender | 8) Tape measure |
| 4) Level vial | 9) Metal saw |
| 5) Screwdriver (+, -) | |

Also prepare the following equipments for other installation method and run check.

- | | |
|----------------|--|
| 1) Clamp meter | 3) Insulation resistance tester (Megger) |
| 2) Thermometer | 4) Electroscop |

1. SPECIFICATIONS

1-1. Outdoor Unit

Model name	Outdoor unit		RAV-GM1601AT8P-E	RAV-GM1601AT8JP-E
Power supply		3 phase 380-415V 50Hz 3 phase 380V 60Hz (Power exclusive to outdoor is required.)		
Compressor	Type		Hermetic compressor	
	Motor	(kW)	3.75	
	Pole		4	
Refrigerant charged		(kg)	2.4	
Refrigerant control		Pulse motor valve		
Inter connecting pipe	Standard length		(m)	7.5
	Max. total length		(m)	50
	Additional refrigerant charge under long piping connector		35g/m (Over 30m)	
	Height difference	Outdoor lower	(m)	30
Outdoor higher		(m)	30	
Outer dimension	Height		(mm)	1340
	Width		(mm)	900
	Depth		(mm)	320
Appearance		Silky shade (Muncel 1Y8.5/0.5)		
Total weight		(kg)	94	
Heat exchanger		Finned tube		
Fan unit	Fan		Propeller fan	
	Standard air flow high		(m ³ /min.)	138
	Motor		(W)	100
Connecting pipe	Gas side		(mm)	15.9
	Liquid side		(mm)	9.52
Sound pressure level		Cooling/Heating (dB·A)	53/55	
Sound power level		Cooling/Heating (dB·A)	70/72	
Outside air temperature, Cooling		°C (Dry bulb temp.)	-15 to 46	
Outside air temperature, Heating		°C (Wet bulb temp.)	-15 to 15	

Model name	Outdoor unit	RAV-GM1601AT8P-TR
Power supply		3 phase 380-415V 50Hz 3 phase 380V 60Hz (Power exclusive to outdoor is required.)
Compressor	Type	Hermetic compressor
	Motor (kW)	3.75
	Pole	4
Refrigerant charged (kg)		2.4
Refrigerant control		Pulse motor valve
Inter connecting pipe	Standard length (m)	7.5
	Max. total length (m)	50
	Additional refrigerant charge under long piping connector	35g/m (Over 30m)
	Height difference	Outdoor lower (m)
Outdoor higher (m)		30
Outer dimension	Height (mm)	1340
	Width (mm)	900
	Depth (mm)	320
Appearance		Silky shade (Muncel 1Y8.5/0.5)
Total weight (kg)		91
Heat exchanger		Finned tube
Fan unit	Fan	Propeller fan
	Standard air flow high (m ³ /min.)	138
	Motor (W)	100
Connecting pipe	Gas side (mm)	15.9
	Liquid side (mm)	9.52
Sound pressure level	Cooling/Heating (dB·A)	53/55
Sound power level	Cooling/Heating (dB·A)	70/72
Outside air temperature, Cooling	°C (Dry bulb temp.)	-15 to 46
Outside air temperature, Heating	°C (Wet bulb temp.)	-15 to 15

1-2. Operation Characteristic Curve

- Operation Characteristic Curve

<Cooling>

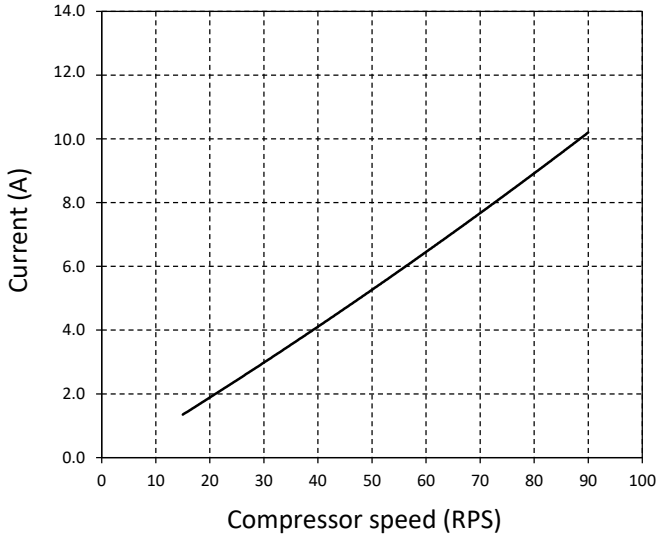

<Heating>

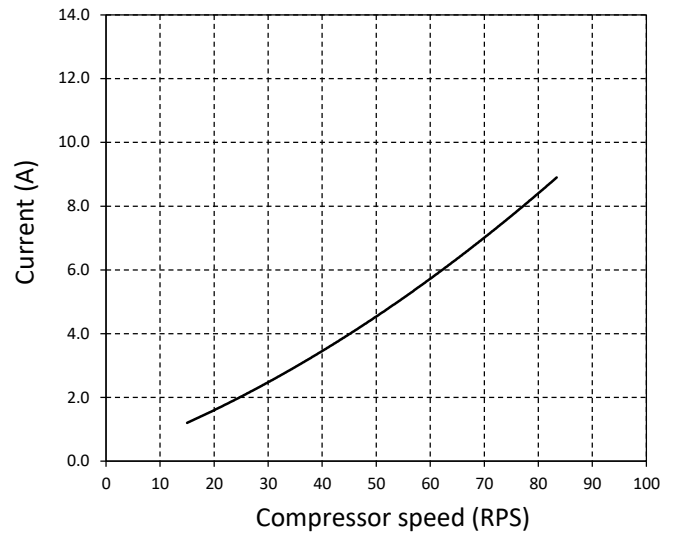

- Capacity variation ratio according to temperature

<Cooling>

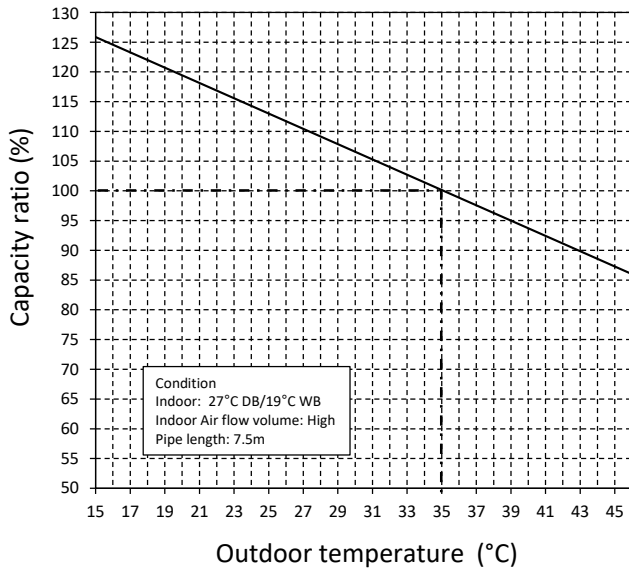

<Heating>

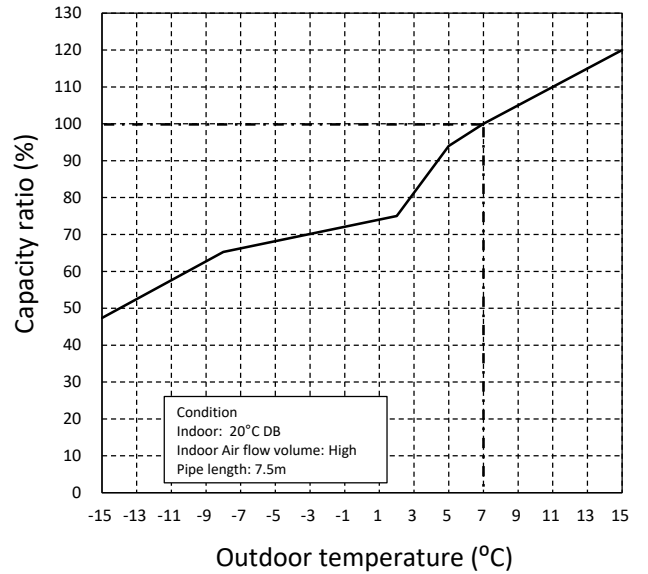

2. CONSTRUCTION VIEWS (EXTERNAL VIEWS)

Outdoor Unit

	Name	Note
①	Refrigerant piping hole Indoor/Outdoor Unit connecting wire inlet hole	—
②	Power supply inlet hole	dia.38 Knockout hole

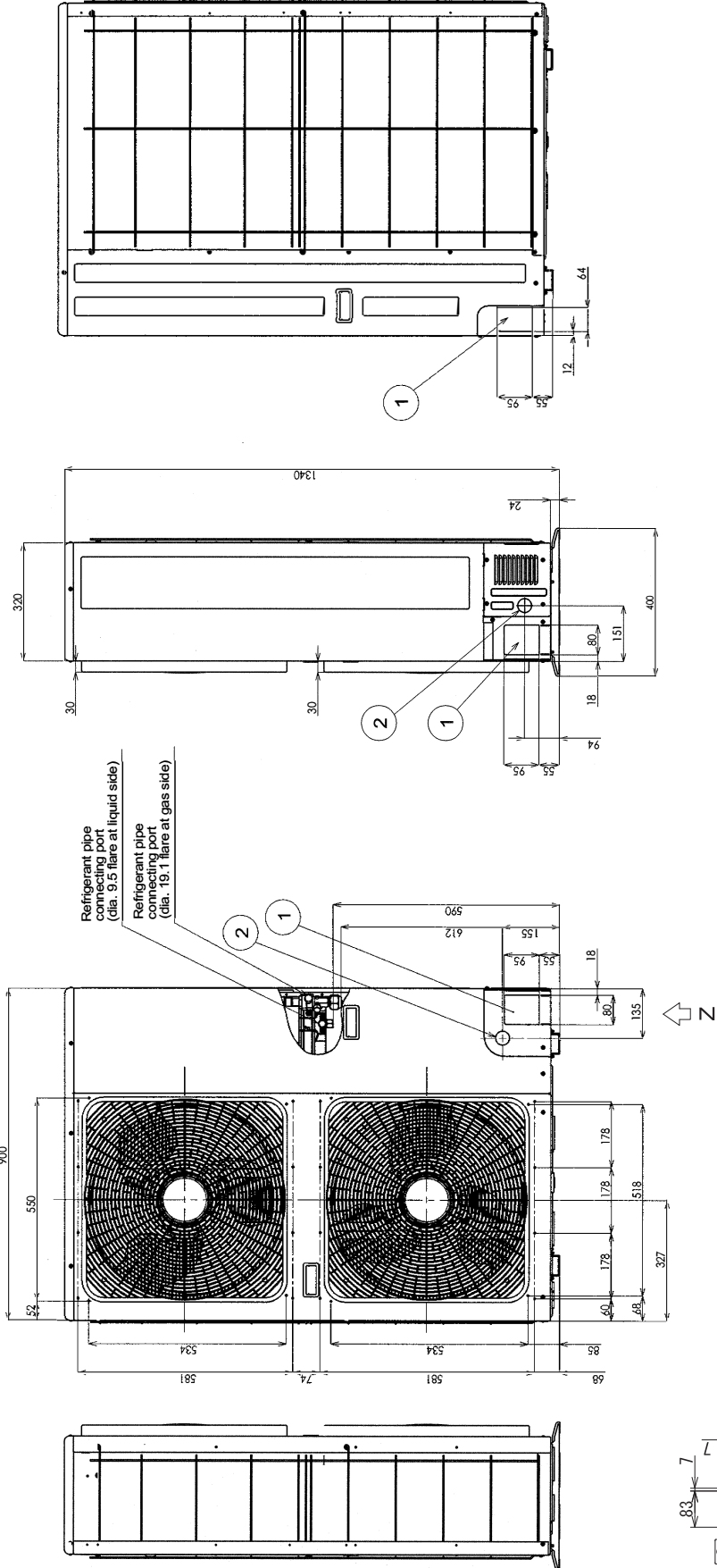
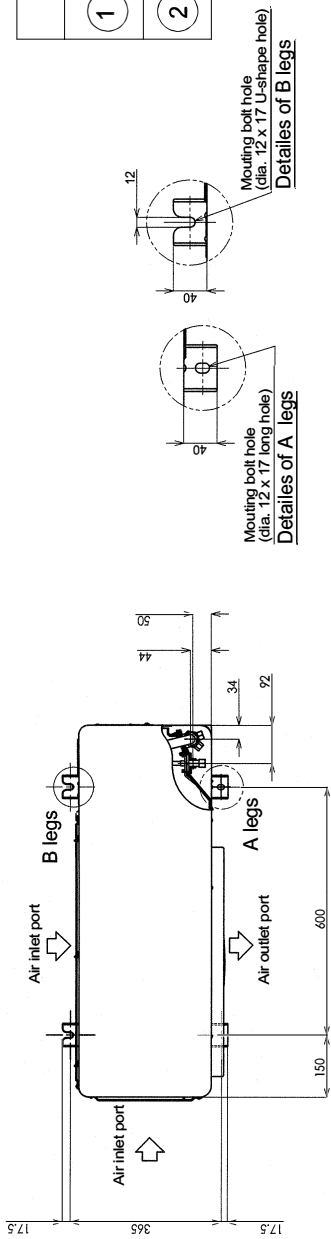

RAV-TWP30E2, RAV-TWP50E2 (Simultaneous Twin)

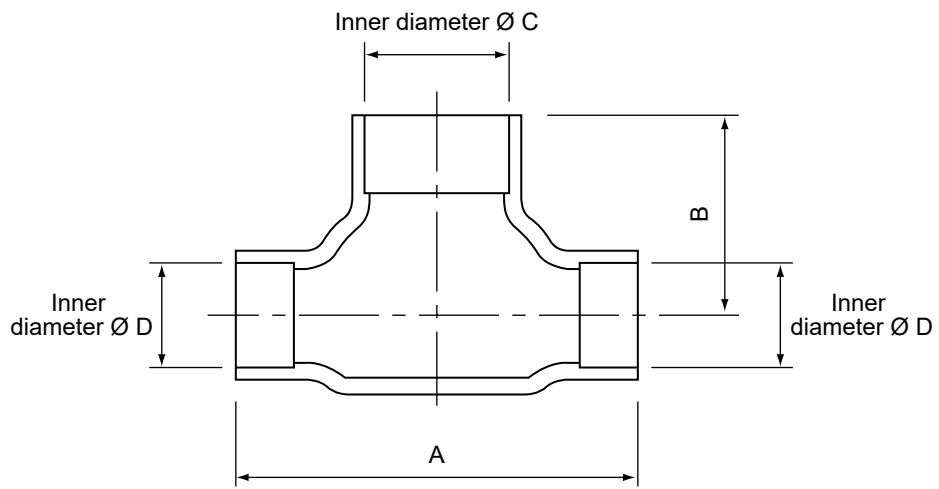

Model (RBC-)		A	B	C	D
TWP30E2	Liquid side	36	14	Ø9.5	Ø6.4
	Gas side	43	23	Ø15.9	Ø12.7
TWP50E2	Liquid side	34	14	Ø9.5	Ø9.5
	Gas side	44	21	Ø15.9	Ø15.9

RBC-TRP100E (Simultaneous Triple)

<Gas side>

Header assembly

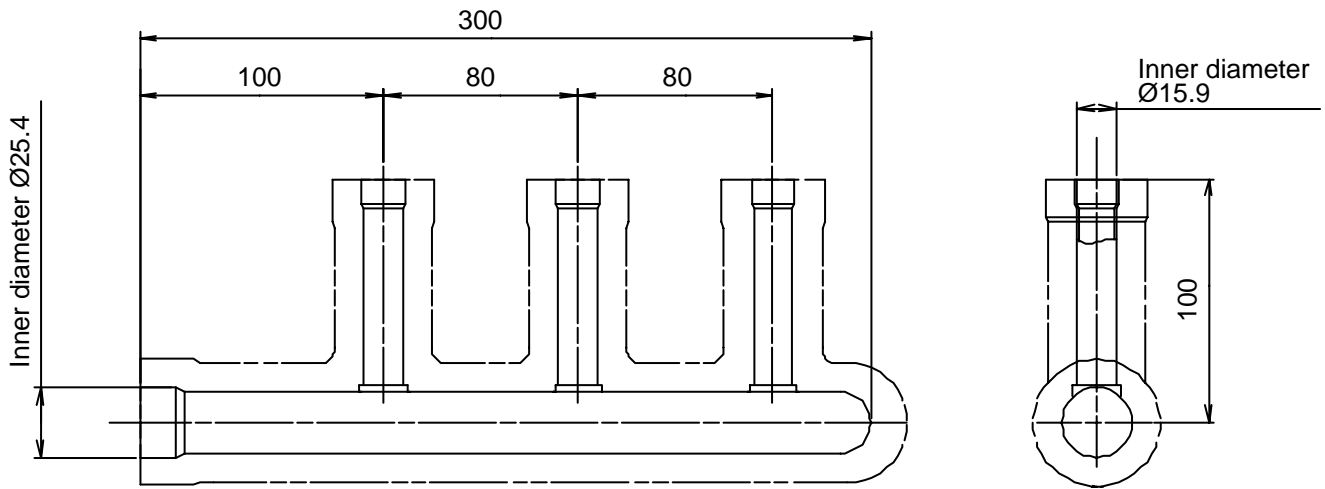

<Liquid side>

Branch pipe assembly

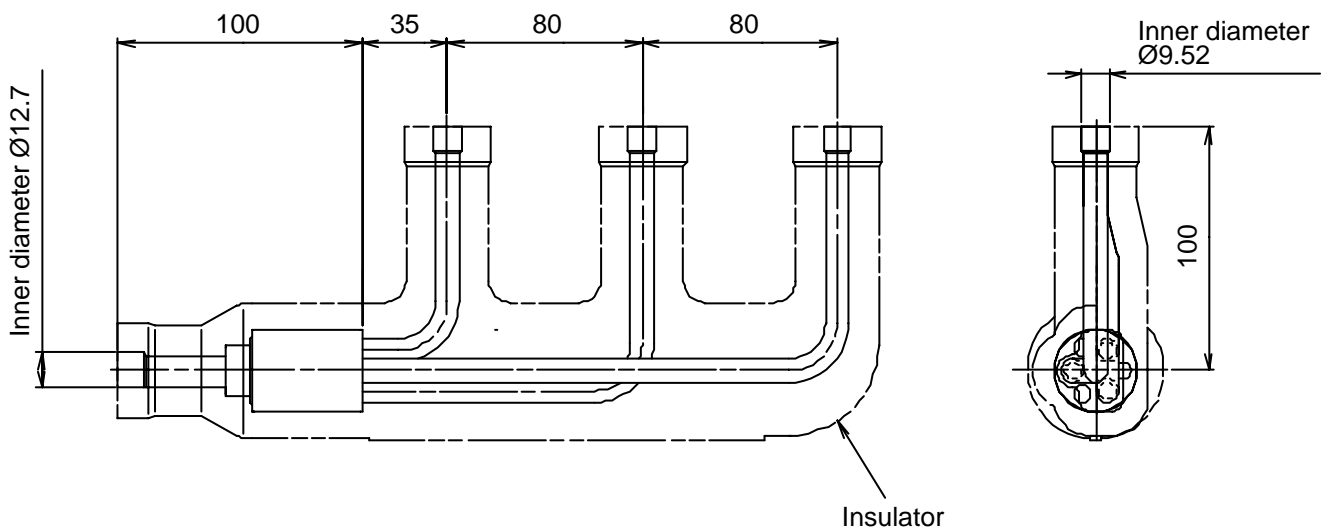

Gas side socket

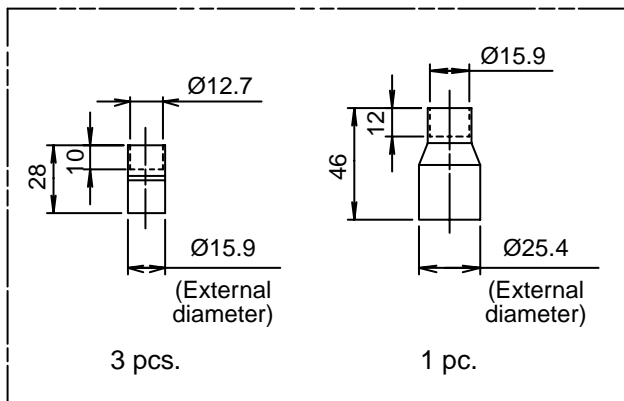

Liquid side socket

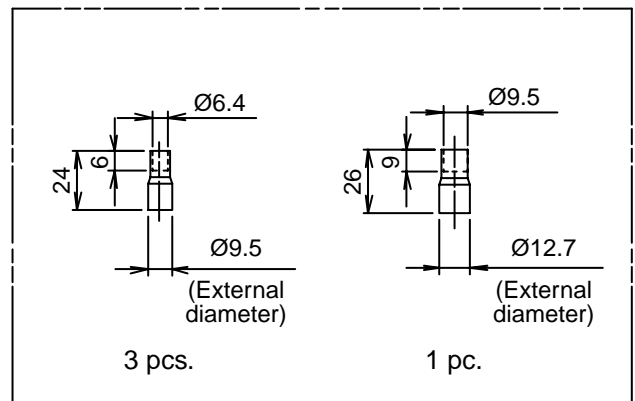

3. SYSTEMATIC REFRIGERATING CYCLE DIAGRAM

3-1. Indoor Unit

Single type (Combination of 1 indoor unit and 1 outdoor unit)

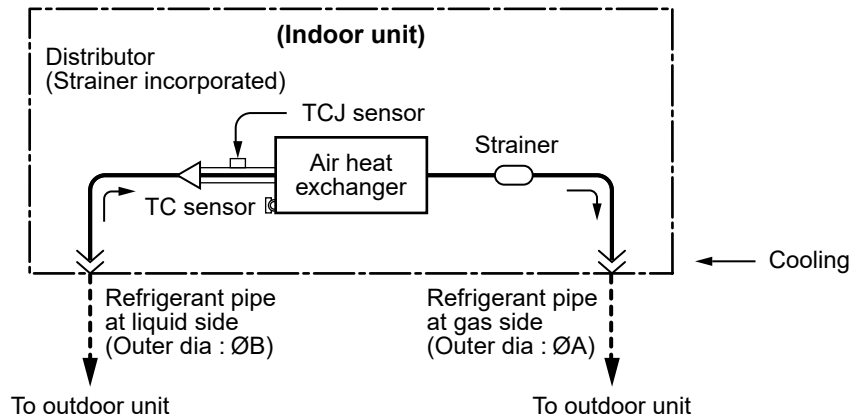

Twin type (Combination of two indoor units and one outdoor unit)

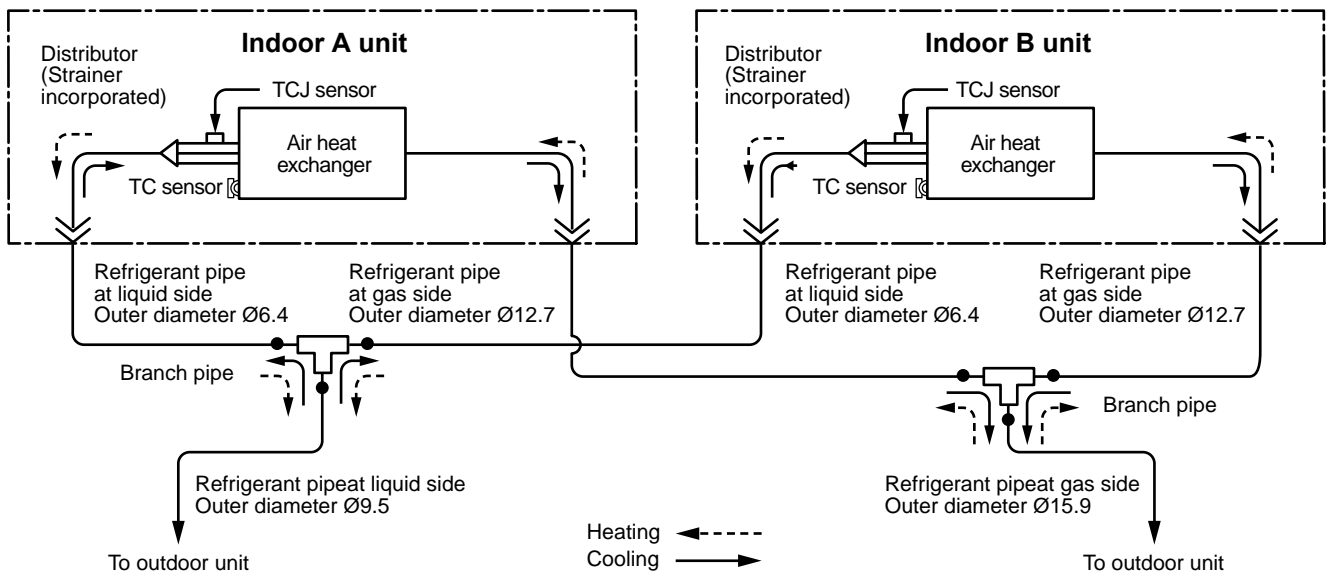

Triple type (Combination of three indoor units and one outdoor unit)

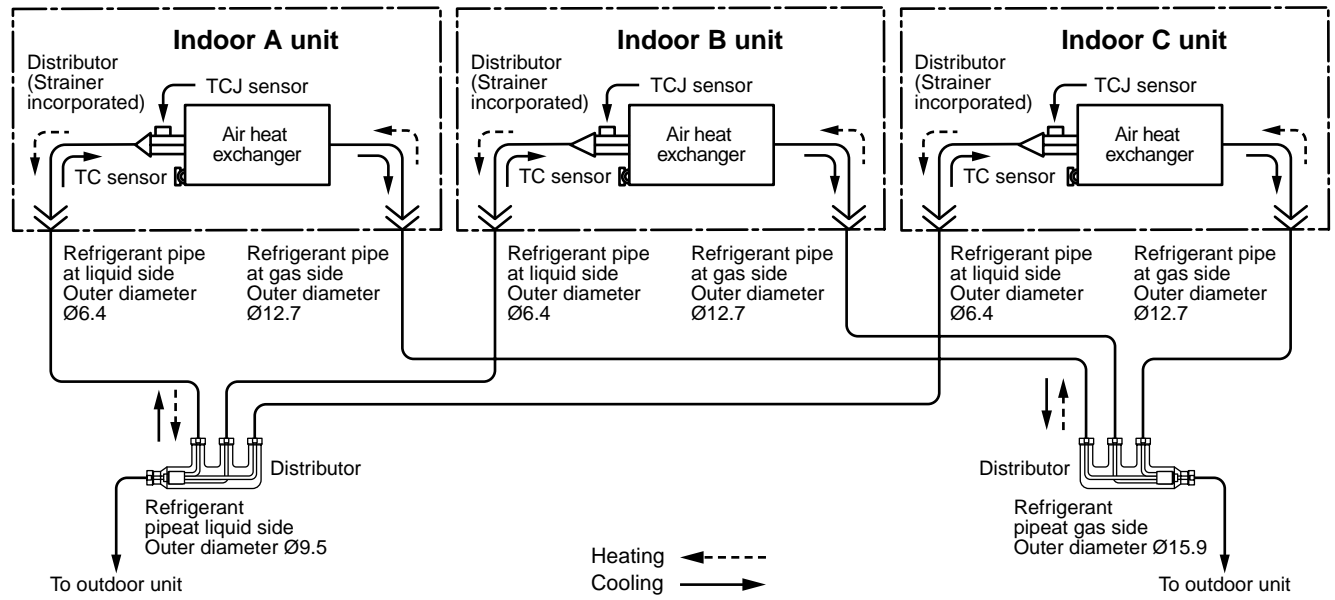

Dimension table

Outer diameter of refrigerant pipe	
Gas side ØA	Liquid side ØB
15.9	9.52

3-2. Outdoor Unit

REFRIGERATING CYCLE DIAGRAM

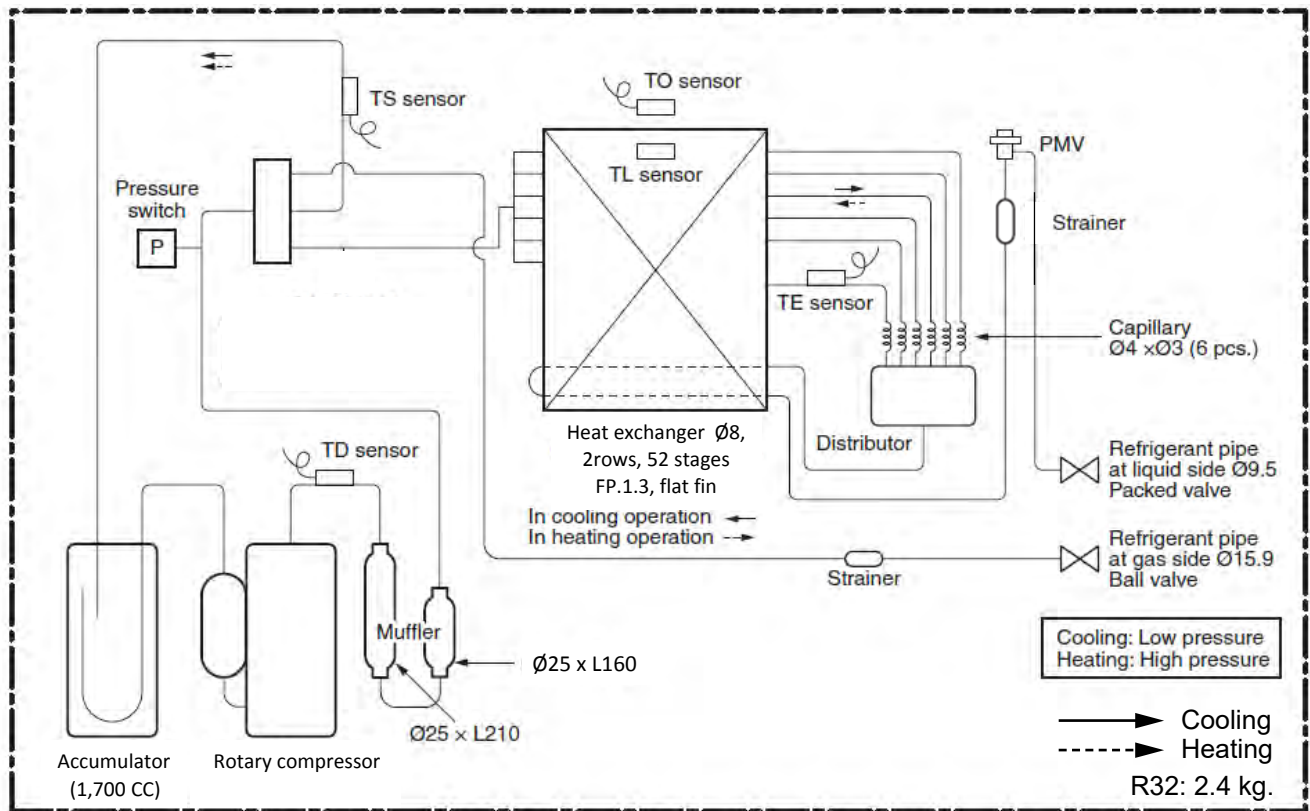

3-3. Operation data

		Pressure				Pipe surface temperature (°C)				Comp. Hz	Fan	Temp	
		(MPa)		(kg/cm ² G)		(TD)	(TS)	(TC)	(TE)			In	Out
		Pd	Ps	Pd	Ps								
Cooling	Standard	2.86	0.85	29.2	8.7	91	8	8	39	68	HIGH	27/19	35/-
	Overload	3.40	0.97	34.7	9.9	82	12	15	54	67	HIGH	32/23	46/-
	Low load	2.92	0.74	29.8	7.5	66	3	4	47	30	LOW	18/13	-15/-
Heating	Standard	2.97	0.63	50.3	6.4	88	1	49	3	68	HIGH	20/-	7/6
	Overload	3.10	1.12	30.6	11.4	86	19	52	16	27	LOW	27/-	24/18
	Low load	2.22	0.26	22.6	2.6	84	-18	36	-17	81	HIGH	15/-	-15/-

* 4 poles are provided to this compressor.

The compressor frequency (Hz) measured with a clamp meter is 2 times of revolutions (rps) of the compressor.

4. WIRING DIAGRAM

Outdoor Unit

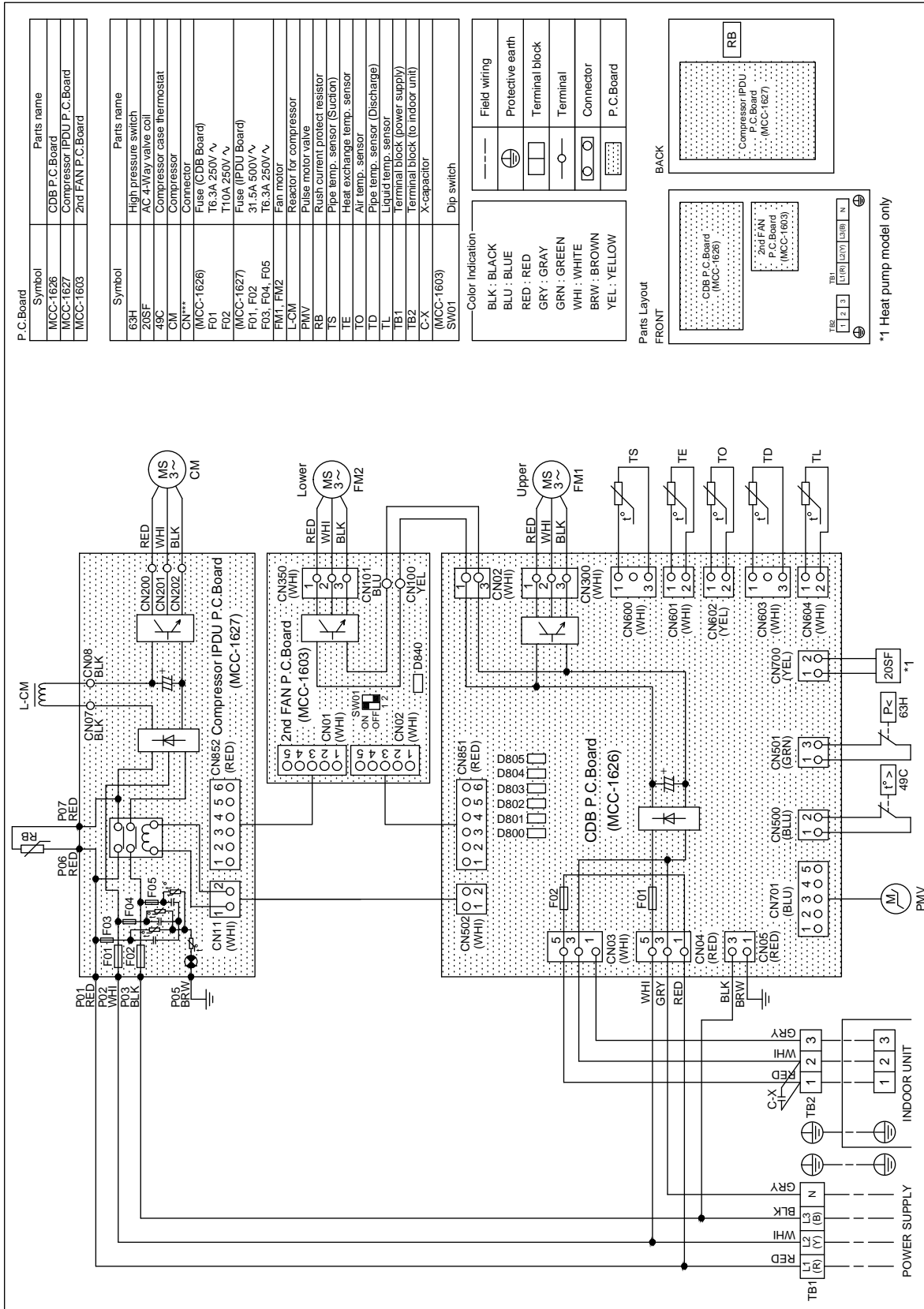

5. SPECIFICATIONS OF ELECTRICAL PARTS

Outdoor Unit

No.	Parts name	Type	Specifications	Q'ty
1	Compressor	RX380A2T-20M	4P, 3750W	1
2	Outdoor fan motor	ICF-280-A100-1	Output 100W	2
3	High pressure switch	ACB-4UB166W	ON : 3.5MPa, OFF : 4.5MPa	1
4	PMV-Coil	CAM-MD12TCTH-8	DC12V	1
5	Reactor	CH-86-2Z-T	5.46 - 6.14mH, 18.5A	1
6	P.C.board for control and 1 st fan motor drive (Upper)	MCC-1626	—	1
7	P.C.board for compressor drive	MCC-1627	—	1
8	P.C.board for 2 nd fan motor drive (Lower)	MCC-1603	—	1
9	Outdoor temp. sensor (TO sensor)	—	10 kΩ at 25°C	1
10	Discharge temp. sensor (TD sensor)	—	50 kΩ at 25°C	1
11	Suction temp. sensor (TS sensor)	—	10 kΩ at 25°C	1
12	Heat exchanger sensor (TE sensor)	—	10 kΩ at 25°C	1
13	Heat exchanger temp. sensor (TL sensor)	—	50 kΩ at 25°C	1
14	Fuse (Mounted on P.C.board, MCC-1626)	50T 100H	T10A, 250V	1
15	Fuse (Mounted on P.C.board, MCC-1626)	SLT6.3A	T6.3A, 250V	1
16	Fuse (Mounted on P.C.board, MCC-1626)	SCT 3.15A	3.15A, 250V	1
17	Fuse (Mounted on P.C.board, MCC-1627)	50T(P) 063HF GF_001 C4	T6.3A, 250V	3
18	Fuse (Mounted on P.C.board, MCC-1627)	GAC1 31.5A	31.5A, 500V	2
19	Fuse (Mounted on P.C.board, MCC-1603)	SCT 3.15A	3.15A, 250V	1
20	PTC Thermistor	MZ32-101RMARD01E	100Ω, 500V	1

6. REFRIGERANT R32

This air conditioner adopted the R32 refrigerant which does not damage the ozone layer.

The working pressure of the refrigerant R32 is 1.6 times higher than conventional refrigerant (R22). The refrigerating oil is also changed in accordance with change of refrigerant, so be careful that water, dust, and existing refrigerant or refrigerating oil are not entered in the refrigerant cycle of the air conditioner using the new refrigerant during installation work or servicing time.

The next section describes the precautions for air conditioner using the new refrigerant.

Conforming to contents of the next section together with the general cautions included in this manual, perform the correct and safe work.

6-1. Safety During Installation/Servicing

As R32's pressure is about 1.6 times higher than that of R22, improper installation/servicing may cause a serious trouble. By using tools and materials exclusive for R32, it is necessary to carry out installation/servicing safely while taking the following precautions into consideration.

1. Never use refrigerant other than R32 in an air conditioner which is designed to operate with R32.
If other refrigerant than R32 is mixed, pressure in the refrigeration cycle becomes abnormally high, and it may cause personal injury, etc. by a rupture.
2. Confirm the used refrigerant name, and use tools and materials exclusive for the refrigerant R32. The refrigerant name R32 is indicated on the visible place of the outdoor unit of the air conditioner using R32 as refrigerant.
A diameter of charge port for R32 is the same as that of the R410's. Be careful not to charge the refrigerant by mistake.
3. If a refrigeration gas leakage occurs during installation/servicing, be sure to ventilate fully. If the refrigerant gas comes into contact with fire, a poisonous gas may occur.
4. When installing or removing an air conditioner, do not allow air or moisture to remain in the refrigeration cycle.
Otherwise, pressure in the refrigeration cycle may become abnormally high so that a rupture or personal injury may be caused.
5. After completion of installation work, check to make sure that there is no refrigeration gas leakage.
If the refrigerant gas leaks into the room, coming into contact with fire in the fan-driven heater, space heater, etc., a poisonous gas may occur.

6. When an air conditioning system charged with a large volume of refrigerant is installed in a small room, it is necessary to exercise care so that, even when refrigerant leaks, its concentration does not exceed the marginal level.
If the refrigerant gas leakage occurs and its concentration exceeds the marginal level, an oxygen starvation accident may result.
7. Be sure to carry out installation or removal according to the installation manual.
Improper installation may cause refrigeration trouble, water leakage, electric shock, fire, etc.
8. Unauthorized modifications to the air conditioner may be dangerous. If a breakdown occurs please call a qualified air conditioner technician or electrician.
Improper repair may result in water leakage, electric shock and fire, etc.

6-2. Refrigerant Piping Installation

6-2-1. Piping Materials and Joints Used

For the refrigerant piping installation, copper pipes and joints are mainly used.

Copper pipes and joints suitable for the refrigerant must be chosen and installed.

Furthermore, it is necessary to use clean copper pipes and joints whose interior surfaces are less affected by contaminants.

1. Copper Pipes

It is necessary to use seamless copper pipes which are made of either copper or copper alloy and it is desirable that the amount of residual oil is less than 40 mg/10 m.

Do not use copper pipes having a collapsed, deformed or discolored portion (especially on the interior surface).

Otherwise, the expansion valve or capillary tube may become blocked with contaminants.

As an air conditioner using R32 incurs pressure higher than when using R22, it is necessary to choose adequate materials.

Thicknesses of copper pipes used with R32 are as shown in Table 6-2-1. Never use copper pipes thinner than 0.8mm even when it is available on the market.

NOTE:

Refer to the "6-6. Instructions for Re-use Piping of R22 or R407C".

Table 6-2-1 Thicknesses of annealed copper pipes

		Thickness (mm)	
Nominal diameter	Outer diameter (mm)	R410A	R22
1/4	6.4	0.80	0.80
3/8	9.5	0.80	0.80
1/2	12.7	0.80	0.80
5/8	15.9	1.00	1.00
3/4	19.1	1.00	1.00

1. Joints

For copper pipes, flare joints or socket joints are used. Prior to use, be sure to remove all contaminants.

a) Flare Joints

Flare joints used to connect the copper pipes cannot be used for pipings whose outer diameter exceeds 20 mm. In such a case, socket joints can be used.

Sizes of flare pipe ends, flare joint ends and flare nuts are as shown in Tables 6-2-3 to 6-2-5 below.

b) Socket Joints

Socket joints are such that they are brazed for connections, and used mainly for thick pipings whose diameter is larger than 20 mm. Thicknesses of socket joints are as shown in Table 6-2-2.

Table 6-2-2 Minimum thicknesses of socket joints

Nominal diameter	Reference outer diameter of copper pipe jointed (mm)	Minimum joint thickness (mm)
1/4	6.4	0.5
3/8	9.5	0.60
1/2	12.7	0.70
5/8	15.9	0.80
3/4	19.1	0.80

6-2-2. Processing of Piping Materials

When performing the refrigerant piping installation, care should be taken to ensure that water or dust does not enter the pipe interior, that no other oil other than lubricating oils used in the installed air conditioner is used, and that refrigerant does not leak. When using lubricating oils in the piping processing, use such lubricating oils whose water content has been removed. When stored, be sure to seal the container with an airtight cap or any other cover.

1. Flare Processing Procedures and Precautions

a) Cutting the Pipe

By means of a pipe cutter, slowly cut the pipe so that it is not deformed.

b) Removing Burrs and Chips

If the flared section has chips or burrs, refrigerant leakage may occur.

Carefully remove all burrs and clean the cut surface before installation.

c) Insertion of Flare Nut

d) Flare Processing

Make certain that a clamp bar and copper pipe have been cleaned.

By means of the clamp bar, perform the flare processing correctly.

Use either a flare tool for R410A/R32 or conventional flare tool. Flare processing dimensions differ according to the type of flare tool.

When using a conventional flare tool, be sure to secure "dimension A" by using a gauge for size adjustment.

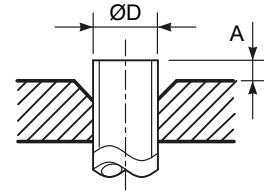

Fig. 6-2-1 Flare processing dimensions

Table 6-2-3 Dimensions related to flare processing for R410A or R32 / R22

Nominal diameter	Outer diameter (mm)	Thickness (mm)	A (mm)				
			Flare tool for R410A, R22 clutch type	Conventional flare tool (R410A or R32)		Conventional flare tool (R22)	
				Clutch type	Wing nut type	Clutch type	Wing nut type
1/4	6.4	0.8	0 to 0.5	1.0 to 1.5	1.5 to 2.0	0.5 to 1.0	1.0 to 1.5
3/8	9.5	0.8	0 to 0.5	1.0 to 1.5	1.5 to 2.0	0.5 to 1.0	1.0 to 1.5
1/2	12.7	0.8	0 to 0.5	1.0 to 1.5	2.0 to 2.5	0.5 to 1.0	1.5 to 2.0
5/8	15.9	1.0	0 to 0.5	1.0 to 1.5	2.0 to 2.5	0.5 to 1.0	1.5 to 2.0
3/4	19.1	1.2	0 to 0.5	1.0 to 1.5	2.0 to 2.5	—	—

Table 6-2-4 Flare and flare nut dimensions for R410A or R32

Nominal diameter	Outer diameter (mm)	Thickness (mm)	Dimension (mm)				Flare nut width (mm)
			A	B	C	D	
1/4	6.4	0.8	9.1	9.2	6.5	13	17
3/8	9.5	0.8	13.2	13.5	9.7	20	22
1/2	12.7	0.8	16.6	16.0	12.9	23	26
5/8	15.9	1.0	19.7	19.0	16.0	25	29
3/4	19.1	1.2	24.0	—	19.2	28	36

Table 6-2-5 Flare and flare nut dimensions for R22

Nominal diameter	Outer diameter (mm)	Thickness (mm)	Dimension (mm)				Flare nut width (mm)
			A	B	C	D	
1/4	6.4	0.8	9.1	9.2	6.5	13	17
3/8	9.5	0.8	13.0	13.5	9.7	20	22
1/2	12.7	0.8	16.2	16.0	12.9	20	24
5/8	15.9	1.0	19.4	19.0	16.0	23	27
3/4	19.1	1.0	23.3	24.0	19.2	34	36

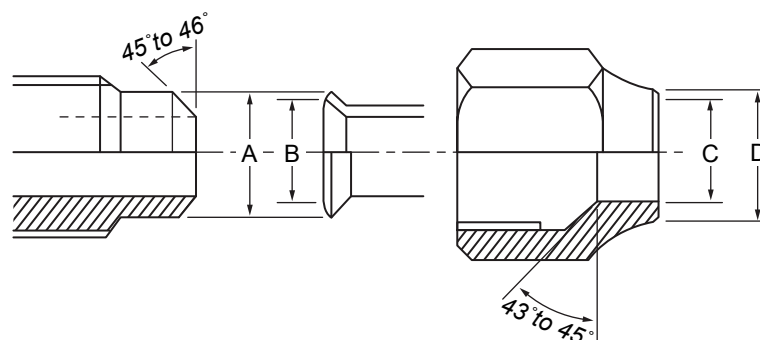

Fig. 6-2-2 Relations between flare nut and flare seal surface

2. Flare Connecting Procedures and Precautions

- a) Make sure that the flare and union portions do not have any scar or dust, etc.
- b) Correctly align the processed flare surface with the union axis.
- c) Tighten the flare with designated torque by means of a torque wrench.
The tightening torque for R410A or R32 is the same as that for conventional R22.
Incidentally, when the torque is weak, the gas leakage may occur.
When it is strong, the flare nut may crack and may be made non-removable.
When choosing the tightening torque, comply with values designated by manufacturers.
Table 6-2-6 shows reference values.

NOTE

When applying oil to the flare surface, be sure to use oil designated by the manufacturer.
If any other oil is used, the lubricating oils may deteriorate and cause the compressor to burn out.

Table 6-2-6 Tightening torque of flare for R410A or R32 [Reference values]

Nominal diameter	Outer diameter (mm)	Tightening torque N•m (kgf•m)	Tightening torque of torque wrenches available on the market N•m (kgf•m)
1/4	6.4	14 to 18 (1.4 to 1.8)	16 (1.6), 18 (1.8)
3/8	9.5	33 to 42 (3.3 to 4.2)	42 (4.2)
1/2	12.7	50 to 62 (5.0 to 6.2)	55 (5.5)
5/8	15.9	68 to 82 (6.8 to 8.2)	65 (6.5)
3/4	19.1	100 to 120 (10.0 to 12.0)	—

6-3. Tools

6-3-1. Required Tools

Refer to the “4. Tools”

6-4. Recharging of Refrigerant

When it is necessary to recharge refrigerant, charge the specified amount of new refrigerant according to the following steps.

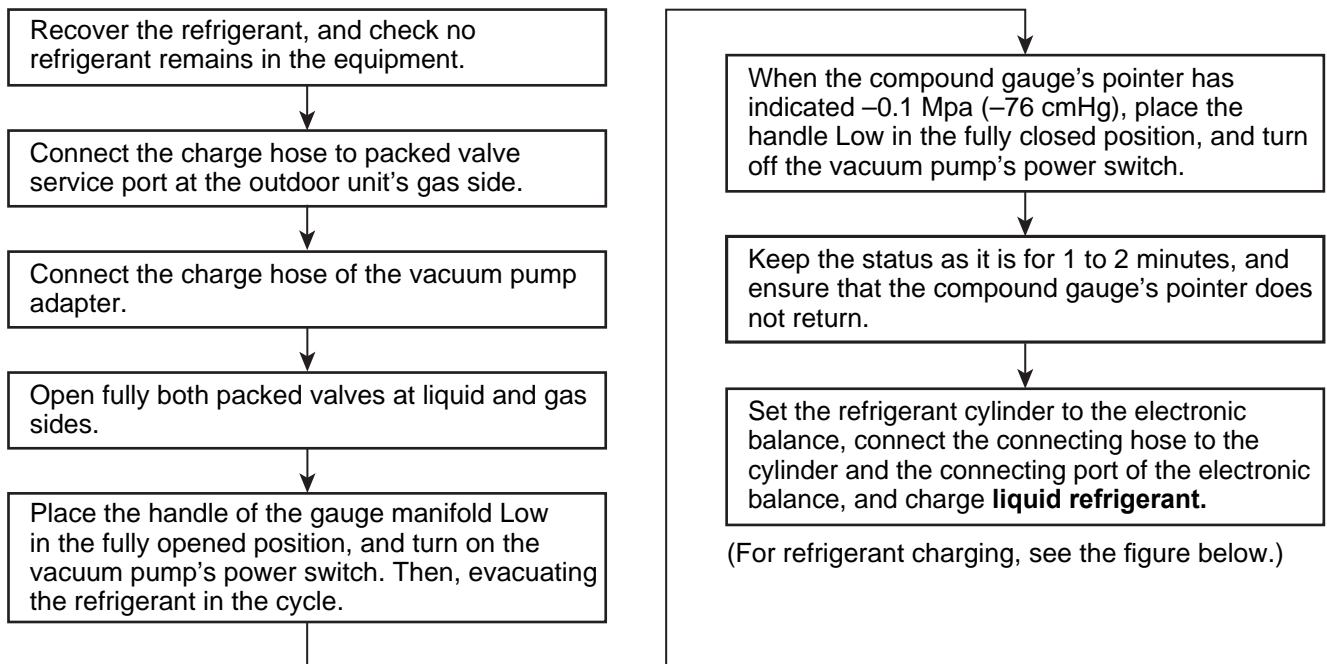

- 1) Never charge refrigerant exceeding the specified amount.
- 2) If the specified amount of refrigerant cannot be charged, charge refrigerant **bit by bit** in COOL mode.
- 3) Do not carry out additional charging.
When additional charging is carried out if refrigerant leaks, the refrigerant composition changes in the refrigeration cycle, that is characteristics of the air conditioner changes, refrigerant exceeding the specified amount is charged, and working pressure in the refrigeration cycle becomes abnormally high pressure, and may cause a rupture or personal injury.

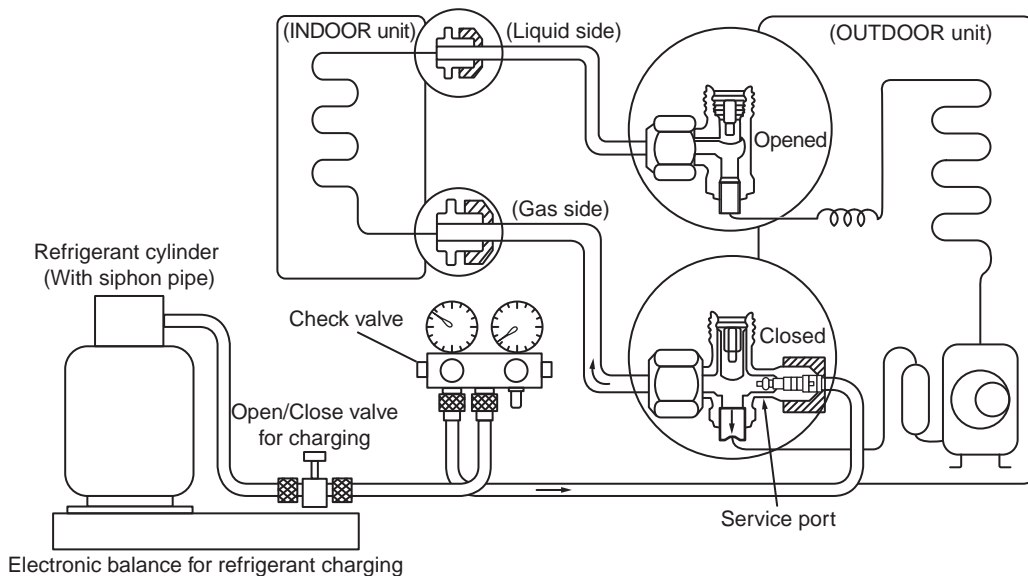

Fig. 6-4-1 Configuration of refrigerant charging

6-5. Brazing of Pipes

6-5-1. Materials for Brazing

1. Silver brazing filler

Silver brazing filler is an alloy mainly composed of silver and copper.

It is used to join iron, copper or copper alloy, and is relatively expensive though it excels in solderability.

2. Phosphor bronze brazing filler

Phosphor bronze brazing filler is generally used to join copper or copper alloy.

3. Low temperature brazing filler

Low temperature brazing filler is generally called solder, and is an alloy of tin and lead.

Since it is weak in adhesive strength, do not use it for refrigerant pipes.

- 1) Phosphor bronze brazing filler tends to react with sulfur and produce a fragile compound water solution, which may cause a gas leakage. Therefore, use any other type of brazing filler at a hot spring resort, etc., and coat the surface with a paint.
- 2) When performing brazing again at time of servicing, use the same type of brazing filler.

6-5-2. Flux

1. Reason why flux is necessary

- By removing the oxide film and any foreign matter on the metal surface, it assists the flow of brazing filler.
- In the brazing process, it prevents the metal surface from being oxidized.
- By reducing the brazing filler's surface tension, the brazing filler adheres better to the treated metal.

2. Characteristics required for flux

- Activated temperature of flux coincides with the brazing temperature.
- Due to a wide effective temperature range, flux is hard to carbonize.
- It is easy to remove slag after brazing.
- The corrosive action to the treated metal and brazing filler is minimum.
- It excels in coating performance and is harmless to the human body.

As the flux works in a complicated manner as described above, it is necessary to select an adequate type of flux according to the type and shape of treated metal, type of brazing filler and brazing method, etc.

3. Types of flux

• Noncorrosive flux

Generally, it is a compound of borax and boric acid.

It is effective in case where the brazing temperature is higher than 800°C.

• Activated flux

Most of fluxes generally used for silver brazing are this type.

It features an increased oxide film removing capability due to the addition of compounds such as potassium fluoride, potassium chloride and sodium fluoride to the borax-boric acid compound.

4. Piping materials for brazing and used brazing filler/flux

Piping material	Used brazing filler	Used flux
Copper - Copper	Phosphor copper	Do not use
Copper - Iron	Silver	Paste flux
Iron - Iron	Silver	Vapor flux

- 1) Do not enter flux into the refrigeration cycle.
- 2) When chlorine contained in the flux remains within the pipe, the lubricating oil deteriorates. Therefore, use a flux which does not contain chlorine.
- 3) When adding water to the flux, use water which does not contain chlorine (e.g. distilled water or ion-exchange water).
- 4) Remove the flux after brazing.

6-5-3. Brazing

As brazing work requires sophisticated techniques, experiences based upon a theoretical knowledge, it must be performed by a person qualified.

In order to prevent the oxide film from occurring in the pipe interior during brazing, it is effective to proceed with brazing while letting dry Nitrogen gas flow.

Never use gas other than Nitrogen gas.

1. Brazing method to prevent oxidation

- 1) Attach a reducing valve and a flow-meter to the Nitrogen gas cylinder.
- 2) Use a copper pipe to direct the piping material, and attach a flow-meter to the cylinder.
- 3) Apply a seal onto the clearance between the piping material and inserted copper pipe for Nitrogen in order to prevent backflow of the Nitrogen gas.
- 4) When the Nitrogen gas is flowing, be sure to keep the piping end open.
- 5) Adjust the flow rate of Nitrogen gas so that it is lower than $0.05 \text{ m}^3/\text{Hr}$ or 0.02 MPa (0.2 kgf/cm^2) by means of the reducing valve.
- 6) After performing the steps above, keep the Nitrogen gas flowing until the pipe cools down to a certain extent (temperature at which pipes are touchable with hands).
- 7) Remove the flux completely after brazing.

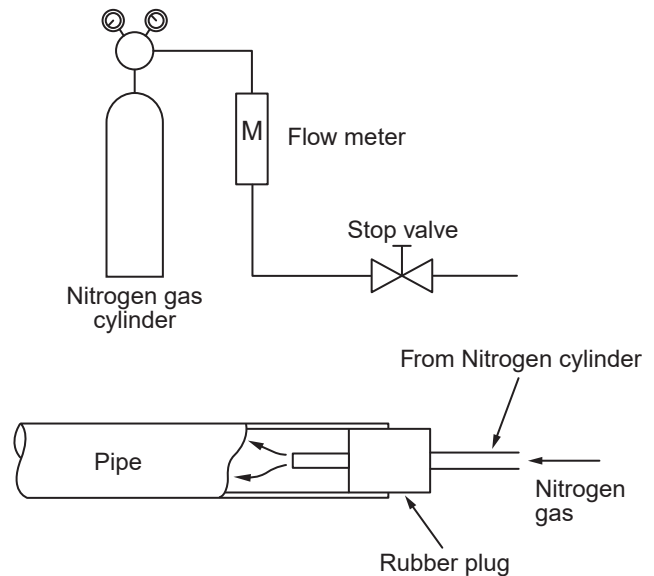

Fig. 6-5-1 Prevention of oxidation during brazing

6-6. Instructions for Re-use Piping of R22 or R410A

Instruction of Works:

The existing R22 and R410A piping can be reused for our super digital inverter R32 products installations.

WARNING

Confirming the existence of scratches or dents on the existing pipes and confirming the reliability of the pipe strength are conventionally referred to the local site.

If the specified conditions can be cleared, it is possible to update existing R22 and R410A pipes to those for R32 models.

6-6-1. Basic conditions needed to reuse existing pipes

Check and observe the presence of three conditions in the refrigerant piping works.

1. **Dry** (There is no moisture inside of the pipes.)
2. **Clean** (There is no dust inside of the pipes.)
3. **Tight** (There are no refrigerant leaks.)

6-6-2. Restrictions for use of existing pipes

In the following cases, the existing pipes should not be reused as they are. Clean the existing pipes or exchange them with new pipes.

1. When a scratch or dent is heavy, be sure to use new pipes for the refrigerant piping works.
2. When the existing pipe thickness is thinner than the specified "Pipe diameter and thickness," be sure to use new pipes for the refrigerant piping works.
 - The operating pressure of R32 is high. If there is a scratch or dent on the pipe or a thinner pipe is used, the pressure strength may be inadequate, which may cause the pipe to break in the worst case.

* Pipe diameter and thickness (mm)

Reference outside diameter (mm)	Wall thickness (mm)	Material
6.4	0.8	—
9.5	0.8	—
12.7	0.8	—
15.9	1.0	—
19.1	1.0	—

- In case the pipe diameter is $\varnothing 12.7$ mm or less and the thickness is less than 0.7 mm, be sure to use new pipes for the refrigerant piping works.

3. When the outdoor unit was left with the pipes disconnected, or the gas leaked from the pipes and the pipes were not repaired and refilled.

- There is the possibility of rain water or air, including moisture, entering the pipe.

4. When refrigerant cannot be recovered using a refrigerant recovery unit.

- There is the possibility that a large quantity of dirty oil or moisture remains inside the pipes.

5. When a commercially available dryer is attached to the existing pipes.

There is the possibility that copper green rust has been generated.

6. When the existing air conditioner is removed after refrigerant has been recovered.

Check if the oil is judged to be clearly different from normal oil.

- The refrigerator oil is copper rust green in color: There is the possibility that moisture has mixed with the oil and rust has been generated inside the pipe.
- There is discolored oil, a large quantity of residue, or a bad smell.

A large quantity of shiny metal dust or other wear

7. When the air conditioner has a history of the compressor failing and being replaced.

- When discolored oil, a large quantity of residue, of foreign matter is observed, trouble will occur.

8. When temporary installation and removal of the air conditioner are repeated such as when leased, etc.

9. If the type of refrigerator oil of the existing air conditioner is other than the following oil (Mineral oil), Suniso, Freol-S, MS (Synthetic oil), alkyl benzene (HAB, Barrel-freeze), ester series, PVE only of ether series.

The winding-insulation of the compressor may deteriorate.

NOTE

The above descriptions are results have been confirmed by our company and represent our views on our air conditioners, but do not guarantee the use of the existing pipes of air conditioners that have adopted R32 or R410A in other companies.

6-6-3. Branching pipe for simultaneous operation system

In the concurrent twin triple system, when TOSHIBA has specified that branching pipe is to be used, it can be reused. Branching pipe model name:

RBC-TWP30E, RBC-TWP50E, RBC-TRP100E

On the existing air conditioner for simultaneous operation system (twin system), there are cases of branch pipes being used that have insufficient compressive strength. In such case, please change the piping to a branch pipe for R32 or R410A.

6-6-4. Curing of pipes

When removing and opening the indoor or outdoor unit for a long time, cure the pipes as follows

- Otherwise rust may be generated when moisture or foreign matter due to condensation enters the pipes.
- The rust cannot be removed by cleaning, and new pipes are necessary.

Placement location	Term	Curing manner
Outdoors	1 month or more	Pinching
	Less than 1 month	Pinching or Taping
Indoors	Every time	

6-6-5. Final Installation Checks

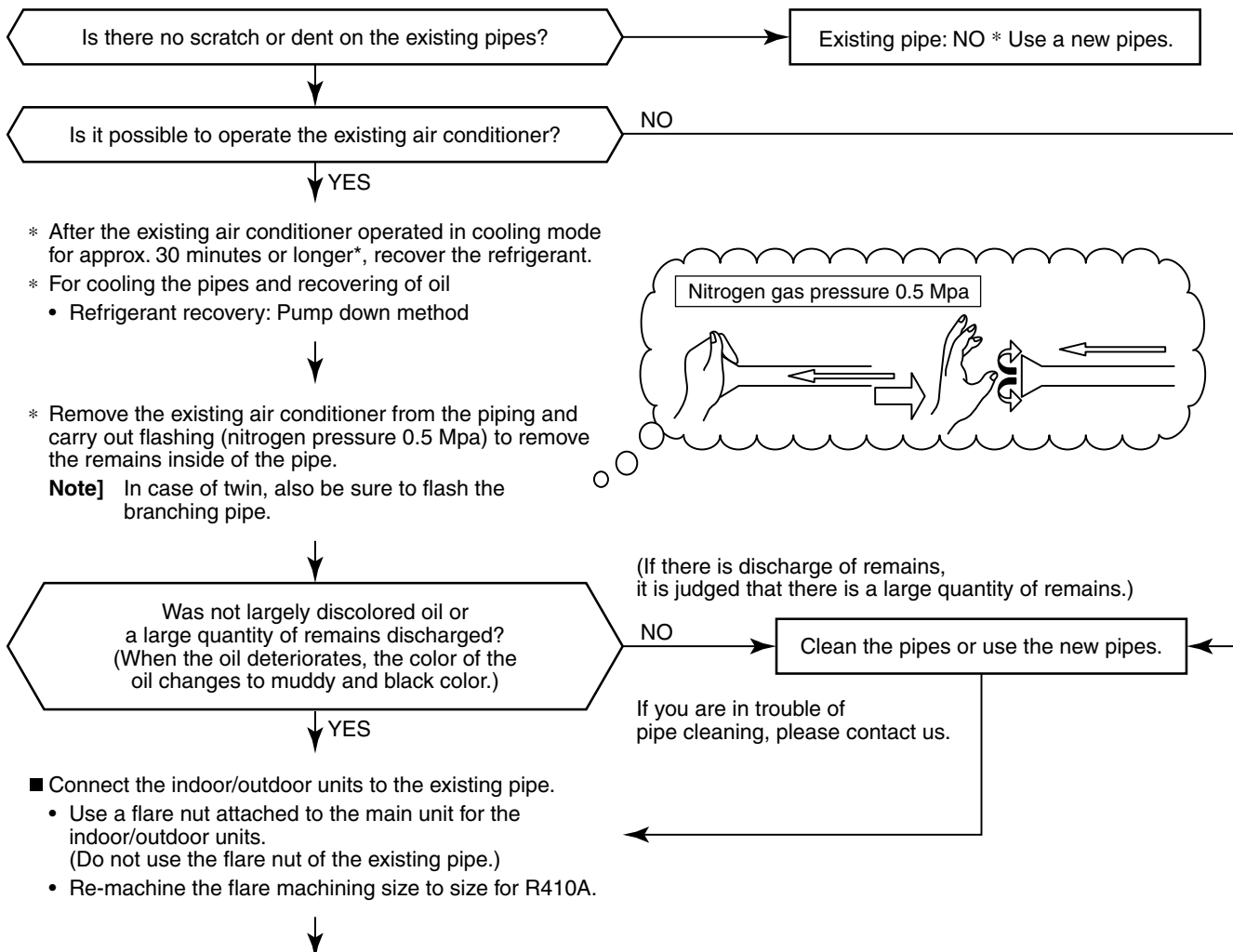

Existing piping

The following settings are required when using a pipe $\varnothing 19.1$ mm as the existing piping at the gas pipe side.

Steps taken to support existing piping

1. Cut J805 (Jumper).
2. Set the circuit breaker to the ON position to turn on the power.

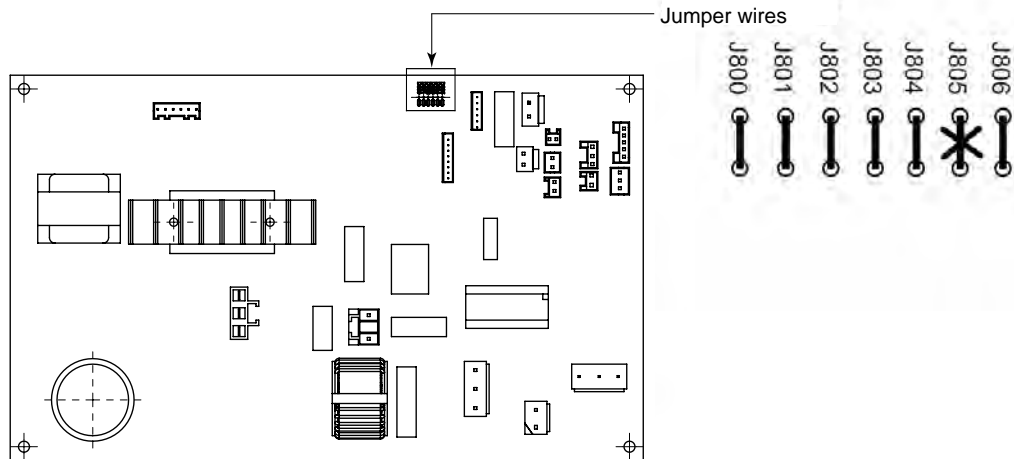

* (Airtight test), Vacuum dry, Refrigerant charge,
Gas leak check

Trial run

Piping necessary to change the flare nut/ machining size due to pipe compression.

1) Flare nut width: H (mm)

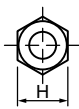

Copper pipe outer dia.	$\varnothing 6.4$	$\varnothing 9.5$	$\varnothing 12.7$	$\varnothing 15.9$	$\varnothing 19.0$
For R410A	17	22	26	29	36
For R22	Same as above		24	27	Same as above

2) Flare machining size: A (mm)



Copper pipe outer dia.	$\varnothing 6.4$	$\varnothing 9.5$	$\varnothing 12.7$	$\varnothing 15.9$	$\varnothing 19.0$
For R410A	9.1	13.2	16.6	19.7	24.0
For R22	9.0	13.0	16.2	19.4	23.3

Becomes large a little for R410A

Do not apply the refrigerator oil to the flare surface.

6-6-6. Handling of Existing Pipe

When using the existing pipe, carefully check it for the following:

- Wall thickness (within the specified range)
- Scratches and dents
- Water, oil, dirt, or dust in the pipe
- Flare looseness and leakage from welds
- Deterioration of copper pipe and heat insulator
- Before recovering the refrigerant in the existing system, perform a cooling operation for at least 30 minutes.

Cautions for using existing pipe

- Do not reuse a flare nut to prevent gas leaks. Replace it with the supplied flare nut and then process it to a flare.
- Blow nitrogen gas or use an appropriate means to keep the inside of the pipe clean. If discolored oil or much residue is discharged, wash the pipe.
- Check welds, if any, on the pipe for gas leaks.
- There may be a problem with the pressure resistance of the branching pipes of the existing piping. Replace them with branch pipes (sold separately).

When the pipe corresponds to any of the following, do not use it. Install a new pipe instead.

- The pipe has been opened (disconnected from indoor unit or outdoor unit) for a long period.
- The pipe has been connected to an outdoor unit that does not use refrigerant R22, R410A, R32 or R407.
- The existing pipe must have a wall thickness equal to or larger than the following thicknesses.

Reference outside diameter (mm)	Wall thickness (mm)	Material
6.4	0.8	—
9.5	0.8	—
12.7	0.8	—
15.9	1.0	—
19.1	1.2	—
22.2	1.0	Half hard
28.6	1.0	Half hard

- Do not use any pipe with a wall thickness less than these thicknesses due to insufficient pressure capacity.

6-6-7. Recovering Refrigerant

Use the refrigerant recovery equipment to recover the refrigerant.

6-7. Charging additional refrigerant

Amount of additional refrigerant shall be restricted by the following explanation to ensure the reliability. Miss-charging leads to the abnormal high pressure in the refrigerant cycle, causing a rupture, a injury and a compressor malfunction.

6-7-1. [Assumed gas leak]

The refrigerant can be charged only when the amount of a leak such as a slow-leak found at the installation work can be ensured that it is within the additional limits shown in the following.

Recharge the refrigerant, as the amount of leakage is unknown when calling "Cooling is not good" or "Warming is not good".

6-7-2. [Limiting the additional charge]

- The maximum amount of additional refrigerant shall be up to 10 % of the normal amount of the refrigerant. If no improvement in symptoms can be found at the above limitation, recover all gases and recharge the normal amount of refrigerant.
- If the slow leak is found at the installation work and the connection pipe length is 15 m or less, tighten the flare nut at the leak point and do not add the refrigerant.

6-7-3. [Cautions on charging additional refrigerant]

- When adding, use a balance with an accuracy of more than 10 g scale. Do not use a health-meter etc.
- If the refrigerant gas leaks, find the leakage point and repair it securely. Though the refrigerant gas itself is innocuous, if it touch a fire source such as fan heater, stove or kitchen stove, noxious gas may occur.
- When charging the refrigerant, charge with liquid refrigerant. Work carefully and charge it little by little since it may be rapidly charged due to the liquid state.

6-8. Tolerance of Pipe Length and Pipe Head

■ Twin system

Refrigerant pipe specification	Pipe length (one way)	Total length (L + a or L + b)		50 m
		Branch pipe length (a, b)		15 m
		Maximum difference between indoor units (b - a, or a - b)		10 m
	Height difference	Between indoor units (Δh)		0.5 m
		Between indoor unit and outdoor unit	When outdoor unit heigher (H)	30 m
			When outdoor unit lower (H)	30 m
Number of bent portions				10 m or less

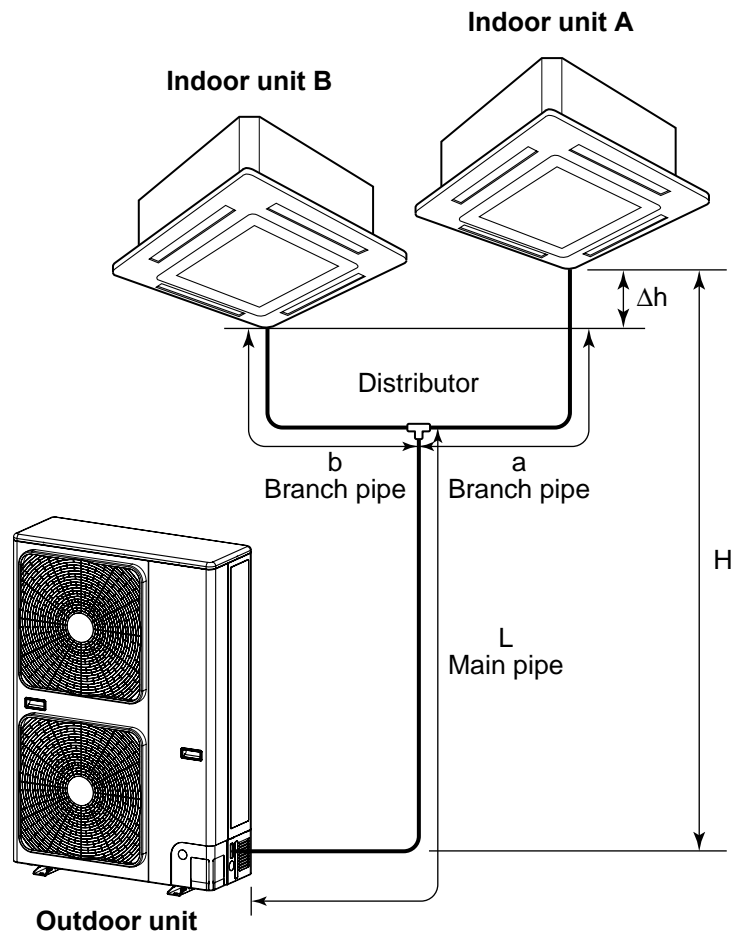

CAUTION

When planning a layout for Units A and B, comply with the following:

1. The lengths after branching ("a" and "b") should be equal if feasible.
Install Units A and B so that the difference of the branching lengths becomes less than 10m if the lengths cannot be equal due to the branch pipe position.
2. Install Units A and B on the same level.
If Units A and B cannot be installed on the same level, the difference in level should be limited to 0.5m or less.
3. Be certain to install Units A and B in the same room.
Units A and B cannot be operated independently each other.

■ Triple system

Refrigerant pipe specification	Pipe length (one way)	Total length (L + a, L + b, L + c)		50 m
		Branch pipe length (a, b, c)		15 m
		Maximum difference between indoor units (a - b , b - c , c - d)		10 m
	Height difference	Between indoor units (Δh)		0.5 m
		Between indoor unit	When outdoor unit heigher (H)	30 m
and outdoor unit		When outdoor unit lower (H)	30 m	
Number of bent portions				10 m or less

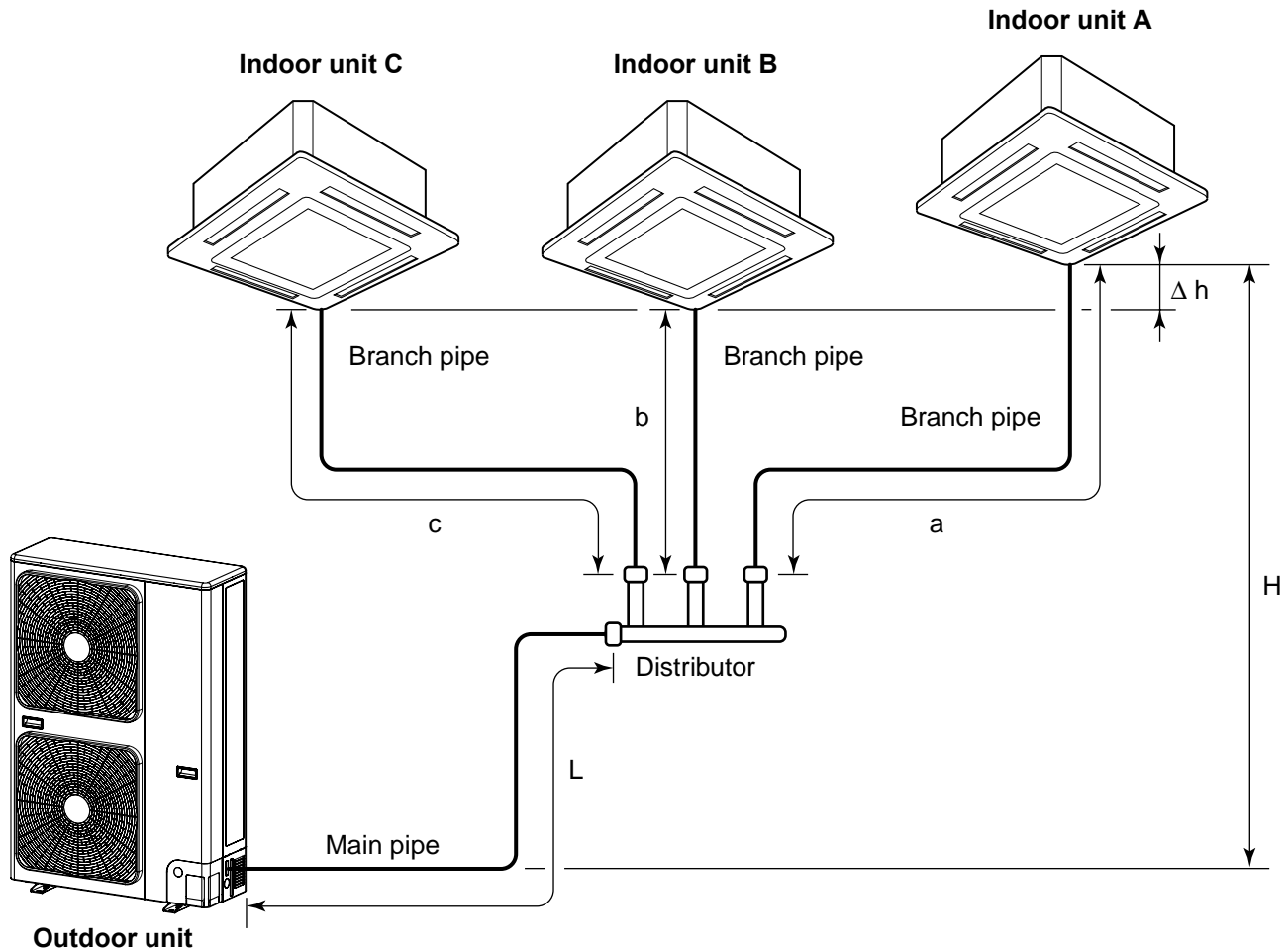

CAUTION

When planning a layout for Units A, B and C, comply with the following:

1. The lengths after branching ("a" and "b", "b" and "c", "a" and "c") should be equal if feasible.
Install Units A, B and C so that the difference of the branching lengths becomes less than 10m if the lengths cannot be equal due to the branch pipe position.
2. Install Units A, B and C on the same level.
If Units A, B and C cannot be installed on the same level, the difference in level should be limited to 0.5 m or less.
3. Be certain to install Units A and B and C in the same room.
Units A, B and C cannot be operated independently each other.

6-9. Additional Refrigerant Amount

■ Twin system

<Formula for Calculating Additional Refrigerant Amount>

Do not remove the refrigerant even if the additional refrigerant amount becomes minus result as a result of calculations by the following formula and operate the air conditioner as it is.

$$\begin{aligned} \text{Additional refrigerant amount (kg)} &= \text{Main piping additional refrigerant amount (kg)} \\ &\quad + \text{Branch piping additional refrigerant amount (kg)} \\ &= \alpha \times (L - 28) + \gamma \times (a + b - 4) \end{aligned}$$

α : Additional refrigerant amount per meter of actual main piping length (kg)

γ : Additional refrigerant amount per meter of actual branch piping length (kg)

L : Actual length of main piping (m)

a, b : Actual length of branch piping (m)

Standard piping length		Connecting pipe diameter			Additional refrigerant amount per Meter (kg/m)		
Main piping	Branch piping	L	a	b	α	β	γ
28 m	2 m	Ø9.5	Ø9.5	Ø9.5	0.035	—	0.035

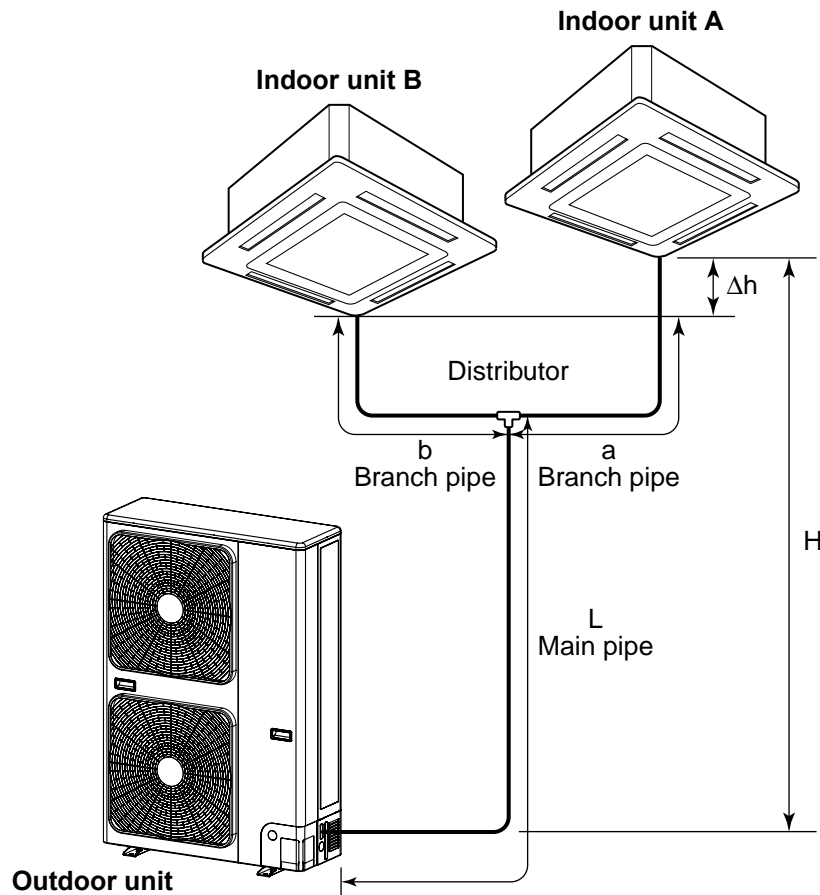

⚠ CAUTION

1. Be certain to wire the additional refrigerant amount, pipe length (actual length), head and other specification on the nameplate put on the outdoor unit for recording.
2. Seal the correct amount of additional refrigerant in the system.

■ Triple system

<Formula for Calculating Additional Refrigerant Amount>

Do not remove the refrigerant even if the additional refrigerant amount becomes minus result as a result of calculations by the following formula and operate the air conditioner as it is.

$$\begin{aligned} \text{Additional refrigerant amount (kg)} &= \text{Main piping additional refrigerant amount (kg)} \\ &+ \text{Branch piping additional refrigerant amount (kg)} \\ &= \{\alpha \times (L - 28)\} + \{\gamma \times (a + b + c - 6)\} \end{aligned}$$

α : Additional refrigerant amount per meter of actual main piping length (kg)

γ : Additional refrigerant amount per meter of actual branch piping length (kg)

L : Actual length of main piping (m)

a, b, c : Actual length of branch piping (m)

Connecting pipe diameter				Additional refrigerant amount per Meter (kg/m)		
L	a	b	c	α	β	γ
Ø9.5	Ø6.4	Ø6.4	Ø6.4	0.035	—	0.02

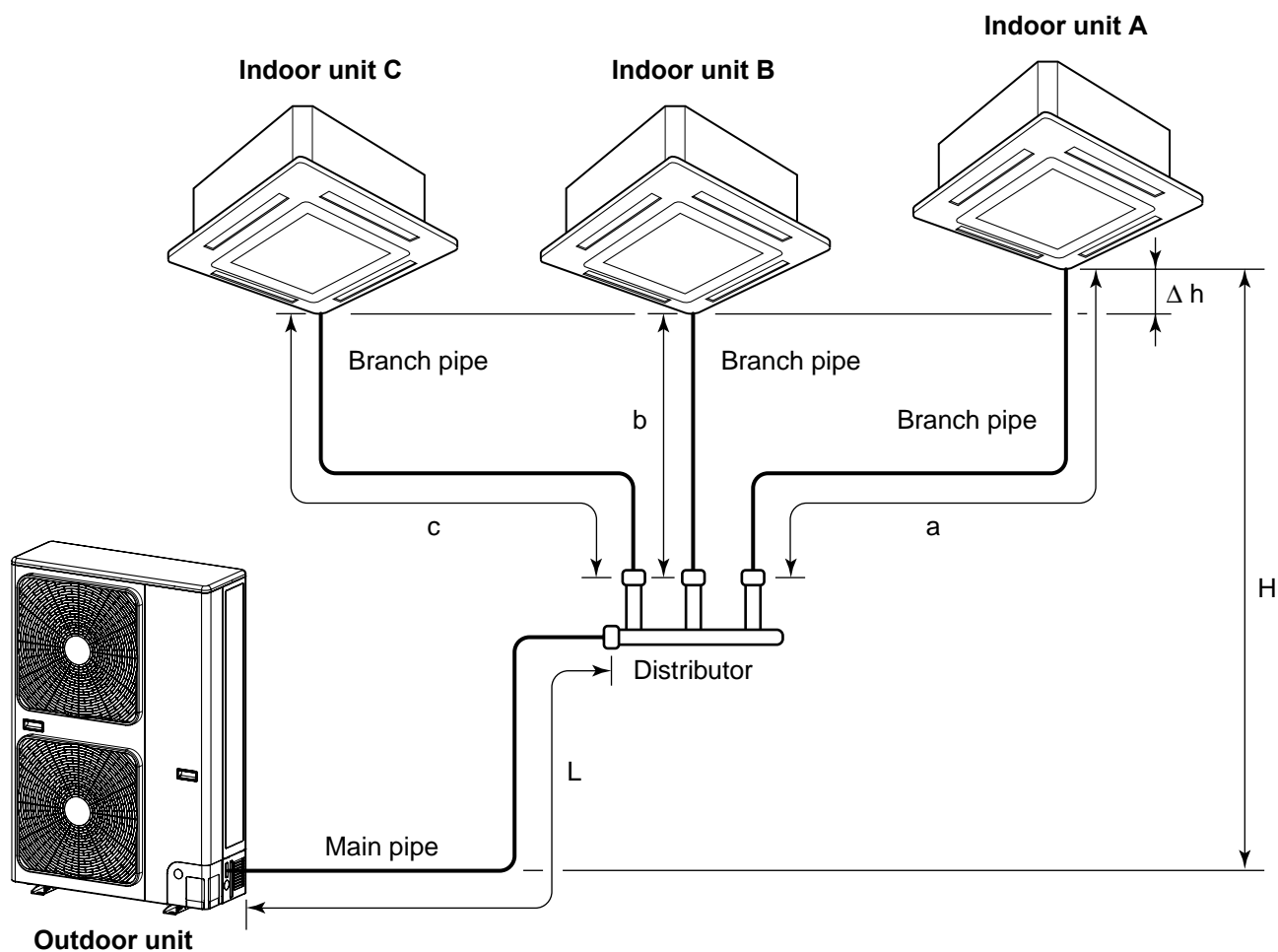

⚠ CAUTION

1. Be certain to wire the additional refrigerant amount, pipe length (actual length), head and other specification on the nameplate put on the outdoor unit for recording.
2. Seal the correct amount of additional refrigerant in the system.

6-10. Piping Materials and Sizes

■ Twin system

Use copper tube of Copper and copper alloy seamless pipes and tubes, with 40mg/10m or less in the amount of oil stuck on inner walls of pipe and 0.8mm in pipe wall thickness for diameters for diameters 6.4, 9.5 and 12.7mm and 1.0mm, for diameter 15.9mm. Never use pipes of thin wall thickness such as 0.7mm.

In parentheses () are wall thickness

Pipe side	Gas side	Main pipe	Ø15.9 (1.0)
		Branch pipe	Ø12.7 (0.8)
	Liquid side	Main pipe	Ø9.5 (0.8)
		Branch pipe	Ø6.4 (0.8)

■ Triple system

Use copper tube of Copper and copper alloy seamless pipes and tubes, with 40 mg/10 m or less in the amount of oil stuck on inner walls of pipe and 0.8 mm in pipe wall thickness for diameters 6.4, 9.5 and 12.7 mm and 1.0 mm, for diameter 15.9 mm. Never use pipes of thin wall thickness such as 0.7 mm.

<Between outdoor unit and distributor>

[Unit: mm]

Outdoor unit		
Main pipe	Gas side	Ø15.9 (1.0)
	Liquid side	Ø9.5 (0.8)

* (): Pipe wall thickness

<Between distributor and indoor unit>

[Unit: mm]

Indoor unit		RM56 type
Branch pipe	Gas side	Ø12.7 (0.8)
	Liquid side	Ø6.4 (0.8)

* (): Pipe wall thickness

6-11. Branch Pipe

■ Twin system

Now the refrigerant pipe is installed using branch pipes supplied as accessories.

- Bend and adjust the refrigerant piping so that the branch pipes and pipe after branching become horizontal.
- Fix the branch pipes onto a wall in a ceiling or onto a column.
- Provide a straight pipe longer than 500mm in length as the main piping of the branches.

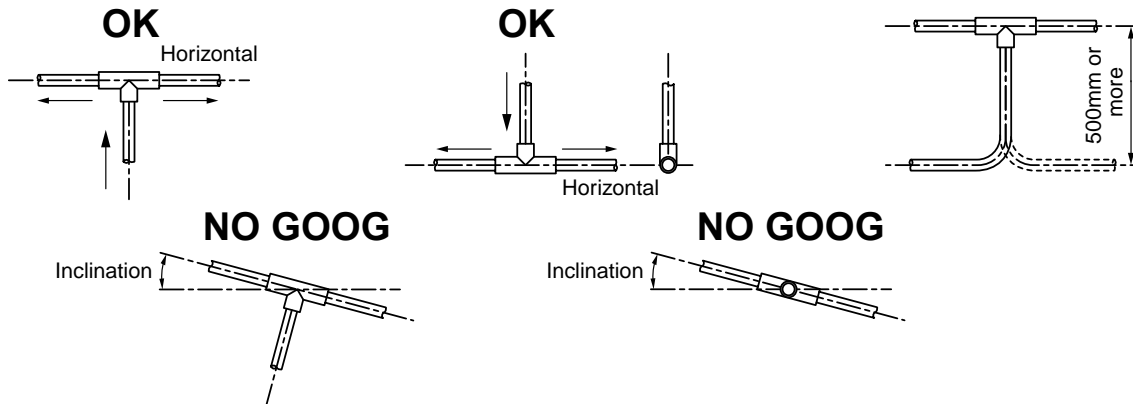

6-12. Distributor

■ Triple system

Now the refrigerant pipe is installed using distributor supplied as accessories.

- Bend and adjust the refrigerant piping so that the distributor and pipe after branching become horizontal.
- Fix the distributor onto a wall in a ceiling or onto a column.
- Provide a straight pipe longer than 500 mm in length as the main piping of the branches.

<How to install distributor>

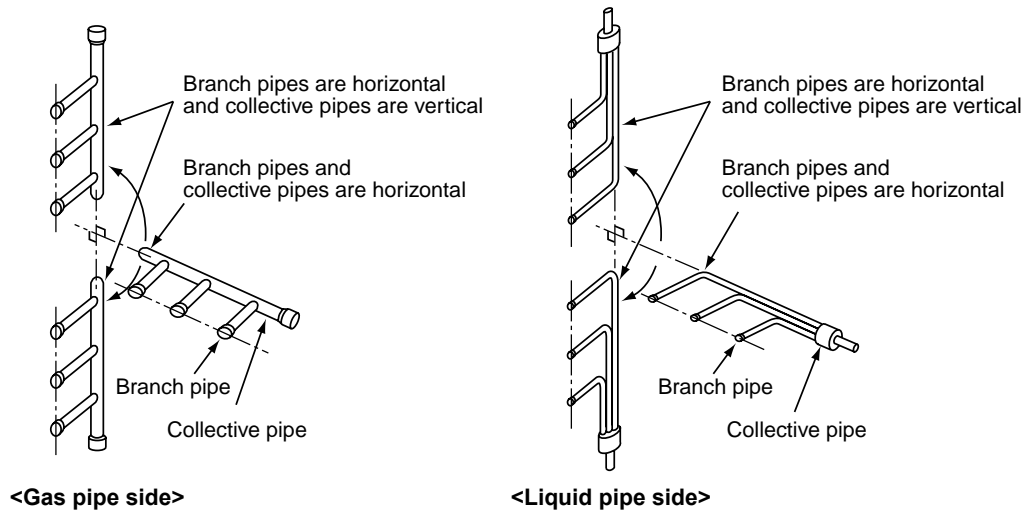

<Restrictions in length of the straight area of the branch pipe (main pipe side)>

Provide a straight area of 500 mm or more on the main pipe side of the branch pipe (for both gas pipe and liquid pipe sides).

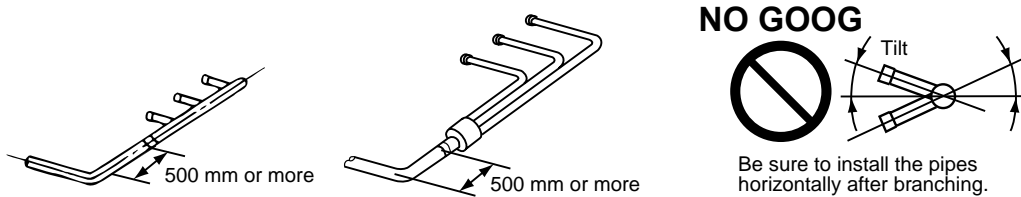

■ Air Purging

For the complete information, read the installation manual for outdoor units of air conditioner.

6-13. General safety precautions for using R32 refrigerant

6-13-1. Recovery

- When removing refrigerant from a system, either for servicing or decommissioning, it is recommended good practice that all refrigerants are removed safely.
- When transferring refrigerant into cylinders, ensure that only appropriate refrigerant recovery cylinders are employed.
- Ensure that the correct number of cylinders for holding the total system charge are available.
- All cylinders to be used are designated for the recovered refrigerant and labelled for that refrigerant (i.e. special cylinders for the recovery of refrigerant).
- Cylinders shall be complete with pressure relief valve and associated shut-off valves in good working order.
- Empty recovery cylinders are evacuated and, if possible, cooled before recovery occurs.
- The recovery equipment shall be in good working order with a set of instructions concerning the equipment that is at hand and shall be suitable for the recovery of flammable refrigerants.
- In addition, a set of calibrated weighing scales shall be available and in good working order.
- Hoses shall be complete with leak-free disconnect couplings and in good condition.
- Before using recovery machine check that it is satisfactory working order, has been properly maintained and that any associated electrical components are sealed to prevent ignition in the event of a refrigerant release.
- Consult manufacturer if in doubt.
- The recovered refrigerant shall be returned to the refrigerant supplier in the correct recovery cylinder, and the relevant Waste Transfer Note arranged.
- Do not mix refrigerants in recovery units and especially not in cylinders.
- If compressors or compressor oils are to be removed, ensure that they have been evacuated to an acceptable level to make certain that flammable refrigerant does not remain within the lubricant.
- The evacuation process shall be carried out prior to returning the compressor to the suppliers.
- Only electric heating to the compressor body shall be employed to accelerate this process.
- When oil is drained from a system, it shall be carried out safely.

6-13-3. Labelling

- Equipment shall be labelled stating that it has been de-commissioned and emptied of refrigerant.
- The label shall be dated and signed.
- Ensure that are labels on the equipment stating the equipment contains flammable refrigerant.

6-13-2. Decommissioning

- Before carrying out this procedure, it is essential that the technician is completely familiar with the equipment and all its details. Only a qualified installer (* 1) or qualified service person (* 1) is allowed to do this work.
- It is recommended good practice that all refrigerants are recovered safely.
- Prior to the task being carried out, an oil and refrigerant sample shall be taken in case analysis is required prior to re-use of reclaimed refrigerant.
- It is essential that electrical power is available before the task is commenced.

-
- a) Become familiar with the equipment and its operation.
 - b) Isolate system electrically.
 - c) Before attempting the procedure ensure that :
 - mechanical handling equipment is available, if required, for handling refrigerant cylinders;
 - all personal protective equipment is available and being used correctly;
 - the recovery process is supervised at all times by a competent person;
 - recovery equipment and cylinders conform to the appropriate standards.
 - d) Pump down refrigerant system, if possible.
 - e) If a vacuum is not possible, make a manifold so that refrigerant can be removed from the various parts of the system.
 - f) Make sure that cylinder is situated on the scales before recovery takes place.
 - g) Start the recovery machine and operate in accordance with manufacturers instructions.
 - h) Do not overfill cylinders (No more than 80%volume liquid change).
 - i) Do not exceed the maximum working pressure of the cylinder, even temporarily.
 - j) When the cylinders have been filled correctly and the process complete, make sure that cylinders and the equipment are removed from site promptly and all isolation valves on the equipment are closed off.
 - k) Recovered refrigerant shall not be changed into another refrigerant system unless it has been cleaned and checked.
-

7. OUTDOOR CONTROL CIRCUIT

7-1. Outdoor unit control

7-1-1. P.C.board for Control and 1st fan drive (MCC-1626)

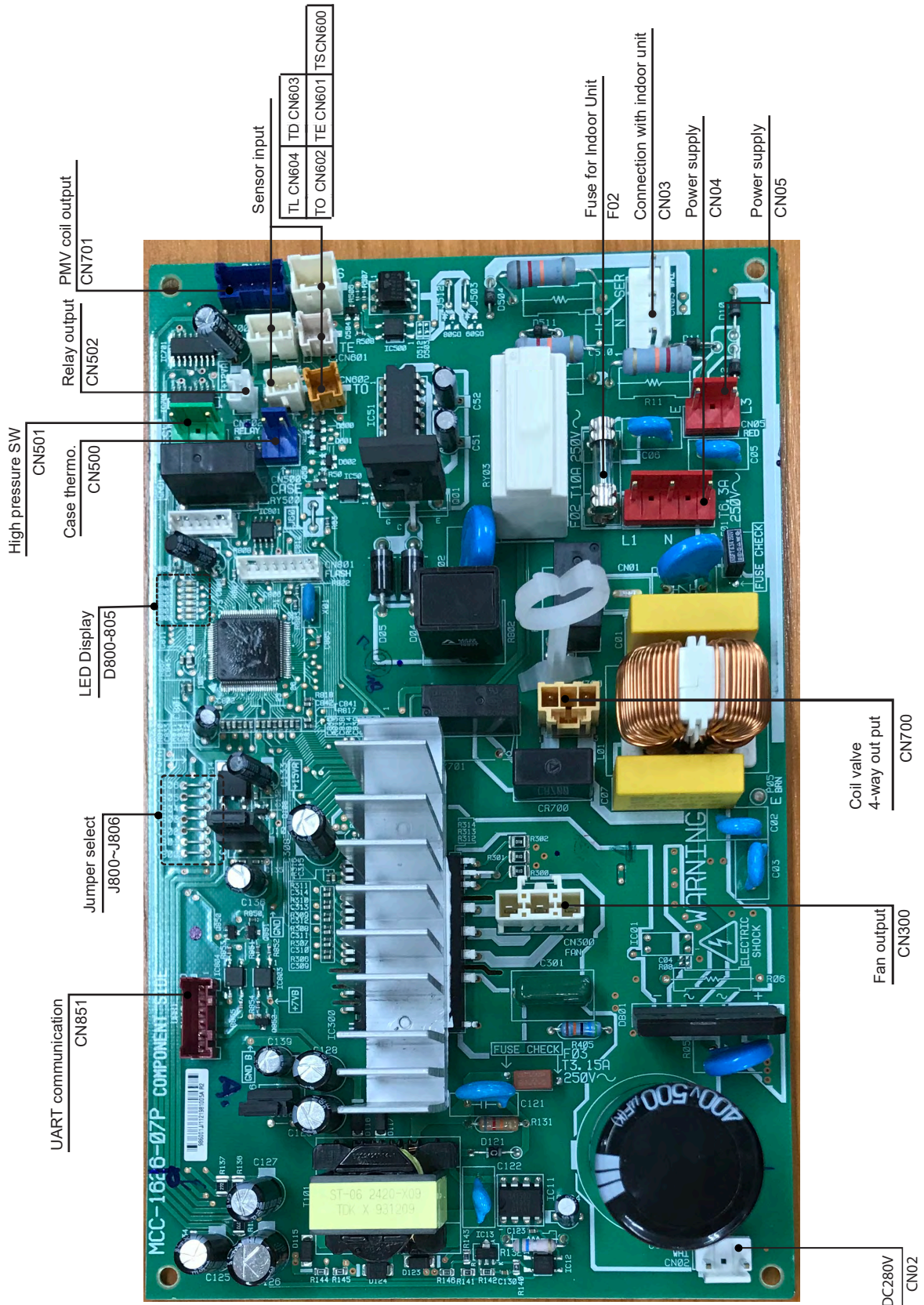

7-1-2. P.C. board for compressor drive (MCC-1627)

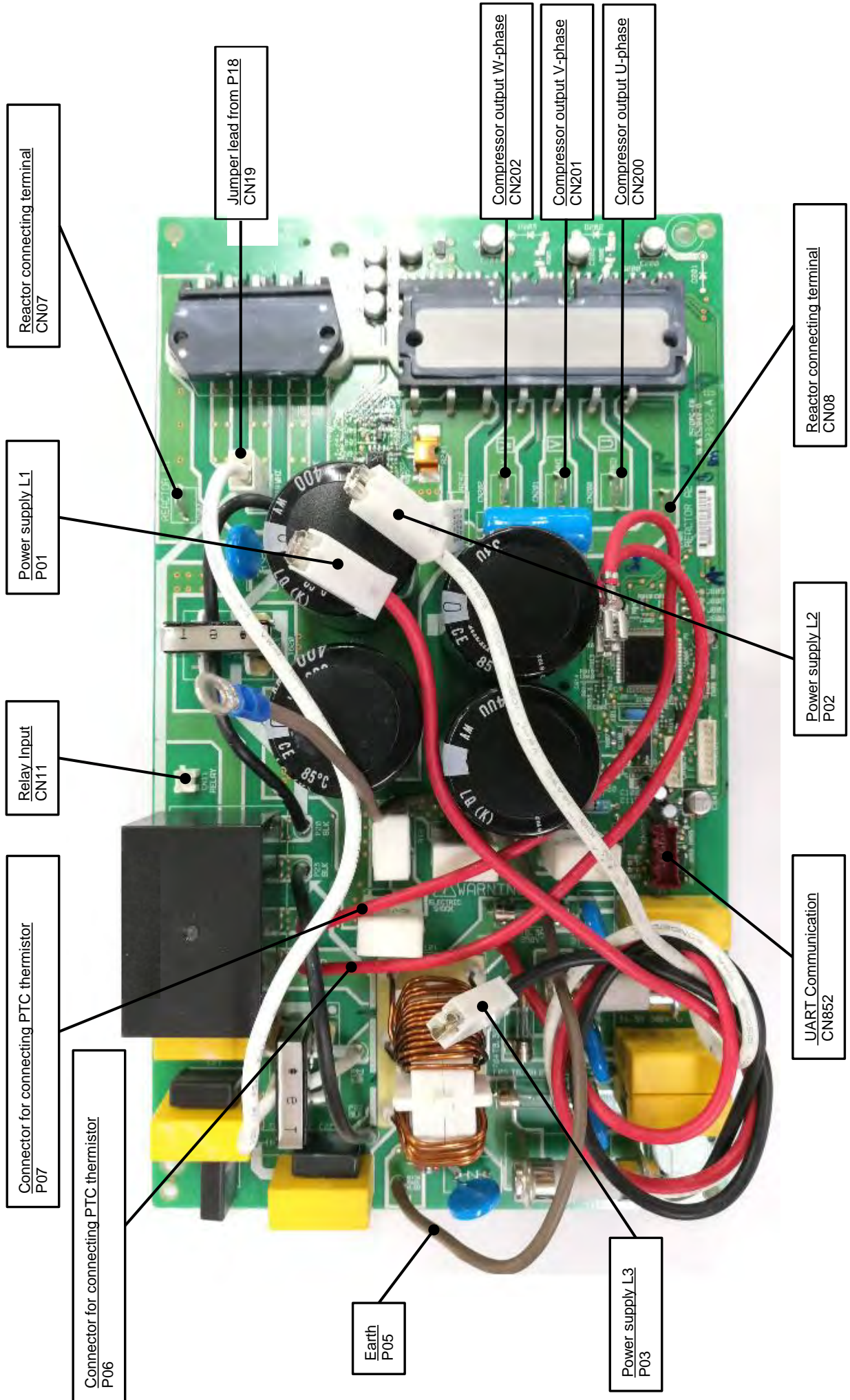

7-1-3. P.C.board for 2nd fan drive (MCC-1603)

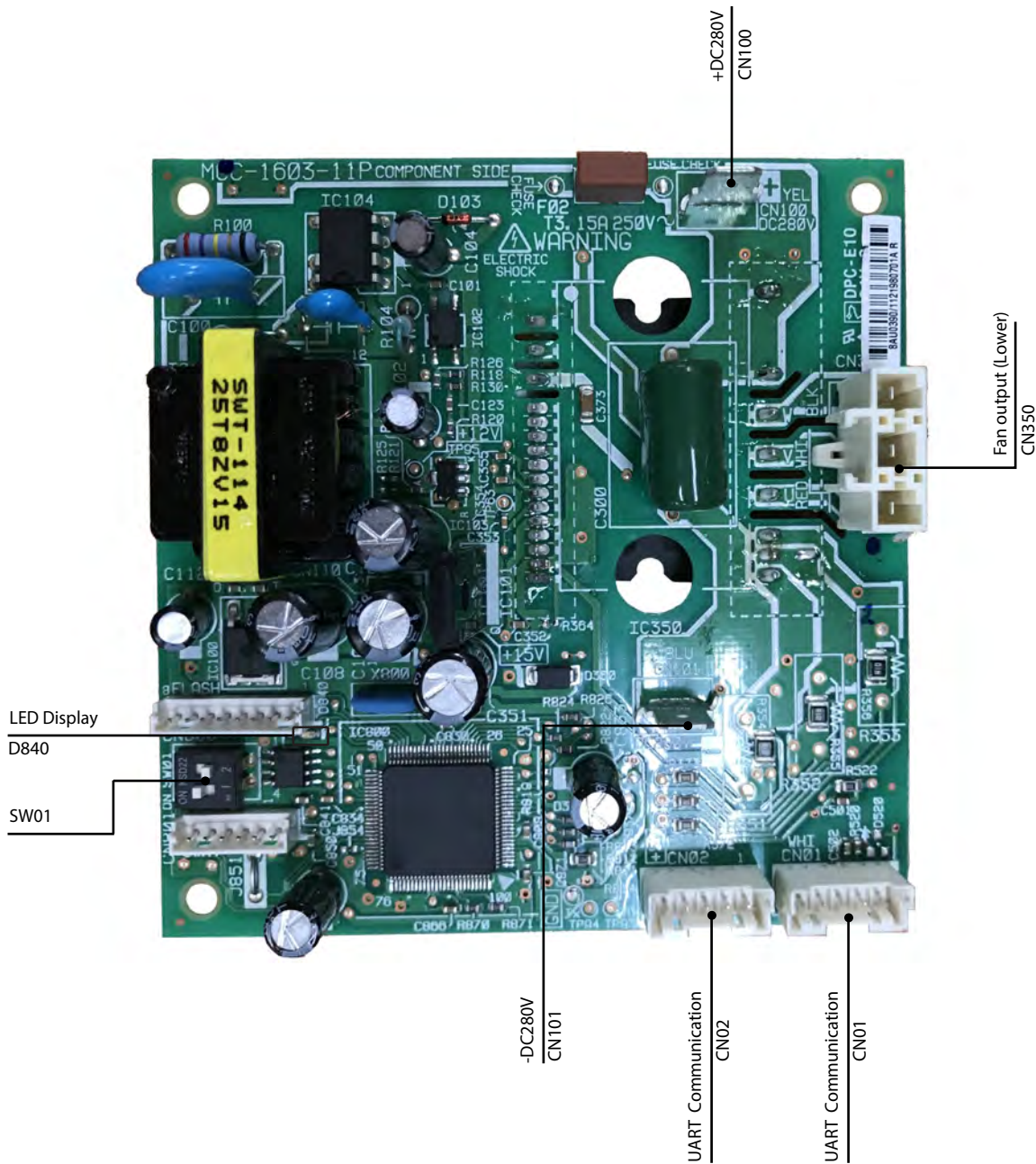

7-2. Outline of Main Controls

1. Pulse Modulating Valve (PMV) control

- 1) For PMV with 40 to 500 pulses during operation, respectively.
- 2) In cooling operation, PMV is controlled with the temperature difference between TS sensor and TC sensor.
- 3) For the temperature difference in item 2), 1 to 5K is aimed as the target in both cooling operation.
- 4) When the cycle excessively rose in both cooling operations, PMV is controlled by TD sensor.
The aimed value is usually 90°C in cooling operation.

REQUIREMENT

A sensor trouble may cause a liquid back-flow or abnormal overheat resulting in excessive shortening of the compressor life. In a case of trouble on the compressor, be sure to check there is no error in the resistance value an the refrigerating cycle of each sensor after repair and then start the operation.

2. Discharge temperature release control

- 1) When the discharge temperature did not fall or the discharge temperature rapidly went up by PMV control, this control lowers the operation frequency. It subdivides the frequency control up to 0.6Hz to stabilize the cycle.
- 2) When the discharge temperature detected an abnormal stop zone, the compressor stops and then restarts after 2 minutes 30 seconds.
The error counting is cleared when the operation continued for 10 minutes. If the error is detected by 4 times without clearing, the error is determined and restarting is not performed.
* The cause is considered as excessively little amount of refrigerant, PMV error or clogging of the cycle.
- 3) For displayed contents of error, confirm on the check code list.

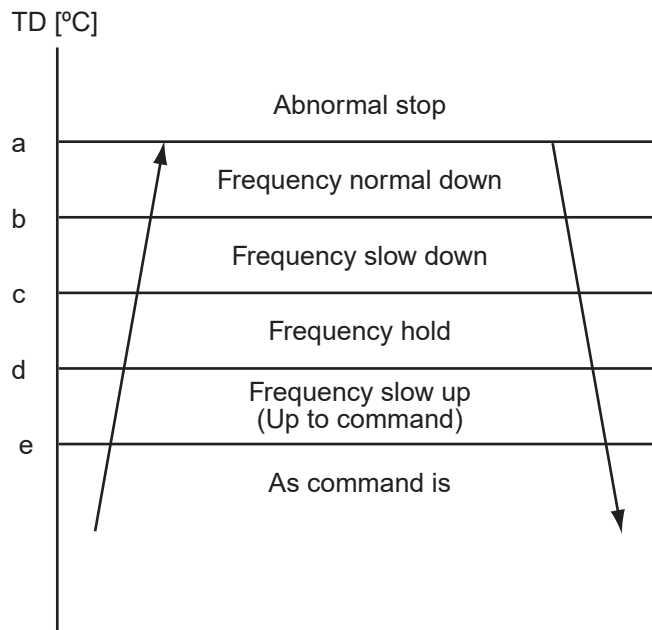

a	b	c	d	e
111	109	106	103	96

3. Current release control

The output frequency and the output voltage are controlled by AC current value detected by T620 and T621 on the outdoor P.C. board so that input current of the inverter does not exceed the specified value.

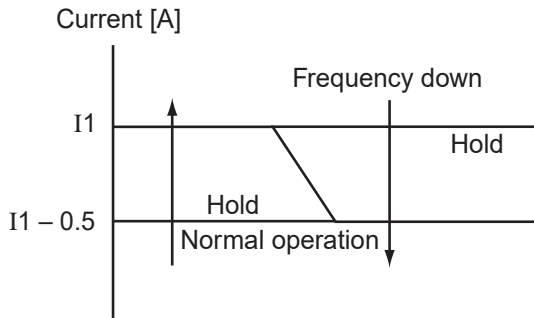

	COOL
I1 value [A]	16.7

4. Outdoor fan control

Allocations of fan tap revolutions [rpm]

	W1	W2	W3	W4	W5	W6	W7	W8	W9	WA	WB	WC	WD	WE	WF
Fan 1	250	280	330	360	410	460	520	580	650	700	760	830	900	940	980
Fan 2	280	280	330	340	410	440	500	560	600	660	700	780	860	940	980

4-1. Cooling fan control

- 1) An outdoor fan is controlled by TE sensor, TO sensor and operation frequency. An outdoor fan is controlled at 1-tap interval of DC fan control.
- 2) At the start time, the fan is fixed for 60 seconds only with the maximum fan tap corresponded to the zone in the following table but it is controlled with TE sensor temperature after then.

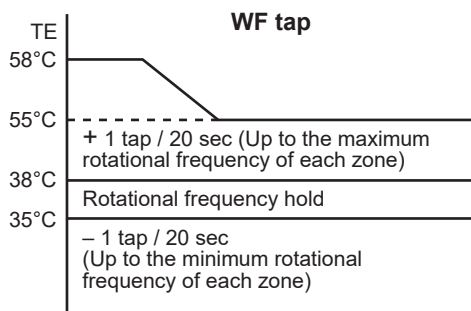

Temp. range	Under 20.4Hz		Over 20.4, under 45.0 Hz		Over 45.0 Hz	
	MIN.	MAX.	MIN.	MAX.	MIN.	MAX.
$38^{\circ}\text{C} \leq \text{TO}$	W6	WD	W8	WF	WA	WF
$29^{\circ}\text{C} \leq \text{TO} < 38^{\circ}\text{C}$	W5	WC	W7	WE	W9	WF
$15^{\circ}\text{C} \leq \text{TO} < 29^{\circ}\text{C}$	W3	W7	W5	W9	W7	WB
$5^{\circ}\text{C} \leq \text{TO} < 15^{\circ}\text{C}$	W2	W5	W4	W7	W6	W9
$0^{\circ}\text{C} \leq \text{TO} < 5^{\circ}\text{C}$	W1	W3	W3	W5	W4	W7
$-4^{\circ}\text{C} \leq \text{TO} < 0^{\circ}\text{C}$	W1	W2	W2	W4	W3	W5
$\text{TO} < -4^{\circ}\text{C}$	OFF	OFF	OFF	W2	OFF	W3
TO error	OFF	WD	OFF	WF	OFF	WF

4-2. Heating fan control

- 1) An outdoor fan is controlled by TE sensor, TO sensor and compressor frequency. (It is controlled with W1 for minimum and the maximum is controlled according to the following table.)
- 2) At the start time, the fan is fixed for 3 minutes only with the maximum fan tap corresponded to the zone in the following table but it is controlled with TE sensor temperature after then.
- 3) When a status $TE \geq 24^{\circ}\text{C}$ continues for 5 minutes, the operation stops. In this case, no error display appears and the status is same as the normal thermo-OFF. The can restarts after approx. 2 minutes 30 seconds and this continuous operation is not an error.
- 4) When the above status as 3) occurs frequently, it is considered that filter of the suction part of the indoor unit is dirty. Clean the filter and restart the operation.

TE	- 2 tap / 20 seconds (up to W1) Stop timer count
24°C	- 2 tap / 20 seconds (up to W1)
21°C	- 1 tap / 20 seconds (up to W1)
18°C	Rotational frequency hold
15°C	+ 1 tap / 20 seconds (up to Max. tap of each zone)

Temp. range	20.4 Hz or lower	20.4Hz to 45.0Hz	45.0Hz or higher
	Max.	Max.	Max.
$10^{\circ}\text{C} \leq \text{TO}$	WA	WB	WC
$5^{\circ}\text{C} \leq \text{TO} < 10^{\circ}\text{C}$	WC	WC	WC
$-3^{\circ}\text{C} \leq \text{TO} < 5^{\circ}\text{C}$	WC	WC	WE
$-10^{\circ}\text{C} \leq \text{TO} < -3^{\circ}\text{C}$	WE	WE	WE
$\text{TO} < -10^{\circ}\text{C}$	WE	WE	WE
TO error	WE	WE	WE

5. Coil heating control

- 1) This control function heats the compressor by turning on the stopped compressor instead of a case heater. It purposes to prevent stagnation of the refrigerant inside of the compressor.
- 2) As usual, turn on power of the compressor for the specified time before a test run after installation; otherwise a trouble of the compressor may be caused.
As same as a test run, it is recommended to turn on power of the compressor beforehand when starting operation after power of the compressor has been interrupted and left as it is for a long time.
- 3) A judgment for electricity is performed by TD and TO sensors.
If TO sensor is defective, a backup control is automatically performed by TE sensor.
For a case of defective TO sensor, judge it with outdoor LED display.
- 4) For every model, the power is turned off when TD is 30°C or more.

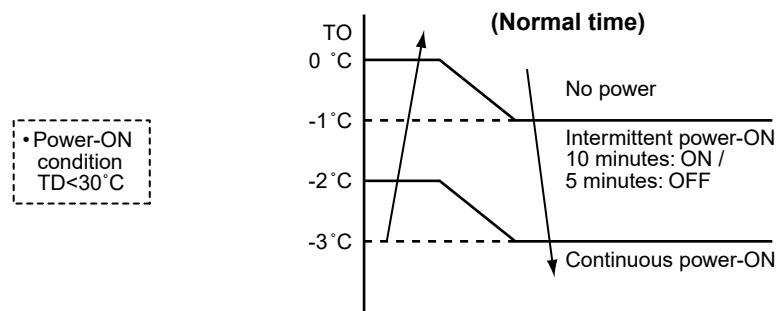

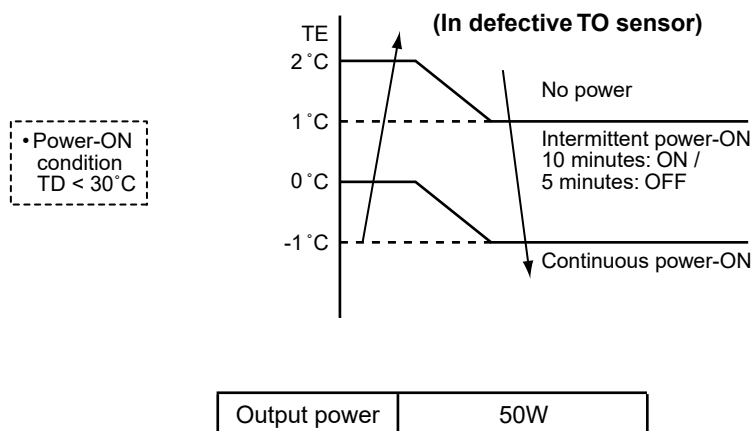

REQUIREMENT

While heating the coil, the power sound may be heard. However it is not a trouble.

6. Short intermittent operation preventive control

- 1) For 3 to 10 minutes after operation start, in some cases, the compressor does not stop to protect the compressor even if receiving the thermostat-OFF signal from indoor.
However it is not abnormal status. (The operation continuance differs according to the operation status.)
- 2) When the operation stops by the remote controller, the operation does not continue.

7. Current release value shift control

- 1) This control purposes to prevent troubles of the electronic parts such as the compressor driving elements and the compressor during cooling operation.
- 2) The current release control value (I1) is selected from the following table according to TO sensor value.

Current release control value (I1)

Temperature range	[A]
$47^{\circ}\text{C} \leq \text{TO}$	5.7
$44^{\circ}\text{C} \leq \text{TO} < 47^{\circ}\text{C}$	9.3
$39^{\circ}\text{C} \leq \text{TO} < 44^{\circ}\text{C}$	10.0
TO error	4.8

8. Over-current protective control

- 1) When the over-current protective circuit detected an abnormal current, stop the compressor.
- 2) The compressor restarts after 2 minutes 30 seconds setting [1] as an error count.
- 3) When the error count [8] was found, determine an error and restart operation is not performed.
- 4) For the error display contents, confirm on the check code list.

9. High-pressure release control

- 1) The operation frequency is controlled to restrain abnormal rising of high pressure by TL sensor in cooling operation and TC sensor in heating operation.
- 2) When TL sensor in cooling operation or TC sensor in heating operation detects abnormal temperature of the stop zone, stop the compressor and the error count becomes +1.
- 3) When the compressor stopped with 2), the operation restarts from the point of the normal operation zone (e point or lower) where it returned after 2 minutes 30 seconds.
- 4) The error count when the compressor stopped with 2) is cleared after the operation continued for 10 minutes.
If the error count becomes [10] without clearing, the error is determined and reactivation is not performed.
- 5) For the error display contents, confirm on the check code list.

HEAT TC / COOL TL
[°C]

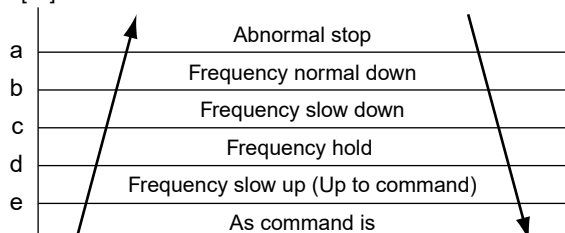

	[°C]	
	HEAT TC	COOL TL
a	61°C	62°C
b	57°C	62°C
c	54°C	60°C
d	52°C	58°C
e	48°C	54°C

10. Defrost control

- ① In heating operation, defrost operation is performed when TE sensor temperature satisfies any condition in A zone to D zone.
- ② The defrost operation is immediately finished if TE sensor temperature has become 12°C continuing for 3 seconds or more, or it also is finished when condition of 7°C < TE < 12°C has continued for 1 minute. The defrost operation is also finished when defrost operation has continued for 10 minutes even if TE sensor temperature has become 7°C or lower.
- ③ After defrost operation has finished, the compressor and the outdoor fan start heating operation after stopped for approx. 40 seconds.

Start of heating operation

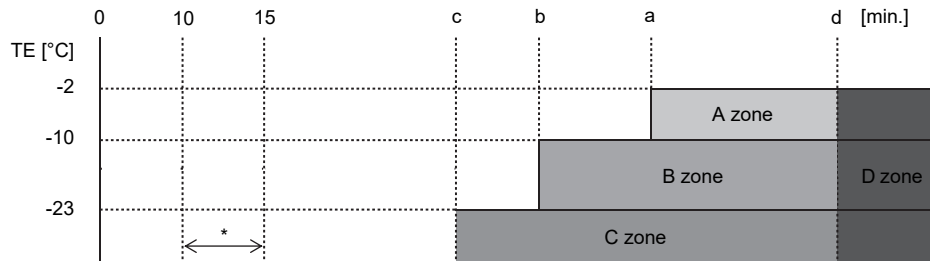

* From 10 minutes to 15 minutes after a heating operation started, the minimum value of TE is stored in memory as TEO and the minimum temperature of TO as ToO.

	At normal TO	At error TO
A zone	When status of [(TEO – TE) – (ToO – TO) ≥ 3°C] continued for 20 seconds	When status of [(TEO – TE) ≥ 3°C] continued for 20 seconds
B zone	When status of [(TEO – TE) – (ToO – TO) ≥ 2°C] continued for 20 seconds	When status of [(TEO – TE) ≥ 2°C] continued for 20 seconds
C zone	When status of [TE ≤ –23C] continued for 20 seconds	
D zone	When compressor operation status with TE < – 2°C is added by d times	

a	55
b	45
c	39
d	150

11. High-pressure switch

- 1) When the high-pressure switch operates, the operation of the compressor is terminated.
- 2) The compressor restarts after 5 minutes using [1] as an error count. After restart, the error count is cleared when operation continues for 10 minutes or more.
- 3) An error is confirmed with the error count [10].
- 4) For the indicated contents of error, confirm using the check code table.

12. Control of compressor case thermo

- 1) The compressor stops when the case thermo of the compressor operated.
- 2) When the case thermo operated for approx. 80 seconds, H04 error code is displayed on the wired remote controller. → Refer to the Check Code.
- 3) When the case thermo is reset, the operation restarts.

8. TROUBLESHOOTING

8-1. Summary of Troubleshooting

<Wired remote controller type>

1. Before troubleshooting

1) Required tools/instruments

- ⊕ and ⊖ screwdrivers, spanners, radio cutting pliers, nippers, push pins for reset switch
- Tester, thermometer, pressure gauge, etc.

2) Confirmation points before check

a) The following operations are normal.

1. Compressor does not operate.

- Is not 3-minutes delay (3 minutes after compressor OFF)?
- Is not the outdoor unit in standby status though the remote controller reached the setup temperature?
- Does not timer operate during fan operation?
- Is not an overflow error detected on the indoor unit?
- Is not outside high-temperature operation controlled in heating operation?

2. Indoor fan does not rotate.

- Does not cool air discharge preventive control work in heating operation?

3. Outdoor fan does not rotate or air volume changes.

- Does not high-temperature release operation control work in heating operation?
- Does not outside low-temperature operation control work in cooling operation?
- Is not defrost operation performed?

4. ON/OFF operation cannot be performed from remote controller.

- Is not the control operation performed from outside/remote side?
- Is not automatic address being set up?
(When the power is turned on at the first time or when indoor unit address setting is changed, the operation cannot be performed for maximum approx. 5 minutes after power-ON.)
- Is not being carried out a test run by operation of the outdoor controller?

b) Did you return the cabling to the initial positions?

c) Are connecting cables of indoor unit and remote controller correct?

2. Troubleshooting procedure

When a trouble occurred, check the parts along with the following procedure.



NOTE :

For cause of a trouble, power conditions or malfunction/erroneous diagnosis of microcomputer due to outer noise is considered except the items to be checked. If there is any noise source, change the cables of the remote controller to shield cables.

<Wireless remote controller type>

1. Before troubleshooting

- 1) Required tools/instruments
 - ⊕ and ⊖ screwdrivers, spanners, radio cutting pliers, nippers, etc.
 - Tester, thermometer, pressure gauge, etc.
- 2) Confirmation points before check
 - a) The following operations are normal.
 1. Compressor does not operate.
 - Is not 3-minutes delay (3 minutes after compressor OFF)?
 - Is not the outdoor unit in standby status though the remote controller reached the setup temperature?
 - Does not timer operate during fan operation?
 - Is not an overflow error detected on the indoor unit?
 - Is not outside high-temperature operation controlled in heating operation?
 2. Indoor fan does not rotate.
 - Does not cool air discharge preventive control work in heating operation?
- 3) Outdoor fan does not rotate or air volume changes.
 - Does not high-temperature release operation control work in heating operation?
 - Does not outside low-temperature operation control work in cooling operation?
 - Is not defrost operation performed?
- 4) ON/OFF operation cannot be performed from remote controller.
 - Is not forced operation performed?
 - Is not the control operation performed from outside/remote side?
 - Is not automatic address being set up?
 - Is not being carried out a test run by operation of the outdoor controller?
 - a) Did you return the cabling to the initial positions?
 - b) Are connecting cables between indoor unit and receiving unit correct?

2. Troubleshooting procedure

(When the power is turned on at the first time or when indoor unit address setting is changed, the operation cannot be performed for maximum approx. 5 minutes after power-ON.)

When a trouble occurred, check the parts along with the following procedure.

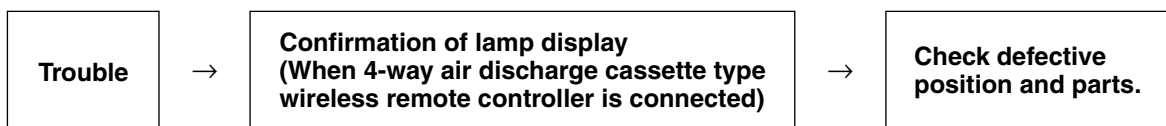

1) Outline of judgment

The primary judgment to check where a trouble occurred in indoor unit or outdoor unit is performed with the following method.

Method to judge the erroneous position by flashing indication on the display part of indoor unit (sensors of the receiving unit)

The indoor unit monitors operating status of the air conditioner, and the blocked contents of self-diagnosis are displayed restricted to the following cases if a protective circuit works.

8-2. Troubleshooting

8-2-1. Outline of judgment





The primary judgment to check whether a trouble occurred in the indoor unit or outdoor unit is carried out with the following method.

Method to judge the erroneous position by flashing indication on the display part of the indoor unit (sensors of the receiving part)

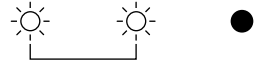
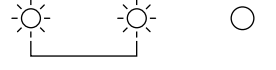

The indoor unit monitors the operating status of the air conditioner, and the blocked contents of self-diagnosis are displayed restricted to the following cases if a protective circuit works.

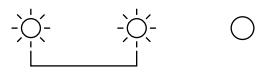
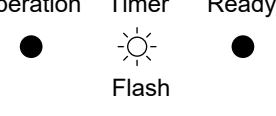
● : Go off, ○ : Go on, ☼ : Flash (0.5 sec.)

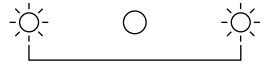
Lamp indication	Check code	Cause of trouble occurrence
Operation Timer Ready ● ● ● No indication at all	—	Power supply OFF, miswiring between receiving unit and indoor unit, miswiring of power supply of outdoor unit, or power supply error.
Operation Timer Ready ☼ ● ● Flash	E01	Receiving error } Receiving unit } Miswiring or wire connection error between receiving unit and indoor unit Sending error } Communication stop }
	E02	
	E03	
	E08	Duplicated indoor unit No. Setup error
	E09	
	E10	Communication error between CPUs on indoor unit P.C. board
E18	Wire connection error between indoor units, Indoor power OFF (Communication stop between indoor master and follower or between main and sub indoor twin)	
Operation Timer Ready ● ● ☼ Flash	E04	Miswiring between indoor unit and outdoor unit or connection error (Communication stop between indoor and outdoor units)
Operation Timer Ready ● ☼ ☼ Alternate flash	P01	Overflow was detected. } Protective device of indoor unit worked. Indoor DC fan error }
	P10	
	P12	
Operation Timer Ready ☼ ● ☼ Alternate flash	P03	Outdoor unit discharge temp. error } Protective device of outdoor unit worked. High pressure SW system error }
	P04	
	P05	Open phase detection error, Power supply voltage error } Outdoor unit error Heat sink overheat error } Gas leak detection error }
	P07	
	P15	
	P19	4-way valve inverse error(Indoor or Outdoor unit detected)
	P20	Outdoor unit high pressure protection
	P22	Outdoor unit : Outdoor unit fan error } Protective device of outdoor unit worked. Outdoor unit : Inverter Idc operation } Outdoor unit : Position detection error }
	P26	
	P29	
P31	Stopped because of error of other indoor unit in a group (Check codes of E03/L03/L07/L08)	

Lamp indication	Check code	Cause of trouble occurrence
Operation Timer Ready  Alternate flash	F01	Heat exchanger sensor (TCJ) error } Heat exchanger sensor (TC) error } Indoor unit sensor error Heat exchanger sensor (TA) error }
	F02	
	P10	
Operation Timer Ready  Alternate flash	F04	Discharge temp. sensor (TD) error } Heat exchanger temp. sensor (TE) error } Heat exchanger temp. sensor (TL) error } Outside air temp. sensor (TO) error } Sensor error of Suction temp. sensor (TS) error } outdoor unit Heat sink temp. sensor (TH) error } Miss-mounting of heat exchanger sensor (TE, TS) }
	F06	
	F07	
	F08	
	F12	
	F13	
	F15	
Operation Timer Ready  Simultaneous flash	F29	Indoor EEPROM error
Operation Timer Ready  Simultaneous flash	F31	Outdoor EEPROM error (MCC-1626)
Operation Timer Ready  Flash	H01	Compressor break down } Compressor lock } Outdoor compressor system error
	H02	
	H03	Current detection circuit error } Outdoor P.C. board error Case thermostat operation } Outdoor compressor overheat error Outdoor unit connection error
	H04	
Operation Timer Ready  Simultaneous flash	L03	Duplicated header indoor units } There is indoor unit of group connection } → AUTO address in individual indoor unit. } * If group construction and Unsetting of group address } address are not normal Missed setting } power supply turned on, (Unset indoor capacity) } automatically goes to address setup mode.
	L07	
	L08	
	L09	
Operation Timer Ready  Simultaneous flash	L10	Unset model type (Service board)
	L20	Duplicated indoor central addresses
	L29	Communication error between MCUs of outdoor unit Outdoor EEPROM error (MCC-1603, MCC-1627)
	L30	Outside interlock error

8-2-2. Others (Other than Check Code)

Lamp indication	Check code	Cause of trouble occurrence
Operation Timer Ready  Simultaneous flash	—	During test run
Operation Timer Ready  Alternate flash	—	Disagreement of cool/heat (Automatic cool/heat setting to automatic cool/heat prohibited model, or setting of heating to cooling-only model)

8-2-3. Check Code List (Outdoor)

ALT (Alternate): Alternate flashing when there are two flashing LED SIM (Simultaneous): Simultaneous flashing when there are two flashing LED
 ○ : Go on, ⊙ : Flash, ● : Go off

Central Control indication	Remote Controller indication	Sensor lamp part		Representative defective position	Detection	Explanation of error contents	Automatic Reset	Operation continuation
		Block indication	Flash					
19	F04	⊙	⊙	Outdoor unit Discharge temp. sensor (TD) error	Outdoor	Disconnection, short of discharge temp. sensor (TD) was detected	X	X
18	F06	⊙	⊙	Outdoor unit Heat exchanger temp. sensor (TE) error	Outdoor	Disconnection, short of heat exchanger temp. sensor (TE) was detected.	X	X
18	F07	⊙	⊙	Outdoor unit Heat exchanger t temp. sensor (TL) error	Outdoor	Disconnection, short of outside heat exchanger temp. sensor (TL) was detected.	X	X
1b	F08	⊙	⊙	Outdoor unit Outside air temp. sensor (TO) error	Outdoor	Disconnection, short of outside air temp. sensor (TO) was detected.	○	○
A2	F12	⊙	⊙	Outdoor unit Suction temp. sensor (TS) error	Outdoor	Disconnection, short of suction temp. sensor (TS) was detected.	X	X
43	F13	⊙	⊙	Outdoor unit Heat sink temp. sensor (TH) error	Outdoor	Disconnection, short of heat sink temp. sensor (TH) (P.C.board installed) was detected.	X	X
18	F15	⊙	⊙	Outdoor unit Miss-mounting of temp. sensor (TE, TS)	Outdoor	Miss-mounting of outdoor heat exchanger temp. sensor (TE) and suction temp. sensor (TS) was detected.	X	X
1C	F31	⊙	⊙	Outdoor unit EEPROM error	Outdoor	Outdoor P.C.board part (EEPROM) error was detected.	X	X
1F	H01	●	⊙	Outdoor unit Compressor break down	Outdoor	Reached release point at min-Hz during compressor operating.	X	X
1d	H02	●	⊙	Outdoor unit Compressor lock	Outdoor	Compressor lock was detected.	X	X
17	H03	●	⊙	Outdoor unit Current detection circuit error	Outdoor	Current detection circuit error.	X	X
44	H04	●	⊙	Outdoor unit case thermostat worked	Outdoor	Case thermostat worked.	X	X
88	L10	⊙	⊙	Outdoor unit Unset model type of service P.C.board	Outdoor	When outdoor service P.C.board was used, model type select jumper setting was inappropriate.	X	X
1C	L29	⊙	⊙	Outdoor unit Communication error between MCUs	Outdoor	Communication error between MCUs, EEPROM MCC-1603 error, EEPROM MCC-1627 error.	X	X
1E	P03	⊙	●	Outdoor unit Discharge temp. error	Outdoor	Error was detected by discharge temp. release control.	X	X
21	P04	⊙	●	Outdoor unit High pressure SW system error	Outdoor	High pressure protection switch worked.	X	X
AF	P05	⊙	●	Power supply voltage error	Outdoor	Power supply voltage error. Open phase detection error.	X	X
1C	P07	⊙	●	Outdoor unit Heat sink overheat error	Outdoor	Abnormal overheat was detected by outdoor heat sink temp. sensor.	X	X
AE	P15	⊙	●	Gas leak detection	Outdoor	Abnormal overheat of discharge temp. or suction temp. was detected.	X	X
08	P19	⊙	●	4-way valve inverse error	Indoor Outdoor	In heating operation, error was detected by temp. down of indoor heat exchanger or temp. up of TE, TS.	○	X
22	P20	⊙	●	Outdoor High pressure protective operation	Outdoor	Error was detected by high release control from indoor / outdoor heat exchanger temp. sensor.	X	X
1A	P22	⊙	●	Outdoor unit Outdoor fan system error	Outdoor	Error (Over-current, lock, overheat, etc.) was detected on outdoor fan drive circuit.	X	X
14	P26	⊙	●	Outdoor unit Short-circuit of compressor drive element	Outdoor	Short-circuited protective operation of compressor drive circuit element (G-Tr / IGBT) worked.	X	X
16	P29	⊙	●	Outdoor unit Position detection circuit error	Outdoor	Position detection error of compressor motor was detected.	X	X

Error mode detected by outdoor unit

Operation of diagnostic function				Judgment and measures
Check code	Cause of operation	Status of air conditioner	Condition	
F04	Disconnection, short of discharge temp. sensor (TD)	Stop	Displayed when error is detected	1. Check discharge temp. sensor (TD). 2. Check outdoor P.C.board.
F06	Disconnection, short of heat exchanger temp. sensor (TE)	Stop	Displayed when error is detected	1. Check temp. sensor (TE). 2. Check outdoor P.C.board.
F07	Disconnection, short of heat exchanger temp. sensor (TL)	Stop	Displayed when error is detected	1. Check heat exchanger temp. sensor (TL). 2. Check outdoor P.C. board .
F08	Disconnection, short of outside air temp. sensor (TO)	Stop	Displayed when error is detected	1. Check outside air temp. sensor (TO). 2. Check outdoor P.C.board.
F12	Disconnection, short of suction temp. sensor (TS)	Stop	Displayed when error is detected	1. Check suction temp. sensor (TS). 2. Check outdoor P.C.board.
F13	Disconnection, short of heat sink temp. sensor (TH)	Stop	Displayed when error is detected	1. Check outdoor P.C.board. (MCC-1627 (Q200) is incorporated in TH sensor)
F15	Miss-mounting of outdoor temp. sensor (TE, TS)	Stop	Displayed when error is detected	1. Check temp. sensor (TE, TS). 2. Check outdoor P.C.board.
F31	Outdoor P.C. EEPROM error	Stop	Displayed when error is detected	1. Check outdoor P.C.board. (MCC-1626)
L10	Unset jumper of service P.C.board	Stop	Displayed when error is detected	1. Outdoor service P.C.board. Check model type setting jumper wire.
L29	Communication error between MCUs of outdoor unit,	Stop	Displayed when error is detected	1. Check outdoor P.C.board. 2. Check connection between outdoor P.C.boards. 3. Check EEPROM on MCC-1627 4. Check EEPROM on MCC-1603
H01	Compressor break down * Although operation has started, operation frequency decreases and operation stops.	Stop	Displayed when error is detected	1. Check power supply voltage. (AC342 to 457V) 2. Overload operation of refrigerating cycle.
H02	Compressor lock * Over-current detection after compressor start-up	Stop	Displayed when error is detected	1. Trouble of compressor (Lock, etc.) : Replace compressor. 2. Wiring error of compressor (Open phase).
H03	Current detection circuit error	Stop	Displayed when error is detected	1. Check outdoor P.C.board. (AC current detection circuit)
H04	Case thermostat operation * Abnormal overheat of compressor	Stop	Displayed when error is detected	1. Check case thermostat and connector. 2. Check gas leak, recharge. 3. Check full open of service valve. 4. Check PMV (Pulse Motor Valve). 5. Check broken pipe.

Operation of diagnostic function				Judgment and measures
Check code	Cause of operation	Status of air conditioner	Condition	
P03	Discharge temp. error * Discharge temp. (TD) over specified value was detected.	Stop	Displayed when error is detected	1. Check refrigerating cycle (Gas leak). 2. Trouble of PMV (Pulse Motor Valve). 3. Check discharge temp. sensor (TD).
P04	High pressure SW system error	Stop	Displayed when error is detected	1. Check service valves are fully opened. (Gas side, Liquid side) 2. Check of outdoor fan operation. 3. Check clogging of outdoor PMV (Pulse Motor Valve). 4. Check clogging of heat exchanger in indoor/outdoor units. 5. Short-circuit status of suction/discharge air in outdoor unit. 6. Check outdoor P.C.board error. 7. Check fan system error (Cause of air volume drop) at Indoor side. 8. Check PMV (Pulse Motor Valve) opening status in indoor unit.
P05	Power supply error * Power supply voltage error * Open phase of 3-phase 4-wire power supply	Stop	Displayed when error is detected	1. Check power supply voltage. (AC342 to 457V) 2. Check open phase of 3-phase 4-wire power supply.
P07	Heat sink overheat error * Heat sink temp. sensor detected over specified temperature.	Stop	Displayed when error is detected	1. Check screw tightening between P.C.board and heat sink and check radiator grease. 2. Check heat sink blast path.
P19	4-way valve system error • After heating operation has started, indoor heat exchangers temp. is down.	Stop (Automatically reset)	Displayed when error is detected	1. Check 4-way valve. 2. Check PMV 3. Check indoor heat exchanger (TC/TCJ). 4. Check indoor P.C. board.
P15	Gas leak detection * Discharge temp. sensor (TD), Suction temp. sensor (TS) detected temperature over specified temp.	Stop	Displayed when error is detected	1. Check gas leak, recharge. 2. Check full open of service valve. 3. Check PMV (Pulse Motor Valve). 4. Check broken pipe. 5. Check discharge temp. sensor (TD), suction temp. sensor (TS).
P20	High pressure protective operation * During cooling operation, outdoor temp. sensor (TE) detected temperature over specified temp.	Stop	Displayed when error is detected	1. Check outdoor heat exchanger sensor (TE). 2. Check full open of service valve. 3. Check indoor / outdoor fan. 4. Check PMV (Pulse Motor Valve). 5. Check clogging and short circuit of indoor / outdoor heat exchanger. 6. Overcharge of refrigerant. Recharge.
P22	Outdoor fan system error	Stop	Displayed when error is detected	1. Check lock of fan motor. 2. Check power supply voltage. (AC342 to 457V) 3. Check screw tightening between P.C.board and heat sink and check radiator grease. 4. Check heat sink blast path. 5. Check LED display on outdoor P.C.board (MCC-1626) by refer the next page.
P26	Short-circuit of compressor drive element	Stop	Displayed when error is detected	1. When performing operation while taking-off compressor wire, P26 error occurs. Check control P.C.board. 2. When performing operation while taking-off compressor wire, an error does not occur. Compressor rare short.
P29	Position detection circuit error	Stop	Displayed when error is detected	1. Check outdoor P.C.board.

Contents Error Display

* When fixations of the errors were overlapped, the latest error is displayed.

No.	Error	Display					
		D800	D801	D802	D803	D804	D805
1	Normal	●	●	●	●	●	○
2	Discharge temperature sensor (TD) error	◎	●	●	●	●	○
3	Heat exchanger temperature sensor (TE) error	●	◎	●	●	●	○
4	Heat exchanger temperature sensor (TL) error	◎	◎	●	●	●	○
5	Outside air temperature sensor (TO) error	●	●	◎	●	●	○
6	Suction temperature sensor (TS) error	◎	●	◎	●	●	○
7	Heat sink temperature sensor (TH) error	●	◎	◎	●	●	○
8	Mis-mounting of temperature sensor (TE, TS)	◎	◎	◎	●	●	○
9	EEPROM error	●	◎	●	◎	●	○
10	Compressor breakdown	◎	◎	●	◎	●	○
11	Compressor lock	●	●	◎	◎	●	○
12	Current detection circuit error	◎	●	◎	◎	●	○
13	Thermostat for compressor activated	●	◎	◎	◎	●	○
14	Model data not set	●	●	●	●	◎	○
15	MCU-MCU communication error	◎	●	●	●	◎	○
16	Discharge temperature error	●	◎	●	●	◎	○
17	High pressure SW error	◎	◎	●	●	◎	○
18	Power supply voltage error	●	●	◎	●	◎	○
19	Heat sink overheating error	●	◎	◎	●	◎	○
20	Gas leak detected	◎	◎	◎	●	◎	○
21	4-way valve reverse error	●	●	●	◎	◎	○
22	High pressure protective operation	◎	●	●	◎	◎	○
23	DC outdoor Fan motor error (Upper side)	●	◎	●	◎	◎	○
24	DC outdoor Fan motor error (Lower side)	●	◎	◎	◎	◎	○
25	Compressor drive device shot circuit	◎	◎	●	◎	◎	○
26	Position detection circuit error	●	●	◎	◎	◎	○
27	Compressor IPDU or other (not specially identified)	◎	●	◎	◎	◎	○
28	Power supply error	●	●	●	●	●	●

○: ON, ●: OFF, ◎: rapid flashing (5 times/sec.)

* The LEDs are located at the top right of the P.C.board of the outdoor unit as shown in the figure on the right.

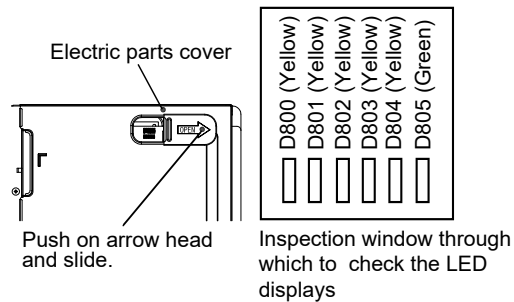

8-2-4. Diagnostic Procedure for Each Check Code (Outdoor Unit)

- 1) This section describes the diagnostic method for each check code displayed on the wired remote controller.
- 2) In some cases, a check code indicates multiple symptoms.
In this case, confirm LED display on the outdoor P.C. board to narrow the contents to be confirmed.
- 3) The check code on the wired remote controller is displayed only when the same error occurred continuously by multiple times while LED of the outdoor P.C. board displays even an error which occurred once.
Therefore the display on the wired remote controller may differ from that of LED.





LED display on outdoor P.C. board

<p>[Display of error which is generating]</p> <ul style="list-style-type: none"> • When even one of D800 to D804 rapid flashing, it indicates that an error occurred. 	<table border="0"> <tr> <td></td> <td style="text-align: center;">D800 (Yellow)</td> <td style="text-align: center;">D801 (Yellow)</td> <td style="text-align: center;">D802 (Yellow)</td> <td style="text-align: center;">D803 (Yellow)</td> <td style="text-align: center;">D804 (Yellow)</td> <td style="text-align: center;">D805 (Green)</td> </tr> <tr> <td style="text-align: right;">(No error)</td> <td style="text-align: center;">●</td> <td style="text-align: center;">●</td> <td style="text-align: center;">●</td> <td style="text-align: center;">●</td> <td style="text-align: center;">●</td> <td style="text-align: center;">○</td> </tr> <tr> <td style="text-align: right;">(Error occurred)</td> <td style="text-align: center;">◎</td> <td style="text-align: center;">●</td> <td style="text-align: center;">●</td> <td style="text-align: center;">●</td> <td style="text-align: center;">●</td> <td style="text-align: center;">○</td> </tr> </table> <p style="text-align: center;">(Example of discharge temp. sensor error)</p> <p>○ : ON, : ● OFF, ◎ : Rapid flashing (5 times / second)</p>		D800 (Yellow)	D801 (Yellow)	D802 (Yellow)	D803 (Yellow)	D804 (Yellow)	D805 (Green)	(No error)	●	●	●	●	●	○	(Error occurred)	◎	●	●	●	●	○
	D800 (Yellow)	D801 (Yellow)	D802 (Yellow)	D803 (Yellow)	D804 (Yellow)	D805 (Green)																
(No error)	●	●	●	●	●	○																
(Error occurred)	◎	●	●	●	●	○																

Check code	Outdoor LED display	Check and troubleshooting (Item without special mention Indicates part of outdoor unit.)
[E04]	-	<p>[Indoor/Outdoor communication error]</p> <pre> graph TD Q1{{Is setting of group address of remote controller correct?}} -- NO --> A1[Check CODE No. [14].] Q1 -- YES --> Q2{{Are inner wiring and indoor/outdoor control wires (1, 2, 3) correct?}} Q2 -- NO --> A2[Correct wiring indoor/outdoor control wires] Q2 -- YES --> Q3{{Are wiring of terminal blocks (1, 2, 3) correct?}} Q3 -- NO --> A3[Correct wiring of connectors and terminal blocks.] Q3 -- YES --> A4[Check outdoor P.C. board. Defect -> Replace] </pre>
[F04]	◎ ● ● ● ● ○	<p>[Discharge temp. sensor (TD) error]</p> <pre> graph TD Q1{{Is connection of CN603 correct? Is resistance value of TD sensor correct?}} -- NO --> A1[Correct connector. Sensor error -> Replace] Q1 -- YES --> A2[Check outdoor P.C. board. Defect -> Replace] </pre>
[F06]	● ◎ ● ● ● ○	<p>[Heat exchanger temp. sensor (TE) error]</p> <pre> graph TD Q1{{Is connection of CN601 correct? Is resistance value of TE sensor correct?}} -- NO --> A1[Correct connector. Sensor error -> Replace] Q1 -- YES --> A2[Check outdoor P.C. board. Defect -> Replace] </pre>
[F07]	◎ ◎ ● ● ● ○	<p>[Heat exchanger temp. sensor (TL) error]</p> <pre> graph TD Q1{{Is connection of CN604 correct? Is resistance value of TL sensor correct?}} -- NO --> A1[Correct connector. Sensor error -> Replace] Q1 -- YES --> A2[Check outdoor P.C. board. Defect -> Replace] </pre>

Check code	Outdoor LED display	Check and troubleshooting (Item without special mention Indicates part of outdoor unit.)
[F08]	● ● ◎ ● ● ○	<p>[Outside air temp. sensor (TO) error]</p> <pre> graph TD Q1{{Is connection of CN602 correct? Is resistance value of TO sensor correct?}} Q1 -- NO --> A1[Correct connector. Sensor error -> Replace] Q1 -- YES --> A2[Check outdoor P.C. board. Defect -> Replace] </pre>
[F12]	◎ ● ◎ ● ● ○	<p>[Suction temp. sensor (TS) error]</p> <pre> graph TD Q1{{Is connection of CN600 correct? Is resistance value of TS sensor correct?}} Q1 -- NO --> A1[Correct connector. Sensor error -> Replace] Q1 -- YES --> A2[Check outdoor P.C. board. Defect -> Replace] </pre>
[F13]	● ◎ ◎ ● ● ○	<p>[Heat sink temp. sensor (TH) error]</p> <pre> graph TD A1[Check outdoor P.C. board. (MCC-1627) Defect -> Replace] </pre>
[F15]	◎ ◎ ◎ ● ● ○	<p>[Miss-mounting of heat exchanger sensor (TE, TS)]</p> <pre> graph TD Q1{{Is mounting status of TE and TS sensors correct?}} Q1 -- NO --> A1[Correct sensor mounting.] Q1 -- YES --> Q2{{Is CN600 connection correct? Is resistance value of TS sensor correct?}} Q2 -- NO --> A2[Correct connector. Sensor error -> Replace] Q2 -- YES --> Q3{{Is CN601 connection correct? Is resistance value of TE sensor correct?}} Q3 -- NO --> A3[Correct connector. Sensor error -> Replace] Q3 -- YES --> A4[Check outdoor P.C. board. Defect -> Replace] </pre>

Check code	Outdoor LED display	Check and troubleshooting (Item without special mention Indicates part of outdoor unit.)
[F31]	● ◎ ● ◎ ● ○	<p>[EEPROM error]</p> <div style="border: 1px solid black; padding: 5px; width: fit-content; margin: 10px auto;"> Check outdoor P.C. board. Defect → Replace </div>
[H01]	◎ ◎ ● ◎ ● ○	<p>[Compressor break down]</p> <pre> graph TD Q1{{Is power supply voltage correct? AC342 to 457V}} -- NO --> A1[Correct power supply line.] Q1 -- YES --> Q2{{Is wire connection correct? Compressor lead (P.C. board side, Compressor side), Reactor lead, Power supply lead}} Q2 -- NO --> A2[Check wire connection and correct it.] Q2 -- YES --> Q3{{Does an abnormal overload happen?}} Q3 -- YES --> A3[Remove and improve the cause of overload.] Q3 -- NO --> A4[Check outdoor P.C. board. Defect → Replace] </pre>
[H02]	● ● ◎ ◎ ● ○	<p>[Compressor lock]</p> <pre> graph TD Q1{{Is power supply voltage correct? AC342 to 457V}} -- NO --> A1[Correct power supply line.] Q1 -- YES --> Q2{{Is wire connection correct? Compressor lead (P.C. board side, Compressor side), Reactor lead, Power supply lead}} Q2 -- NO --> A2[Check wire connection and correct it.] Q2 -- YES --> Q3{{Is compressor under correct conditions?}} Q3 -- YES --> A3[Check outdoor P.C. board. Defect → Replace] Q3 -- NO --> Q4{{Is there refrigerant stagnation?}} Q4 -- NO --> A4[Compressor lock → Replace] Q4 -- YES --> Q5{{Does PMV correctly operate?}} Q5 -- NO --> A5[Check TE, TS sensors and PMV. Defect → Replace] Q5 -- YES --> A6[Check outdoor P.C. board. Defect → Replace] </pre>

Check code	Outdoor LED display	Check and troubleshooting (Item without special mention indicates part of outdoor unit.)
[H03]		<p>[Current detection circuit error]</p> <div style="border: 1px solid black; padding: 5px; width: fit-content; margin: 10px auto;"> Check outdoor P.C. board. Defect → Replace </div>
[H04]		<p>[Case thermostat operation]</p> <pre> graph TD Q1{{Are CN500 connection and case thermostat correct?}} -- NO --> A1[Correct connector. Case thermostat error → Replace] Q1 -- YES --> Q2{{Short each pins of CN500. Can compressor operate?}} Q2 -- NO --> A2[Check outdoor P.C. board. Defect → Replace] Q2 -- YES --> Q3{{Is there gas leak? Is there refrigerant shortage?}} Q3 -- YES --> A3[Repair defectives position. Recharge refrigerant.] Q3 -- NO --> Q4{{Is service valve fully opened?}} Q4 -- NO --> A4[Open service valve fully.] Q4 -- YES --> Q5{{Is PMV under correct conditions?}} Q5 -- NO --> A5[Correct defective position. Replace defective part.] Q5 -- YES --> A6[Check crushed or broken pipe. Defect → Correct and Replace] </pre>
[L10]		<p>[Unset model type] : Only when service P.C. board is used</p> <div style="border: 1px solid black; padding: 5px; width: fit-content; margin: 10px auto;"> Cut jumper line according to the explanation sheet packaged with the service P.C. board. </div>
[L29]		<p>[Communication error between MCUs] or [EEPROM on MCC-1603 error, EEPROM on MCC-1627 error]</p> <div style="border: 1px solid black; padding: 5px; width: fit-content; margin: 10px auto;"> Check outdoor P.C. board. Defect → Replace </div>
[P03]		<p>[Discharge temp. error]</p> <pre> graph TD Q1{{Is there gas leak? Is there refrigerant shortage?}} -- YES --> A1[Repair defective position. Recharge refrigerant.] Q1 -- NO --> Q2{{Is PMV under correct conditions?}} Q2 -- NO --> A2[Repair defective position. Replace defective part.] Q2 -- YES --> Q3{{Does an abnormal overload happen?}} Q3 -- YES --> A3[Remove and improve the cause of overload.] Q3 -- NO --> Q4{{Is connection of CN603 correct? Is resistance value of TD sensor correct?}} Q4 -- NO --> A4[Correct connector. Sensor error → Replace] Q4 -- YES --> A5[Check outdoor P.C. board. Defect → Replace] </pre>

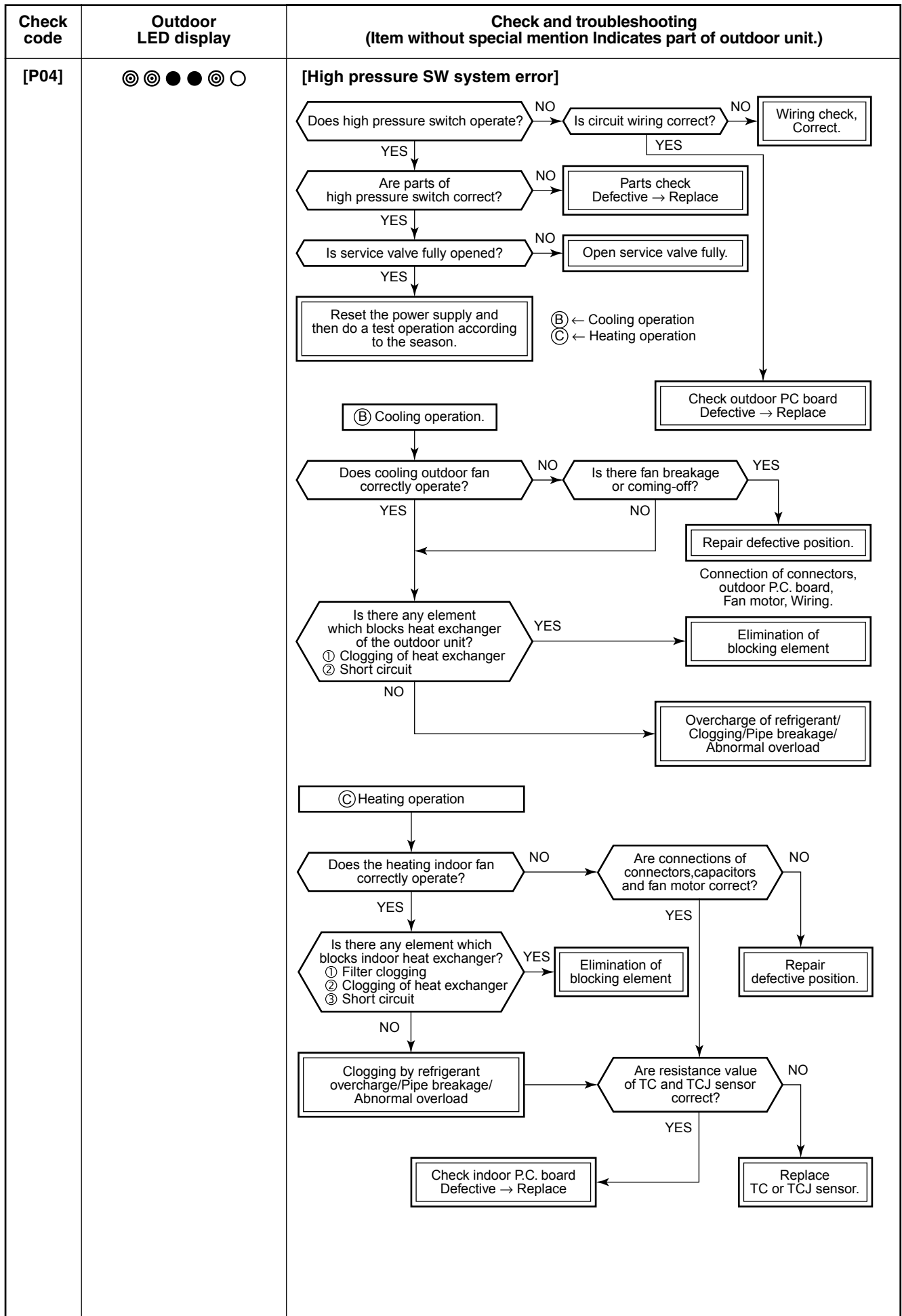



Check code	Outdoor LED display	Check and troubleshooting (Item without special mention Indicates part of outdoor unit.)
[P05]	● ● ◎ ● ◎ ○	<p>[Power supply error]</p> <pre> graph TD Q1{{Is there no open phase of the power supply?}} -- YES --> A1[Correct wiring] Q1 -- NO --> Q2{{Is there no down or up of power supply voltage? (AC342 to 457V)}} Q2 -- YES --> A2[Confirm electric construction, etc.] Q2 -- NO --> A3[Check outdoor P.C. board. Defect -> Replace] </pre>
[P07]	● ◎ ◎ ● ◎ ○	<p>[Heat sink overheat error]</p> <pre> graph TD Q1{{Is the power device on P.C. board screwed without looseness? (Q200 of MCC-1627) Are radiation grease properly applied? (Q200 of MCC-1627)}} -- NO --> A1[Apply radiation grease to objective parts. Retightening of screws.] Q1 -- YES --> Q2{{Does something block the ventilation around the heat sink? Does something block air flow from the fan?}} Q2 -- YES --> A2[Remove blocking matter. Correct short-circuit.] Q2 -- NO --> A3[Check outdoor P.C. board. Defect -> Replace] </pre>
[P15]	◎ ◎ ◎ ● ◎ ○	<p>[Gas leak detection]</p> <pre> graph TD Q1{{Is there gas leak? Is there refrigerant shortage?}} -- YES --> A1[Repair defective position. Recharge refrigerant.] Q1 -- NO --> Q2{{Is PMV under correct conditions?}} Q2 -- NO --> A2[Repair defective position. Replace defective part.] Q2 -- YES --> Q3{{Is service valve fully opened?}} Q3 -- NO --> A3[Open service valve fully.] Q3 -- YES --> Q4{{Is there crushed pipe?}} Q4 -- YES --> A4[Correct and replace piping.] Q4 -- NO --> Q5{{Check temp. sensor. TD sensor CN603 TS sensor CN600}} Q5 -- Error --> A5[Correct connector. Sensor error -> Replace] Q5 -- OK --> A6[Check outdoor P.C. board. Defect -> Replace] </pre>

Check code	Outdoor LED display	Check and troubleshooting (Item without special mention indicates part of outdoor unit.)
[P19]	● ● ● ◎ ◎ ○	<p>[4-way valve inverse error]</p> <pre> graph TD Q1{{Is operation of 4-way valve correct? (Check pipe temp. and etc. in cooling/heating operation.)}} Q2{{Is the 4-way valve coil is normal? (Check the resistance value of 4-way valve coil)}} Q3{{Does power supply to 4-way valve coil when 4-way valve is operated?}} Q4{{Are temperature sensors correct? TE sensor: CN601 TS sensor: CN600}} Q5{{Is refrigerant flow by PMV correct?}} Q6{{Are resistance value of indoor TC and TCJ sensors correct?}} Q7{{Check outdoor P.C. board.}} Q8{{Check indoor P.C. board. Defect -> Replace}} Q1 -- NO --> Q2 Q1 -- YES --> Q4 Q2 -- NO --> R1[Replace coil of 4-way valve.] Q2 -- YES --> Q3 Q3 -- YES --> Q7 Q3 -- NO --> Q4 Q4 -- NO --> R2[Replace TE sensor. Replace TS sensor.] Q4 -- YES --> Q5 Q5 -- NO --> R3[Check and replace of PMV] Q5 -- YES --> Q6 Q6 -- NO --> R4[Replace TC sensor Replace TCJ sensor] Q6 -- YES --> Q8 Q7 -- Error --> R5[Check 4-way valve. Defect -> Replace] Q7 -- OK --> Q8 </pre>

Check code	Outdoor LED display	Check and troubleshooting (Item without special mention indicates part of outdoor unit.)
[P20]		<p>[High pressure protective operation]</p> <pre> graph TD Q1{{Is service valve fully opened?}} -- NO --> A1[Open service valve fully.] Q1 -- YES --> B1[Reset the power supply and then make a test run.] B1 --> Q2{{Is resistance value of TE sensor correct?}} Q2 -- NO --> A2[Replace TE sensor.] Q2 -- YES --> Q3{{Is there any defect such as loosening of nut in the outdoor fan?}} Q3 -- YES --> A3[Check outdoor fan. Defect → Replace, retightening] Q3 -- NO --> Q4{{Does the outdoor fan perform abnormal operation?}} Q4 -- YES --> A4[Check the same items as [P22] error.] Q4 -- NO --> Q5{{Is there anything which interfere heat exchange of outdoor unit? • Clogging of heat exchanger • Short-circuit}} Q5 -- YES --> A5[Eliminate interfering element.] Q5 -- NO --> A6[Check overcharge of refrigerant, clogging of cycle, broken pipe, abnormal overload, etc. Defect → Correct defect.] </pre>

Check code	Outdoor LED display	Check and troubleshooting (Item without special mention Indicates part of outdoor unit.)
[P22]	● ◎ ● ◎ ◎ ○	<p>[Outdoor Fan Motor (Upper side) error]</p> <pre> graph TD Q1{{Is AC mains voltage correct? (AC342 to 457V)}} -- NO --> A1[Check wiring construction. Ask repair of power supply.] Q1 -- YES --> Q2{{Rotate shaft of the fan motor by hands during power-OFF. Can it rotate smoothly? Is coil resistance of fan motor correct? Between red and white lead wire : 12 to 20Ω Between white and black lead wire : 12 to 20Ω Between black and red lead wire : 12 to 20Ω}} Q2 -- NO --> A2[Replace fan motor] Q2 -- YES --> Q3{{Is the power device on P.C.board screwed without looseness? (IC300 of MCC-1626) Are radiation grease properly applied? (IC300 of MCC-1626)}} Q3 -- NO --> A3[Apply radiation grease to objective parts. Retightening of screws.] Q3 -- YES --> Q4{{Does something block the ventilation around the heat sink? Does something block air flow from the fan ?}} Q4 -- YES --> A4[Remove blocking matter. Correct short-circuit.] Q4 -- YES --> A5[Check outdoor P.C.Board. Defect → Replace] </pre>
	● ◎ ◎ ◎ ◎ ○	<p>[Outdoor Fan Motor (Lower side) error]</p> <pre> graph TD Q1{{Is AC mains voltage correct? (AC342 to 457V)}} -- NO --> A1[Check wiring construction. Ask repair of power supply.] Q1 -- YES --> Q2{{Rotate shaft of the fan motor by hands during power-OFF. Can it rotate smoothly? Is coil resistance of fan motor correct? Between red and white lead wire : 12 to 20Ω Between white and black lead wire : 12 to 20Ω Between black and red lead wire : 12 to 20Ω}} Q2 -- NO --> A2[Replace fan motor] Q2 -- YES --> Q3{{Is the power device on P.C.board screwed without looseness? (IC350 of MCC-1603) Are radiation grease properly applied? (IC350 of MCC-1603)}} Q3 -- NO --> A3[Apply radiation grease to objective parts. Retightening of screws.] Q3 -- YES --> Q4{{Does something block the ventilation around the heat sink? Does something block air flow from the fan ?}} Q4 -- YES --> A4[Remove blocking matter. Correct short-circuit.] Q4 -- YES --> A5[Check outdoor P.C.Board. Defect → Replace] </pre>

Check code	Outdoor LED display	Check and troubleshooting (Item without special mention Indicates part of outdoor unit.)
[P26]		<p>[Short-circuit of compressor drive element]</p> <pre> graph TD Q1{Are connections of compressor lead and reactor correct? (Check referring to the Wiring diagram.)} Q2{Does the same error occur in operation without compressor lead?} A1[Correct wiring.] A2[Replace outdoor P.C. board.] A3[Check compressor. (Rear short, etc.) Defect → Replace] Q1 -- NO --> A1 Q1 -- YES --> Q2 Q2 -- YES --> A2 Q2 -- NO --> A3 </pre>
[P29]		<p>[Position detection circuit error]</p> <p>Check outdoor P.C. board. Defect → Replace</p>
— No code		<p>[Other error] Compressor disorder due to sudden change of load, etc.</p> <ul style="list-style-type: none"> * Although the display of outdoor LED outputs, the unit automatically restarts and error is not determined. * LED display also may output due to wire coming-off of compressor.

8-2-5. Diagnostic Procedure for Each Check Code (Outdoor Unit)

Temperature sensor Temperature – Resistance value characteristic table

TA, TC, TCJ, TE, TS, TO sensors

TD, TL sensors

Representative value

Representative value

Temperature (°C)	Resistance value (kΩ)		
	(Minimum value)	(Standard value)	(Maximum value)
0	32.33	33.80	35.30
10	19.63	20.35	21.09
20	12.23	12.59	12.95
25	9.75	10.00	10.25
30	7.764	7.990	8.218
40	5.013	5.192	5.375
50	3.312	3.451	3.594
60	2.236	2.343	2.454
70	1.540	1.623	1.709
80	1.082	1.146	1.213
90	0.7740	0.8237	0.8761
100	0.5634	0.6023	0.6434

Temperature (°C)	Resistance value (kΩ)		
	(Minimum value)	(Standard value)	(Maximum value)
0	150.5	161.3	172.7
10	92.76	99.05	105.6
20	58.61	62.36	66.26
25	47.01	49.93	52.97
30	37.93	40.22	42.59
40	25.12	26.55	28.03
50	17.00	17.92	18.86
60	11.74	12.34	12.95
70	8.269	8.668	9.074
80	5.925	6.195	6.470
90	4.321	4.507	4.696
100	3.205	3.336	3.468

TA, TC, TCJ, TE, TS, TO sensors

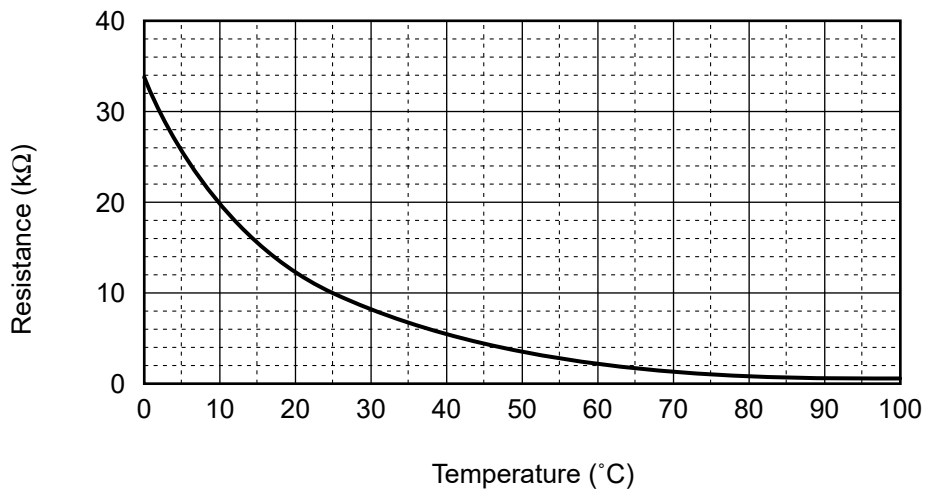

TD, TL sensors

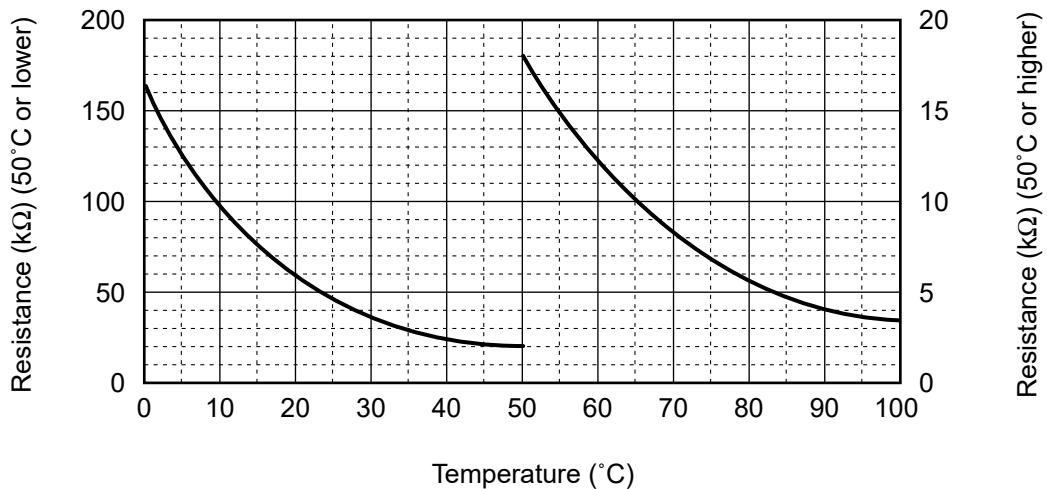

* As TH sensor (Outdoor unit heat sink temp. sensor) is incorporated in the outdoor control P.C. board, the resistance value cannot be measured.

8-3. Table Inspection of outdoor unit main parts

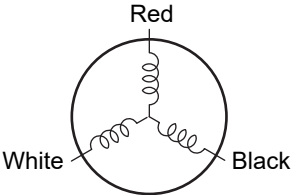
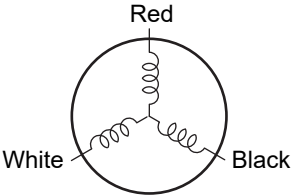
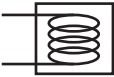
No.	Parts name	Checking procedure						
1	Compressor (Model : RX380A2T-20M)	<p>Measure the resistance value of each winding by using the tester.</p> <div style="display: flex; align-items: center; justify-content: center;">  <table border="1" style="margin-left: 20px;"> <thead> <tr> <th data-bbox="964 331 1206 387">Position</th> <th data-bbox="1211 331 1450 387">Resistance value</th> </tr> </thead> <tbody> <tr> <td data-bbox="964 394 1206 451">Red – White</td> <td data-bbox="1211 394 1450 451" rowspan="3" style="text-align: center; vertical-align: middle;">1.42Ω</td> </tr> <tr> <td data-bbox="964 458 1206 514">White – Black</td> </tr> <tr> <td data-bbox="964 521 1206 578">Black – Red</td> </tr> </tbody> </table> </div> <p style="text-align: right; margin-right: 20px;">Under 20°C</p>	Position	Resistance value	Red – White	1.42Ω	White – Black	Black – Red
Position	Resistance value							
Red – White	1.42Ω							
White – Black								
Black – Red								
2	Outdoor fan motor (Model : ICF-280-A100-1)	<p>Measure the resistance value of each winding by using the tester.</p> <div style="display: flex; align-items: center; justify-content: center;">  <table border="1" style="margin-left: 20px;"> <thead> <tr> <th data-bbox="964 698 1206 755">Position</th> <th data-bbox="1211 698 1450 755">Resistance value</th> </tr> </thead> <tbody> <tr> <td data-bbox="964 762 1206 818">Red – White</td> <td data-bbox="1211 762 1450 818" rowspan="3" style="text-align: center; vertical-align: middle;">14.8±1.5Ω</td> </tr> <tr> <td data-bbox="964 825 1206 882">White – Black</td> </tr> <tr> <td data-bbox="964 889 1206 945">Black – Red</td> </tr> </tbody> </table> </div> <p style="text-align: right; margin-right: 20px;">Under 20°C</p>	Position	Resistance value	Red – White	14.8±1.5Ω	White – Black	Black – Red
Position	Resistance value							
Red – White	14.8±1.5Ω							
White – Black								
Black – Red								
3	4-way valve coil (Cooling/heating switching) (Model : DXQ-822)	<p>Measure the resistance value of each winding by using the tester.</p> <div style="display: flex; align-items: center; justify-content: center;">  <table border="1" style="margin-left: 20px;"> <thead> <tr> <th data-bbox="964 1068 1450 1124">Resistance value</th> </tr> </thead> <tbody> <tr> <td data-bbox="964 1131 1450 1188" style="text-align: center;">1979±197 Ω</td> </tr> </tbody> </table> </div> <p style="margin-left: 20px;">Connector : Yellow</p> <p style="text-align: right; margin-right: 20px;">Under 20°C</p>	Resistance value	1979±197 Ω				
Resistance value								
1979±197 Ω								

9. SETUP AT LOCAL SITE AND OTHERS

9-1. Calling of error history

<Contents>

The error contents in the past can be called.

<Procedure>

- 1 Push **SET** + **TEST** buttons simultaneously for 4 seconds or more to call the service check mode.

Service Check goes on, the **item code 01** is displayed, and then the content of the latest alarm is displayed. The number and error contents of the indoor unit in which an error occurred are displayed.

- 2 In order to monitor another error history, push the set temperature **▼** / **▲** buttons to change the error history No. (Item code).

Item code **01** (Latest) → Item code **04** (Old)

NOTE : 4 error histories are stored in memory.

- 3 Pushing **TEST** button returns the display to usual display.

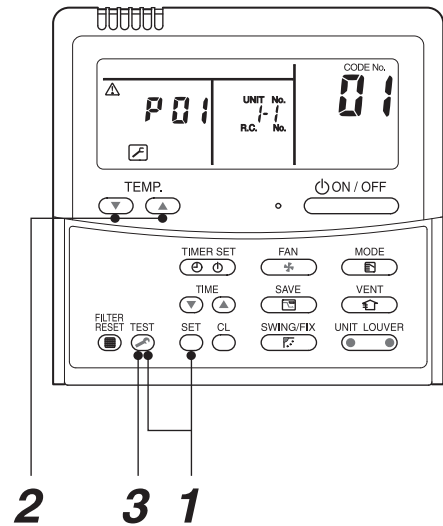

<Operation procedure>

1 → 2 → 3

Returned to usual display

REQUIREMENT

Do not push **CL** button, otherwise all the error histories of the indoor unit are deleted.

(Group control operation)

In a group control, operation of maximum 8 indoor units can be controlled by a remote controller.

The indoor unit connected with outdoor unit (Individual/Master of twin) controls room temperature according to setting on the remote controller.

<System example>

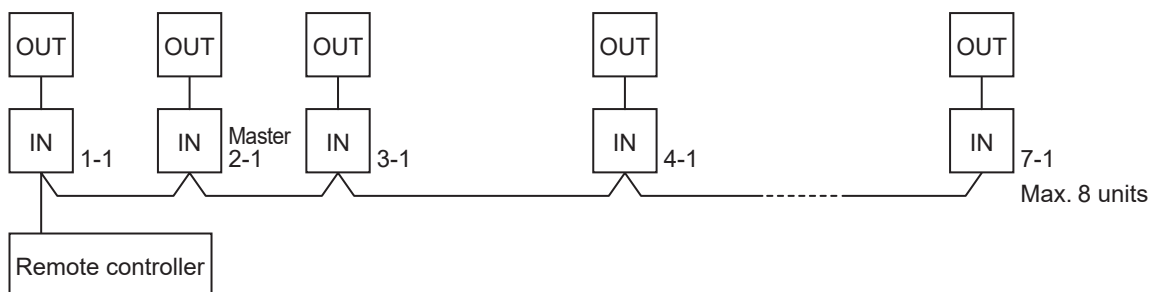

1. Display range on remote controller

The setup range (Operation mode/Air volume select/Setup temp) of the indoor unit which was set to the master unit is reflected on the remote controller.

2. Address setup

Turn on power of the indoor unit to be controlled in a group within 3 minutes after setting of automatic address.

If power of the indoor unit is not turned on within 3 minutes (completion of automatic address setting), the system is rebooted and the automatic address setting will be judged again.

- 1) Connect 3 In/Out cables surely.
- 2) Check line address/indoor address/group address of the unit one by one.
- 3) The unit No. (line/indoor gout address) which have been set once keep the present status as a rule if the unit No. is not duplicated with one of another unit.

■ Indoor unit power-ON sequence

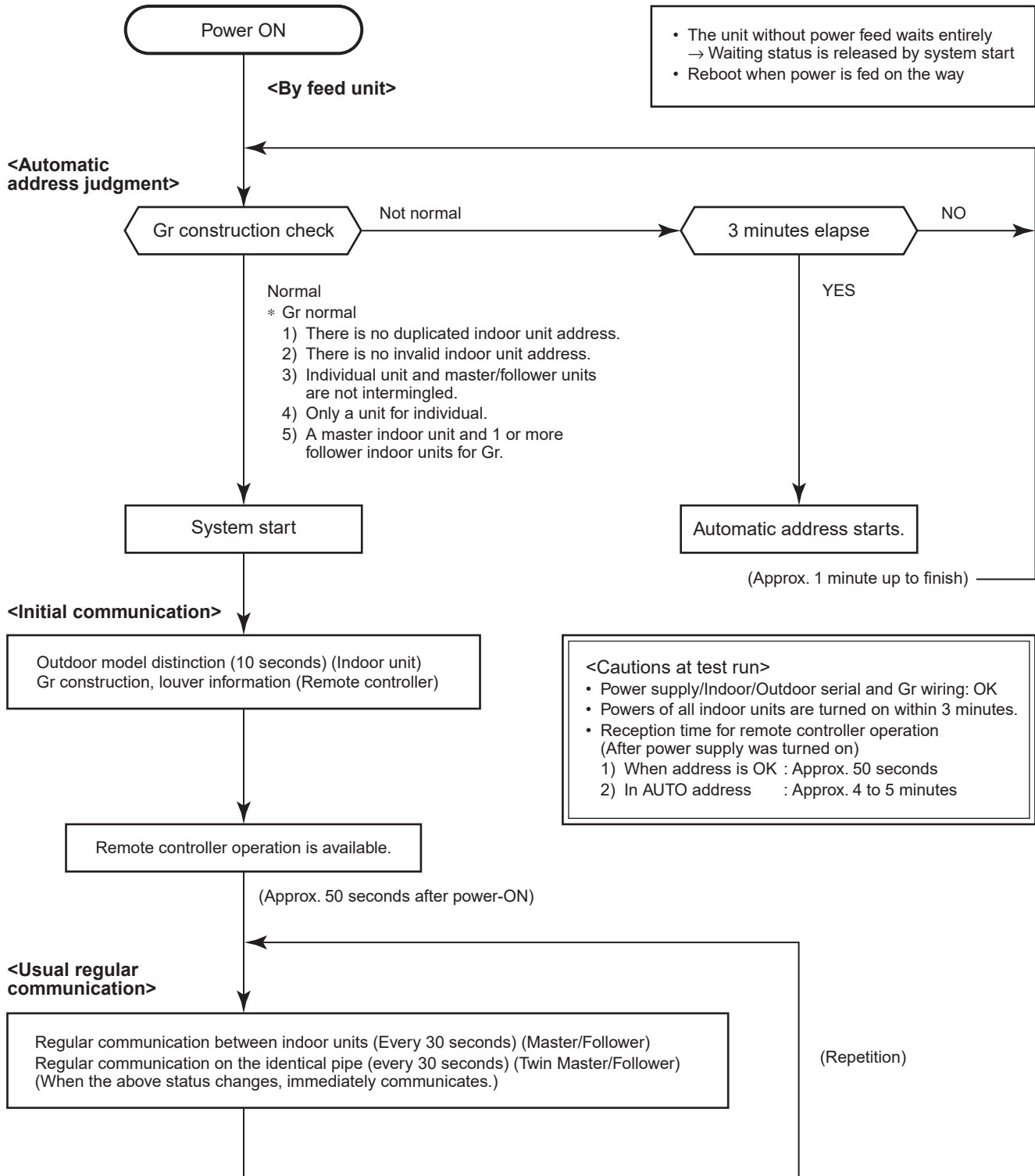

- In a group operation, if the indoor unit which was fed power after judgment of automatic address cannot receive regular communication from the master unit and regular communication on identical pipe within 120 seconds after power was turned on, it reboots (system reset).
 - The operation starts from judgment of automatic address (Gr construction check) again.
(If the address of the master unit was determined in the previous time, the power fed to the master unit and reboot works, the master unit may change though the indoor unit line address is not changed.)

9-2. Others

Recovering the refrigerant

WARNING

Don't admit air into refrigerant during recovery.
Otherwise, the pressure in the freezing cycle might increase abnormally. Serious injury could occur if it bursts.

[Recovering the refrigerant]

- You need to recover the refrigerant when moving or repairing the indoor and/or outdoor units. You cannot do this while the air conditioner is running in cooling mode because a protective device will be tripped. Be sure to recover the refrigerant in test run mode.
- Use a refrigerant recovery device when the amount of refrigerant to be recovered exceeds the initial amount of 1.5 kg.

■ Instructions (Recovery to the Air Conditioner)

1. Power on the air conditioner.
2. To set the air conditioner to test run mode, hold down the Temporary button for more than 10 seconds. Then, you will hear a "Pi" sound, and the light (green), light (green) and light (orange) lamps will blink quickly to indicate that the air conditioner has gone into a test run mode.
3. Wait for one minute to elapse, and then close the valve of liquid side.
4. It is recommended to attach a pressure gauge at the service port so that you can determine when refrigerant recovery has been completed.
5. Upon completion, close the valve of gas side.
6. Stop the air conditioner.
7. Power off the air conditioner.
 - Complete Steps 2 to 6 within five minutes. Otherwise, the protective device might trip, causing the outdoor unit to stop.
 - If the recovery operation has been interrupted by the protective device, turn off the air conditioner. In this case, use a refrigerant recovery device.

10. ADDRESS SETUP

10-1. Address Setup Procedure

When an outdoor unit and an indoor unit are connected, or when an outdoor unit is connected to each indoor unit respectively in the group operation even if multiple refrigerant lines are provided, the automatic address setup completes with power-ON of the outdoor unit. The operation of the remote controller is not accepted while automatic address works. (Approx. 4 to 5 minutes)

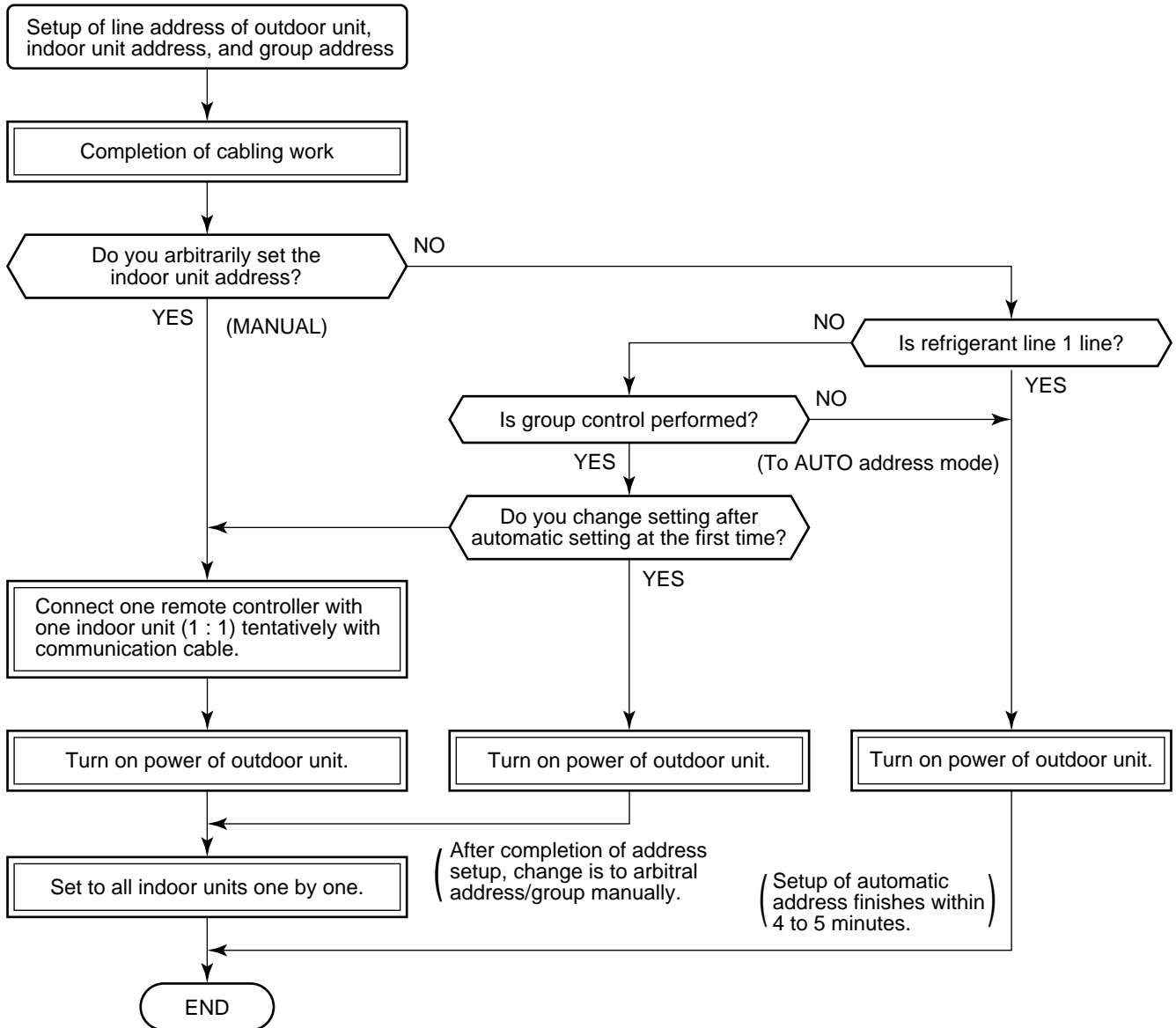

- When the following addresses are not stored in the neutral memory (IC503) on the indoor P.C. board, a test run operation cannot be performed. (Unfixed data at shipment from factory)

	Item code	Data at shipment	Setup data range
Line address	12	0099	0001 (No. 1 unit) to 0064 (No. 64 unit)
Indoor unit address	13	0099	0001 (No. 1 unit) to 0064 (No. 64 unit) Max. value of indoor units in the identical refrigerant line
Group address	14	0099	0000 : Individual (Indoor units which are not controlled in a group) 0001 : Master unit (1 indoor unit in group control) 0002 : Sub unit (Indoor units other than master unit in group control)

10-2. Address Setup & Group Control

<Terminology>

Indoor unit No. : N - n = Outdoor unit line address N (Max. 30) - Indoor unit address n (Max. 64)

Group address : 0 = Single (Not group control)
 1 = Master unit in group control
 2 = Sub unit in group control

Master unit (= 1) : The representative of multiple indoor units in group operation sends/receives signals to/from the remote controllers and sub indoor units.
 (* It has no relation with an indoor unit which communicates serially with the outdoor units.)
 The operation mode and setup temperature range are displayed on the remote controller LCD. (Except air direction adjustment of louver)

Sub unit (= 2) : Indoor units other than master unit in group operation
 Basically, sub units do not send/receive signals to/from the remote controllers.
 (Except errors and response to demand of service data)

Header unit (Representative unit) (Master Twin)

: This unit communicates with the indoor unit (follower) which serial-communicates with the outdoor units and sends/receives signal (Command from compressor) to/from the outdoor units as the representative of the cycle control in the indoor units of the identical line address within the minimum unit which configures one of the refrigerating cycles of Twin.

Follower unit (Subordinate unit) (Sub Twin)

: Indoor units excluding the header unit in Twin

This unit communicates with (Header) indoor unit in the identical line address and performs control synchronized with (Header) indoor unit.

This unit does not perform the signal send/receive operation with the outdoor units. :
 No judgment for serial signal error.

10-2-1. System Configuration

1. Single

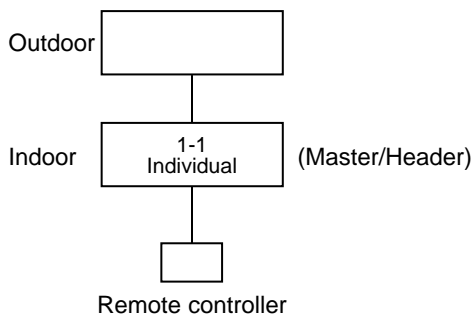

2. Twin

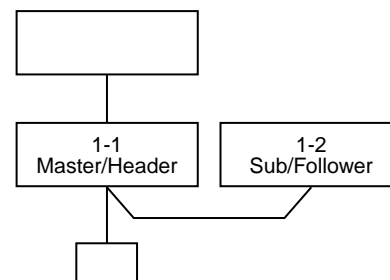

3. Triple

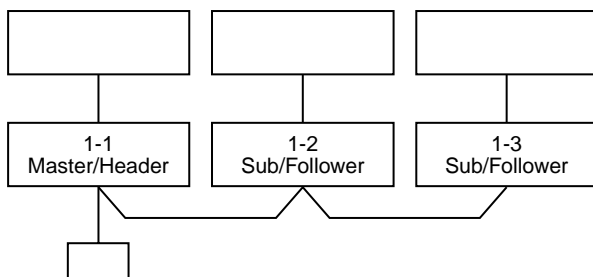

4. Single group operation

- Each indoor unit controls the outdoor unit individually.

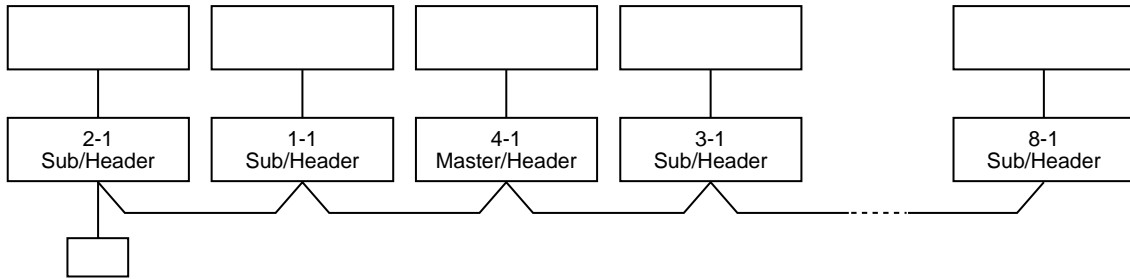

5. Multiple groups operation (Manual address setting)

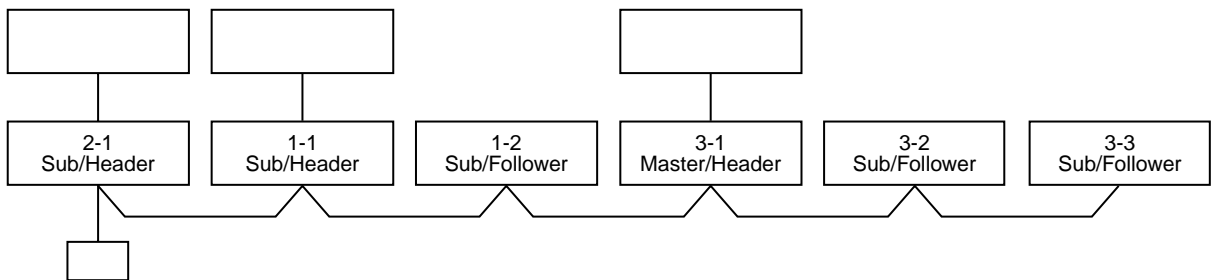

- Header unit: The header unit receives the indoor unit data (thermo status) of the follower (Without identical line address & indoor/outdoor serial) and then finally controls the outdoor compressor matching with its own thermo status. The header unit sends this command information to the follower unit.
- Follower unit: The follower unit receives the indoor unit data from the header (With identical line address & indoor/outdoor serial) and then performs the thermo operation synchronized with the header unit. The follower unit sends own thermo ON/OFF demand to the header unit.

(Example)

No. 1-1 header unit sends/receives signal to/from No. 1-2 and No. 1-3 follower units. (It is not influenced by the line 2 or 3 address indoor unit.)

10-2-2. Automatic Address Example from Unset Address (No miswiring)

1. Standard (One outdoor unit)

1) Single

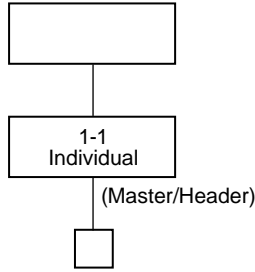

2) Twin

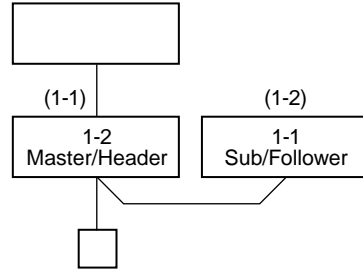

3) Triple

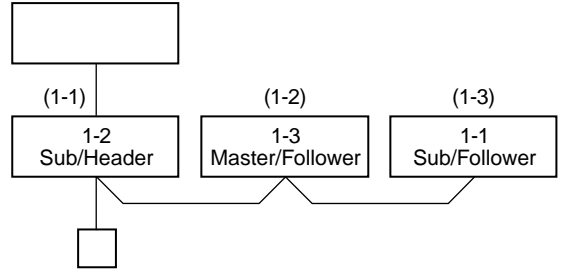

Only turning on source power supply (Automatic completion)

2. Group operation

(Multiple outdoor units = Multiple indoor units with serial communication only, without twin)

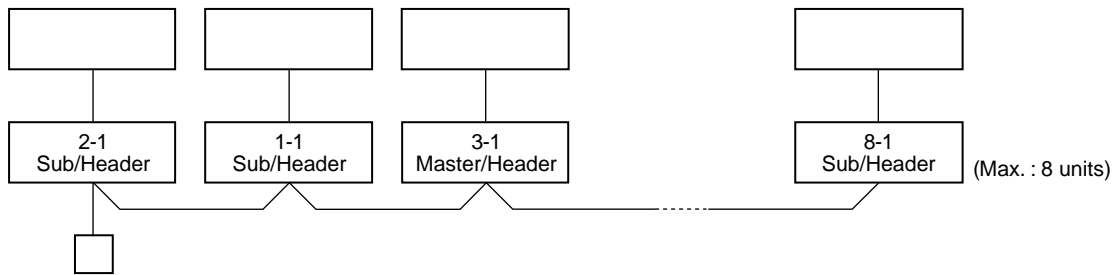

Only turning on source power supply (Automatic completion)

3. Multiple groups operation

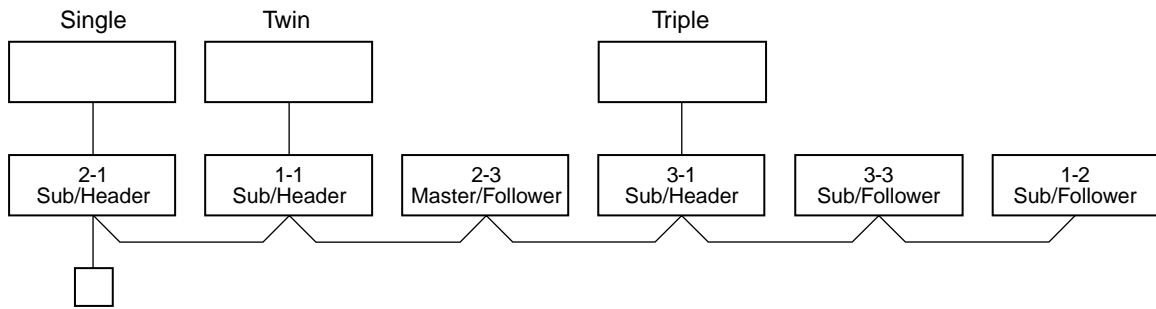

Change is necessary
Manually change addresses of the multiple follower units
simultaneously from the remote controller.

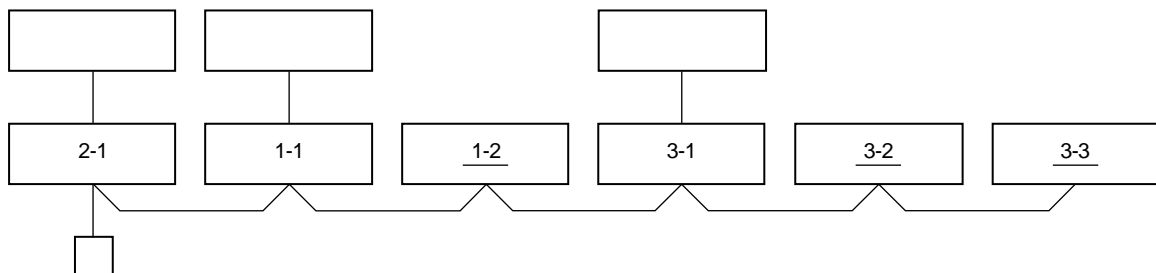

10-3. Remote Controller Wiring

- Strip off approx. 9 mm the wire to be connected.
- For single system, use non polarity, 2 core wire is used for wiring of the remote controller. (0.5 mm² to 2.0 mm² wires)
- For the synchronous twin, triple system, use 2-core shield wire (Vinyl cord for microphone 0.5 to 2.0 mm²) to conform to the EMC standard.

Wiring diagram

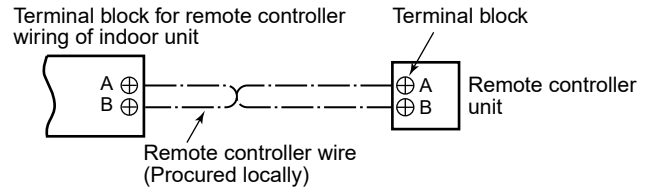

* For details of wiring/installation of the remote controller, refer to the Installation Manual enclosed with the remote controller.

Single system

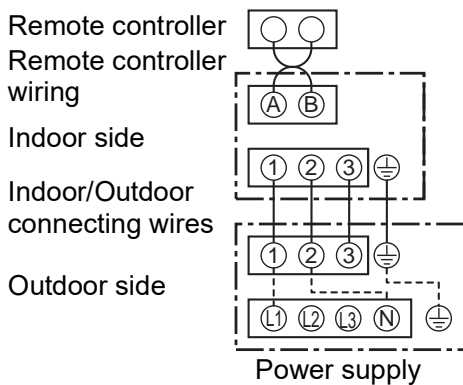

Simultaneous twin system

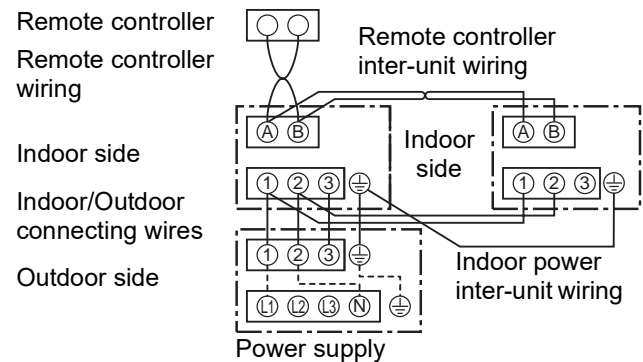

10-4. Address Setup (Manual setting from remote controller)

In case that addresses of the indoor units will be determined prior to piping work after cabling work

- Set an indoor unit per a remote controller.
- Turn on power supply.

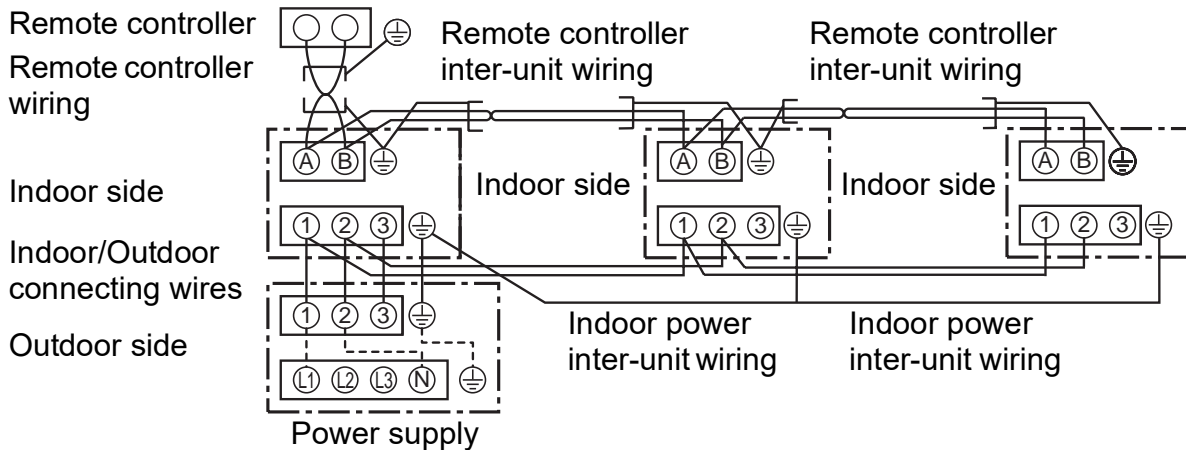

- 1** Push **SET** + **CL** + **TEST** buttons simultaneously for 4 seconds or more.
- 2** (**←** Line address)
Using the temperature setup **▼** / **▲** buttons, set **12** to the CODE No.
- 3** Using timer time **▼** / **▲** buttons, set the line address.
- 4** Push **SET** button. (OK when display goes on.)
- 5** (**←** Indoor unit address)
Using the temperature setup **▼** / **▲** buttons, set **13** to the CODE No.
- 6** Using timer time **▼** / **▲** buttons, set **1** to the line address.
- 7** Push **SET** button. (OK when display goes on.)
- 8** (**←** Group address)
Using the temperature setup **▼** / **▲** buttons, set **14** to the CODE No.
- 9** Using timer time **▼** / **▲** buttons, set **0000** to Individual, **0001** to Master unit, and **0002** to sub unit.
- 10** Push **SET** button. (OK when display goes on.)
- 11** Push **TEST** button.
Setup completes. (The status returns to the usual stop status.)

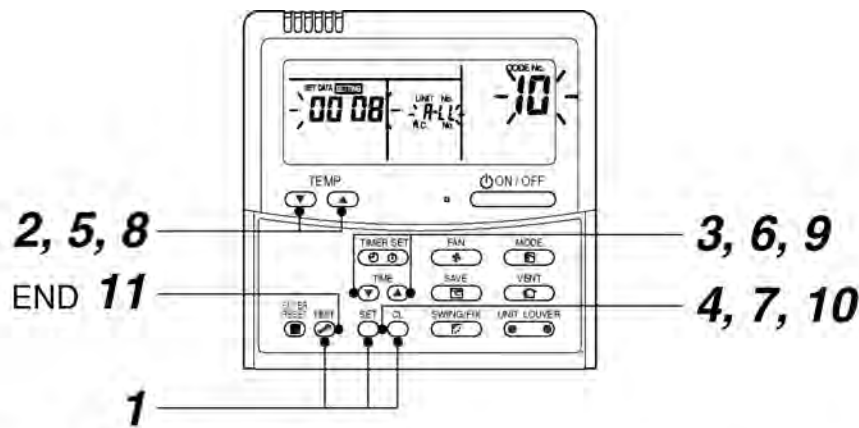

<Operation procedure>

1 → 2 → 3 → 4 → 5 → 6 → 7 → 8 → 9 → 10 → 11 END

10-5. Confirmation of Indoor Unit No. Position

1. To know the indoor unit addresses though position of the indoor unit body is recognized

- In case of individual operation (Wired remote controller : indoor unit = 1 : 1)
(Follow to the procedure during operation)

<Procedure>

- 1** Push **ON/OFF** button if the unit stops.
- 2** Push **UNIT LOUVER** button.

Unit No. **1-1** is displayed on LCD.

(It disappears after several seconds.)

The displayed unit No. indicate line address and indoor unit address.

(When other indoor units are connected to the identical remote controller (Group control unit), other unit numbers are also displayed every pushing **UNIT LOUVER** button.

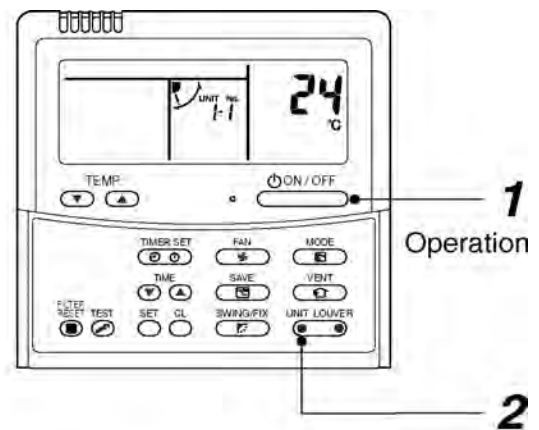

<Operation procedure>

1 → 2 END

2. To know the position of indoor unit body by address

- To confirm the unit No. in the group control
(Follow to the procedure during operation) (in this procedure, the indoor units in group control stop.)

<Procedure>

The indoor unit numbers in the group control are successively displayed, and fan, louver, and drain pump of the corresponding indoor unit are turned on.

(Follow to the procedure during operation)

- 1** Push **VENT** and **TEST** buttons simultaneously for **4 seconds or more**.

 - Unit No. **ALL** is displayed.
 - Fans and louvers of all the indoor units in the group control operate.
- 2** Every pushing **UNIT LOUVER** button, the unit numbers in the group control are successively displayed.

 - The unit No. displayed at the first time indicates the master unit address.
 - Fan and louver of the selected indoor unit only operate.
- 3** Push **TEST** button to finish the procedure.
All the indoor units in the group control stop.

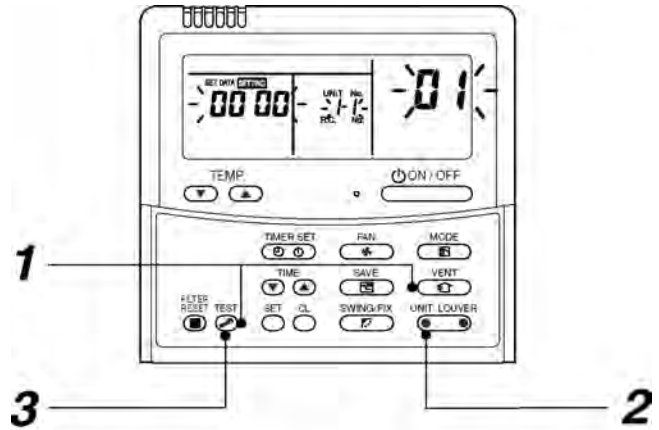

<Operation procedure>

1 → 2 → 3 END

<Maintenance/Check list>

Aiming in environmental preservation, it is strictly recommended to clean and maintain the indoor/outdoor units of the operating air conditioning system regularly to secure effective operation of the air conditioner.

It is also recommended to maintain the units once a year regularly when operating the air conditioner for a long time.

Check periodically signs of rust or scratches, etc. on coating of the outdoor units.

Repair the defective position or apply the rust resisting paint if necessary.

If an indoor unit operates for approx. 8 hours or more per day, usually it is necessary to clean the indoor/outdoor units once three months at least.

These cleaning and maintenance should be carried out by a qualified dealer.



Although the customer has to pay the charge for the maintenance, the life of the unit can be prolonged.

Failure to clean the indoor/outdoor units regularly will cause shortage of capacity, freezing, water leakage or trouble on the compressor.



Part name	Object		Contents of check	Contents of maintenance
	Indoor	Outdoor		
Heat exchanger	○	○	• Blocking with dust, damage check	• Clean it when blocking is found.
Fan motor	○	○	• Audibility for sound	• When abnormal sound is heard
Filter	○	—	• Visual check for dirt and breakage	• Clean with water if dirty • Replace if any breakage
Fan	○	○	• Visual check for swing and balance • Check adhesion of dust and external appearance.	• Replace fan when swinging or balance is remarkably poor. • If a large dust adheres, clean it with brush or water.
Suction/Discharge grille	○	—	• Visual check for dirt and scratch	• Repair or replace it if deformation or damage is found.
Drain pan	○	—	• Check blocking by dust and dirt of drain water.	• Clean drain pan, Inclination check
Face panel, Louver	○	—	• Check dirt and scratch.	• Cleaning/Coating with repair painting
External appearance	—	○	• Check rust and peeling of insulator • Check peeling and floating of coating film	• Coating with repair painting

11. DETACHMENTS



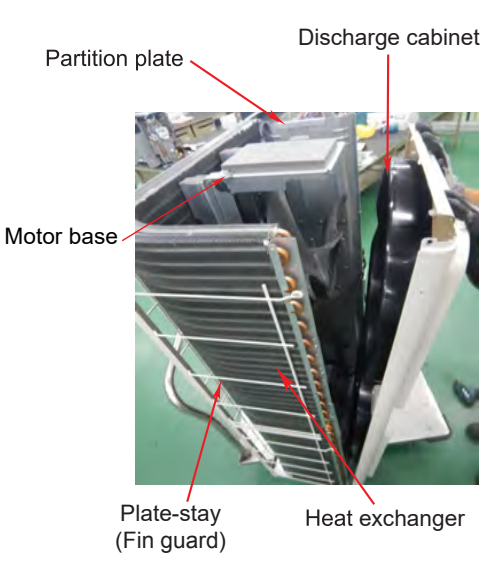
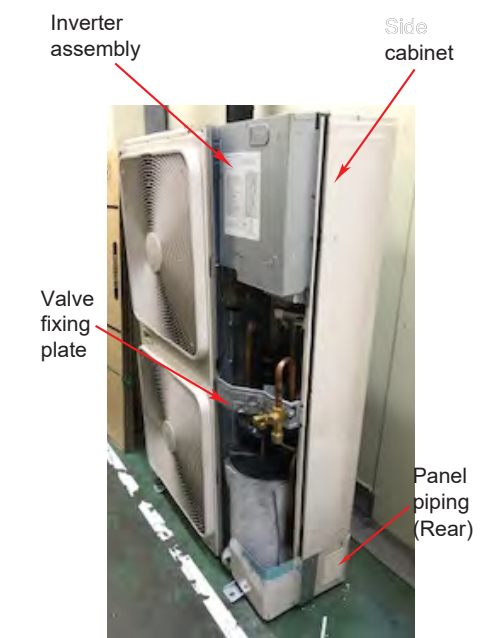

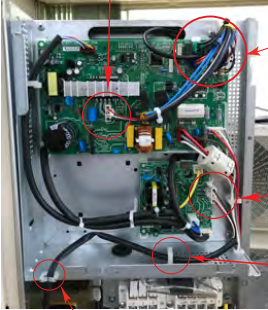
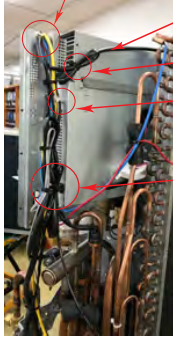
Outdoor Unit



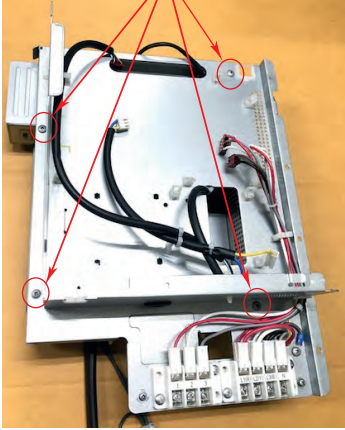
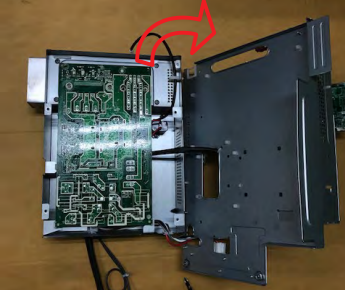
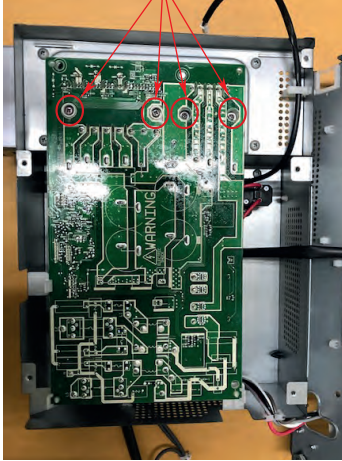
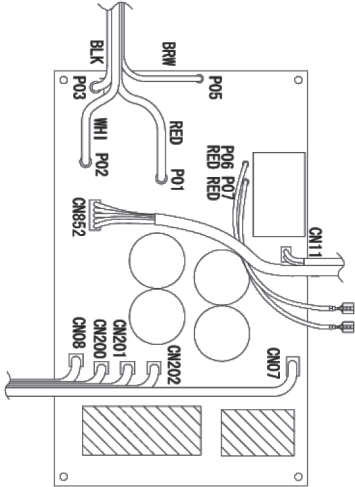

No.	Part name	Procedure	Remarks
①	Common procedure	<hr/> <p style="text-align: center;">CAUTION</p> <p>Be sure to put on the gloves at working time; otherwise an injury may be caused by a part, etc.</p> <hr/> <p>1. Detachment</p> <ol style="list-style-type: none"> 1) Stop operation of the air conditioner and then turn off switch of the circuit breaker. 2) Take off the front panel. (HEX-ST-SCREW Ø4 × 10, 2 pcs.) * After Take off screws, Take off the front cabinet while pulling it downward. 3) Take off the power wire and indoor/outdoor connecting wire from the cord clamp and the terminals. 4) Take off the upper cabinet. (HEX-ST-SCREW Ø4 × 10, 5 pcs.) <p>2. Attachment</p> <ol style="list-style-type: none"> 1) Attach the upper cabinet. (HEX-ST-SCREW Ø4 × 10, 5 pcs.) 2) Connect the power supply wire and the indoor/outdoor connecting wire to the terminal and mounting with cord clamp. <hr/> <p style="text-align: center;">CAUTION</p> <p>Using bundling band on the market, be sure to fix the power wire and indoor/outdoor connecting wire along the crossover pipe so that they do not come to contact with the compressor, valve at gas side, pipe at gas side and discharge pipe.</p> <hr/> <ol style="list-style-type: none"> 3) Attach the front cabinet. (HEX-ST-SCREW Ø4 × 10, 2 pcs.) 	 <p style="text-align: right;">Front cabinet</p>  <p style="text-align: right;">Upper cabinet</p>

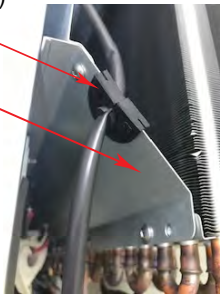

No.	Part name	Procedure	Remarks
②	Discharge port cabinet	<p>1. Detachment</p> <ol style="list-style-type: none"> 1) Carry out work of 1 of ①. 2) Take off screws for the discharge cabinet and the partition plate. (ST1T Ø4 × 10, 4 pcs.) 3) Take off screws for the discharge cabinet and the bottom plate. (HEX-ST-SCREW Ø4 × 10, 2 pcs.) 4) Take off screws of the discharge cabinet and the motor base. (ST1T Ø4 × 10, 2 pcs.) 5) Take off screws of the discharge cabinet and the heat exchanger. (ST2T Ø4 × 10, 1 pcs.) 6) Take off screws of the discharge cabinet and the plate-stay (HEX-ST-SCREW Ø4 × 10, 2 pcs.) 	<p>Remarks</p> 
③	Side cabinet	<ol style="list-style-type: none"> 1) Carry out work of 1 of ①. 2) Take off screws which fix the inverter assembly and the side cabinet. (ST1T Ø4 × 10, 3 pc.) 3) Take off screws of the side cabinet and the valve fixing plate. (HEX-ST-SCREW Ø4 × 10, 2 pcs.) 4) Take off screws of the side cabinet and the pipe panel (Rear). (HEX-ST-SCREW Ø4 × 10, 2 pcs.) 5) Take off screws of the side cabinet and the bottom plate. (HEX-ST-SCREW Ø4 × 10, 1 pc.) 6) Take off screws of the side cabinet and the heat exchanger. (HEX-ST-SCREW Ø4 × 10, 3 pcs.) and (ST1T Ø4 × 14, 2 pcs.) 7) Slide the side cabinet upward and then take off it. (Hook of inverter) 	

No.	Part name	Procedure	Remarks
④	Inverter box	<p>1. How to remove</p> <p>1) Proceed 1 of ①.</p> <hr/> <p style="text-align: center;">⚠ WARNING</p> <p>Never disassemble the inverter for 3 minutes after power has been turned off because an electric shock may be caused.</p> <hr/> <p>2) Take off the inverter cover. Take off screws between the inverter cover and the inverter box. (CTT2T Ø4 × 10, 1 pcs.)</p> <p>3) Take off the connector that connecting with control board. (TD, TS, TE, TL, TO-Sensor, COIL PMV, ASM-THERMO-COMP, ASM-HP-SW, ASM-COIL-4WAY, FAN-MOTOR (UPPER and LOWER) *Take off the connectors by pulling the connector body. Do not pull the wire. *Connectors should be removed after unlocking the housing section.</p> <p>4) Take off lead of FAN-MOTOR (LOWER) from EDGE-SADDLE and WIRE-SADDLE.</p> <p>5) Cut the CABLE-TIE that cover lead of FAN-MOTOR (UPPER), Take off lead of TD, TS, TE, TL, TO-Sensor, COIL PMV, ASM-THERMO-COMP, ASM-COIL-4WAY and ASM-HP-SW from EDGE-SADDLE, WIRE-SADDLE and CABLE-CLAMP.</p> <p>6) Take off lead of REACTOR from REACTOR.</p> <p>7) Take off terminal cover of compressor, take off lead of compressor from compressor and CORD-CLAMP.</p> <p>8) Lift the ASM-BOX-INV up.</p>	<p>Inverter cover</p>  <p>Screw</p> <p>FAN-MOTOR (UPPER)</p>  <p>TD, TS, TE, TL, TO-Sensor, COIL PMV, ASM-THERMO-COMP, ASM-HP-SW, ASM-COIL-4WAY</p> <p>FAN-MOTOR (LOWER)</p> <p>EDGE-SADDLE</p> <p>WIRE-SADDLE</p>  <p>Lead of FAN-MOTOR (UPPER)</p> <p>CABLE-TIE</p> <p>EDGE-SADDLE</p> <p>CABLE-CLAMP</p>  <p>Lead of REACTOR</p>  <p>Lead of compressor</p>



No.	Part name	Procedure	Remarks
⑥	P.C.Board (for compressor drive) MCC-1627	<p>1. Detachment</p> <p>1) Carry out work 1 of ⑤.</p> <hr/> <p>⚠ WARNING</p> <p>Never disassemble the inverter for 3 minutes after power has been turned off because an electric shock may be caused.</p> <hr/> <p>2) Take off screw 4 pcs. and life the PL-FIX-CDB up.</p> <p>3) Take off screw for fixing the P.C.Board (for compressor drive) with HEAT-SINK.</p> <p>4) Take off the P.C.Board (for compressor drive) from 3 PCB mounts.</p> <p>5) Take off all the connectors and faston terminals connected to the P.C.Board.</p> <p>*Take off connectors by pulling the connector body. Do not pull the wire.</p> <p>*connectors should be remove after unlocking the housing section.</p> <p>CN11 : Relay input (2P: White)</p> <p>CN852 : UART Communication (6P: Red)</p> <p>CN07,08 : Reactor (1P: faston terminal)</p> <p>CN200,201,202: Compressor (1P: faston terminal)</p> <p>2. Attachment</p> <p>1) Mount the individual components in the opposite procedure to that during detachment.</p> <hr/> <p>⚠ CAUTION</p> <p>Be sure that all the connectors are connected correctly and securely inserted. If the components on the P.C.board were bent during this procedure, straighten them so they do not touch other parts.</p> <hr/>	<p>Screw</p>   <p>4 Screw for P.C.Board(MCC-1627)</p>  

No.	Part name	Procedure	Remarks
⑦	Fan motor	<p>1) Carry out works of 1 of ① and ②.</p> <p>2) Take off the flange nut fixing the fan motor and the propeller fan. * The flange nut is loosened by turning clockwise. (To tighten it, turn it counterclockwise.)</p> <p>3) Take off the propeller fan 2 pcs.</p> <p>4) Take off the connector for fan motor from the inverter.</p> <p>5) Take off the fan motor lead from the fan motor lead fixing rubber of the penetrated part of the partition plate.</p> <p>6) Take off the fixing screws (4 pcs. each) while supporting the fan motor so that it does not fall.</p> <p>* Cautions when assembling the fan motor</p> <p>* Tighten the flange nut with 6.86N·m (70kgf.cm).</p> <p>* Adjust length on the fan motor lead fixing rubber so that the fan motor lead does not slacken in order not to put the fan motor lead into contact with the propeller fan. Attach the fan motor lead fixing rubber to the partition plate so that projection directs to the refrigerating cycle side.</p> <p>* Be sure to bind the removed bundling band with the bundling band on the market.</p> <hr/> <p style="text-align: center;">⚠ CAUTION</p> <p>Use the metal band of the motor base to fix the fan motor lead on the motor base so that the fan motor lead does not come to contact with the propeller fan.</p> <hr/>	<p>Propeller fan</p> <p>Loosened by turning clockwise</p>  <p>Frange nut</p> <p>Fan motor (Upper)</p>  <p>Fan motor (Lower)</p> <p>Fan motor (Upper) lead fixing rubber</p> <p>Partition plate</p>  <p>Fan motor (Upper) lead fixing rubber</p> 

No.	Part name	Procedure	Remarks
⑧	Compressor	<p>1. Removal of broken compressor</p> <ol style="list-style-type: none"> 1) Take off the refrigerant gas. 2) Carry out works of 1 of ① and ②, ③, ④. 3) Take off the piping panel (Front). Take off screws of the piping panel (Front) and the bottom plate. (ST1T Ø4 × 10, 2 pcs.) Take off screws of the piping panel (Front) and the piping panel (Rear). (ST1T Ø4 × 10, 1 pc.) 4) Take off the piping panel (Rear). Take off screws of the piping panel (Rear) and the bottom plate. (ST1T Ø4 × 10, 2 pcs.) 5) Take off the valve fixing plate. Take off bolts of the valve. (Hexagonal screw Ø6 × 15, 4 pcs.) Take off screws of the valve fixing plate and the partition plate. (ST1T Ø4 × 10, 1 pc.) Take off screws of the valve fixing plate and the reinforcing plate. (ST1T Ø4 × 10, 1 pc.) 6) Take off TD sensor fixed to the discharge pipe. 7) Take off the sound insulating plate. (Upper side, Inside, outer winding) 8) Take off terminal cover from the compressor and then remove the compressor lead and also the ASM-THERMO-COMP. 9) Using a burner, remove the discharge pipe and the suction pipe connected to the compressor. <hr/> <p style="text-align: center;">⚠ WARNING</p> <p>In case of take off the piping by broiling the welded part with a burner, if the piping includes oil, it may burst into flames at the moment when wax melted, so take sufficient care.</p> <hr/> <p style="text-align: center;">⚠ CAUTION</p> <p>Note so that the flame does not catch the PMV and High pressure switch. (An operation may become an error.)</p> <hr/> <ol style="list-style-type: none"> 10) Pull off the discharge pipe and the suction pipe of the refrigerating cycle upward. 11) Take off the compressor bolts which fix the compressor to the bottom plate. (3 pcs.) 12) Pull out the compressor toward you. 	 <p>Piping panel (Front)</p> <p>Piping panel (Rear)</p>  <p>TD sensor</p>  <p>Take off (Discharge pipe)</p> <p>Take off (Suction pipe)</p>  <p>Compressor bolt (4 pcs.)</p>

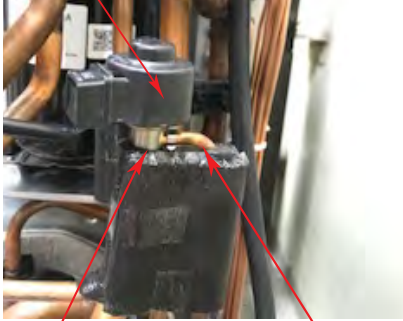
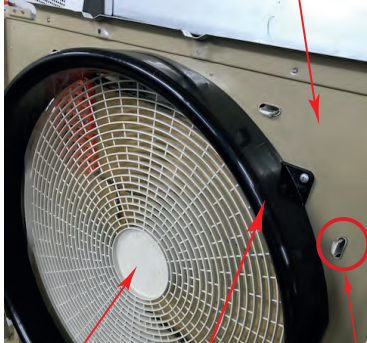
No.	Part name	Procedure	Remarks
⑧	Compressor (Continued)	<p>2. Mounting of compressor</p> <p>1) Mount the compressor in the reverse procedure of removal.</p> <p>NOTES:</p> <ul style="list-style-type: none"> * After exchange of the compressor, be sure to exchange the compressor lead. In this time, the compressor lead does not contact with the discharge pipe. * As shown in the right figure, mount the soundproof plate by inserting between the compressor and the piping, and between piping and the partition plate. * Put the compressor lead wire and the compressor case thermo between partition plate and the soundproof as if dropping them in. 	 <p>(SOUND-INSU inside)</p>  <p>(SOUND-INSU out side)</p>  <p>(TD-Sensor)</p> <p>(SOUND-INSU upper)</p>

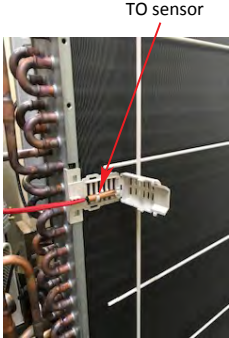
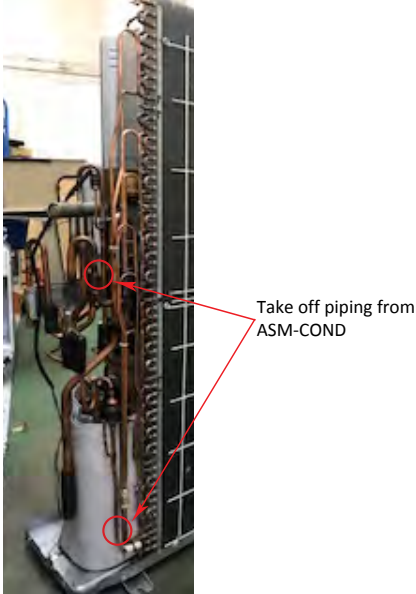
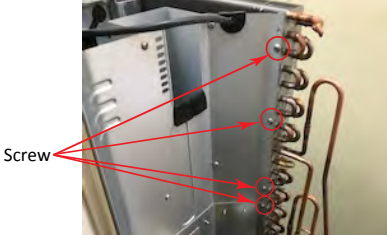
No.	Part name	Procedure	Remarks
⑨	PMV coil	<p>1. Detachment</p> <ol style="list-style-type: none"> 1) Carry out works of 1 of ① and ③. 2) While pulling the coil upward and removing the spring which pinches the copper pipe, take off the coil from PMV main body. <p>2. Attachment</p> <ol style="list-style-type: none"> 1) Match the spring to the copper pipe and fix it. 	 <p>PMV coil</p> <p>PMV main body</p> <p>Spring</p>
⑩	Fan guard	<p>1. Detachment</p> <ol style="list-style-type: none"> 1) Carry out works of 1 of ① and ②. <hr/> <p style="text-align: center;">CAUTION</p> <p>To prevent scratching on the product, handle the product on a cardboard or cloth.</p> <hr/> <ol style="list-style-type: none"> 2) Take off the discharge port cabinet and then put on it so that the fan guard side directs downward. 3) Take off the hooking claws (8 positions) of the fan guard. <p>2. Attachment</p> <ol style="list-style-type: none"> 1) Push the hooking claws (8 positions) with hands from the front side to fix the claws. <hr/> <p style="text-align: center;">CAUTION</p> <p>Check that all the hooking claws are fixed at the specified positions.</p> <hr/>	 <p>Discharge port cabinet</p> <p>Fan guard</p> <p>Bell mouth</p> <p>Hooking claw</p>

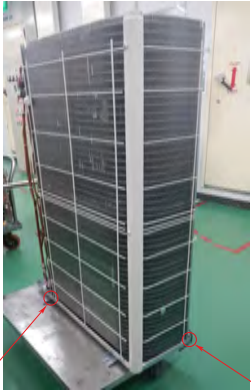
No.	Part name	Procedure	Remarks
①	Heat exchanger	<p>1. How to remove the frame of heat exchanger</p> <ol style="list-style-type: none"> 1) Recover the refrigerant gas. 2) Proceed 1 of ①, ②, ③, ④. 3) Take off TO-sensor. 4) Using a burner remove the discharge pipe connected to the ASM-COND. 5) Take off screws between the assembly of heat exchanger and the partition board. and SUB PARTITION.(ST1T Ø4 × 10, 5 pcs.) 6) Take off screws between the assembly of heat exchanger and the bottom plate.(ST1T Ø4 × 10, 2 pcs.) 7) Pull the back side of the assembly of heat exchanger. <p>2. How to attach the assembly of heat exchanger (maintenance part)</p> <ol style="list-style-type: none"> 1) Proceed through the reverse order of how to remove <ul style="list-style-type: none"> ※The pipe fixing plate and pipe cover that come with the assembly of heat exchanger, before replacement, are just for shipping. There is no need to attach them. However, make sure to fasten a screw that attach the pipe fixing plate (ST1T Ø4 × 10, 1 pcs.) to the assembly of heat exchanger, after replacement. <p>NOTES:</p> <p>※Don't remove the cap from the joint of the assembly of heat exchanger (maintenance part) till you braze. And don't neglect the assembly of heat exchanger (maintenance part) without cap for a long time.</p>	 <p>TO sensor</p>  <p>Take off piping from ASM-COND</p>  <p>Screw</p>  <p>Screw</p>  <p>SCREW</p>

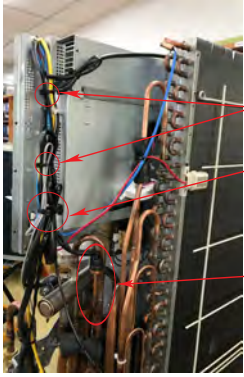
No.	Part name	Procedure	Remarks
⑫	High pressure switch	<p>1. Detachment</p> <ol style="list-style-type: none"> 1) Recover the refrigerant gas. 2) Carry out works of 1 of ①. 3) Take off the inverter cover. take off screws between the inverter cover and the inverter box. (CTT2T Ø4 × 10, 1 pcs.) 4) Cut the CABLE-TIE that fixate high pressure switch lead line. 5) Take off the connector for high pressure switch from the inverter. 6) Using a burner, take off the High pressure switch. 	<p>High pressure switch connector</p> <p>CABLE-TIE</p>  <p>Cut CABLE-TIE</p> <p>CABLE-CLAMP</p> <p>High pressure switch</p> 

12. EXPLODED VIEWS AND PARTS LIST

Outdoor Unit

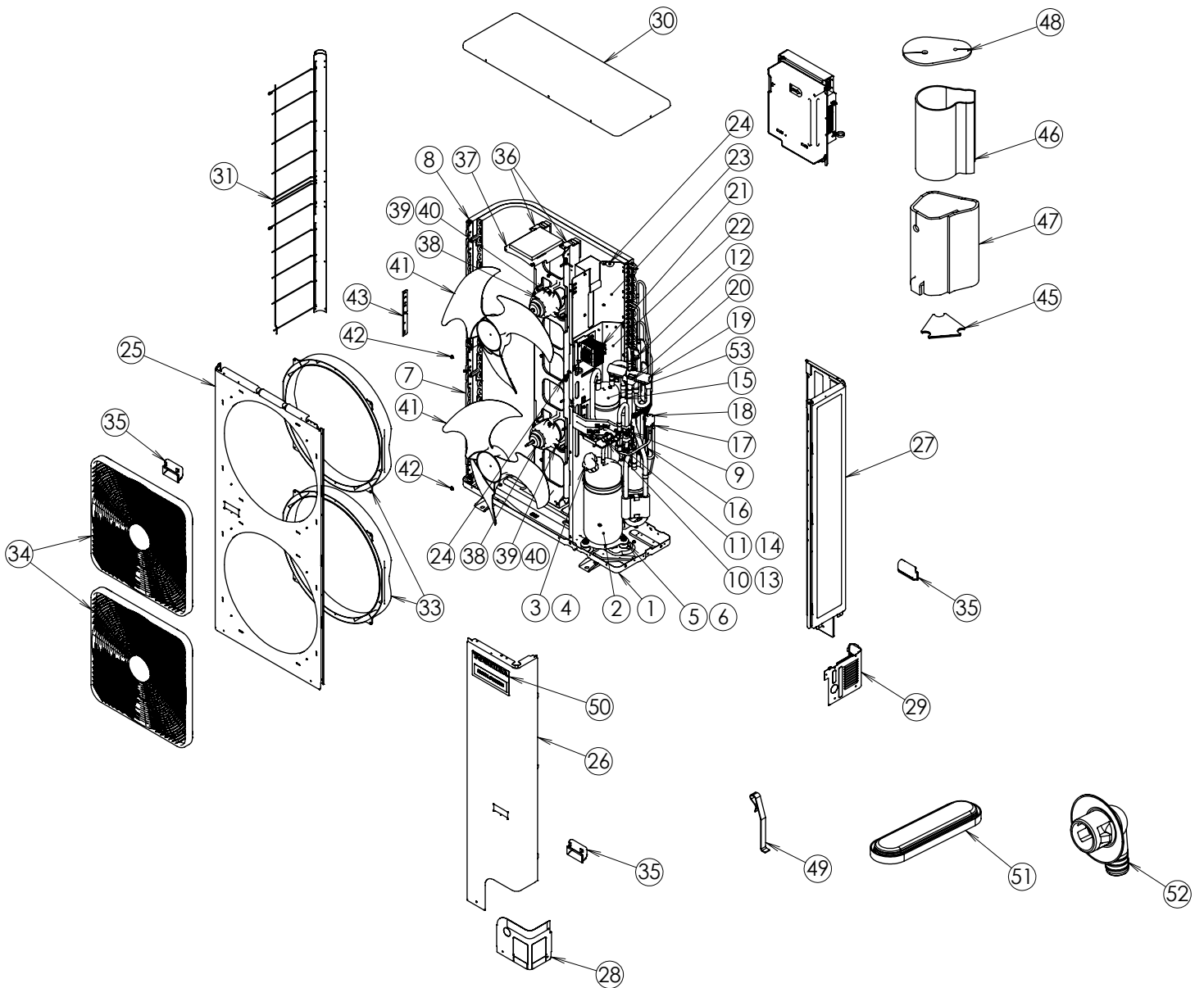

Location No.	Part No.	Description	Model name RAV-GM		
			1601AT8P-E	1601AT8JP-E	1601AT8P-TR
1	43T42373	BASE PLATE ASSEMBLY	1	1	1
2	43T41545	COMPRESSOR(RX380A2T-20M)	1	1	1
3	43T54319	BIMETAL-THERMO	1	1	1
4	43T50307	HOLDER-THERMO	1	1	1
5	43T49357	RUBBER,CUSHION	3	3	3
6	43T97326	COMPRESSOR NUT	3	3	3
7	43T43626	DOWN CONDENSER ASSEMBLY	1	-	1
7	43T43628	DOWN CONDENSER WORKING	-	1	-
8	43T43627	UPPER CONDENSER ASSEMBLY	1	-	1
8	43T43629	UPPER CONDENSER WORKING	-	1	-
9	43T00781	VALVE FIXING PLATE COATING	1	1	1
10	43T46380	VALVE;PACKED 9.52 DIA	1	1	1
11	43T46456	VALVE, BALL, SBV-JA6GTC-1	1	1	1
12	43T63385	HIGH PRESSURE SWITCH ASSEMBLY	1	1	1
13	43T47404	BONNET, 9.52 DIA	1	1	1
14	43T47411	BONNET (19.1D)	1	1	1
15	43T47400	STRAINER	1	1	1
16	43T47414	STRAINER	1	1	1
17	43T46387	VALVE,PULSE,MODULATING	1	1	1
18	43T63384	COIL PMV ASSEMBLY	1	1	1
19	43T46512	4WAY VALVE	1	1	1
20	43T63382	COIL 4WAY ASSEMBLY	1	1	1
21	43T58344	REACTOR(CH-86-2Z-T)	1	1	1
22	43T00782	SPOT WELDING PARTITION COAT ASSEMBLY	1	1	1
23	43T00783	PARTITION SUB COAT ASSEMBLY	1	1	1
24	43T96305	BUSHING	1	1	1
25	43T00786	AIR OUTLET CABINET	1	1	1
26	43T00784	FRONT PANEL ASSEMBLY	1	1	1
27	43T00785	RIGHT PANEL ASSEMBLY	1	1	1
28	43T00608	ASM-COAT-P-P-FR	1	1	1
29	43T00609	ASM-COAT-P-P-BK	1	1	1
30	43T00611	ASM-CABI-UP	1	1	1
31	43T00726	GUARD FIN ASSEMBLY	1	1	1
32	43T00727	GUARD FIN BACK	1	1	1
33	43T22313	BELLMOUTH	1	1	1
34	43T19372	FAN GUARD	1	1	1
35	43T71302	HANDLE	1	1	1
36	43T39413	PLATE SUPPORT MOTOR ASSEMBLY	1	1	1
37	43T39412	BASE MOTOR ASSEMBLY	1	1	1
38	43T21502	FAN MOTOR ASSEMBLY	1	1	1
39	43T97327	SCREW	4	4	4
40	43T22321	COLLAR	4	4	4
41	43T20352	FAN-PR(PB522)	1	1	1
42	43T39346	NUT FLANGE	1	1	1
43	43T43630	COAT PLATE COND ASSEMBLY	1	1	1
45	43T04389	INSULATION SOUND UNDERSIDE	1	1	1
46	43T04312	SOUND-INSU(IS)	1	1	1
47	43T04387	INSULATION SOUND OUTSIDE	1	1	1
48	43T04439	INSULATION SOUND UPPERSIDE	1	1	1
49	43T19333	HOLDER, SENSOR	1	1	1
50	43T85553	MARK-T	1	1	1
51	43089160	CAP, WATERPROOF	5	5	5
52	43T79305	DRAIN NIPPLE	1	1	1
53	43T48324	ACCUMULATOR ASSEMBLY	1	1	1

Inverter assembly

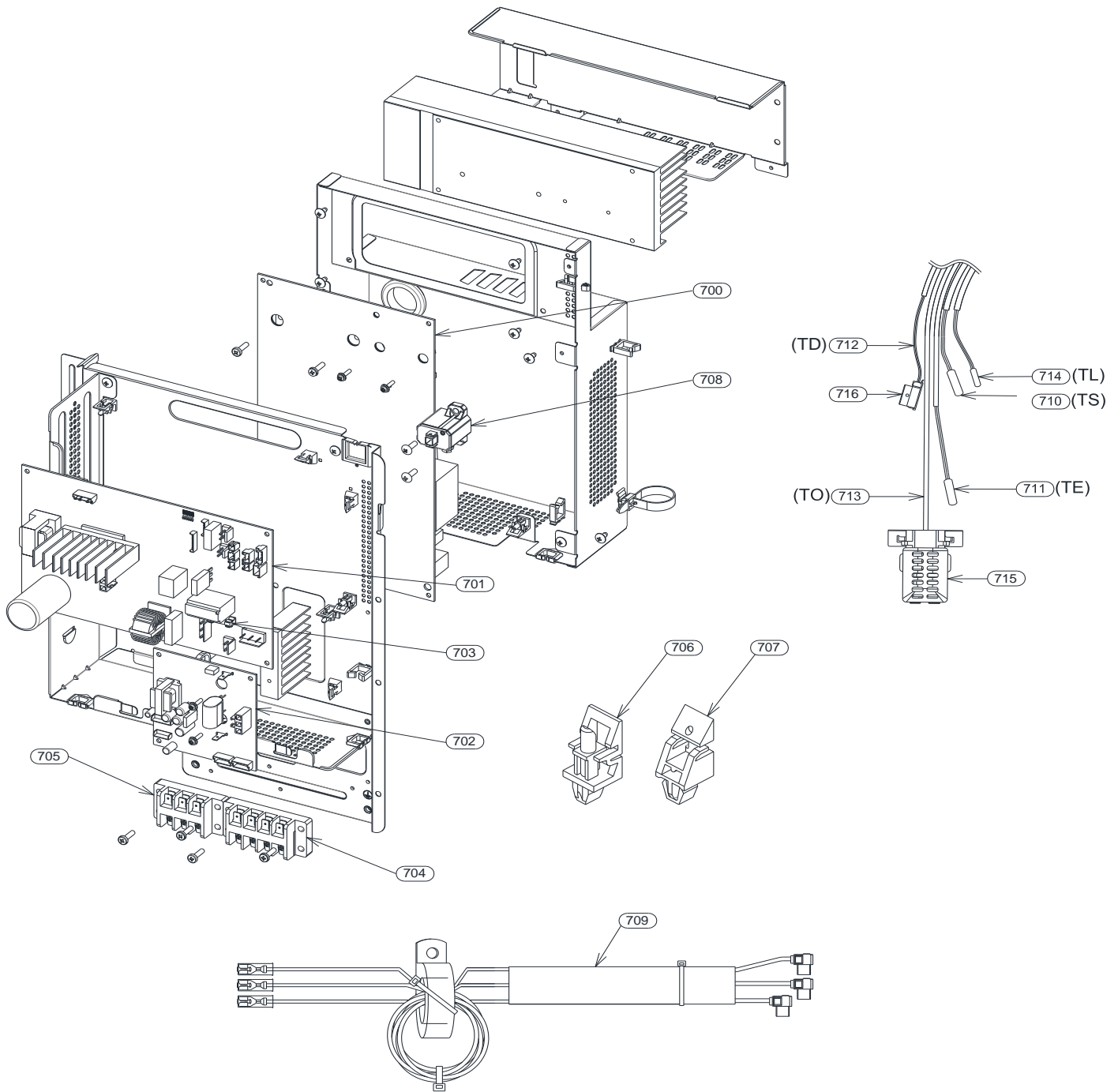

Location No.	Part No.	Description	Location No.	Part No.	Description
700	43T6W815	PC BOARD ASSY IPDU	709	43T60519	COMP LEAD ASSY
701	43T6W758	PC BOARD ASSY CDB & FAN UPPER	710	43T50372	TEMPERATURE SENSOR,TS
702	43T6W461	PC BOARD ASSY FAN LOWER	711	43T50385	TEMPERATURE SENSOR,TE
703	43T60413	FUSE (CHINA)	712	43T50376	SENSOR-TD
704	43T60419	TERMINAL;4P	713	43T50337	TEMPERATURE SENSOR,TO
705	43T60331	TERMINAL, 3P	714	43T50335	TEMPERATURE SENSOR
706	43T95301	SUPPORT, SPACER	715	43T63335	SENSOR HOLDER
707	43T95302	SPACER(EDGE)	716	43T63323	HOLDER,SENSOR
708	43T50345	THERMISTOR,PTC			

WARNINGS ON REFRIGERANT LEAKAGE

Check of Concentration Limit

The room in which the air conditioner is to be installed requires a design that in the event of refrigerant gas leaking out, its concentration will not exceed a set limit.

The refrigerant R32 which is used in the air conditioner is safe, without the toxicity or combustibility of ammonia, and is not restricted by laws to be imposed which protect the ozone layer. However, since it contains more than air, it poses the risk of suffocation if its concentration should rise excessively. Suffocation from leakage of R32 is almost non-existent.

If a conditioner system is to be installed in a small room, select a suitable model and installation procedure so that if the refrigerant accidentally leaks out, its concentration does not reach the limit (and in the event of an emergency, measures can be made before injury can occur).

In a room where the concentration may exceed the limit, create an opening with adjacent rooms, or install mechanical ventilation combined with a gas leak detection device.

The concentration is as given below.

$$\frac{\text{Total amount of refrigerant (kg)}}{\text{Min. volume of the indoor unit installed room (m}^3\text{)}} \leq \text{Concentration limit (kg/m}^3\text{)}$$

Refrigerant concentration limit shall be in accordance with local regulations.

Toshiba Carrier (Thailand) Co., Ltd.

**144/9 MOO 5, BANGKADI INDUSTRIAL PARK, TIVANON ROAD, TAMBOL BANGKADI,
AMPHUR MUANG, PATHUMTHANI 12000, THAILAND.**