

TOSHIBA

SERVICE MANUAL

AIR-CONDITIONER

(SPLIT TYPE)

INDOOR UNIT <DIGITAL INVERTER>

Concealed Duct Type

RAV-GM901BTP Series

R32



March, 2020

NOTE

A direct current motor is adopted for indoor fan motor in the Concealed Duct Standard Type air conditioner. Caused from its characteristics, a current limit works on the direct current motor. When replacing the high-performance filter or when opening the service board, be sure to stop the fan. If an above action is executed during the fan operation, the protective control works to stop the unit operation, and the check code "P12" may be issued. However it is not a trouble. When the desired operation has finished, be sure to reset the system to clear "P12" error code using the leak breaker of the indoor unit. Then push the operation stop button of the remote controller to return to the usual operation.

CONTENTS

Original instruction	4
Warning Indications on the Air Conditioner Unit	6
Precaution for Safety	7
New Refrigerant (R32)	14
1. Safety Caution Concerned to New Refrigerant	14
2. Cautions on Installation/Service	14
3. Pipe Materials	14
1. AIR DUCTING WORK	16
2. CONSTRUCTION VIEWS (EXTERNAL VIEWS)	17
3. WIRING DIAGRAM	19
4. SPECIFICATIONS OF ELECTRICAL PARTS	20
5. CONTROL BLOCK DIAGRAM	21
5-1. Indoor Controller Block Diagram	21
5-2. Control Specifications	24
5-3. Indoor Print Circuit Board	34
6. TROUBLESHOOTING	36
6-1. Summary of Troubleshooting	36
6-2. Check Code List (Indoor)	41
6-3. Diagnostic Procedure for Each Check Code (Indoor Unit)	46
7. REPLACEMENT OF SERVICE P.C. BOARD	58

8. SETUP AT LOCAL SITE AND OTHERS	63
8-1. Indoor Unit.....	63
8-2. Setup at Local Site / Others	73
8-3. How to Set up Central Control Address Number	75
9. ADDRESS SETUP	77
9-1. Address Setup	77
9-2. Address Setup & Group Control.....	78
9-3. Address Setup (Manual Setting from Remote Controller).....	81
9-4. Confirmation of Indoor Unit No. Position	82
10. DETACHMENTS	83
11. EXPLODED VIEWS AND PARTS LIST	89

SAFETY CAUTION

Please read carefully through these instructions that contain important information which complies with the “Machinery” Directive (Directive 2006/42/EC), and ensure that you understand them.

Generic Denomination: Air Conditioner

Definition of Qualified Installer or Qualified Service Person

The air conditioner must be installed, maintained, repaired and removed by a qualified installer or qualified service person. When any of these jobs is to be done, ask a qualified installer or qualified service person to do them for you.

A qualified installer or qualified service person is an agent who has the qualifications and knowledge described in the table below.

Agent	Qualifications and knowledge which the agent must have
Qualified installer	<ul style="list-style-type: none"> • The qualified installer is a person who installs, maintains, relocates and removes the air conditioners made by Toshiba Carrier Corporation. He or she has been trained to install, maintain, relocate and remove the air conditioners made by Toshiba Carrier Corporation or, alternatively, he or she has been instructed in such operations by an individual or individuals who have been trained and is thus thoroughly acquainted with the knowledge related to these operations. • The qualified installer who is allowed to do the electrical work involved in installation, relocation and removal has the qualifications pertaining to this electrical work as stipulated by the local laws and regulations, and he or she is a person who has been trained in matters relating to electrical work on the air conditioners made by Toshiba Carrier Corporation or, alternatively, he or she has been instructed in such matters by an individual or individuals who have been trained and is thus thoroughly acquainted with the knowledge related to this work. • The qualified installer who is allowed to do the refrigerant handling and piping work involved in installation, relocation and removal has the qualifications pertaining to this refrigerant handling and piping work as stipulated by the local laws and regulations, and he or she is a person who has been trained in matters relating to refrigerant handling and piping work on the air conditioners made by Toshiba Carrier Corporation or, alternatively, he or she has been instructed in such matters by an individual or individuals who have been trained and is thus thoroughly acquainted with the knowledge related to this work. • The qualified installer who is allowed to work at heights has been trained in matters relating to working at heights with the air conditioners made by Toshiba Carrier Corporation or, alternatively, he or she has been instructed in such matters by an individual or individuals who have been trained and is thus thoroughly acquainted with the knowledge related to this work.
Qualified service person	<ul style="list-style-type: none"> • The qualified service person is a person who installs, repairs, maintains, relocates and removes the air conditioners made by Toshiba Carrier Corporation. He or she has been trained to install, repair, maintain, relocate and remove the air conditioners made by Toshiba Carrier Corporation or, alternatively, he or she has been instructed in such operations by an individual or individuals who have been trained and is thus thoroughly acquainted with the knowledge related to these operations. • The qualified service person who is allowed to do the electrical work involved in installation, repair, relocation and removal has the qualifications pertaining to this electrical work as stipulated by the local laws and regulations, and he or she is a person who has been trained in matters relating to electrical work on the air conditioners made by Toshiba Carrier Corporation or, alternatively, he or she has been instructed in such matters by an individual or individuals who have been trained and is thus thoroughly acquainted with the knowledge related to this work. • The qualified service person who is allowed to do the refrigerant handling and piping work involved in installation, repair, relocation and removal has the qualifications pertaining to this refrigerant handling and piping work as stipulated by the local laws and regulations, and he or she is a person who has been trained in matters relating to refrigerant handling and piping work on the air conditioners made by Toshiba Carrier Corporation or, alternatively, he or she has been instructed in such matters by an individual or individuals who have been trained and is thus thoroughly acquainted with the knowledge related to this work. • The qualified service person who is allowed to work at heights has been trained in matters relating to working at heights with the air conditioners made by Toshiba Carrier Corporation or, alternatively, he or she has been instructed in such matters by an individual or individuals who have been trained and is thus thoroughly acquainted with the knowledge related to this work.

Definition of Protective Gear

When the air conditioner is to be transported, installed, maintained, repaired or removed, wear protective gloves and 'safety' work clothing.

In addition to such normal protective gear, wear the protective gear described below when undertaking the special work detailed in the table below.



Failure to wear the proper protective gear is dangerous because you will be more susceptible to injury, burns, electric shocks and other injuries.

Work undertaken	Protective gear worn
All types of work	Protective gloves 'Safety' working clothing
Electrical-related work	Gloves to provide protection for electricians and from heat Insulating shoes Clothing to provide protection from electric shock
Work done at heights (50 cm or more)	Helmets for use in industry
Transportation of heavy objects	Shoes with additional protective toe cap
Repair of outdoor unit	Gloves to provide protection for electricians and from heat

The important contents concerned to the safety are described on the product itself and on this Service Manual.



Please read this Service Manual after understanding the described items thoroughly in the following contents (Indications / Illustrated marks), and keep them.

[Explanation of indications]





Indication	Explanation
 DANGER	Indicates contents assumed that an imminent danger causing a death or serious injury of the repair engineers and the third parties when an incorrect work has been executed.
 WARNING	Indicates possibilities assumed that a danger causing a death or serious injury of the repair engineers, the third parties, and the users due to troubles of the product after work when an incorrect work has been executed.
 CAUTION	Indicates contents assumed that an injury or property damage (*) may be caused on the repair engineers, the third parties, and the users due to troubles of the product after work when an incorrect work has been executed.

* Property damage: Enlarged damage concerned to property, furniture, and domestic animal / pet

[Explanation of illustrated marks]

Indication	Explanation
	Indicates prohibited items (Forbidden items to do) The sentences near an illustrated mark describe the concrete prohibited contents.
	Indicates mandatory items (Compulsory items to do) The sentences near an illustrated mark describe the concrete mandatory contents.
	Indicates cautions (Including danger / warning) The sentences or illustration near or in an illustrated mark describe the concrete cautious contents.

MEANING OF SYMBOLS DISPLAYED ON THE UNIT







	WARNING (Risk of fire)	This mark is for R32 refrigerant only. Refrigerant type is written on nameplate of outdoor unit. In case that refrigerant type is R32, this unit uses a flammable refrigerant. If refrigerant leaks and comes in contact with fire or heating part, it will create harmful gas and there is risk of fire.
		Read the OWNER'S MANUAL carefully before operation.
		Service personnel are required to carefully read the OWNER'S MANUAL and INSTALLATION MANUAL before operation.
		Further information is available in the OWNER'S MANUAL, INSTALLATION MANUAL, and the like.

Warning Indications on the Air Conditioner Unit

[Confirmation of warning label on the main unit]

Confirm that labels are indicated on the specified positions





If removing the label during parts replace, stick it as the original.

Warning indication		Description
	<p>WARNING</p> <p>ELECTRICAL SHOCK HAZARD Disconnect all remote electric power supplies before servicing.</p>	<p>WARNING</p> <p>ELECTRICAL SHOCK HAZARD Disconnect all remote electric power supplies before servicing.</p>
	<p>WARNING</p> <p>Moving parts. Do not operate unit with grille removed. Stop the unit before the servicing.</p>	<p>WARNING</p> <p>Moving parts. Do not operate unit with grille removed. Stop the unit before the servicing.</p>
	<p>CAUTION</p> <p>High temperature parts. You might get burned when removing this panel.</p>	<p>CAUTION</p> <p>High temperature parts. You might get burned when removing this panel.</p>
	<p>CAUTION</p> <p>Do not touch the aluminium fins of the unit. Doing so may result in injury.</p>	<p>CAUTION</p> <p>Do not touch the aluminium fins of the unit. Doing so may result in injury.</p>
	<p>CAUTION</p> <p>BURST HAZARD Open the service valves before the operation, otherwise there might be the burst.</p>	<p>CAUTION</p> <p>BURST HAZARD Open the service valves before the operation, otherwise there might be the burst.</p>
	<p>CAUTION</p> <p>Do not climb onto the fan guard. Doing so may result in injury.</p>	<p>CAUTION</p> <p>Do not climb onto the fan guard. Doing so may result in injury.</p>



PRECAUTIONS FOR SAFETY







The manufacturer shall not assume any liability for the damage caused by not observing the description of this manual.







DANGER



 Turn off braeaker	<p>Before carrying out the installation, maintenance, repair or removal work, be sure to set the circuit breaker for both the indoor and outdoor units to the OFF position. Otherwise, electric shocks may result.</p>
	<p>Before opening the electrical box cover of the indoor unit or service panel of the outdoor unit, set the circuit breaker to the OFF position. Failure to set the circuit breaker to the OFF position may result in electric shocks through contact with the interior parts. Only a qualified installer (*1) or qualified service person (*1) is allowed to remove the intake grille of the indoor unit or service panel of the outdoor unit and do the work required.</p>
	<p>Before starting to repair the outdoor unit fan or fan guard, be absolutely sure to set the circuit breaker to the OFF position, and place a "Work in progress" sign on the circuit breaker.</p>
	<p>When cleaning the filter or other parts of the indoor unit, set the circuit breaker to OFF without fail, and place a "Work in progress" sign near the circuit breaker before proceeding with the work.</p>
	<p>When you have noticed that some kind of trouble (such as when an error display has appeared, there is a smell of burning, abnormal sounds are heard, the air conditioner fails to cool or heat or water is leaking) has occurred in the air conditioner, do not touch the air conditioner yourself but set the circuit breaker to the OFF position, and contact a qualified service person. Take steps to ensure that the power will not be turned on (by marking "out of service" near the circuit breaker, for instance) until qualified service person arrives. Continuing to use the air conditioner in the trouble status may cause mechanical problems to escalate or result in electric shocks or other failure.</p>
 Electric shock hazard	<p>When you access inside of the service panel to repair electric parts, wait for about five minutes after turning off the breaker. Do not start repairing immediately. Otherwise you may get electric shock by touching terminals of high-voltage capacitors. Natural discharge of the capacitor takes about five minutes.</p>
	<p>When checking the electric parts, removing the cover of the electric parts box of Indoor Unit and/or service panel of Outdoor Unit inevitably to determine the failure, use gloves to provide protection for electricians, insulating shoes, clothing to provide protection from electric shock and insulating tools. Be careful not to touch the live part. Electric shock may result. Only "Qualified service person" is allowed to do this work.</p>
 Prohibition	<p>Place a "Work in progress" sign near the circuit breaker while the installation, maintenance, repair or removal work is being carried out. There is a danger of electric shocks if the circuit breaker is set to ON by mistake.</p>
	<p>When checking the electric parts, removing the cover of the electric parts box of Indoor Unit and/or front panel of Outdoor Unit inevitably to determine the failure, put a sign "Do not enter" around the site before the work. Failure to do this may result in third person getting electric shock.</p>
	<p>Before operating the air conditioner after having completed the work, check that the electrical parts box cover of the indoor unit and service panel of the outdoor unit are closed, and set the circuit breaker to the ON position. You may receive an electric shock if the power is turned on without first conducting these checks.</p>
 Stay on protection	<p>If, in the course of carrying out repairs, it becomes absolutely necessary to check out the electrical parts with the electrical parts box cover of one or more of the indoor units and the service panel of the outdoor unit removed in order to find out exactly where the trouble lies, wear insulated heat-resistant gloves, insulated boots and insulated work overalls, and take care to avoid touching any live parts. You may receive an electric shock if you fail to heed this warning. Only qualified service person (*1) is allowed to do this kind of work.</p>

 **WARNING**

 General	<p>Before starting to repair the air conditioner, read carefully through the Service Manual, and repair the air conditioner by following its instructions.</p>
	<p>Only qualified service person (*1) is allowed to repair the air conditioner. Repair of the air conditioner by unqualified person may give rise to a fire, electric shocks, injury, water leaks and / or other problems.</p>
	<p>Do not use any refrigerant different from the one specified for complement or replacement. Otherwise, abnormally high pressure may be generated in the refrigeration cycle, which may result in a failure or explosion of the product or an injury to your body.</p>
	<p>Only a qualified installer (*1) or qualified service person (*1) is allowed to carry out the electrical work of the air conditioner. Under no circumstances must this work be done by an unqualified individual since failure to carry out the work properly may result in electric shocks and / or electrical leaks.</p>
	<p>When the air conditioner is to be transported, installed, maintained, repaired or removed, wear protective gloves and 'safety' work clothing.</p>
	<p>To connect the electrical wires, repair the electrical parts or undertake other electrical jobs, wear gloves to provide protection for electricians, insulating shoes and clothing to provide protection from electric shocks. Failure to wear this protective gear may result in electric shocks.</p>
	<p>Electrical wiring work shall be conducted according to law and regulation in the community and installation manual. Failure to do so may result in electrocution or short circuit.</p>
	<p>Use wiring that meets the specifications in the Installation Manual and the stipulations in the local regulations and laws. Use of wiring which does not meet the specifications may give rise to electric shocks, electrical leakage, smoking and/or a fire.</p>
	<p>Only a qualified installer (*1) or qualified service person (*1) is allowed to undertake work at heights using a stand of 50 cm or more or to remove the intake grille of the indoor unit to undertake work.</p>
	<p>When working at heights, use a ladder which complies with the ISO 14122 standard, and follow the procedure in the ladder's instructions. Also wear a helmet for use in industry as protective gear to undertake the work.</p>
	<p>Before working at heights, put a sign in place so that no-one will approach the work location, before proceeding with the work. Parts and other objects may fall from above, possibly injuring a person below. While carrying out the work, wear a helmet for protection from falling objects.</p>
	<p>When executing address setting, test run, or troubleshooting through the checking window on the electric parts box, put on insulated gloves to provide protection from electric shock. Otherwise you may receive an electric shock.</p>
	<p>Do not touch the aluminum fin of the outdoor unit. You may injure yourself if you do so. If the fin must be touched for some reason, first put on protective gloves and safety work clothing, and then proceed.</p>
	<p>Do not climb onto or place objects on top of the outdoor unit. You may fall or the objects may fall off of the outdoor unit and result in injury.</p>
	<p>Use forklift to carry in the air conditioner units and use winch or hoist at installation of them.</p>
	<p>When transporting the air conditioner, wear shoes with protective toe caps, protective gloves and other protective clothing.</p>
	<p>When transporting the air conditioner, do not take hold of the bands around the packing carton. You may injure yourself if the bands should break.</p>
	<p>Be sure that a heavy unit (10 kg or heavier) such as a compressor is carried by two persons.</p>
	<p>This air conditioner has passed the pressure test as specified in IEC 60335-2-40 Annex EE.</p>
	 Check earth wires.
<p>After completing the repair or relocation work, check that the ground wires are connected properly.</p>	
<p>Be sure to connect earth wire. (Grounding work) Incomplete grounding causes an electric shock. Do not connect ground wires to gas pipes, water pipes, and lightning rods or ground wires for telephone wires.</p>	

 Prohibition of modification.	<p>Do not modify the products. Do not also disassemble or modify the parts. It may cause a fire, electric shock or injury.</p>
 Use specified parts.	<p>When any of the electrical parts are to be replaced, ensure that the replacement parts satisfy the specifications given in the Service Manual (or use the parts contained on the parts list in the Service Manual). Use of any parts which do not satisfy the required specifications may give rise to electric shocks, smoking and / or a fire.</p>
 Do not bring a child close to the equipment.	<p>If, in the course of carrying out repairs, it becomes absolutely necessary to check out the electrical parts with the electrical parts box cover of one or more of the indoor units and the service panel of the outdoor unit removed in order to find out exactly where the trouble lies, put a sign in place so that no-one will approach the work location before proceeding with the work. Third-party individuals may enter the work site and receive electric shocks if this warning is not heeded.</p>
 Insulating measures	<p>Connect the cut-off lead wires with crimp contact, etc., put the closed end side upward and then apply a watercut method, otherwise a leak or production of fire is caused at the users' side.</p>
 No fire	<p>When performing repairs using a gas burner, replace the refrigerant with nitrogen gas because the oil that coats the pipes may otherwise burn. When repairing the refrigerating cycle, take the following measures.</p> <ol style="list-style-type: none"> 1) Be attentive to fire around the cycle. When using a gas stove, etc., be sure to put out fire before work; otherwise the oil mixed with refrigerant gas may catch fire. 2) Do not use a welder in the closed room. When using it without ventilation, carbon monoxide poisoning may be caused. 3) Do not bring inflammables close to the refrigerant cycle, otherwise fire of the welder may catch the inflammables.
 Refrigerant	<p>The refrigerant used by this air conditioner is the R32.</p> <p>Check the used refrigerant name and use tools and materials of the parts which match with it. For the products which use R32 refrigerant, the refrigerant name is indicated at a position on the outdoor unit where is easy to see. To prevent miss-charging, the route of the service port is changed from one of the former R22.</p> <p>Do not use any refrigerant different from the one specified for complement or replacement. Otherwise, abnormally high pressure may be generated in the refrigeration cycle, which may result in a failure or explosion of the product or an injury to your body.</p> <p>For an air conditioner which uses R32 never use other refrigerant than R32 For an air conditioner which uses other refrigerant (R22, etc.), never use R32. If different types of refrigerant are mixed, abnormal high pressure generates in the refrigerating cycle and an injury due to breakage may be caused.</p> <p>When the air conditioner has been installed or relocated, follow the instructions in the Installation Manual and purge the air completely so that no gases other than the refrigerant will be mixed in the refrigerating cycle. Failure to purge the air completely may cause the air conditioner to malfunction.</p> <p>Do not charge refrigerant additionally. If charging refrigerant additionally when refrigerant gas leaks, the refrigerant composition in the refrigerating cycle changes resulted in change of air conditioner characteristics or refrigerant over the specified standard amount is charged and an abnormal high pressure is applied to the inside of the refrigerating cycle resulted in cause of breakage or injury. Therefore if the refrigerant gas leaks, recover the refrigerant in the air conditioner, execute vacuuming, and then newly recharge the specified amount of liquid refrigerant. In this time, never charge the refrigerant over the specified amount.</p> <p>When recharging the refrigerant in the refrigerating cycle, do not mix the refrigerant or air other than R32 into the specified refrigerant. If air or others is mixed with the refrigerant, abnormal high pressure generates in the refrigerating cycle resulted in cause of injury due to breakage.</p> <p>After installation work, check the refrigerant gas does not leak. If the refrigerant gas leaks in the room, poisonous gas generates when gas touches to fire such as fan heater, stove or cooking stove though the refrigerant gas itself is innocuous.</p> <p>Never recover the refrigerant into the outdoor unit. When the equipment is moved or repaired, be sure to recover the refrigerant with recovering device. The refrigerant cannot be recovered in the outdoor unit; otherwise a serious accident such as breakage or injury is caused.</p>

 Assembly / Wiring	After repair work, surely assemble the disassembled parts, and connect and lead the removed wires as before. Perform the work so that the cabinet or panel does not catch the inner wires. If incorrect assembly or incorrect wire connection was done, a disaster such as a leak or fire is caused at user's side.
 Insulator check	After the work has finished, be sure to use an insulation tester set (500 V Megger) to check the resistance is 1 MΩ or more between the charge section and the non-charge metal section (Earth position). If the resistance value is low, a disaster such as a leak or electric shock is caused at user's side.
 Ventilation	When the refrigerant gas leaks during work, execute ventilation. If the refrigerant gas touches to a fire, poisonous gas generates. A case of leakage of the refrigerant and the closed room full with gas is dangerous because a shortage of oxygen occurs. Be sure to execute ventilation. If refrigerant gas has leaked during the installation work, ventilate the room immediately. If the leaked refrigerant gas comes in contact with fire, noxious gas may generate. After installation work, check the refrigerant gas does not leak. If the refrigerant gas leaks in the room, poisonous gas generates when gas touches to fire such as fan heater, stove or cooking stove though the refrigerant gas itself is innocuous.
 Compulsion	When the refrigerant gas leaks, find up the leaked position and repair it surely. If the leaked position cannot be found up and the repair work is interrupted, pump-down and tighten the service valve, otherwise the refrigerant gas may leak into the room. The poisonous gas generates when gas touches to fire such as fan heater, stove or cooking stove though the refrigerant gas itself is innocuous. When installing equipment which includes a large amount of charged refrigerant such as a multi air conditioner in a sub-room, it is necessary that the density does not the limit even if the refrigerant leaks. If the refrigerant leaks and exceeds the limit density, an accident of shortage of oxygen is caused. Tighten the flare nut with a torque wrench in the specified manner. Excessive tighten of the flare nut may cause a crack in the flare nut after a long period, which may result in refrigerant leakage. Nitrogen gas must be used for the airtight test. The charge hose must be connected in such a way that it is not slack. For the installation / moving / reinstallation work, follow to the Installation Manual. If an incorrect installation is done, a trouble of the refrigerating cycle, water leak, electric shock or fire is caused.
 Check after repair	Once the repair work has been completed, check for refrigerant leaks, and check the insulation resistance and water drainage. Then perform a trial run to check that the air conditioner is running properly. After repair work has finished, check there is no trouble. If check is not executed, a fire, electric shock or injury may be caused. For a check, turn off the power breaker. After repair work (installation of front panel and cabinet) has finished, execute a test run to check there is no generation of smoke or abnormal sound. If check is not executed, a fire or an electric shock is caused. Before test run, install the front panel and cabinet. Be sure to fix the screws back which have been removed for installation or other purposes.
 Do not operate the unit with the valve closed.	Check the following matters before a test run after repairing piping. <ul style="list-style-type: none"> • Connect the pipes surely and there is no leak of refrigerant. • The valve is opened. Running the compressor under condition that the valve closes causes an abnormal high pressure resulted in damage of the parts of the compressor and etc. and moreover if there is leak of refrigerant at connecting section of pipes, the air is sucked and causes further abnormal high pressure resulted in burst or injury.
 Check after reinstallation	Only a qualified installer (*1) or qualified service person (*1) is allowed to relocate the air conditioner. It is dangerous for the air conditioner to be relocated by an unqualified individual since a fire, electric shocks, injury, water leakage, noise and / or vibration may result. Check the following items after reinstallation. <ol style="list-style-type: none"> 1) The earth wire is correctly connected. 2) The power cord is not caught in the product. 3) There is no inclination or unsteadiness and the installation is stable. If check is not executed, a fire, an electric shock or an injury is caused. When carrying out the pump-down work shut down the compressor before disconnecting the refrigerant pipe. Disconnecting the refrigerant pipe with the service valve left open and the compressor still operating will cause air, etc. to be sucked in, raising the pressure inside the refrigeration cycle to an abnormally high level, and possibly resulting in reputing, injury, etc.

 Cooling check	<p>When the service panel of the outdoor unit is to be opened in order for the compressor or the area around this part to be repaired immediately after the air conditioner has been shut down, set the circuit breaker to the OFF position, and then wait at least 10 minutes before opening the service panel. If you fail to heed this warning, you will run the risk of burning yourself because the compressor pipes and other parts will be very hot to the touch. In addition, before proceeding with the repair work, wear the kind of insulated heat-resistant gloves designed to protect electricians.</p>
	<p>Take care not to get burned by compressor pipes or other parts when checking the cooling cycle while running the unit as they get heated while running. Be sure to put on gloves providing protection for heat.</p>
 Installation	<p>When the service panel of the outdoor unit is to be opened in order for the fan motor, reactor, inverter or the areas around these parts to be repaired immediately after the air conditioner has been shut down, set the circuit breaker to the OFF position, and then wait at least 10 minutes before opening the service panel. If you fail to heed this warning, you will run the risk of burning yourself because the fan motor, reactor, inverter heat sink and other parts will be very hot to the touch. In addition, before proceeding with the repair work, wear the kind of insulated heat-resistant gloves designed to protect electricians.</p>
	<p>Only a qualified installer or service person is allowed to do installation work. Inappropriate installation may result in water leakage, electric shock or fire.</p>
 Installation	<p>Before starting to install the air conditioner, read carefully through the Installation Manual, and follow its instructions to install the air conditioner.</p>
	<p>Be sure to use the company-specified products for the separately purchased parts. Use of non-specified products may result in fire, electric shock, water leakage or other failure. Have the installation performed by a qualified installer.</p>
	<p>Do not supply power from the power terminal block equipped on the outdoor unit to another outdoor unit. Capacity overflow may occur on the terminal block and may result in fire.</p>
	<p>Do not install the air conditioner in a location that may be subject to a risk of exposure to a combustible gas. If a combustible gas leaks and becomes concentrated around the unit, a fire may occur.</p>
	<p>Install the indoor unit at least 2.5 m above the floor level since otherwise the users may injure themselves or receive electric shocks if they poke their fingers or other objects into the indoor unit while the air conditioner is running.</p>
	<p>Install a circuit breaker that meets the specifications in the installation manual and the stipulations in the local regulations and laws.</p>
	<p>Install the circuit breaker where it can be easily accessed by the qualified service person (*1).</p>
	<p>If you install the unit in a small room, take appropriate measures to prevent the refrigerant from exceeding the limit concentration even if it leaks. Consult the dealer from whom you purchased the air conditioner when you implement the measures. Accumulation of highly concentrated refrigerant may cause an oxygen deficiency accident.</p>
<p>Do not place any combustion appliance in a place where it is directly exposed to the wind of air conditioner, otherwise it may cause imperfect combustion.</p>	

Explanations given to user

If you have discovered that the fan grille is damaged, do not approach the outdoor unit but set the circuit breaker to the OFF position, and contact a qualified service person to have the repairs done. Do not set the circuit breaker to the ON position until the repairs are completed.

Relocation

- Only a qualified installer (*1) or qualified service person (*1) is allowed to relocate the air conditioner. It is dangerous for the air conditioner to be relocated by an unqualified individual since a fire, electric shocks, injury, water leakage, noise and / or vibration may result.
- When carrying out the pump-down work shut down the compressor before disconnecting the refrigerant pipe. Disconnecting the refrigerant pipe with the service valve left open and the compressor still operating will cause air, etc. to be sucked in, raising the pressure inside the refrigeration cycle to an abnormally high level, and possibly resulting in rupturing, injury, etc.

(*1) Refer to the “Definition of Qualified Installer or Qualified Service Person”

Declaration of Conformity

Manufacturer: TOSHIBA CARRIER (THAILAND) CO., LTD.
144 / 9 Moo 5, Bangkadi Industrial Park, Tivanon Road,
Amphur Muang, Pathumthani 12000, Thailand

TCF holder: TOSHIBA CARRIER EUROPE S.A.S
Route de Thil
01120 Montluel FRANCE

Hereby declares that the machinery described below:

Generic Denomination: Air Conditioner

Model/type: RAV-GM901BTP-E RAV-GM901BTP-TR

Commercial name: Digital Inverter Series / Super Digital Inverter Series Air Conditioner

Complies with the provisions of the "Machinery" Directive (Directive 2006/42/EC) and the regulations transposing into national law.

Note: This declaration becomes invalid if technical or operational modifications are introduced without the manufacturer's consent.

Specifications

Model	Sound power level (dBA)		Weight (kg)
	Cooling	Heating	
RAV-GM901BTP-E	*	*	41
RAV-GM901BTP-TR	*	*	41

*: Under 70 dBA

• Refrigerant (R32)

This air conditioner adopts a refrigerant HFC (R32) which does not deplete the ozone layer.

1. Safety Caution Concerned to Refrigerant R32

The pressure of R32 is high 1.6 times of that of the former refrigerant (R22).

Accompanied with change of refrigerant, the refrigerating oil has been also changed.

Therefore, be sure that water, dust, the former refrigerant or the former refrigerating oil is not mixed into the refrigerating cycle of the air conditioner with refrigerant R32 during installation work or service work. If an incorrect work or incorrect service is performed, there is a possibility to cause a serious accident. Use the tools and materials exclusive to R32 to purpose a safe work.

2. Cautions on Installation/Service

1) Do not mix the other refrigerant or refrigerating oil.

For the tools exclusive to R32 shapes of all the joints including the service port differ from those of the former refrigerant in order to prevent mixture of them.

2) As the use pressure of the refrigerant R32 is high, use material thickness of the pipe and tools which are specified for R32.

3) In the installation time, use clean pipe materials and work with great attention so that water and others do not mix in because pipes are affected by impurities such as water, oxide scales, oil, etc.

Use the clean pipes.

Be sure to brazing with flowing nitrogen gas. (Never use gas other than nitrogen gas.)

4) For the earth protection, use a vacuum pump for air purge.

5) R32 refrigerant is azeotropic mixture type refrigerant.

Therefore use liquid type to charge the refrigerant. (If using gas for charging, composition of the refrigerant changes and then characteristics of the air conditioner change.)

3. Pipe Materials

For the refrigerant pipes, copper pipe and joints are mainly used.

It is necessary to select the most appropriate pipes to conform to the standard.

Use clean material in which impurities adhere inside of pipe or joint to a minimum.

1) Copper pipe

<Piping>

The pipe thickness, flare finishing size, flare nut and others differ according to a refrigerant type.

When using a long copper pipe for R32 it is recommended to select "Copper or copper-base pipe without seam" and one with bonded oil amount 40mg/10m or less.

Also do not use crushed, deformed, discolored (especially inside) pipes.

(Impurities cause clogging of expansion valves and capillary tubes.)

<Flare nut>

Use the flare nuts which are attached to the air conditioner unit.

2) Joint

The flare joint and socket joint are used for joints of the copper pipe.

The joints are rarely used for installation of the air conditioner. However clear impurities when using them.

4. Tools

1. Required Tools for R32

Mixing of different types of oil may cause a trouble such as generation of sludge, clogging of capillary, etc. Accordingly, the tools to be used are classified into the following three types.

- 1) Tools exclusive for R32 (Those which cannot be used for conventional refrigerant (R22))
- 2) Tools exclusive for R32 but can be also used for conventional refrigerant (R22)
- 3) Tools commonly used for R32 and for conventional refrigerant (R22)

The table below shows the tools exclusive for R32 and their interchangeability.

Tools exclusive for R32 (The following tools for R32 are required.)

Tools whose specifications are changed for R32 and their interchangeability

No.	Used tool	Usage	R32 air conditioner installation		Conventional air conditioner installation
			Existence of new equipment for R32	Whether conven- tional equipment can be used	Whether conventional equipment can be used
①	Flare tool	Pipe flaring	Yes	*(Note)	Yes
②	Copper pipe gauge for adjusting projection margin	Flaring by conventional flare tool	Yes	*(Note)	*(Note)
③	Torque wrench	Tightening of flare nut	Yes	No	No
④	Gauge manifold	Evacuating, refrigerant charge, run check, etc.	Yes	No	No
⑤	Charge hose				
⑥	Vacuum pump adapter	Vacuum evacuating	Yes	No	Yes
⑦	Electronic balance for refrigerant charging	Refrigerant charge	Yes	Yes	Yes
⑧	Refrigerant cylinder	Refrigerant charge	Yes	No	No
⑨	Leakage detector	Gas leakage check	Yes	No	Yes

(Note) When flaring is carried out for R32 using the conventional flare tools, adjustment of projection margin is necessary. For this adjustment, a copper pipe gauge, etc. are necessary.

General tools (Conventional tools can be used.)

In addition to the above exclusive tools, the following equipments which serve also for R22 are necessary as the general tools.

- | | |
|--|--|
| 1) Vacuum pump. Use vacuum pump by
attaching vacuum pump adapter. | 7) Screwdriver (+, -) |
| 2) Torque wrench | 8) Spanner or Monkey wrench |
| 3) Pipe cutter | 9) Hole core drill |
| 4) Reamer | 10) Hexagon wrench (Opposite side 4mm) |
| 5) Pipe bender | 11) Tape measure |
| 6) Level vial | 12) Metal saw |

Also prepare the following equipments for other installation method and run check.

- | | |
|----------------|--|
| 1) Clamp meter | 3) Insulation resistance tester (Megger) |
| 2) Thermometer | 4) Electroscope |

1. AIR DUCTING WORK

Static Pressure Characteristics

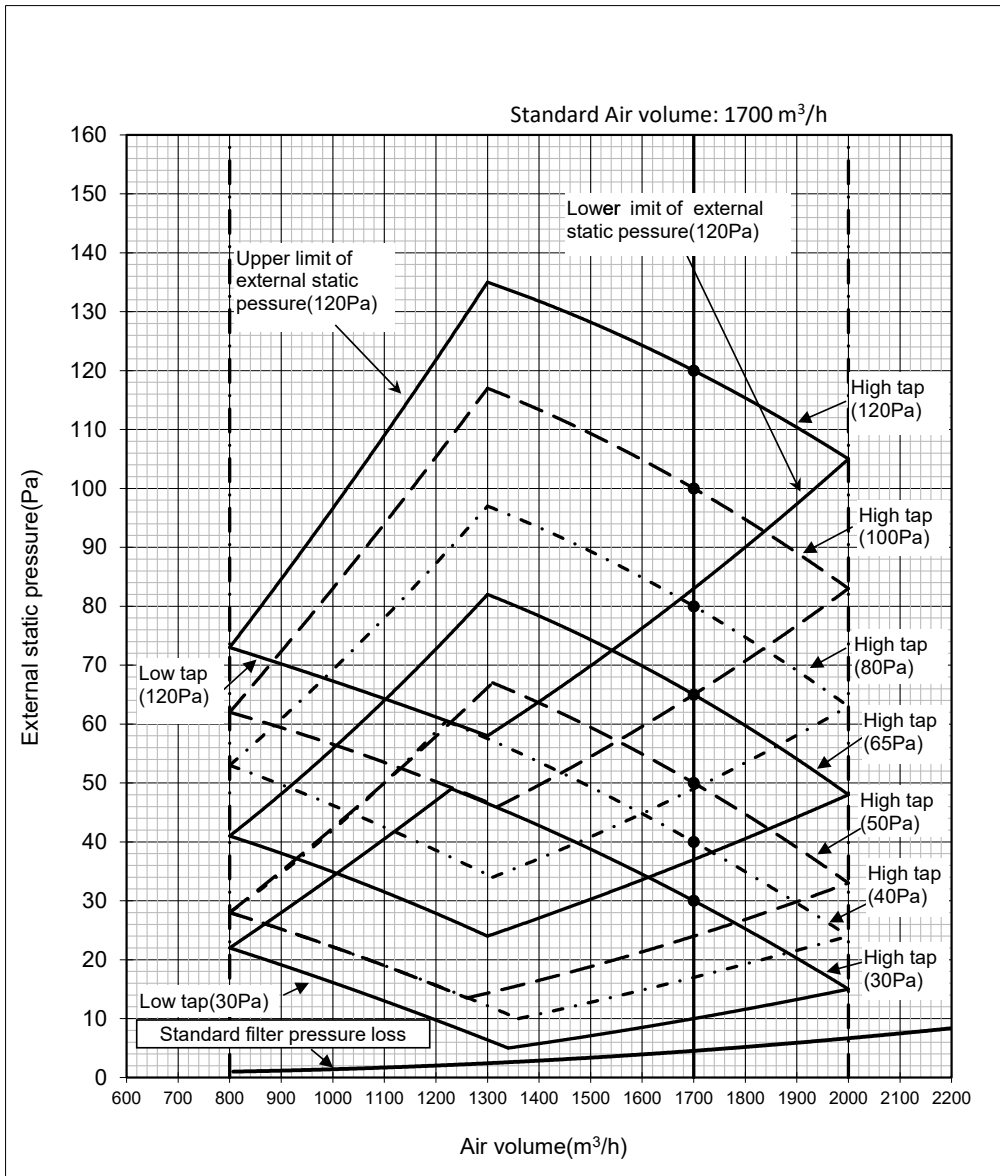

2. CONSTRUCTION VIEWS (EXTERNAL VIEWS)

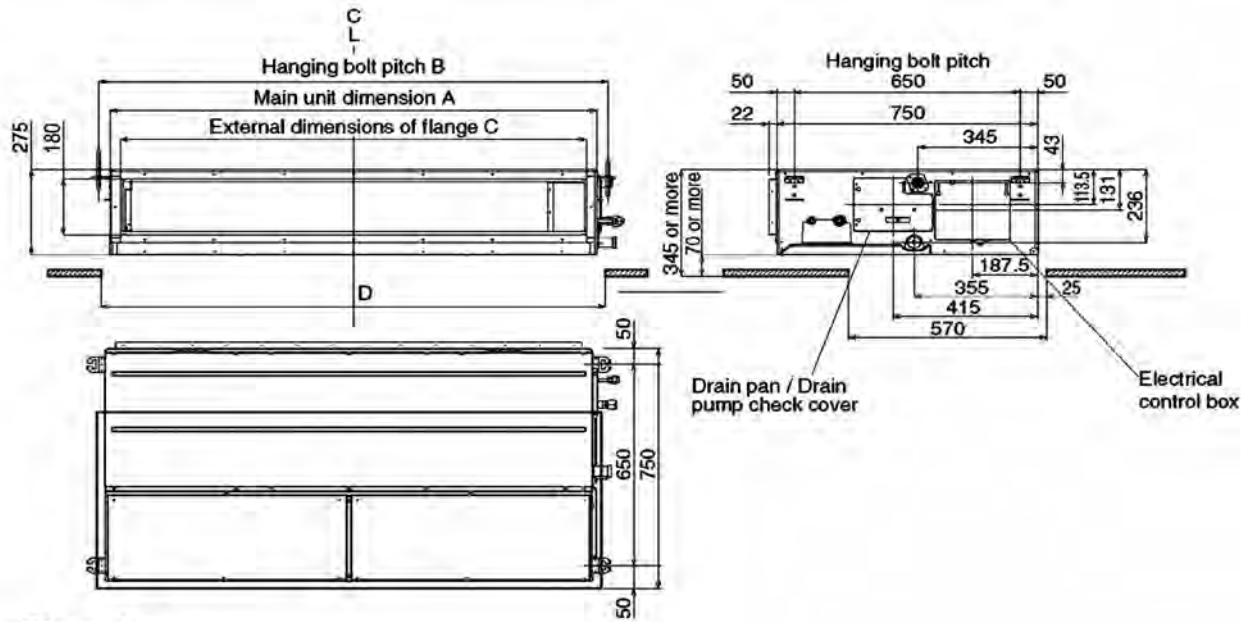

Dimension

Model	A	B	C	D
GM90 type	1400	1465	1340	1450

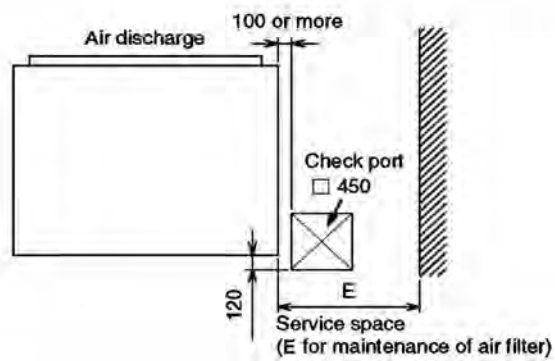

Model	E
GM90 type	700

GM90 type

<Under air intake>

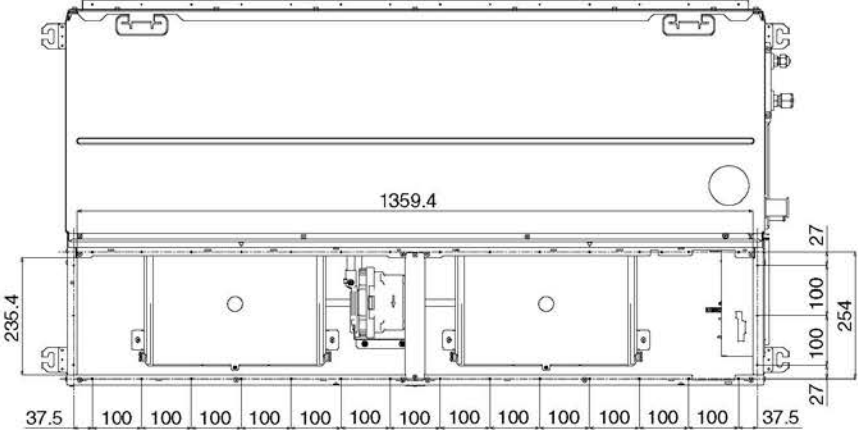

<Back air intake>

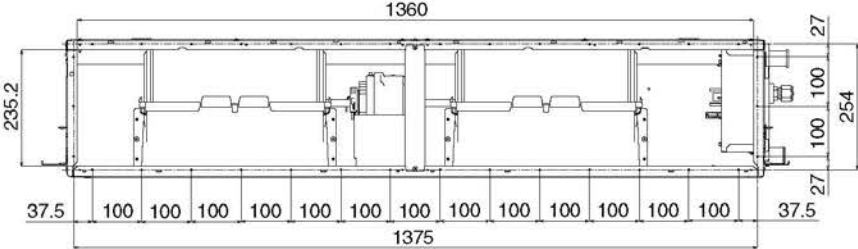

4. SPECIFICATIONS OF ELECTRICAL PARTS

Concealed Duct Type

No.	Parts name	Type	Specifications
1	Fan motor	ICF-340W250-1	Output (Rated) 250W, 220-240V
2	Thermo. Sensor (TA-sensor)	218mm	10k Ω at 25°C
3	Heat exchanger sensor (TCJ-sensor)	Ø6mm, 1000mm	10k Ω at 25°C
4	Heat exchanger sensor (TC-sensor)	Ø6mm, 1000mm	10k Ω at 25°C
5	Float switch	FS-1A-31-3	
6	Drain pump motor	MDP-1401	
7	Reactor	CH-49-Z-T	14mH, 4A

5-1-2. In Case of Connection of Wireless Remote Controller

Indoor unit #1 (Header)

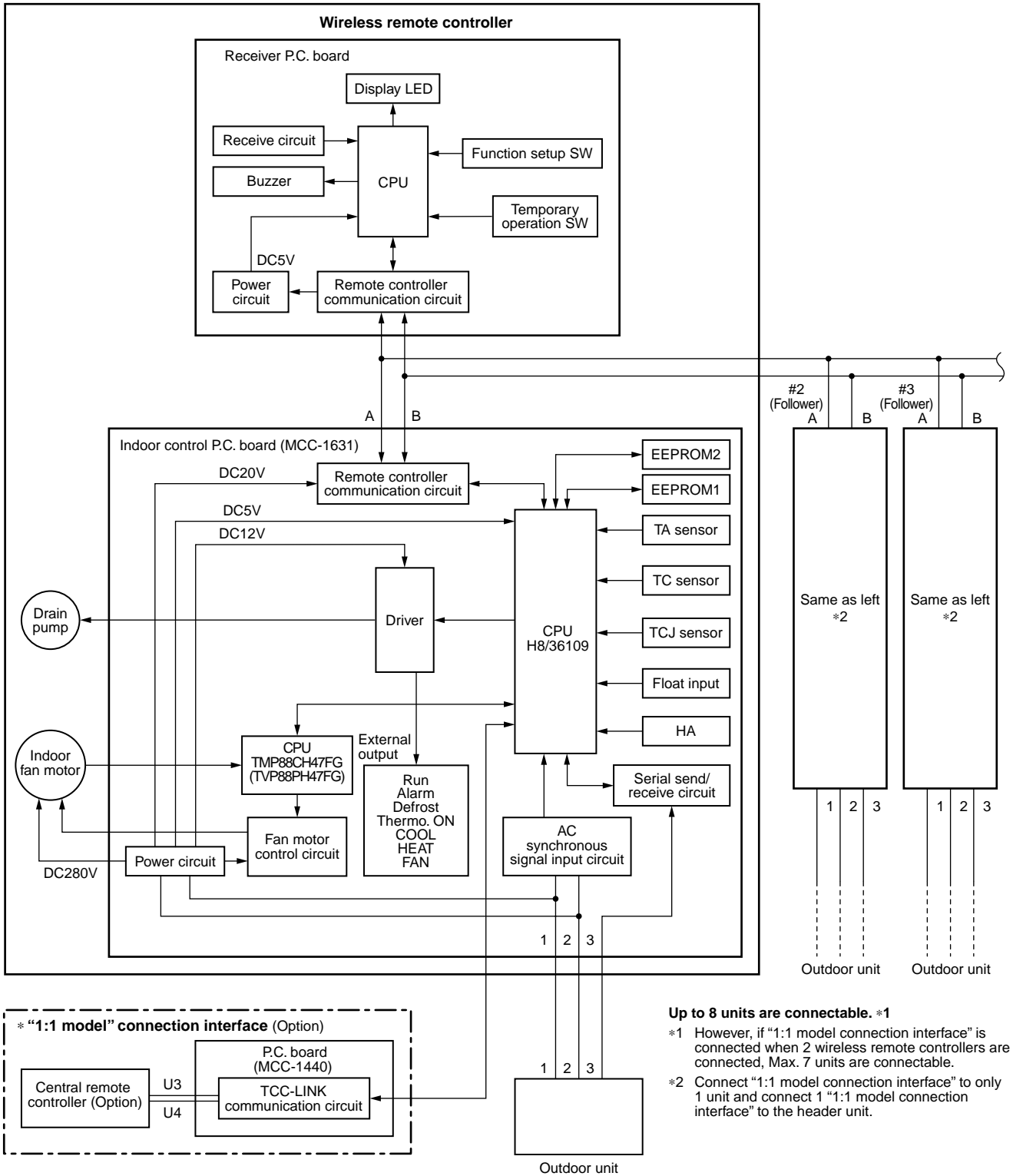



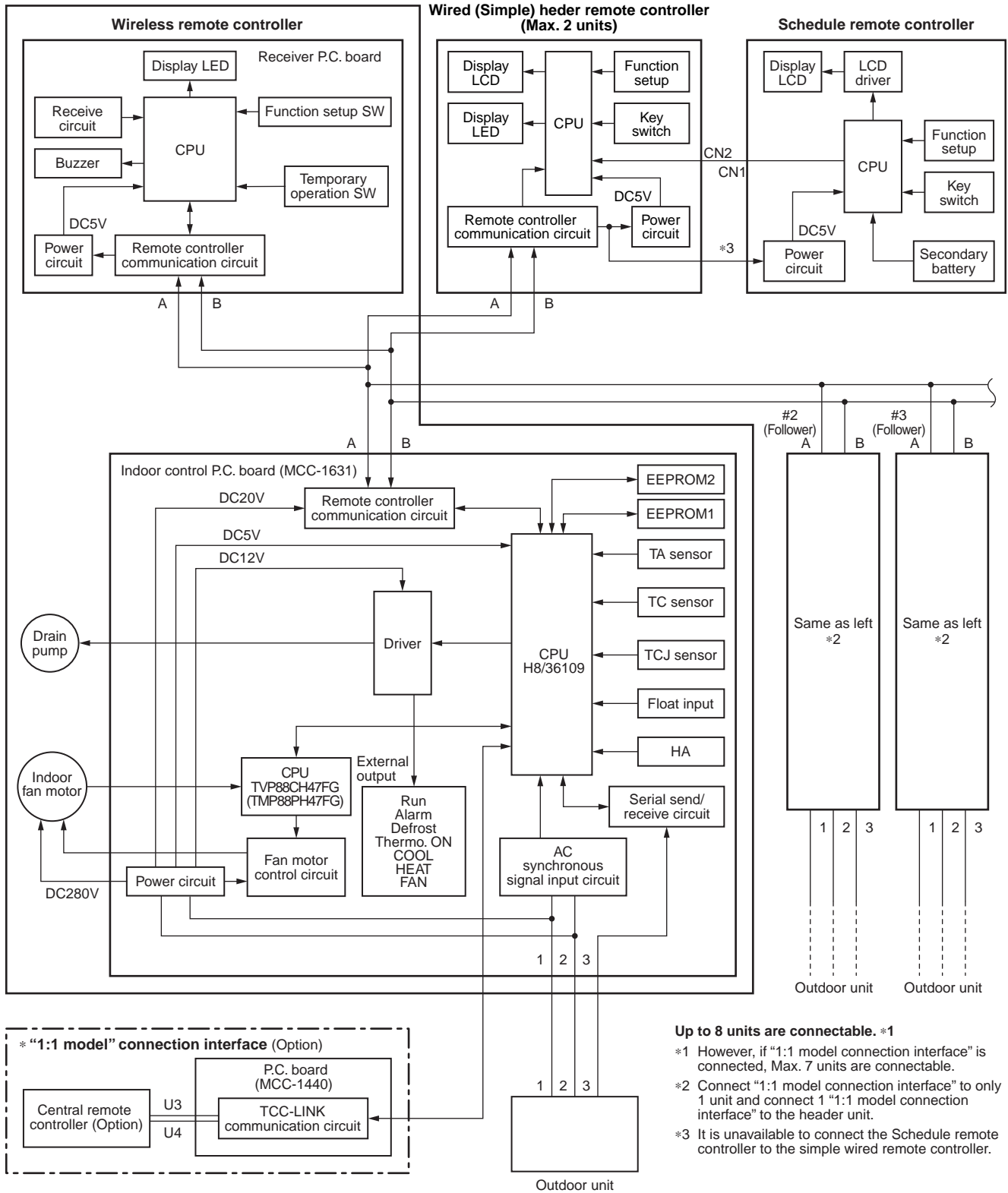

5-1-3. Connection of Both Wired (Simple) Remote Controller and Wireless Remote Controller

Indoor unit
#1 (Header)

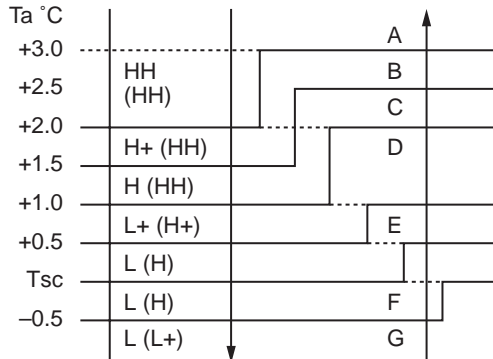
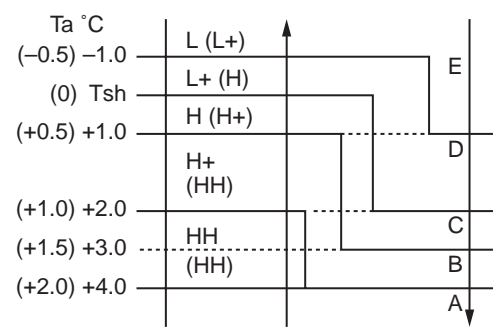



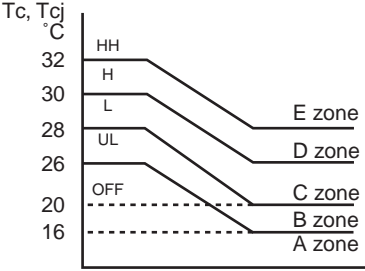

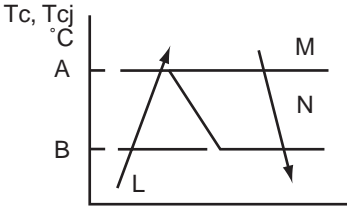

No.	Item	Outline of specifications	Remarks												
3	Room temp. control (Continued)	2) Using the CODE No. 06, the setup temperature in heating operation can be corrected. <table border="1" data-bbox="443 286 1096 394"> <thead> <tr> <th>SET DATA</th> <th>0</th> <th>2</th> <th>4</th> <th>6</th> </tr> </thead> <tbody> <tr> <td>Setup temp. correction</td> <td>+0°C</td> <td>+2°C</td> <td>+4°C</td> <td>+6°C</td> </tr> </tbody> </table> Setting at shipment <table border="1" data-bbox="443 450 754 490"> <tbody> <tr> <td>SET DATA</td> <td>2</td> </tr> </tbody> </table>	SET DATA	0	2	4	6	Setup temp. correction	+0°C	+2°C	+4°C	+6°C	SET DATA	2	Shift of suction temperature in heating operation
SET DATA	0	2	4	6											
Setup temp. correction	+0°C	+2°C	+4°C	+6°C											
SET DATA	2														
4	Automatic capacity control (GA control)	1) Based on the difference between Ta and Ts, the operation frequency is instructed to the outdoor unit. 2) Cooling operation Every 90 seconds, the room temperature difference between temperature detected by Ta and Ts and the varied room temperature value are calculated to obtain the correction value of the frequency command and then the present frequency command is corrected. $Ta(n) - Ts(n)$: Room temp. difference n : Counts of detection $Ta(n-1) - Ts(n)$: Varied room temp. value $n - 1$: Counts of detection of 90 seconds before 3) Heating operation Every 1 minute (60 sec.), the room temperature difference between temperature detected by Ta and Ts and the varied room temperature value are calculated to obtain the correction value of the frequency command and then the present frequency command is corrected. $Ts(n) - Ta(n)$: Room temp. difference n : Counts of detection $Ta(n) - Ta(n - 1)$: Varied room temp. value $n - 1$: Counts of detection of 1 minute before 4) Dry operation The frequency correction control is same as those of the cooling operation. However the maximum frequency is limited to approximately "S6". Note) When LOW is set up, the maximum frequency is limited to approximately "SB".													
5	Automatic cooling/heating control	1) The judgment of selecting COOL/HEAT is carried out as shown below. When +1.5°C exceeds against Tsh 10 minutes and after thermo. OFF, heating operation (Thermo. OFF) exchanges to cooling operation. Description in the parentheses shows an example of cooling ON/OFF. <div style="text-align: center;"> </div> When -1.5°C lowers against Tsc 10 minutes and after thermo. OFF, cooling operation (Thermo. OFF) exchanges to heating operation. 2) For the automatic capacity control after judgment of cooling/heating, see Item 4. 3) For temperature correction of room temp. control in automatic heating, see Item 3.	Tsc: Setup temp. in cooling operation Tsh: Setup temp. in heating operation + temp. correction of room temp. control												

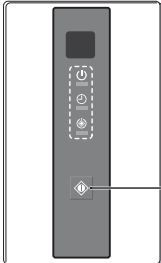

No.	Item	Outline of specifications	Remarks
6	Fan speed control	<p>1) Operation with (HH), (H), (L) or [AUTO] mode is carried out by the command from the remote controller.</p> <p>2) When the fan speed mode [AUTO] is selected, the fan speed varies by the difference between T_a and T_s.</p> <p><COOL></p>  <ul style="list-style-type: none"> Controlling operation in case when thermostat of remote controller works is same as a case when thermostat of the body works. If the fan speed has been changed once, it is not changed for 3 minutes. However when the air volume is exchanged, the fan speed changes. When cooling operation has started, select a downward slope for the fan speed, that is, the high position. If the temperature is just on the difference boundary, the fan speed does not change. Mode in the parentheses indicates one in automatic cooling operation. <p><HEAT></p>  <p>Value in the parentheses indicates one when thermostat of the remote controller works. Value without parentheses indicates one when thermostat of the body works.</p> <ul style="list-style-type: none"> If the fan speed has been changed once, it is not changed for 1 minute. However when the fan speed exchanged, the fan speed changes. When heating operation has started, select an upward slope for the fan speed, that is, the high position. If the temperature is just on the difference boundary, the fan speed does not change. Mode in the parentheses indicates one in automatic heating operation. In $T_c \geq 60^\circ\text{C}$, the fan speed increases by 1 step. 	<p>HH > H+ > H > L+ > L > UL</p> <p>Tc: Indoor heat exchanger sensor temperature</p>







No.	Item	Outline of specifications	Remarks																																																																																																																																																																																																																																																																		
6	Fan speed control (Continued)	<table border="1" data-bbox="469 248 1442 595"> <thead> <tr> <th>CODE No.</th> <th colspan="2">40Pa</th> <th colspan="2">30Pa</th> <th colspan="2">65Pa</th> <th colspan="2">50Pa</th> <th colspan="2">80Pa</th> <th colspan="2">100Pa</th> <th colspan="2">120Pa</th> </tr> <tr> <th>[5d]</th> <th colspan="2">0000</th> <th colspan="2">0001</th> <th colspan="2">0002</th> <th colspan="2">0003</th> <th colspan="2">0004</th> <th colspan="2">0005</th> <th colspan="2">0006</th> </tr> <tr> <th>SW501(1)/(2)</th> <th colspan="2">OFF/OFF</th> <th colspan="2">ON/OFF</th> <th colspan="2">—</th> <th colspan="2">OFF/ON</th> <th colspan="2">—</th> <th colspan="2">—</th> <th colspan="2">ON/ON</th> </tr> <tr> <th>Tap</th> <th>HEAT</th> <th>COOL</th> <th>HEAT</th> <th>COOL</th> <th>HEAT</th> <th>COOL</th> <th>HEAT</th> <th>COOL</th> <th>HEAT</th> <th>COOL</th> <th>HEAT</th> <th>COOL</th> <th>HEAT</th> <th>COOL</th> </tr> </thead> <tbody> <tr><td>F1</td><td></td><td></td><td></td><td></td><td></td><td></td><td></td><td></td><td></td><td></td><td></td><td></td><td></td><td></td></tr> <tr><td>F2</td><td></td><td></td><td></td><td></td><td></td><td></td><td></td><td></td><td></td><td></td><td></td><td></td><td></td><td></td></tr> <tr><td>F3</td><td></td><td></td><td></td><td></td><td></td><td></td><td></td><td></td><td>HH</td><td>HH</td><td>HH</td><td>HH</td><td>H+</td><td>H+</td></tr> <tr><td>F4</td><td></td><td></td><td></td><td></td><td></td><td></td><td></td><td></td><td>H+</td><td>H+</td><td>H</td><td>H</td><td>L+</td><td>L+</td></tr> <tr><td>F5</td><td></td><td></td><td></td><td></td><td>HH</td><td>HH</td><td>HH</td><td>HH</td><td>H</td><td>H</td><td>L+</td><td>L+</td><td></td><td></td></tr> <tr><td>F6</td><td>HH</td><td>HH</td><td></td><td></td><td>H</td><td>H</td><td>H+</td><td>H+</td><td>L+</td><td>L+</td><td></td><td></td><td></td><td></td></tr> <tr><td>F7</td><td>H+</td><td>H+</td><td>HH</td><td>HH</td><td>L+</td><td>L+</td><td></td><td></td><td></td><td></td><td>L</td><td>L</td><td></td><td></td></tr> <tr><td>F8</td><td></td><td></td><td></td><td></td><td></td><td></td><td>H</td><td>H</td><td>L</td><td>L</td><td></td><td></td><td></td><td></td></tr> <tr><td>F9</td><td>H</td><td>H</td><td>H+</td><td>H+</td><td>L</td><td>L</td><td></td><td></td><td></td><td></td><td></td><td></td><td></td><td></td></tr> <tr><td>FA</td><td>L+</td><td>L+</td><td>H</td><td>H</td><td></td><td></td><td>L+</td><td>L+</td><td></td><td></td><td></td><td></td><td></td><td></td></tr> <tr><td>FB</td><td>L</td><td>L</td><td>L+</td><td>L+</td><td></td><td></td><td>L</td><td>L</td><td></td><td></td><td></td><td></td><td></td><td></td></tr> <tr><td>FC</td><td></td><td></td><td>L</td><td>L</td><td></td><td></td><td></td><td></td><td></td><td></td><td></td><td></td><td></td><td></td></tr> <tr><td>FD</td><td>UL</td><td>UL</td><td>UL</td><td>UL</td><td>UL</td><td>UL</td><td>UL</td><td>UL</td><td>UL</td><td>UL</td><td>UL</td><td>UL</td><td>UL</td><td>UL</td></tr> </tbody> </table> <p data-bbox="459 622 1190 1010"> 3) In heating operation, the mode changes to [UL] if thermostat is turned off. 4) If $T_a \geq 25^\circ\text{C}$ when heating operation has started and when defrost operation has been cleared, the air conditioner operates with (H) mode or higher mode for 1 minute after T_c entered in E zone of cool air discharge preventive control (No. 7). 5) Self-clean operation When performing self-clean operation after stopping the cooling operation, the mode becomes 310 rpm. ✕ When the factory is shipped, self-clean operation is not set. </p>	CODE No.	40Pa		30Pa		65Pa		50Pa		80Pa		100Pa		120Pa		[5d]	0000		0001		0002		0003		0004		0005		0006		SW501(1)/(2)	OFF/OFF		ON/OFF		—		OFF/ON		—		—		ON/ON		Tap	HEAT	COOL	HEAT	COOL	HEAT	COOL	HEAT	COOL	HEAT	COOL	HEAT	COOL	HEAT	COOL	F1															F2															F3									HH	HH	HH	HH	H+	H+	F4									H+	H+	H	H	L+	L+	F5					HH	HH	HH	HH	H	H	L+	L+			F6	HH	HH			H	H	H+	H+	L+	L+					F7	H+	H+	HH	HH	L+	L+					L	L			F8							H	H	L	L					F9	H	H	H+	H+	L	L									FA	L+	L+	H	H			L+	L+							FB	L	L	L+	L+			L	L							FC			L	L											FD	UL	UL	UL	UL	UL	UL	UL	UL	UL	UL	UL	UL	UL	UL	<p data-bbox="1219 846 1414 902">[Self-clean 7</p>	Cool air discharge preventive control	<p data-bbox="459 1061 1190 1279"> 1) In heating operation, the indoor fan is controlled based on the detected temperature of T_c sensor or T_{cj} sensor. As shown below, the upper limit of the revolution frequency is restricted. However B zone is assumed as C zone for 6 minutes and after when the compressor activated. In defrost operation, the control value of T_c is shifted by 6°C. </p> 	<p data-bbox="1219 1061 1437 1361"> In D and E zones, the priority is given to air volume selection setup of remote controller. In A zone while thermo is ON, [PRE-HEAT  <p>- 27 -</p> </p>
CODE No.	40Pa		30Pa		65Pa		50Pa		80Pa		100Pa		120Pa																																																																																																																																																																																																																																																								
[5d]	0000		0001		0002		0003		0004		0005		0006																																																																																																																																																																																																																																																								
SW501(1)/(2)	OFF/OFF		ON/OFF		—		OFF/ON		—		—		ON/ON																																																																																																																																																																																																																																																								
Tap	HEAT	COOL	HEAT	COOL	HEAT	COOL	HEAT	COOL	HEAT	COOL	HEAT	COOL	HEAT	COOL																																																																																																																																																																																																																																																							
F1																																																																																																																																																																																																																																																																					
F2																																																																																																																																																																																																																																																																					
F3									HH	HH	HH	HH	H+	H+																																																																																																																																																																																																																																																							
F4									H+	H+	H	H	L+	L+																																																																																																																																																																																																																																																							
F5					HH	HH	HH	HH	H	H	L+	L+																																																																																																																																																																																																																																																									
F6	HH	HH			H	H	H+	H+	L+	L+																																																																																																																																																																																																																																																											
F7	H+	H+	HH	HH	L+	L+					L	L																																																																																																																																																																																																																																																									
F8							H	H	L	L																																																																																																																																																																																																																																																											
F9	H	H	H+	H+	L	L																																																																																																																																																																																																																																																															
FA	L+	L+	H	H			L+	L+																																																																																																																																																																																																																																																													
FB	L	L	L+	L+			L	L																																																																																																																																																																																																																																																													
FC			L	L																																																																																																																																																																																																																																																																	
FD	UL	UL	UL	UL	UL	UL	UL	UL	UL	UL	UL	UL	UL	UL																																																																																																																																																																																																																																																							

No.	Item	Outline of specifications	Remarks						
9	High-temp. release control	<p>1) The heating operation is performed as follows based on the detected temperature of Tc sensor or Tcj sensor.</p> <ul style="list-style-type: none"> • When [M] zone is detected, the commanded frequency is decreased from the real operation frequency. After then the commanded frequency changes every 30 seconds while operation is performed in [M] zone. • In [N] zone, the commanded frequency is held. • When [L] zone is detected, the commanded frequency is returned to the original value by approx. 6Hz every 60 seconds. <p>Setup at shipment</p> <table border="1" data-bbox="435 600 678 719"> <thead> <tr> <th colspan="2">Control temp. °C</th> </tr> <tr> <th>A</th> <th>B</th> </tr> </thead> <tbody> <tr> <td>56 (54)</td> <td>52 (52)</td> </tr> </tbody> </table>  <p>NOTE: When the operation has started or when Tc or Tcj < 30°C at start of the operation or after operation start, temperature is controlled between values in parentheses of A and B.</p>	Control temp. °C		A	B	56 (54)	52 (52)	<p>However this control is ignored in case of the follower unit of the twin.</p> <p>Same status as that when “thermostat-OFF” (status that the air conditioner enters in the room temp. monitor mode when the temperature reached the setup temperature on the remote controller)</p>
Control temp. °C									
A	B								
56 (54)	52 (52)								
10	Drain pump control	<ol style="list-style-type: none"> 1) In cooling operation (including Dry operation), the drain pump is usually operated. 2) If the float switch works while drain pump drives, the compressor stops, the drain pump continues the operation, and a check code is output. 3) If the float switch works while drain pump stops, the compressor stops and the drain pump operates. If the float switch keeps operating for approx. 4 minutes, a check code is output. 	Check code [P10]						
11	After-heat elimination	When heating operation stops, in some cases, the indoor fan operates with (L) for approx. 30 seconds.							

No.	Item	Outline of specifications	Remarks
12	Frequency fixed operation (Test run)	<p><In case of wired remote controller></p> <ol style="list-style-type: none"> 1) When pushing [CHK] button for 4 seconds or more, [TEST] is displayed on the display screen and the mode enters in Test run mode. 2) Push [ON/OFF] button. 3) Using [MODE] button, set the mode to [COOL] or [HEAT]. <ul style="list-style-type: none"> • Do not use other mode than [COOL]/[HEAT] mode. • During test run operation, the temperature cannot be adjusted. • An error is detected as usual. • A frequency fixed operation is performed. 4) After the test run, push [ON/OFF] button to stop the operation. (Display in the display part is same as the procedure in Item 1.) 5) Push [CHK] button to clear the test run mode. ([TEST] display in the display part disappears and the status returns to the normal stop status.) <p><In case of wireless remote controller></p> <ol style="list-style-type: none"> 1) When TEMPORARY button is pushed for 10 seconds or more, "Pi!" sound is heard and the operation changes to test run. After approx. 3 minutes, a cooling operation starts forcibly. Check cool air starts blowing. If the operation does not start, check wiring again. 2) To stop a test operation, push TEMPORARY button once again (Approx. 1 second). Check wiring / piping of the indoor and outdoor units in test run. <div style="text-align: center;">  <p>TEMPORARY button</p> </div>	Command frequency is approximately [S7]
13	Filter sign display (Except wireless type)	<ol style="list-style-type: none"> 1) The operation time of the indoor fan is calculated, the filter reset signal is sent to the remote controller when the specified time (2500H) has passed, and it is displayed on LCD. 2) When the filter reset signal has been received from the remote controller, time of the calculation timer is cleared. In this case, the measurement time is reset if the specified time has passed, and display on LCD disappears. 	[FILTER ] goes on.

No.	Item	Outline of specifications	Remarks
14	Central control mode selection	<p>1) Setting at the central controller side enables to select the contents which can be operated on the wired remote controller.</p> <p>2) Setup contents</p> <ul style="list-style-type: none"> • In case of TCC-LINK Central remote controller (TCB-SC642TLE2) <p>[Individual]: Operated by wired remote controller ([After-push precedence])</p> <p>[Central 1]: START / STOP operation by wired remote controller is unavailable.</p> <p>[Central 2]: START / STOP, MODE change and TEMP. setting by wired remote controller are unavailable.</p> <p>[Central 3]: MODE change and TEMP. setting by wired remote controller are unavailable.</p> <p>[Central 4]: MODE change by wired remote controller is unavailable.</p> <ul style="list-style-type: none"> • In case of the wireless remote controller, the contents to be operated are same though the display lamp does not change. If an item prohibited by the central control mode is operated from the remote controller, it is notified with receiving sound Pi, Pi, Pi, Pi, Pi (5 times) 	<p>Display at wired remote controller side (No display)</p> <p>[] goes on.</p> <p>[] goes on.</p> <p>[] goes on.</p> <p>[] goes on.</p>
15	Energy-saving control	<p>1) Selecting [AUTO] mode enables an energy-saving to be operated.</p> <p>2) The setup temperature is shifted (corrected) in the range not to lose the comfort ability according to input values of various sensors.</p> <p>3) Data (Input value room temp. Ta, Outside temp. To, Air volume, Indoor heat exchanger sensor temp. Tc) for 20 minutes are taken the average to calculate correction value of the setup temperature.</p> <p>4) The setup temperature is shifted every 20 minutes, and the shifted range is as follows. In cooling time: +1.5 to -1.0K In heating time: -1.5 to +1.0K.</p>	
16	Max. frequency cut control	<p>1) This control is operated by selecting [AUTO] operation mode.</p> <p>2) COOL operation mode: It is controlled according to the following figure if $T_o < 28^{\circ}\text{C}$.</p> <div data-bbox="539 1756 963 1989" data-label="Figure"> </div> <p>3) HEAT operation mode: It is controlled according to the following figure if $T_o > 15^{\circ}\text{C}$.</p> <div data-bbox="963 1727 1353 1939" data-label="Figure"> </div>	

No.	Item	Outline of specifications	Remarks												
17	DC motor	<p>1) When the fan operation has started, positioning of the stator and the rotor are performed. (Moves slightly with tap sound)</p> <p>2) The motor operates according to the command from the indoor controller.</p> <p>Notes)</p> <ul style="list-style-type: none"> • When the fan rotates while the air conditioner stops due to entering of outside air, etc, the air conditioner may operate while the fan motor stops. • When a fan lock is found, the air conditioner stops, and an error is displayed. • If static pressure of the used duct does not match with the setup value of static pressure, which was decided in the static pressure setting code No. [5D], the air conditioner may stop or an error code may be displayed. 	Check code [P12]												
18	<p>Self-clean operation (Dry operation)</p> <p>✕When the factory is shipped, self-clean operation is not set.</p>	<p>1) When cooling operation mode (AUTO COOL, COOL, DRY) stopped, the following three self-clean operations are performed.</p> <table border="1" data-bbox="596 1016 1286 1205"> <thead> <tr> <th>Compressor ON period</th> <th>Self-clean operation period</th> <th>FAN</th> <th>Drain pump</th> </tr> </thead> <tbody> <tr> <td>0 to 10 min.</td> <td>None</td> <td rowspan="3">Fan (UL)</td> <td rowspan="3">STOP</td> </tr> <tr> <td>10 to 60 min.</td> <td>1 hour</td> </tr> <tr> <td>60 min. to</td> <td>2 hours</td> </tr> </tbody> </table> <p>2) During operation of self-clean,  lights on the wired remote controller screen. However the operation lamp (Green LED) goes off.</p> <p>3) To stop the self-clean operation, push twice the [ON/OFF] button on the remote controller continuously. (Stop the operation as compressor ON time in the table above: 10 minutes or below.)</p> <p>4) When the follower unit executes self-clean operation in the group connection, the segment of  is displayed on the wired remote controller screen via master unit.</p> <p>* If self-clean operation is not used, set invalidity (does not use) of the self-clean operation by changing [0001 (At shipment) of CODE No. (DN) [D3] to [0000].</p> <p>* To erase the  display during operation of self-clean, change CODE No. [D4] from [0000: Display (At shipment)] to [0001: Non-display].</p>	Compressor ON period	Self-clean operation period	FAN	Drain pump	0 to 10 min.	None	Fan (UL)	STOP	10 to 60 min.	1 hour	60 min. to	2 hours	<p>And it is not also on the wireless remote controller. It is recognized as [STOP] from the remote monitor side.</p>
Compressor ON period	Self-clean operation period	FAN	Drain pump												
0 to 10 min.	None	Fan (UL)	STOP												
10 to 60 min.	1 hour														
60 min. to	2 hours														

No.	Item	Outline of specifications	Remarks
19	Save operation	<ol style="list-style-type: none"> 1) Turn on  button on the remote controller. 2) During operation of save operation,  lights on the wired remote controller. 3) During save operation, the current release control is performed with the restriction ratio set in EEPROM on the outdoor unit. 4) The restriction ratio can be set by keeping  button pushed for 4 seconds or more on the remote controller. 5) When validating the save operation, the next operation starts with save operation valid because contents are held even when operation stops, operation mode changes or power supply is reset. 6) The restriction ratio can be set by changing the setup data of CODE No. (DN) [C2] in the range of 50 to 100% (every 1%, Setting at shipment: 75%). 	<p>Carry out setting operation during stop of the unit; otherwise the unit stops operation.</p> <p>For the setup operation, refer to “How to set contents of save operation” in Section “8. SETUP AT LOCAL SITE AND OTHERS”.</p>
20	8°C heating/Frost protective operation	<ol style="list-style-type: none"> 1) This functional is intended for the cold latitudes and performs objective heating operation (8°C heating operation). 2) This function is valid only for combination with the outdoor units. 3) Using the indoor CODE No. [D1] (1 bit), Valid/Invalid of this function is set up at the customer's side. * The setup by CODE No. is Invalid [0]/Valid [1] and Invalid [0] has been set at the shipment. 4) This operation is the heating operation which sets 8°C as the setup temperature of the target. 5) This function starts operation by pushing temperature button  during heating operation; besides by pushing  button for 4 seconds or more after temperature reached the minimum set temperature. 6) To stop/release this operation, select and execute one from the following operations. <ol style="list-style-type: none"> ① Push  button: Heating operation (18°C setting) continues. ② Push [START/STOP] button: Air conditioner stops. (Heating 18°C operation at the next start) ③ Push  : Other operation mode is selected and the operation continues. 7) As the setup temperature is 8°C and the human heating is not targeted, the cold air discharge preventive control (Item 7) is made invalid to suppress the intermittent operation. 8) The settings of the air direction and air volume are changeable during this operation. 9) The indoor fan stops to protect the compressor for 2 minutes after start of heating operation (Thermo-ON) by this function. 	<p>In a group connection, if there is even one combination with other unit, “This function is not provided.” is displayed.</p> <p>The setup temperature jumps from [18] to [8].</p>

5-3. Indoor Print Circuit Board

<MCC-1631>

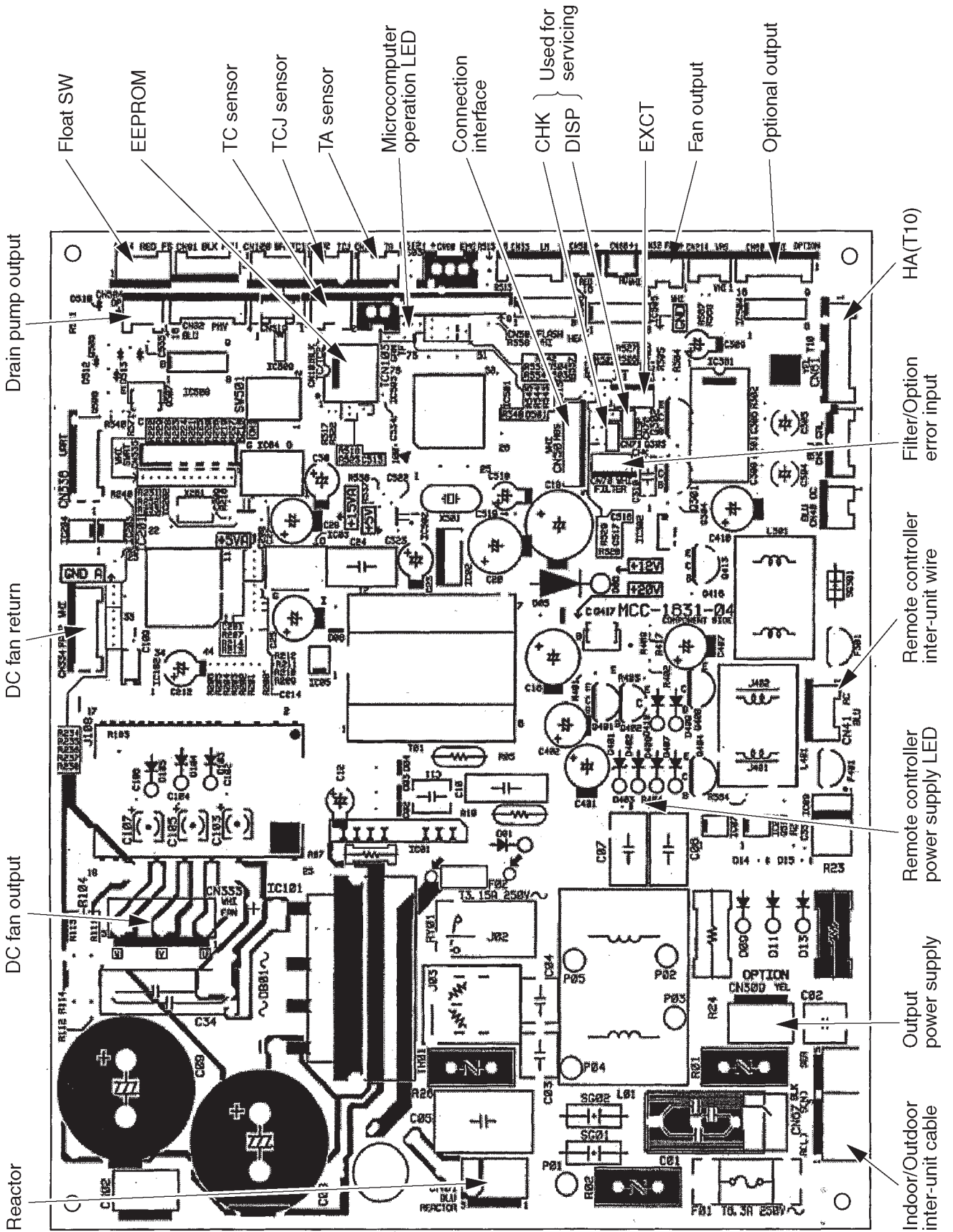

Indoor P.C. Board Optional Connector Specifications (MCC-1631)

Function	Connector No.	Pin No.	Specification	Remarks
Fan output	CN32	1	DC12 V	Factory default setting: ON when indoor unit in operation and OFF when indoor unit at rest * Fan can be operated on its own by pressing FAN button on remote controller (DN = 31)
		2	Output	
HA	CN61	1	Start / stop input	Start / stop input for HA (J01: In place / Removed = Pulse input (factory default) / Step input)
		2	0V(COM)	
		3	Remote controller disabling input	Enables / disables start / stop control via remote controller
		4	In-operation output	ON during operation (HA answerback signal)
		5	DC12 V (COM)	
		6	Alarm output	ON while alarm ON
Optional output	CN60	1	DC12 V (COM)	
		2	Defrosting output	ON while outdoor unit defrosted
		3	Thermostat ON output	ON while real thermostat ON (compressor ON)
		4	Cooling output	ON while air conditioner in cooling or related operation (COOL, DRY or cooling under AUTO mode)
		5	Heating output	ON while air conditioner in heating operation (HEAT or heating under AUTO mode)
		6	Fan output	ON while indoor fan ON (via interlock wiring)
External error input	CN80	1	DC12 V (COM)	Generates test code L30 and automatically shuts down air conditioner (only if condition persists for 1 minute)
		2	DC12 V (COM)	
		3	External error input	
CHK Operation check	CN71	1	Check mode input	Used for indoor operation check (prescribed operational status output, such as indoor fan "H" or drain pump ON, to be generated without communication with outdoor unit or remote controller)
		2	0 V	
DISP Display mode	CN72	1	Display mode input	Product display mode - Communication just between indoor unit and remote controller enabled (upon turning on of power) Timer short-circuited out (always)
		2	0 V	
EXCT Demand	CN73	1	Demand input	Imposes thermostat OFF on indoor unit
		2	0 V	

6. TROUBLESHOOTING

6-1. Summary of Troubleshooting

<Wired remote controller type>

1. Before troubleshooting

- 1) Required tools/instruments
 - ⊕ and ⊖ screwdrivers, spanners, radio cutting pliers, nippers, push pins for reset switch
 - Tester, thermometer, pressure gauge, etc.
- 2) Confirmation points before check
 - a) The following operations are normal.
 1. Compressor does not operate.
 - Is not 3-minutes delay (3 minutes after compressor OFF)?
 - Is not the outdoor unit in standby status though the remote controller reached the setup temperature?
 - Does not timer operate during fan operation?
 - Is not an overflow error detected on the indoor unit?
 - Is not outside high-temperature operation controlled in heating operation?
 2. Indoor fan does not rotate.
 - Does not cool air discharge preventive control work in heating operation?
 3. Outdoor fan does not rotate or air volume changes.
 - Does not high-temperature release operation control work in heating operation?
 - Does not outside low-temperature operation control work in cooling operation?
 - Is not defrost operation performed?
 4. ON/OFF operation cannot be performed from remote controller.
 - Is not automatic address being set up?
(When the power is turned on at the first time or when indoor unit address setting is changed, the operation cannot be performed for maximum approx. 5 minutes after power-ON.)
 - Is not being carried out a test run by operation of the outdoor P.C. board?
 - b) Did you return the cabling to the initial positions?
 - c) Are connecting cables of indoor unit and remote controller correct?

2. Troubleshooting procedure

When a trouble occurred, check the parts along with the following procedure.



NOTE

For cause of a trouble, power conditions or malfunction/erroneous diagnosis of microcomputer due to outer noise is considered except the items to be checked. If there is any noise source, change the cables of the remote controller to shield cables.

<Wireless remote controller type>

1. Before troubleshooting

- 1) Required tools/instruments
 - ⊕ and ⊖ screwdrivers, spanners, radio cutting pliers, nippers, etc.
 - Tester, thermometer, pressure gauge, etc.
- 2) Confirmation points before check
 - a) The following operations are normal.
 1. Compressor does not operate.
 - Is not 3-minutes delay (3 minutes after compressor OFF)?
 - Is not the outdoor unit in standby status though the remote controller reached the setup temperature?
 - Does not timer operate during fan operation?
 - Is not an overflow error detected on the indoor unit?
 - Is not outside high-temperature operation controlled in heating operation?
 2. Indoor fan does not rotate.
 - Does not cool air discharge preventive control work in heating operation?
 3. Outdoor fan does not rotate or air volume changes.
 - Does not high-temperature release operation control work in heating operation?
 - Does not outside low-temperature operation control work in cooling operation?
 - Is not defrost operation performed?
 4. ON/OFF operation cannot be performed from remote controller.
 - Is not forced operation performed?
 - Is not the control operation performed from outside/remote side?
 - Is not automatic address being set up?
 - Is not being carried out a test run by operation of the outdoor controller?
 - b) Did you return the cabling to the initial positions?
 - c) Are connecting cables between indoor unit and receiving unit correct?

2. Troubleshooting procedure

(When the power is turned on at the first time or when indoor unit address setting is changed, the operation cannot be performed for maximum approx. 5 minutes after power-ON.)

When a trouble occurred, check the parts along with the following procedure.



Outline of judgment

When one of the following phenomena appears, an error of the power relay (RY01) is considered; therefore replace the P.C. board.

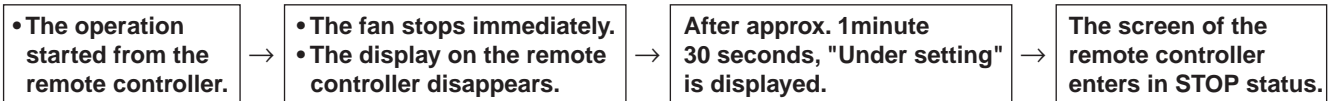

The primary judgment to check whether a trouble occurred in the indoor unit or outdoor unit is carried out with the following method.

Method to judge the erroneous position by display panel of the indoor unit
(lamp display of the wireless receiving part)

The indoor unit monitors the operating status of the air conditioner, and the blocked contents of self-diagnosis are displayed restricted to the following cases if a protective circuit works.

● : Go off, ○ : Go on, ☼ : Flash (0.5 sec.)

Lamp indication	Check code	Cause of trouble occurrence		
Operation Timer Ready ● ● ● No indication at all	—	Power supply OFF or miswiring between lamp indication unit and indoor unit		
Operation Timer Ready ☼ ● ● Flash	E01	Receiving error } Receiving unit } Sending error } Communication stop } Miswiring or wire connection error between receiving unit and indoor unit		
	E02			
	E03			
	Operation Timer Ready ☼ ● ● Flash	E08	Duplicated indoor unit No. } Duplicated master units of remote controller } Setup error	
		E09		
		E10		
		E18		
Operation Timer Ready ● ● ☼ Flash	E04	Miswiring between indoor unit and outdoor unit or connection error (Communication stop between indoor and outdoor units)		
Operation Timer Ready ● ☼ ☼ Alternate flash	P10	Overflow was detected. } Indoor DC fan error } Protective device of indoor unit worked.		
	P12			
Operation Timer Ready ☼ ● ☼ Alternate flash	P03	Outdoor unit discharge temp. error } Outdoor high pressure system error } Protective device of outdoor unit worked. *1		
	P04			
	P05 P07 P15	Negative phase detection error } Heat sink overheat error } Gas leak detection error } Outdoor unit error		
			P19	4-way valve system error (Indoor or outdoor unit judged.)
			P20	Outdoor unit high pressure protection
	P22 P26 P29	Outdoor unit: Outdoor unit error } Outdoor unit: Inverter Idc operation } Outdoor unit: Position detection error } Protective device of outdoor unit worked. *1		
			P31	Stopped because of error of other indoor unit in a group (Check codes of E03/L03/L07/L08)

*1: These are representative examples and the check code differs according to the outdoor unit to be combined.

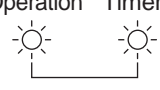
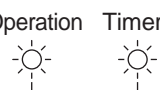
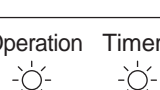
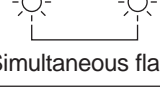
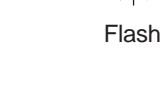
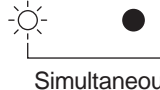
Lamp indication	Check code	Cause of trouble occurrence	
Operation Timer Ready  Alternate flash	F01	Heat exchanger sensor (TCJ) error } Indoor unit sensor error	
	F02		Heat exchanger sensor (TC) error
	F10		Heat exchanger sensor (TA) error
Operation Timer Ready  Alternate flash	F04	} Sensor error of outdoor unit *1	
	F06		Discharge temp. sensor (TD) error
	F07		Temp. sensor (TE) error
	F08		Temp. sensor (TL) error
	F12		Temp. sensor (TO) error
	F13		Temp. sensor (TS) error
	F15		Temp. sensor (TH) error
Operation Timer Ready  Simultaneous flash	F29	Indoor EEPROM error	
	F31	Outdoor EEPROM error	
Operation Timer Ready  Flash	H01	} Outdoor compressor system error *1	
	H02		Compressor break down
	H03		Compressor lock
	H04		Current detection circuit error
	H06		Case thermostat worked.
Operation Timer Ready  Simultaneous flash	L03	} → AUTO address * If group construction and address are not normal when power supply turned on, automatically goes to address setup mode.	
	L07		Duplicated header indoor units
	L08		There is indoor unit of group connection in individual indoor unit.
	L09		Unsetting of group address
Operation Timer Ready  Simultaneous flash	L10	} Others	
	L20		Unset model type (Service board)
	L29		Duplicated indoor central addresses
	L30		Outdoor unit and other error
	L31		Outside interlock error
		Negative phase error	

*1: These are representative examples and the check code differs according to the outdoor unit to be combined.

Others (Other than Check Code)

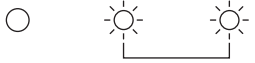
Lamp indication	Check code	Cause of trouble occurrence
Operation Timer Ready  Simultaneous flash	—	During test run
Operation Timer Ready  Alternate flash	—	Disagreement cool/heat (Automatic cool/heat setting to automatic cool/heat prohibited mode)

6-2. Check Code List (Indoor) (Indoor unit detected)

Check code indication TCC-LINK central & Remote controller	Representative defective position	Explanation of error contents	Air conditioner operation Automatic reset	Operation continuation
E03	Regular communication error between indoor and remote controller	No communication from remote controller and network adapter (Also no communication from central control system)	○	×
E04	Indoor/Outdoor serial error	There is error on serial communication between indoor and outdoor units	○	×
E08	Duplicated indoor addresses	Same address as yours was detected.	○	×
E10	Communication error between indoor MCU	MCU communication error between main motor and micro computer	○	×
E18	Regular communication error between indoor master and follower units	Regular communication between indoor master and follower units is impossible.	○	×
F01	Indoor unit, Heat exchanger (TC-J) error	Open/short was detected on heat exchanger (TC-J).	○	×
F02	Indoor unit, Heat exchanger (TC) error	Open/short was detected on heat exchanger (TC).	○	×
F10	Indoor unit, Room temp. sensor (TA) error	Open/short was detected on room temp. sensor (TA).	○	×
F29	Indoor unit, other indoor PC board error	EEPROM error (Other error may be detected. If no error, automatic address is repeated.	×	×
L03	Duplicated setting of indoor group master unit	There are multiple master units in a group.	×	×
L07	There is group cable in individual indoor unit.	When even one group connection indoor unit exists in individual indoor unit.	×	×
L08	Unset indoor group address	Indoor group address is unset.	×	×
L09	Unset indoor capacity	Capacity of indoor unit is unset.	×	×
L20	Duplicated central control system address	Duplicated setting of central control system address	○	×
L30	Outside error input to indoor unit (Interlock)	Abnormal stop by outside error (CN80) input	×	×
P01	Indoor unit, AC fan error	An error of indoor AC fan was detected. (Fan motor thermal relay worked.)	×	×
P10	Indoor unit, overflow detection	Floater switch worked.	×	×
P12	Indoor unit, DC fan error	Indoor DC fan error (Over-current/Lock, etc.) was detected. Static pressure error set	×	×
P19	4-way valve system error	In heating operation, an error was detected by temp. down of indoor heat exchanger sensor.	○	×
P31	Other indoor unit error	Follower unit in group cannot operate by warning from [E03/L03/L07/L08] of master unit.	○	×

◇ When this warning was detected before group construction/address check finish at power supply was turned on, the mode shifts automatically to AUTO address setup mode.

(Remote controller detected)

Check code indication Remote controller	Representative defective position	Explanation of error contents	Air conditioner operation Automatic reset	Operation continuation
E01	No master remote controller, Remote controller communication (Receive) error	Signal cannot be received from indoor unit. Master remote controller was not set. (including 2 remote controllers)	—	—
E02	Remote controller communication (Send) error	Signal cannot be sent to indoor unit.	—	—
E09	Duplicated master remote controller	In 2-remote controller control, both were set as master. (Indoor master unit stops warning and follower unit continues operation.)	×	△

(Central control devices detected)

Check code indication TCC-LINK central	Representative defective position	Explanation of error contents	Air conditioner operation Automatic reset	Operation continuation
C05	Central control system communication (send) error	Signal sending operation of central control system is impossible. There are multiple same central devices. (AI-NET)	—	—
C06	Central control system communication (receive) error	Signal receiving operation of central control system is impossible.	—	—
C12	General-purpose device control interface batched warning	An error on device connected to general-purpose device control interface of exclusive to TCC-LINK/AI-NET	—	—
P30	Group follower unit is defective.	Group follower unit is defective. (For remote controller, above-mentioned [***] details are displayed with unit No.)	—	—

NOTE: Even for the same contents of error such as communication error, the display of check code may differ according to detection device.
When remote controller or central controller detects an error, it is not necessarily related to operation of the air conditioner. In this list, the check codes that outdoor unit detects are not described.

Check Code List

Error mode detected by indoor unit

Operation of diagnostic function				Judgment and measures
Check code	Cause of operation	Status of air conditioner	Condition	
E03	No communication from remote controller (including wireless) and communication adapter	Stop (Automatic reset)	Displayed when error is detected	1. Check cables of remote controller and communication adapters. • Remote controller LCD display OFF (Disconnection) • Central remote controller [97] check code
E04	The serial signal is not output from outdoor unit to indoor unit. • Miswiring of inter-unit wire • Defective serial sending circuit on outdoor P.C. board • Defective serial receiving circuit on indoor P.C. board	Stop (Automatic reset)	Displayed when error is detected	1. Outdoor unit does not completely operate. • Inter-unit wire check, correction of miswiring • Check outdoor P.C. board. Correct wiring of P.C. board. 2. When outdoor unit normally operates Check P.C. board (Indoor receiving / Outdoor sending).
E08	Duplicated indoor unit address	Stop	Displayed when error is detected	1. Check whether remote controller connection (Group/Individual) was changed or not after power supply turned on (Finish of group construction/Address check). * If group construction and address are not normal when the power has been turned on, the mode automatically shifts to address setup mode. (Resetting of address)
L03	Duplicated indoor header unit			
L07	There is group wire in individual indoor unit.			
L08	Unset indoor group address			
L09	Unset indoor capacity	Stop	Displayed when error is detected	1. Set indoor capacity (DN=11)
L30	Abnormal input of outside interlock	Stop	Displayed when error is detected	1. Check outside devices. 2. Check indoor P.C. board.
P10	Float switch operation • Float circuit, Disconnection, Coming-off, Float switch contact error	Stop	Displayed when error is detected	1. Trouble of drain pump 2. Clogging of drain pump 3. Check float switch. 4. Check indoor P.C. board.
P12	Indoor DC fan error	Stop	Displayed when error is detected	1. Position detection error 2. Indoor fan driving part over-current protective circuit operation 3. Indoor fan lock 4. Indoor P.C. board check 5. Static pressure error set
P19	4-way valve system error • After heating operation has started, indoor heat exchangers temp. is down.	Stop (Automatic reset)	Displayed when error is detected	1. Check 4-way valve. 2. Check 2-way valve and check valve. 3. Check indoor heat exchanger (TC/TCJ). 4. Check indoor P.C. board.
P31	Own unit stops while warning is output to other indoor units.	Stop (Follower unit) (Automatic reset)	Displayed when error is detected	1. Judge follower unit while master unit is [E03], [L03], [L07] or [L08]. 2. Check indoor P.C. board.
F01	Coming-off, disconnection or short of indoor heat exchanger temp. sensor (TCJ)	Stop (Automatic reset)	Displayed when error is detected	1. Check indoor heat exchanger temp. sensor (TCJ). 2. Check indoor P.C. board.
F02	Coming-off, disconnection or short of indoor heat exchanger temp. sensor (TC)	Stop (Automatic reset)	Displayed when error is detected	1. Check indoor heat exchanger temp. sensor (TC). 2. Check indoor P.C. board.
F10	Coming-off, disconnection or short of indoor heat exchanger temp. sensor (TA)	Stop (Automatic reset)	Displayed when error is detected	1. Check indoor heat exchanger temp. sensor (TA). 2. Check indoor P.C. board.
F29	Indoor EEPROM error • EEPROM access error	Stop (Automatic reset)	Displayed when error is detected	1. Check indoor EEPROM. (including socket insertion) 2. Check indoor P.C. board.
E10	Communication error between indoor MCU • Communication error between fan driving MCU and main MCU	Stop (Automatic reset)	Displayed when error is detected	1. Check indoor P.C. board.
E18	Regular communication error between indoor header and follower units	Stop (Automatic reset)	Displayed when error is detected	1. Check remote controller wiring. 2. Check indoor power supply wiring. 3. Check indoor P.C. board.

Error mode detected by outdoor unit

Operation of diagnostic function				Judgment and measures
Check code	Cause of operation	Status of air conditioner	Condition	
Indoor unit				
F04	Disconnection, short of discharge temp. sensor (TD)	Stop	Displayed when error is detected	1. Check discharge temp. sensor (TD). 2. Check outdoor P.C. board.
F06	Disconnection, short of outdoor temp. sensor (TE)	Stop	Displayed when error is detected	1. Check temp. sensor (TE). 2. Check outdoor P.C. board.
F07	Disconnection, short of outdoor temp. sensor (TL)	Stop	Displayed when error is detected	1. Check temp. sensor (TL). 2. Check outdoor P.C. board.
F12	Disconnection, short of suction temp. sensor (TS)	Stop	Displayed when error is detected	1. Check suction temp. sensor (TS). 2. Check outdoor P.C. board.
F15	Miss-mounting of outdoor temp. sensor (TE, TS)	Stop	Displayed when error is detected	1. Check temp. sensor (TE, TS). 2. Check outdoor P.C. board.
F08	Disconnection, short of outside temp. sensor (TO)	Continue	Displayed when error is detected	1. Check outside temp. sensor (TO). 2. Check outdoor P.C. board.
F13	Disconnection, short of heat sink temp. sensor (TH)	Stop	Displayed when error is detected	1. Check outdoor P.C. board. (Q201 is incorporated in TH sensor.)
F31	Outdoor P.C. EEPROM error	Stop	Displayed when error is detected	1. Check outdoor P.C. board.
L10	Unset jumper of service P.C. board	Stop	Displayed when error is detected	1. Outdoor service P.C. board Check model type setting jumper wire.
L29	Communication error between outdoor P.C. board MCU	Stop	Displayed when error is detected	1. Check outdoor P.C. board 2. Connection check for each P.C. board.
P07	Heat sink overheat error * Heat sink temp. sensor detected over specified temperature.	Stop	Displayed when error is detected	1. Check screw tightening between PC. Board and heat sink and check radiator grease. 2. Check heat sink blast path.
P15	Detection of gas leak * Discharge temp. sensor (TD), Suction temp. sensor (TS) detected temperature over specified temp.	Stop	Displayed when error is detected	1. Check gas leak, recharge 2. Check full open of service valve. 3. Check PMV (Pulse Motor Valve). 4. Check broken pipe. 5. Check discharge temp. sensor (TD), suction temp. sensor (TS).
P19	4-way valve inverse error * After heating operation has started, indoor heat exchanger temp. lowers under the specified temp. * After heating operation has started, outdoor heat exchanger / suction temp. rises over the specified temp.	Stop	Displayed when error is detected	1. Check operation of 4-way valve. 2. Check outdoor heat exchanger (TE), suction temp. sensor (TS). 3. Check indoor heat exchanger sensor (TC). 4. Check 4-way valve coil. 5. Check PMV (Pulse Motor Valve).
H01	Compressor break down * Although operation has started, operation frequency decreases and operation stops.	Stop	Displayed when error is detected	1. Check power supply voltage. 2. Overload operation of refrigerating cycle
H02	Compressor lock * Over-current detection after compressor start-up	Stop	Displayed when error is detected	1. Trouble of compressor (Lock, etc.): Replace compressor. 2. Wiring error of compressor (Open phase)

Operation of diagnostic function				Judgment and measures
Check code	Cause of operation	Status of air conditioner	Condition	
Indoor unit				
H03	Current detection circuit error	Stop	Displayed when error is detected	1. Check outdoor P.C. board. (AC current detection circuit)
P05	Open phase of 3-phase power supply	Stop	Displayed when error is detected	1. Check open phase of 3-phase power supply. 2. Black lead wire to be connected to CN03 of outdoor P. C. board does not pass through T611.
F23	Ps sensor error	Stop	Displayed when error is detected	1. Check connection of Ps sensor connector. 2. Check failure of Ps sensor. 3. Check compressing power error of compressor. 4. Check 4-way valve error. 5. Check outdoor P.C. board error.
H06	Low pressure protective operation	Stop	Displayed when error is detected	1. Check service valves are fully opened. (Gas side, Liquid side) 2. Check clogging of outdoor PMV. (PMV1, 2) 3. Check SV2 circuit. 4. Check Ps sensor error. 5. Check clogging of indoor filter. 6. Check clogging of refrigerant pipe. 7. Check of outdoor fan operation. (In heating mode) 8. Check short of refrigerant.
P03	Discharge temp. error * Discharge temp. (TD) over specified value was detected.(1.6)	Stop	Displayed when error is detected	1. Check refrigerating cycle (Gas leak) 2. Trouble of electronic expansion valve 3. Check discharge temp. sensor (TD).
H04	Case thermostat operation * Abnormal overheat of compressor	Stop	Displayed when error is detected	1. Check case thermostat and connector. 2. Check gas leak, recharge 3. Check full open of service valve. 4. Check PMV (Pulse Motor Valve). 5. Check broken pipe.
P04	High pressure SW system error	Stop	Displayed when error is detected	1. Check service valves are fully opened. (Gas side, Liquid side) 2. Check of outdoor fan operation. 3. Check motor error of outdoor fan. 4. Check clogging of outdoor PMV. (PMV1, 2) 5. Check clogging of heat exchanger in indoor/outdoor units. 6. Short-circuit status of suction/discharge air in outdoor unit. 7. Check outdoor P.C. board error. 8. Check fan system error (Cause of air volume drop) at indoor side. 9. Check PMV opening status in indoor unit.
P05	Power supply voltage error	Stop	Displayed when error is detected	1. Check power supply voltage.
P20	High pressure protective operation • During cooling operation, outdoor temp. sensor (TL) detected temperature over specified temp. • During heating operation, indoor temp. sensor (TC, TCJ) detected temperature over specified temp.	Stop	Displayed when error is detected	1. Check outdoor heat exchanger sensor (TL). 2. Check indoor heat exchanger sensor (TC, TCJ). 3. Check full open of service valve. 4. Check indoor/outdoor fan. 5. Check PMV (Pulse Motor Valve). 6. Check clogging and short circuit of indoor/outdoor heat exchanger. 7. Overcharge of refrigerant. Recharge
P22	Outdoor fan system error	Stop	Displayed when error is detected	1. Check lock of fan motor. 2. Check power supply voltage between L2 and N. 3. Check outdoor P.C. board.
P26	Short-circuit error of compressor driving element	Stop	Displayed when error is detected	1. When performing operation while taking-off compressor wire, P26 error occurs. Check control P.C. board. 2. When performing operation while taking-off compressor wire, an error does not occur. (Compressor rare short)
P29	Position detection circuit error	Stop	Displayed when error is detected	1. Check control P.C. board.

Error mode detected by remote controller or central controller (TCC-LINK)

Operation of diagnostic function				Judgment and measures
Check code	Cause of operation	Status of air conditioner	Condition	
Not displayed at all (Operation on remote controller is impossible.)	No communication with master indoor unit <ul style="list-style-type: none"> Remote controller wiring is not correct. Power of indoor unit is not turned on. Automatic address cannot be completed. 	Stop	—	Power supply error of remote controller, Indoor EEPROM error <ol style="list-style-type: none"> 1. Check remote controller inter-unit wiring. 2. Check remote controller. 3. Check indoor power wiring. 4. Check indoor P.C. board. 5. Check indoor EEPROM. (including socket insertion) → Automatic address repeating phenomenon generates.
E01 *2	No communication with master indoor unit <ul style="list-style-type: none"> Disconnection of inter-unit wire between remote controller and master indoor unit (Detected by remote controller side) 	Stop (Automatic reset) * If center exists, operation continues.	Displayed when error is detected	Receiving error from remote controller <ol style="list-style-type: none"> 1. Check remote controller inter-unit wiring. 2. Check remote controller. 3. Check indoor power wiring. 4. Check indoor P.C. board.
E02	Signal send error to indoor unit (Detected by remote controller side)	Stop (Automatic reset) * If center exists, operation continues.	Displayed when error is detected	Sending error of remote controller <ol style="list-style-type: none"> 1. Check sending circuit inside of remote controller. → Replace remote controller.
E09	There are multiple main remote controllers. (Detected by remote controller side)	Stop (Sub unit continues operation.)	Displayed when error is detected	<ol style="list-style-type: none"> 1. In 2-remote controllers (including wireless), there are multiple main units. Check that there are 1 main remote controller and other sub remote controllers.
L20 ----- Central controller L20	Duplicated indoor central addresses on communication of central control system (Detected by indoor/central controller side)	Stop (Automatic reset)	Displayed when error is detected	<ol style="list-style-type: none"> 1. Check setting of central control system network address. (Network adapter SW01) 2. Check network adapter P.C. board.
— *3 ----- Central controller (Send) C05 (Receive) C06	Communication circuit error of central control system (Detected by central controller side)	Continues (By remote controller)	Displayed when error is detected	<ol style="list-style-type: none"> 1. Check communication wire / miswiring 2. Check communication (U3, U4 terminals) 3. Check network adapter P.C. board. 4. Check central controller (such as central control remote controller, etc.) 5. Check terminal resistance. (TCC-LINK)
— ----- Central controller P30	Indoor Gr sub unit error (Detected by central controller side)	Continuation/Stop (According to each case)	Displayed when error is detected	Check the check code of the corresponding unit from remote controller.

*2 The check code cannot be displayed by the wired remote controller.
(Usual operation of air conditioner becomes unavailable.)

For the wireless models, an error is notified with indication lamp.

*3 This trouble is related to communication of remote controller (A, B), central system (TCC-LINK U3, U4), and [E01], [E02], [E03], [E09] or [E18] is displayed or no check display on the remote controller according to the contents.

6-3. Diagnostic Procedure for Each Check Code (Indoor Unit)

Check code

[E01 error]

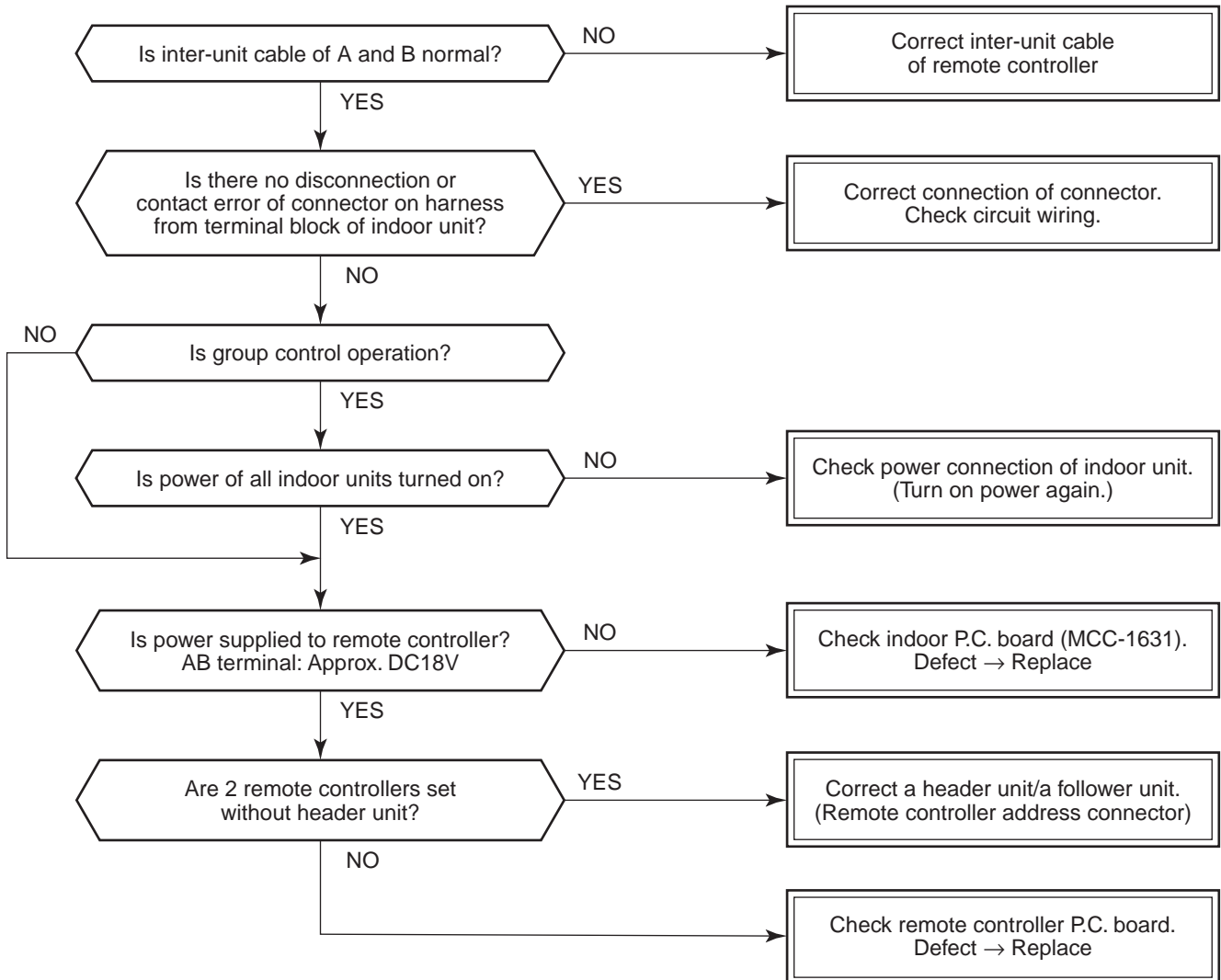

[E09 error]

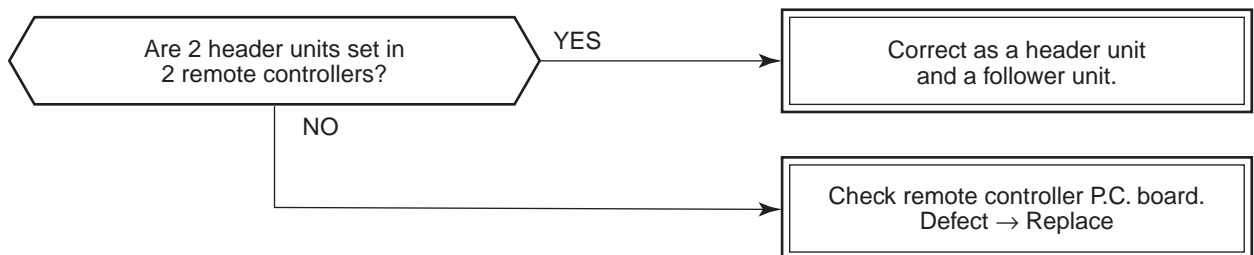

[E04 error]

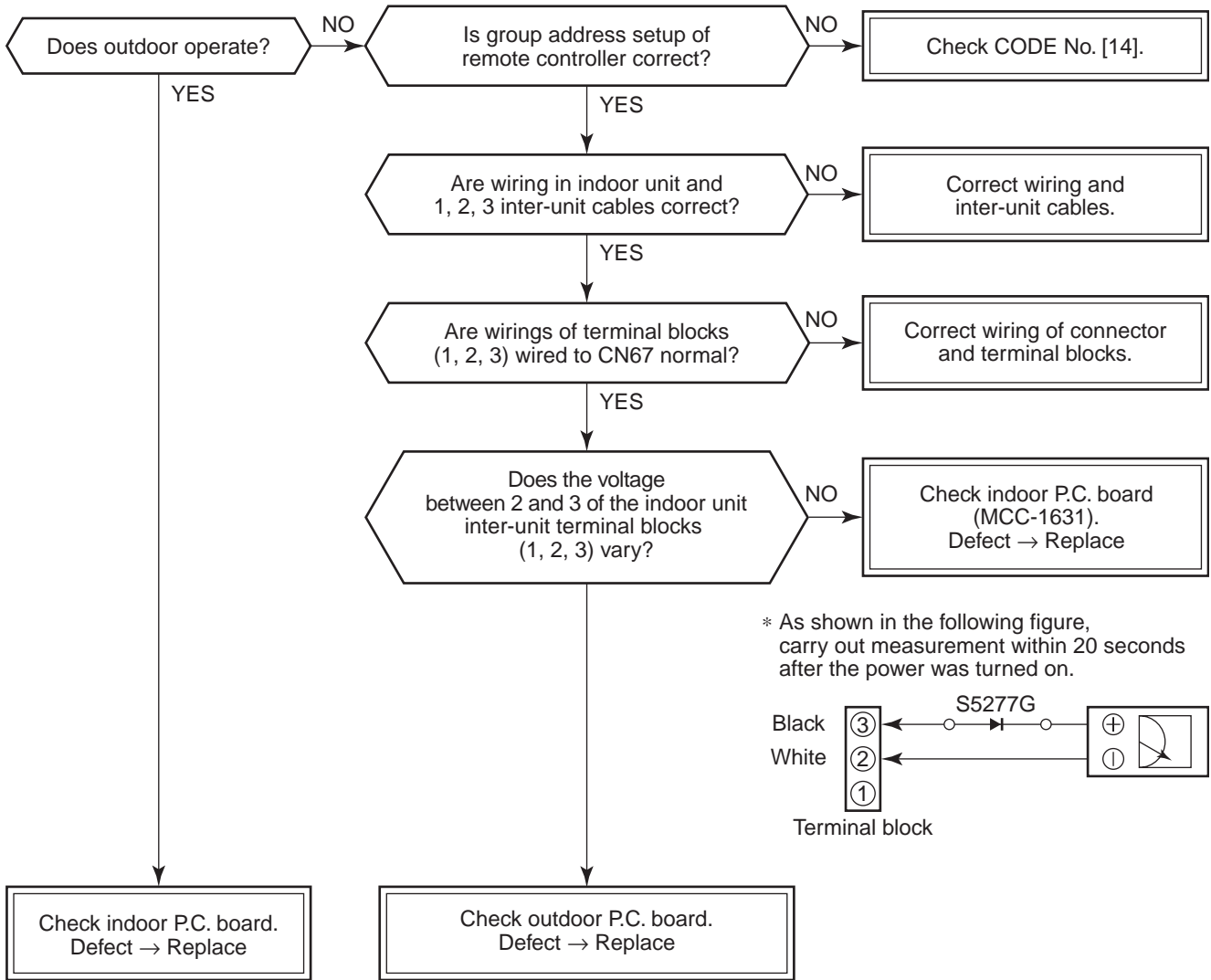

[E10 error]

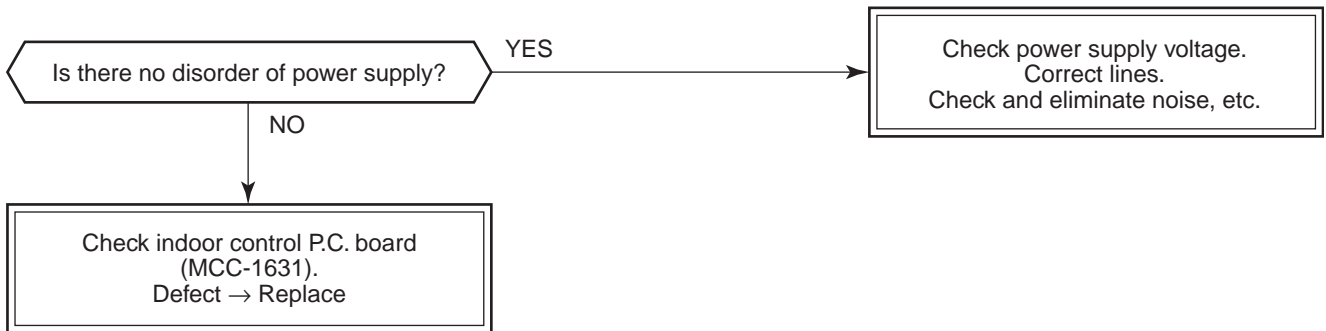

[E18 error]

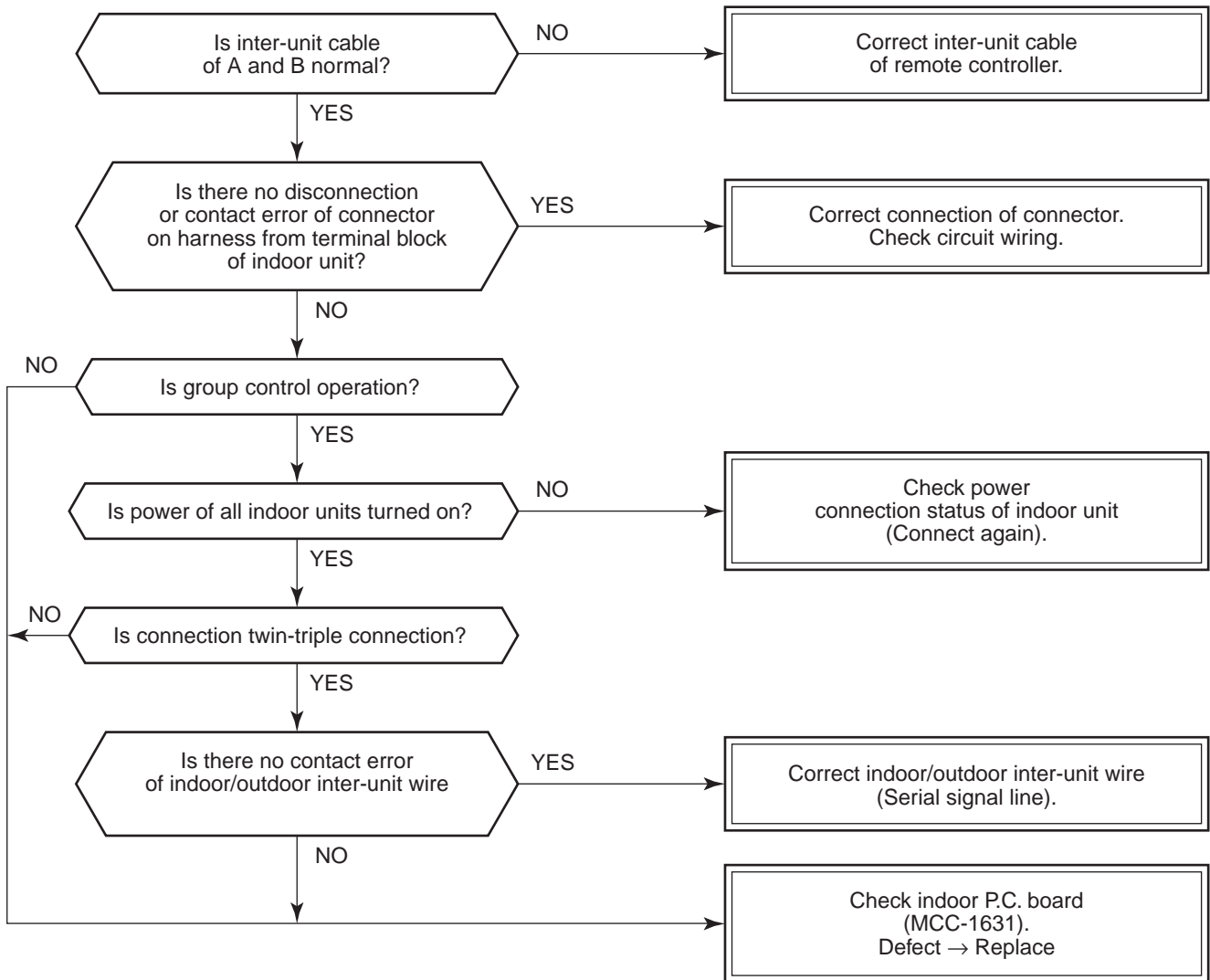

[E08, L03, L07, L08 error]

E08: Duplicated indoor unit No.

L03: There are 2 or more header units in a group control.

L07: There is 1 or more group address [Individual] in a group control.

L08: The indoor group address is unset. (99)

If the above error is detected when power supply turned on, the mode enters automatically in the automatic address set mode. (Check code is not output.)

However, if the above error is detected during the automatic address set mode, a check code may be output.

[L09 error]

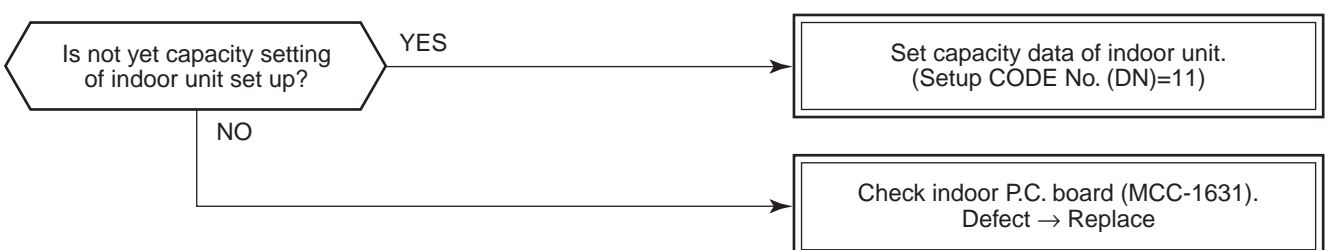

[L20 error]

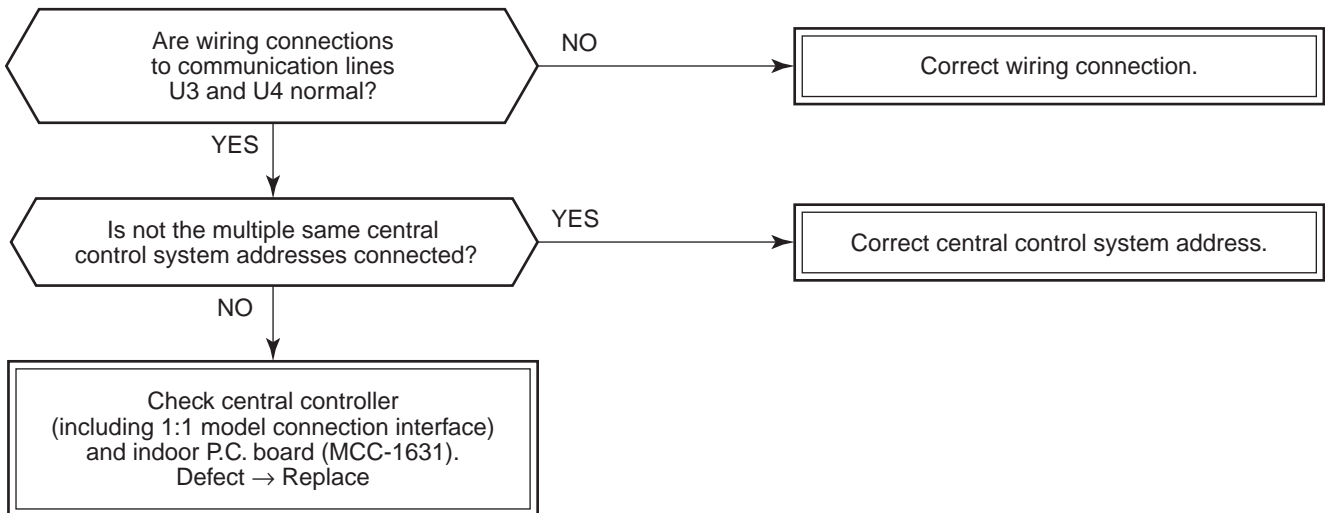

[L30 error]

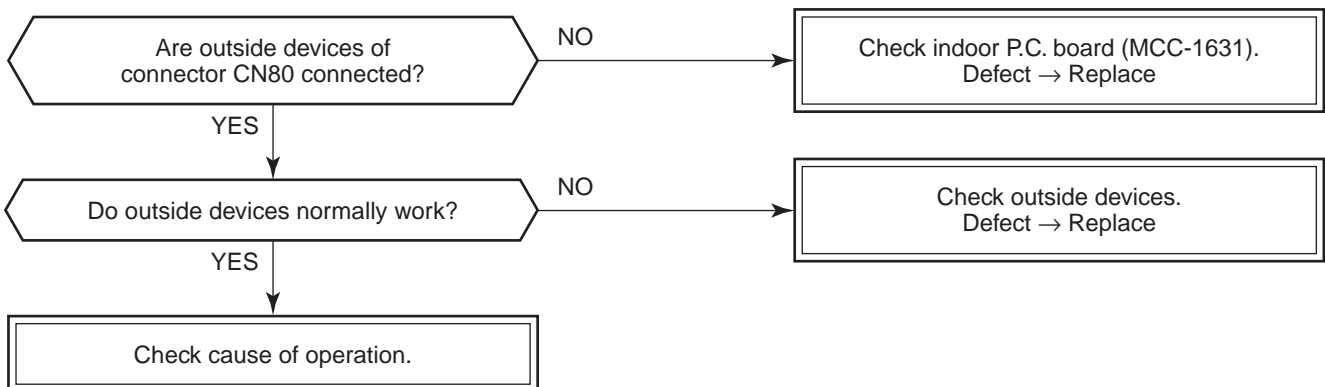

[P30 error] (Central controller)

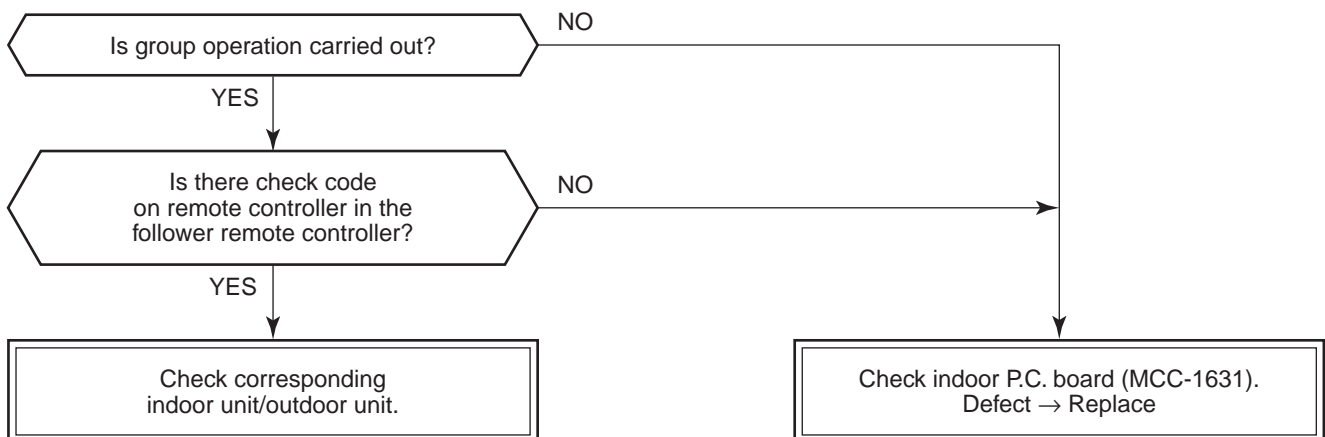

[P10 error]

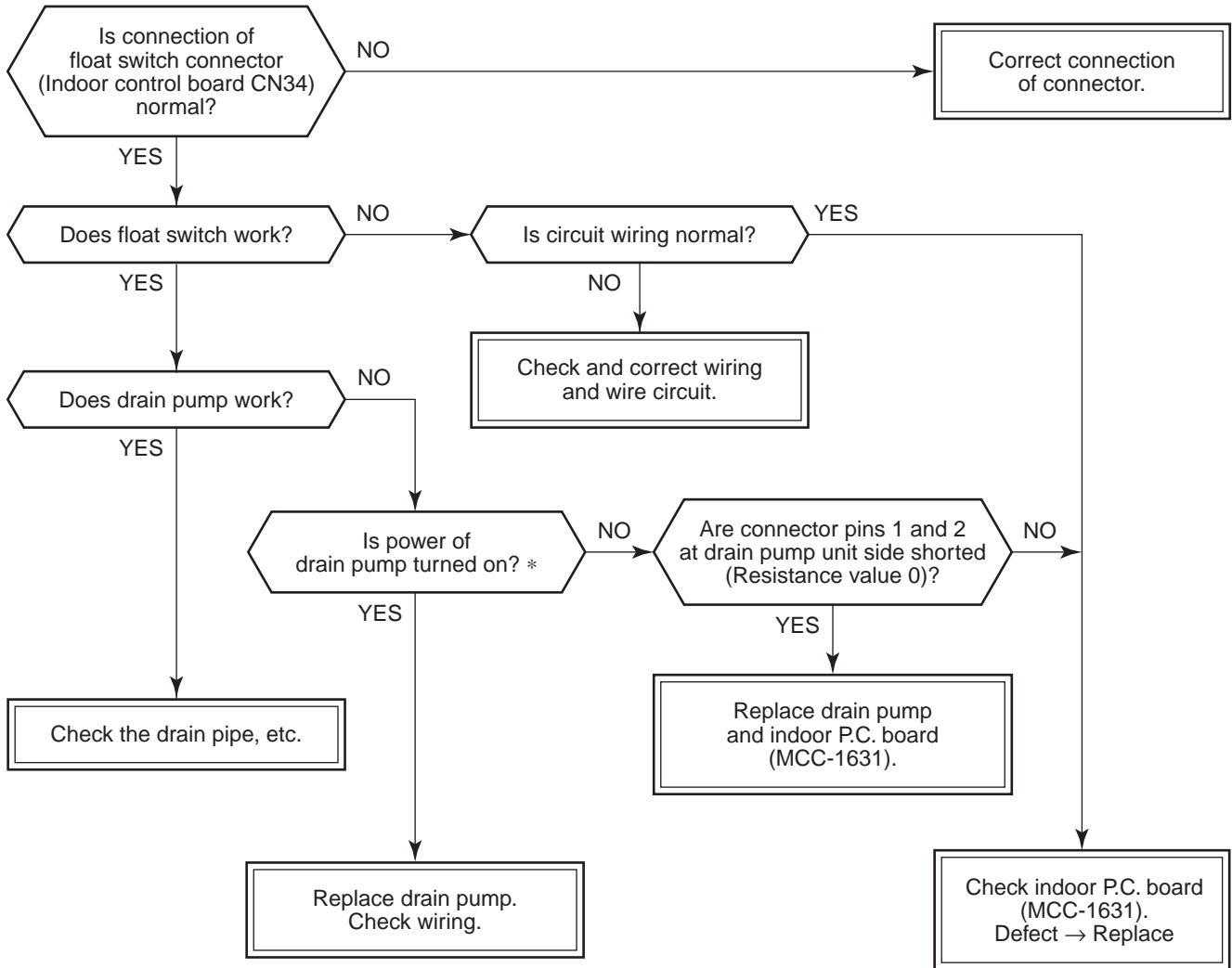

* Check that voltage of 1 – 2 pin of CN504 on the indoor P.C. board is Approx., 12V.

[F10 error]

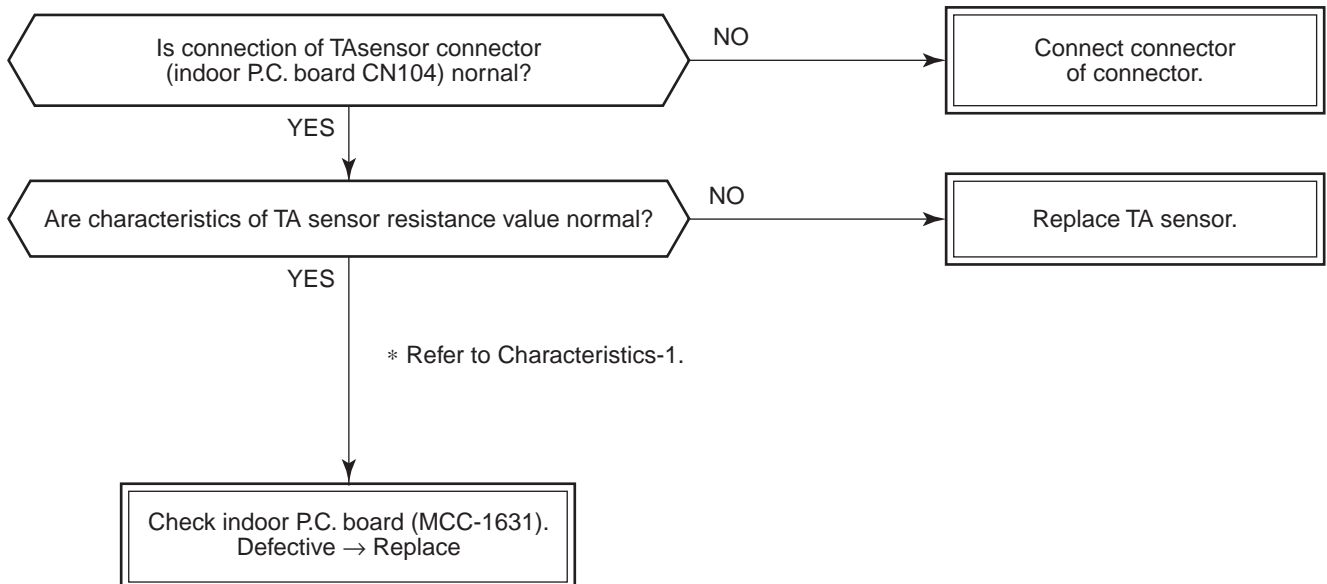

[P12 error]

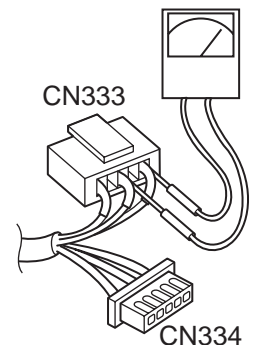
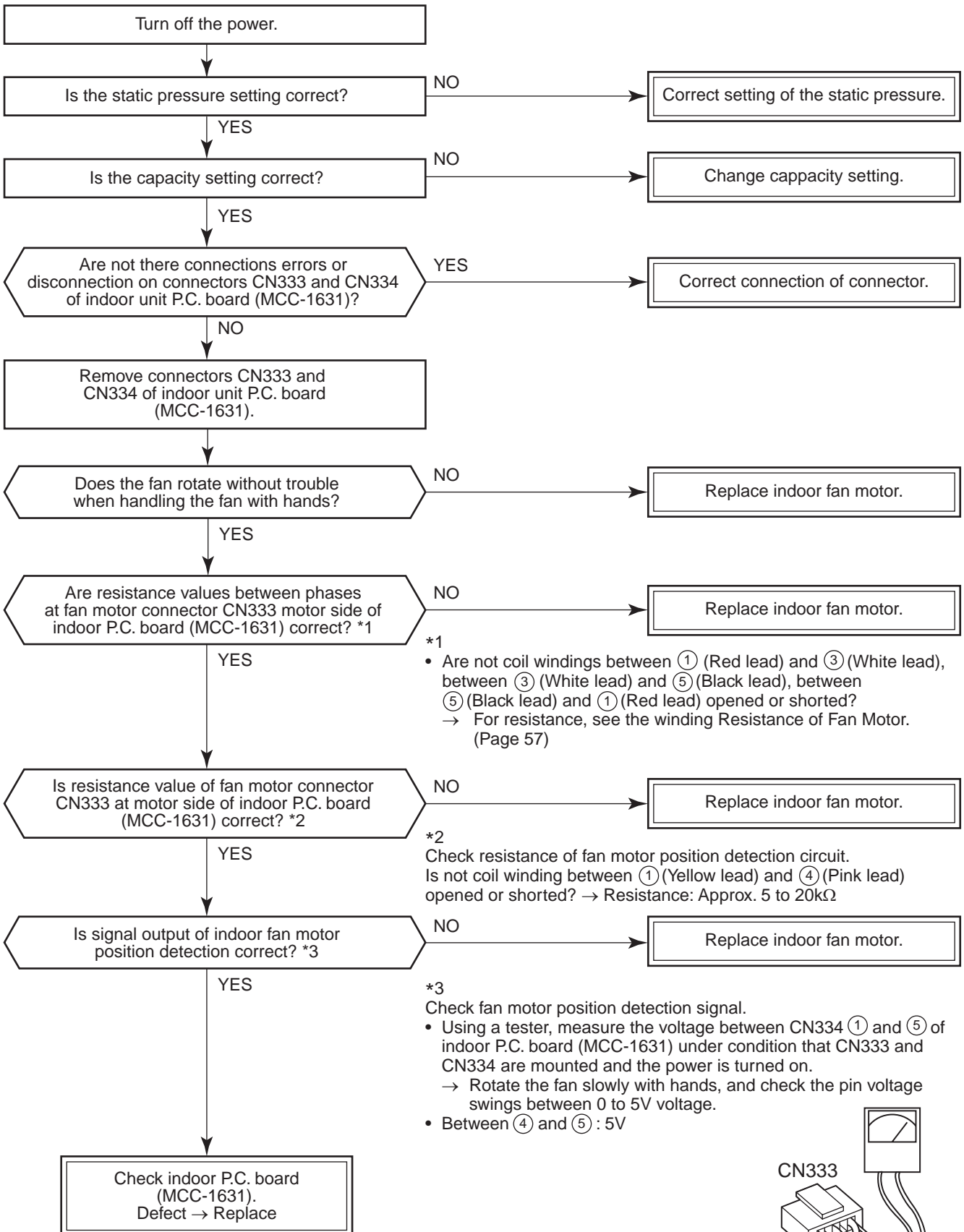

[P19 error]

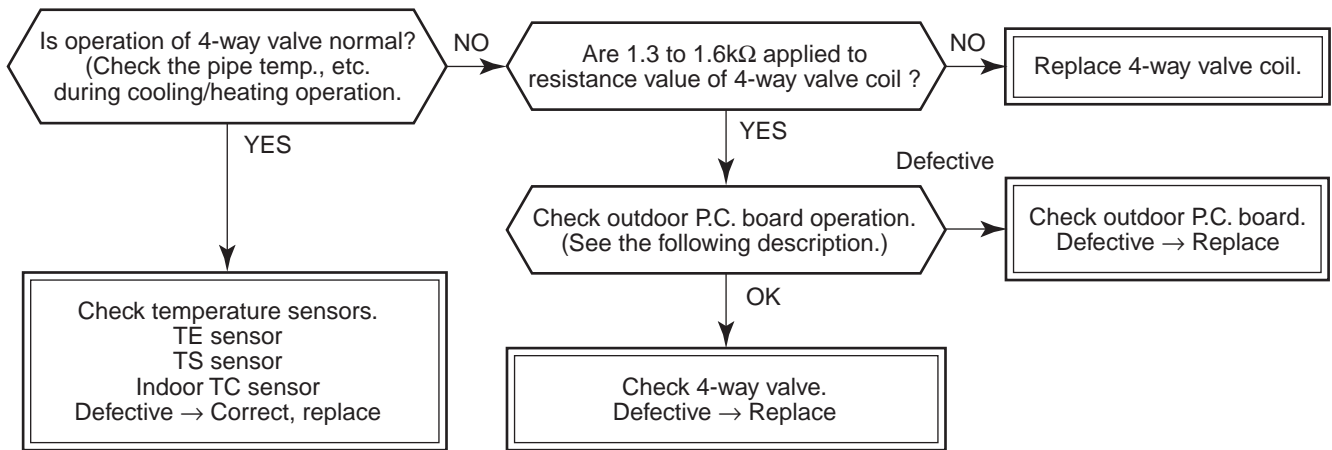

Operation check direction of the outdoor P.C. board (In case of self-preservation valve)

- 1) Set the Dip switch SW804 as same as the following table and push SW801 for approx. 1 second. It enables you to check the exchange operation to cooling cycle or heating cycle.
 - Only for approx. 10 seconds, the power is turned on.
 - As the heat value of part (coil: resistance R700) is large, when checking the operation continuously, wait 1 minute or more until the next check. (There is no problem if a coil is not connected.)
- 2) After check, turn off all the Dip switches SW804.

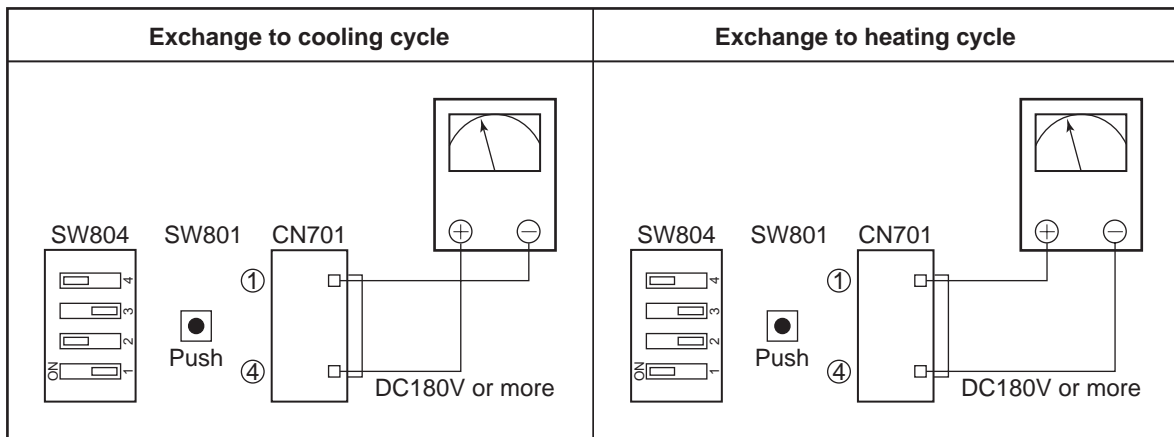

Check by tester

Analog tester: Good article if over DC180V

Digital tester: Although in some cases, the value varied and indicated. If the maximum value is DC180V or more, it is good article.

[F02 error]

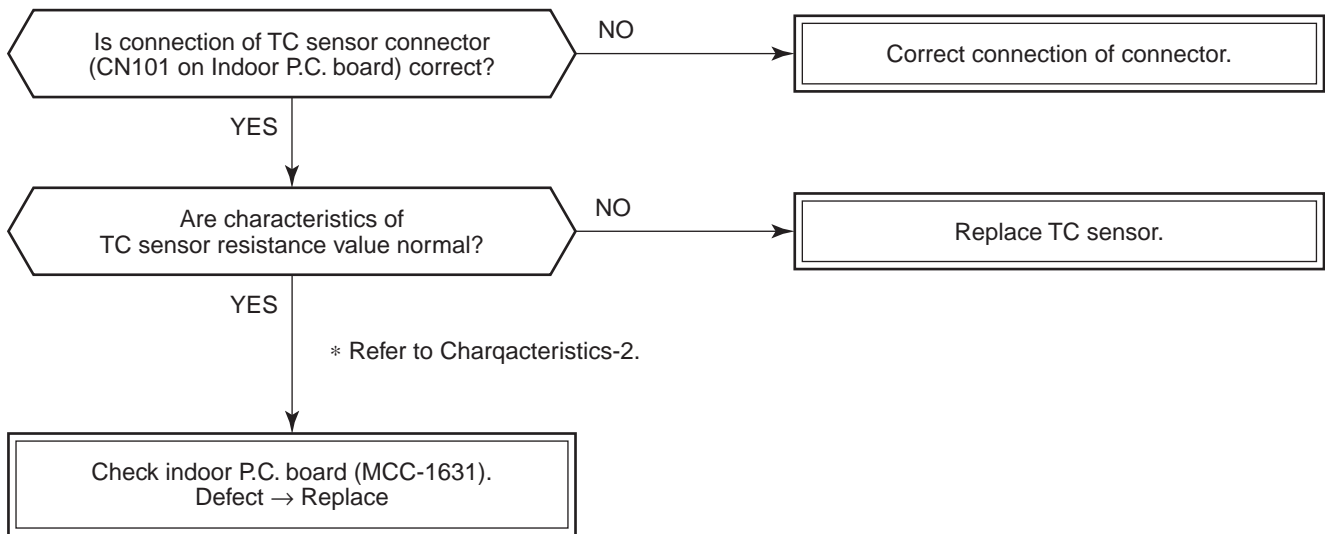

[F01 error]

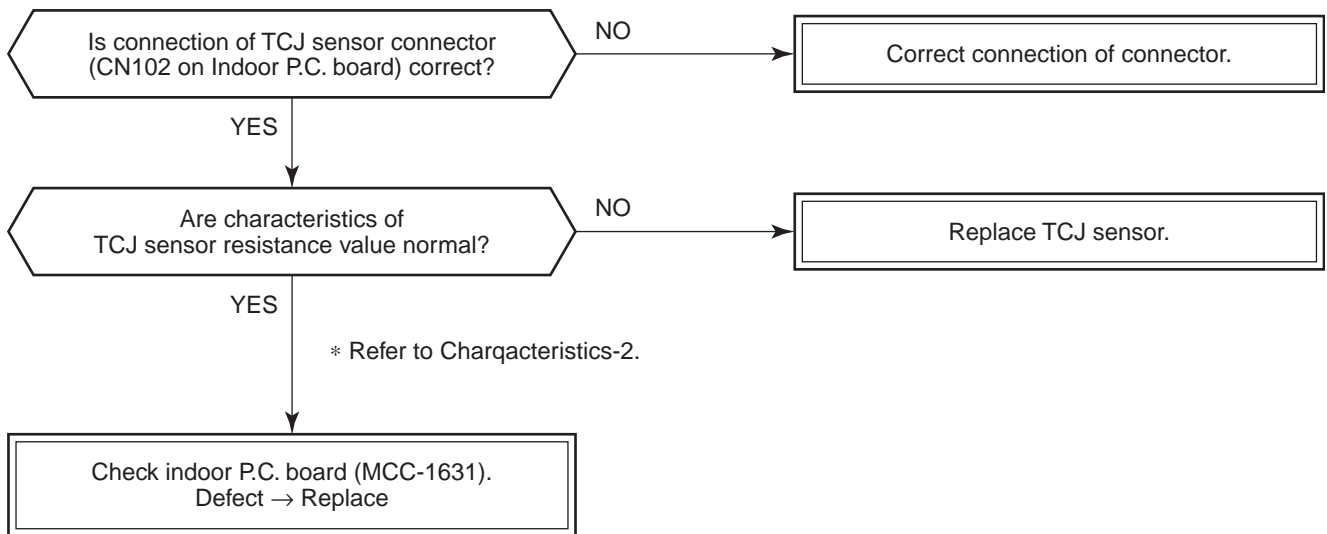

[C06 error] (1:1 model connection interface)

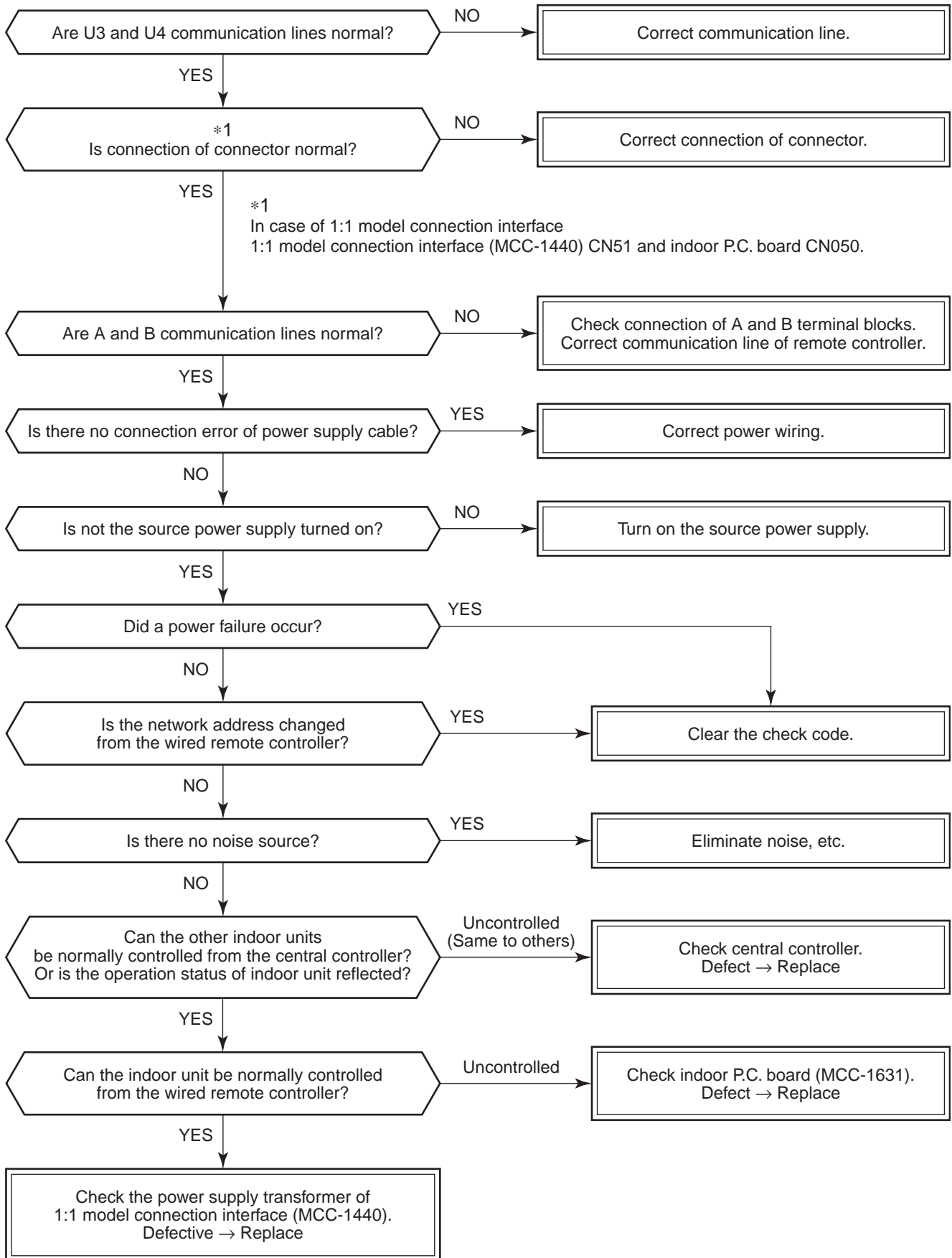

[E03 error] (Master indoor unit)

[E03 error] is detected when the indoor unit cannot receive a signal from the wired remote controller (also central controller).

Check A and B remote controllers and communication lines of the central control system U3 and U4.

As communication is impossible, this check code [E03] is not displayed on the wired remote controller and the central controller.

[E01] is displayed on the wired remote controller and [C06 error] is displayed on the central controller.

If these check codes generate during operation, the air conditioner stops.

[F29 error]

This check code indicates a detection error of IC503 non-volatile memory (EEPROM) on the indoor unit P.C. board, which generated during operation of the air conditioner. Replace the service P.C. board.

* When EEPROM was not inserted when power supply turned on or when the EEPROM data read/write operation is impossible at all, the automatic address mode is repeated. In this time, [97 error] is displayed on the central controller.

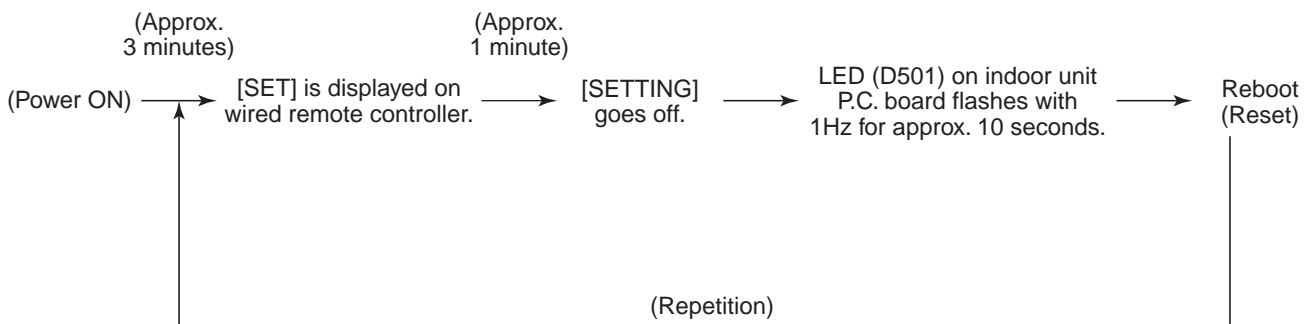

[P31 error] (Follower indoor unit)

When the master unit of a group operation detected [E03], [L03], [L07] or [L08] error, the follower unit of the group operation detects [P31 error] and then the unit stops.

There is no display of the check code or alarm history of the wired remote controller. (In this model, the mode enters in automatic address set mode when the header unit detected [L03], [L07] or [L08] error.)

Temperature – Resistance value characteristic table

TA, TC, TCJ, TE, TS, TO sensor

Representative value

Temperature (°C)	Resistance value (kΩ)		
	(Minimum value)	(Standard value)	(Maximum value)
0	32.33	33.80	35.30
10	19.63	20.35	21.09
20	12.23	12.59	12.95
25	9.75	10.00	10.25
30	7.764	7.990	8.218
40	5.013	5.192	5.375
50	3.312	3.451	3.594
60	2.236	2.343	2.454
70	1.540	1.623	1.709
80	1.082	1.146	1.213
90	0.7740	0.8237	0.8761
100	0.5634	0.6023	0.6434

TD, TL sensor

Representative value

Temperature (°C)	Resistance value (kΩ)		
	(Minimum value)	(Standard value)	(Maximum value)
0	150.5	161.3	172.7
10	92.76	99.05	105.6
20	58.61	62.36	66.26
25	47.01	49.93	52.97
30	37.93	40.22	42.59
40	25.12	26.55	28.03
50	17.00	17.92	18.86
60	11.74	12.34	12.95
70	8.269	8.668	9.074
80	5.925	6.195	6.470
90	4.321	4.507	4.696
100	3.205	3.336	3.468

TA, TC, TCJ, TE, TS, TO sensor

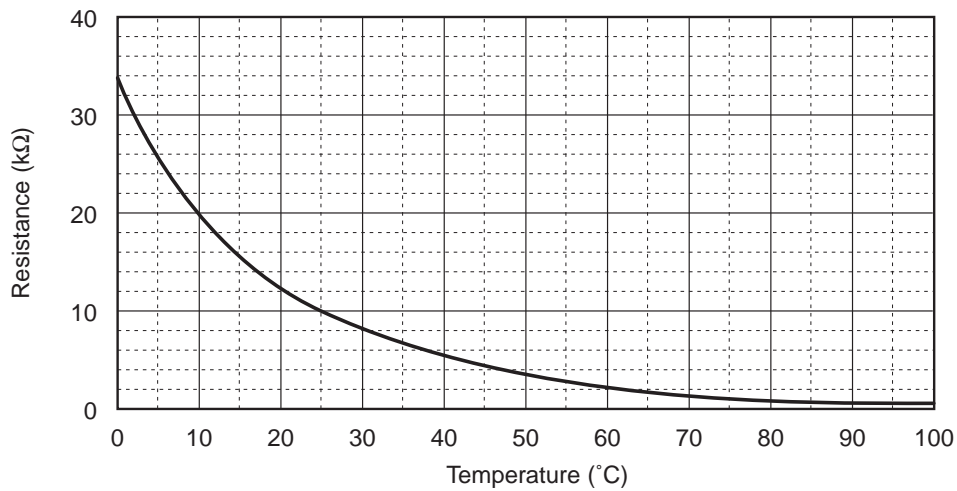

TD, TL sensor

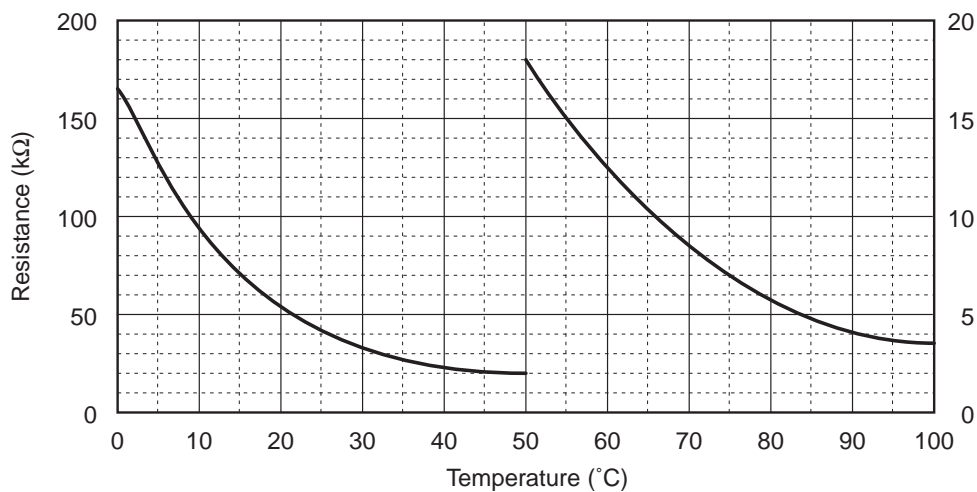

Winding Resistance of Fan Motor

Part name	Checking procedure													
Concealed Duct type Fan motor ICF-340W250-1	<p data-bbox="411 293 1123 320">Measure the resistance value of each winding by using the tester.</p> <p data-bbox="416 371 770 398">Fan motor inside wiring diagram</p> <div data-bbox="416 421 766 651"> <p data-bbox="416 501 469 651"> <table border="1"> <tr><td>1</td></tr> <tr><td>2</td></tr> <tr><td>3</td></tr> <tr><td>4</td></tr> <tr><td>5</td></tr> </table> </p> </div> <p data-bbox="884 371 1062 398">ICF-340W250-1</p> <table border="1" data-bbox="874 405 1406 607"> <thead> <tr> <th data-bbox="874 405 1137 461">Position</th> <th data-bbox="1142 405 1406 461">Resistance value</th> </tr> </thead> <tbody> <tr> <td data-bbox="874 468 1137 512">Black – Red</td> <td data-bbox="1142 468 1406 512">12.4 ± 1.2</td> </tr> <tr> <td data-bbox="874 519 1137 564">Black – White</td> <td data-bbox="1142 519 1406 564">12.4 ± 1.2</td> </tr> <tr> <td data-bbox="874 571 1137 616">Red – White</td> <td data-bbox="1142 571 1406 616">12.4 ± 1.2</td> </tr> </tbody> </table> <p data-bbox="1286 622 1417 649" style="text-align: right;">Under 20°C</p>	1	2	3	4	5	Position	Resistance value	Black – Red	12.4 ± 1.2	Black – White	12.4 ± 1.2	Red – White	12.4 ± 1.2
1														
2														
3														
4														
5														
Position	Resistance value													
Black – Red	12.4 ± 1.2													
Black – White	12.4 ± 1.2													
Red – White	12.4 ± 1.2													

7. REPLACEMENT OF SERVICE P.C. BOARD

Indoort Unit

⚠ CAUTION

<Model name: RAV-GM***BTP-E(TR)>

For the above models, set the CODE No. “*LE*” and the setting data “0000” (initial) to “0001”.

<Note: when replacing the P.C. board for indoor unit servicing>

The nonvolatile memory (hereafter called EEPROM, IC503) on the indoor unit P.C. board before replacement includes the model specific type information and capacity codes as the factory-set value and the important setting data which have been automatically or manually set when the indoor unit is installed, such as system/indoor/group addresses, external static pressure select setting, etc.

When replacing the P.C. board for indoor unit servicing, follow the procedures below.

After replacement completes, confirm whether the settings are correct by checking the indoor unit No., Group header unit/follower unit settings and perform the cooling cycle confirmation through the trial operation.

<Replacement procedures>

CASE 1

Before replacement, the indoor unit can be turned on and the setting data can be read out by wired remote control operation.

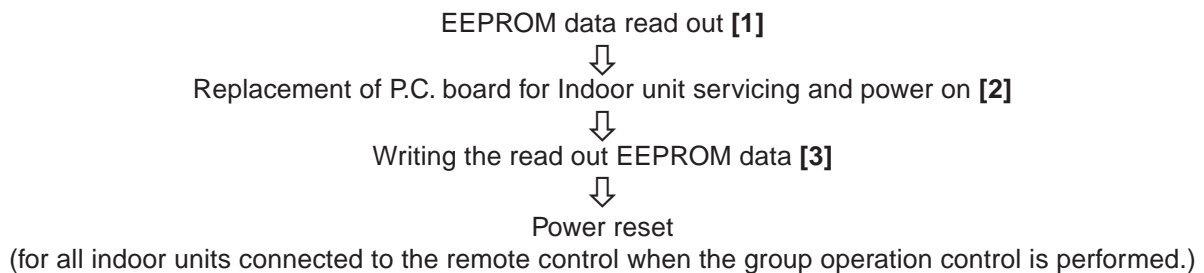





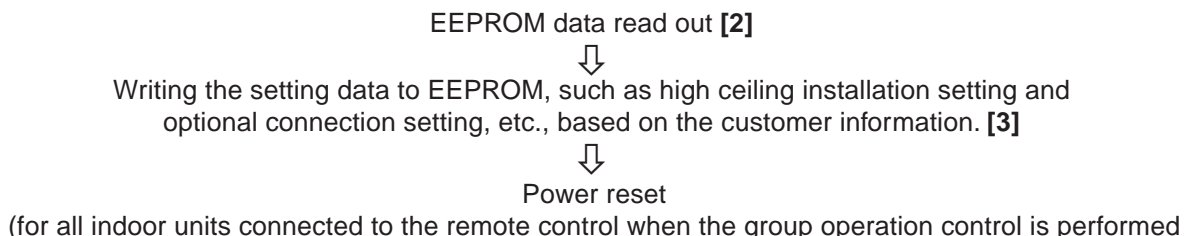



CASE 2

The EEPROM before replacement is defective and the setting data cannot be read out.



[1] Setting data read out from EEPROM

The setting data modified on the site, other than factory-set value, stored in the EEPROM shall be read out.



- Step 1** Push ,  and  button on the remote controller simultaneously for more than 4 seconds.
* When the group operation control is performed, the unit No. displayed for the first time is the header unit No. At this time, the CODE No. (DN) shows " **U**". Also, the fan of the indoor unit selected starts its operation and the swing operation also starts if it has the louvers.
- Step 2** Every time when the  button is pushed, the indoor unit No. under the group control is displayed in order. Specify the indoor unit No. to be replaced.
- Change the CODE No. (DN) to **U** → **U** / by pushing  /  buttons for the temperature setting. (this is the setting for the filter sign lighting time.)
At this time, be sure to write down the setting data displayed.**
 - Change the CODE No. (DN) by pushing  /  buttons for the temperature setting. Similarly, be sure to write down the setting data displayed.
 - Repeat the step 2-2 to set the other settings in the same way and write down the setting data as shown in the table 1 (example).
* The CODE No. (DN) are ranged from "**U** /" to "**FF**". The CODE No. (DN) may skip.
- Step 3** After writing down all setting data, push  button to return to the normal stop status. (It takes approx. 1 min until the remote controller operation is available again.)

CODE No. required at least

DN	Contents
10	Type
11	Indoor unit capacity
12	System address
13	Indoor unit address
14	Group address
5d	External static pressure.

- The CODE No. for the Indoor unit type and Indoor unit capacity are required to set the rotation number setting of the fan.
- If the system/indoor/group addresses are different from those before replacement, the auto-address setting mode starts and the manual resetting may be required again. (when the multiple units group operation including twin system.)

[2] P.C. Board for indoor unit servicing replacement procedures

- Step 1** Replace the P.C. board to the P.C. board for indoor unit servicing.
At this time, perform the same setting of the jumper wire (J01) setting (cut), switch SW501, (short-circuit) connector CN34 as the setting of the P.C. board before replacement.
- Step 2** According to the system configuration, turn on the indoor unit following to the either methods shown below.
- a) Single operation (Indoor unit is used as standalone.)
Turn on the indoor unit.
- After completion of the auto-address setting mode (required time: approx. 5 min.), proceed to [3]. (System address = 1, Indoor unit address = 1, Group address = 0 (standalone) are automatically set.)
 - Push ,  and  buttons simultaneously for more than 4 seconds to interrupt the auto-address setting mode, and proceed to [3]. (The unit No. "**ALL**" is displayed.)
- b) Group operation (including twin system)
Turn on the indoor unit(s) with its P.C. board replaced to the P.C. board for indoor unit servicing, according to either methods 1 or 2 shown below.
- Turn on only the indoor unit with its P.C. board replaced. (Be sure to confirm the remote controller is surely connected. If not, the operation [3] cannot be performed.)
Perform either methods 1 or 2 described in item a) above.
 - Turn on the multiple indoor units including the indoor unit with its P.C. board replaced.
 - Twin 1 system only
 - All group connections

After completion of the auto-address setting mode (required time: approx. 5 min.), proceed to [3].

- * The header unit of the group may be changed by performing the auto-address setting. Also, the system address/Indoor unit address of the indoor unit with its P.C. board replaced may be assigned to the addresses (not used) other than those of the indoor units without its P.C. board replaced. It is recommended to keep the information in advance, which cooling system the indoor unit belongs to or whether the indoor unit works as the header unit or the follower unit in the group control operation.

[3] Writing the setting data to EEPROM

The settings stored in the EEPROM of the P.C. board for indoor unit servicing are the factory-set values.

- Step 1** Push **SET**, **CL** and **TEST** buttons on the remote controller simultaneously for more than 4 seconds.
- * In the group control operation, the unit No. displayed for the first time is the header unit No.
- At this time, the CODE No. (DN) shows "10". Also, the fan of the indoor unit selected starts its operation and the swing operation starts if it has the louvers.
(The unit No. "ALL" is displayed if the auto-address setting mode is interrupted in [2] step 2 a)
- Step 2** Every time when **UNIT LOUVER** button is pushed, the indoor unit No. in the group control operation are displayed in order.
(The settings stored in the EEPROM of the P.C. board for indoor unit servicing are the factory-set values.)
Specify the indoor unit No. with its P.C. board replaced to the P.C. board for indoor unit servicing.
(You cannot perform this operation if "ALL" is displayed.)

Step 3 Select the CODE No. (DN) can be selected by pushing the **▼** / **▲** button for the temperature setting.

- Set the indoor unit type and capacity.
- The factory-set values shall be written to the EEPROM by changing the type and capacity.
1. Set the CODE No. (DN) to "10". (without change)
 2. Select the type by pushing **▼** / **▲** buttons for the timer setting.
(For example, Concealed Duct standard type is set to "0004". Refer to table 2)
 3. Push **SET** button.
(The operation completes if the setting data is displayed.)
 4. Change the CODE No. (DN) to "11" by pushing **▼** / **▲** buttons for the temperature setting.
 5. Select the capacity by pushing **▼** / **▲** buttons for the timer setting.
(For example, 80 Type is set to "0012". Refer to table 3)
 6. Push **SET** button.
(The setting completes if the setting data are displayed.)

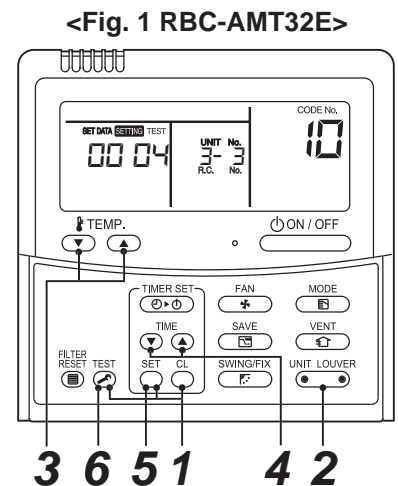

NOTE: Setting Concealed Duct standard type Indoor Unit model only

7. Using the set temperature **▼** / **▲** buttons, set "11" to the CODE No. (DN).
8. Using the timer time **▼** / **▲** buttons, set the data. (0002)

9. Push **SET** buttons. (The setting completes if the setting data are displayed.)

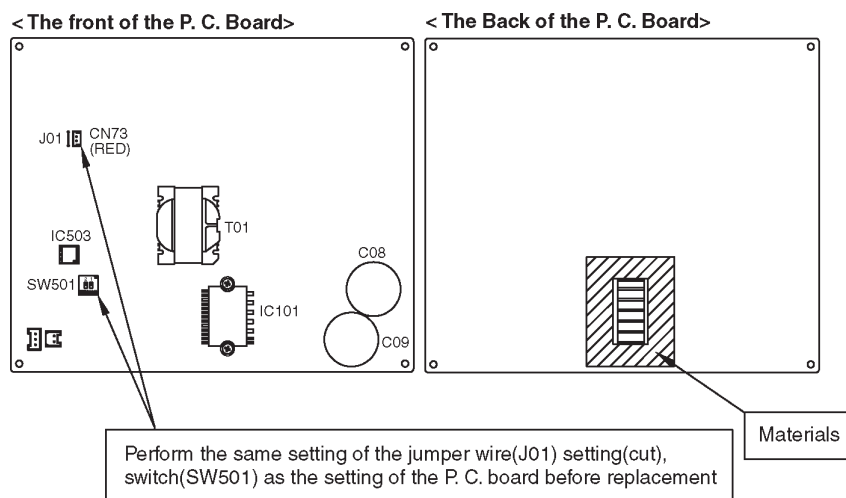

⚠ CAUTION

Don't remove the materials.
No materials. The power I.C. (IC101) may break.



<Fig. 2>

10. Push the **TEST** button to return to the normal stop status.
(It takes approx. 1 min until the remote controller operation is available again.)

- Step 4** Write the on-site setting data to the EEPROM, such as address setting, etc. Perform the steps 1 and 2 above again.
- Step 5** Change the CODE No. (DN) to “01” by pushing ▼ / ▲ buttons for the temperature setting. (this is the setting for the filter sign lighting time.)
- Step 6** Check the setting data displayed at this time with the setting data put down in [1].
1. If the setting data is different, modify the setting data by pushing ▼ / ▲ buttons for the timer setting to the data put down in [1].
The operation completes if the setting data is displayed.
 2. If the data is the same, proceed to next step.
- Step 7** Change the CODE No. (DN) by pushing ▼ / ▲ buttons for the temperature setting. As described above, check the setting data and modify to the data put down in [1].
- Step 8** Repeat the steps 6 and 7.
- Step 9** After the setting completes, push  button to return to the normal stop status. (It takes approx. 1 min until the remote control operation is available again.)
- * The CODE No. (DN) are ranged from “01” to “FF”. The CODE No. (DN) is not limited to be serial No. Even after modifying the data wrongly and pushing  button, it is possible to return to the data before modification by pushing  button if the CODE No. (DN) is not changed.

<Fig. 3 EEPROM layout diagram>

The EEPROM (IC503) is attached to the IC socket. When detaching the EEPROM, use a tweezers, etc. Be sure to attach the EEPROM by fitting its direction as shown in the figure.

* Do not bend the IC lead when replacing.

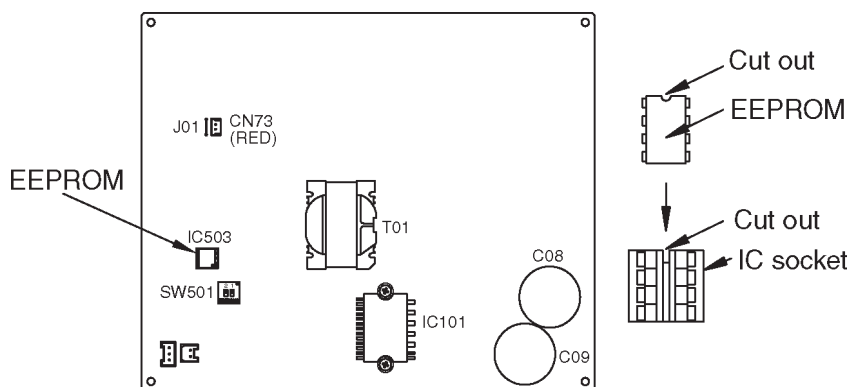

<Fig. 3>

Table 1

DN	Item	Setting data	Factory-set value
01	Filter sign lighting time		Depending on Type
02	Filter pollution level		0000: Standard
03	Central control address		0099: Not determined
06	Heating suction temperature shift		0002: +2°C
0F	Cooling only		0000: Heat pump
10	Type		Depending on model type
11	Indoor unit capacity		Depending on capacity type
12	System address		0099: Not determined
13	Indoor unit address		0099: Not determined
14	Group address		0099: Not determined
1E	Temperature range of cooling/heating automatic SW control point		0003: 3 deg (Ts ± 1.5)
28	Auto restart after power failure		0000: None
2b	Thermo output SW (T10 ③)		0000: Thermo ON
31	Ventilation fan (standalone)		0000: Not available
32	Sensor select (Selection of static pressure)		0000: Body sensor
5d	High ceiling SW (External static pressure selection)		Depending on capacity type
60	Timer setting (wired remote controller)		0000: Available
8b	Correction of high heat feeling		0000: None
C2	DEMAND setup		0075: 75%
d0	Remote controller save function		0001: Valid
d1	Frost protection function		0000: Not available
d3	Revolutions per minute of dry operation		0011: 310rpm
d6	Fan speed tab		0001: 5 tab

Table 2. Type: CODE No. 10

Setting data	Type	Type name abb.
0001* ¹	4-way Air Discharge Cassette Type	—
0004* ²	Concealed Duct standard type	RAV-GM***BTP-E(TR)

* 1 EEPROM initial value on the P. C. board for indoor unit servicing.

* 2

⚠ CAUTION

< Model Name : RAV-GM***BTP-E(TR)>

For the above models, set the CODE No. to “ $\mathcal{L}\mathcal{E}$ ” and the setting data 0000 (initial) to “0002”.

Table 3. Indoor unit capacity: CODE No. 11

Setting data	Type
0000*	Disable
0013	90

* EEPROM initial value on the P.C. board for indoor unit servicing.

Table 4. Addition setting data(CODE No.)

Model	CODE No.(DN)	Setting data
90*	54	78
	5d	00
	84	01
	85	10



Setting data for model 90 only.

8. SETUP AT LOCAL SITE AND OTHERS

8-1. Indoor Unit

8-1-1. Test Run Setup on Remote Controller

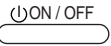
<Wired remote controller>

1. When pushing  button on the remote controller for 4 seconds or more, "TEST" is displayed on LC display.
Then push  button.
 - "TEST" is displayed on LC display during operation of Test Run.
 - During Test Run, temperature cannot be adjusted but air volume can be selected.
 - In heating and cooling operation, a command to fix the Test Run frequency is output.
 - Detection of error is performed as usual. However, do not use this function except case of Test Run because it applies load on the unit.
2. Use either heating or cooling operation mode for [TEST].
NOTE : The outdoor unit does not operate after power has been turned on or for approx. 3 minutes after operation has stopped.
3. After a Test Run has finished, push  button again and check that [TEST] on LC display has gone off.
(To prevent a continuous test run operation, 60-minutes timer release function is provided to this remote controller.)





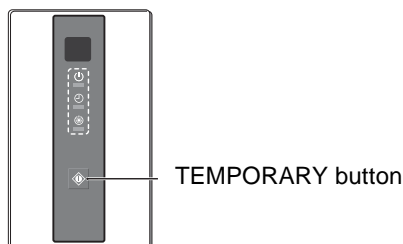





<Wiress remote controller>

- 1** When **TEMPORARY** button is pushed for 10 seconds or more, "Pi!" sound is heard and the operation changes to test run. After approx. 3 minutes, a cooling operation starts forcedly.
Check cool air starts blowing. If the operation does not start, check wiring again.
- 2** To stop a test operation, push **TEMPORARY** button once again (Approx. 1 second).
Check wiring / piping of the indoor and outdoor units in test run.



8-1-2. Forced Defrost Setup of Remote Controller (For wired remote controller only)

(Preparation in advance)

- 1** Push  +  +  buttons simultaneously for 4 seconds or more on the remote controller. (Push buttons while the air conditioner stops.)
The first displayed unit No. is the master indoor unit address in the group control.
- 2** Every pushing  button, the indoor unit No. in the group control is displayed one after the other.
Select a main indoor unit (outdoor unit is connected) which is to be defrosted.
In this time, fan and louver of the selected indoor unit operate.
- 3** Using the set temperature   buttons, specify the CODE No. (DN) 8C.
- 4** Using the timer time   buttons, set time to data 0001. (0000 at shipment)
- 5** Push  button. (OK if indication lights)
- 6** Pushing  button returns the status to the normal stop status.

(Practical operation)

- Push ON/OFF  Key.
- Select the HEAT mode.
- After while, the forced defrost signal is sent to the outdoor unit and then the outdoor unit starts defrost operation. (The forced defrost operation is performed for Max. 12 minutes.)
- After defrost operation finished, the operation returns to the heating operation.

To execute the defrost operation again, start procedure from above item 1 .

(If the forced defrost operation was executed once, setting of the above forced defrost operation is cleared.)

8-1-3. LED Display on Indoor P.C. Board

1. D501 (Red)

- Goes on at the same time when power was turned on (Main microcomputer operates and goes on.)
- Flashes with 1-second interval (every 500ms): When EEPROM is not provided or writing was an error.
- Flashes with 10-seconds interval (every 5S): When the mode is DISP

2. D403 (Red)

- Goes on when power is supplied to remote controller (Lights on the hardware)

8-1-4. Function Selection Setup

<Procedure> Perform setting while the air conditioner stops.

1 Push **TEST** + **SET** + **CL** buttons simultaneously for 4 seconds or more.

The first displayed unit No. is the master indoor unit address in the group control.
In this time, fan and louver of the selected indoor unit operate.



2 Every pushing **UNIT LOUVER** button (button at left side), the indoor unit No. in the group control is displayed one after the other. In this time, fan and louver of the selected indoor unit only operate.



3 Using the set temperature **TEMP.** buttons, specify the CODE No. (DN).



4 Using the timer time **TIME** buttons, select the set data.



5 Push **SET** button. (OK if indication lights)

- To change the selected indoor unit, proceed to Procedure **2**.
- To change item to be set up, proceed to Procedure **3**.



6 Pushing **TEST** button returns the status to the normal stop status.

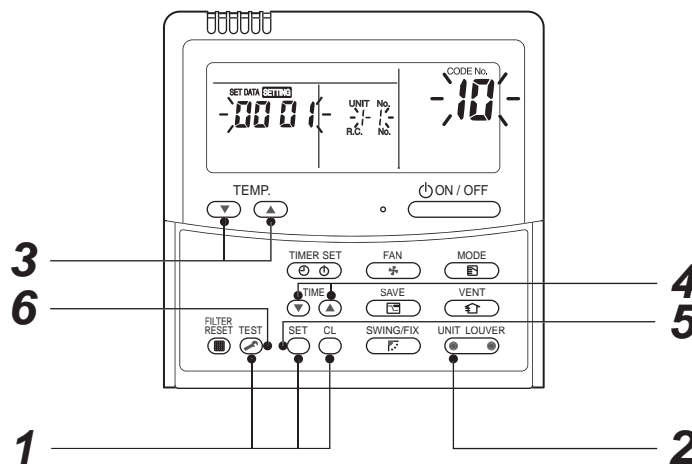

<Operation procedure>

1 → 2 → 3 → 4 → 5 → 6 END

Item No. (DN) table (Selection of function)

DN	Item	Description	At shipment																							
01	Filter sign lighting time)	0000 : None 0002 : 2500H (4-Way/Duct/Ceiling Type)	0002 : 2500H																							
02	Dirty state of filter	0000 : Standard 0001 : High degree of dirt (Half of standard time)	0000 : Standard																							
03	Central control address	0001 : No.1 unit to 0064 : No.64 unit 0099 : Unfixed	0099 : Unfixed																							
06	Heating suction temp shift	0000 : No shift 0001 : +1°C 0002 : +2°C to 0010 : -10°C (Up to recommendation + 6)	0002 : +2°C																							
0F	Cooling only	0000 : Heat pump 0001 : Cooling only (No display of [AUTO] [HEAT])	0000 : Heat pump																							
10	Type	0004 : Concealed duct type	According to model type																							
11	Indoor unit capacity	0000 : Unfixed 0013 : 90 type	According to capacity type																							
12	Line address	0001 : No.1 unit to 0030 : No.30 unit	0099 : Unfixed																							
13	Indoor unit address	0001 : No.1 unit to 0064 : No.64 unit	0099 : Unfixed																							
14	Group address	0000 : Individual 0001 : Master of group 0002 : Follower of group	0099 : Unfixed																							
19	Louver type (Air direction adjustment) * None for concealed duct	0000 : No louver 0001 : Swing only 0002 : 1-way 0003 : 2-way 0004 : 4-way	According to model type																							
1E	Temp difference of automatic cooling/heating mode selection COOL → HEAT, HEAT →COOL	0000 : 0 deg to 0010 : 10 deg (For setup temperature, reversal of COOL/HEAT by ± (Data value)/2)	0003 : 3 deg (Ts±1.5)																							
28	Auto restart after power failure	0000 : None 0001 : Auto restart	0000 : None																							
2A	Option		0002 : Default																							
2b	Thermo output selection (T10 ㉓)	0000 : Indoor thermo ON 0001 : Output of outdoor comp-ON receiving	0000: Thermo. ON																							
2E	Option		0000 : Default																							
30	Option		0000 : Default																							
31	Option		0000 : Default																							
32	Sensor selection	0000 : Body TA sensor 0001 : Remote controller sensor	0000 : Body sensor																							
33	Temperature indication	0000 : °C (celsius) 0001 : °F (Fahrenheit)	0000 : °C																							
40	Option		0003 : Default																							
5d	High ceiling selection (External static pressure selection)	<p><Concealed Duct type></p> <table border="1"> <thead> <tr> <th>Set data</th> <th>0000</th> <th>0001</th> <th>0002</th> <th>0003</th> <th>0004</th> <th>0005</th> <th>0006</th> </tr> </thead> <tbody> <tr> <td rowspan="2">External static pressure</td> <td>40 Pa</td> <td>30 Pa</td> <td>65 Pa</td> <td>50 Pa</td> <td>80 Pa</td> <td>100 Pa</td> <td>120 Pa</td> </tr> <tr> <td>(Factory default)</td> <td>—</td> <td>—</td> <td>—</td> <td>—</td> <td>—</td> <td>—</td> </tr> </tbody> </table> <p>The list above is when SW501-1 and SW501-2 is OFF.</p>	Set data	0000	0001	0002	0003	0004	0005	0006	External static pressure	40 Pa	30 Pa	65 Pa	50 Pa	80 Pa	100 Pa	120 Pa	(Factory default)	—	—	—	—	—	—	According to capacity type
Set data	0000	0001	0002	0003	0004	0005	0006																			
External static pressure	40 Pa	30 Pa	65 Pa	50 Pa	80 Pa	100 Pa	120 Pa																			
	(Factory default)	—	—	—	—	—	—																			

DN	Item	Description	At shipment
60	Timer set (Wired remote controller)	0000 : Available (Operable) 0001 : Unavailable (Operation prohibited)	0000 : Available
8b	Correction of high heat feeling	0000 : None 0001 : Correction	0000 : None
42	Self clean time	0000: None 0001: 0.5h to 0.012: 6.0h The case that compressor-ON time is 10 to 60 minutes is set up. When ON time is over 60 minutes, the operating time becomes two times of it.	0000: None
C2	Power saving (Current demand × % to outdoor unit)	0050: 50% to 0100: 100%	0075: 75%
CC	Forced stop setting for self clean	0000: None 0001: Set	0000: None
CD	Self clean stop function when [START/STOP] operation was prohibited	When stopping the air conditioner (including "Fire alarm" of the control system, etc.) while [START/STOP] operation is prohibited (Central 1, 2) from the central controller side, 0000: Valid (No self cleaning) 0001: Invalid (Self cleaning)	0000: Valid
D0	Existence of Power save operation	0000: Invalid (Unavailable) 0001: Valid (Available)	0001: Valid (Available)
D1	Existence of 8°C heating operation function	0000: Invalid (Unavailable)} 0001: Valid (Available)	0000: Invalid (Unavailable)
D3	Revolution count of self clean	0000: Invalid (Self cleaning is not performed.) 0011: Valid (Self cleaning is performed at 310 rpm.)	0011: 310 rpm
D4	Display/ No display of [SELF CLEANING] during self clean operation	0000: Displayed, 0001: Not displayed	0000: Displayed
D6	Fan speed tab	0000: 3 tab 0001: 5 tab	0001: 5 tab

8-1-4. Cabling and Setting of Remote Controller Control

2-remote controller control (Controlled by 2 remote controllers)

This control is to operate 1 or multiple indoor units are controlled by 2 remote controllers.
(Max. 2 remote controllers are connectable.)

• When connected 2 remote controllers operate an indoor unit

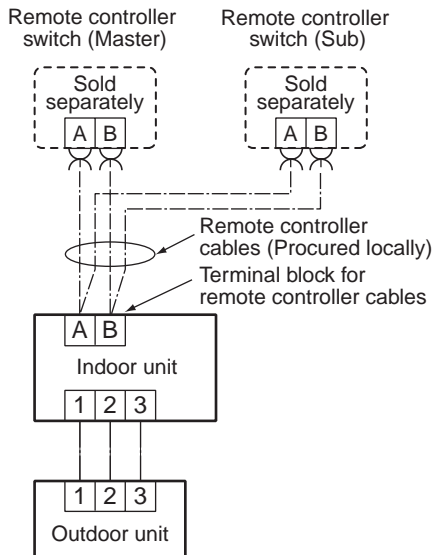

• When connected 2 remote controllers operate the twin

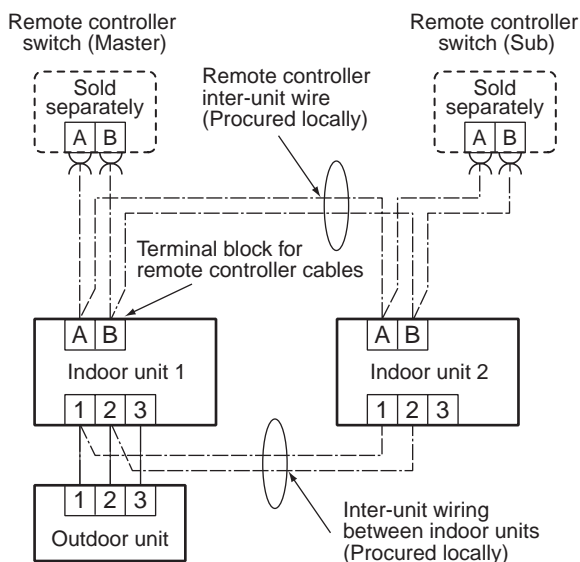

(Setup method)

One or multiple indoor units are controlled by two remote controllers.
(Max. 2 remote controllers are connectable.)

<Wired remote controller>

How to set wired remote controller as sub remote controller

Change DIP switch inside of the rear side of the remote controller switch from remote controller master to sub. (In case of RBC-AMT32E)

Remote controller (Inside of the rear side)

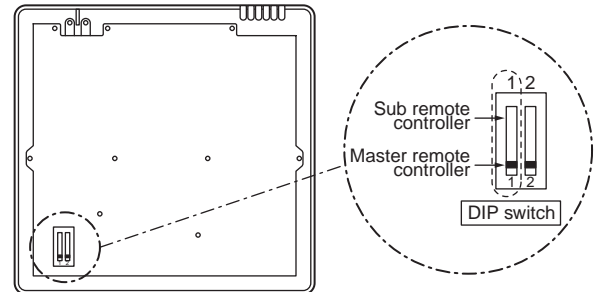

<Wireless remote controller>

Remote controller address (A-B selection) setting

- When two or more signal receiving units are installed in a room, a unique address can be set for each signal receiving unit to prevent interference.
- Address (A-B selection) must be changed on both signal receiving unit and wireless remote controller.
- For the details of address change (A-B selection) on wireless remote controller, refer to the owner's manual.

Turn off the indoor unit power supply. Turn on the bit 3 of DIP switch SW30 on the signal receiving unit P.C. board.

The setting change is shown below.

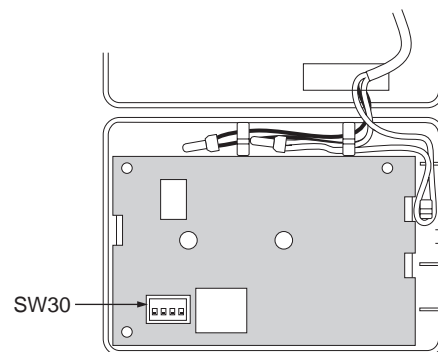

DIP-Switch [SW30]

4	ON=Follower	OFF=Header
3	ON=B	OFF=A
2	Not used	
1	Not used	



Wireless remote controller (A-B selection)

Using 2 wireless remote controllers for the respective air conditioners, when the 2 air conditioners are closely installed.

Wireless remote controller B setup

1. Start the air conditioner.
2. Point the wireless remote controller at the indoor unit.
3. Push and hold **CHK** ● button on the wireless remote controller by the tip of the pencil.
"00" will be shown on the display.
4. Push **MODE** ● button during **CHK** ● pushing .
"B" will be shown on the display and "00" will be disappear and the air conditioner will turn OFF.
The wireless remote controller B is memorized.

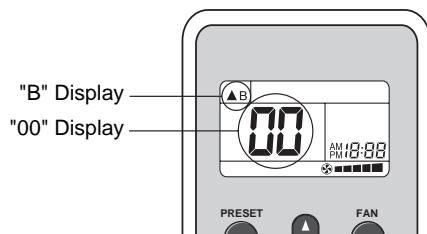

NOTE

- Repeat above step to reset wireless remote controller to be A.
- The wireless remote controllers do not display "A".
- The factory default of the wireless remote controllers is "A".
- A-B selection can be set with signal receiving unit.
For the further details, refer to the installation manual.

8-1-5. Monitor Function of Remote Controller

■ Calling of sensor temperature display

<Contents>

Each sensor temperature of the remote controller, indoor unit, and outdoor unit can become known by calling the service monitor mode from the remote controller.

<Procedure>

- 1 Push **TEST** + **CL** buttons simultaneously for 4 seconds to call the service monitor mode.

The service monitor goes on, the master indoor unit No. is displayed, at first and then the temperature of **CODE No. 00** is displayed.

- 2 Push temperature set **TEMP.** buttons and then change the **CODE No.** of data to be monitored.

The item code list is shown below:

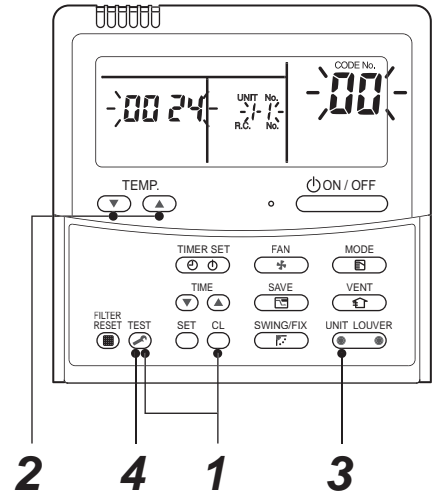

<Operation procedure>

1 → 2 → 3 → 4

Returned to usual display

	CODE No.	Data name	Unit
Indoor unit data	01	Room temperature (Remote controller)	°C
	02	Indoor suction temperature (TA)	°C
	03	Indoor heat exchanger (Coil) temperature (TCJ)	°C
	04	Indoor heat exchanger (Coil) temperature (TC)	°C
	07	Indoor fan revolution frequency	rpm
	F2	Indoor fan calculated operation time	×100h
	F3	Filter sign time	×1h

	CODE No.	Data name	Unit
Outdoor unit data	60	Outdoor heat exchanger (Coil) temperature (TE)	°C
	61	Outside temperature (TO)	°C
	62	Compressor discharge temperature (TD)	°C
	63	Compressor suction temperature (TS)	°C
	65	Heat sink temperature (THS)	°C
	6A	Operation current (× 1/10)	A
	6D	Outdoor heat exchanger (Coil) temperature (TL)	°C
	70	Compressor operation frequency	rps
	72	Outdoor fan revolution frequency (Lower)	rpm
	73	Outdoor fan revolution frequency (Upper)	rpm
	F1	Compressor calculated operation time	×100h



- 3 Push **UNIT LOUVER** button to select the indoor unit to be monitored. Each data of the indoor unit and its outdoor units can be monitored.



- 4 Pushing **TEST** button returns the status to the usual display.

- The data value of each item is not the real time, but value delayed by a few seconds to ten-odd seconds.
- If the combined outdoor unit is one before 2 or 3 series, the outdoor unit data [6D], [70], [72] and [73] are not displayed.

■ Calling of error history

<Contents>

The error contents in the past can be called.

<Procedure>

- 1 Push **CL** + **TEST** buttons simultaneously for 4 seconds or more to call the service check mode.

Service Check goes on, the **CODE No. 01** is displayed, and then the content of the latest alarm is displayed.
The number and error contents of the indoor unit in which an error occurred are displayed.

- 2 In order to monitor another error history, push the set temperature **▼** / **▲** buttons to change the error history No. (CODE No.)

CODE No. **01** (Latest) → CODE No. **04** (Old)

NOTE : 4 error histories are stored in memory.

- 3 Pushing **TEST** button returns the display to usual display.

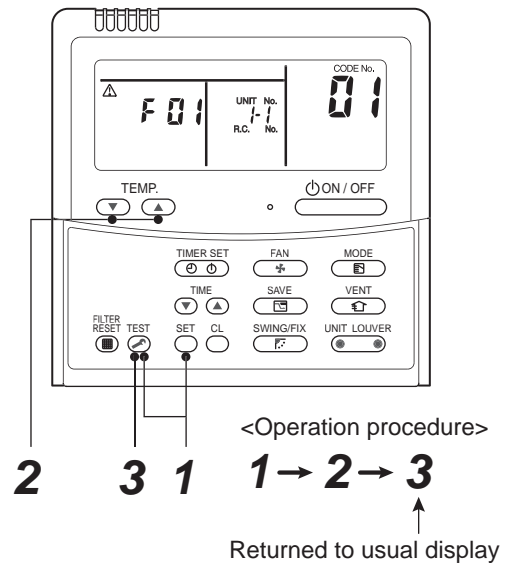

REQUIREMENT

Do not push **CL** button, otherwise all the error histories of the indoor unit are deleted. If the error histories are deleted by pushing CL button, turn off the power supply once and then turn on the power supply again.
When the error which is same as one occurred at the last before deletion continuously occurs again, it may not be stored in memory.

(Group control operation)

In a group control, operation of maximum 8 indoor units can be controlled by a remote controller.

Twin, triple or double twin of an outdoor unit is one of the group controls.

The indoor unit connected with outdoor unit (Individual/Header of twin) controls room temperature according to setting on the remote controller.

<System example>

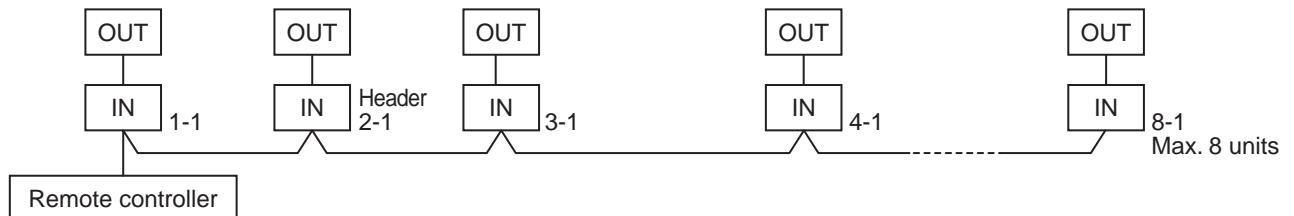

1. Display range on remote controller

The setup range (Operation mode/Air volume select/Setup temp) of the indoor unit which was set to the header unit is reflected on the remote controller.

- 1) Concealed duct high static pressure type (RAV-RMXXX) is not set up on the header unit.

- If the Concealed duct high static pressure type is the header unit:
Operation mode: [Cooling/Heating AUTO] [HEAT] [COOL] [FAN] and no [DRY]
Air volume select: [HIGH]
- When the operation mode is [DRY], [FAN] stops in concealed duct high static pressure models.

2. Address setup

If there is no serial communication between indoor and outdoor when the power is turned on, it is judged as follower unit of the twin. (Every time when the power is turned on)

- The judgment of header (wired) / follower (simple) of twin is carried out every time. It is not stored in non-volatile memory.

Turn on power of the indoor unit to be controlled in a group within 3 minutes after setting of automatic address.

If power of the indoor unit is not turned on within 3 minutes (completion of automatic address setting), the system is rebooted and the automatic address setting will be judged again.

- 1) Connect indoor/outdoor connecting wire surely.
- 2) Check line address/indoor address/group address of the unit one by one.
Especially in case of twin, triple, double twin, check whether they are identical system address or not.
- 3) The unit No. (line/indoor gout address) which have been set once keep the present status as a rule if the unit No. is not duplicated with one of another unit.

■ Indoor unit power-ON sequence

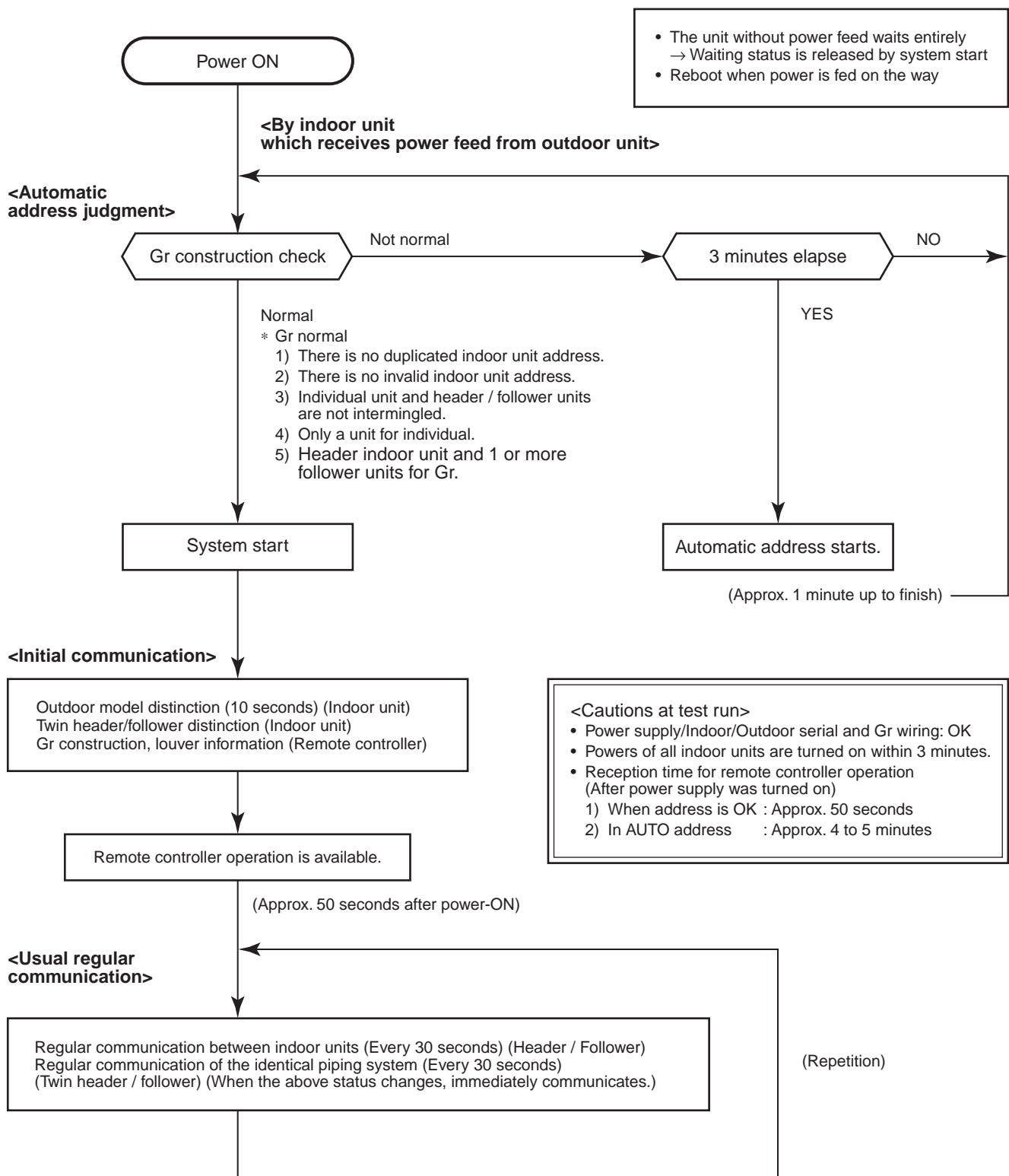

- In a group operation, if the indoor unit which was fed power after judgment of automatic address cannot receive regular communication from the header unit and regular communication on identical pipe within 120 seconds after power was turned on, it reboots (system reset).
→ The operation starts from judgment of automatic address (Gr construction check) again.
(If the address of the header unit was determined in the previous time, the power fed to the header unit and reboot works, the header unit may change though the indoor unit line address is not changed.)

8-2. Setup at Local Site / Others

Model name: TCB-PCNT30TLE2

8-2-1. 1:1 Model Connection Interface (TCC-LINK adapter)

1. Function

This model is an optional P.C. board to connect the indoor unit to 1:1 model connection interface.

2. Microprocessor block diagram

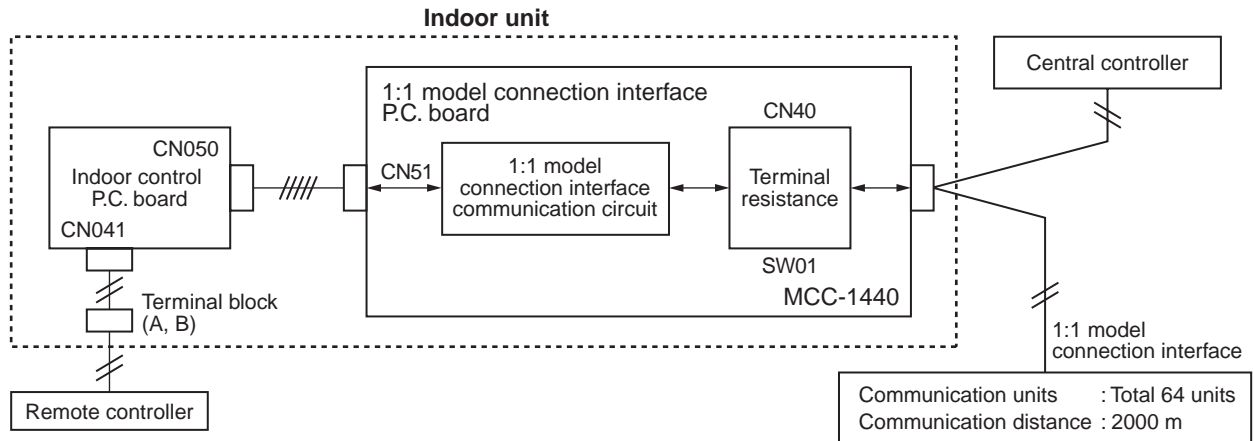

3. 1:1 model connection interface wiring connection

CAUTION

- 1) When controlling DI, SDI series collectively, 1:1 model connection interface (This option) is required.
- 2) In case of group operation, twin-triple operation, the 1:1 model connection interface is necessary to be connected to the header unit.
- 3) Connect the central control devices to the central control system wiring.
- 4) When controlling DI, SDI series only, turn on only Bit 1 of SW01 of the least line of the system address No. (OFF when shipped from the factory)

*** In case of DI, SDI series, the address is necessary to be set up again from the wired remote controller after automatic addressing.**

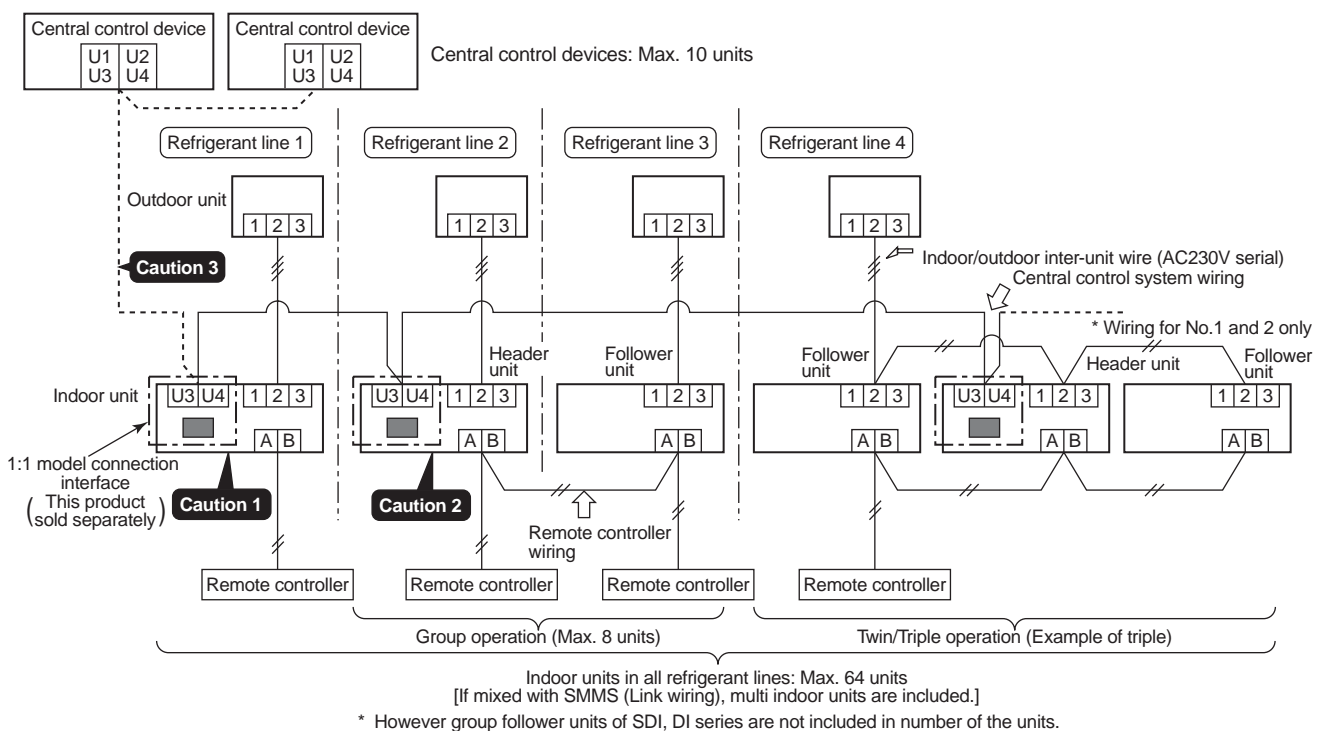

4. Wiring Specifications

- Use 2-core with no polar wire.
- Match the length of wire to wire length of the central control system. If mixed in the SMMS system, the wire length is lengthened with all indoor/outdoor inter-unit wire length at side.
- To prevent noise trouble, use 2-core shield wire.
- Connect the shield wire by closed-end connection and apply open process (insulating process) to the last terminal. Ground the earth wire to 1 point at indoor unit side. (In case of central controlling of digital inverter (DI, SDI) unit setup)

No. of wires	Size
2	Up to 1000m: twisted wire 1.25mm ² Up to 2000m: twisted wire 2.0mm ²

⚠ CAUTION

- 1) Closed-end connection of shield wire (Connect all the connecting parts of each indoor unit)
- 2) Apply open process to the last terminal (insulating process).
- 3) Ground earth wire to 1 point at indoor unit side.

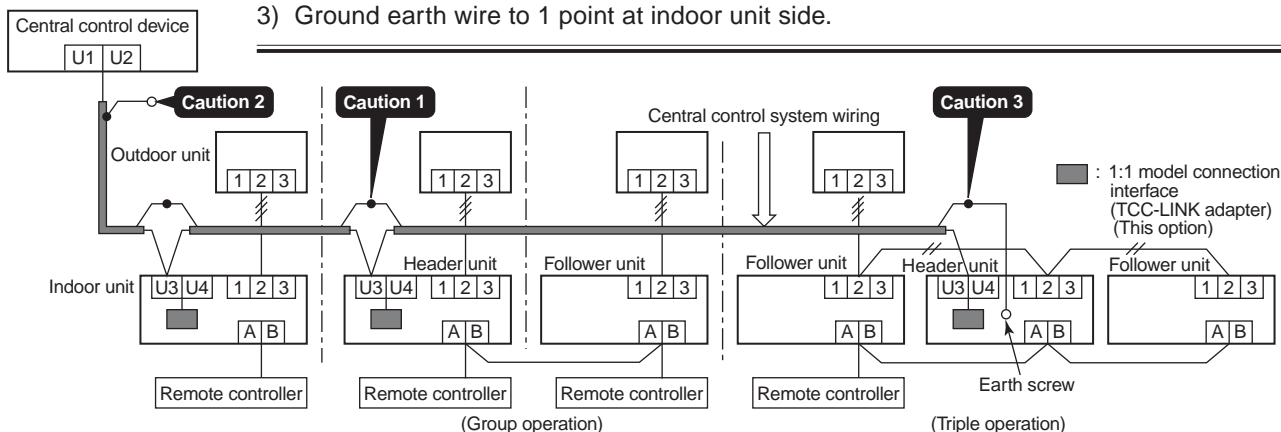

5. P.C. Board Switch (SW01) Setup

When performing collective control by customized setup only, the setup of terminator is necessary.

- Using SW01, set up the terminator.
- Set up the terminator to only the interface connected to the indoor unit of least line address No.

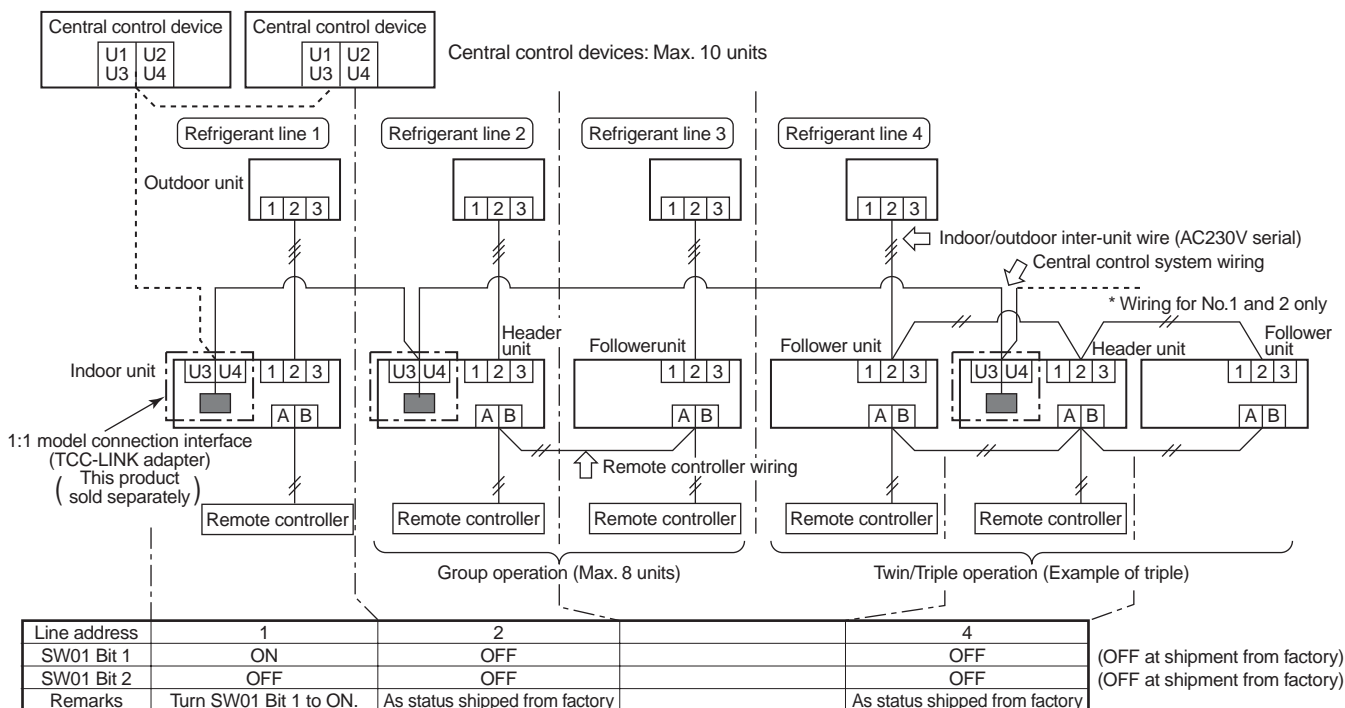

(Reference) Setup contents of switch

SW01		Terminator	Remarks
Bit 1	Bit 1		
OFF	OFF	None	Mixed with SMMS (Link wiring) at shipment from factory
ON	OFF	100Ω	Central control by digital inverter only
OFF	ON	75Ω	Spare
ON	ON	43Ω	Spare

6. External view of P.C. board assembly

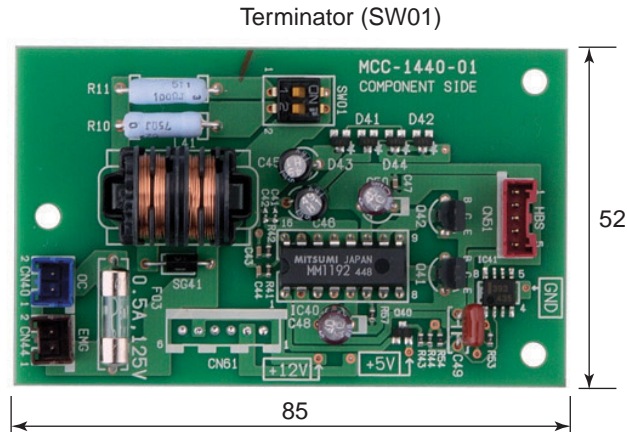

7. Address setup

In addition to set up the central control address, it is necessary to change the indoor unit number. (Line/Indoor/Group address). For details, refer to 1:1 model connection interface Installation Manual.

8-3. How to Set up Central Control Address Number

When connecting the indoor unit to the central control remote controller using 1:1 model connection interface, it is necessary to set up the central control address number.

- The central control address number is displayed as the line No. of the central control remote controller.

How to set up from indoor unit side by remote controller

<Procedure> Perform setup while the unit stops.

- 1 Push **TEST** + **VENT** buttons for 4 seconds or more.

When group control is executed, first the unit No. **ALL** is displayed and all the indoor units in the group control are selected. In this time, fans of all the selected indoor units are turned on. (Fig. 1) (Keep **ALL** displayed status without pushing **UNIT LOUVER** button.)

In case of individual remote controller which is not group-controlled, Line address and Indoor unit address are displayed.

- 2 Using temperature setup **TEMP.** buttons, specify CODE No. **03**.

- 3 Using timer time **TIME** buttons, select the SET DATA. The setup data is shown in the table below (Table 1).

- 4 Push **SET** button. (OK if display goes on.)
 - To change the item to be set up, return to Procedure 2.

- 5 Push **TEST** button. The status returns to usual stop status.

(Table 1)

SET DATA	Central control address No.
0001	1
0002	2
0003	3
⋮	⋮
0064	64
0099	Unset (Setup at shipment from factory)

(Fig.1)

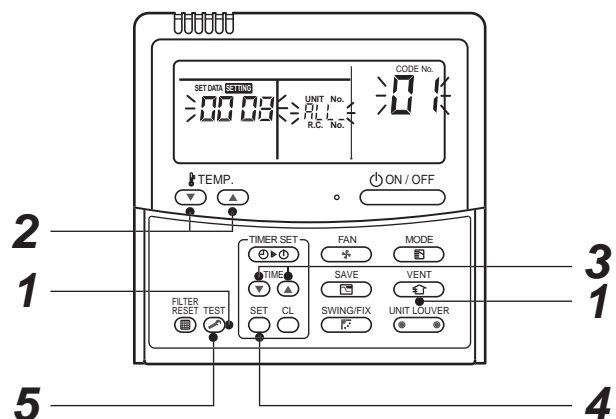

How to confirm the central control address (New function for AMT32E remote controller)

<Procedure> It can be confirmed even during operation or stopping.

1 Push  button for 4 seconds or more.



2 In the frame at left side of the remote controller screen, the lighting set contents are displayed.
During unset time, **0099** (At shipment from factory) is displayed.



3 After lighting display for 3 seconds, the display automatically disappears.

If any button is pushed during display, immediately the display disappears and then the pushed button is displayed.

9. ADDRESS SETUP

9-1. Address Setup

<Address setup procedure>

When an outdoor unit and an indoor unit are connected and they are twin-triple, or when an outdoor unit is connected to each indoor unit respectively in the group operation even if multiple refrigerant lines are provided, the automatic address setup completes with power-ON of the outdoor unit. The operation of the remote controller is not accepted while automatic address works. (Approx. 4 to 5 minutes)

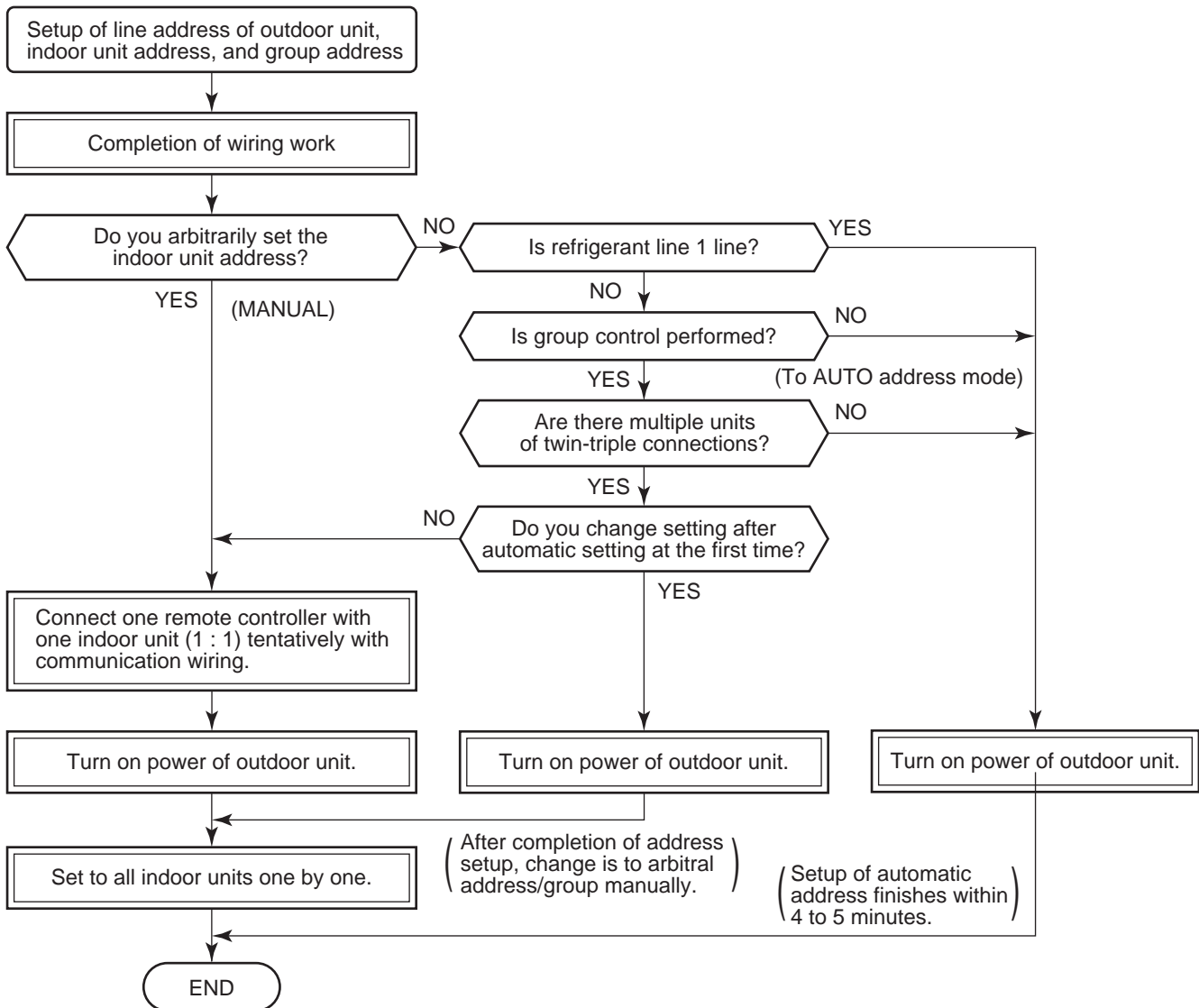

- When the following addresses are not stored in the neutral memory (IC10) on the indoor P.C. board, a test run operation cannot be performed. (Unfixed data at shipment from factory)

	CODE No.	Data at shipment	SET DATA range
Line address	12	0099	0001 (No. 1 unit) to 0030 (No. 30 unit)
Indoor unit address	13	0099	0001 (No. 1 unit) to 0064 (No. 64 unit) Max. value of indoor units in the identical refrigerant line (Double twin = 4)
Group address	14	0099	0000 : Individual (Indoor units which are not controlled in a group) 0001 : Header unit (1 indoor unit in group control) 0002 : Follower unit (Indoor units other than header unit in group control)

9-2. Address Setup & Group Control

<Terminology>

- Indoor unit No. : $N - n =$ Outdoor unit line address N (Max. 30) – Indoor unit address n (Max. 64)
- Group address : 0 = Single (Not group control)
 1 = Header unit in group control
 2 = Follower unit in group control
- Header unit (= 1) : The representative of multiple indoor units in group operation sends/receives signals to/from the remote controllers and follower indoor units.
 (*It has no relation with an indoor unit which communicates serially with the outdoor units.)
 The operation mode and setup temperature range are displayed on the remote controller LCD. (Except air direction adjustment of louver)
- Follower unit (= 2) : Indoor units other than header unit in group operation
 Basically, follower units do not send/receive signals to/from the remote controllers.
 (Except errors and response to demand of service data)
- Master unit (Representative unit) (Header Twin) : This unit communicates with the indoor unit (sub) which serial-communicates with the outdoor units and sends/receives signal (Command from compressor) to/from the outdoor units as the representative of the cycle control in the indoor units of the identical line address within the minimum unit which configures one of the refrigerating cycles of Twin, Triple, Double twin.
- Sub unit (Subordinate unit) (Follower Twin) : Indoor units excluding the header unit in Twin, Triple, Double twin
 This unit communicates with (Master) indoor unit in the identical line address and performs control synchronized with (Master) indoor unit.
 This unit does not perform the signal send/receive operation with the outdoor units.:
 N judgment for serial signal error.

9-2-1. System configuration

1. Single

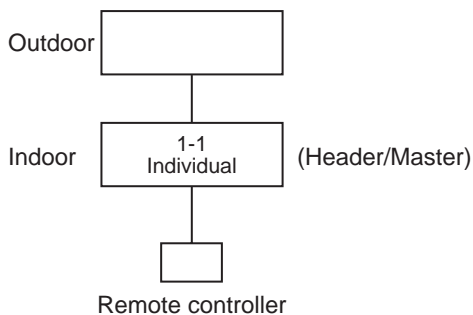

2. Single group operation

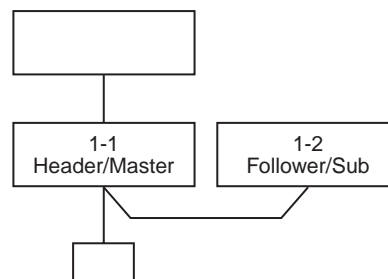

3. Triple

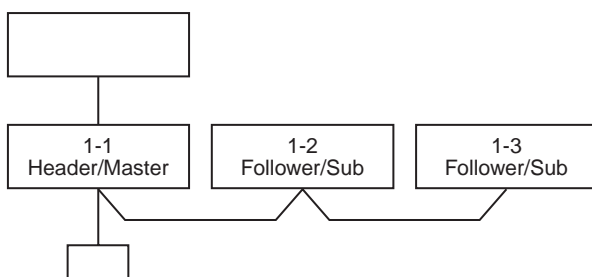

4. Single group operation

- Each indoor unit controls the outdoor unit individually.

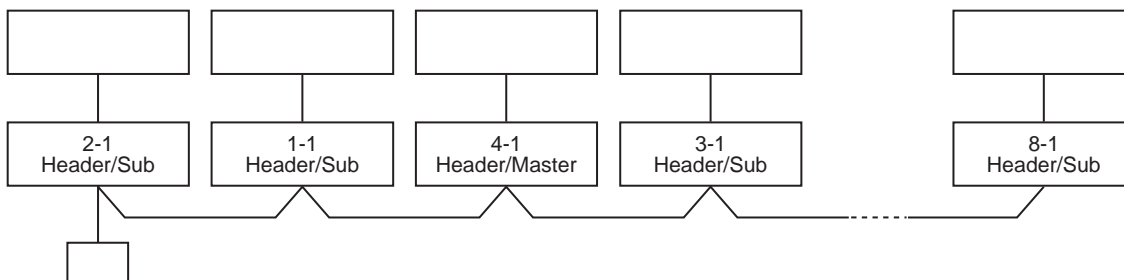

5. Multiple groups operation (Manual address setting)

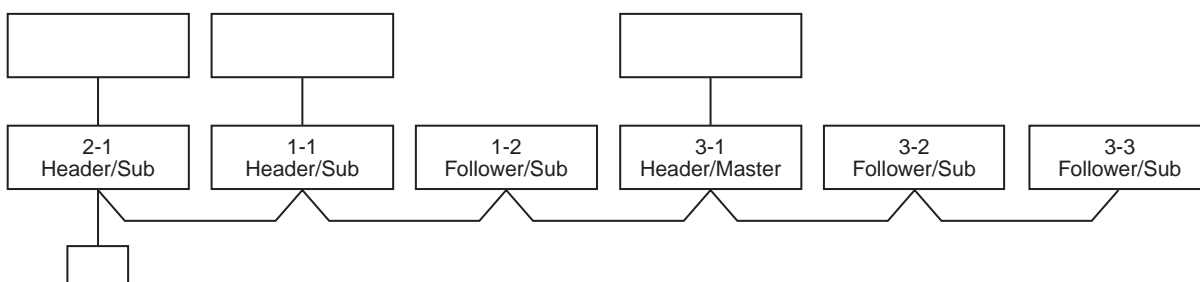

- Master unit: The master unit receives the indoor unit data (thermo status) of the sub (Without identical line address & indoor/outdoor serial) and then finally controls the outdoor compressor matching with its own thermo status.
The master unit sends this command information to the sub unit.
- Sub unit: The sub unit receives the indoor unit data from the master (With identical line address & indoor/outdoor serial) and then performs the thermo operation synchronized with the master unit.
The sub unit sends own thermo ON/OFF demand to the master unit.

(Example)

No. 1-1 master unit sends/receives signal to/from No. 1-2 and No. 1-3 sub units.
(It is not influenced by the line 2 or 3 address indoor unit.)

9-2-2. Automatic Address Example from Unset Address (No miswiring)

1. Standard (One outdoor unit)

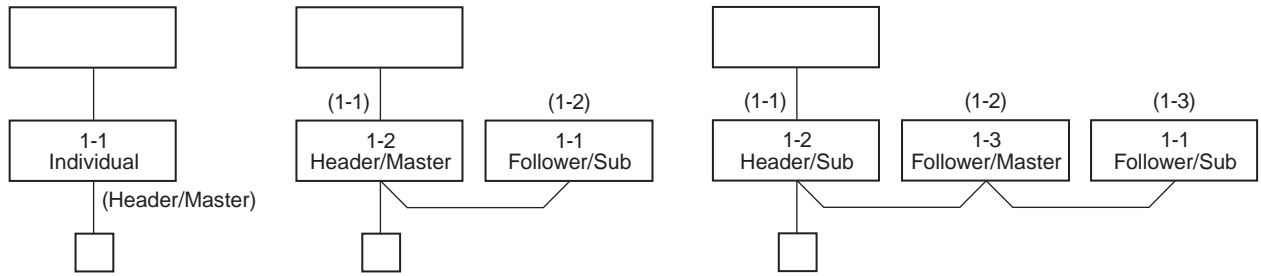

Only turning on source power supply (Automatic completion)

2. Group operation

(Multiple outdoor units = Multiple indoor units with serial communication only, without twin)

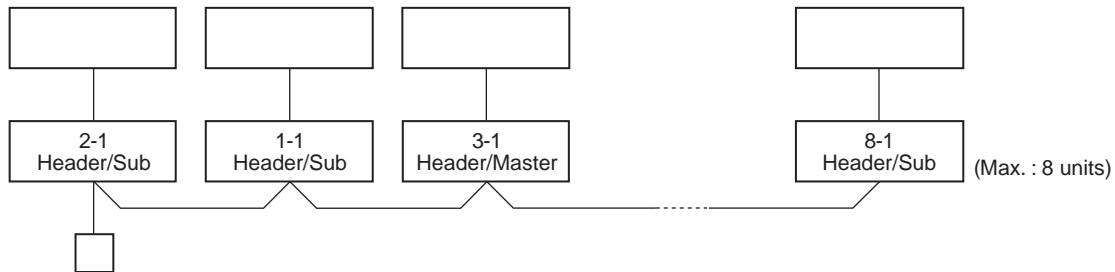

Only turning on source power supply (Automatic completion)

3. Multiple groups operation

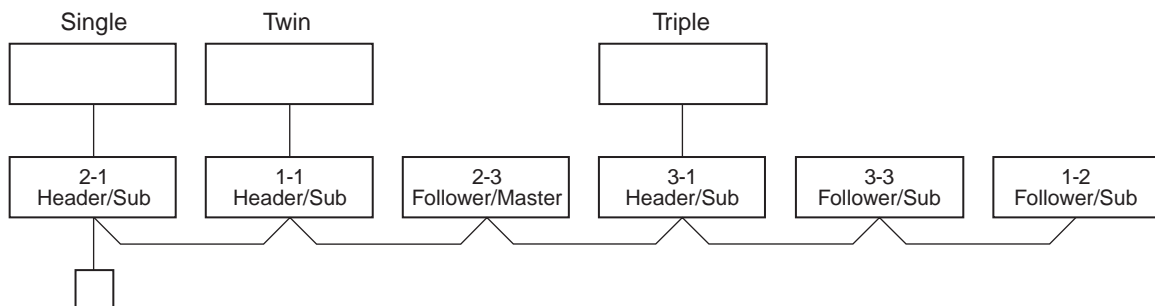

Change is necessary
Manually change addresses of the multiple sub units
simultaneously from the remote controller.

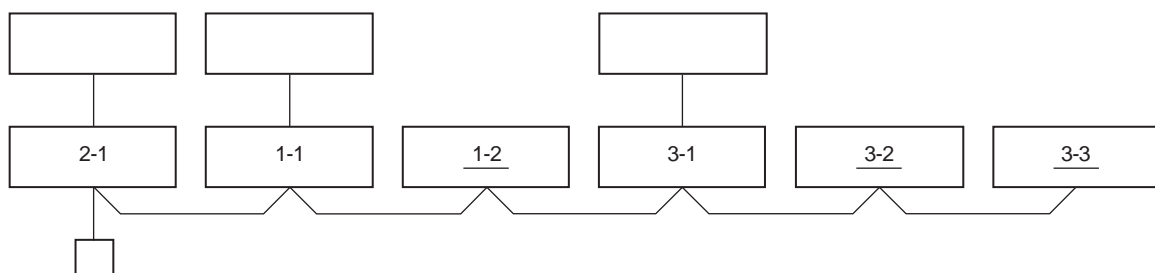

9-3. Address Setup (Manual Setting from Remote Controller)

In case that addresses of the indoor units will be determined prior to piping work after wiring work

- Set an indoor unit per a remote controller.
- Turn on power supply.

(Example of 2-lines wiring)
(Real line: Wiring, Broken line: Refrigerant pipe)

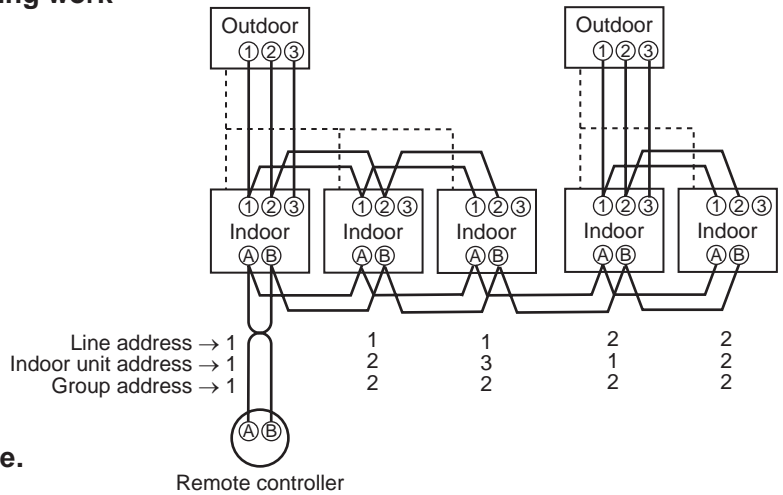

For the above example, perform setting by connecting singly the wired remote controller without remote controller inter-unit wire.

Group address
Individual : 0000
Header unit : 0001
Follower unit : 0002 } In case of group control

- 1 Push **SET** + **CL** + **TEST** buttons simultaneously for 4 seconds or more.
- 2 (Line address)
Using the temperature setup **▼** / **▲** buttons, set **12** to the CODE No.
- 3 Using timer time **▼** / **▲** buttons, set the line address.
- 4 Push **SET** button. (OK when display goes on.)
- 5 (Indoor unit address)
Using the temperature setup **▼** / **▲** buttons, set **13** to the CODE No.
- 6 Using timer time **▼** / **▲** buttons, set **1** to the line address.
- 7 Push **SET** button. (OK when display goes on.)
- 8 (Group address)
Using the temperature setup **▼** / **▲** buttons, set **14** to the CODE No.
- 9 Using timer time **▼** / **▲** buttons, set **0000** to Individual, **0001** to Header unit, and **0002** to Folloer unit.
- 10 Push **SET** button. (OK when display goes on.)
- 11 Push **TEST** button.
Setup completes. (The status returns to the usual stop status.)

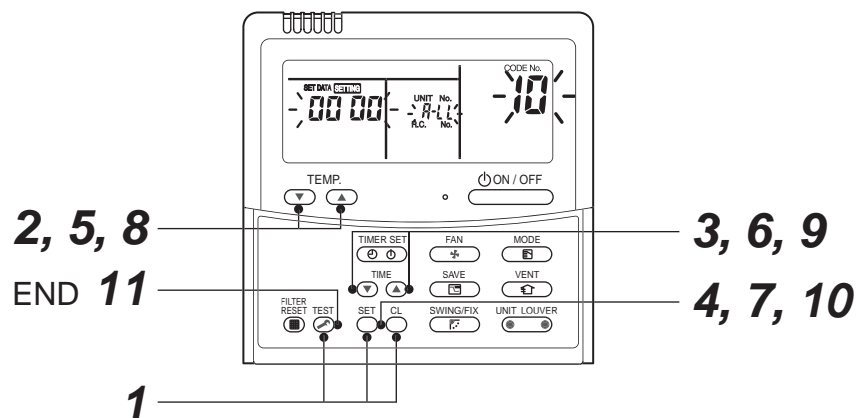

<Operation procedure>

1 → 2 → 3 → 4 → 5 → 6 → 7 → 8 → 9 → 10 → 11 END

9-4. Confirmation of Indoor Unit No. Position

1. To know the indoor unit addresses though position of the indoor unit body is recognized

- In case of individual operation (Wired remote controller : indoor unit = 1 : 1)
(Follow to the procedure during operation)

<Procedure>

1 Push  button if the unit stops.

2 Push  button.

Unit No. **1-1** is displayed on LCD.

(It disappears after several seconds.)

The displayed unit No. indicate line address and indoor unit address. (When other indoor units are connected to the identical remote controller (Group control unit), other unit numbers are also displayed every pushing  button.

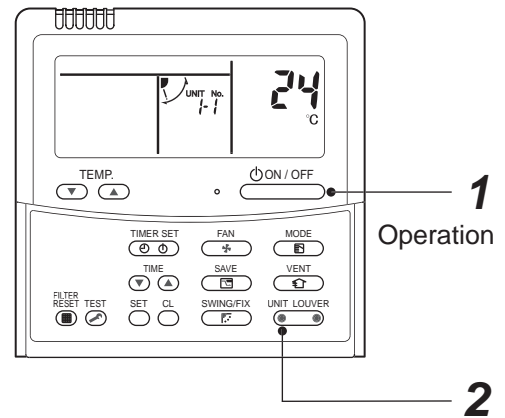

<Operation procedure>

1 → 2 END

2. To know the position of indoor unit body by address

- To confirm the unit No. in the group control
(Follow to the procedure during operation) (in this procedure, the indoor units in group control stop.)

<Procedure>

The indoor unit numbers in the group control are successively displayed, and fan, louver, and drain pump of the corresponding indoor unit are turned on. (Follow to the procedure during operation)

1 Push  and  buttons simultaneously for 4 seconds or more.

- Unit No. **ALL** is displayed.
- Fans and louvers of all the indoor units in the group control operate.

2 Every pushing  button, the unit numbers in the group control are successively displayed.

- The unit No. displayed at the first time indicates the header unit address.
- Fan and louver of the selected indoor unit only operate.

3 Push  button to finish the procedure. All the indoor units in the group control stop.

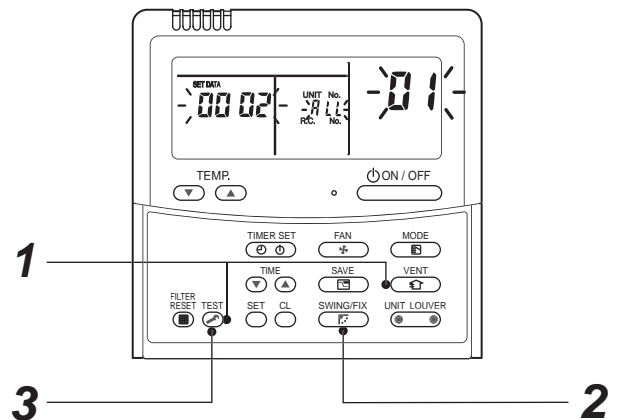

<Operation procedure>

1 → 2 → 3 END

10. DETACHMENTS

⚠ WARNING

Be sure to stop operation of the air conditioner before work and then turn off switch of the breaker.

⚠ CAUTION



Be sure to put on gloves during working time; otherwise an injury will be caused by a part, etc.

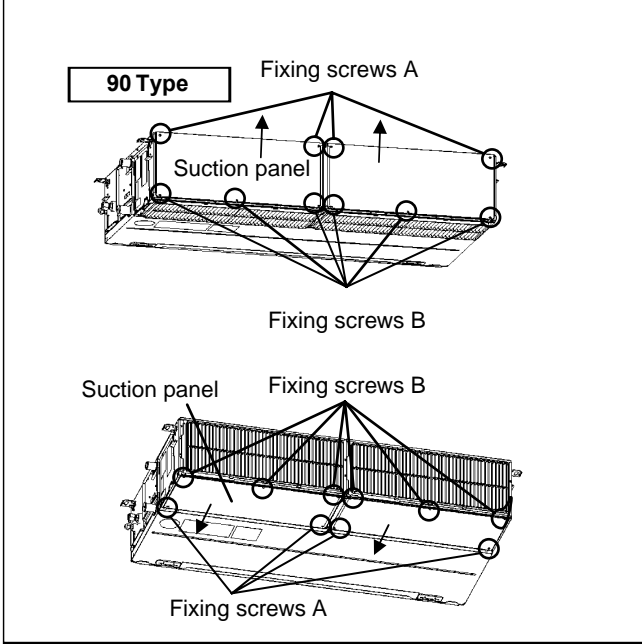
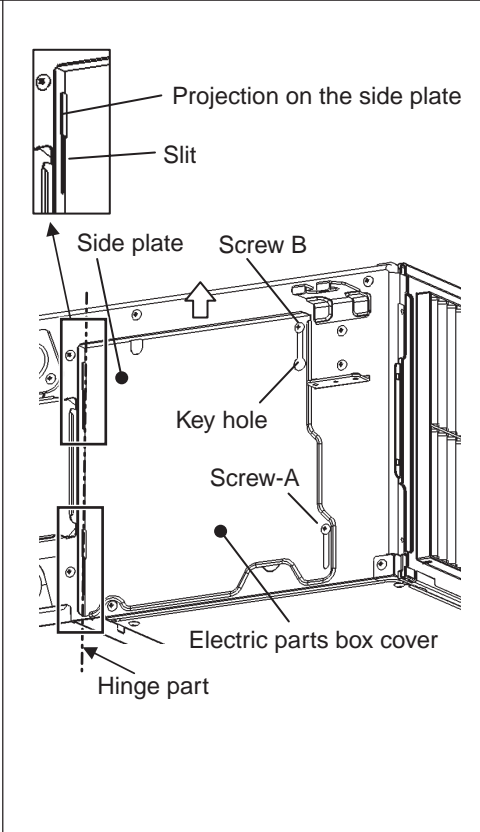

NOTE

In a section 10, Detachments, the models are expressed as follows for convenience.
90 Types: RAV-GM901BTP-E, -TR

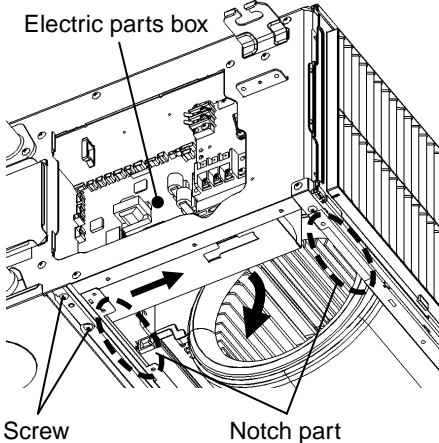
No.	Part name	Procedure	Remarks
①	Air filter	<p>1. Detachment</p> <p>1) Slide the filter toward the opposite side of the arrow mark and then pull out the filter. (In the case that two filters are provided, pull out the first filter, then the second filter will be pulled out connected with the first filter.)</p> <p>2. Attachment</p> <p>1) Insert the filter in the filter rail toward the arrow mark, slide it until the filter stops and then fix it. (In the case that two filters are provided, insert the second filter in the same direction after inserting the first filter.)</p>	<p>The diagram consists of two parts. The upper part shows a perspective view of the air intake area with the filter being pulled out. Labels include 'Back air intake' and 'Air filter'. The lower part shows a perspective view of the filter being inserted into the 'Under air intake' area. Labels include 'Under air intake', 'Air filter', and 'Arrow mark' pointing to the filter's position.</p>

No.	Part name	Procedure	Remarks
②	Suction panel	<p>1. Detachment</p> <ol style="list-style-type: none"> 1) Remove the fixing screws A which fix the suction panel. Loosen the fixing screws B. 2) Slide the suction panel to the arrow side and then remove the panel. <p>2. Attachment</p> <ol style="list-style-type: none"> 1) Hook the suction panel to the fixing screws B and tighten screws. 2) Attach the removed screws A to the original positions. 	
		<p>1. Detachment</p> <ol style="list-style-type: none"> 1) Remove the screw A of the electric parts box cover to loosen screw B. 2) As shown in the right figure, when sliding it toward arrow direction and pulling to this side, the electric parts cover opens using the hinge part as a shaft. 3) Take off the slit of the electric parts box cover from the projection of the side plate and then remove the cover. <p>2. Attachment</p> <ol style="list-style-type: none"> 1) Hook the slit of the electric parts box cover to the projection of the side plate, close the cover, enter screw B in the Key hole and then slide it. 2) Fix the electric parts box cover by tightening with screws A and B. 	

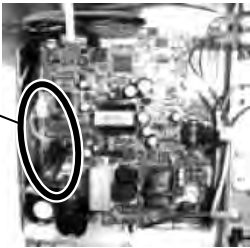
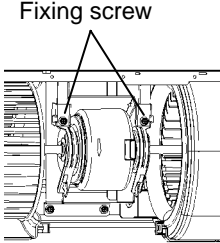
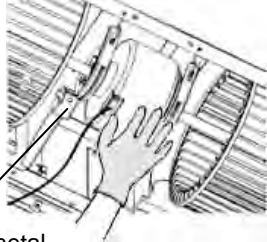
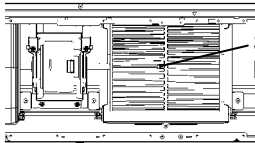
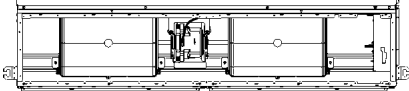
No.	Part name	Procedure	Remarks
④	Electric parts box	<p>1. Detachment</p> <ol style="list-style-type: none"> 1) Perform works of 1 of ①. (In case of under air intake) Perform works of 1 of ②. (In case of back air intake) Perform works of 1 of ③. 2) Remove the indoor/outdoor connecting wire and remote controller wire from each terminal block. 3) Remove the connectors which connected from the control P.C. board to other parts. <p>NOTE</p> <hr/> <p>First unlock the housing and then remove the connectors.</p> <hr/> <p>CN34 : Float switch (3P, Red) CN41 : Remote controller terminal block (3P, Blue) (Screw part of terminal block, 2P.) CN504 : Drain pump (2P, White) CN67 : Power supply terminal block (5P: Black) (Screw part of terminal block, 3P.) CN101 : TC sensor (2P: Black) CN102 : TCJ sensor (2P, Red) CN104 : Room temperature (2P, Yellow)</p> <ol style="list-style-type: none"> 4) Remove screws. (Ø4 x 10, 2 pcs.) 5) Slide the electric parts box toward the arrow mark and then remove the box from the bottom side of the main unit. <p>2. Attachment</p> <ol style="list-style-type: none"> 1) Attach the electric parts box and then perform wiring as original. <p>Notes 1</p> <hr/> <p>Check there is no missing or contact failure on the connectors.</p> <hr/> <p>Notes 2</p> <hr/> <p>Be sure to perform wiring as original.</p> <hr/> <ol style="list-style-type: none"> 2) Attach air filter, suction panel, and electric parts box as original. 	 
⑤	Control P.C. board	<p>1. Detachment</p> <ol style="list-style-type: none"> 1) Perform work of 1 of ④. (In the works of 1 of ④, removal of the control P.C. board is available even if you do not perform works after 4)). 2) Unlock the card edge spacers (5 positions) in the electric parts box to remove the control P.C. board. <p>2. Attachment</p> <ol style="list-style-type: none"> 1) Mount control P.C. board in the electric parts box as original. 2) Attach the electric parts box as original. 3) Be sure to perform wiring as original in the electric parts box. <p>NOTE</p> <hr/> <p>Check there is no missing or contact failure on the connectors.</p> <hr/> <ol style="list-style-type: none"> 4) Attach each air filter, suction panel or electric parts box cover as original. 	 <p>⚠ CAUTION When replacing PC. board, check no-mex paper is attached.</p> 

No.	Part name	Procedure	Remarks
⑥	Fan motor, Fan, Fan case	<p>1. Detachment</p> <ol style="list-style-type: none"> 1) Perform works until opening of the electric parts box cover in works of 1 of ④. 2) Remove connectors for fan motor wiring from control P.C. board. CN333 : Motor power supply (5P: White) CN334 : Motor control (5P: White) 3) Open the fan case (under) and remove it while pressing claws of the fan case (under). (There are both sides of the case) 4) Remove the fixing screws (Ø5 x 10, 2 pcs.) of the fixing plate (2 pcs.) at the side of the fan motor. (The fan motor becomes temporal hanging status by fixing plate.) 5) While supporting the fan motor by hands, remove the fixing plate from the motor base to remove the fan motor. 6) Loosen the hexagonal screw hole of the fan and then pull out the fan from the shaft. (Hexagon wrench : 3mm) <p>2. Attachment</p> <ol style="list-style-type: none"> 1) Insert the fan in the shaft while adjusting to match the hexagonal screw hole to the groove of the shaft. 2) Perform screwing the fan motor with the fixing plate (Ø5 x 10, 2 pcs.) <p>NOTE</p> <hr/> <p>Match the fan motor with turning direction of the fan and fix so that the 90 type is at opposite side of refrigerant piping.</p> <hr/> <ol style="list-style-type: none"> 3) While positioning so that the fan is at the center of the fan case (upper), fix the fan with hexagonal screw. <p>NOTE</p> <hr/> <p>Be sure to use a torque wrench for fixing and tighten with 4.9N•m or more.</p> <hr/> <ol style="list-style-type: none"> 4) Attach the fan case (under) as original and check the fan turns smoothly without coming to contact with the fan case. 5) Connect the fan motor wirings as before, close and fix the electric parts box cover. Be sure to perform wirings as original in the electric parts box. 6) Attach air filter and suction panel as original position. 	 <p>Fan motor wiring CN333 CN334</p>  <p>Fixing screw</p>  <p>Fixing sheet metal</p>  <p>Screw with hexagonal hole</p> <p>90 Type</p>  <div style="border: 1px solid black; padding: 2px; display: inline-block;">Refrigerant piping side</div>  <p>⚠ CAUTION When replacing the fan motor, be sure to exchange the clamp filter with the fan motor lead wire.</p>

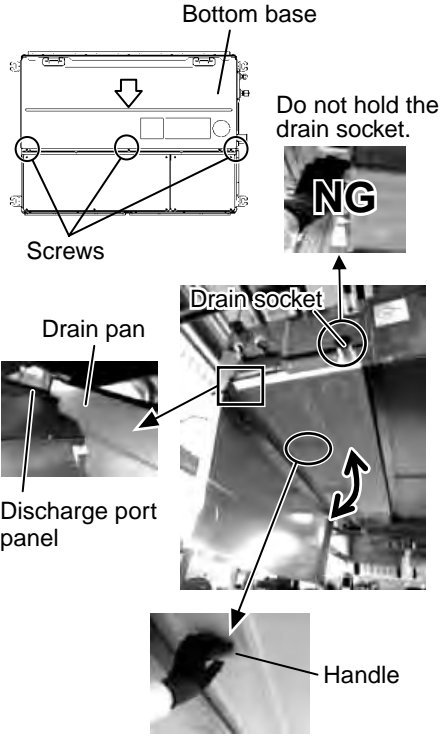
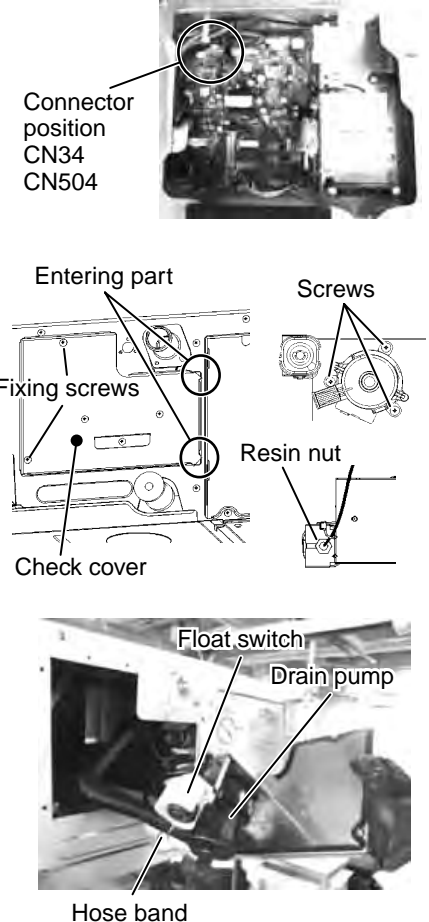
No.	Part name	Procedure	Remarks
⑦	Drain pan	<p>1. Detachment</p> <p>1) Remove the drain cap and then extract the drain water accumulated in the drain pan.</p> <p>NOTE</p> <p>When removing the drain cap, be sure to receive drain water using a bucket, etc.</p> <p>2) Loosen screws which fix the bottom base. (3 positions) (For 140 type models, remove 2 screws at the center.)</p> <p>3) As shown in the right figure, when sliding it toward arrow direction, the electric parts cover the bottom base opens using the hinge part as a shaft.</p> <p>4) Hold handle of the drain pan and then pull off slowly.</p> <p>CAUTION</p> <p>When removing the drain pan, do not hold the drain socket. (Water leakage may be caused.)</p> <p>2. Attachment</p> <p>1) First hook the thin side of the drain pan to the discharge panel and then push in the thick side.</p> <p>2) Close the bottom base and fix it with screws.</p>	 <p>Bottom base</p> <p>Screws</p> <p>Do not hold the drain socket.</p> <p>NG</p> <p>Drain pan</p> <p>Discharge port panel</p> <p>Drain socket</p> <p>Handle</p>
⑧	Drain pump Float switch	<p>1. Detachment</p> <p>1) Perform works until opening of the electric parts box cover in works of 1 of ④.</p> <p>2) Remove the connectors which connect to float switch of the drain pump from the control P.C. board. CN34 : Float switch (3P, Red) CN504 : Drain pump (2P, White)</p> <p>3) Remove the fixing screws (2 positions) of the check cover and then take out the check cover. (To the check cover, the drain pump and float switch are attached.)</p> <p>4) Pick up the hose band, shift from the pump connecting part, remove the drain hose and then remove the check cover.</p> <p>5) Remove screws which fix the drain pump assembly and then remove the drain pump assembly. (Ø4 x 10, 3 pcs.)</p> <p>6) Remove the resin nut switch and then remove the float switch from the fixing plate.</p> <p>2. Attachment</p> <p>1) Using the removed screws, fix the drain pump assembly as original.</p> <p>2) Using the removed resin nut, fix the float switch as original.</p> <p>3) Connect the drain hose as original and then attach the hose band.</p> <p>4) Connect the drain pump and the float switch wiring as original and close the electric parts box cover for fixing. Be sure to perform wiring in the electric parts box as original.</p> <p>5) Enter the corners (2 positions) of the check cover in the entering part and then fix it using fixing screws (2 positions).</p>	 <p>Connector position CN34 CN504</p> <p>Entering part</p> <p>Screws</p> <p>Fixing screws</p> <p>Resin nut</p> <p>Check cover</p> <p>Float switch</p> <p>Drain pump</p> <p>Hose band</p>

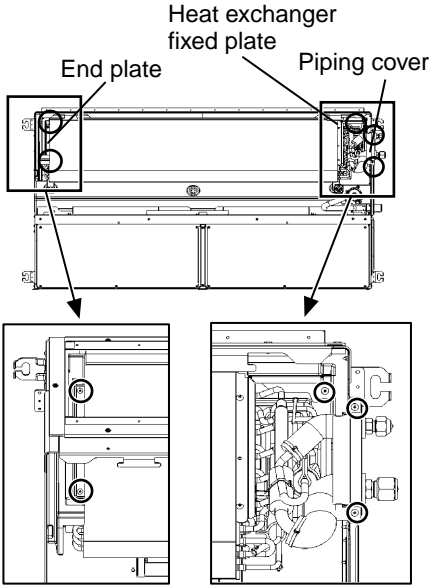
No.	Part name	Procedure	Remarks
⑨	Heat exchanger	<p>1. Detachment</p> <ol style="list-style-type: none"> 1) Recover the refrigerant gas and then remove the refrigerant pipe of the indoor unit. 2) Perform works of 1 of ⑦. 3) Pull out TC sensor and TCJ sensor wirings from the holder. 4) Remove the screws (Ø4 x 8, 2 pcs.) and then remove the piping cover. 5) Remove screws (Ø4 x 8, 1pc.) of the heat exchanger fixed plate. 6) While holding the heat exchanger, remove the fixed screws (Ø4 x 8, 2 pcs.) of the end plate and then take out the heat exchanger slowly. <p>2. Attachment</p> <ol style="list-style-type: none"> 1) Set the heat exchanger at the original position and fix it as before, using screws which removed the end plate, heat exchanger fixed plate and piping cover. 2) Enter TC sensor and TCJ sensor wirings in the holder and then perform wirings as original. 3) Attach the drain pan and the bottom base as original. 	<p>○ : Screw position</p> <p>90 Type</p> 

11. EXPLODED VIEWS AND PARTS LIST

RAV-GM901BTP-E, RAV-GM901BTP-TR

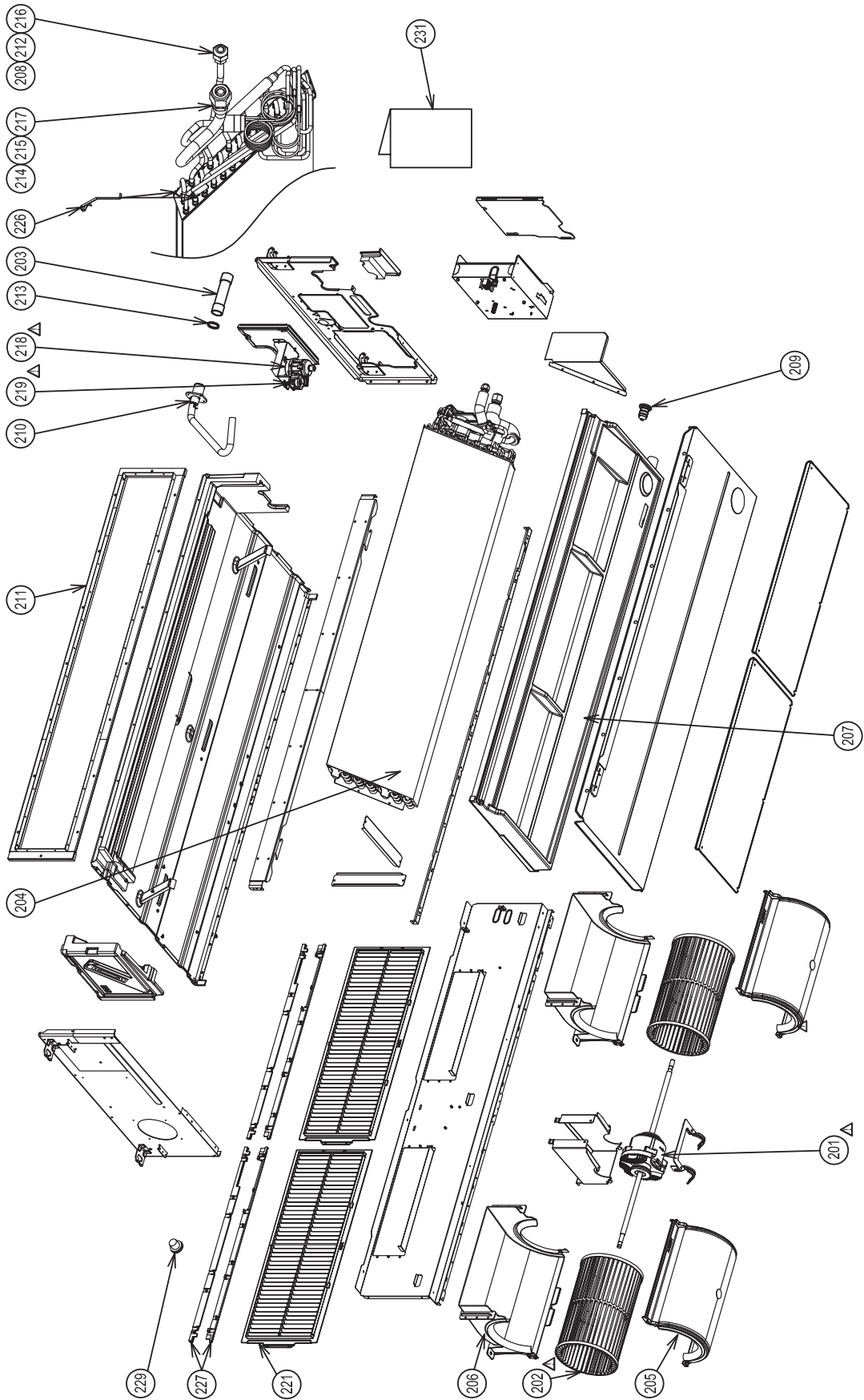

Location No.	Part No.	Description	Model name RAV-GM	
			901BTP-E	901BTP-TR
201	43T21446	MOTOR, FAN	1	1
202	43T20339	FAN, MULTI BLADE	2	2
203	43T70315	HOSE, DRAIN	1	1
204	43T44617	REFRIGERANT CYCLE ASSEMBLY	1	1
205	43T22336	CASE, FAN, LOWER	2	2
206	43T22338	CASE, FAN, UPPER	2	2
207	43T72319	PAN ASSY, DRAIN	1	1
208	43T82337	SOCKET	1	1
209	43T79321	CAP, DRAIN	1	1
210	43T70319	ASM-HOSE-DRAIN	1	1
211	43T39358	FLANGE	1	1
212	43T47332	BONNET, 9.52 DIA	1	1
213	43T83311	BAND, HOSE	1	1
214	43T82339	SOCKET	1	1
215	43T97323	NUT, FLARE, 5/8 IN	1	1
216	43T97321	NUT, FLARE, 3/8 IN	1	1
217	43T47334	BONNET; 15.88 DIA	1	1
218	43T77301	PUMP ASSY	1	1
219	43T51312	SWITCH, FLOAT	1	1
221	43T80340	AIR FILTER	2	2
226	43T19333	HOLDER, SENSOR	2	2
227	43T82331	RAIL, FILTER ASSY	1	1
229	43T82323	FILTER, STOPPER	1	1
231	43T85771	OWNER'S MANUAL	1	-
231	43T85772	OWNER'S MANUAL	-	1

Electric parts

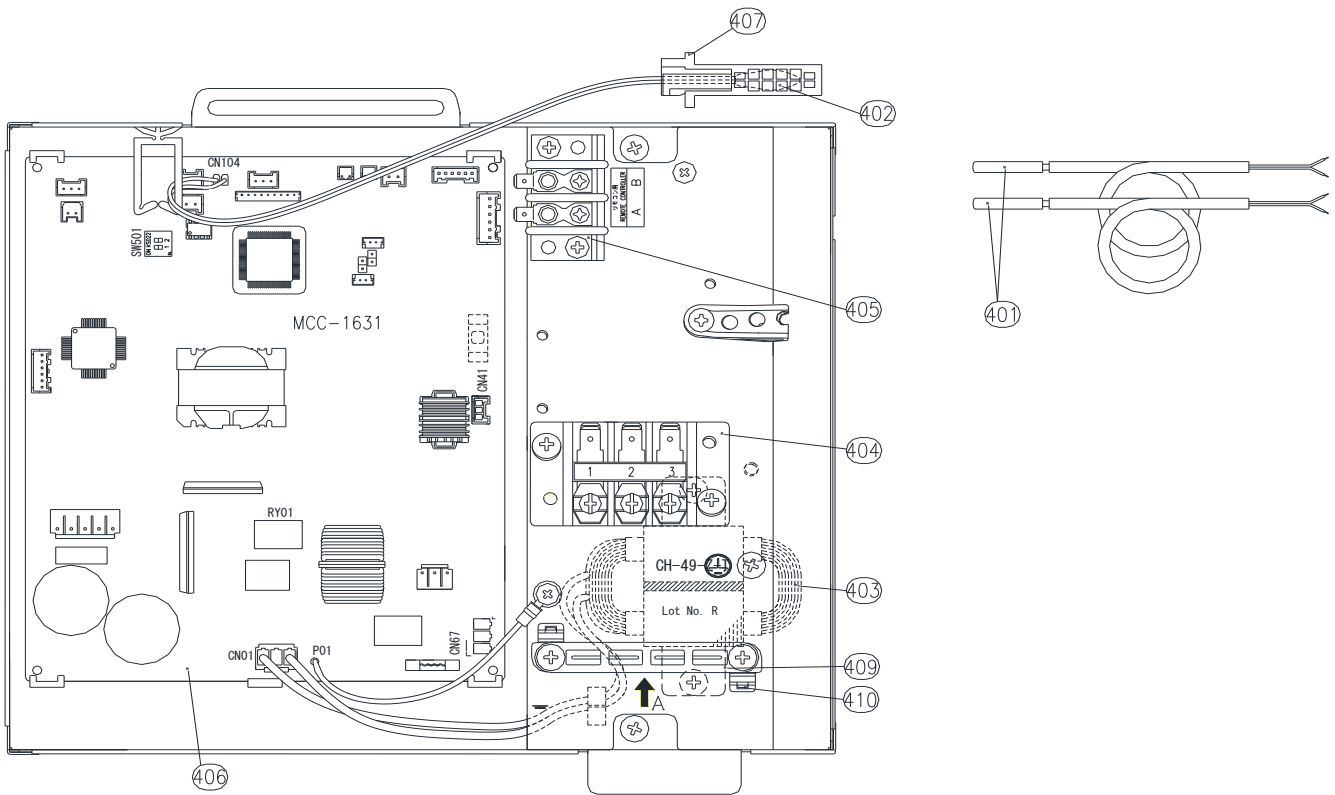

Location No.	Part No.	Description	Model name RAV-GM	
			901BTP-E	901BTP-TR
401	43T50347	SENSOR ASSY, SERVICE	2	2
402	43T50476	SERVICE-SENSOR	1	1
403	43T58320	REACTOR	1	1
404	43T60427	TERMINAL BLOCK	1	1
405	43T60434	TERMINAL BLOCK, 2P	1	1
406	43T6W328	PC BOARD ASSY	1	1
407	43T50351	HOLDER-TA	1	1
409	43T63348	CLAMP, DOWN	1	1
410	43T63349	CLAMP, UP	1	1

WARNINGS ON REFRIGERANT LEAKAGE

Check of Concentration Limit

The room in which the air conditioner is to be installed requires a design that in the event of refrigerant gas leaking out, its concentration will not exceed a set limit.

The refrigerant R32 which is used in the air conditioner is safe, without the toxicity or combustibility of ammonia, and is not restricted by laws to be imposed which protect the ozone layer.

However, since it contains more than air, it poses the risk of suffocation if its concentration should rise excessively. Suffocation from leakage of R32 is almost non-existent.

With the recent increase in the number of high concentration buildings, however, the installation of multi air conditioner systems is on the increase because of the need for effective use of floor space, individual control, energy conservation by curtailing heat and carrying power etc.

Most importantly, the multi air conditioner system is able to replenish a large amount of refrigerant compared with conventional individual air conditioners.

If a single unit of the multi conditioner system is to be installed in a small room, select a suitable model and installation procedure so that if the refrigerant accidentally leaks out, its concentration does not reach the limit (and in the event of an emergency, measures can be made before injury can occur).

In a room where the concentration may exceed the limit, create an opening with adjacent rooms, or install mechanical ventilation combined with a gas leak detection device.

The concentration is as given below.

$$\frac{\text{Total amount of refrigerant (kg)}}{\text{Min. volume of the indoor unit installed room (m}^3\text{)}} \leq \text{Concentration limit (kg/m}^3\text{)}$$

The concentration limit of R32 which is used in multi air conditioners is 0.3kg/m³.

NOTE 1 :

If there are 2 or more refrigerating systems in a single refrigerating device, the amounts of refrigerant should be as charged in each independent device.

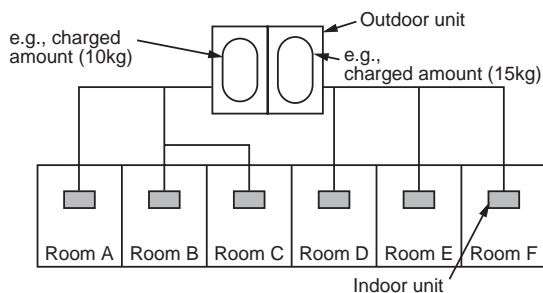

For the amount of charge in this example:

The possible amount of leaked refrigerant gas in rooms A, B and C is 10kg.

The possible amount of leaked refrigerant gas in rooms D, E and F is 15kg.

Important

NOTE 2 :

The standards for minimum room volume are as follows.

- (1) No partition (shaded portion)

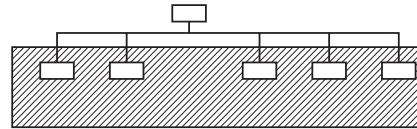

- (2) When there is an effective opening with the adjacent room for ventilation of leaking refrigerant gas (opening without a door, or an opening 0.15% or larger than the respective floor spaces at the top or bottom of the door).

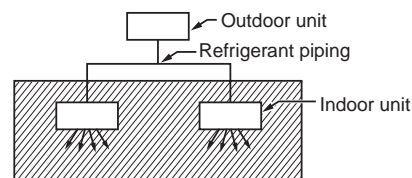

- (3) If an indoor unit is installed in each partitioned room and the refrigerant piping is interconnected, the smallest room of course becomes the object. But when a mechanical ventilation is installed interlocked with a gas leakage detector in the smallest room where the density limit is exceeded, the volume of the next smallest room becomes the object.

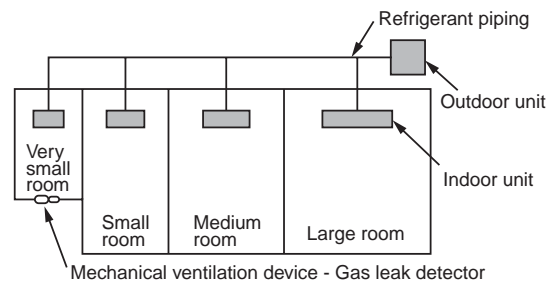

NOTE 3 :

The minimum indoor floor area compared with the amount of refrigerant is roughly as follows: (When the ceiling is 2.7m high)

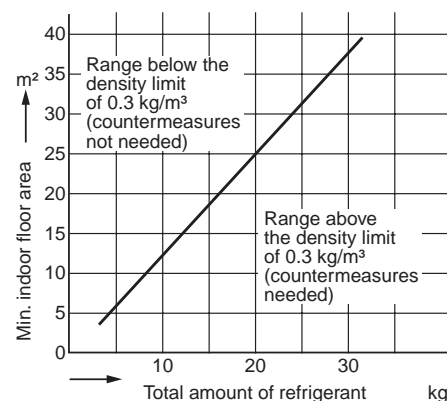

Toshiba Carrier (Thailand) Co., Ltd.

**144/9 MOO 5, BANGKADI INDUSTRIAL PARK, TIVANON ROAD, TAMBOL BANGKADI,
AMPHUR MUANG, PATHUMTHANI 12000, THAILAND.**