

SERVICE MANUAL AIR-CONDITIONER (MULTI TYPE)

OUTDOOR UNIT

Model name:

MCY-MHP0806HS8-E
MCY-MHP1006HS8-E
MCY-MHP0806HS8-TR
MCY-MHP1006HS8-TR

MCY-MHP0806HT8-C*
MCY-MHP0906HT8-C*
MCY-MHP1006HT8-C*

This service manual provides relevant explanations about new outdoor unit.
Please refer to the following service manuals for each indoor units.

	Service Manual No.
<4-way Cassette Type> (MMU-AP****HY) (Made in China model)	A10-1402
<Compact 4-way Cassette Type> (MMU-AP****MH*)	A10-033
<2-way Cassette Type> (MMU-AP****WH*)	A10-007
<1-way Cassette Type> (MMU-AP****YH*) (MMU-AP****SH*)	A10-033 A10-033
<Concealed Duct Standard> (MMD-AP****BH*) (MMD-AP****BHY*) (Made in China model)	A10-033 A10-1415
<Concealed Duct High Static Pressure Type> (MMD-AP****H*) (MMD-AP0726,P0966HP*) (Made in Thailand model)	A10-033 SVM-16038
<Slim Duct Type> (MMD-AP****S(P)H*) (MMD-AP024, A0274SPH*)	A10-033 A12-005
<Compact Slim Duct Type> (MMD-AP****M(P)H*) (MMD-AP****M(P)HY*) (Made in China model)	A10-1612 A10-1403
<Ceiling Type> (MMC-AP****H*) (MMC-AP****HP*) (Made in Thailand model)	A10-033 SVM-17015
<Floor Standing Cabinet Type> (MML-AP****H*)	A10-033
<Floor Standing Concealed Type> (MML-AP****BH*)	A10-033
<Floor Standing Type> (MMF-AP****H*)	A10-033
<High Wall Type> (MMK-AP****H*) (MMK-AP****HP*) (Made in Thailand model) (Made in Thailand model)	SVM-17053 SVM-17085
<Console Type> (MML-AP****NH*) (Made in Thailand model)	SVM-11036
<HWM Type> (MMW-AP****LQ*)	A10-1505

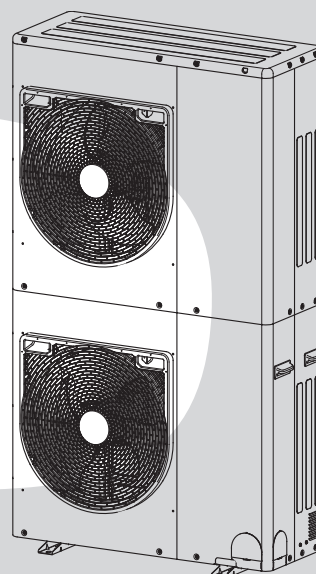

Contents

Precautions for safety	7
1 Product summary	15
1-1. Outdoor unit	15
1-2. Connectable indoor units	15
1-3. Branching joints and headers	16
1-4. PMV kit	16
2 Construction views	17
3 Wiring diagram	19
4 Parts rating	20
4-1. Outdoor unit	20
4-2. Outdoor inverter	20
4-3. Parts layout in outdoor unit	21
4-4. Parts layout in inverter assembly	22
4-5. Outdoor (inverter) print circuit board	23
4-5-1. Interface P.C. board (MCC-1639)	23
4-5-2. Inverter P.C. board for compressor (MCC-1729) A3-IPDU	24
4-5-3. Fan motor IPDU (MCC-1728) for upper fan and center fan	25
4-5-4. Noise filter (MCC-1733)	26
5 Refrigerant piping systematic drawing	27
6 Control outline	29
7 Applied control for outdoor unit	36
7-1. Outdoor fan high static pressure shift	36
7-2. Priority operation mode setting	36
7-3. Applied control of outdoor unit	38
7-3-1. Optional P.C. board of outdoor unit installation	38
7-3-2. Power peak-cut control (standard)	40
7-3-3. Power peak-cut control (extended)	41
7-3-4. Snowfall fan control	42
7-3-5. External master ON / OFF control	42
7-3-6. Night operation (sound reduction) control	43
7-3-7. Operation mode selection control	44
7-3-8. Error / Operation output	45

8	Test operation	46
8-1.	Procedure and summary of test operation	46
8-2.	Check items before test operation (before powering-on).	47
8-3.	Check at main power-on	52
8-4.	Address setup	53
8-4-1.	Precautions	53
8-4-2.	Address setup and check procedure	53
8-4-3.	Address setup procedure	54
8-4-4.	Check after address setup when central control system is connected.	68
8-5.	Troubleshooting in test operation	69
8-5-1.	A check code is displayed on the remote controller.	69
8-5-2.	Operation from the indoor remote controller is not accepted, and a check code is displayed on the 7-segment display of the interface P.C. board of the outdoor unit.	70
8-5-3.	There is no display of a check code on the 7-segment display on the interface P.C. board of the outdoor unit, although there is indoor unit that is not accepting operation from the indoor remote controller.	70
8-5-4.	In checking the number of connected outdoor units and connected indoor units after address setup, a lower number of connected units is displayed. (There are outdoor / indoor units that do not operate in a test operation.)	71
8-6.	Test operation check	72
8-6-1.	Fan check.	72
8-6-2.	Cooling / Heating test operation check.	73
8-7.	Service support function	77
8-7-1.	Check function for connecting of refrigerant and control lines	77
8-7-2.	Function to start / stop (ON / OFF) indoor unit from outdoor unit.	79
8-7-3.	Check code clearing function.	84
8-7-4.	Remote controller distinction function	86
8-7-5.	Pulse motor valve (PMV) forced open / close function in indoor unit	87
8-7-6.	Pulse motor valve (PMV) forced fixing function in outdoor unit	87
8-7-7.	Solenoid valve forced open / close function in outdoor unit	89
8-7-8.	Fan operation check in outdoor unit.	90
8-7-9.	Manual adjustment function of outside temperature (TO) sensor	91
8-7-10.	Service support function list	92
8-7-11.	Monitor function of remote controller switch	93
9	Troubleshooting	94
9-1.	Overview	94
9-2.	Troubleshooting method	95
9-3.	Troubleshooting based on information displayed on remote controller	100
9-4.	Check codes displayed on remote controller and outdoor unit (7-segment display on I/F board) and locations to be checked	105
9-5.	Diagnosis procedure for each check code	117
9-6.	7-segment display function	143
9-7.	Sensor characteristics	148
9-8.	Pressure sensor output check	151

10 Outdoor unit parts replacement methods	153
11 P.C. board exchange procedures	173
11-1. Interface P.C. board replacement procedure (MCC-1639:43H69066)	173
11-2. Comp-IPDU P.C. board replacement procedure (MCC-1729:43H69065)	174
11-3. Fan IPDU P.C. board replacement procedure (MCC-1728:43H69055)	175
11-4. Noise filter P.C. board replacement procedure (MCC-1733:43H69057)	177
12 Exploded diagram / parts list	178

Original instruction

Please read carefully through these instructions that contain important information which complies with the “Machinery Directive” (Directive 2006/42/EC), and ensure that you understand them.

Some of the details provided in these instructions differ from the service manual, and the instructions provided here take precedence.

Generic Denomination: Air Conditioner

Definition of Qualified Installer or Qualified Service Person

The air conditioner must be installed, maintained, repaired and removed by a qualified installer or qualified service person. When any of these jobs is to be done, ask a qualified installer or qualified service person.

A qualified installer or qualified service person is an agent who has the qualifications and knowledge described in the table below.

Agent	Qualifications and knowledge which the agent must have
Qualified installer	<ul style="list-style-type: none"> • The qualified installer is a person who installs, maintains, relocates and removes the air conditioners made by Toshiba Carrier Corporation. He or she has been trained to install, maintain, relocate and remove the air conditioners made by Toshiba Carrier Corporation or, alternatively, he or she has been instructed in such operations by an individual or individuals who have been trained and is thus thoroughly acquainted with the knowledge related to these operations. • The qualified installer who is allowed to do the electrical work involved in installation, relocation and removal has the qualifications pertaining to this electrical work as stipulated by the local laws and regulations, and he or she is a person who has been trained in matters relating to electrical work on the air conditioners made by Toshiba Carrier Corporation or, alternatively, he or she has been instructed in such matters by an individual or individuals who have been trained and is thus thoroughly acquainted with the knowledge related to this work. • The qualified installer who is allowed to do the refrigerant handling and piping work involved in installation, relocation and removal has the qualifications pertaining to this refrigerant handling and piping work as stipulated by the local laws and regulations, and he or she is a person who has been trained in matters relating to refrigerant handling and piping work on the air conditioners made by Toshiba Carrier Corporation or, alternatively, he or she has been instructed in such matters by an individual or individuals who have been trained and is thus thoroughly acquainted with the knowledge related to this work. • The qualified installer who is allowed to work at heights has been trained in matters relating to working at heights with the air conditioners made by Toshiba Carrier Corporation or, alternatively, he or she has been instructed in such matters by an individual or individuals who have been trained and is thus thoroughly acquainted with the knowledge related to this work.
Qualified service person	<ul style="list-style-type: none"> • The qualified service person is a person who installs, repairs, maintains, relocates and removes the air conditioners made by Toshiba Carrier Corporation. He or she has been trained to install, repair, maintain, relocate and remove the air conditioners made by Toshiba Carrier Corporation or, alternatively, he or she has been instructed in such operations by an individual or individuals who have been trained and is thus thoroughly acquainted with the knowledge related to these operations. • The qualified service person who is allowed to do the electrical work involved in installation, repair, relocation and removal has the qualifications pertaining to this electrical work as stipulated by the local laws and regulations, and he or she is a person who has been trained in matters relating to electrical work on the air conditioners made by Toshiba Carrier Corporation or, alternatively, he or she has been instructed in such matters by an individual or individuals who have been trained and is thus thoroughly acquainted with the knowledge related to this work. • The qualified service person who is allowed to do the refrigerant handling and piping work involved in installation, repair, relocation and removal has the qualifications pertaining to this refrigerant handling and piping work as stipulated by the local laws and regulations, and he or she is a person who has been trained in matters relating to refrigerant handling and piping work on the air conditioners made by Toshiba Carrier Corporation or, alternatively, he or she has been instructed in such matters by an individual or individuals who have been trained and is thus thoroughly acquainted with the knowledge related to this work. • The qualified service person who is allowed to work at heights has been trained in matters relating to working at heights with the air conditioners made by Toshiba Carrier Corporation or, alternatively, he or she has been instructed in such matters by an individual or individuals who have been trained and is thus thoroughly acquainted with the knowledge related to this work.



Definition of Protective Gear

When the air conditioner is to be transported, installed, maintained, repaired or removed, wear protective gloves and 'safety' work clothing. In addition to such normal protective gear, wear the protective gear described below when undertaking the special work detailed in the table below. Failure to wear the proper protective gear is dangerous because you will be more susceptible to injury, burns, electric shocks and other injuries.

Work undertaken	Protective gear worn
All types of work	Protective gloves 'Safety' working clothing
Electrical-related work	Gloves to provide protection for electricians Insulating shoes Clothing to provide protection from electric shock
Work done at heights (50 cm or more)	Helmets for use in industry
Transportation of heavy objects	Shoes with additional protective toe cap
Repair of outdoor unit	Gloves to provide protection for electricians



The important contents concerned to the safety are described on the product itself and on this Service Manual. Please read this Service Manual after understanding the described items thoroughly in the following contents (Indications / Illustrated marks), and keep them.

[Explanation of indications]

Indication	Explanation
 DANGER	Indicates contents assumed that an imminent danger causing a death or serious injury of the repair engineers and the third parties when an incorrect work has been executed.
 WARNING	Indicates possibilities assumed that a danger causing a death or serious injury of the repair engineers, the third parties, and the users due to troubles of the product after work when an incorrect work has been executed.
 CAUTION	Indicates contents assumed that an injury or property damage (*) may be caused on the repair engineers, the third parties, and the users due to troubles of the product after work when an incorrect work has been executed.

* Property damage: Enlarged damage concerned to property, furniture, and domestic animal / pet

[Explanation of illustrated marks]







Mark	Explanation
	Indicates prohibited items (Forbidden items to do) The sentences near an illustrated mark describe the concrete prohibited contents.
	Indicates mandatory items (Compulsory items to do) The sentences near an illustrated mark describe the concrete mandatory contents.
	Indicates cautions (Including danger / warning) The sentences or illustration near or in an illustrated mark describe the concrete cautious contents.

Warning indications on the air conditioner unit

[Confirmation of warning label on the main unit]

Confirm that labels are indicated on the specified positions





If removing the label during parts replace, stick it as the original.

Warning indication	Description								
 <table border="1" data-bbox="331 499 584 656"> <tr> <td colspan="2" style="text-align: center;">WARNING</td> </tr> <tr> <td colspan="2">ELECTRICAL SHOCK HAZARD</td> </tr> <tr> <td colspan="2">Disconnect all remote electric power supplies before servicing.</td> </tr> </table>	WARNING		ELECTRICAL SHOCK HAZARD		Disconnect all remote electric power supplies before servicing.		<p>WARNING</p> <p>ELECTRICAL SHOCK HAZARD Disconnect all remote electric power supplies before servicing.</p>		
WARNING									
ELECTRICAL SHOCK HAZARD									
Disconnect all remote electric power supplies before servicing.									
 <table border="1" data-bbox="331 712 584 869"> <tr> <td colspan="2" style="text-align: center;">WARNING</td> </tr> <tr> <td colspan="2">Moving parts. Do not operate unit with grille removed. Stop the unit before the servicing.</td> </tr> </table>	WARNING		Moving parts. Do not operate unit with grille removed. Stop the unit before the servicing.		<p>WARNING</p> <p>Moving parts. Do not operate unit with grille removed. Stop the unit before the servicing.</p>				
WARNING									
Moving parts. Do not operate unit with grille removed. Stop the unit before the servicing.									
 <table border="1" data-bbox="331 925 584 1081"> <tr> <td colspan="2" style="text-align: center;">CAUTION</td> </tr> <tr> <td colspan="2">High temperature parts. You might get burned when removing this panel.</td> </tr> </table>	CAUTION		High temperature parts. You might get burned when removing this panel.		<p>CAUTION</p> <p>High temperature parts. You might get burned when removing this panel.</p>				
CAUTION									
High temperature parts. You might get burned when removing this panel.									
 <table border="1" data-bbox="331 1137 584 1294"> <tr> <td colspan="2" style="text-align: center;">CAUTION</td> </tr> <tr> <td colspan="2">Do not touch the aluminum fins of the unit. Doing so may result in injury.</td> </tr> </table>	CAUTION		Do not touch the aluminum fins of the unit. Doing so may result in injury.		<p>CAUTION</p> <p>Do not touch the aluminium fins of the unit. Doing so may result in injury.</p>				
CAUTION									
Do not touch the aluminum fins of the unit. Doing so may result in injury.									
 <table border="1" data-bbox="331 1350 584 1507"> <tr> <td colspan="2" style="text-align: center;">CAUTION</td> </tr> <tr> <td colspan="2">BURST HAZARD</td> </tr> <tr> <td colspan="2">Open the service valves before the operation, otherwise there might be the burst.</td> </tr> <tr> <td colspan="2">Refrigerant recovery during operation is prohibited.</td> </tr> </table>	CAUTION		BURST HAZARD		Open the service valves before the operation, otherwise there might be the burst.		Refrigerant recovery during operation is prohibited.		<p>CAUTION</p> <p>BURST HAZARD Open the service valves before the operation, otherwise there might be the burst.</p> <p>Refrigerant recovery during operation is prohibited.</p>
CAUTION									
BURST HAZARD									
Open the service valves before the operation, otherwise there might be the burst.									
Refrigerant recovery during operation is prohibited.									
 <table border="1" data-bbox="331 1608 584 1765"> <tr> <td colspan="2" style="text-align: center;">CAUTION</td> </tr> <tr> <td colspan="2">Do not climb onto the fan guard.</td> </tr> <tr> <td colspan="2">Doing so may result in injury.</td> </tr> </table>	CAUTION		Do not climb onto the fan guard.		Doing so may result in injury.		<p>CAUTION</p> <p>Do not climb onto the fan guard. Doing so may result in injury.</p>		
CAUTION									
Do not climb onto the fan guard.									
Doing so may result in injury.									





Precautions for safety







The manufacturer shall not assume any liability for the damage caused by not observing the description of this manual.





DANGER

 Turn off breaker.	<p>Before carrying out the installation, maintenance, repair or removal work, be sure to set the circuit breaker for both the indoor and outdoor units to the OFF position. Otherwise, electric shocks may result.</p>
	<p>Before opening the intake grille of the indoor unit or service panel of the outdoor unit, set the circuit breaker to the OFF position. Failure to set the circuit breaker to the OFF position may result in electric shocks through contact with the interior parts. Only a qualified installer or qualified service person is allowed to remove the intake grille of the indoor unit or service panel of the outdoor unit and do the work required.</p>
	<p>Before starting to repair the outdoor unit fan or fan guard, be absolutely sure to set the circuit breaker to the OFF position, and place a "Work in progress" sign near the circuit breaker before proceeding with the work.</p>
	<p>When checking the electric parts, removing the cover of the electric parts box of Indoor Unit and/or front panel of outdoor unit inevitably to determine the failure, put a sign "Do not enter" around the site before the work. Failure to do this may result in third person getting electric shock.</p>
	<p>When you have noticed that some kind of trouble (such as when a check code display has appeared, there is a smell of burning, abnormal sounds are heard, the air conditioner fails to cool or heat or water is leaking) has occurred in the air conditioner, do not touch the air conditioner yourself but set the circuit breaker to the OFF position, and contact a qualified service person. Take steps to ensure that the power will not be turned on (by marking "out of service" near the circuit breaker, for instance) until qualified service person arrives. Continuing to use the air conditioner in the trouble status may cause mechanical problems to escalate or result in electric shocks or other failure.</p>
 Electric shock hazard	<p>When you access inside of the service panel to repair electric parts, wait for about five minutes after turning off the breaker. Do not start repairing immediately. Otherwise you may get electric shock by touching terminals of high-voltage capacitors. Natural discharge of the capacitor takes about five minutes.</p>
 Prohibition	<p>Place a "Work in progress" sign near the circuit breaker while the installation, maintenance, repair or removal work is being carried out. There is a danger of electric shocks if the circuit breaker is set to ON by mistake.</p>
	<p>Before operating the air conditioner after having completed the work, check that the electrical control box cover of the indoor unit and service panel of the outdoor unit are closed, and set the circuit breaker to the ON position. You may receive an electric shock if the power is turned on without first conducting these checks.</p>
 Stay on protection	<p>If, in the course of carrying out repairs, it becomes absolutely necessary to check out the electrical parts with the electrical control box cover of one or more of the indoor units and the service panel of the outdoor unit removed in order to find out exactly where the trouble lies, wear insulated heat-resistant gloves, insulated boots and insulated work overalls, and take care to avoid touching any live parts. You may receive an electric shock if you fail to heed this warning. Only qualified service person is allowed to do this kind of work.</p>

 **WARNING**

 General	<p>Before starting to repair the air conditioner, read carefully through the Service Manual, and repair the air conditioner by following its instructions.</p>
	<p>Only qualified service person is allowed to repair the air conditioner. Repair of the air conditioner by unqualified person may give rise to a fire, electric shocks, injury, water leaks and/or other problems.</p>
	<p>Do not use any refrigerant different from the one specified for complement or replacement. Otherwise, abnormally high pressure may be generated in the refrigeration cycle, which may result in a failure or explosion of the product or an injury to your body.</p>
	<p>Only a qualified installer or qualified service person is allowed to carry out the electrical work of the air conditioner. Under no circumstances must this work be done by an unqualified individual since failure to carry out the work properly may result in electric shocks and/or electrical leaks.</p>
	<p>Wear protective gloves and safety work clothing during installation, servicing and removal.</p>
	<p>When connecting the electrical wires, repairing the electrical parts or undertaking other electrical jobs, wear gloves to provide protection for electricians, insulating shoes and clothing to provide protection from electric shocks. Failure to wear this protective gear may result in electric shocks.</p>
	<p>Electrical wiring work shall be conducted according to law and regulation in the community and installation manual. Failure to do so may result in electrocution or short circuit.</p>
	<p>Only a qualified installer or qualified service person is allowed to undertake work at heights using a stand of 50 cm or more or to remove the intake grille of the indoor unit to undertake work.</p>
	<p>When working at heights, use a ladder which complies with the ISO 14122 standard, and follow the procedure in the ladder's instructions. Also wear a helmet for use in industry as protective gear to undertake the work.</p>
	<p>When transporting the air conditioner, use a forklift and when moving the air conditioner by hand, move the unit with 5 people.</p>
	<p>When executing address setting, test run, or troubleshooting through the checking window on the electrical control box, put on insulated gloves to provide protection from electric shock. Otherwise you may receive an electric shock.</p>
	<p>Do not touch the aluminum fin of the outdoor unit. You may injure yourself if you do so. If the fin must be touched for some reason, first put on protective gloves and safety work clothing, and then proceed.</p>
	<p>Do not climb onto or place objects on top of the outdoor unit. You may fall or the objects may fall off of the outdoor unit and result in injury.</p>
	<p>When transporting the air conditioner, wear shoes with additional protective toe caps. When transporting the air conditioner, do not take hold of the bands around the packing carton. You may injure yourself if the bands should break.</p>
<p>Be sure that a heavy unit (10 kg or heavier) such as a compressor is carried by two persons.</p>	
 Check earth wires.	<p>Before troubleshooting or repair work, check the earth wire is connected to the earth terminals of the main unit, otherwise an electric shock is caused when a leak occurs. If the earth wire is not correctly connected, contact an electric engineer for rework.</p>
	<p>After completing the repair or relocation work, check that the ground wires are connected properly.</p>
	<p>Be sure to connect earth wire. (grounding work) Incomplete grounding causes an electric shock. Do not connect ground wires to gas pipes, water pipes, and lightning rods or ground wires for telephone wires.</p>
 Prohibition of modification.	<p>Do not modify the products. Do not also disassemble or modify the parts. It may cause a fire, electric shock or injury.</p>
 Use specified parts.	<p>When any of the electrical parts are to be replaced, ensure that the replacement parts satisfy the specifications given in the Service Manual (or use the parts contained on the parts list in the Service Manual). Use of any parts which do not satisfy the required specifications may give rise to electric shocks, smoking and/or a fire.</p>

 Do not bring a child close to the equipment.	If, in the course of carrying out repairs, it becomes absolutely necessary to check out the electrical parts with the electrical control box cover of one or more of the indoor units and the service panel of the outdoor unit removed in order to find out exactly where the trouble lies, put a sign in place so that no-one will approach the work location before proceeding with the work. Third-party individuals may enter the work site and receive electric shocks if this warning is not heeded.
 Insulating measures	Connect the cut-off lead wires with crimp contact, etc., put the closed end side upward and then apply a drain off method, otherwise a leak or production of fire is caused at the user's side.
 No fire	When performing repairs using a gas burner, replace the refrigerant with nitrogen gas because the oil that coats the pipes may otherwise burn. When repairing the refrigerating cycle, take the following measures. 1) Be attentive to fire around the cycle. When using a gas stove, etc., be sure to put out fire before work; otherwise the oil mixed with refrigerant gas may catch fire. 2) Do not use a welder in the closed room. When using it without ventilation, carbon monoxide poisoning may be caused. 3) Do not bring inflammables close to the refrigerant cycle, otherwise fire of the welder may catch the inflammables.
 Refrigerant	The refrigerant used by this air conditioner is the R410A. Check the used refrigerant name and use tools and materials of the parts which match with it. For the products which use R410A refrigerant, the refrigerant name is indicated at a position on the outdoor unit where is easy to see. To prevent miss-charging, the route of the service port is changed from one of the former R22. For an air conditioner which uses R410A, never use other refrigerant than R410A. For an air conditioner which uses other refrigerant (R22, etc.), never use R410A. If different types of refrigerant are mixed, abnormal high pressure generates in the refrigerating cycle and an injury due to breakage may be caused. When the air conditioner has been installed or relocated, follow the instructions in the Installation Manual and purge the air completely so that no gases other than the refrigerant will be mixed in the refrigerating cycle. Failure to purge the air completely may cause the air conditioner to malfunction. Do not charge refrigerant additionally. If charging refrigerant additionally when refrigerant gas leaks, the refrigerant composition in the refrigerating cycle changes resulted in change of air conditioner characteristics or refrigerant over the specified standard amount is charged and an abnormal high pressure is applied to the inside of the refrigerating cycle resulted in cause of breakage or injury. Therefore if the refrigerant gas leaks, recover the refrigerant in the air conditioner, execute vacuuming, and then newly recharge the specified amount of liquid refrigerant. In this time, never charge the refrigerant over the specified amount. When recharging the refrigerant in the refrigerating cycle, do not mix the refrigerant or air other than R410A into the specified refrigerant. If air or others is mixed with the refrigerant, abnormal high pressure generates in the refrigerating cycle resulted in cause of injury due to breakage. After installation work, check the refrigerant gas does not leak. If the refrigerant gas leaks in the room, poisonous gas generates when gas touches to fire such as fan heater, stove or cooking stove though the refrigerant gas itself is innocuous. Never recover the refrigerant into the outdoor unit. When the equipment is moved or repaired, be sure to recover the refrigerant with recovering device. The refrigerant cannot be recovered in the outdoor unit; otherwise a serious accident such as breakage or injury is caused.
 Assembly / Wiring	After repair work, surely assemble the disassembled parts, and connect and lead the removed wires as before. Perform the work so that the cabinet or panel does not catch the inner wires. If incorrect assembly or incorrect wire connection was done, a disaster such as a leak or fire is caused at user's side.
 Insulator check	After the work has finished, be sure to use an insulation tester set (500 V Megger) to check the resistance is 1 MΩ or more between the charge section and the non-charge metal section (earth position). If the resistance value is low, a disaster such as a leak or electric shock is caused at user's side.
 Ventilation	If refrigerant gas has leaked during the installation work, ventilate the room immediately. If the leaked refrigerant gas comes in contact with fire, noxious gas may be generated.

 Compulsion	<p>When the refrigerant gas leaks, find up the leaked position and repair it surely. If the leaked position cannot be found up and the repair work is interrupted, pump-down and tighten the service valve, otherwise the refrigerant gas may leak into the room. The poisonous gas generates when gas touches to fire such as fan heater, stove or cooking stove though the refrigerant gas itself is innocuous. When installing equipment which includes a large amount of charged refrigerant such as a multi air conditioner in a sub-room, it is necessary that the density does not exceed the limit even if the refrigerant leaks. If the refrigerant leaks and exceeds the limit density, an accident of shortage of oxygen is caused.</p> <p>Tighten the flare nut with a torque wrench in the specified manner. Excessive tighten of the flare nut may cause a crack in the flare nut after a long period, which may result in refrigerant leakage.</p> <p>Nitrogen gas must be used for the airtight test.</p> <p>The charge hose must be connected in such a way that it is not slack.</p> <p>For the installation / moving / reinstallation work, follow to the Installation Manual. If an incorrect installation is done, a trouble of the refrigerating cycle, water leak, electric shock or fire is caused.</p>
 Check after repair	<p>Once the repair work has been completed, check for refrigerant leaks, and check the insulation resistance and water drainage. Then perform a trial run to check that the air conditioner is running properly.</p> <p>After repair work has finished, check there is no trouble. If check is not executed, a fire, electric shock or injury may be caused. For a check, turn off the power breaker.</p> <p>After repair work (installation of front panel and cabinet) has finished, execute a test run to check there is no generation of smoke or abnormal sound. If check is not executed, a fire or an electric shock is caused. Before test run, install the front panel and cabinet.</p> <p>Be sure to fix the screws back which have been removed for installation or other purposes.</p>
 Do not operate the unit with the valve closed.	<p>Check the following matters before a test run after repairing piping.</p> <ul style="list-style-type: none"> • Connect the pipes surely and there is no leak of refrigerant. • The valve is opened. <p>Running the compressor under condition that the valve closes causes an abnormal high pressure resulted in damage of the parts of the compressor and etc. and moreover if there is leak of refrigerant at connecting section of pipes, the air is sucked and causes further abnormal high pressure resulted in burst or injury.</p>
 Check after reinstallation	<p>Only a qualified installer or qualified service person is allowed to relocate the air conditioner. It is dangerous for the air conditioner to be relocated by an unqualified individual since a fire, electric shocks, injury, water leakage, noise and/or vibration may result.</p> <p>Check the following items after reinstallation.</p> <ol style="list-style-type: none"> 1) The earth wire is correctly connected. 2) The power cord is not caught in the product. 3) There is no inclination or unsteadiness and the installation is stable. <p>If check is not executed, a fire, an electric shock or an injury is caused.</p> <p>When carrying out the pump-down work shut down the compressor before disconnecting the refrigerant pipe. Disconnecting the refrigerant pipe with the service valve left open and the compressor still operating will cause air, etc. to be sucked in, raising the pressure inside the refrigeration cycle to an abnormally high level, and possibly resulting in injury, etc.</p>
 Cooling check	<p>When the service panel of the outdoor unit is to be opened in order for the compressor or the area around this part to be repaired immediately after the air conditioner has been shut down, set the circuit breaker to the OFF position, and then wait at least 10 minutes before opening the service panel. If you fail to heed this warning, you will run the risk of burning yourself because the compressor pipes and other parts will be very hot to the touch. In addition, before proceeding with the repair work, wear the kind of insulated heat-resistant gloves.</p> <p>Take care not to get burned by compressor pipes or other parts when checking the cooling cycle while running the unit as they get heated while running. Be sure to put on gloves providing protection for electric shock and heat.</p> <p>When the service panel of the outdoor unit is to be opened in order for the fan motor, reactor, inverter or the areas around these parts to be repaired immediately after the air conditioner has been shut down, set the circuit breaker to the OFF position, and then wait at least 10 minutes before opening the service panel. If you fail to heed this warning, you will run the risk of burning yourself because the fan motor, reactor, inverter heat sink and other parts will be very hot to the touch. In addition, before proceeding with the repair work, wear the kind of insulated heat-resistant gloves designed to protect electricians.</p>

 Installation	<p>Only a qualified installer or qualified service person is allowed to install the air conditioner. If the air conditioner is installed by an unqualified individual, a fire, electric shocks, injury, water leakage, noise and/or vibration may result.</p>
	<p>Before starting to install the air conditioner, read carefully through the Installation Manual, and follow its instructions to install the air conditioner.</p>
	<p>Be sure to use the company-specified products for the separately purchased parts. Use of non-specified products may result in fire, electric shock, water leakage or other failure. Have the installation performed by a qualified installer.</p>
	<p>Do not supply power from the power terminal block equipped on the outdoor unit to another outdoor unit. Capacity overload may occur on the terminal block and may result in fire.</p>
	<p>Do not install the air conditioner in a location that may be subject to a risk of exposure to a combustible gas. If a combustible gas leaks and becomes concentrated around the unit, a fire may occur.</p>
	<p>Use wiring that meets the specifications in the Installation Manual and the stipulations in the local regulations and laws. Use of wiring which does not meet the specifications may give rise to electric shocks, electrical leakage, smoking and/or a fire.</p>
	<p>Install a circuit breaker that meets the specifications in the installation manual and the stipulations in the local regulations and laws.</p>
	<p>Install the circuit breaker where it can be easily accessed by the qualified service person.</p>
	<p>If you install the unit in a small room, take appropriate measures to prevent the refrigerant from exceeding the limit concentration even if it leaks. Consult the dealer from whom you purchased the air conditioner when you implement the measures. Accumulation of highly concentrated refrigerant may cause an oxygen deficiency accident.</p>
	<p>Do not place any combustion appliance in a place where it is directly exposed to the wind of air conditioner, otherwise it may cause imperfect combustion.</p>

Explanations given to user

- If you have discovered that the fan grille is damaged, do not approach the outdoor unit but set the circuit breaker to the OFF position, and contact a qualified service person to have the repairs done.
Do not set the circuit breaker to the ON position until the repairs are completed.

Relocation

- Only a qualified installer or qualified service person is allowed to relocate the air conditioner.
It is dangerous for the air conditioner to be relocated by an unqualified individual since a fire, electric shocks, injury, water leakage, noise and/or vibration may result.
- When carrying out the pump-down work shut down the compressor before disconnecting the refrigerant pipe.
Disconnecting the refrigerant pipe with the service valve left open and the compressor still operating will cause air, etc. to be sucked in, raising the pressure inside the refrigeration cycle to an abnormally high level, and possibly resulting in injury, etc.

Declaration of Conformity

Manufacturer: Toshiba Carrier Air Conditioning (China) Co., Ltd.
Building 1, No.60, 21st Avenue and 2nd Floor, Building 3, No.235, 23st Avenue,
Baiyang Street, Hangzhou Economic and Technological Development Area, China.

TCF holder: TOSHIBA CARRIER EUROPE S.A.S
Route de Thil
01120 Montluel FRANCE

Hereby declares that the machinery described below:

Generic Denomination: Air Conditioner

Model / type: Outdoor unit
MCY-MHP0806HS8-E
MCY-MHP1006HS8-E
MCY-MHP0806HS8-TR
MCY-MHP1006HS8-TR

Complies with the provisions of the "Machinery" Directive (Directive 2006/42/EC) and the regulations transposing into national law

NOTE

This declaration becomes invalid if technical or operational modifications are introduced without the manufacturer's consent.

Specifications

Model	Sound pressure level (dBA)		Weight (kg)
	Cooling	Heating	
MCY-MHP0806HS8-E	58	59	147
MCY-MHP1006HS8-E	59	60	147
MCY-MHP0806HS8-TR	58	59	147
MCY-MHP1006HS8-TR	59	60	147

Product information of ecodesign requirements. (Regulation (EU) 2016/2281)
<http://ecodesign.toshiba-airconditioning.eu/en>

New refrigerant (R410A)

This air conditioner adopts a new HFC type refrigerant (R410A) which does not deplete the ozone layer.

1. Safety caution concerned to new refrigerant

The pressure of R410A is high 1.6 times of that of the former refrigerant (R22). Accompanied with change of refrigerant, the refrigerating oil has been also changed. Therefore, be sure that water, dust, the former refrigerant or the former refrigerating oil is not mixed into the refrigerating cycle of the air conditioner with new refrigerant during installation work or service work. If an incorrect work or incorrect service is performed, there is a possibility to cause a serious accident. Use the tools and materials exclusive to R410A to purpose a safe work.

2. Cautions on installation / service

(1) Do not mix the other refrigerant or refrigerating oil.

For the tools exclusive to R410A, shapes of all the joints including the service port differ from those of the former refrigerant in order to prevent mixture of them.

(2) As the use pressure of the new refrigerant is high, use material thickness of the pipe and tools which are specified for R410A.

(3) In the installation time, use clean pipe materials and work with great attention so that water and others do not mix in because pipes are affected by impurities such as water, oxide scales, oil, etc. Use the clean pipes.

Be sure to brazing with flowing nitrogen gas. (Never use gas other than nitrogen gas.)

(4) For the earth protection, use a vacuum pump for air purge.

(5) R410A refrigerant is azeotropic mixture type refrigerant. Therefore use liquid type to charge the refrigerant.

(If using gas for charging, composition of the refrigerant changes and then characteristics of the air conditioner change.)

3. Pipe materials

For the refrigerant pipes, copper pipe and joints are mainly used. It is necessary to select the most appropriate pipes to conform to the standard. Use clean material in which impurities adhere inside of pipe or joint to a minimum.

(1) Copper pipe

<Piping>

The pipe thickness, flare finishing size, flare nut and others differ according to a refrigerant type.

When using a long copper pipe for R410A, it is recommended to select "Copper or copper-base pipe without seam" and one with bonded oil amount 40 mg / 10 m or less. Also do not use crushed, deformed, discolored (especially inside) pipes. (Impurities cause clogging of expansion valves and capillary tubes.)

<Flare nut>

Use the flare nuts which are attached to the air conditioner unit.

(2) Joint

The flare joint and socket joint are used for joints of the copper pipe. The joints are rarely used for installation of the air conditioner. However clear impurities when using them.

4. Tools

(1) Required Tools for R410A

Mixing of different types of oil may cause a trouble such as generation of sludge, clogging of capillary, etc. Accordingly, the tools to be used are classified into the following three types.

- 1) Tools exclusive for R410A (Those which cannot be used for conventional refrigerant (R22))
- 2) Tools exclusive for R410A, but can be also used for conventional refrigerant (R22)
- 3) Tools commonly used for R410A and for conventional refrigerant (R22)

The table below shows the tools exclusive for R410A and their interchangeability.

Tools exclusive for R410A (The following tools for R410A are required.)

Explanation of symbols

△: Newly prepared (It is necessary to use it exclusively with R410A, separately from those for R22 or R407C.)

⊙: Former tool is available.

Used tools	Usage	Proper use of tools / parts
Gauge manifold	Vacuuming, charging refrigerant and operation check	△ Exclusive to R410A
Charging hose		△ Exclusive to R410A
Charging cylinder	Charging refrigerant	Unusable (Use the Refrigerant charging balance.)
Gas leak detector	Checking gas leak	△ Exclusive to R410A
Vacuum pump	Vacuum drying	Usable if a counter-flow preventive adapter is attached
Vacuum pump with counter-flow	Vacuum drying	⊙ R22 (Existing article)
Flare tool	Flare processing of pipes	⊙ Usable by adjusting size
Bender	Bending processing of pipes	⊙ R22 (Existing article)
Refrigerant recovery device	Recovering refrigerant	△ Exclusive to R410A
Torque wrench	Tightening flare nut	△ Exclusive to Ø12.7 mm and Ø15.9 mm
Pipe cutter	Cutting pipes	⊙ R22 (Existing article)
Refrigerant canister	Charging refrigerant	△ Exclusive to R410A Enter the refrigerate name for identification
Brazing machine / Nitrogen gas cylinder	Brazing of pipes	⊙ R22 (Existing article)
Refrigerant charging balance	Charging refrigerant	⊙ R22 (Existing article)

(Note 1) When flaring is carried out for R410A using the conventional flare tools, adjustment of projection margin is necessary. For this adjustment, a copper pipe gauge, etc. are necessary.

(Note 2) Charging cylinder for R410A is being currently developed.

General tools (Conventional tools can be used.)

In addition to the above exclusive tools, the following equipments which serve also for R22 are necessary as the general tools.

- | | |
|---|--|
| (1) Vacuum pump | (7) Screwdriver (+, -) |
| Use vacuum pump by attaching vacuum pump adapter. | (8) Spanner or Monkey wrench |
| (2) Torque wrench | (9) Hole core drill |
| (3) Pipe cutter | (10) Hexagon wrench (Opposite side 4 mm) |
| (4) Reamer | (11) Tape measure |
| (5) Pipe bender | (12) Metal saw |
| (6) Level vial | |

Also prepare the following equipments for other installation method and run check.

- | | |
|-----------------|----------------------------------|
| (1) Clamp meter | (3) Insulation resistance tester |
| (2) Thermometer | (4) Electro-scope |

1 Product summary

1-1. Outdoor unit

For Europe and Turkey model

Power supply	Corresponding HP	
	8HP	10HP
Power supply Three-phase 380-415V (50Hz)	MCY-MHP0806HS8-E MCY-MHP0806HS8-TR	MCY-MHP1006HS8-E MCY-MHP1006HS8-TR
Cooling capacity (kW) *1	22.4	28.0
Heating capacity (kW) *1	22.4	28.0

For China model

Power supply	Corresponding HP		
	8HP	9HP	10HP
Power supply Three-phase 380 (50Hz)	MCY-MHP0806HT8-C*	MCY-MHP0906HT8-C*	MCY-MHP1006HT8-C*
Cooling capacity (kW) *1	25.0	26.5	28.0
Heating capacity (kW) *1	28.0	29.5	31.5

*1 Rated conditions

Cooling: Indoor air temperature 27 °C DB / 19 °C WB,

Outdoor air temperature 35 °C DB

Heating: Indoor air temperature 20 °C DB,

Outdoor air temperature 7 °C DB / 6 °C WB

1-2. Connectable indoor units

Model type	Model name
4-way Cassette	MMU-*P****HY*, MMU-AP****HP*
Compact 4-way Cassette	MMU-*P****MH*
2-way Cassette	MMU-*P****WH*
1-way Cassette	MMU-*P****YH*
	MMU-*P****SH*
Concealed Duct Standard	MMD-AP****BH*
	MMD-*P****BHY*, MMU-AP****BHP*
Concealed Duct High Static Pressure MMD	MMD-AP****H*
	MMD-*P****HP*
Slim Duct	MMD-AP****S(P)H*
Compact Slim duct	MMD-*P****M(P)H*
	MMD-*P****M(P)HY*
Ceiling	MMC-AP****H*
	MMC-*P****HP*
Floor Standing Cabinet	MML-*P****H*
Floor Standing Concealed	MML-*P****BH*
Floor Standing	MMF-*P****H*
High Wall	MMK-AP****H*
	MMK-*P****HP*
Console	MML-*P****NH(P)*
HWM	MMW-*P****LQ*

* For details on these models, read the owner's manuals that come with the indoor units.

1-3. Branching joints and headers

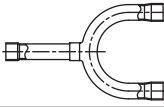
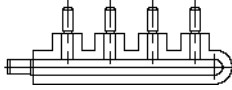
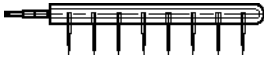
	Model name	Appearance
Y-shape branching joint	RBM-BY55E RBM-BY105E	
4-branching header	RBM-HY1043E	
8-branching header	RBM-HY1083E	

1-4. PMV kit

Model type	Indoor unit capacity type	Appearance
RBM-PMV0363E, RBM-PMV0361U-E	005 to 014 type	
RBM-PMV0903E, RBM-PMV0901U-E	015 to 027 type	

2 Construction views

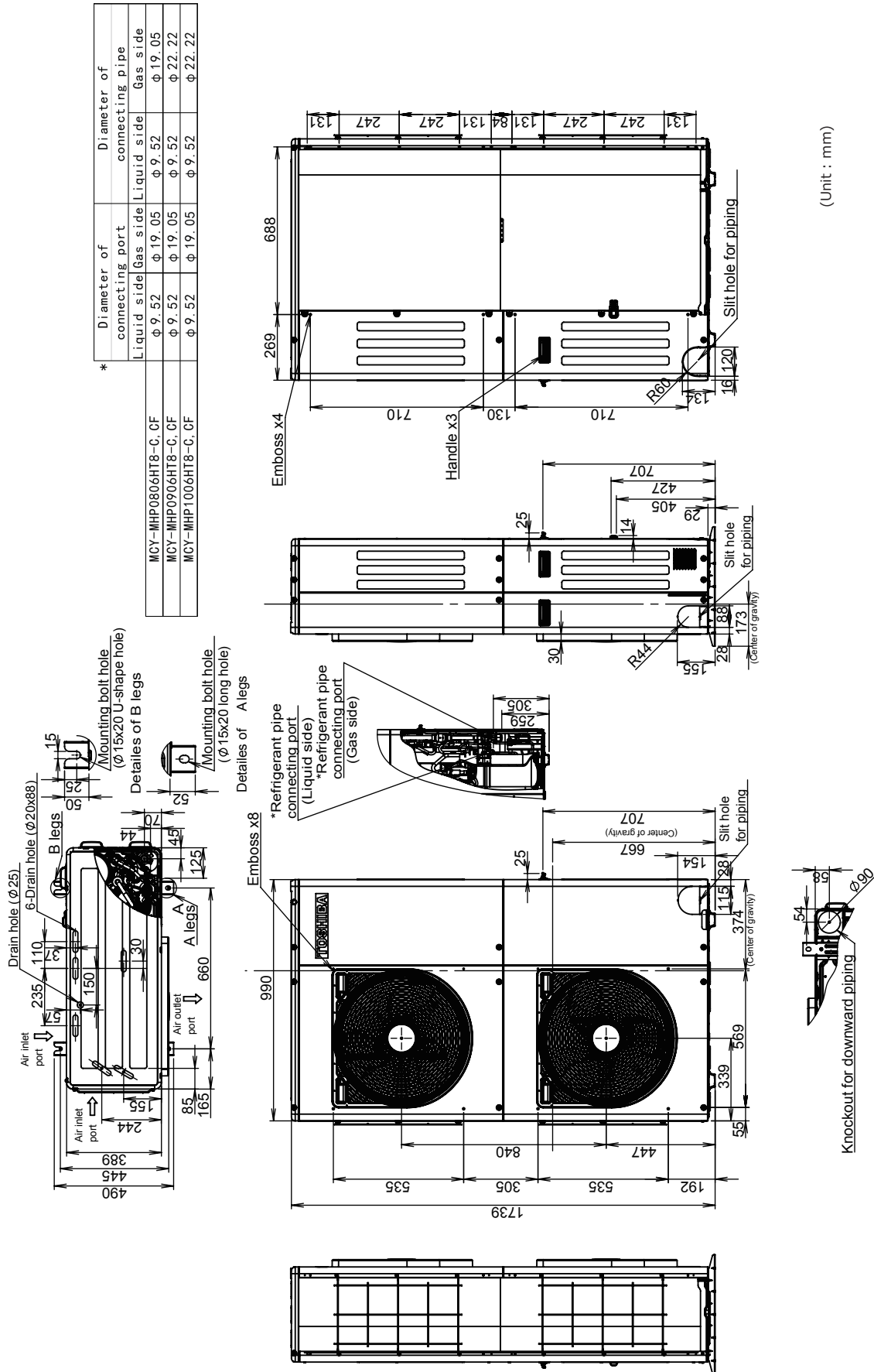

(Unit : mm)

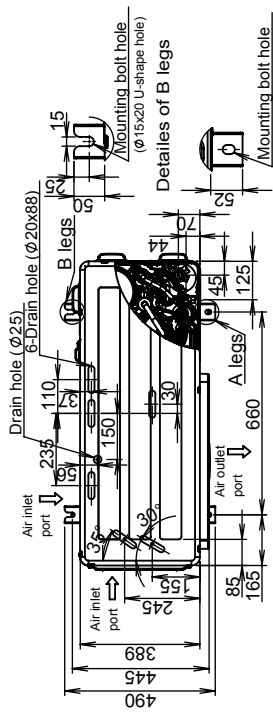

	* Diameter of connecting port		Diameter of connecting pipe	
	Liquid side	Gas side	Liquid side	Gas side
MCY-MHP0806HS8-E	φ 9.52	φ 19.05	φ 9.52	φ 19.05
MCY-MHP1006HS8-E	φ 9.52	φ 19.05	φ 9.52	φ 22.22
MCY-MHP0806HS8-TR	φ 9.52	φ 19.05	φ 9.52	φ 19.05
MCY-MHP1006HS8-TR	φ 9.52	φ 19.05	φ 9.52	φ 22.22

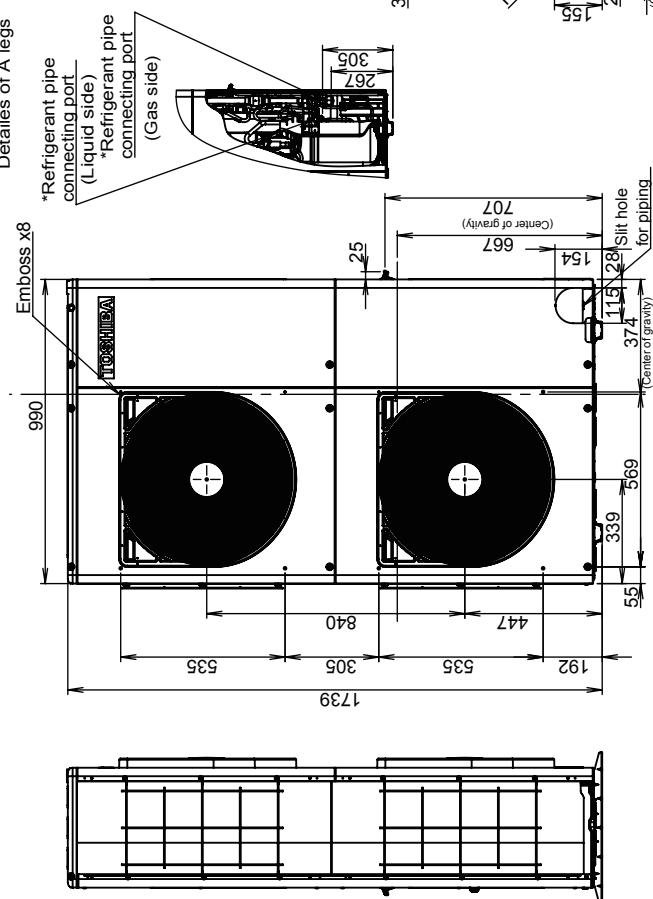

(Unit : mm)

3 Wiring diagram

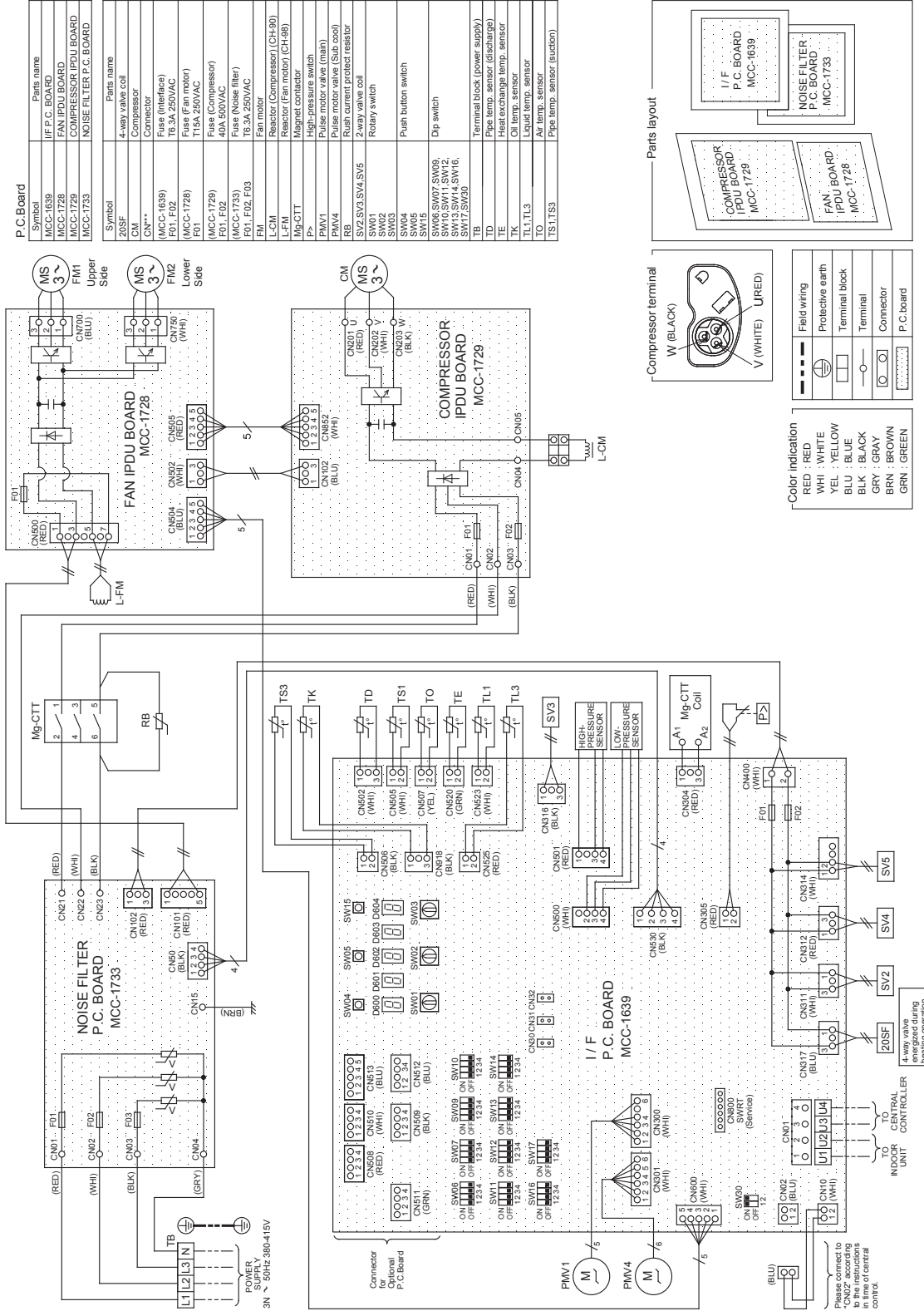

Color indication

RED	RED
WHI	WHITE
YEL	YELLOW
BLK	BLACK
GRY	GRAY
BRN	BROWN
GRN	GREEN

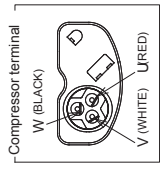

---	Field wiring
⊕	Protective earth
□	Terminal block
○	Terminal
⊞	Connector
⋯	P.C. board

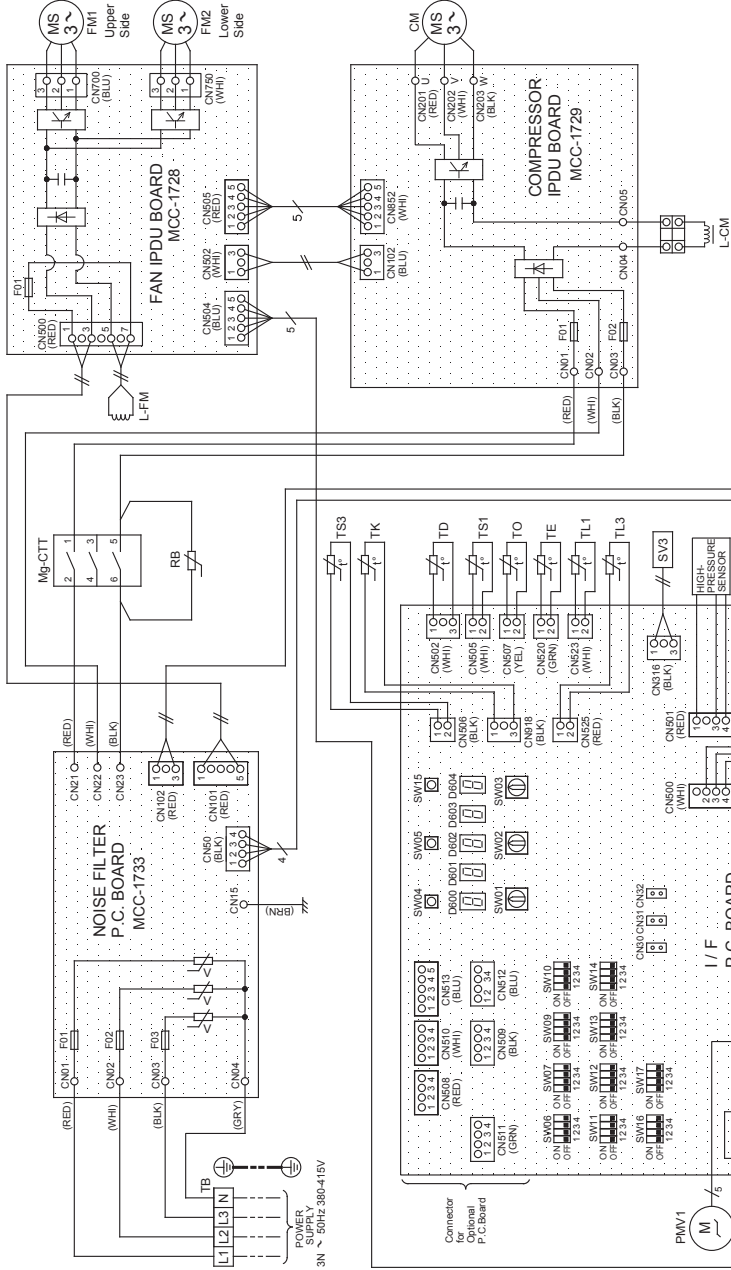

4 Parts rating

4-1. Outdoor unit

No.	Name	Model	Specification
1	Compressor	RA641A3TB-22M	Output: 5.60 kW
2	4-way valve coil	SQ-A2522G-000371	AC220-240V, 50/60Hz
3	SV2, SV4, SV5 valve coil	FQ-G593	AC220-240V, 50/60Hz
4	SV3 valve coil	TEV-SMOAJ2170A1	AC220-240V, 50Hz
5	Pulse motor valve coil	PAM-MD12TF-1	DC12V
6	Pulse motor valve coil 4	PQ-M10012-000441	DC12V
7	Pressure sensor (For high pressure)	YCQB04H02	DC5V 0-3.92MPa
		AAG-M35YLTF-1	DC5V 0-3.73MPa
8	Pressure sensor (For low pressure)	YCQB01H01	DC5V 0-0.98MPa
		AAG-L25YLTF-1	DC5V 0-0.98MPa
9	High-pressure SW	ACB-4UB154W	OFF:4.15MPa ON:3.2MPa
10	Fan motor	ICF-280-A100-1	DC280-340V/100W

4-2. Outdoor inverter

No.	Name	Model	Specification
1	Power supply terminal block	JXO-6004	AC600V/75A, 4P
2	Communication terminal block (MCC-1639)	HP-T4053-1-4PS2	AC30V (or no more than DC42V)/1A, 4P (P.C. board)
3	Reactor (For comp.)	CH-90-Z	2.9 ± 0.29mH/25A
4	Interface P.C. board	MCC-1639	—
5	A3-IPDU P.C. board	MCC-1729	—
6	Fuse (MCC-1729)	GAC1-40A:P	40A/500VAC (P.C. board)
7	Comp. motor drive IPM (MCC-1729)	PSS50SA2FT	50A/1200V (P.C. board)
8	Fan-IPDU P.C. board	MCC-1728	—
9	Fuse (MCC-1728)	GDT250V15A-A	15A/AC250V (P.C. board)
10	Fan motor drive IPM (MCC-1728)	6MBP10XSH060-50-F2	10A/600V (P.C. board)
11	Noise filter P.C. board	MCC-1733	—
12	Line filter (MCC-1733)	RC4V4735-006PF12	35A/AC500V (P.C. board)
13	Magnet switch	FC-1S-Z675	30A/AC440V
14	PTC thermistor	MZ32-101RMARD01E-A	AC500V/13A
15	Pipe temp. sensor (TD)	—	-30°C ~ 130°C (Ambient temp. range)
16	Pipe temp. sensor (TS1)	—	-20°C ~ 80°C (Ambient temp. range)
17	Pipe temp. sensor (TE)	—	-20°C ~ 80°C (Ambient temp. range)
18	Pipe temp. sensor (TO)	—	-20°C ~ 80°C (Ambient temp. range)
19	Pipe temp. sensor (TL1)	—	-20°C ~ 80°C (Ambient temp. range)
20	Pipe temp. sensor (TL3)	—	-20°C ~ 80°C (Ambient temp. range)
21	Pipe temp. sensor (TS3)	—	-20°C ~ 80°C (Ambient temp. range)
22	Reactor (for fan)	CH-98-Z	18.0 ± 1.27mH/5A
23	Pipe temp. sensor (TK)	—	-30°C ~ 130°C (Ambient temp. range)

4-3. Parts layout in outdoor unit

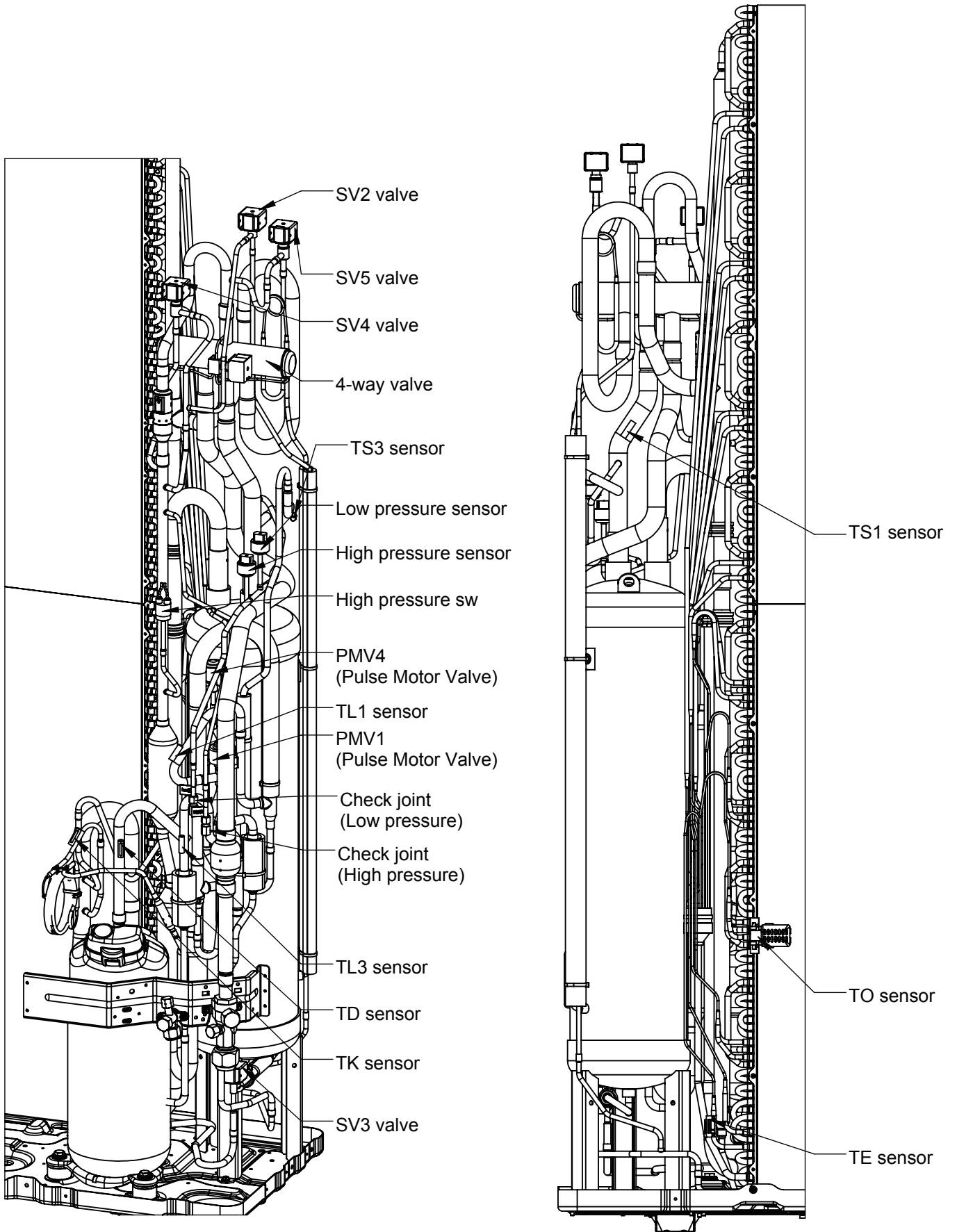

4-4. Parts layout in inverter assembly

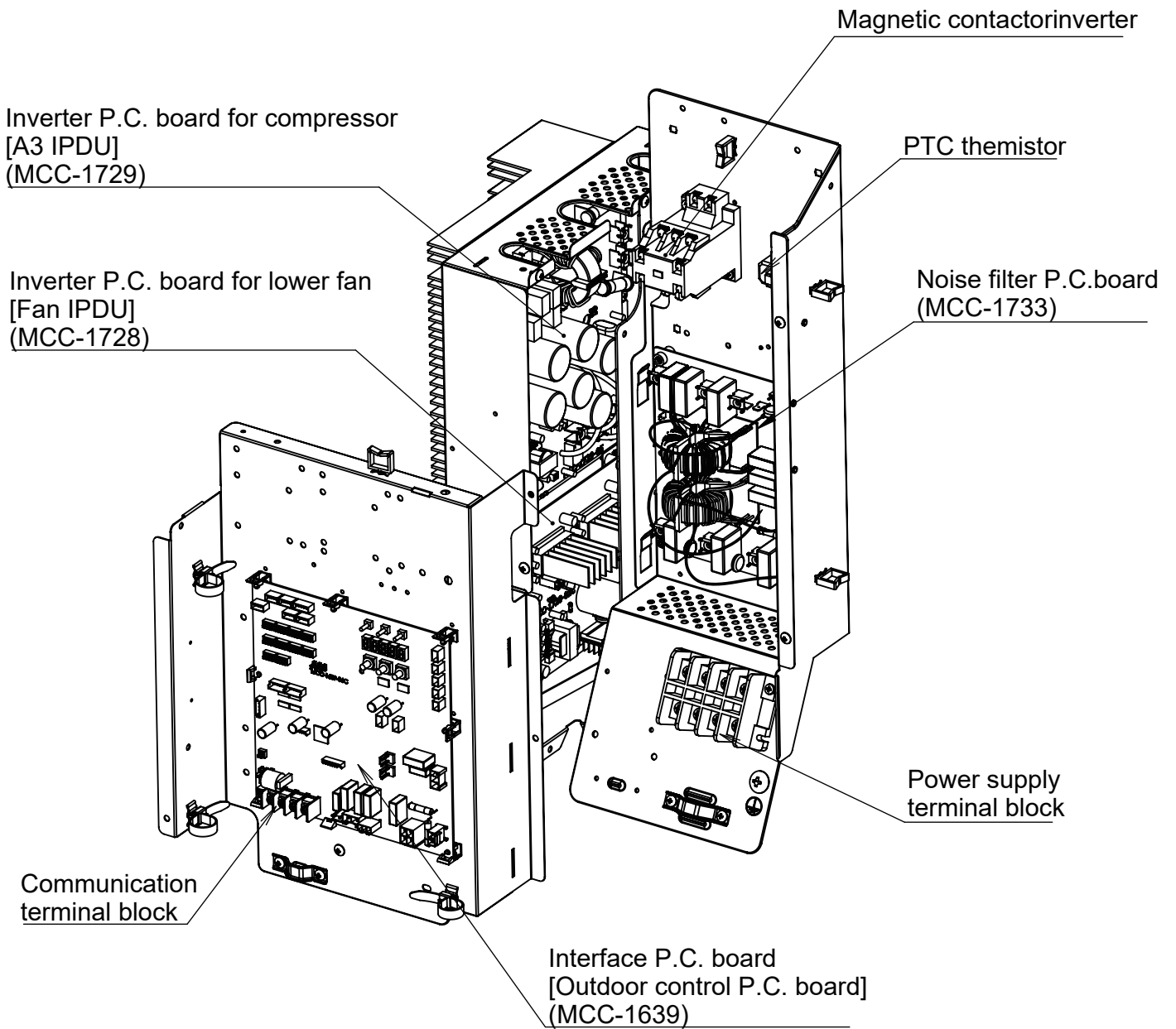

4-5. Outdoor (inverter) print circuit board

4-5-1. Interface P.C. board (MCC-1639)

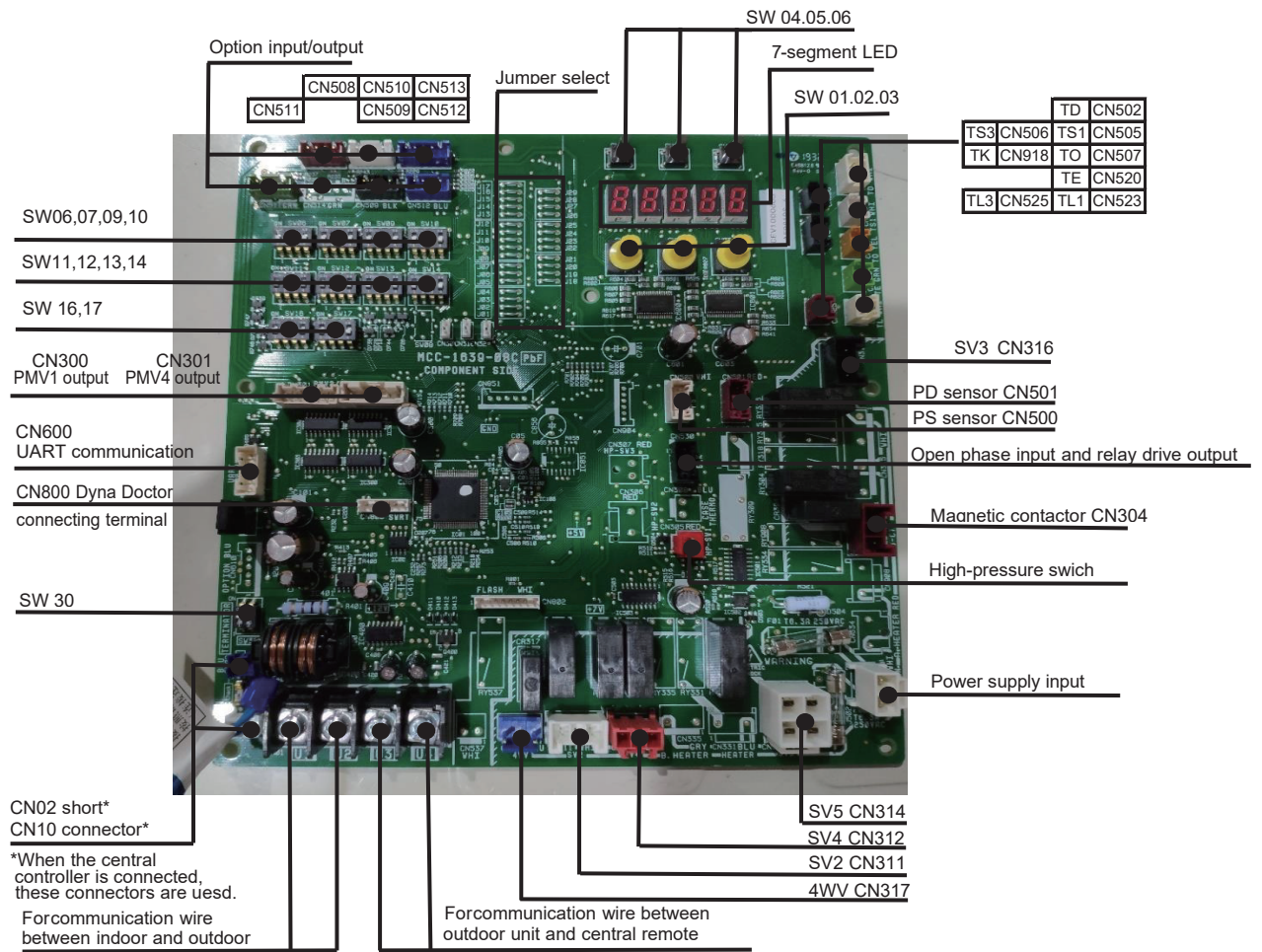

4-5-2. Inverter P.C. board for compressor (MCC-1729) A3-IPDU

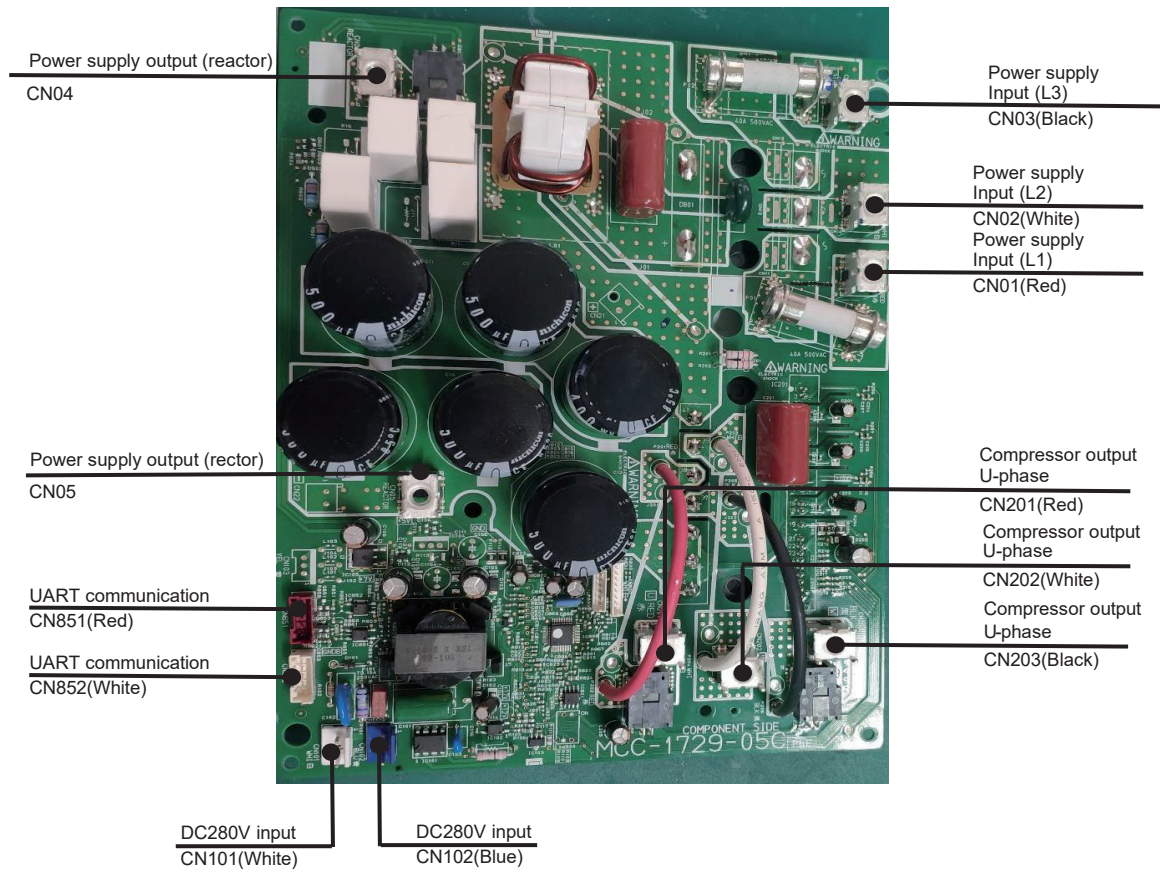

4-5-3. Fan motor IPDU (MCC-1728)

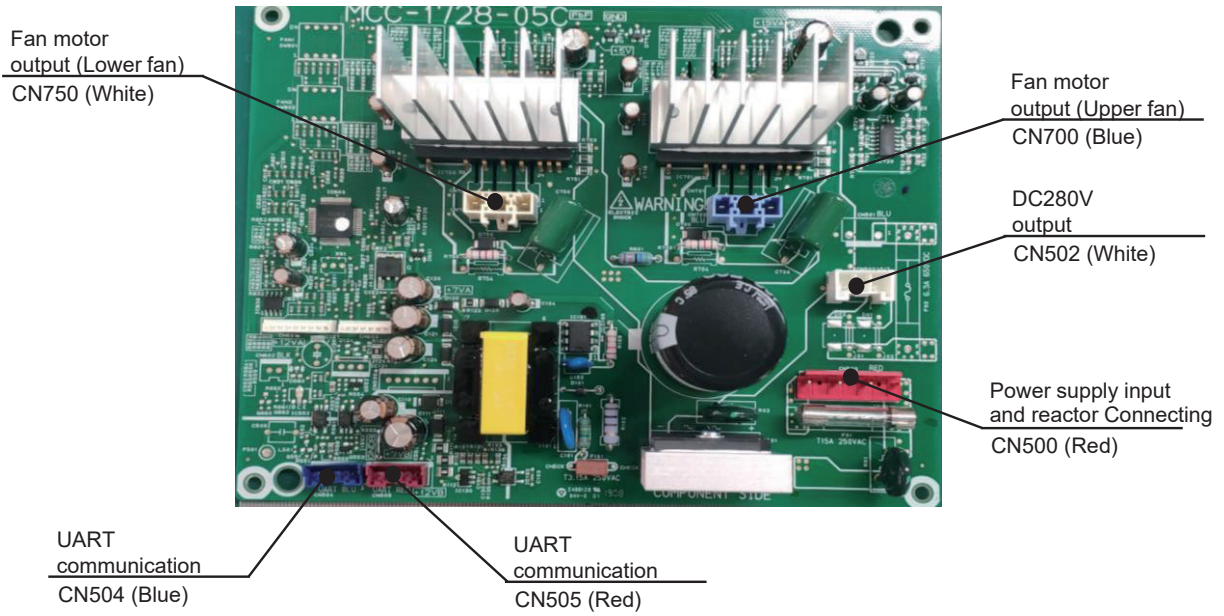

4-5-4. Noise filter (MCC-1733)

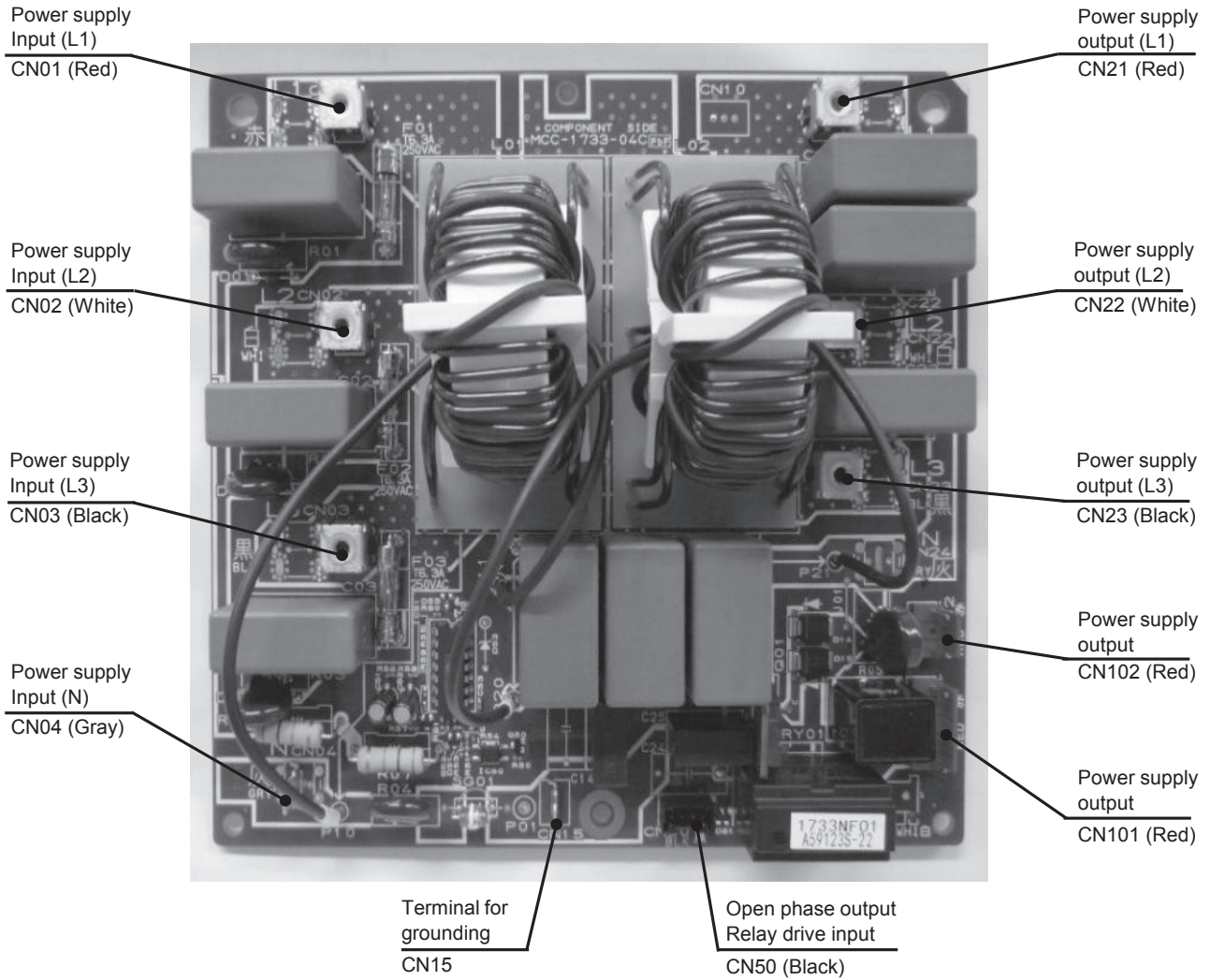

5 Refrigerant piping systematic drawing

Outdoor unit

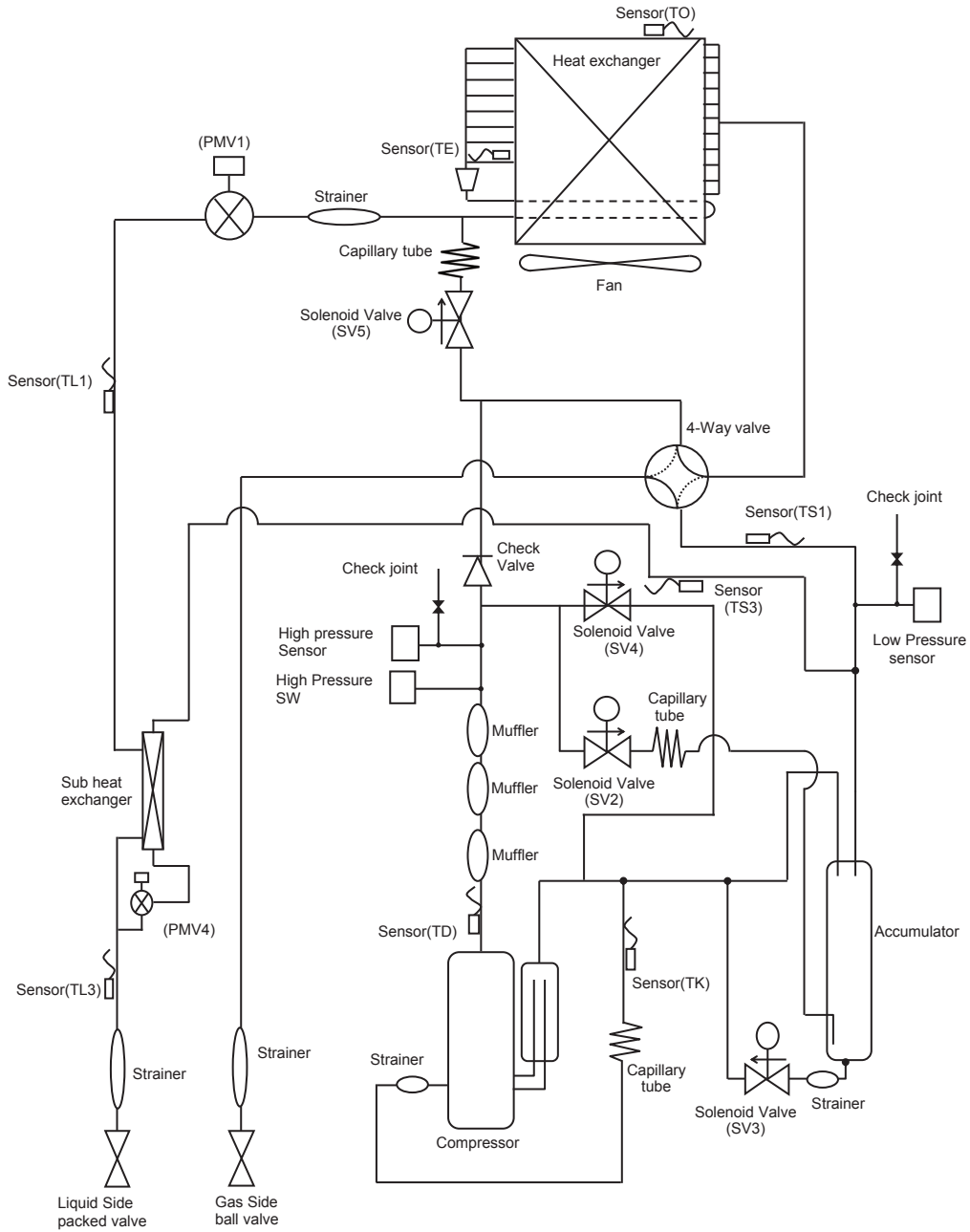

Explanation of functional parts

Functional part name		Functional outline
Solenoid valve	SV2	(Hot gas bypass) (Connector CN311 : White) 1) Low pressure release function 2) High pressure release function 3) Gas balance function during stop time 4) Hot gas bypass into accumulator
	SV3	(Connector CN316: Black) 1) For returning oil to compressor
	SV4	(Start compensation valve of compressor) (Connector CN312: Red) 1) For gas balance start 2) High pressure release function 3) Low pressure release function
	SV5	(Connector CN314: White) 1) Preventive function for high pressure rising in heating operation
4-way valve		(Connector CN317: Blue) 1) Cooling / heating exchange 2) Reverse defrost
Pulse motor valve	PMV1	(Connector CN300: White) 1) Super heat Control function in heating operation 2) Liquid line shut-down function while follower unit stops 3) Subcool adjustment function in cooling operation
	PMV4	(Connector CN301: White) 1) Super heat Control function or Subcool adjustment function only in cooling operation 2) Liquid bypass function for discharge temperature release (cooling bypass function)
Temp. sensor	TD	(Connector CN502: White) 1) Protection of compressor discharge temp. 2) Used for discharge temperature release
	TS1	(Connector CN505: White) 1) Controls PMV1 super heat in heating operation
	TS3	(Connector CN 506: Black) 1) Controls PMV4 super heat in cooling operation
	TE	(Connector CN520: Green) 1) Controls defrost in heating operation 2) Controls outdoor fan in heating operation
	TL1,TL3	TL1 Connector CN 523: White TL3 Connector CN 525: Red 1) Detects subcool in cooling operation
	TO	(Connector CN507: Yellow) 1) Detects outside temperature
Pressure sensor	TK	(Connector CN918: Black) 1) Judges oil level of the compressor
	High pressure sensor	(Connector CN501: Red) 1) Detects high pressure and controls compressor capacity 2) Detects high pressure in cooling operation, and controls the fan in low ambient cooling operation 3) Detects subcool in indoor unit in heating operation
	Low pressure sensor	(Connector CN500: White) 1) Detects low pressure in cooling operation, and controls compressor capacity 2) Detects low pressure in heating operation, and controls the super heat
High pressure switch (4.15MPa)	High pressure SW	(Connector CN305: RED) 1) Piping resisting pressure protection

6 Control outline

Outdoor unit

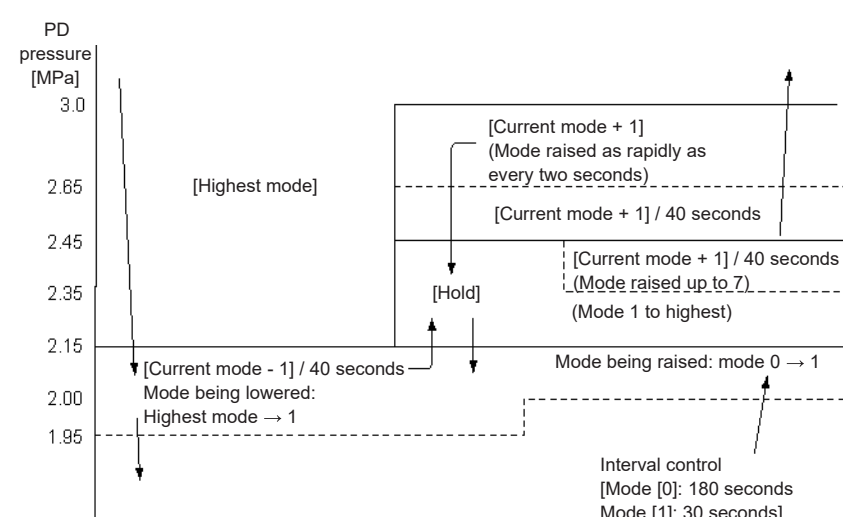
Item	Description of operation, numerical data, and other information	Remarks
<p>1. Pulse motor valve (PMV) control</p>	<p>1) PMV1 control</p> <ul style="list-style-type: none"> During air conditioner operation, the pulse count of the PMV1 (pulse motor valve1) is controlled between 100 and 3000. During cooling, the PMV1 opening is controlled on the basis of measurements provided by the TL1 temperature sensor and the PD pressure sensor (subcool control). During heating, the PMV1 opening is controlled on the basis of measurements provided by the TS1 and TD temperature sensors and the PS pressure sensor (super heat control). <p>2) PMV4 control (cooling only)</p> <ul style="list-style-type: none"> During cooling, the pulse count of the PMV4 (pulse motor valve 4) is controlled between 30pls and 500pls. <p>The PMV4 opening is controlled on the basis of measurements provided by the TL3 temperature sensor and PD pressure sensor (Subcool control), or TS3 temperature sensor and PS pressure sensor (Superheat control).</p> <p>3) PMVs are fully closed when the air conditioner is in thermostat OFF state or upon being turned off normally or shut down due to an abnormality.</p>	
<p>2. Outdoor fan control</p>	<p>1. Cooling fan control</p> <p>1) Outdoor fan speed (mode) is controlled on the basis of measurements provided by the PD pressure sensor.</p> <p>2) For a specified period after the start of cooling operation, the outdoor unit controls outdoor fan speed (mode) on the basis of measurements provided by the PD pressure sensor.</p>  <p>* Available control modes are 0 (at rest) to 31.</p>	<ul style="list-style-type: none"> The fan speed corresponding to the highest mode varies with the HP capacity of the outdoor unit.

Item	Description of operation, numerical data, and other information	Remarks												
2. Outdoor fan control (continued)	<p>2. Heating fan control</p> <p>1) Outdoor fan speed (mode) is controlled on the basis of measurements provided by the TE temperature sensor.</p> <p>2) If TE > 25 °C is continuously detected for 5 minutes, the operation may stop.</p> <p>3) For a specified period after air conditioner startup and during defrosting, this control is disabled.</p> <p>4) When refrigerant is in extremely short supply, this control may cause the air conditioner to be repeatedly turned on and off.</p> <table border="1" data-bbox="319 436 1141 734"> <tr> <td data-bbox="319 436 475 481">TE temperature (°C)</td> <td data-bbox="475 436 1141 504">Zone A: Lowest mode, timer count for forced compressor shutdown</td> </tr> <tr> <td data-bbox="319 504 475 548">25</td> <td data-bbox="475 504 1141 548">Zone B: -2/20 seconds (down to lowest mode)</td> </tr> <tr> <td data-bbox="319 548 475 593">8</td> <td data-bbox="475 548 1141 593">Zone C: -1/20 seconds (down to lowest mode)</td> </tr> <tr> <td data-bbox="319 593 475 638">6</td> <td data-bbox="475 593 1141 638">Zone D: Hold (staying at current mode)</td> </tr> <tr> <td data-bbox="319 638 475 683">4</td> <td data-bbox="475 638 1141 683">Zone E: +1/20 seconds (up to highest mode)</td> </tr> <tr> <td data-bbox="319 683 475 728">2</td> <td data-bbox="475 683 1141 728">Zone F: Highest mode</td> </tr> </table>	TE temperature (°C)	Zone A: Lowest mode, timer count for forced compressor shutdown	25	Zone B: -2/20 seconds (down to lowest mode)	8	Zone C: -1/20 seconds (down to lowest mode)	6	Zone D: Hold (staying at current mode)	4	Zone E: +1/20 seconds (up to highest mode)	2	Zone F: Highest mode	<ul style="list-style-type: none"> The fan speed corresponding to the highest mode varies with the HP capacity of the outdoor unit.
TE temperature (°C)	Zone A: Lowest mode, timer count for forced compressor shutdown													
25	Zone B: -2/20 seconds (down to lowest mode)													
8	Zone C: -1/20 seconds (down to lowest mode)													
6	Zone D: Hold (staying at current mode)													
4	Zone E: +1/20 seconds (up to highest mode)													
2	Zone F: Highest mode													
3. Capacity control	The compressor is controlled on the basis of capacity demand issued by indoor controllers.													
4. Oil level detection control	1) Judgment as to whether an optimum amount of oil is present in the compressor case is made on the basis of the temperature readings of sensor TK.													
5. Low oil level protection control	<p>This control function is aimed at preventing compressor of the outdoor unit from running out of oil, and is basically performed by opening/closing solenoid valve SV3. There are three control patterns as described below.</p> <p>1. Preparatory control If the oil level judgment result in the memory is continued to be "low" for 120 seconds, SV3 is turned on.</p> <p>2. Oil recovery control This control function is performed if the oil level judgment result is continued to be "low" for 15 minutes. (Item 6.)</p> <p>3. Oil depletion protection control This control function is performed if the oil level don't become an optimum level after oil recovery control. In concrete terms, if the oil level judgment result is continued to be "low" for 30 minutes, the unit is brought to a protective shutdown, followed by a restart 2 minutes and 30 seconds later. If protective shutdown is repeated once more, the trouble is confirmed as final. (There will be no more restarts.) The check code is "H07".</p>	<ul style="list-style-type: none"> This protective control is performed when the oil level judgment result is continued to be "low" for a long time. 												
6. Refrigerant / Oil recovery control	<p>1. Cooling oil (refrigerant) recovery control</p> <p>During cooling operation, this control function is executed to recover the oil from the indoor units and connecting pipe-work back to the outdoor unit. It is also executed to prevent the accumulation of refrigerant in outdoor heat exchangers while cooling operation is under low outside air temperature conditions.</p> <p>1) Control conditions</p> <ul style="list-style-type: none"> When cooling operation has started (compressor has just been turned on, though this does not always happen depending on outside air temperature conditions). When the oil level judgment result is continued to be "low" for 15 minutes. <p>2) Control details</p> <ul style="list-style-type: none"> Compressor is operated at the oil recovery control mode speed. Indoor units are set to the cooling oil (refrigerant) recovery control mode, with their indoor PMVs opened to a certain degree. After recovery control is performed for a specified period, it is terminated, and cooling operation resumes. The recovery period lasts for approximately 2 or 3 minutes though this is dependent on the system capacity. 													

Item	Description of operation, numerical data, and other information	Remarks
<p>6. Refrigerant / Oil recovery control (continued)</p>	<p>2. Heating refrigerant (oil) recovery control During heating operation, this control function is executed to recover liquid refrigerant from indoor units. It is also executed to recover indoor/outdoor refrigerant after defrosting and to recover oil in outdoor heat exchangers during heating overload operation.</p> <p>1) Control conditions</p> <ul style="list-style-type: none"> • When heating operation has started (compressors have just been turned on) • When heating operation resumes after defrosting. • When the oil level judgment result is continued to be “low” for 15 minutes. <p>2) Control details</p> <ul style="list-style-type: none"> • Compressor is operated at the refrigerant recovery control mode speed. • Indoor units are set to the heating refrigerant (oil) recovery control mode, with their indoor PMVs opened to a certain degree. • After completion of refrigerant recovery for all the indoor units, heating operation resumes. • The recovery period lasts for approximately 2 to 10 minutes though this is dependent upon the operated condition. 	
<p>7. Defrosting control (reverse defrosting method)</p>	<p>1. Defrosting commencement conditions</p> <p>1) After the heating operation commences, the value detected for the TE sensor temperature between 10 and 20 minutes, the value detected for the To sensor temperature, the rotation speed of the compressor, and the super heat value are saved, and the estimated evaporation temperature for conditions without frost formation is calculated.</p> <p>2) After the heating operation runs for 40 minutes, the defrosting control engages when the value detected for the TE sensor temperature falls below the cumulative TE temperature during the heating operation, and the frost formation rate calculated from the estimated evaporation temperature for conditions without frost formation, the value detected for the TE sensor temperature during the heating operation, and the detection value of the To sensor temperature exceeds a certain level.</p> <p>3) In addition to (2) above, the total operation time is calculated when the value detected for the TE sensor temperature falls below the cumulative TE temperature during the heating operation, and the defrosting control engages after 180 minutes. (The cumulative operation time is 25 minutes right after startup or right after changeover from the cooling to the heating operation.)</p> <p>2. Details of defrosting control</p> <p>1) The compressor currently in operation is operated at the standby operation speed.</p> <p>2) When a specified amount of time passes from the time the compressor reached the standby operation speed, the outdoor fans are turned off by closing the 4-way valves.</p> <p>3) The compressor operates at the target rotational speed for defrosting control.</p> <p>3. Defrosting termination conditions</p> <ul style="list-style-type: none"> • Defrosting termination conditions are met when the TE temperature sensor measurement reaches a specified value (roughly 12 °C) a certain period of time after the commencement of defrosting control. In that event, defrosting termination control takes over. <p>4. Details of defrosting termination control</p> <p>1) Compressor is operated at the standby operation speed.</p> <p>2) When a specified amount of time passes, the 4-way valve is opened.</p> <p>3) Indoor heating refrigerant recovery control is performed. For control details, see “6. Refrigerant / Oil recovery control”.</p>	<ul style="list-style-type: none"> • Frost formation temperature is -1.5 °C. • To protect the refrigerating cycle circuit, the fan mode may be controlled during defrosting. • During defrosting control, compressor is controlled so that its speed does not exceed 77.0 rps.

Item	Description of operation, numerical data, and other information	Remarks
8. Release valve control	<p>1. SV2 gas balance control This control function is aimed at achieving gas balance by opening SV2 while compressor is turned off so as to reduce its startup load the next time it is turned on.</p> <p>1) Control conditions</p> <ul style="list-style-type: none"> • The compressor has been turned off. <p>2) Control details</p> <ul style="list-style-type: none"> • The control point is changed according to ΔP (PD pressure - PS pressure) registered just before the compressor was turned off. • When $\Delta P \geq 1.3 \text{ MPa}$, SV2 is opened. When this results in $\Delta P \leq 1.1 \text{ MPa}$, SV2 is closed. • When $\Delta P \leq 1.3 \text{ MPa}$, SV2 is closed. <p>2. SV2 high pressure release control (Heating) This control function is aimed at mitigating pressure rise while a compressor is in operation at low speeds.</p> <p>1) Control conditions</p> <ul style="list-style-type: none"> • Heating operation is in progress (except periods of defrosting control). • A speed of the compressor is in operation at low speeds of up to 77 rps. <p>2) Control details</p> <ul style="list-style-type: none"> • When PD pressure becomes $\geq 3.4 \text{ MPa}$, SV2 is opened. • When PD pressure becomes $\leq 2.8 \text{ MPa}$, SV2 is closed. <p>3) Termination conditions</p> <ul style="list-style-type: none"> • Shutdown, thermostat OFF, defrosting operation, or cooling operation. • The speed of the compressor rises to 82 rps or more. <p>3. SV2 high pressure release control (Cooling) This control function is aimed at mitigating pressure rise.</p> <p>1) Control conditions</p> <ul style="list-style-type: none"> • Cooling operation is in progress. <p>2) Control details</p> <ul style="list-style-type: none"> • When PD pressure becomes $\geq 3.8 \text{ MPa}$, SV2 is opened. • When PD pressure becomes $\leq 3.6 \text{ MPa}$, SV2 is closed. <p>3) Termination conditions</p> <ul style="list-style-type: none"> • Shutdown, thermostat OFF, or heating operation. <p>4. SV2 low pressure release control This control function is aimed at preventing a rapid fall in pressure during transient operation. The control is always provided except during periods of stoppage or thermostat OFF.</p> <p>1) Control details (heating)</p> <ul style="list-style-type: none"> • When PS pressure becomes $\leq 0.1 \text{ MPa}$, SV2 is opened. • When PS pressure becomes $\geq 0.2 \text{ MPa}$, SV2 is closed. <p>2) Control details (cooling)</p> <ul style="list-style-type: none"> • When PS pressure becomes $\leq 0.14 \text{ MPa}$, SV2 is opened. • When PS pressure becomes $\geq 0.24 \text{ MPa}$, SV2 is closed. <p>5. SV4 low pressure release control This control function is aimed at providing low pressure protection.</p> <p>1) Control details (heating) When PS pressure becomes $\leq 0.1 \text{ MPa}$, SV4 is opened; when PS pressure becomes $\geq 0.2 \text{ MPa}$, SV4 is closed.</p> <p>2) Control details (cooling) When PS pressure and PD pressure become $< 0.14 \text{ MPa}$ and $< 1.7 \text{ MPa}$, respectively, SV4 is opened; when PS pressure and PD pressure become $\geq 0.22 \text{ MPa}$ and $\geq 1.9 \text{ MPa}$, respectively, SV4 is closed.</p> <p>6. SV5 high pressure release control This control function is aimed at mitigating pressure rise.</p> <p>1) Control details (heating) When PD pressure and compressor speed become $\geq 3.4 \text{ MPa}$ and $\leq 38 \text{ rps}$, respectively, SV5 is opened; when PD pressure becomes $\geq 2.7 \text{ MPa}$, or compressor speed $\geq 42 \text{ rps}$, SV5 is closed.</p>	

Item	Description of operation, numerical data, and other information	Remarks												
9. Frequency release control	<p>High pressure release control This function is to correct the operation command of the compressor and suppress the rise of high pressure.</p> <p>1. Cooling frequency release control</p> <p>1)Control contents The operation frequency is decreased by 1 step when PD pressure ≥ 3.8 MPa. It is decreased by 1 step every 1 seconds until PD pressure drops below 3.8 MPa.</p> <p>2)Release condition</p> <ul style="list-style-type: none"> • When PD pressure ≤ 3.6 MPa • Stop, thermostat OFF. <p>2. Heating frequency release control</p> <p>1)Control contents The operation frequency is decreased by 1 step when PD pressure ≥ 3.4 MPa. It is decreased by 1 step every 10 seconds until PD pressure drops below 3.4 MPa.</p> <p>2)Release condition</p> <ul style="list-style-type: none"> • When PD pressure ≤ 3.2 MPa • When refrigerant recovery control starts in all heating mode • During defrost operation, stop, thermostat OFF. 													
10. A3-IPDU control	<p>IPDU controls inverter compressor by issuing commands relating to compressor speeds, speed increases / decreases, and current release control values via the interface P.C. board.</p> <p>The main control functions of the IPDU P.C. board are described below.</p> <p>1. Current release control</p> <p>To prevent inverter input current from exceeding the specified value, output frequency is controlled with AC input current as detected by T611 mounted on the A3-IPDU P.C. board.</p> <div style="text-align: center;"> <p>The graph plots Current on the vertical axis. Two horizontal dashed lines are labeled I₁ and I₂. A solid line represents the operating frequency. The graph is divided into four zones: Zone A (normal operation), Zone D (frequency maintained), Zone B (frequency lowered), and Zone C (frequency lowering halted).</p> </div> <p>Zone A: Compressor is operated normally. Zone D: The current operating frequency is maintained. Zone B: Operating frequency is lowered. Zone C: The lowering of operating frequency is halted to maintain the current frequency.</p> <p>Current control values for various outdoor units are shown below.</p> <table border="1" data-bbox="534 1422 901 1579"> <thead> <tr> <th>Outdoor unit HP capacity</th> <th>I₁</th> <th>I₂</th> </tr> </thead> <tbody> <tr> <td>8</td> <td>17.0</td> <td>16.5</td> </tr> <tr> <td>9</td> <td>18.5</td> <td>18.0</td> </tr> <tr> <td>10</td> <td>20.0</td> <td>19.5</td> </tr> </tbody> </table>	Outdoor unit HP capacity	I ₁	I ₂	8	17.0	16.5	9	18.5	18.0	10	20.0	19.5	
Outdoor unit HP capacity	I ₁	I ₂												
8	17.0	16.5												
9	18.5	18.0												
10	20.0	19.5												

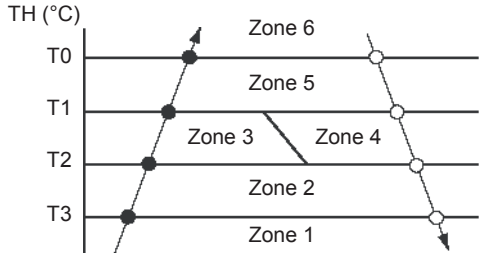
Item	Description of operation, numerical data, and other information	Remarks								
10. A3-IPDU control (continued)	<p>2. Heat sink temperature detection control</p> <ol style="list-style-type: none"> 1) This control performs the IGBT overheat protection by the detection of the TH sensor in Module Q201 for compressor driven in A3-IPDU. 2) Increments the Fan operation mode by 1 when $TH \geq 75^\circ\text{C}$ is detected. Increments the Fan operation mode by 1 per 5 seconds to the maximum hereinafter. 3) Returns to the normal fan mode control at $TH < 70^\circ\text{C}$ after 2). 4) Controls the output frequency by the TH sensor value so that the IGBT temperature does not become a given value, in addition to 1) - 3). <div style="text-align: center;">  <p>Zone 1: Normal operation. Zone 2: Slower frequency rising speed than normal. Zone 3: Maintains the current frequency. Zone 4: Maintains the current frequency. Zone 5: Reduces the frequency. Zone 6: Stop the operation.</p> </div> <p>The following table shows the temperature control value for each outdoor unit's horse power:</p> <table border="1" style="margin-left: auto; margin-right: auto;"> <thead> <tr> <th>T0</th> <th>T1</th> <th>T2</th> <th>T3</th> </tr> </thead> <tbody> <tr> <td>100 °C</td> <td>85 °C</td> <td>80 °C</td> <td>75 °C</td> </tr> </tbody> </table> <ol style="list-style-type: none"> 5) Stops the compressor at $TH \geq 100^\circ\text{C}$. (By the control of Zone 6 above) 6) The compressor restarts in 2 minutes and 30 seconds when the failure count is incremented. The failure is confirmed when the count becomes "4". The check code display is [P07]. (The compressor does not restart.) <p>3. Overcurrent protection control</p> <ol style="list-style-type: none"> 1) When the overcurrent protection circuit on an A3-IPDU P.C. board detects an abnormal current, the compressor is shut down. 2) The compressor is restarted 2 minutes and 30 seconds later, with a failure count of 1 recorded. If the compressor successfully operates for at least 10 minutes after a restart, the failure count is cleared. 3) If the failure count reaches 8, the check code is confirmed as final. 	T0	T1	T2	T3	100 °C	85 °C	80 °C	75 °C	<ul style="list-style-type: none"> • A3-IPDU is provided with a TH sensor.
T0	T1	T2	T3							
100 °C	85 °C	80 °C	75 °C							
11. High pressure SW control	<p>High pressure SW control</p> <ol style="list-style-type: none"> 1) When the high pressure SW of an inverter compressor is activated, the compressor is shut down with a failure count of 1 recorded. 2) The compressor is restarted 5 minutes later, and, if it successfully operates for at least 10 minutes, the failure count is cleared. 3) If the failure reaches 4, the check code is confirmed as final. The check code "P04" is displayed. 	<ul style="list-style-type: none"> • Connected to interface P.C. board, the high-pressure SW is normally closed. 								

<Other points to note>

1 Cooling operation under low outside temperature conditions

- 1) If pressure falls to extremely low levels, indoor units may be shut down via freeze prevention control based on the indoor TC sensor.
- 2) If pressure falls to extremely low levels, frequency may be reduced via cooling capacity control.
- 3) When the discharge temperature sensor reading falls below 60 °C, the frequency may be increased above the level called for by the command received from the indoor unit.

2 PMV (Pulse Motor Valve)

- 1) When the power is turned on, PMVs generate a tapping sound as they are initialized. If this sound is not heard, there is a possibility of faulty PMV operation. However, in a noisy environment, it may simply be drowned out by ambient noise.
- 2) Do not separate the actuator (head section) from any PMV during operation. It may result in an inaccurate opening.
- 3) When transporting (relocating) the set, do not, under any circumstances, keep the actuator separated. It may damage the valve by causing it to close and exposing it to pressure from sealed liquid.
- 4) When reattaching the actuator after its removal, push it in firmly until a click sound is heard. Then, turn the power off and back on again.

7 Applied control for outdoor unit

The outdoor fan high static pressure support and priority operation mode setting (cooling / heating / number of units / or priority indoor unit) functions are made available by setting relevant switches provided on the interface P.C. board of the outdoor unit.

7-1. Outdoor fan high static pressure shift

Purpose / characteristics

This function is used when connecting a duct to the discharge port of an outdoor unit (as part of, for example, unit installation on the floor by floor installation.)

Setup

Turn ON the DIP switch [SW10, Bit 2] provided on the interface P.C. board of the outdoor unit.

Specifications

Increase the speed of the propeller fan units on the outdoor fan to allow the installation of a duct with a maximum external static pressure not greater than specified in the table below.

Table 1: Maximum External Static Pressures of Outdoor Units

For Europe and Turkey model

Model	MCY-	MHP0806HS8	MHP1006HS8
Maximum external static pressure	(Pa)	20	20
Outdoor unit air flow*1	(m ³ /h)	7200	7620

For China model

Model	MCY-	MHP0806HT8	MHP0906HT8	MHP1006HT8
Maximum external static pressure	(Pa)	20	20	20
Outdoor unit air flow*1	(m ³ /h)	7200	8160	8580

*1 Calculate duct resistance from outdoor unit air flow.

7-2. Priority operation mode setting

Purpose / characteristics

This function allows switching between priority cooling and priority heating.

Four patterns of priority operation mode setting are available as shown in the table below. Select a suitable priority mode according to the needs of the customer.

Setup

CAUTION

In the case of the priority indoor unit mode, it is necessary to set up the specific indoor unit chosen for priority operation (a single unit only).

(1) Outdoor unit setup method

SW11		Operation
Bit 1	Bit 2	
OFF	OFF	Priority heating (factory default)
ON	OFF	Priority cooling
OFF	ON	Priority operation based on No. of units in operation (priority given to the operation mode with the largest share of units in operation)
ON	ON	Priority indoor unit (priority given to the operation mode of the specific indoor unit set up for priority operation)

(2) Indoor unit setup method for priority indoor unit mode

The setting can be changed only when the system is at rest. (Be sure to turn off the system prior to this operation.)

- 1 Push the + + buttons simultaneously and hold for at least 4 seconds. The display window will start flashing in a little while.

Verify that the displayed CODE No. is 10.

- If the displayed CODE No. is not 10, press the button to erase the display and repeat the procedure from the beginning.
(Note that the system does not respond to remote controller operation for about 1 minute after the button is pushed.)
(In the case of group control, the indoor unit No. displayed first indicates the outdoor unit.)

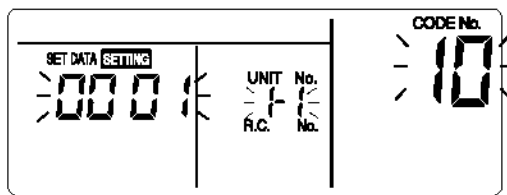
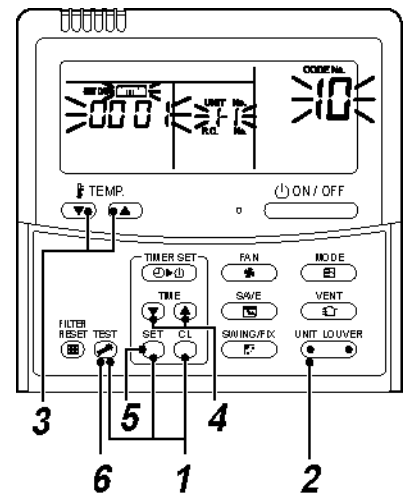

- 2 Each time the button is pushed, one of the indoor unit Nos. under group control is displayed in turn. Select the indoor unit whose setting is to be changed.

The fan and louver of the selected indoor unit then come on, so that the position of this unit can be confirmed.

- 3 Use the button to select the CODE No. 04.

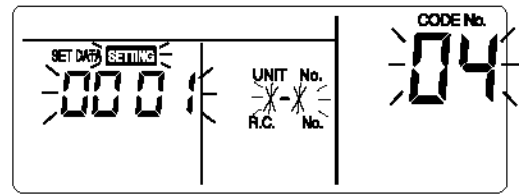

- 4 Use the button to select the SET DATA 0001.

Priority set 0001 No priority set 0000

- 5 Push the button.

The setup is finished when the display changes from flashing to steady.

- 6 Upon finishing the setup, push the button. (This finalizes the setting.)

When the button is pushed, the display goes blank, and the system returns to normal off state.

(Note that the system does not respond to remote controller operation for about 1 minute after the button is pushed.)

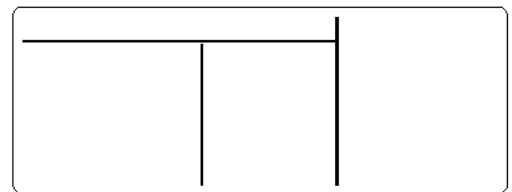

NOTE

Priority can be given to only one indoor unit. If more than one indoor unit is accidentally set to priority, a check code (L5 or L6: Duplicated indoor unit priority setting) will be displayed.
All units displaying L5 have been set to 0001 (priority). Keep the unit to which priority should be given as it is, and change the value back to 0000 (no priority) for all the rest.

Check code	Description
L5	Duplicated indoor unit priority setting (The unit is set to 0001.)
L6	Duplicated indoor unit priority setting (The unit is set to 0000.)

7-3. Applied control of outdoor unit

7-3-1. Optional P.C. board of outdoor unit installation

Placing position

Install the optional P.C. boards on top of the interface P.C. board in the outdoor unit.
Be sure to turn off the power switch before installing.

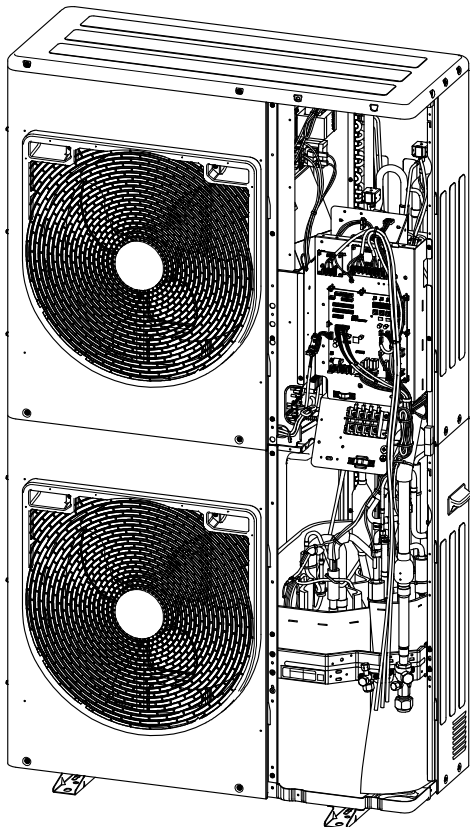

- (1) Holes for installing supports are provided on the top of the interface P.C. board in the electrical box.
Use the supports to install the optional P.C. boards.

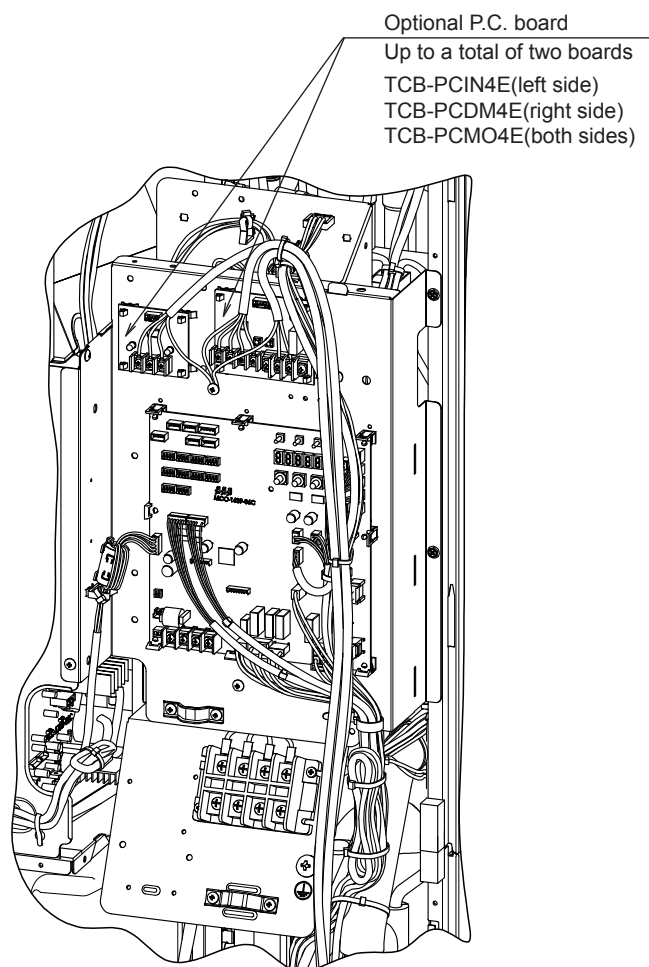

Optional P.C. board
Up to a total of two boards
TCB-PCIN4E(left side)
TCB-PCDM4E(right side)
TCB-PCMO4E(both sides)

Wiring connections

- (1) Refer to the details on the wiring diagrams.
- (2) Be sure to use the shield wire to prevent noise trouble, and perform the grounding at both sides of shield wires.
- (3) Fasten the external wires to the cable clamps.

Optional control P.C. boards provide access to a range of functions as listed below.

No.	Function	Control P.C. board to be used			Outdoor unit interface P.C. board setting*			
		PCDM4E	PCMO4E	PCIN4E	Connector No.	DIP SW No.	Bit	Jumper to be removed
1	Power peak-cut control (Standard)	✓	–	–	CN513 (blue)	SW07	1	–
	Power peak-cut control (For one input function)	✓	–	–	CN513 (blue)	SW07	1	J20
2	Power peak-cut control (Enhanced Functions)	✓	–	–	CN513 (blue)	SW07	1.2	–
3	Snowfall fan control	–	✓	–	CN509 (black)	–	–	–
4	External master ON / OFF control	–	✓	–	CN512 (blue)	–	–	–
5	Night operation (sound reduction) control	–	✓	–	CN508 (red)	–	–	–
6	Operation mode selection control	–	✓	–	CN510 (white)	–	–	–
	Operation mode selection control (forced choice)	–	✓	–	CN510 (white)	–	–	J01
7	Error / Operation output	–	–	✓	CN511 (green)	–	–	–

Layout of outdoor unit interface P.C. board

* DIP switch settings and jumper wire statuses vary from function to function.

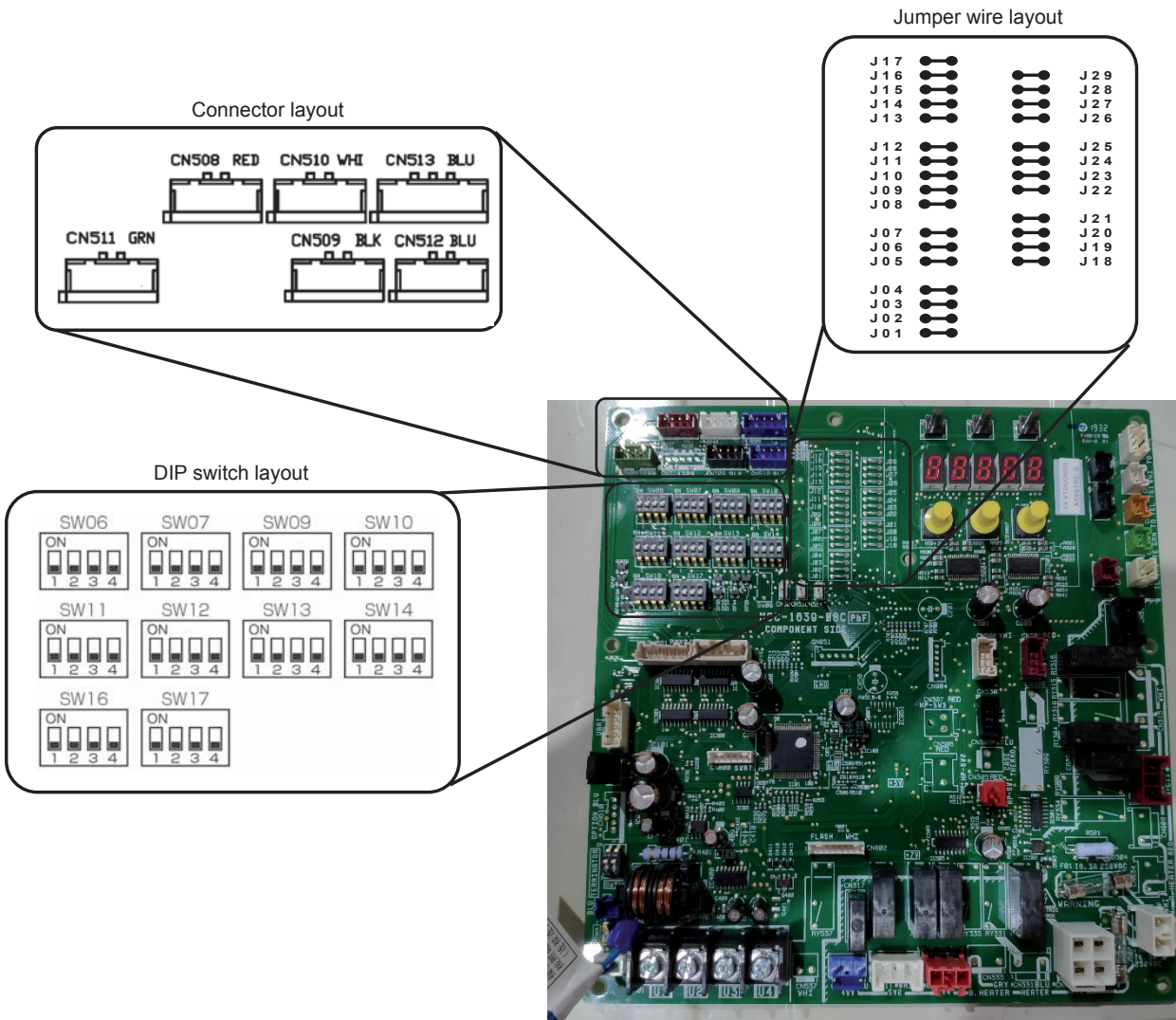

7-3-2. Power peak-cut control (standard)

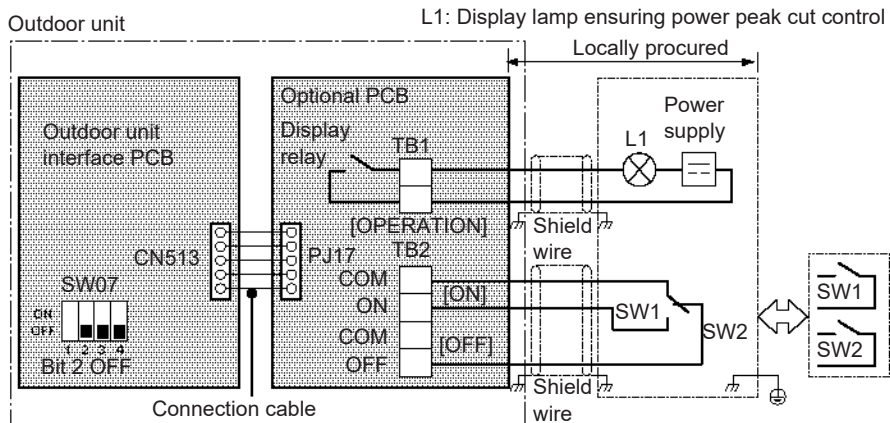

For SW1 and SW2, be sure to provide no-voltage contacts for each terminal.
The input signals of SW1 and SW2 may be pulse input (100 msec or more) or continuous make.

Operation

An external power peak-cut control signal limits the peak capacity of the outdoor unit.

L1: Power peak-cut control indication lamp

SW1: Power peak-cut control ON switch (ON as long as target power peak-cut control has been reached or exceeded, normally OFF)*1

SW2: Power peak-cut control OFF switch (OFF as long as target power peak-cut control has not been reached or exceeded, normally ON)*1

*1 The inputs of SW1 and SW2 can be either pulse (100 msec or wider) or step signals.

Do not turn on SW1 and SW2 simultaneously.

* Be sure to provide a contact for each terminal.

Power peak-cut control settings

Power peak-cut control P.C. board	SW1	SW2	L1	Interface P.C. board of outdoor unit	
				SW07 Bit 1 OFF	SW07 Bit 1 ON
Power peak-cut control ON signal received	ON	OFF	ON	0 % (forced stop)	60 % capacity (upper limit regulated)
Power peak-cut control OFF signal received	OFF	ON	OFF	100 % (normal operation)	100 % (normal operation)

Two-core cable support

It allows ON / OFF power peak-cut control to be implemented using a power peak-cut control ON input (SW1) alone, provided that the J20 jumper wire on the interface P.C. board of the outdoor unit has been removed.

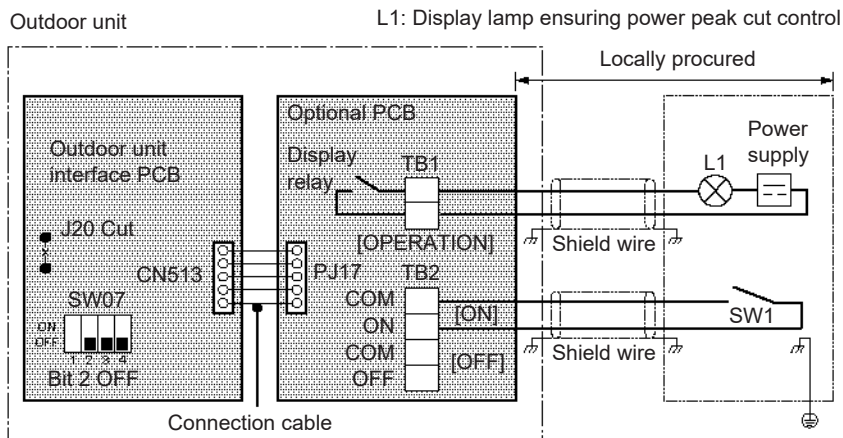

<SW07 Bit 2 OFF (two-step control)>

Power peak-cut control is enabled as long as SW1, as shown on the wiring diagram, is ON (continuously).

Jumper wire J20	Input SW1	SW07 Bit 1		Indicator relay (L1)
		Bit 1 OFF	Bit 1 ON	
Cut	ON	0 % (forced stop)	60 % capacity (upper limit regulated)	ON
	OFF	100 % (normal operation)	100 % (normal operation)	OFF

Note 1: Specifications of display relay contact

- The terminal for display output ([Operation] terminal) must satisfy the following electrical rating.

<p><Electrical Rating> 220 to 240 VAC, 10 mA or more, 1 A or less 24 VDC, 10 mA or more, 1 A or less (non-conductive load)</p>
--

When connecting a conductive load (e.g. relay coil) to the display relay load, insert a surge killer CR (for an AC power supply) or a diode for preventing back electromotive force (for a DC power supply) on the bypass circuit.

7-3-3. Power peak-cut control (extended)

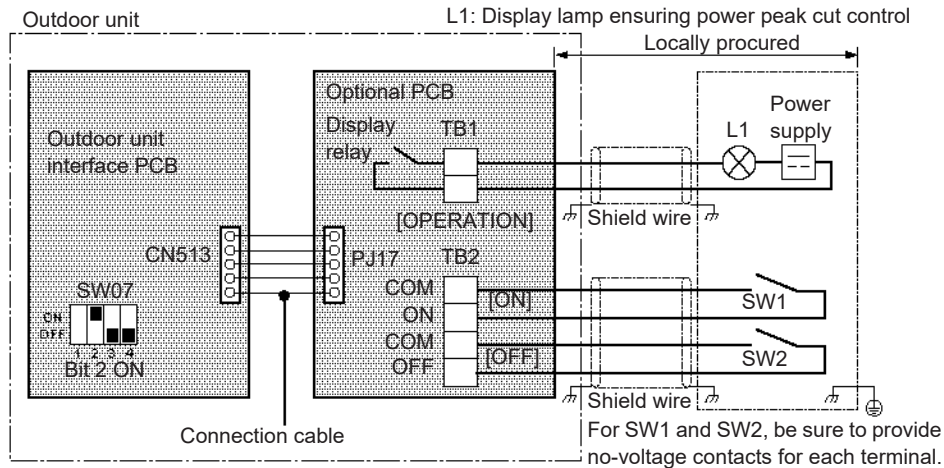

Operation

An external power peak-cut control signal limits the peak capacity of the outdoor unit.

L1: Power peak-cut control indication lamp

SW1: Power peak-cut control ON switch*1

SW2: Power peak-cut control OFF switch*1

*1 The inputs of SW1 and SW2 can be either pulse (100 msec or wider) or step signals.

* Be sure to provide a contact for each terminal.

Extended power peak-cut control settings

Specifications of display relay contact

Indication lamp	External power peak-cut control signals		Peak capacity	
			I/F SW07 Bit 1	
L1	SW1	SW2	OFF	ON
OFF	OFF	OFF	100 % (normal operation)	100 % (normal operation)
ON	ON	OFF	80 % (upper limit regulated)	85 % (upper limit regulated)
ON	OFF	ON	60 % (upper limit regulated)	75 % (upper limit regulated)
ON	ON	ON	0 % (forced stop)	60 % (upper limit regulated)

Note 1: Specifications of display relay contact

- The terminal for display output ([Operation] terminal) must satisfy the following electrical rating.

<p><Electrical Rating> 220 to 240 VAC, 10 mA or more, 1 A or less 24 VDC, 10 mA or more, 1 A or less (non-conductive load)</p>
--

When connecting a conductive load (e.g. relay coil) to the display relay load, insert a surge killer CR (for an AC power supply) or a diode for preventing back electromotive force (for a DC power supply) on the bypass circuit.

7-3-4. Snowfall fan control

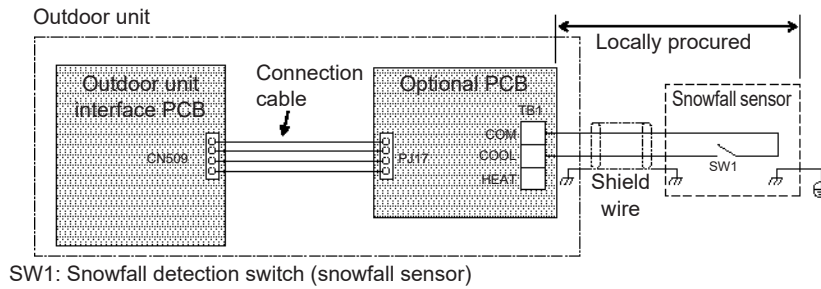

Operation

An external snowfall signal turns on the outdoor unit fan.

Terminal	Input signal	Operation
COOL (SW1)	ON	Snowfall fan control (Turns on outdoor unit fan)
	OFF	Normal operation (Cancels control)

The input signal is recognized during its rising / falling phase.

(After reaching the top / bottom of the rising / falling edge, the signal must remain there for at least 100 ms.)

7-3-5. External master ON / OFF control

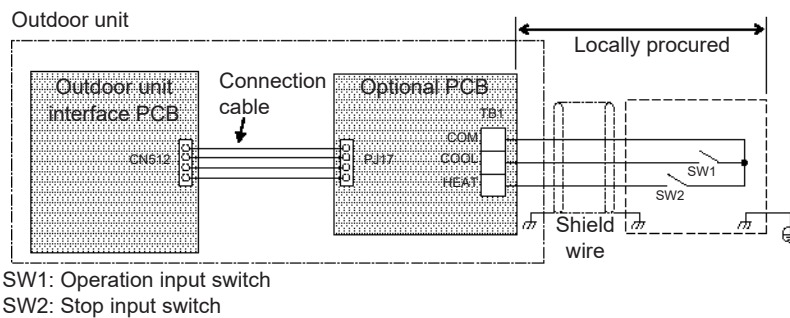

Operation

The system is started / stopped from the outdoor unit.

Terminal	Input signal	Operation
COOL (SW1)	ON	Turns on all indoor units
HEAT (SW2)	ON	Turns off all indoor units

The input signal is recognized during its falling phase. (After reaching the bottom of the falling edge, the signal must remain there for at least 100 ms.)

CAUTION

(1) Do not turn on the COOL (SW1) and HEAT (SW2) terminals simultaneously.

(2) Be sure to provide a contact for each terminal.

External signal: No-voltage pulse contact

7-3-7. Operation mode selection control

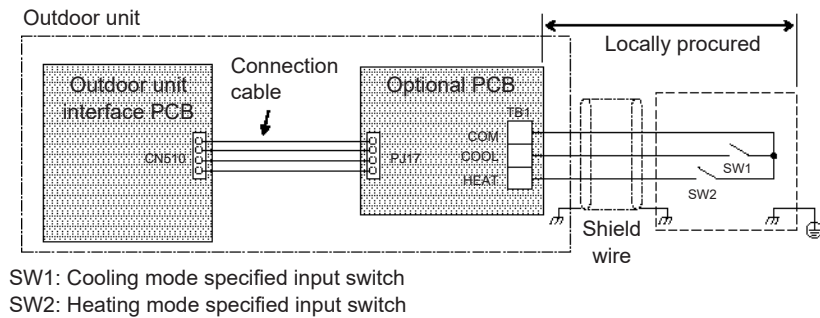

NOTE

SW1: COOL mode selection switch
SW2: HEAT mode selection switch

Input signal		Operation	Remarks
COOL (SW1)	HEAT (SW2)		
ON	OFF	Only cooling operation allowed	*
OFF	ON	Only heating operation allowed	*
OFF	OFF	Normal operation	

* The display "🔧 (Operation mode selection control in progress)" appears on the remote controller

Indoor unit operation intervention function

The statuses of indoor units operating in a mode different from the selected operation mode can be changed by changing the status of a jumper wire (J01) provided on the interface P.C. board of outdoor unit.

Jumper wire	Description of intervention											
J01 connected (factory default)	All indoor units operating in a mode different from the selected operation mode (prohibited-mode indoor units) become non-priority units (thermostat OFF). The display "🔧 (operation ready)" appears on the remote controller of prohibited-mode indoor units.											
J01 cut	The selected operation mode is imposed on all indoor units operating in a different mode. <table border="1" style="width: 100%; border-collapse: collapse;"> <thead> <tr> <th>Mode selected at P.C. board</th> <th colspan="2">Remote controller operation / display</th> </tr> </thead> <tbody> <tr> <td>Normal</td> <td>All modes (COOL, DRY, HEAT and FAN) available</td> <td></td> </tr> <tr> <td>COOL</td> <td>Only COOL, DRY and FAN available</td> <td rowspan="2">"🔧 operation mode control" (turned on during remote controller operation)</td> </tr> <tr> <td>HEAT</td> <td>Only HEAT and FAN available</td> </tr> </tbody> </table>	Mode selected at P.C. board	Remote controller operation / display		Normal	All modes (COOL, DRY, HEAT and FAN) available		COOL	Only COOL, DRY and FAN available	"🔧 operation mode control" (turned on during remote controller operation)	HEAT	Only HEAT and FAN available
Mode selected at P.C. board	Remote controller operation / display											
Normal	All modes (COOL, DRY, HEAT and FAN) available											
COOL	Only COOL, DRY and FAN available	"🔧 operation mode control" (turned on during remote controller operation)										
HEAT	Only HEAT and FAN available											

7-3-8. Error / Operation output

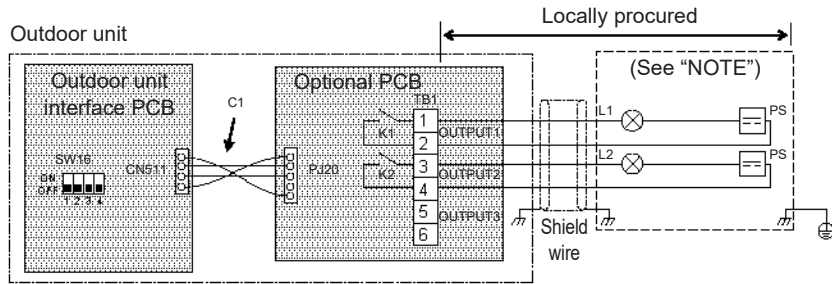

Operation

In-operation output: An in-operation indication signal is output as long as at least one indoor unit is in operation in the line.

Failure output: A failure indication signal is output if check code occurs in at least one indoor / outdoor unit in the line.

Note 1: Output Relay (K1, K2) Contact Specifications

- Output terminals (OUTPUT1, 2) must satisfy the following electrical rating.
- When connecting a conductive load (e.g. relay coil) to loads K1 and K2 insert a surge killer CR (for an AC power supply) or a diode for preventing back electromotive force (for a DC power supply) on the bypass circuit.

<Electrical Rating>
 220-240 VAC, 10 mA or more, 1 A or less
 24 VDC, 10 mA or more, 1 A or less (non-conductive load)

C1	Connector cable 1
CN511	Connector on Interface side (green)
K1,K2	Relays
L1	Failure indication Lamp
L2	Operation indication Lamp
OUTPUT1	Failure output
OUTPUT2	Operation output
PJ20	Connector on optional PCB side
PS	Power supply unit
TB1	Terminal block

8 Test operation

8-1. Procedure and summary of test operation

A test operation is executed with the following procedure. When a problem occurs at any step, remove the causes of the problem referring to “9 Troubleshooting.”

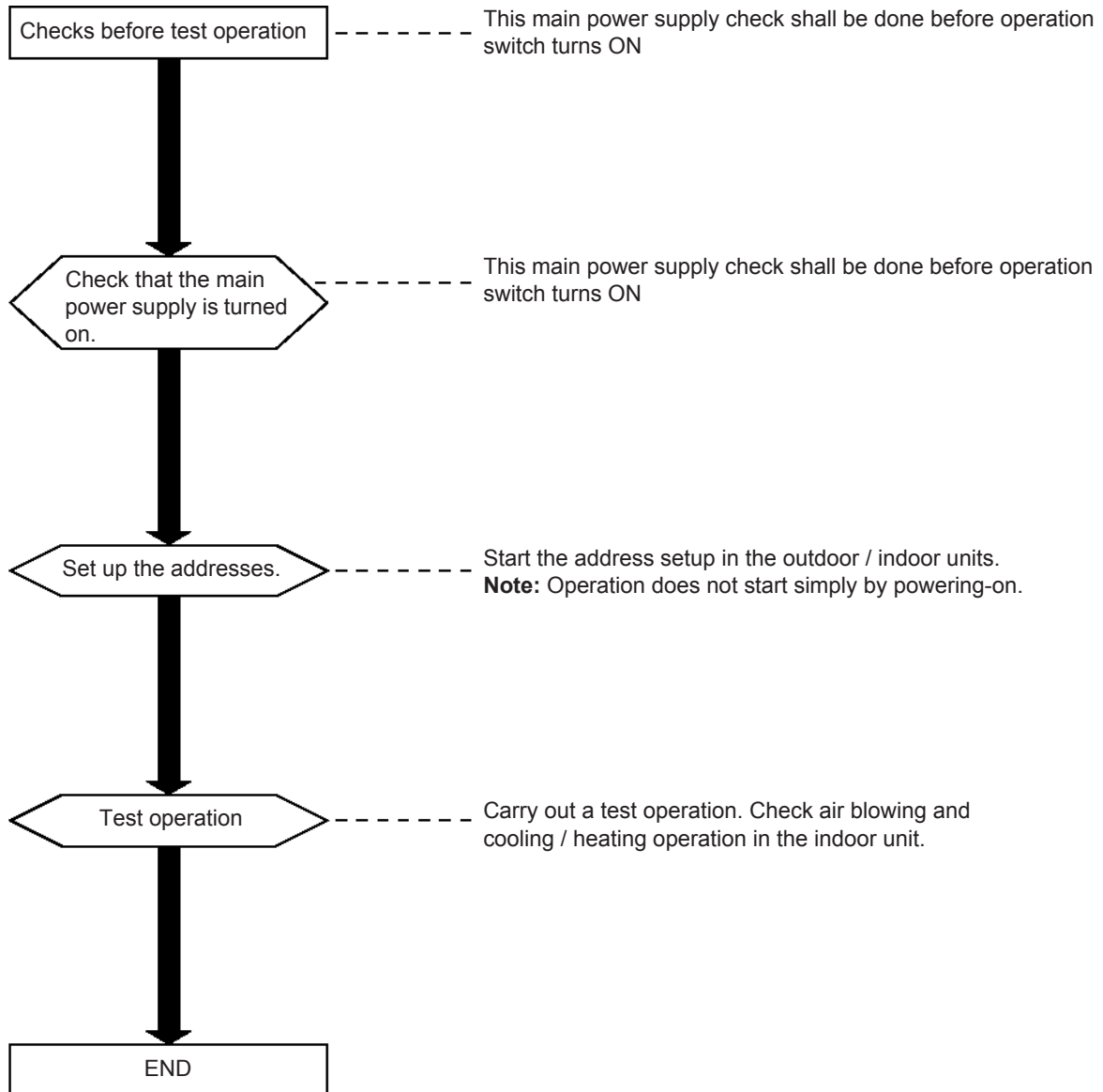

8-2. Check items before test operation (before powering-on)

Prior to the test operation, check the following items to verify there are no problems with the installation work.

Main check items for electric wiring

The communication system differs from that of R22 or R407 refrigerant “Modular Multi system” air conditioners. Check wiring points again carefully.

(1) In the case that a central control system is not connected:

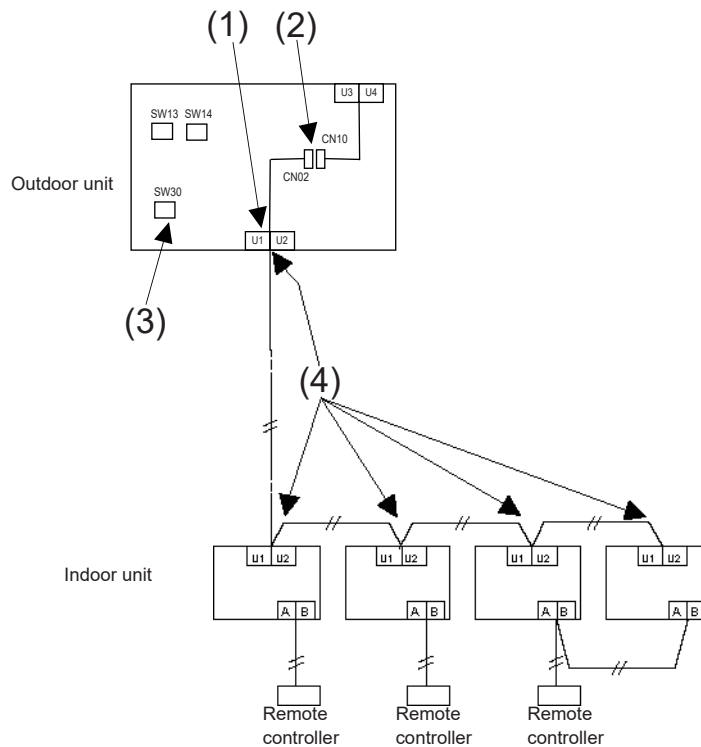

Main check items	Check
(1) Are the indoor and outdoor communication lines of the outdoor unit connected to the U1 / U2 terminals?	
(2) Relay connector CN10 which is mounted on the interface P.C. board or has been removed from the CN02? (Set up factory default)	
(3) Is the terminal resistance (SW30-bit 2) on the interface P.C. board of the outdoor unit turned on? (Set up factory default)	
(4) Is the end terminal of the shield wire earthed?	

NOTE

The figure above does not show all the electric wires.

For details, refer to the installation manuals for the outdoor unit, indoor unit, remote controller, or optional devices.

If connect a relay connector CN10 to CN02, will connected communication line [U1, U2] and [U3, U4].

The connected [U1,U2]and[U3,U4] brings incorrect refrigerant line address setting.

(2) In the case that a central control system is connected (before address setup)

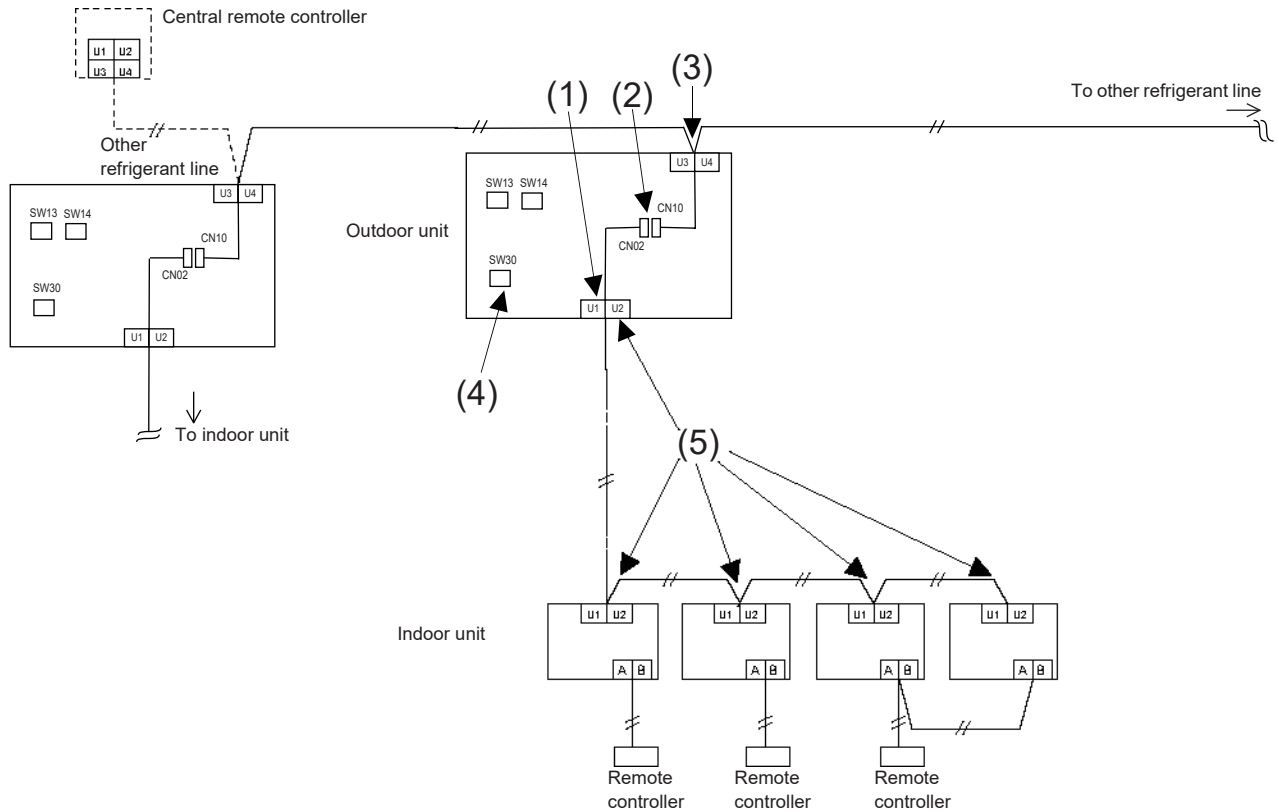

Main check items	Check
(1) Are the indoor and outdoor communication lines of the outdoor unit connected to the U1 / U2 terminals?	
(2) Relay connector CN10 which is mounted on the interface P.C. board or has been removed from the CN02? (Set up factory default) (Keep the relay connector disconnected before address setup.)	
(3) Is the communication line of the central control system connected to the outdoor unit U3 / U4 terminals of each refrigerant line?	
(4) Is the terminal resistance (SW30-bit 2) on the interface P.C. board of the outdoor unit turned on? (Set up factory default) * After address setup and test operation check, turn on the SW30-bit 2 of the outdoor unit for the smallest line address, and turn off SW30-bit 2 of the outdoor unit for other refrigerant lines. ("8-4-3. Address setup procedure")	
(5) Is the end terminal of the shield wire earthed?	
(6) When the refrigerant line and the central control system of the DI-SDI series are connected: → Are Network adapter (TCB-PCNT30TLE2) correctly connected? → When the DI-SDI series operates with group, twin, or triple operation, are the adapters connected to the header unit of the indoor unit?	

NOTE

The figure above does not show all the electric wires.
For details, refer to the installation manuals for the outdoor unit, indoor unit, remote controller, or optional devices.
If connect a relay connector CN10 to CN02, will connected communication line [U1, U2] and [U3, U4].
The connected [U1,U2]and[U3,U4] brings incorrect refrigerant line address setting.

Checklist 1

Using Checklist 1, check that there are no problems with the installation work.

Is the capacity of the circuit breaker (Earth leakage breaker) appropriate?	Outdoor unit <input type="text"/> A	Indoor unit <input type="text"/> A
Is the gauge of the power cable correct?	Outdoor unit <input type="text"/> mm ²	Indoor unit <input type="text"/> mm ²
Is the control communication line correct?	Indoor-outdoor connection terminals (U1, U2) <input type="text"/>	
	Central control system connection terminals (U3, U4) <input type="text"/>	
Is the power of indoor units supplied collectively?		
Is it grounded to earth?		
Is the insulation resistance sufficient? (10 MΩ or higher)	<input type="text"/> MΩ or higher	
Is the main power voltage sufficient? (within 380 - 415 V ±10%)	<input type="text"/> V	
Is the diameter of connecting pipe correct?		
Is the branch kit correct?		
Is the water drain of the indoor unit arranged so that it flows without accumulation?		
Is the heat insulation of pipes sufficient? (connecting pipes, branch kit)		
Is there no short circuit of discharge air in the indoor / outdoor units?		
After an airtightness test of the pipes, are vacuuming and adding of refrigerant executed?		
Are the valves of all the outdoor units fully opened?	Outdoor unit	Gas side <input type="text"/> Liquid side <input type="text"/>

For Europe and Turkey model Checklist 2

Calculate the additional amount of refrigerant from the following:

Additional refrigerant charge amount at local site	=	Real length of liquid pipe	×	Additional refrigerant charge amount per 1 m liquid pipe (Table 1)	+	Corrective amount of refrigerant depending on the indoor units (Table 2)	+	Compensation by outdoor HP (Table 3)
		(A)			(B)		(C)	

Firstly enter the total length for each liquid pipe in the following table and then calculate the additional amount of refrigerant by pipe length.

(Table 1) Additional amount of refrigerant by pipe length

Pipe diameter on the liquid side	Total pipe length on each liquid side (m)	Standard amount of refrigerant (kg/m)	Additional amount of refrigerant pipe diameter on each liquid side (kg)
Ø6.4	=	0.025 ×	kg
Ø9.5	=	0.055 ×	kg
Ø12.7	=	0.105 ×	kg
Additional amount of refrigerant by pipe length (A)			kg

Next, refer to the following table for the corrective amount of refrigerant depending on the indoor units (B).

(Table 2) Corrective amount of refrigerant depending on the indoor units

Model type	Capacity ran	005	007	009	012	015	018	024	027	030	036	048	056
	Capacity code(Equivalent to HP)	0.6	0.8	1.0	1.25	1.7	2.0	2.5	3.0	3.2	4.0	5.0	6.0
4-way cassette	MMU-AP****HP*	—	—	0.4	0.4	0.8	0.8	0.8	0.8	0.8	1.2	1.2	1.2
	MMU-AP****MH*	0.3	0.4	0.4	0.4	0.6	0.6	—	—	—	—	—	—
2-way cassette	MMU-AP****WH*	—	0.4	0.4	0.4	0.5	0.7	0.7	0.7	0.7	1.1	1.1	1.1
1-way cassette	MMU-AP****YH/SH*	—	0.4	0.4	0.4	0.5	0.5	0.6	—	—	—	—	—
Duct	MMD-AP****BHP*	—	0.5	0.5	0.5	0.5	0.5	0.7	0.7	0.7	1.1	1.1	1.1
	MMD-AP****SPH*	0.3	0.3	0.3	0.3	0.5	0.5	0.8	0.8	—	—	—	—
	MMD-AP****HP*	—	—	—	—	—	0.7	0.7	0.7	—	1.1	1.1	1.1
Ceiling	MMC-AP****HP*	—	—	—	—	0.6	0.6	0.8	0.8	—	1.2	1.2	1.2
High wall	MMK-AP****H*	—	0.5	0.5	0.5	0.7	0.7	0.7	—	—	—	—	—
	MMK-AP****HP*	0.3	0.3	0.3	0.3	0.7	0.7	0.7	—	—	—	—	—
Floor standing	MMF-AP****H*	—	—	—	—	0.7	0.7	1.0	1.0	—	1.3	1.3	1.3
	MML-AP****H*	—	0.5	0.5	0.5	0.5	0.8	0.8	—	—	—	—	—
	MML-AP****BH*	—	0.3	0.3	0.3	0.5	0.5	0.7	—	—	—	—	—
	MML-AP****NH*	—	0.5	0.5	0.5	0.5	0.5	—	—	—	—	—	—

(Unit: kg)

		Capacity rank	027	056
		Capacity code(Equivalent to HP)	2.5	5.0
Indoor unit model name	HWM	MMW-AP****1LQ*	0.2	0.4

	Indoor unit model	Capacity rank	B (Corrective amount of refrigerant) (kg)
Unit 1			kg
Unit 2			kg
Unit 3			kg
Unit 4			kg
Unit 5			kg
Unit 6			kg
Unit 7			kg
Unit 8			kg
Unit 9			kg
Unit 10			kg
Unit 11			kg
Unit 12			kg
Unit 13			kg
Unit 14			kg
Unit 15			kg
Unit 16			kg
Corrective amount of refrigerant depending on the indoor units (B)			kg

Next, refer to the following table for the corrective amount of refrigerant by outdoor HP (C).

(Table 3) Compensation by outdoor HP

Outdoor unit type	0806HS8	1006HS8
Compensation by outdoor HP(kg)	- 1.0	- 1.0

Lastly, add the additional amount of refrigerant by pipe length (A), the corrective amount of refrigerant depending on the indoor units (B) and the corrective amount of refrigerant by outdoor HP (C). This is the final additional amount of refrigerant. If a minus sign is indicated as the result, do not add the refrigerant (= 0 kg).

<Additional amount of refrigerant>

Additional amount of refrigerant by pipe length (A)	kg
Corrective amount of refrigerant depending on the indoor units (B)	kg
Compensation by outdoor HP (C)	kg
Additional refrigerant charge amount at local site (A) + (B) + (C)	kg

For China model Checklist 2

Calculate the additional amount of refrigerant from the following:

Additional refrigerant charge amount at local site	=	Real length of liquid pipe	×	Additional refrigerant charge amount per 1 m liquid pipe (Table 1)	+	Corrective amount of refrigerant depending on the indoor units (Table 2)	+	Compensation by outdoor HP (Table 3)
			(A)				(B)	(C)

Firstly enter the total length for each liquid pipe in the following table and then calculate the additional amount of refrigerant by pipe length.

(Table 1) Additional amount of refrigerant by pipe length

Pipe diameter on the liquid side	Total pipe length on each liquid side (m)	Standard amount of refrigerant (kg/m)	Additional amount of refrigerant pipe diameter on each liquid side (kg)
Ø6.4	=	0.025 ×	kg
Ø9.5	=	0.055 ×	kg
Ø12.7	=	0.105 ×	kg
Additional amount of refrigerant by pipe length (A)			kg

Next, refer to the following table for the corrective amount of refrigerant depending on the indoor units (B).

(Table 2) Corrective amount of refrigerant depending on the indoor units

Model type	Capacity	005	007	008	009	010	012	014	015	017	018	020	024	027	030	034	036	042	048	056	
	Capacity code(Equivalent to HP)	0.6	0.8	0.9	1.0	1.1	1.25	1.5	1.7	1.85	2.0	2.25	2.5	3.0	3.2	3.6	4.0	4.5	5.0	6.0	
4-way cassette	MMU-*P****HY*	—	—	—	0.4	—	0.4	—	0.8	—	0.8	—	0.8	0.8	0.8	0.8	1.2	1.2	1.2	1.2	
	MMU-*P****MH*	—	0.4	—	0.4	—	0.4	—	0.6	—	0.6	—	—	—	—	—	—	—	—	—	
2-way cassette	MMU-*P****WH*	—	0.4	—	0.4	—	0.4	—	0.5	—	0.7	—	0.7	0.7	0.7	—	1.1	—	1.1	1.1	
1-way cassette	MMU-*P****YH/SH*	—	0.4	—	0.4	—	0.4	—	0.5	—	0.5	—	0.6	—	—	—	—	—	—	—	
Duct	MMD-AP****BH*	—	0.3	—	0.3	—	0.3	—	0.5	—	0.5	—	0.8	0.8	0.8	—	1.1	—	1.1	1.1	
	MMD-*P****BHY*	—	—	—	—	—	—	—	—	—	—	—	0.7	0.7	0.7	0.7	1.1	1.1	1.1	1.1	
	MMD-AP****S(P)H*	—	0.3	—	0.3	—	0.3	—	0.5	—	0.5	—	0.8	0.8	—	—	—	—	—	—	
	MMD-*P****M(P)H(Y)*	0.3	0.4	0.4	0.4	0.4	0.4	0.4	0.5	0.5	0.5	0.7	0.7	0.7	—	—	—	—	—	—	
	MMD-AP****H*	—	—	—	—	—	—	—	—	—	—	—	0.8	—	1.0	1.0	—	1.0	—	1.3	—
	MMD-*P****HP*	—	—	—	—	—	—	—	—	—	—	—	0.7	0.7	—	—	—	1.1	—	1.1	1.1
Under-ceiling	MMC-AP****H*	—	—	—	—	—	—	—	0.5	—	0.5	—	0.7	0.7	—	—	1.1	—	1.1	—	
	MMC-*P****HP*	—	—	—	—	—	—	—	0.6	—	0.6	—	0.8	0.8	—	—	1.2	—	1.2	1.2	
High wall	MMK-AP****H*	—	0.5	—	0.5	—	0.5	—	0.7	—	0.7	—	0.7	—	—	—	—	—	—	—	
	MMK-*P****HP*	0.3	0.3	—	0.3	—	0.3	—	0.7	—	0.7	—	0.7	—	—	—	—	—	—	—	
Floor standing	MMF-*P****H*	—	—	—	—	—	—	—	0.7	—	0.7	—	1.0	1.0	—	—	1.3	—	1.3	1.3	
	MML-*P****H*	—	0.5	—	0.5	—	0.5	—	0.5	—	0.8	—	0.8	—	—	—	—	—	—	—	
	MML-*P****BH*	—	0.3	—	0.3	—	0.3	—	0.5	—	0.5	—	0.7	—	—	—	—	—	—	—	
	MML-*P****NH(P)*	—	0.5	—	0.5	—	0.5	—	0.5	—	0.5	—	—	—	—	—	—	—	—	—	

Indoor unit model name	HWM	Capacity rank	027	042	056	084
		Capacity code(Equivalent to HP)	2.5	4.0	5.0	8.0
		MMW-*P****LQ*	0.2	0.3	0.4	0.7

Indoor unit model	Capacity rank	B (Corrective amount of refrigerant) (kg)
Unit 1		kg
Unit 2		kg
Unit 3		kg
Unit 4		kg
Unit 5		kg
Unit 6		kg
Unit 7		kg
Unit 8		kg
Unit 9		kg
Unit 10		kg
Unit 11		kg
Unit 12		kg
Unit 13		kg
Unit 14		kg
Unit 15		kg
Unit 16		kg
Corrective amount of refrigerant depending on the indoor units (B)		kg

Next, refer to the following table for the corrective amount of refrigerant by outdoor HP (C).

(Table 3) Compensation by outdoor HP

Outdoor unit type	0806HT8	0906HT8	1006HT8
Compensation by outdoor HP(kg)	- 1.0	- 1.0	- 1.0

Lastly, add the additional amount of refrigerant by pipe length (A), the corrective amount of refrigerant depending on the indoor units (B) and the corrective amount of refrigerant by outdoor HP (C). This is the final additional amount of refrigerant. If a minus sign is indicated as the result, do not add the refrigerant (= 0 kg).

<Additional amount of refrigerant>

Additional amount of refrigerant by pipe length (A)	kg
Corrective amount of refrigerant depending on the indoor units (B)	kg
Compensation by outdoor HP (C)	kg
Additional refrigerant charge amount at local site (A) + (B) + (C)	kg

8-3. Check at main power-on

After turning on the main power of the indoor units and outdoor unit in the refrigerant line to conduct a test operation, check the following items in each outdoor and indoor unit.

(After turning on the main power, be sure to check in order: indoor unit → outdoor unit.)

<Check on the outdoor unit>

- (1) Check that all the rotary switches, SW01, SW02, and SW03, on the interface P.C. board of the outdoor unit are set to "1."
- (2) If another check code is displayed on the 7-segment display [B], remove the cause of the problem referring to Section, "9 Troubleshooting".
- (3) Check that "L08" is displayed on the 7-segment display [B] on the interface P.C. board of the outdoor unit. (L08: Indoor address not set up)
(If the address setup operation has already been completed during servicing, etc., the above check code is not displayed, and only "U1" is displayed on the 7-segment display [A].)

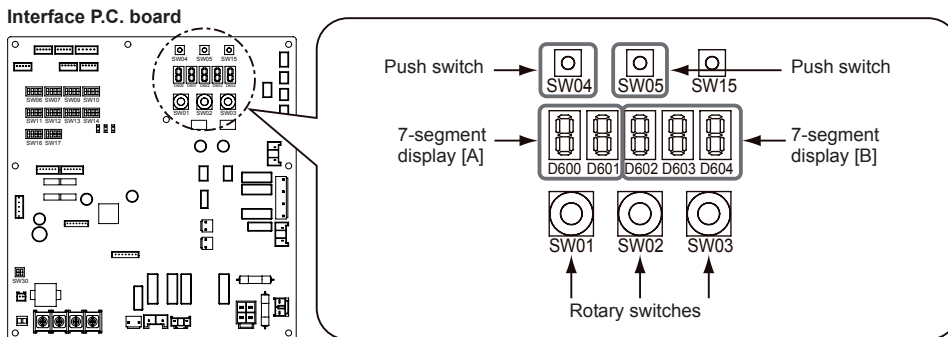

<Check on the indoor unit>

- (1) Display check on the remote controller (in the case of a wired remote controller)

Check that a frame, as shown in the following figure at left, is displayed on the LC display section of the remote controller.

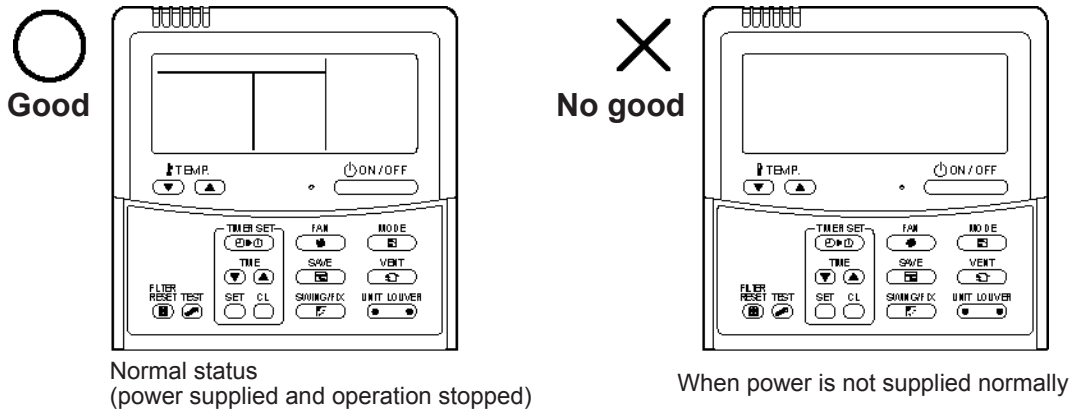

If no frame is displayed, as shown in the above figure at right, the remote controller does not have a normal supply of power; check the following items.

- Check the power supply of the indoor unit.
- Check the cabling between the indoor unit and the remote controller.
- Check whether there is a cutoff of wire around the indoor control P.C. board or not, and check for connection failures of the connectors.
- Check for failure of the transformer for the indoor electrical control box.
- Check for failure of the indoor control P.C. board.

8-4. Address setup

This product requires address setup before operation.
Follow this procedure for address setup.

8-4-1. Precautions

- (1) Address setup is not performed simply by turning on the power supply.
- (2) For indoor units, address setup can be done either by manual address setup or by automatic address setup:
Automatic address setup: Setup from SW15 on the interface P.C. board of the outdoor unit
Manual address setup: Setup from the wired remote controller. (For details, refer to “8-4-3. Address setup procedure.”)
- (3) Automatic setup usually takes about 5 minutes per line. In some cases, however, it may take up to 10 minutes.
- (4) It is unnecessary to operate the air conditioner to achieve address setup.

8-4-2. Address setup and check procedure

Procedure	Item	Operation and check contents																							
1	Indoor unit power-on	Turn on the power of the indoor unit for the refrigerant line for which the address is to be set up.																							
2	Outdoor unit power-on	Turn on the power of the outdoor unit for the refrigerant line for which the address is to be set up.																							
3	7-segment display check	Check that “L08” is displayed on the 7-segment display [B] on the interface P.C. board of the outdoor unit in the system where the address is to be set up.																							
4	Address setup start	Confirm the items in “8-4-3. Address setup procedure,” and then set up the address according to the operation procedure. (Be careful to note that the setup operation may differ in group control and central control systems.) Note: The address cannot be set up if switches are not operated.																							
5	Display check after setup	<ul style="list-style-type: none"> • After address setup, “U1” “ ” is displayed on the 7-segment display. • If a check code is displayed on the 7-segment display [B], remove the cause of the problem referring to “9 Troubleshooting.” 																							
6	System information check after setup	Using the 7-segment display function, check the system information of the scheduled system. (This check is executed on the interface P.C. board of the outdoor unit.) <table border="1" style="margin-left: auto; margin-right: auto;"> <thead> <tr> <th rowspan="2"></th> <th colspan="3">Rotary switch setup</th> <th colspan="2">7-segment display</th> </tr> <tr> <th>SW01</th> <th>SW02</th> <th>SW03</th> <th>[A]</th> <th>[B]</th> </tr> </thead> <tbody> <tr> <td>System capacity</td> <td>1</td> <td>2</td> <td>3</td> <td>[Number of horsepower]</td> <td>[H P]</td> </tr> <tr> <td>Total capacity of indoor units</td> <td>1</td> <td>3</td> <td>3</td> <td>[. -]</td> <td>[-. - -]</td> </tr> </tbody> </table> <p>After the above checks, return rotary switches SW01, SW02, and SW03 to 1/1/1.</p>		Rotary switch setup			7-segment display		SW01	SW02	SW03	[A]	[B]	System capacity	1	2	3	[Number of horsepower]	[H P]	Total capacity of indoor units	1	3	3	[. -]	[-. - -]
	Rotary switch setup			7-segment display																					
	SW01	SW02	SW03	[A]	[B]																				
System capacity	1	2	3	[Number of horsepower]	[H P]																				
Total capacity of indoor units	1	3	3	[. -]	[-. - -]																				

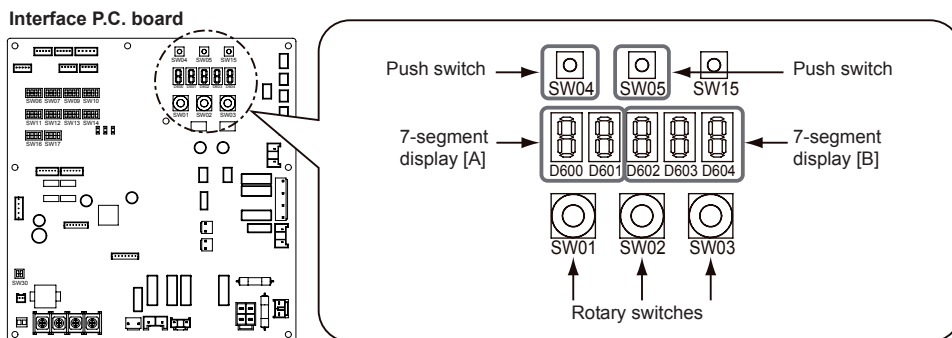

8-4-3. Address setup procedure

No central control (Single refrigerant line): go to Address setting procedure 1
 Central control of 2 or more refrigerant lines: go to Address setting procedure 2

(Example)	When controlling a single refrigerant line centrally	When controlling 2 or more refrigerant lines centrally
Address setting procedure	To procedure 1	To procedure 2
System wiring diagram		

◆ Address setting procedure 1

- 1 Turn on indoor units first, and then turn on outdoor unit.
- 2 About one minute after turning the power on, confirm that the 7-segment display on the interface P.C. board of the outdoor unit indicates U. 1. L08 (U. 1. flash).
- 3 Press SW 15 to start the automatic address setting.
 (It may take up to 10 minutes (normally about 5 minutes) to complete one line's setting.)
- 4 The 7-segment display indicates Auto 1 → Auto 2 → Auto 3.
 After the indication, U. 1. --- (U. 1. flash) starts flashing on the display.
 When the flashing stops and U. 1. --- (U. 1. light) remain lit on the display, the setting is complete.

Interface P.C. board on the outdoor unit

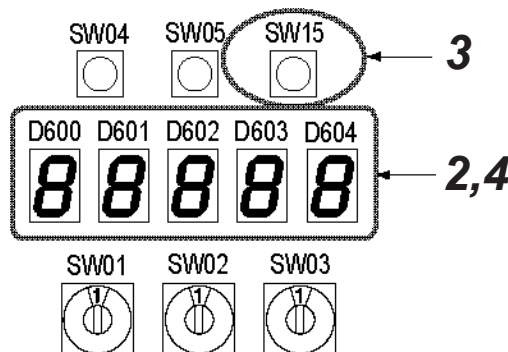

REQUIREMENT

- When 2 or more refrigerant lines are controlled as a group, be sure to turn on all the indoor units in the group before setting addresses.
- If you set the unit addresses of each line separately, each line's header indoor unit is set separately. In that case, the CODE No. "L03" (Indoor outdoor unit overlap) is indicated as running starts. Change the group address to make one unit the outdoor unit using wired remote controller.

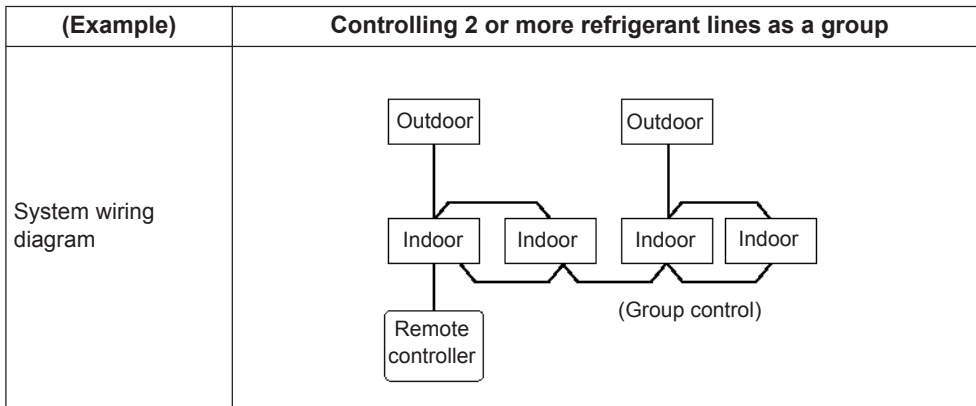

◆ Address setting procedure 2

- 1 Set a line address for each system using SW 13 and 14 on the interface P.C. board on the outdoor unit of each system.
(Factory default: Address 1)

NOTE

Be sure to set a unique address on each system. Do not use a same address as another system (refrigerant line) or a 1-to-1 system side.

Interface P.C. board on the outdoor unit

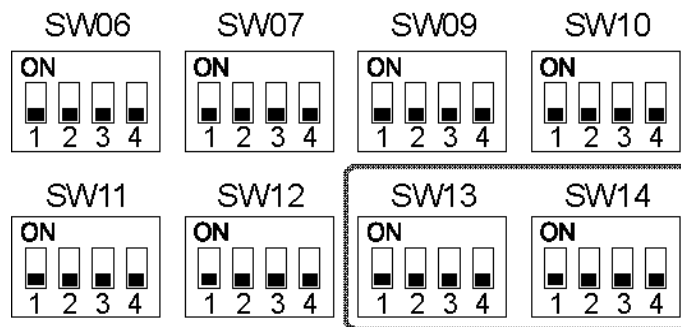

Line address switches on the outdoor interface P.C. board (○: switch on, ×: switch off)

Line address	SW13				SW14			
	1	2	3	4	1	2	3	4
1	■	■	■	■	×	×	×	×
2	■	■	■	■	×	○	×	×
3	■	■	■	■	×	×	○	×
4	■	■	■	■	×	○	○	×
5	■	■	■	■	×	×	×	○
6	■	■	■	■	×	○	×	○
7	■	■	■	■	×	×	○	○
8	■	■	■	■	×	○	○	○
9	■	■	■	■	×	×	×	○
10	■	■	■	■	×	○	×	○
11	■	■	■	■	×	×	○	○
12	■	■	■	■	×	○	○	○
13	■	■	■	■	×	×	×	○
14	■	■	■	■	×	○	×	○
15	■	■	■	■	×	×	○	○
16	■	■	■	■	×	○	○	○
17	■	■	■	■	○	×	×	×
18	■	■	■	■	○	○	×	×
19	■	■	■	■	○	×	○	×
20	■	■	■	■	○	○	○	×
21	■	■	■	■	○	×	×	○
22	■	■	■	■	○	○	×	○
23	■	■	■	■	○	×	○	○
24	■	■	■	■	○	○	○	○
25	■	■	■	■	○	×	×	○
26	■	■	■	■	○	○	×	○
27	■	■	■	■	○	×	○	○
28	■	■	■	■	○	○	○	○

■ Not used for setup of line address (do not change setup.)

- 2** Be sure to disconnect the relay connectors CN10 which mounted interface P.C. board from CN02, on all the outdoor unit that will be connected to the central control.

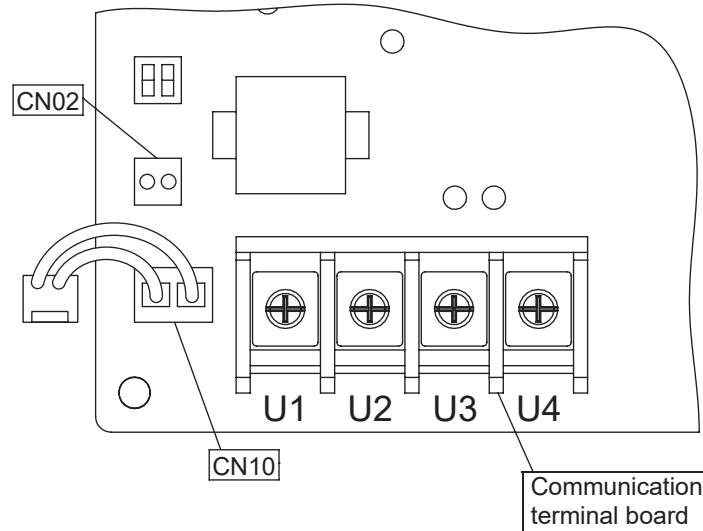

- 3** Turn on indoor units first, and then turn on outdoor unit.
- 4** About 1 minute after turning the power on, confirm that the 7-segment display on the interface P.C. board of the outdoor unit indicates **U. 1. L08 (U. 1. flash)**.
- 5** Press SW 15 to start the automatic address setting.
(It may take up to 10 minutes (normally about 5 minutes) to complete one line's setting.)
- 6** The 7-segment display indicates **Auto 1 → Auto 2 → Auto 3**.
After the indication, **U. 1. --- (U. 1. flash)** starts flashing on the display.
When the flashing stops and **U. 1. --- (U. 1. light)**, remains lit on the display, the setting is complete.
- 7** Repeat steps 4 to 6 for other refrigerant lines.
- 8** After completing address setting of all systems, turn off DIP switch 2 of SW30 on the interface P.C. boards of all the outdoor units connected to the same central control, except the unit that has the lowest address.
(For unifying the termination of the wiring for the central control of indoor and outdoor unit)
- 9** Connect the relay connectors CN10 to CN02, which is mounted on the interface P.C. board of each refrigerant line.

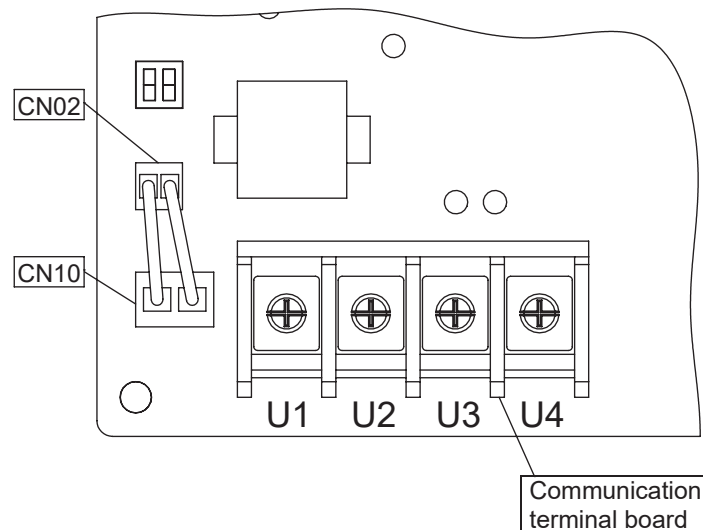

10 Set the central control address.

(For the setting of the central control address, refer to the installation manuals of the central control devices.)

Outdoor unit interface P.C. board

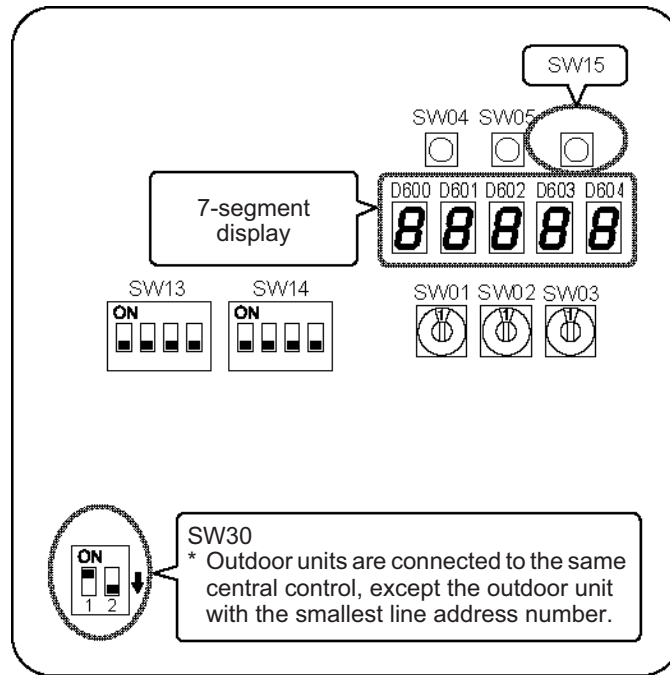

Switch setting (setting example when controlling 2 or more refrigerant lines centrally)

Outdoor units (setting manually)

*The items in bold font must be set manually.

Outdoor unit's interface P.C. board	Outdoor unit	Outdoor unit	Outdoor unit	Factory default
SW13, 14 (Line (system) address)	1	2	3	1
DIP switch 2 of SW30 (Terminator of indoor / outdoor communication line and central control line)	ON	Set to OFF after setting addresses.	Set to OFF after setting addresses.	ON
Relay connector	Connect after setting addresses.	Connect after setting addresses.	Connect after setting addresses.	Open

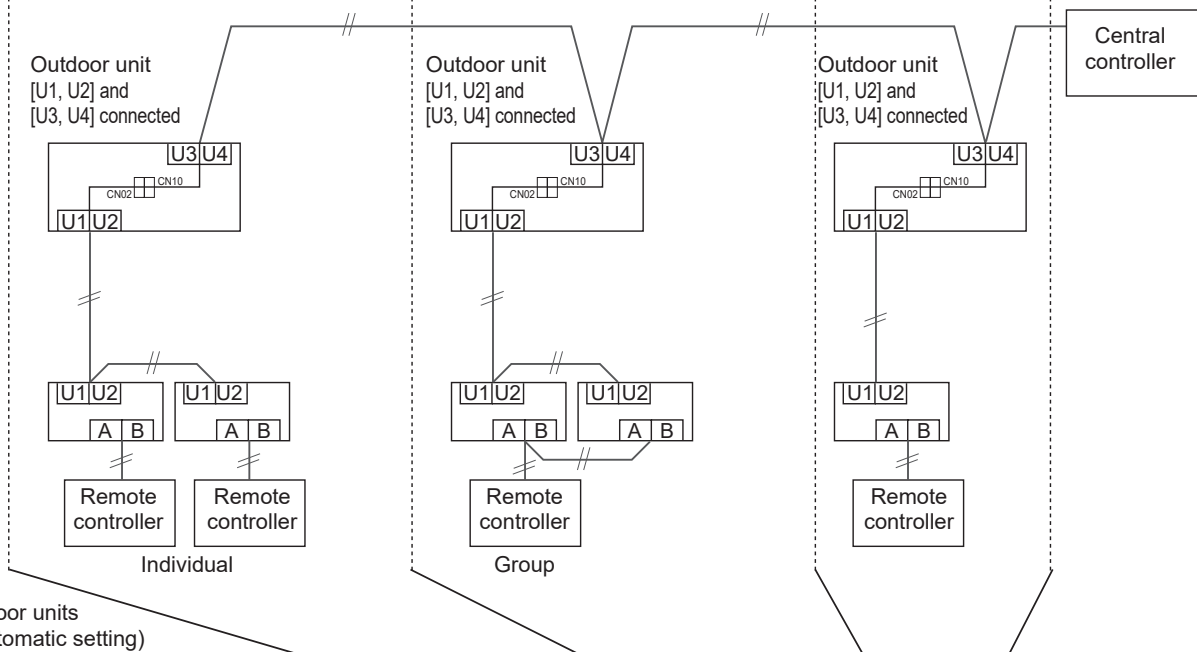

Line (system) address	1	1	2	2	3
Indoor unit address	1	2	1	2	1
Group address	0	0	1	2	0

CAUTION

Relay connector connection

Never connect relay connectors between the [U1, U2] and [U3, U4] terminals before completing address setting of all the refrigerant lines. Otherwise, the addresses cannot be set correctly.

Manual address setting with the remote controller

Procedure when setting indoor units' addresses first under the condition that indoor wiring has been completed and outdoor wiring has not been started (manual setting using the remote controller)

▼ Wiring example of 2 refrigerant lines

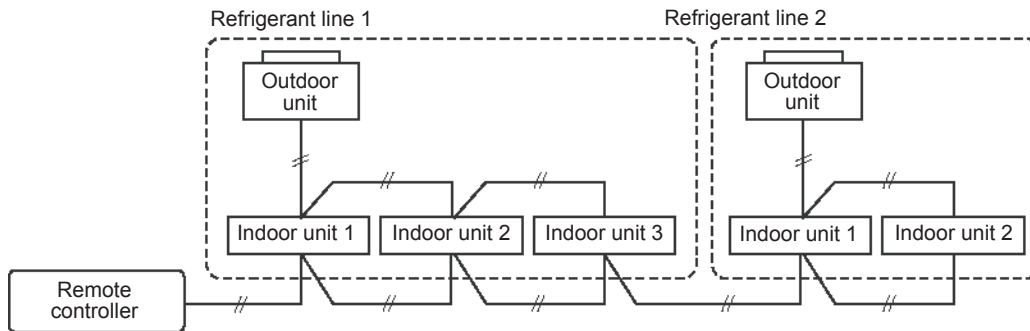

Line (system) address	1	1	1	2	2
Indoor unit address	1	2	3	1	2
Group address	1 Header unit	2 Follower unit	2 Follower unit	2 Follower unit	2 Follower unit

In the example above, disconnect the remote controller connections between the indoor units and connect a wired remote controller to the target unit directly before address setting.

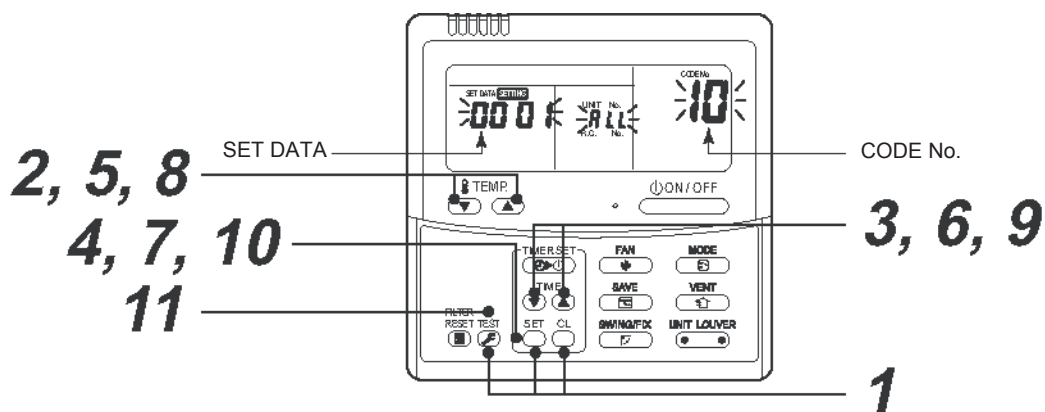

Pair the indoor unit to set and the remote controller one-to-one.

Turn on the power.

- 1 Push and hold the **SET**, **CL**, and **TEST** buttons at the same time for more than 4 seconds. LCD starts flashing.

<Line (system) address>

2 Push the TEMP.  /  buttons repeatedly to set the CODE No. to **12**.

3 Push the TIME  /  buttons repeatedly to set a line address.

(Match the address with the address on the interface P.C. board of the outdoor unit in the same refrigerant line.)

4 Push  button.

(It is OK if the display turns on.)

<Indoor unit address>

5 Push the TEMP.  /  buttons repeatedly to set the CODE No. to **13**.

6 Push the TIME  /  buttons repeatedly to set an indoor unit address.

7 Push the  button.

(It is OK if the display turns on.)

<Group address>

8 Push the TEMP.  /  buttons repeatedly to set the CODE No. to **14**.

9 Push the TIME  /  buttons repeatedly to set a group address. If the indoor unit is individual, set the address to **0000**; header unit, **0001**; follower unit, **0002**.

Individual	: 0000	} In case of group control
Header unit	: 0001	
Follower unit	: 0002	

10 Push the  button.

(It is OK if the display turns on.)

11 Push the  button.

The address setting is complete.

(**SETTING** flashes. You can control the unit after **SETTING** has disappeared.)

NOTE

1. Do not use address numbers **29** or **30** when setting line addresses using the remote controller. These 2 address numbers cannot be used on outdoor units and the CODE No. **[E04]** (Indoor / outdoor communication failure) will appear if they are mistakenly used.
2. If you set addresses to indoor units in 2 or more refrigerate lines manually using the remote controller and will control them centrally, set the outdoor unit of each line as below.
 - Set a line address for the outdoor unit of each line with SW13 and 14 of their interface P.C. boards.
 - Turn off DIP switch 2 of SW30 on the interface P.C. boards of all the outdoor units connected to the same central control, except the unit that has the lowest address. (For unifying the termination of the wiring for the central control of indoor and outdoor units)
 - Connect the relay connectors between the [U1, U2] and [U3, U4] terminals on the outdoor unit of each refrigerate line.
 - After finishing all the settings above, set the address of the central control devices. (For the setting of the central control address, refer to the installation manuals of the central control devices.)

■ Confirming the indoor unit addresses and the position of an indoor unit using the remote controller

◆ Confirming the numbers and positions of indoor units

To see the indoor unit address of an indoor unit having location data.

- ▼ When the unit is individual (the indoor unit is paired with a wired remote controller one-to-one), or it is a group-controlled one.

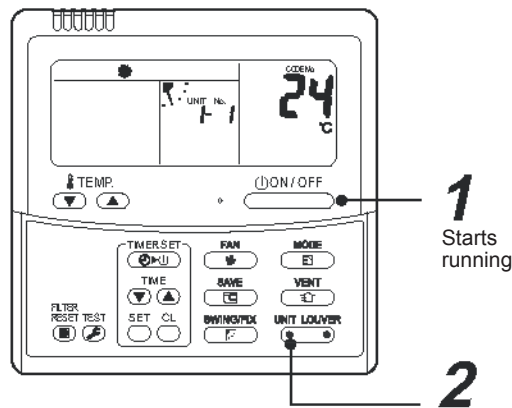

(Execute it while the units are running.)

1 Push the **ON/OFF** button if the units stop.

2 Push the **UNIT LOUVER** button (left side of the button).

A unit numbers **1-1** is indicated on the LCD (it will disappear after a few seconds). The indicated number shows the line address and indoor unit address of the unit.

When 2 or more indoor units are connected to the remote controller (group-controlled units), a number of other connected units appears each time you push the **UNIT LOUVER** button (left side of the button).



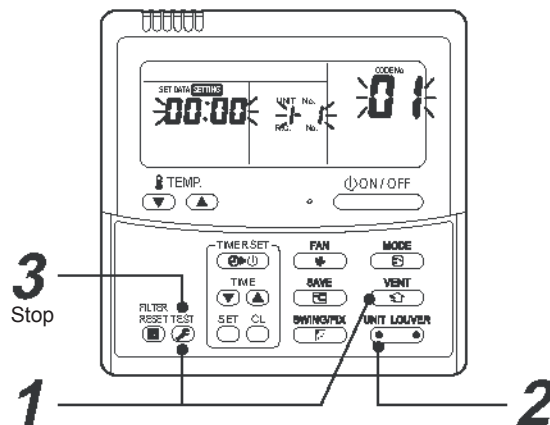

To find an indoor unit's position from its address

- ▼ When checking unit numbers controlled as a group



(Execute it while the units are stopped.)

The indoor unit numbers in a group are indicated one after another. The fan and louvers of the indicated units are activated.





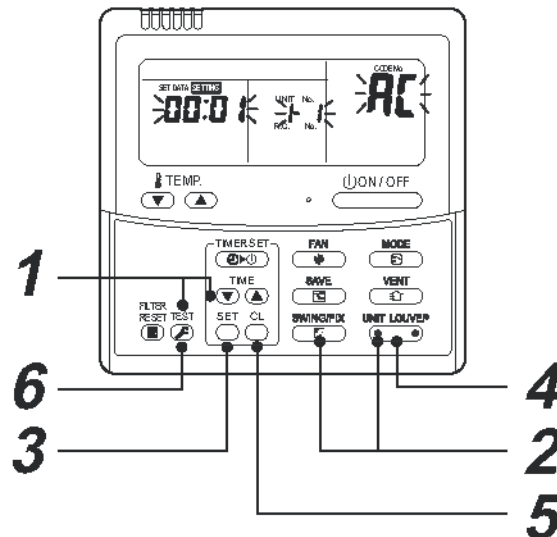

- 1 Push and hold the  and  buttons at the same time for more than 4 seconds.
 - **ALL** appears on UNIT No. on the LCD display.
 - The fans and louvers of all the indoor units in the group are activated.
- 2 Push the  button (left side of the button). Each time you push the button, the indoor unit numbers are indicated one after another.
 - The first-indicated unit number is the address of the outdoor unit.
 - Only the fan and louvers of the indicated indoor unit are activated.
- 3 Push the  button to finish the procedure.
All the indoor units in the group stop.

▼ To check all the indoor unit addresses using an arbitrary wired remote controller.
(When communication wirings of 2 or more refrigerant lines are interconnected for central control)





(Execute it while the units are stopped.)

You can check indoor unit addresses and positions of the indoor units in a single refrigerant line. When an outdoor unit is selected, the indoor unit numbers of the refrigerant line of the selected unit are indicated one after another and the fan and louvers of the indicated indoor units are activated.

- 1 Push and hold the **TIME**  and  buttons at the same time for more than 4 seconds. At first, the line 1 and CODE No. **AC** (Address Change) are indicated on the LCD display. (Select an outdoor unit.)
- 2 Push the  (left side of the button) and  buttons repeatedly to select a line address.
- 3 Push the  button to confirm the line address selection.
 - The address of an indoor unit connected to the selected refrigerant line is indicated on the LCD display and its fan and louvers are activated.
- 4 Push the  button (left side of the button). Each time you push the button, the indoor unit numbers of the selected refrigerant line are indicated one after another.
 - Only the fan and louvers of the indicated indoor unit are activated.

◆ To select another line address

- 5 Push the  button to return to step 2.
 - After returning to step 2, select another line address and check the indoor unit addresses of the line.
- 6 Push the  button to finish the procedure.







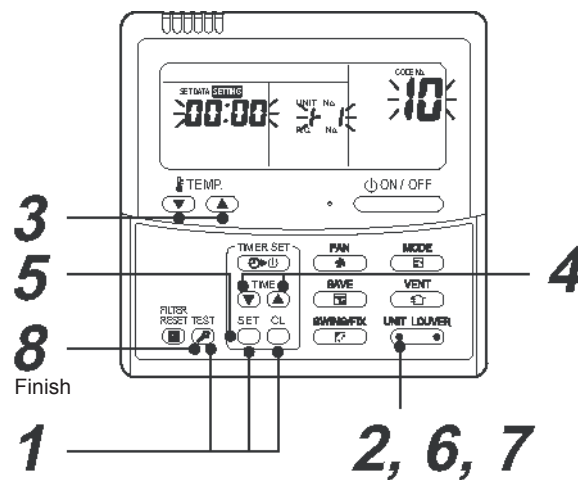





■ Changing the indoor unit address using a remote controller

To change an indoor unit address using a wired remote controller.

- ▼ The method to change the address of an individual indoor unit (the indoor unit is paired with a wired remote controller one-to-one), or an indoor unit in a group.
 (The method is available when the addresses have already been set automatically.)



(Execute it while the units are stopped.)

- 1 Push and hold the , , and  buttons at the same time for more than 4 seconds.
 (If 2 or more indoor units are controlled in a group, the first indicated UNIT No. is that of the head unit.)
- 2 Push the  button (left side of the button) repeatedly to select an indoor unit number to change if 2 or more units are controlled in a group. (The fan and louvers of the selected indoor unit are activated.)
 (The fan of the selected indoor unit is turned on.)
- 3 Push the TEMP.  /  buttons repeatedly to select **13** for CODE No.
- 4 Push the TIME  /  buttons repeatedly to change the value indicated in the SET DATA section to that you want.
- 5 Push the  button.
- 6 Push the  button (left side of the button) repeatedly to select another indoor UNIT No. to change.
 Repeat steps 4 to 6 to change the indoor unit addresses so as to make each of them unique.
- 7 Push the  button (left side of the button) to check the changed addresses.
- 8 If the addresses have been changed correctly, push the  button to finish the procedure.

- ▼ To change all the indoor unit addresses using an arbitrary wired remote controller.
(The method is available when the addresses have already been set automatically.)

(When communication wirings of 2 or more refrigerant lines are interconnected for central control)

NOTE

You can change the addresses of indoor units in each refrigerant line using an arbitrary wired remote controller.

- * Enter the address check / change mode and change the addresses.

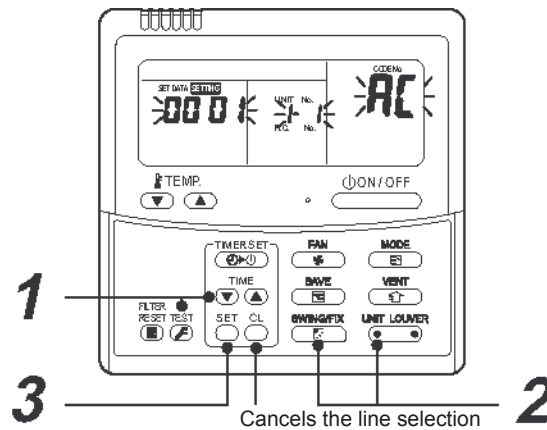

If no number appears on UNIT No., no outdoor unit exists on the line. Push button and select another line following step 2.

(Execute it while the units are stopped.)

- 1 Push and hold the TIME and buttons at the same time for more than 4 seconds.
At first, the line 1 and CODE No. **AC** (Address Change) are indicated on the LCD display.
- 2 Push (left side of the button) and buttons repeatedly to select a line address.
- 3 Push the button.
 - The address of one of the indoor units connected to the selected refrigerant line is indicated on the LCD display and the fan and louvers of the unit are activated.
At first, the current indoor unit address is displayed in SET DATA.
(No line address is indicated.)

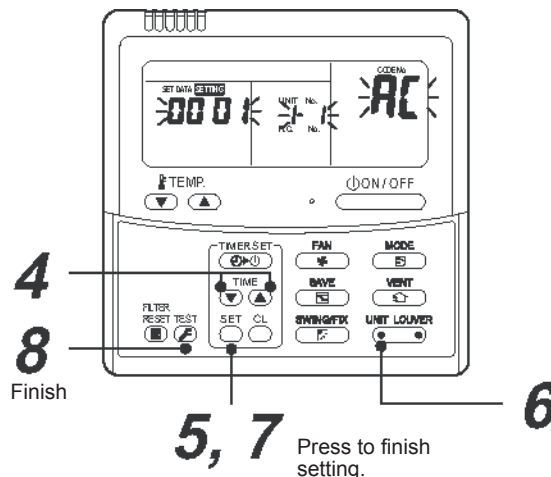

- 4** Push the TIME \blacktriangledown / \blacktriangle buttons repeatedly to change the value of the indoor unit address in SET DATA.
Change the value in SET DATA to that of a new address.
- 5** Push the SET button to confirm the new address on SET DATA.
- 6** Push the UNIT LOUVER button (left side of the button) repeatedly to select another address to change.
Each time you push the button, the indoor unit numbers in a refrigerant line are indicated one after another. Only the fan and louvers of the selected indoor unit are activated.
Repeat steps 4 to 6 to change the indoor unit addresses so as to make each of them unique.
- 7** Push the SET button.
(All the segments on the LCD display light up.)
- 8** Push the TEST button to finish the procedure.

■ Resetting the address (Resetting to the factory default (address undecided))

Method 1

Clearing each address separately using a wired remote controller.

Set the line address, indoor unit address and group address to "0099", using a wired remote controller.

(For the setting procedure, refer to the address setting procedures using the wired remote controller on the previous pages.)

Method 2

Clearing all the indoor unit addresses on a refrigerate line at once from the outdoor unit.

1 Turn off the refrigerant line to reset to the factory default and set the outdoor unit of the line as below.

- 1) Remove the relay connectors CN10 from CN02.
- 2) If the DIP switch 2 of SW30 which is mounted on the interface P.C. board is OFF, turn on switch.

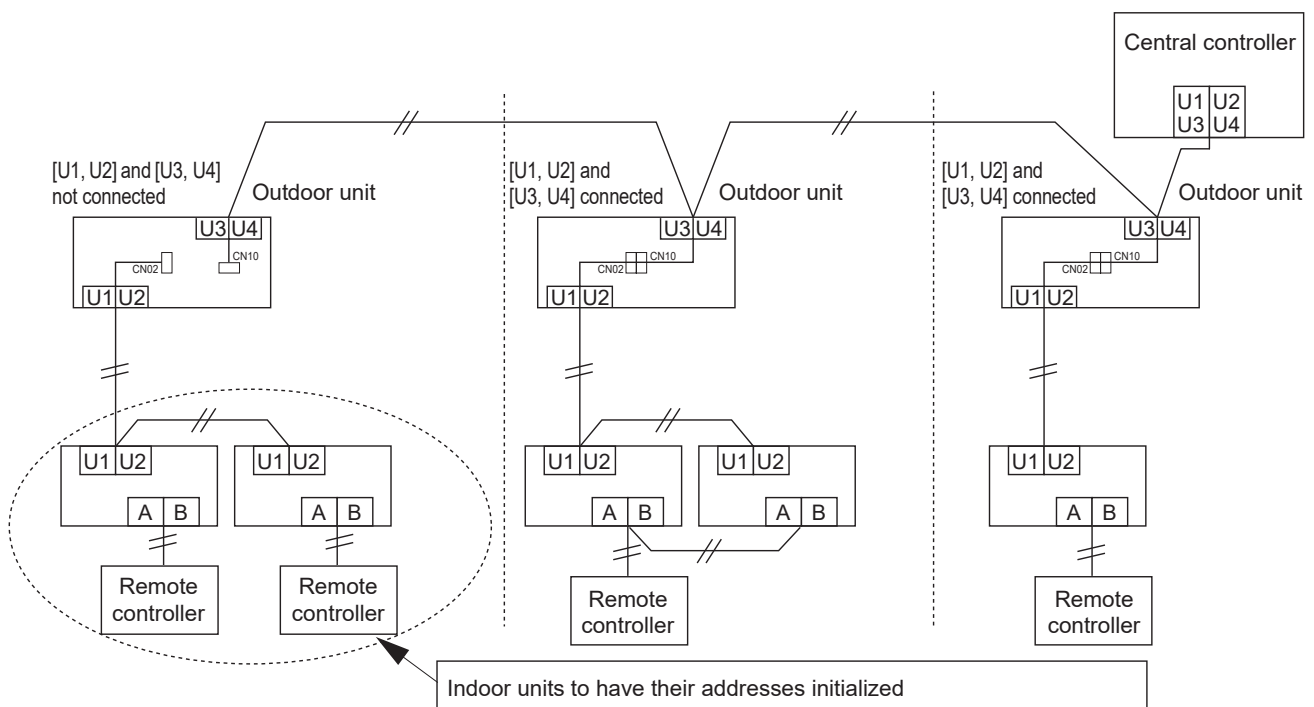

2 Turn on the indoor and outdoor units of the refrigerant line to be initialized in addresses. About one minute after turning on the power, confirm that the 7-segment display on the outdoor unit indicates “U.1. - -” and operate the interface P.C. board on the outdoor unit of the refrigerant line as follows.

SW01	SW02	SW03	SW04	Clearable addresses
2	1	2	Confirm that the 7-segment display indicates “A.d.buS” and turn SW04 ON for more than five seconds.	System / indoor unit / group address
2	2	2	Confirm that the 7-segment display indicates “A.d.nEt” and turn SW04 ON for more than five seconds.	Central control address

3 Confirm that the 7-segment display indicates “A.d. C.L.” and set SW01, SW02 and SW03 to 1, 1, 1 respectively.

4 After a time “U.1.L08” appears on the 7-segment display if the address clearing has been completed successfully. If the 7-segment display indicates “A.d. n.G.”, the outdoor unit may still be connected with other refrigerant lines. Check the connection of the relay connectors between [U1, U2] and [U3, U4].

NOTE

Take care to carry out the procedure above correctly; otherwise, addresses in other refrigerant lines may also be cleared.

5 Set the addresses again after finishing the clearance.

■ In the case of an increase in address-undefined indoor units (extension, etc.)

To set up the indoor address of a unit with an address that is undefined due to the extension of indoor units or replacement of P.C. board, etc., follow the methods below.

Method 1

Set up an address individually from a wired remote controller.

(Line address, Indoor address, Group address, Central address)

For the setup method, refer to “Manual address setup from the remote controller.” above.

Method 2

Set up an address from the outdoor unit.

* Leave the addresses of the units for which addresses have already been set up as they are. Set up an address only for the unit where the address is undefined. Addresses are allocated from lower numbers.

Setup procedure

Set up the outdoor units in the refrigerant line to which indoor units have been added, as follows.

- 1 Remove the relay connector between U1 / U2 and U3 / U4.**
- 2 Turn on SW30-bit2 on the interface P.C. board in the outdoor unit.**
*Turn off the power, and then execute the operation.

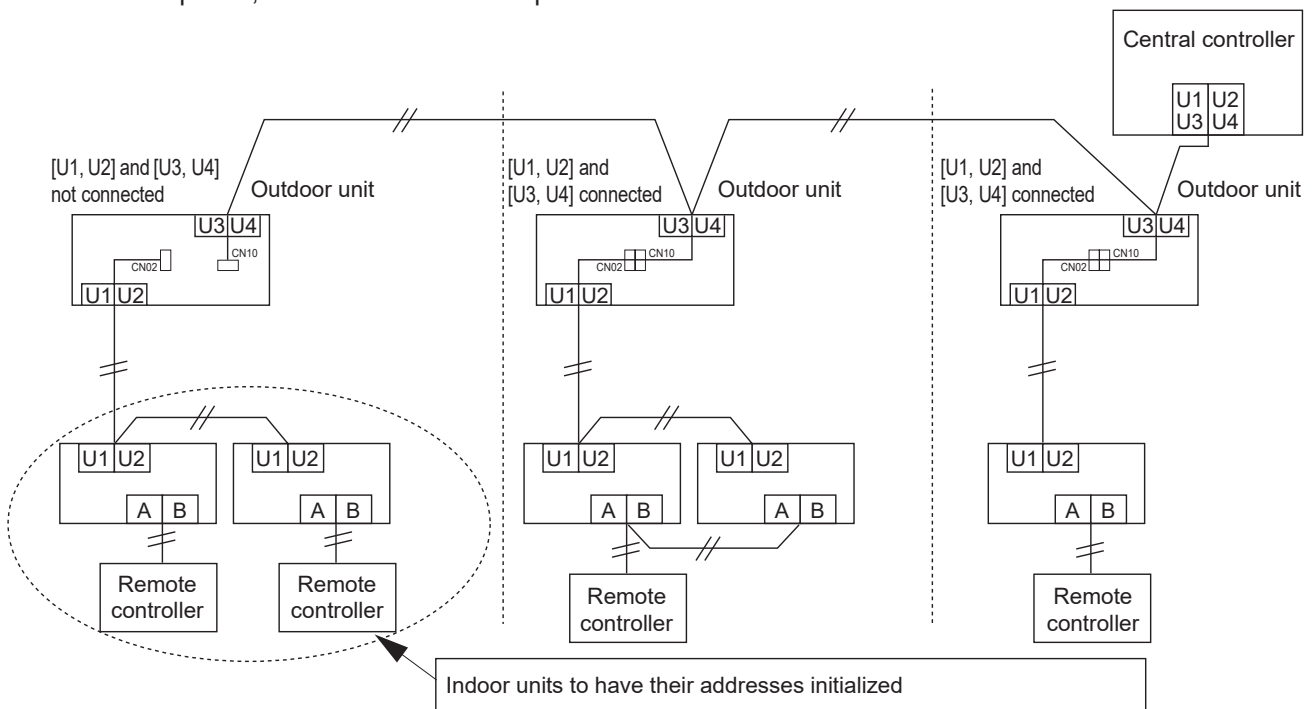

- 3 Turn on the indoor / outdoor power for the refrigerant line for which an address is to be set up. After approximately 1 minute, check that “U.1. - - -” is displayed on the 7-segment display.**
- 4 Execute the following operation on the interface P.C. board of the outdoor unit.**

SW01	SW02	SW03	SW04
2	14	2	After checking that “In.At” is displayed on the 7-segment display, push SW04 for 5 seconds or more.

“AUTO1” → “AUTO2” → “AUTO3” → ... → “AUTO9” ... is counted and displayed on the 7-segment display.

- 5 When “U.1. - - -” is displayed on the 7-segment display, the setup operation finished.**

Turn off the indoor / outdoor power.

- 6 Return to the following setup as before.**

- Relay connector CN10
- SW30-bit 2
- SW01, SW02, SW03

8-4-4. Check after address setup when central control system is connected

When the central control system is connected, check that the following setup has finished after address setup.

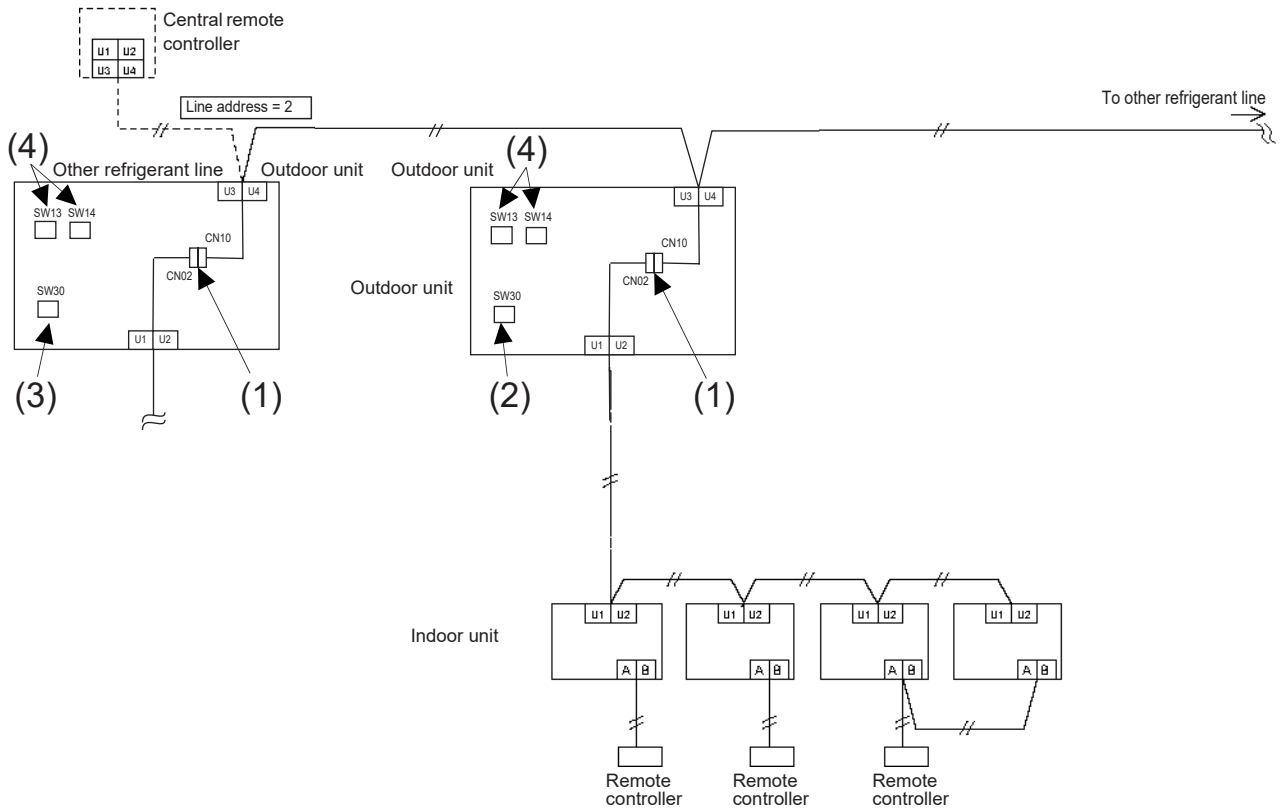

	Main check items	Check
Relay connector	(1) Is the relay connectors CN10 which mounted on the interface P.C. board on the outdoor unit connect to the CN02 after address setup?	
Terminal resistance	(2) Is the terminator resistor (SW30-bit 2) of the outdoor unit with the smallest line address number in the central control turned on?	
	(3) Is the terminator resistor (SW30-bit 2) of the outdoor unit, except for the line with the smallest central control line address, turned off?	
Line address	(4) Are addresses in the line address (SW13, SW14) not duplicated in each refrigerant line?	

NOTE

The figure above does not show all the electric wires.

For details, refer to the installation manuals for the outdoor unit, indoor unit, remote controller, or optional devices.

8-5. Troubleshooting in test operation

If there are phenomena such as the output of a check code or the remote controller is not accepted when powered-on after wiring work or during address setup operation, the following causes are considered.

8-5-1. A check code is displayed on the remote controller

Check the code displayed on the indoor remote controller	Outdoor unit 7-segment display	Cause	Countermeasures
E04	–	When outdoor power is off	Check that the outdoor unit power is on
	L08	Address setup trouble <ul style="list-style-type: none"> • Only line addresses of the connected indoor units are undefined. • The outdoor line address and the line addresses of all the indoor units do not match. • The indoor addresses are duplicated. (Units except those displaying E04 are duplicated.) 	Set up the address again.
	E08 ⇔ -XX Alternate blinking	Duplication of indoor addresses (address number in the sub code of the check code are duplicated).	Set up the address again.
	E07	Indoor / Outdoor communication circuit trouble. (Detected by outdoor side)	Check SW30 bit 2 of the outdoor unit. No connection between multiple refrigerant lines: SW30 bit 2 is on. Check the communication connector between indoor and outdoor unit.
		Transmission circuit trouble at the interface side (P.C.board failure)	Replace the interface P.C. board.
E06	After address setup, communication from all the indoor units is interrupted under the condition that a normal operation can be performed.	Check and correct disconnection of the indoor / outdoor communication line. Check for the influence of communication noise.	
E16	E16 ⇔ -XX Alternate blinking	Exceeded the number or capacity of connected indoor units	Adjust the number or capacity of connected indoor units.
L04	L04	Duplication of outdoor line addresses <ul style="list-style-type: none"> • Line address setup trouble (occurred after connection between U1 / U2 and U3 / U4 connectors) 	Modify the line address setup of the outdoor unit between lines. (Set up SW13 and SW14 on the interface P.C. board.)
L05(*)	L06	Duplication of indoor units with priority	Set up priority only for one indoor unit.
L06(*)		There are two or more indoor units set up with priority.	Among indoor units indicating "L05," set one unit with priority.
L08	L08	Address setup trouble <ul style="list-style-type: none"> • Only indoor addresses of all the connected indoor units are undefined. 	Set up the addresses again. Modify the setup.

* "L05": Displayed on the indoor unit set up with priority

"L06": Displayed on the indoor units except the one set up with priority

8-5-2. Operation from the indoor remote controller is not accepted, and a check code is displayed on the 7-segment display of the interface P.C. board of the outdoor unit.

Indoor remote controller status	Outdoor unit 7-segment display	Cause	Countermeasures
No response	L08	Line addresses and indoor addresses of all the connected indoor units are not set.	Set up addresses.
	E19 ↔ -00 Alternate blinking	Indoor unit power is not turned on.	Turn on the power again. (In the order: indoor → outdoor)
		Indoor / outdoor communication line is not correctly connected to the U1 / U2 terminal of the outdoor unit. (Indoor / outdoor cannot communicate before address setup.)	Correct wiring
E20 ↔ -01 Alternate blinking	Address setup is performed under the condition of connecting multiple refrigerant lines.	Correct wiring	

8-5-3. There is no display of a check code on the 7-segment display on the interface P.C. board of the outdoor unit, although there is indoor unit that is not accepting operation from the indoor remote controller.

Indoor remote controller status	Outdoor unit 7-segment display	Cause	Countermeasures
No response	None	The communication line is not connected between indoor and outdoor (the unit that does not respond to the indoor remote controller).	Modify the wiring.
		Line address and indoor address are not set (the unit that does not respond to the indoor remote controller).	Set up the address.
		The power of the outdoor unit of the group is not turned on in indoor group control (the unit that does not respond to the indoor remote controller).	Turn on the power.
		Group address is set to the follower unit for individual control (the unit that does not respond to the indoor remote controller).	Set the group address to "0" in the case of individual control.
No display on the indoor remote controller (No frame line is displayed.)	None	The power is not turned on (the unit that is not displayed on the indoor remote controller).	Turn on the power.
		The indoor remote controller is not connected with a wire (the unit that is not displayed on the indoor remote controller).	Modify the wiring.
		Miswiring of the indoor remote controller (the unit that is not displayed on the indoor remote controller)	Modify the wiring.
		Indoor remote controller communication circuit trouble (the unit that is not displayed on the indoor remote controller) If 220-240 V is incorrectly applied to the indoor remote controller terminal, the remote controller communication circuit fails.	Remove the quick connect terminal connected to indoor remote controller terminals A / B, and check the voltage. If voltage is not applied (normally 15 to 18 V), replace the P.C. board.

8-5-4. In checking the number of connected outdoor units and connected indoor units after address setup, a lower number of connected units is displayed. (There are outdoor / indoor units that do not operate in a test operation.)

Status	Cause	Countermeasures
The number of connected indoor units is too few.	Miswiring of communication lines between indoor units or an unconnected wire. (Address setup operation finished without recognizing a miswired indoor unit.)	After modification of wiring, set up the addresses again and check the number of connected indoor units.
The number of outdoor units connected to a group is too few in group operation from an indoor remote controller.	The indoor remote controller is not connected with wire. Miswiring of the indoor remote controller	Using the main indoor remote controller connected to a group, start a test operation, specify the unit that is not operating (the unit not connected to the group), and then check the wiring.
	Indoor remote controller communication circuit trouble. If 220-240 V is incorrectly applied to the remote controller terminal, the remote controller communication circuit fails.	Using the main indoor remote controller connected to a group, start a test operation and then specify the unit that is not operating (the unit not connected to the group). Remove the quick connect terminal connected to remote controller terminals A / B, and check the voltage. If voltage is not applied (normally 15 to 18 V), replace the P.C. board.

8-6. Test operation check

8-6-1. Fan check

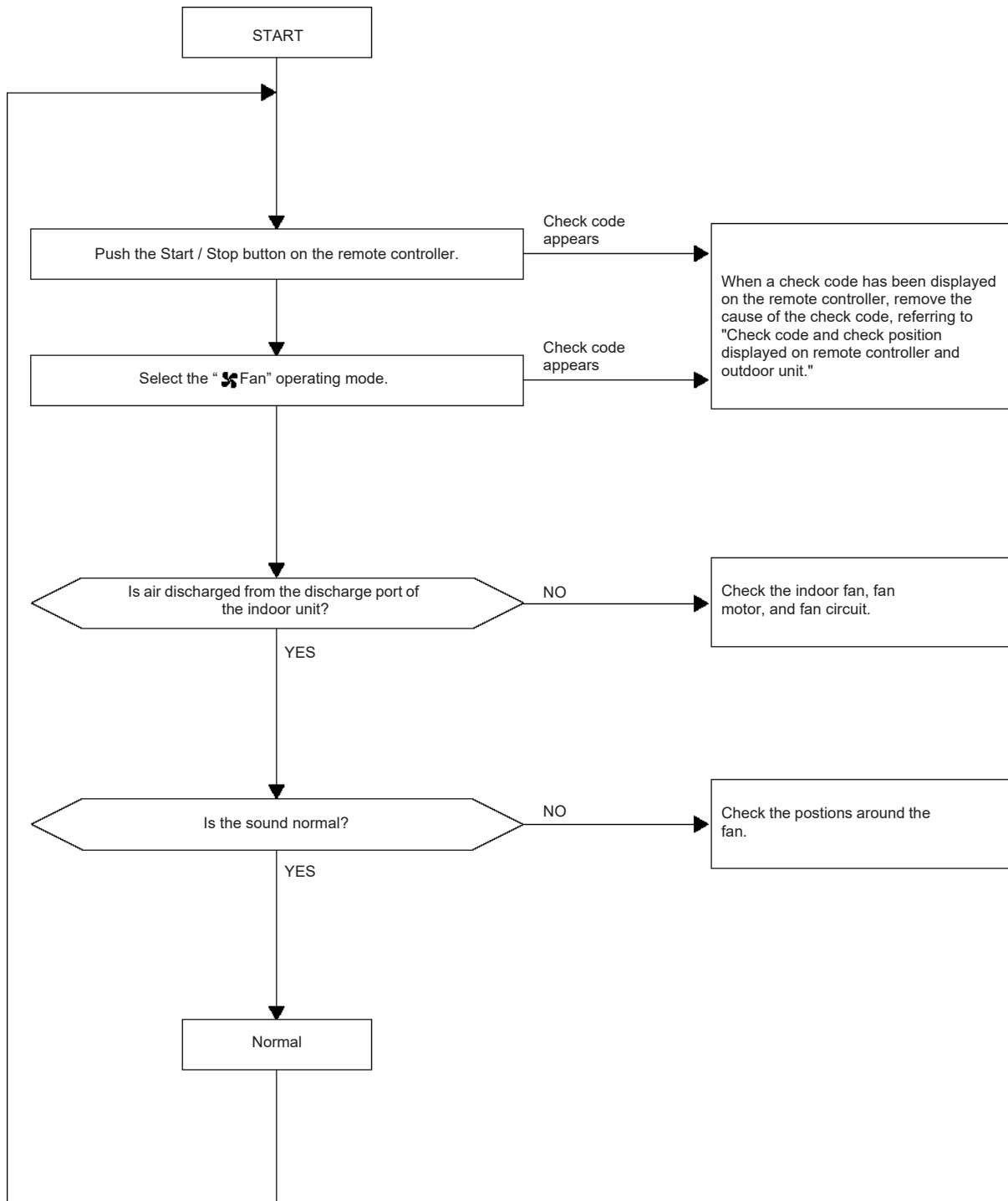

Check every indoor unit in turn.

8-6-2. Cooling / Heating test operation check





The cooling / heating test operation check can be performed on both the indoor remote controller and the outdoor unit interface P.C. board.

(1) Test operation start / stop operation

Test operation from the indoor remote controller

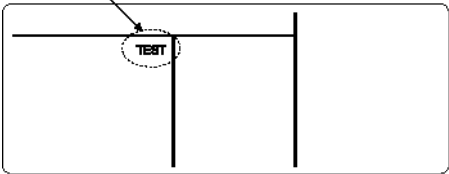
- Wired remote controller: Refer to the items below in “Test operation” of the wired remote controller.
- Wireless remote controller: Refer to the items below in “Test operation” of the wireless remote controller.
- Lite-Vision plus remote controller : Refer to the installation manual of RBC-AMS51E

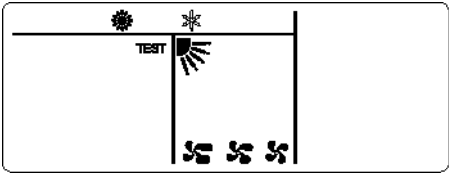
▼ Wired remote controller

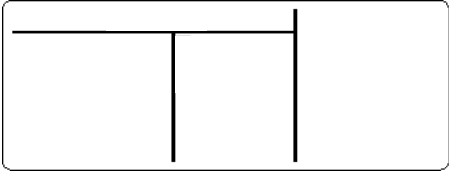
Procedure	Operation content
1	When the Test button is pushed for 4 seconds or more, “TEST” is displayed in the display section, and the unit enters test operating mode. 
2	Push the  button.
3	Using the Select Mode button, select the “❄️ COOL” or “❄️ HEAT” operating mode. • Do not use an operating mode other than “❄️ COOL” or “❄️ HEAT”. • Temperature adjustment is unavailable during test operation. • Check code is detected as usual. 
4	When the test operation has finished, push the  button to stop the operation. (The same display as in procedure 1 appears in the display section.)
5	Push the Test button to clear the test operating mode. (“TEST” disappears from the display section, and the status returns to the normal stopped status.) 

▼ Wireless remote controller (Except the 4-way Cassette type and the Ceiling type)

Procedure	Operation content
1	Start Push Temporary operation button. • The operation mode is the one last selected. If you want to change it, turn the power off and then on, and push the Temporary operation button again.
2	Stop Push Temporary operation button once more.

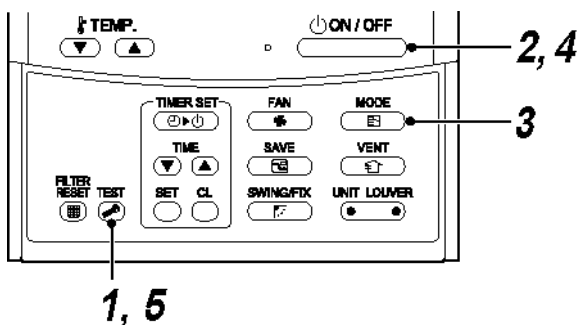
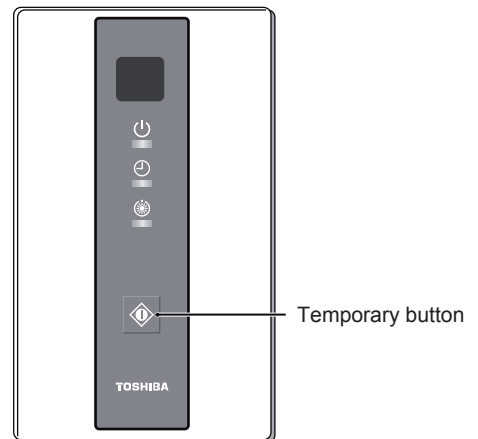

▼ Wireless remote controller (4-way Cassette type)

Procedure	Operation content
1	<p>When Temporary button is pushed for 10 seconds or more, "Pi!" sound is heard and the operation changes to a forced cooling operation. After approx. 3 minutes, a cooling operation starts forcibly.</p> <p>Check cool air starts blowing. If the operation does not start, check wiring again.</p>
2	<p>To stop a test operation, push Temporary button once again (approx. 1 second).</p> <ul style="list-style-type: none"> • Check wiring / piping of the indoor and outdoor units in forced cooling operation.

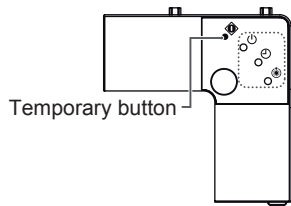

▼ Wireless remote controller (Ceiling type and 1-way Cassette SH type)

Procedure	Operation content
1	<p>Start</p> <p>Push Temporary operation button.</p> <ul style="list-style-type: none"> • The operation mode is the one last selected. If you want to change it, turn the power off and then on, and push the Temporary operation button again.
2	<p>Stop</p> <p>Push Temporary operation button once more.</p>

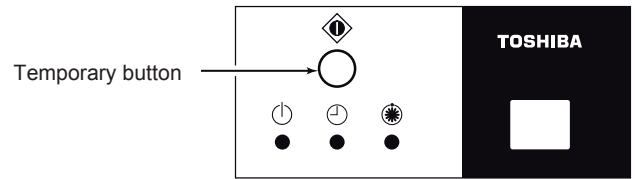

Test operation from the outdoor unit

- Refer to "8-7-2. Function to start / stop (ON / OFF) indoor unit from outdoor unit" in "8-7. Service support function".

Note: The test operation returns to normal operating mode after 60 minutes.

(2) Test operation

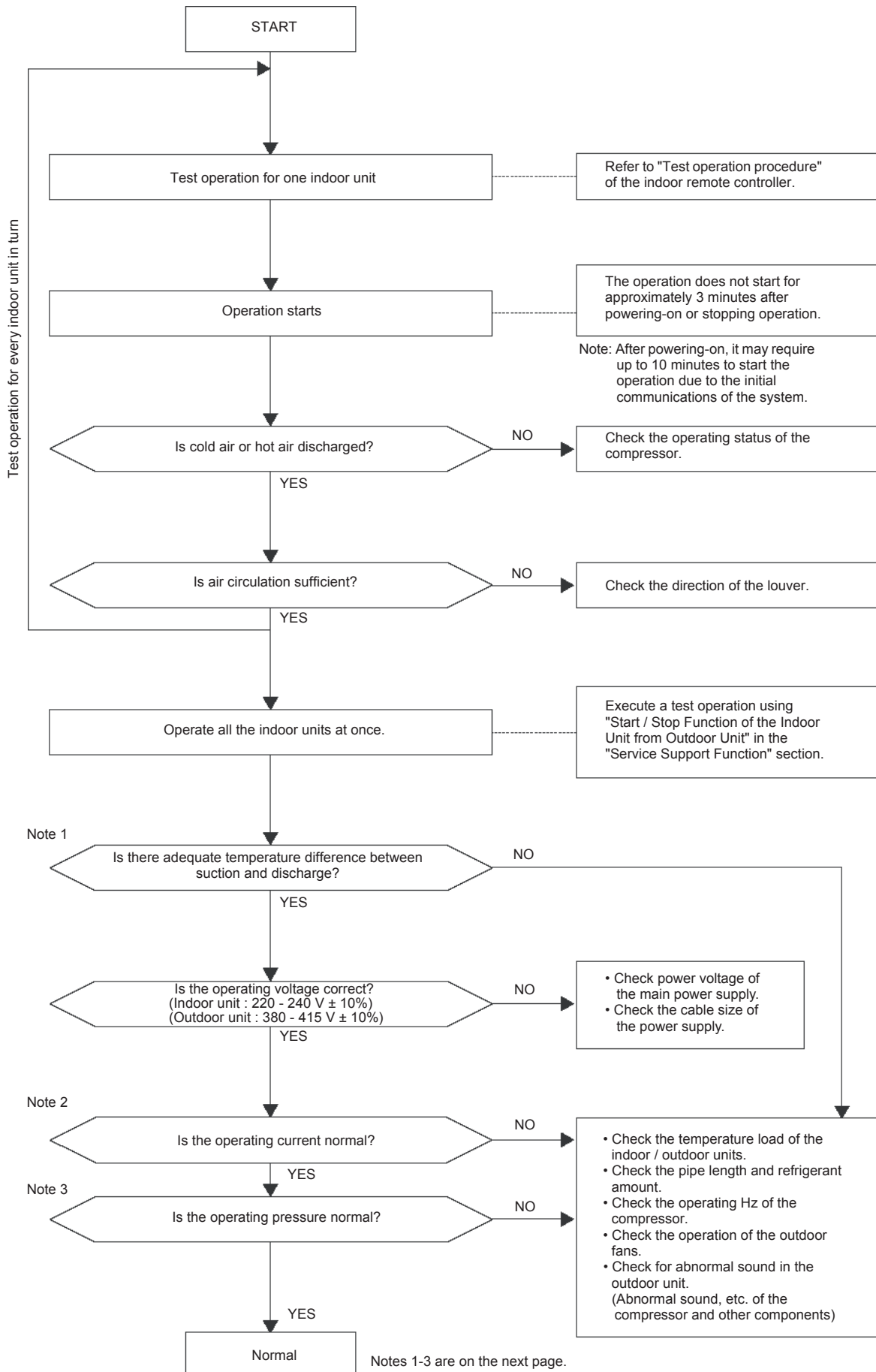

Note 1: Criteria for the difference between suction and discharge temperatures

(1) Cooling operation

After operating for a minimum of 30 minutes in “COOL” mode, if the ΔT dry bulb temperature difference between suction and discharge air of the indoor unit is 8 °C or more, it is normal.

(2) Heating operation

After operating for a minimum of 30 minutes in “HEAT” mode, if the ΔT dry bulb temperature difference between suction and discharge air of the indoor unit is 15 °C or more, it is normal.

* If demand from the indoor unit on the outdoor unit is low because the difference between the temperature set by the remote controller and the temperature of the room is small, then the ΔT temperature difference is small.

* Consider that ΔT temperature difference may diminish in cases of a system in which the connected indoor unit capacity exceeds the outdoor unit capacity, the pipe length is long, or a large difference exists among outdoor units.

Note 2: Criteria for operating power current

The table below shows the maximum current for each outdoor unit. Under standard conditions, operating current is about 80 % of the value shown in the table below.

Outdoor unit	MCY-MHP	0806	0906	1006
Current value	(A)	17.0	18.5	20.0

Note 3: Criteria for cycle status

(1) These data are based on operating a 4-way Cassette type air conditioner of 100 % connection with standard piping length.

Data may vary depending on temperature conditions, installed pipe length, and room shape combinations, or indoor unit connection capacity.

For pressure criteria in different temperature conditions, refer to (2).

For Europe and Turkey model

Outdoor unit MCY-MHP	Operating mode	Pressure(MPa)		Pipe surface temperature (°C)					Compressor drive revolution frequency (rps)*	Indoor fan	Air temperature condition (DB/WB)(°C)	
		Pd	Ps	Discharge (TD)	Suction (TS1)	Indoor heat exchanger (TC)	Outdoor heat exchanger (TE)	Liquid temperature (TL3)			Indoor	Outdoor
0806HS8	Cooling	3.0	0.9	82	14	11	41	28	62	High	27/19	35/-
	Heating	2.5	0.7	69	1	28	1	28	57	High	20/-	7/6
1006HS8	Cooling	3.3	0.9	90	14	10	41	26	82	High	27/19	35/-
	Heating	2.7	0.7	77	1	28	1	27	71	High	20/-	7/6

For China model

Outdoor unit MCY-MHP	Operating mode	Pressure(MPa)		Pipe surface temperature (°C)					Compressor drive revolution frequency (rps)*	Indoor fan	Air temperature condition (DB/WB)(°C)	
		Pd	Ps	Discharge (TD)	Suction (TS1)	Indoor heat exchanger (TC)	Outdoor heat exchanger (TE)	Liquid temperature (TL3)			Indoor	Outdoor
0806HT8	Cooling	3.1	0.9	85	14	11	41	28	67	High	27/19	35/-
	Heating	2.6	0.7	77	1	30	1	27	71	High	20/-	7/6
0906HT8	Cooling	3.2	0.9	87	14	11	41	27	71	High	27/19	35/-
	Heating	2.7	0.7	78	0	32	0	27	76	High	20/-	7/6
1006HT8	Cooling	3.3	0.9	90	14	10	41	26	77	High	27/19	35/-
	Heating	2.7	0.6	79	0	32	0	26	79	High	20/-	7/6

* This compressor is driven with a 4-pole motor. The value of the compressor frequency (rps) measured with a clamp meter at the compressor lead line is two times the rotation count (rps) of the compressor.

* The temperature of the indoor heat exchanger (TC) indicates TCJ sensor temperature when cooling, and TC2 sensor temperature when heating, respectively.

(2) Criteria for operating pressure

Operating mode	Cooling	Heating	
Indoor temperature (°C)	18~32	15~25	
Outdoor temperature (°C)	25~35	5~10	
Pressure	High pressure (MPa)	2.0~3.7	2.5~3.3
	Low pressure (MPa)	0.5~0.9	0.5~0.7

* Criteria after 15 minutes or more has passed since operating started

(3) On rotations of outdoor fans

Outdoor fans may rotate slowly to control pressure when cooling with low outer air temperature or heating with excessive load. For control content, also refer to items in Section 6, “Control Outline: Outdoor Unit, Outdoor Fan Control.”

8-7. Service support function

8-7-1. Check function for connecting of refrigerant and control lines

This function is provided to check misconnection of the refrigerant pipes and the control transmission line (Wiring over lines) between indoor unit and outdoor unit by using the switch on the interface P.C. board of the outdoor unit. However, be sure to check the following items prior to executing this check function.

1 This check function does not work when a group operation by remote controller is performed and it is used over outdoor units.

2 When using this check system, be sure to check for each 1 line in the unit of outdoor unit. If checking the multiple lines at the same time, misjudgment may be caused.

(Check procedure)

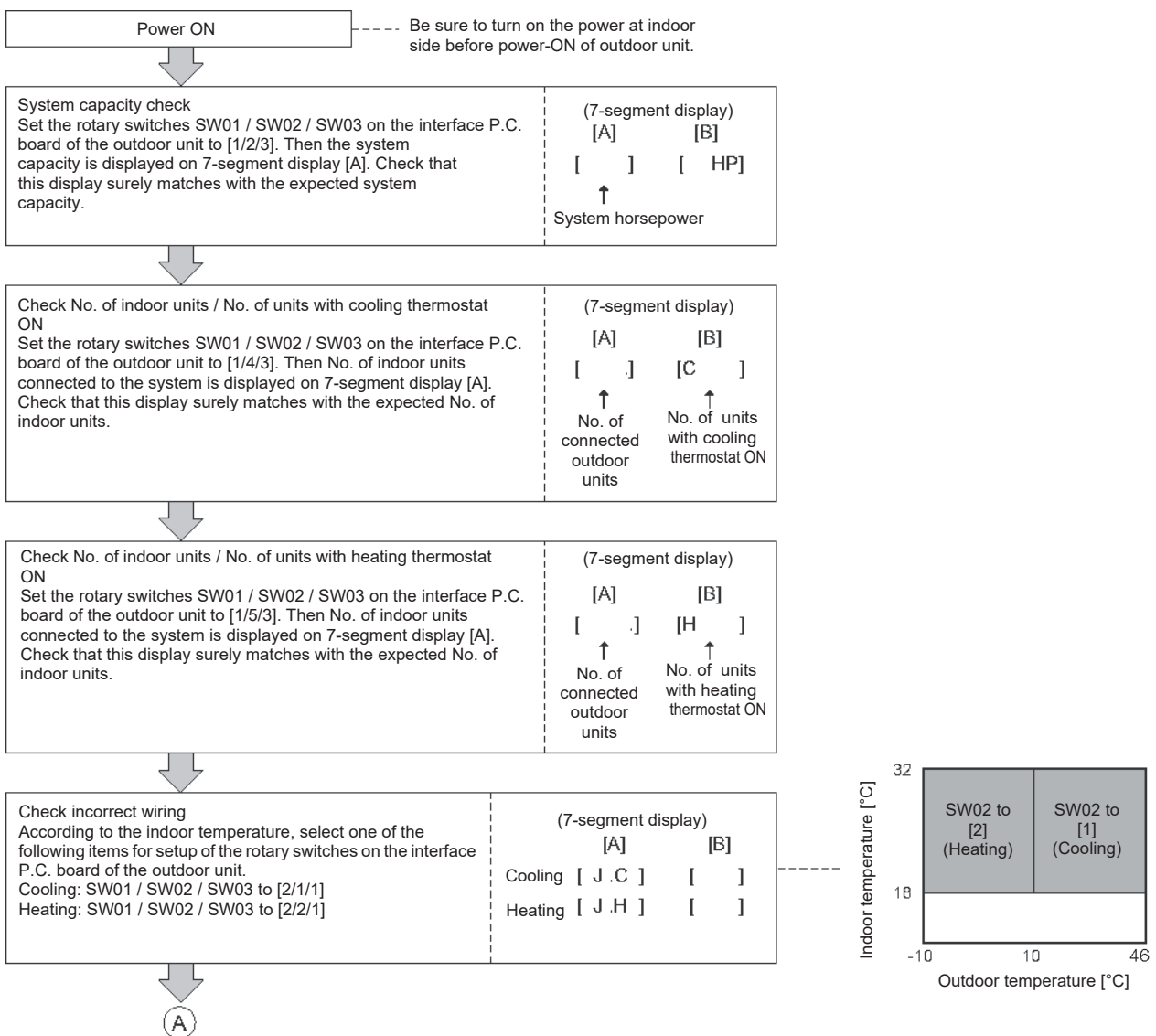



<p>Operation start Press the push-switch SW04 on the interface P.C. board of the outdoor unit for 2 seconds or more. The operation starts. Check that 7-segment display [B] shows [CC] for cooling and [HH] for heating.</p>	<p>(7-segment display)</p> <table style="width: 100%; border-collapse: collapse;"> <tr> <td style="width: 50%; text-align: center;">[A]</td> <td style="width: 50%; text-align: center;">[B]</td> </tr> <tr> <td style="text-align: center;">Cooling [C.]</td> <td style="text-align: center;">[CC]</td> </tr> <tr> <td style="text-align: center;">Heating [H.]</td> <td style="text-align: center;">[HH]</td> </tr> </table>	[A]	[B]	Cooling [C.]	[CC]	Heating [H.]	[HH]
[A]	[B]						
Cooling [C.]	[CC]						
Heating [H.]	[HH]						

----- Operation



<p>Confirmation of check results (1) Check that No. of misconnected indoor units is displayed on 7-segment display [B] after 15 minutes. (If there is no misconnection, [00P] is displayed.)</p>	<p>(7-segment display)</p> <table style="width: 100%; border-collapse: collapse;"> <tr> <td style="width: 50%; text-align: center;">[A]</td> <td style="width: 50%; text-align: center;">[B]</td> </tr> <tr> <td style="text-align: center;">[]</td> <td style="text-align: center;">[# # P]</td> </tr> <tr> <td style="text-align: center;">↑</td> <td style="text-align: center;">↑</td> </tr> <tr> <td style="text-align: center;">C.or H.</td> <td style="text-align: center;">No. of misconnected indoor units</td> </tr> </table>	[A]	[B]	[]	[# # P]	↑	↑	C.or H.	No. of misconnected indoor units
[A]	[B]								
[]	[# # P]								
↑	↑								
C.or H.	No. of misconnected indoor units								

----- This check operation requires 15 minutes even if there is no misconnection or there is any misconnection.



<p>Confirmation of check results (2) Press the push-switch SW05 on the interface P.C. board of the outdoor unit for 2 seconds or more. The indoor address in which check code is being detected is displayed on 7-segment display [B]. If there are multiple indoor address in which check code is being detected, they are successively exchanged and displayed. (When SW05 is turned on again, the display returns to display of No. of units.)</p>	<p>(7-segment display)</p> <table style="width: 100%; border-collapse: collapse;"> <tr> <td style="width: 50%; text-align: center;">[A]</td> <td style="width: 50%; text-align: center;">[B]</td> </tr> <tr> <td style="text-align: center;">[]</td> <td style="text-align: center;">[# #]</td> </tr> <tr> <td style="text-align: center;">↑</td> <td style="text-align: center;">↑</td> </tr> <tr> <td style="text-align: center;">C.or H.</td> <td style="text-align: center;">Address display of misconnected indoor unit</td> </tr> </table>	[A]	[B]	[]	[# #]	↑	↑	C.or H.	Address display of misconnected indoor unit
[A]	[B]								
[]	[# #]								
↑	↑								
C.or H.	Address display of misconnected indoor unit								



<p>After check, return the rotary switches SW01 / SW02 / SW03 on the interface P.C. board of the outdoor unit to [1/1/1].</p>	<p>(7-segment display)</p> <table style="width: 100%; border-collapse: collapse;"> <tr> <td style="width: 50%; text-align: center;">[A]</td> <td style="width: 50%; text-align: center;">[B]</td> </tr> <tr> <td style="text-align: center;">[U.1]</td> <td style="text-align: center;">[---]</td> </tr> </table>	[A]	[B]	[U.1]	[---]
[A]	[B]				
[U.1]	[---]				

Interface P.C. board

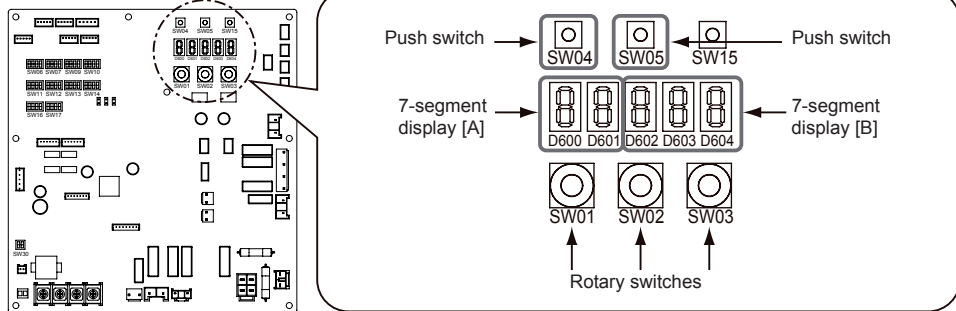

8-7-2. Function to start / stop (ON / OFF) indoor unit from outdoor unit

The following functions of the indoor unit can start or stop by the switches on the interface P.C. board of the outdoor unit.

No	Function	Outline	Setup / Release	7-segment display	
1	Cooling test operation	Changes the mode of all the connected indoor units collectively to cooling test operation. Note) Control operation same as usual test operation from remote controller is performed.	[Setup] Set SW01 / SW02 / SW03 to [2/5/1], and press SW04. [Release] Return SW01 / SW02 / SW03 to [1/1/1].	Section A [C.]	Section B [- C]
2	Heating test operation	Changes the mode of all the connected indoor units collectively to heating test operation. Note) Control operation same as usual test operation from remote controller is performed.	[Setup] Set SW01 / SW02 / SW03 to [2/6/1], and press SW04. [Release] Return SW01 / SW02 / SW03 to [1/1/1].	Section A [H.]	Section B [- H]
3	Batch start	Starts all the connected indoor units collectively. Note) The contents follow to the setup of remote controller.	[Setup] Set SW01 / SW02 / SW03 to [2/7/1], and press SW04. [Release] Return SW01 / SW02 / SW03 to [1].	Section A [C.H]	Section B [11] [11] is displayed on Section B for 5 seconds.
	Batch stop	Stops all the connected indoor units collectively.	[Setup] Set SW01 / SW02 / SW03 to [2/7/1], and press SW05. [Release] Return SW01 / SW02 / SW03 to [1].	Section A [C.H]	Section B [00] [00] is displayed on Section B for 5 seconds.
4	Individual start	Starts the specified indoor unit. Notes) • The contents follow to the setup of remote controller. • The other indoor units keep the status as they are.	[Setup] Set SW01 to [16], set SW02 and SW03 to address No. (1 to 64) to be started, and press SW04. [Release] Return SW01 / SW02 / SW03 to [1/1/1].	Section A []	Section B [1] Section A: Displays the corresponding indoor address. Section B: Displays [11] for 5 seconds from operation-ON.
	Individual stop	Stops the specified indoor unit. Note) The other indoor units keep the status as they are.	[Setup] Set SW01 to [16], set SW02 and SW03 to address No. (1 to 64) to be stopped, and press SW05. [Release] Return SW01 / SW02 / SW03 to [1/1/1].	Section A []	Section B [0] Section A: Displays the corresponding indoor address. Section B: Displays [00] for 5 seconds from operation-OFF.
	Individual test operation	Operates the specified indoor unit. Note) The other indoor units keep the status as they are.	[Setup] Set SW01 to [16], set SW02 and SW03 to address No. to be operated, and press SW04 for 10 seconds or more. [Release] Return SW01 / SW02 / SW03 to [1/1/1].	Section A []	Section B [1] Section A: Displays the corresponding indoor address. Section B: Displays [FF] for 5 seconds from test operation-ON.

NOTE 1) This start / stop function only sends the signals from the outdoor unit to the indoor unit, such as start, stop, operation mode, etc. It does not resend the signals even if the indoor unit does not follow the sent signals.

NOTE 2) The above controls are not used during abnormal stop.

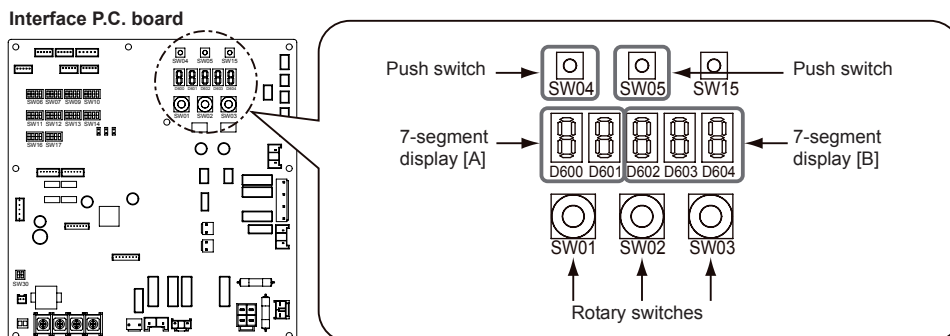

(1) Cooling test operation function

This function is provided to change collectively the mode of all the indoor units connected to the same system for the cooling test operation mode, by using switches on the interface board of the outdoor unit.

<Operation procedure>

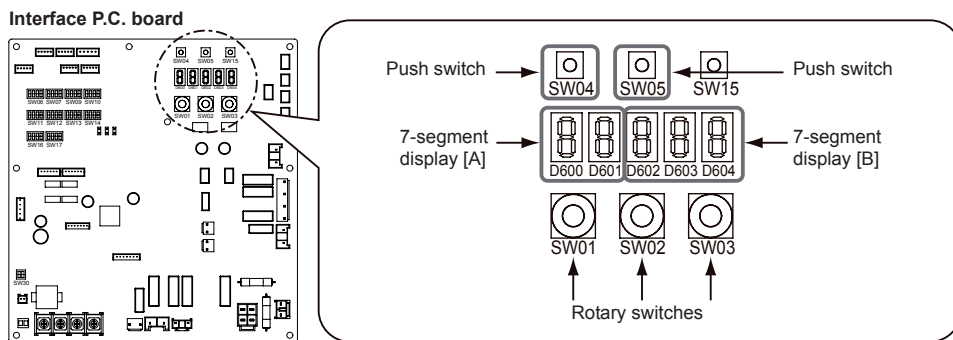
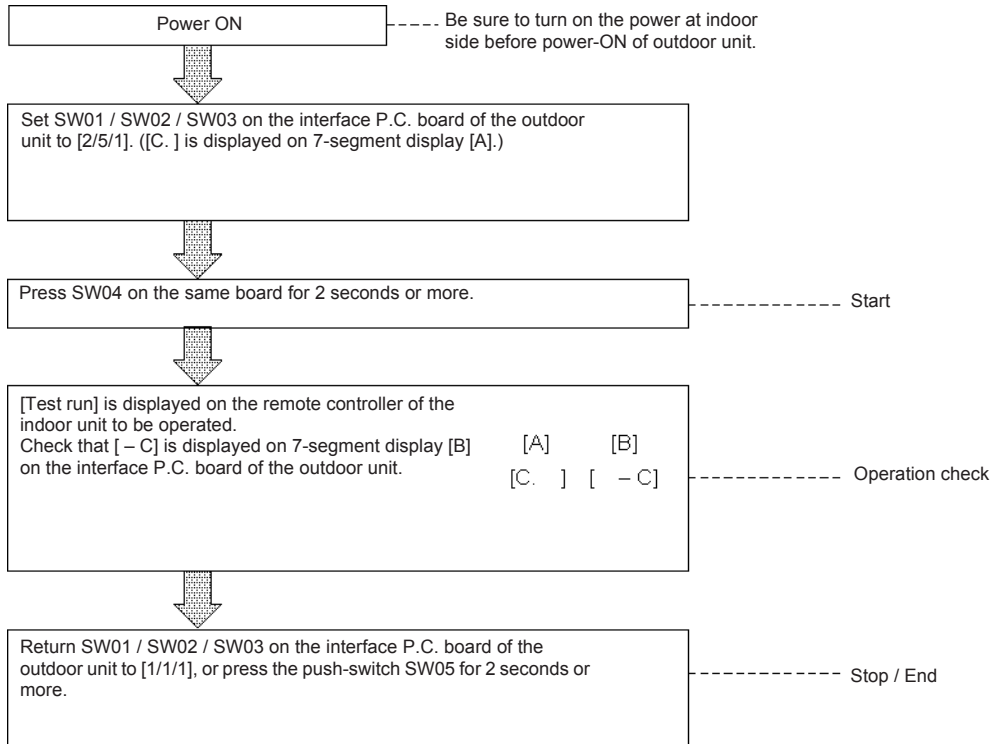

NOTE) The test operation returns to the normal operation after 60 minutes.

(2) Heating test operation function

This function is provided to change collectively the mode of all the indoor units connected to the same system for the heating test operation mode, by using switches on the interface board of the outdoor unit.

<Operation procedure>

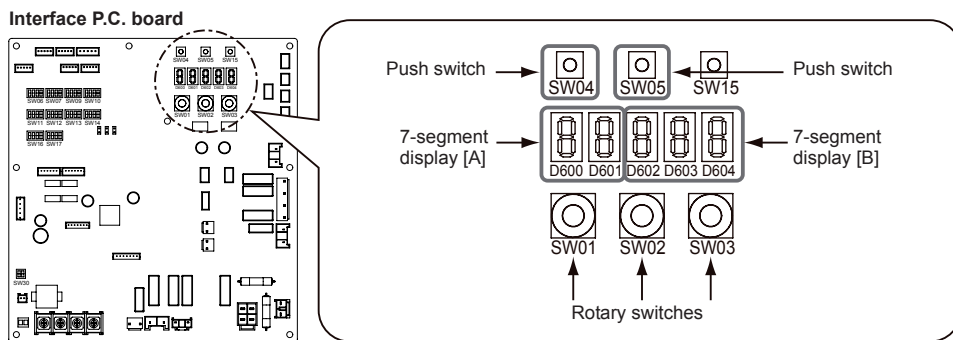
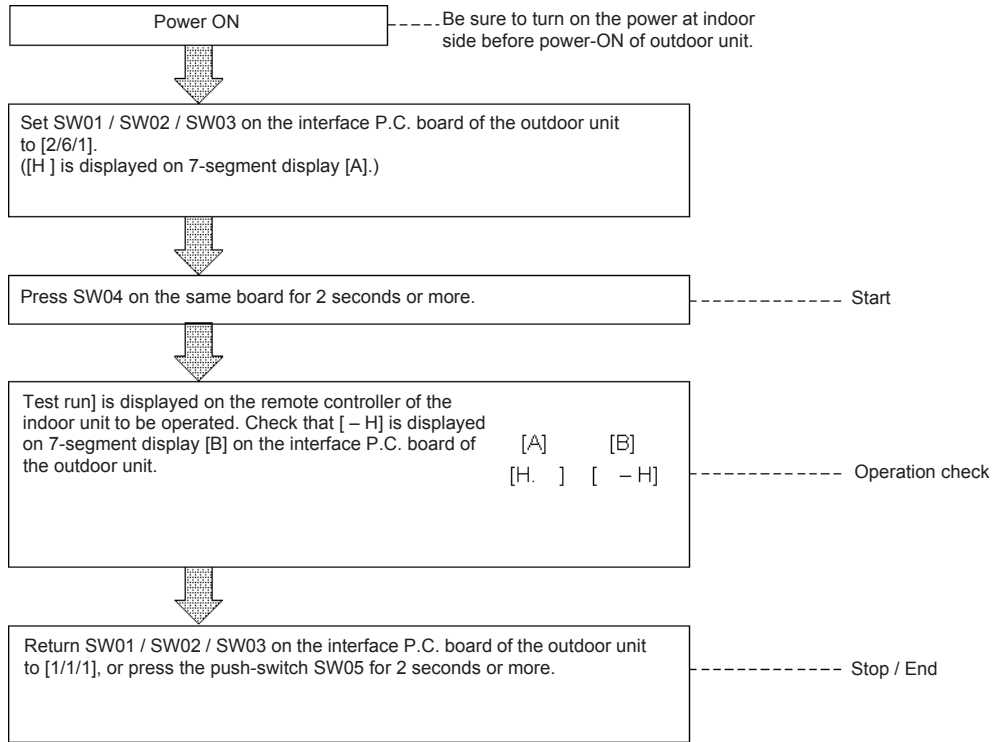

NOTE) The test operation returns to the normal operation after 60 minutes.

(3) Batch start / stop (ON / OFF) function

This function is provided to start / stop collectively all the indoor units connected to the same system by using switches on the interface board of the outdoor unit.

<Operation procedure>

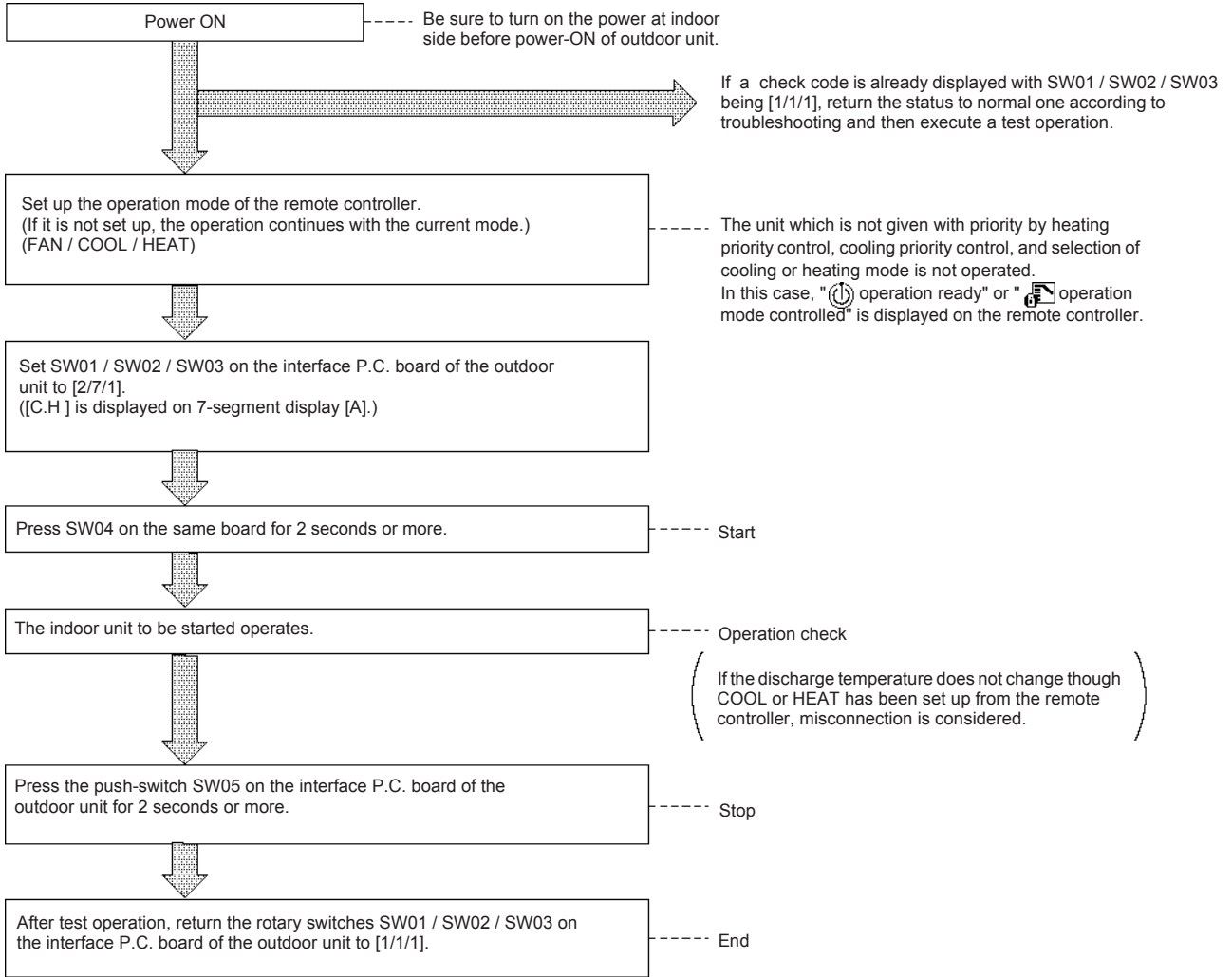

Interface P.C. board

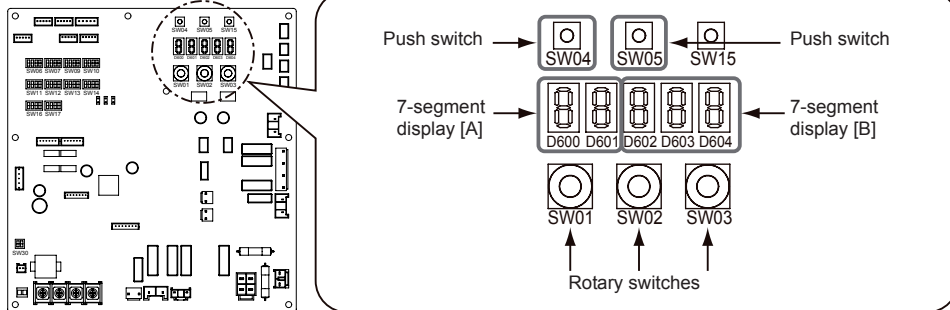

(4) Individual start / stop (ON / OFF) individual test operation function

This function is provided to start / stop (ON / OFF) individually each indoor unit connected to the same system by using switches on the interface board of the outdoor unit.

Set SW01 [16] and set SW02, SW03 to indoor address No. (1 to 64) to be started (Refer to the following table*) - only the setup indoor unit starts operation.

(In the rotary switches of the indoor unit which operates in a group by the remote controller, the follower unit cannot be individually started or stopped. In this case, [- -] is displayed on 7-segment display [B] on the interface P.C. board of the outdoor unit.)

<Operation procedure>

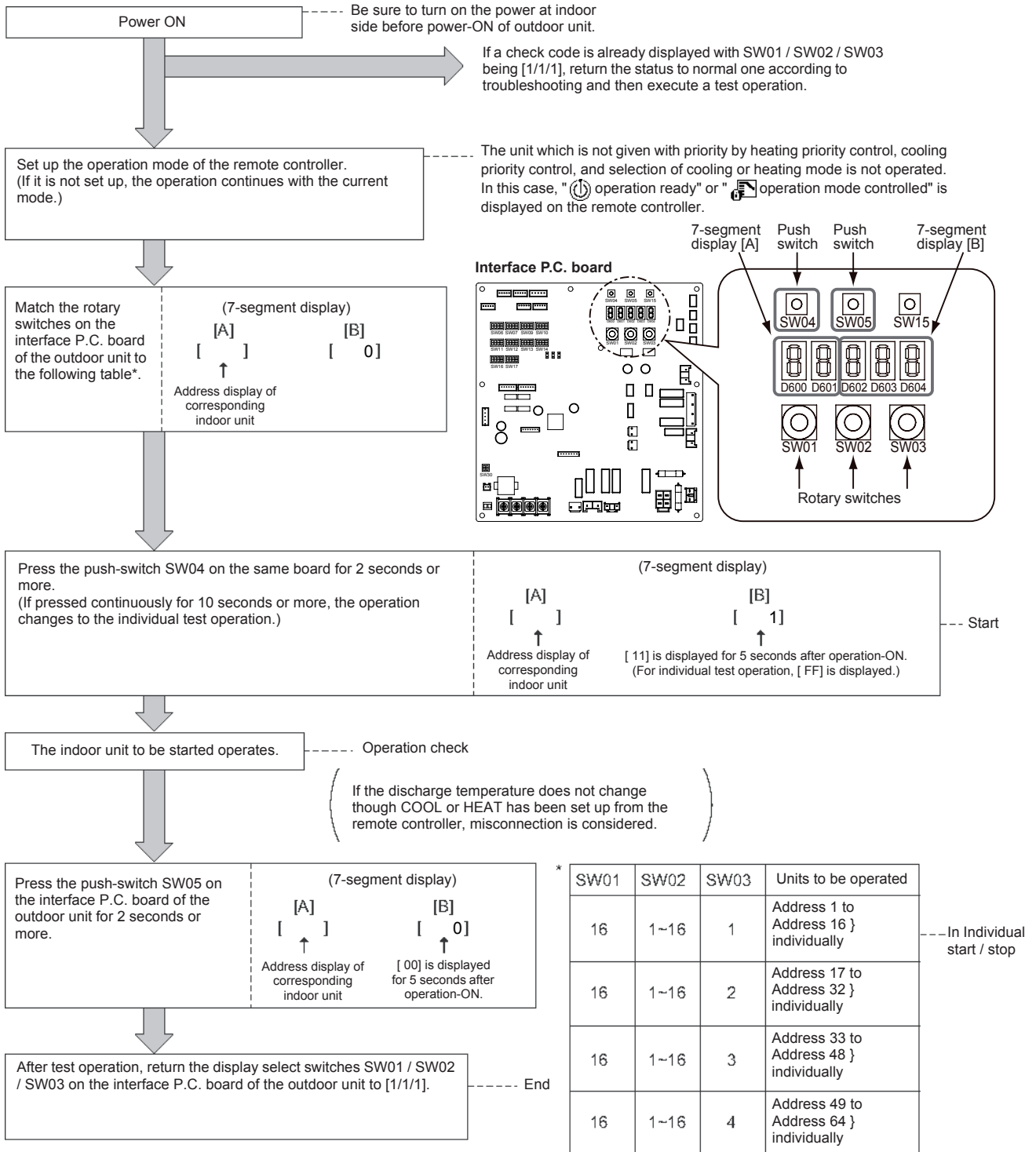

NOTE) The individual test operation returns to the normal operation after 60 minutes.

8-7-3. Check code clearing function

(1) Clearing from the main remote controller

▼ Check code clearing in outdoor unit

Check code of the outdoor unit currently detected is cleared by the unit of one refrigerant circuit system to which the indoor units operated by the remote controller is connected. (Check code of the indoor unit is not cleared.) For clearing check codes, the service monitor function of the remote controller is used.

<Method>

- 1 Change the mode to service monitor mode by pushing **CL** + **TEST** buttons simultaneously for 4 seconds or more.
- 2 Using **TEMP.** buttons, set CODE No. to "FF".
- 3 The display in Section A in the following figure is counted with interval of 5 seconds as "0005" --> "0004" --> "0003" --> "0002" --> "0001" --> "0000".
When the count arrives "0000", the check code is cleared.
*However, counting from "0005" is repeated on the display.
- 4 When **TEST** button is pushed, the status returns to the normal status.

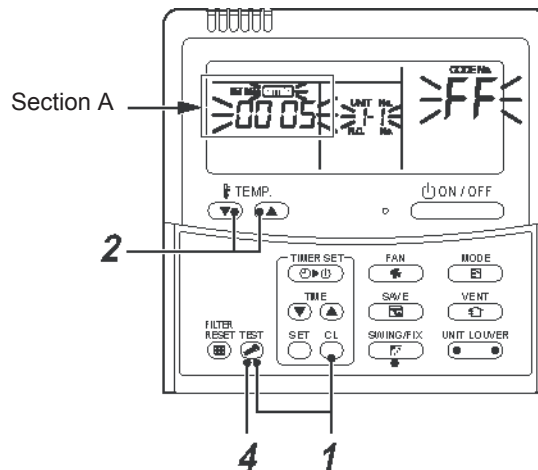

▼ Check code clearing in indoor unit

Check code in the indoor unit is cleared by **ON/OFF** button on the remote controller. (Only check code of the indoor unit connected with operating remote controller is cleared.)

(2) Clearing check code by using switches on the interface board of the outdoor unit

Using the switches on the interface P.C. board of the outdoor unit, this function is to clear the currently detected check code for each refrigerant circuit system without resetting the power supply.

Check codes in both outdoor and indoor units are once cleared, and check code detection is performed again.

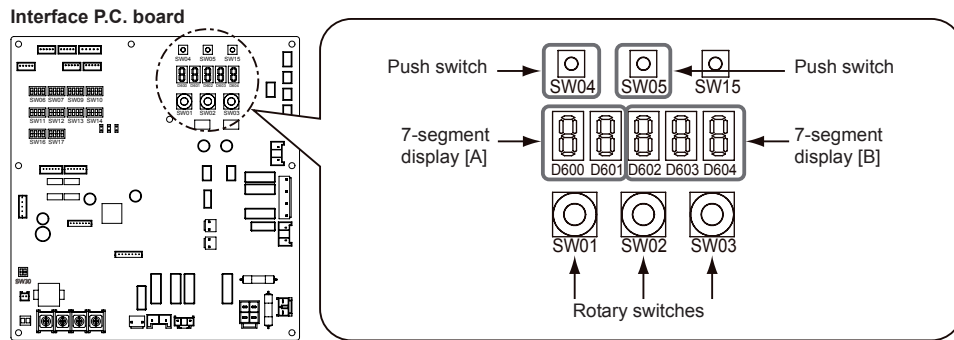
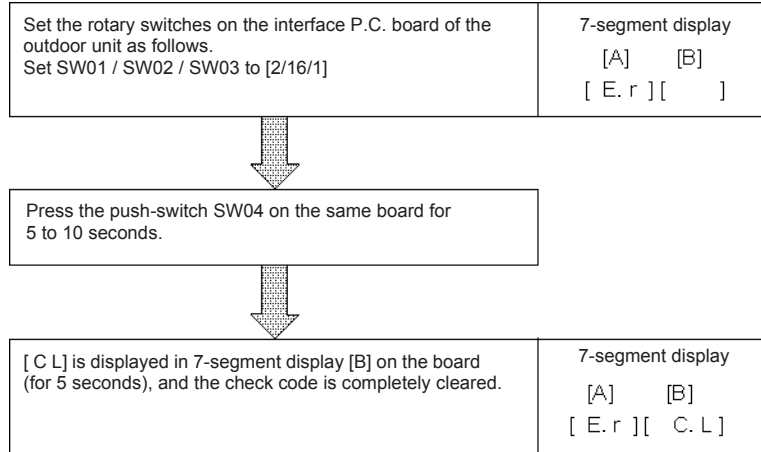

(3) Clearing check code by resetting power

This function is provided to clear check code in a system by resetting the power of all the outdoor and the indoor units. As same as the clearing method by the interface P.C. board, check codes of both the outdoor and the indoor units are once cleared, and check code detection is performed again.

<Method>

- (1) Be sure to reset power of both the outdoor and the indoor units.
- (2) Turn on the power of the indoor unit prior to the power of the outdoor unit.

NOTE) After power reset, it requires usually 3 minutes to power-on due to the initial communication of the system. In some cases, it requires max. 10 minutes.

8-7-4. Remote controller distinction function

This function is provided to distinguish the remote controller connected to the indoor unit from the outdoor unit for a refrigerant circuit system by using switches on the interface P.C. board of the outdoor unit.

<Distinction procedure>

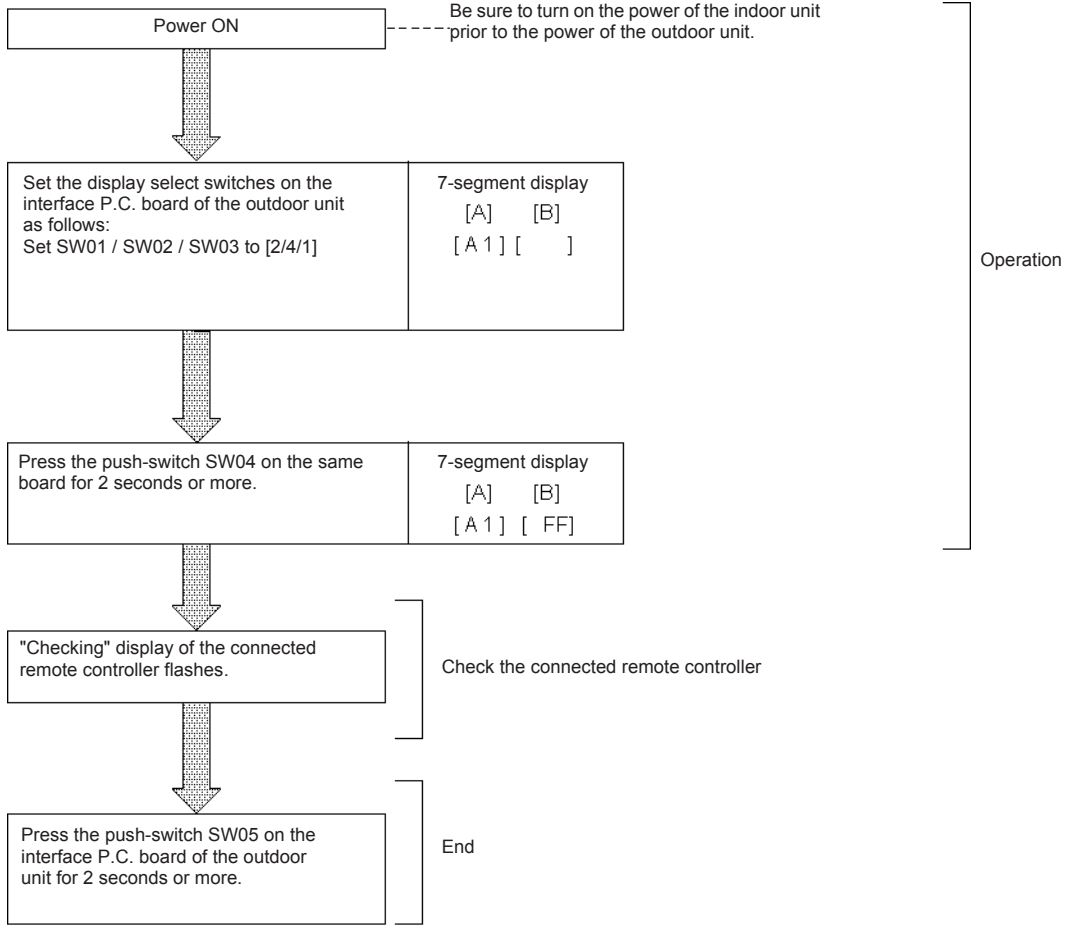

- Other end conditions:
1. 10 minutes have passed
 2. SW01, SW02, or SW03 changed to other position.

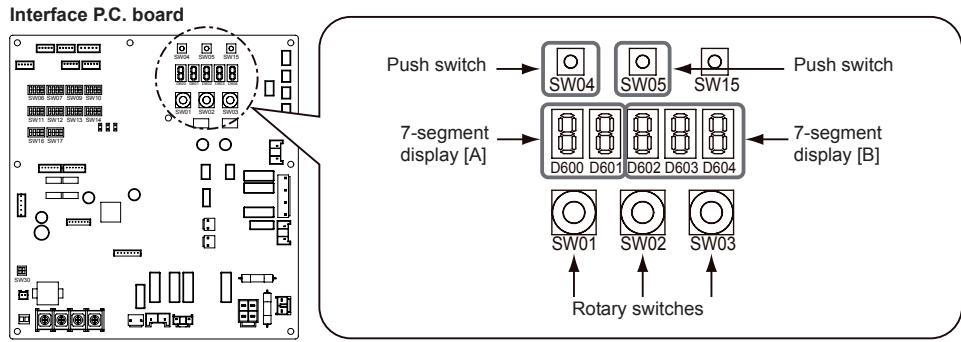

8-7-5. Pulse motor valve (PMV) forced open / close function in indoor unit

This function is provided to open or close forcedly PMV for 2 minutes in all the indoor units by the switch operation on the interface P.C. board of the outdoor unit.

This function is also used to open PMV fully when turning off the power and executing an operation.

<Operation>

[Open fully]

Set the switches SW01 / SW02 / SW03 on the interface P.C. board of the outdoor unit to [2/3/1], and press SW04 for 2 seconds or more.

(Display appears on 7-segment display for 30 seconds as follows.) [P.] [FF]

[Close fully]

Set the switches SW01 / SW02 / SW03 on the interface P.C. board of the outdoor unit to [2/3/1], and press SW05 for 2 seconds or more.

(Display appears on 7-segment display for one minute as follows.) [P.] [00]

[Clear]

After 30 seconds (1 minutes for "Close fully") after setting up, the opening automatically returns to the normal opening.

8-7-6. Pulse motor valve (PMV) forced fixing function in outdoor unit

This function is provided to forcedly the opening degree adjustment of pulse motor valve (PMV1/PMV4).

By setting the switch PMV can be fixed 2 minutes "open fully", "open half" or "close fully" the opening of the pulse motor valve.

<Operation (PMV1)>

[Open fully]

Set the switches SW01/SW02/SW03 on the interface P.C. board of the outdoor unit to [2/1/8], and press SW04 for 2 seconds or more.

(7-segment display appears as below.)

[**][**P] (View PMV opening degree the "****")
"Open fully" of this model ... 3000P

[Open half]

Set the switches SW01/SW02/SW03 on the interface P.C. board of the outdoor unit to [2/2/8], and press SW04 for 2 seconds or more.

(7-segment display appears as below.)

[**][**P] (View PMV opening degree the "****")
"Open half" of this model ... 1500P

[Close fully]

Set the switches SW01/SW02/SW03 on the interface P.C. board of the outdoor unit to [2/3/8], and press SW04 for 2 seconds or more.

(7-segment display appears as below.)

[**][**P] (View PMV opening degree the "****")
"Close fully" of this model ... 0P

[Clear]

This function is cleared by one of the following operations.

- (1) After 2 minutes from the start of the function, the opening degree returns to the normal.
- (2) Set the switches SW01/SW02/SW03 on the interface P.C. board of the outdoor unit to [2/1/8], and press SW05 for 5 seconds or more, the opening degree returns to the normal.

<Operation (PMV4)>

[Open fully]

Set the switches SW01/SW02/SW03 on the interface P.C. board of the outdoor unit to [2/7/8], and press SW04 for 2 seconds or more.

(7-segment display appears as below.)

[**][**P] (View PMV opening degree the “****”)
“Open fully” of this model ... 500P

[Open half]

Set the switches SW01/SW02/SW03 on the interface P.C. board of the outdoor unit to [2/8/8], and press SW04 for 2 seconds or more.

(7-segment display appears as below.)

[**][**P] (View PMV opening degree the “****”)
“Open half” of this model ... 250P

[Close fully]

Set the switches SW01/SW02/SW03 on the interface P.C. board of the outdoor unit to [2/9/8], and press SW04 for 2 seconds or more.

(7-segment display appears as below.)

[**][**P] (View PMV opening degree the “****”)
“Close fully” of this model ... 0P

[Clear]

This function is cleared by one of the following operations.

- (1) After 2 minutes from the start of the function, the opening degree returns to the normal.
- (2) Set the switches SW01/SW02/SW03 on the interface P.C. board of the outdoor unit to [2/7/8], and press SW05 for 5 seconds or more, the opening degree returns to the normal.

8-7-7. Solenoid valve forced open / close function in outdoor unit

This function is provided to forcedly open each solenoid valve mounted in the outdoor unit by the switch operation on the interface P.C. board in the outdoor unit. Use this function to check there is no refrigerant clogging with ON / OFF operation of the solenoid valve.

[Operation]

- (1) Set the switches SW01 / SW02 / SW03 on the interface P.C. board of the outdoor unit to [2/1/3].
- (2) When [H. r.] is displayed in 7-segment display [A], keep pressing the switch SW04 for 2 seconds or more.
- (3) [2] is displayed in 7-segment display [B] and SV2 ON.
- (4) After then, ON and OFF of solenoid valve are exchanged by changing the setup number of the switch SW02.

(ON / OFF output pattern of each solenoid valve is as shown below.)

NOTE 1) Display in 7-segment display [B] is exchanged just when the number of SW02 has been changed; on the other hand, the solenoid valve output is exchanged when SW02 has been kept with the same number for 5 seconds or more.

NOTE 2) The mark [O] in the table indicates that the corresponding solenoid valve is forcedly turned on.

NOTE 3) The mark [-] in the table indicates that ON / OFF of the solenoid valve is controlled based upon the specifications of the air conditioner.

NOTE 4) The mark [x] in the table indicates that the corresponding solenoid valve is forcedly turned off with this operation.

SW02	7-segment display [B]	Operation pattern of solenoid valve			
		SV2	SV3	SV4	SV5
1	[2]	○	-	-	-
2	[4]	-	-	○	-
3	[5]	-	-	-	○
5	[3]	-	○	-	-
15	[OFF]	x	x	x	x
16	[ALL]	○	○	○	○

[Clear]

Return switches SW01 / SW02 / SW03 on the interface P.C. board to [1/1/1].

NOTE) As this function is not based on the specified general control, be sure to release this mode after checking.

8-7-8. Fan operation check in outdoor unit

This function is provided to check the fan operation of the outdoor unit by using switches on the interface P.C. board in the outdoor unit. The frequency of the fan speed can be controlled by setting of the switches. Use this function to check the operation or abnormal sound in the fan system. And, use this function while the system is stopped.

NOTE) Do not use this function during operation of the compressor. It may damage the compressor.

[Operation]

- (1) Set the switches SW01 / SW02 / SW03 on the interface P.C. board of the outdoor unit to [2/1/4].
- (2) When [F. d.] is displayed in 7-segment display [A], keep pressing the switch SW04 for 2 seconds or more.
- (3) When [31] is displayed in 7-segment display [B], the fan starts operation. (Max. mode operation)
- (4) After that, by changing the setup number of the switches SW02 and SW03, 7-segment display [B] and the fan mode are changed.
(Mode output pattern of the fan is as follows.)

SW02	SW03	7-segment display [B]	Fan mode
1	4	[31]	31
2		[30]	30
3		[29]	29
4		[28]	28
5		[27]	27
6		[26]	26
7		[25]	25
8		[24]	24
9		[23]	23
10		[22]	22
11		[21]	21
12		[20]	20
13		[19]	19
14		[18]	18
15		[17]	17
16		[16]	16
1	5	[15]	15
2		[14]	14
3		[13]	13
4		[12]	12
5		[11]	11
6		[10]	10
7		[9]	9
8		[8]	8
9		[7]	7
10		[6]	6
11		[5]	5
12		[4]	4
13		[3]	3
14		[2]	2
15		[1]	1
16		[0]	0

[Clear]

This function is cleared by one of the following operations.

- (1) When SW01 setting number was changed to other number.
- (2) Press-switch SW05 was pressed for 2 seconds or more.

8-7-9. Manual adjustment function of outside temperature (TO) sensor

This function is provided to fix TO sensor value manually by the switch operation on the interface P.C. board in the outdoor unit. When the unit stops abnormally due to TO sensor failure, etc, an emergent operation is available by setting up the value manually to position near the current outside temperature.

[Operation]

- (1) Set the rotary switches on the interface P.C. board to numbers as follows:
 - SW01 / SW02 / SW03 to [2/1/15]
 - 7-segment display: [t o]
- (2) Keep pressing the push-switch SW04 on the interface P.C. board for 1 second or more. The mode changes to the TO sensor value fix manual mode.
- (3) As shown in the following table, TO sensor value can be fixed by setting the rotary switch SW02 on the interface P.C. board.

[Clear]

Return SW01 / SW02 / SW03 on the interface P.C. board in the outdoor unit to [1/1/1].

SW02	7-segment display [B]	TO sensor value
1	[10.]	10 °C
2	[15.]	15 °C
3	[20.]	20 °C
4	[25.]	25 °C
5	[30.]	30 °C
6	[35.]	35 °C
7	[40.]	40 °C
8	[43.]	43 °C
9	[45.]	45 °C
10	[-15.]	-15 °C
11	[-10.]	-10 °C
12	[- 5.]	-5 °C
13	[0.]	0 °C
14	[2.]	2 °C
15	[5.]	5 °C
16	[7.]	7 °C

NOTE) If operated with TO sensor fixed by this function, the system control operation of the air conditioner may not be based on the specification of the product. Therefore an emergent operation should be restricted to a day or so.

8-7-10. Service support function list

SW01	SW02	SW03	7-segment display [A]	Function contents
2	1	1	[J . C]	Refrigerant circuit and control communication line check function (Cooling operation)
	2		[J . H]	Refrigerant circuit and control communication line check function (Heating operation)
	3		[P .]	Indoor PMV forced full open function
	4		[A 1]	Indoor remote controller discriminating function
	5		[C .]	Cooling test operation function
	6		[H .]	Heating test operation function
	7		[C . H]	Indoor collective start / stop (ON / OFF) function
	16		[E . r]	Check code clear function

2	1~3	8	[P . 1]	Pulse motor valve (PMV) forced fixing function in outdoor unit
2	7~9	8	[P . 4]	Pulse motor valve (PMV4) forced fixing function in outdoor unit
2	1~16	3	[H . r.]	Solenoid valve forced open / close function
2		4~5	[F . d.]	Fan forced operation function
2		15	[t o]	Outside temperature sensor manual adjustment function

16	1~16	1	[0 1]~[1 6]	Indoor No. 1 to 16 unit	Indoor individual start / stop (ON / OFF) function
		2	[1 7]~[3 2]	Indoor No. 17 to 32 unit	
		3	[3 3]~[4 8]	Indoor No. 33 to 48 unit	
		4	[4 9]~[6 4]	Indoor No. 49 to 64 unit	

8-7-11. Monitor function of remote controller switch

When using a remote controller with the model name RBC-AMT32E, the following monitor functions can be used.

Calling of service monitor display screen

<Content>

The sensor temperature or operation status of the remote controller, indoor unit, or the outdoor unit can be known by calling up the service monitor mode from the remote controller.

[Procedure]

- 1 Push **TEST** + **CL** buttons simultaneously for 4 seconds or more to call up the service monitor mode.

The service monitor goes on, and temperature of the CODE No. 00 is firstly displayed.

- 2 Push the temperature setup **TEMP.** buttons to select the CODE No. to be monitored.

For displayed codes, refer to the table below.

- 3 Push **SET** button to determine the item to be monitored.

Then monitor the sensor temperature or operation status of indoor unit and the outdoor unit in the corresponding refrigerant line.

- 4 Pushing **TEST** button returns the display to the normal display.

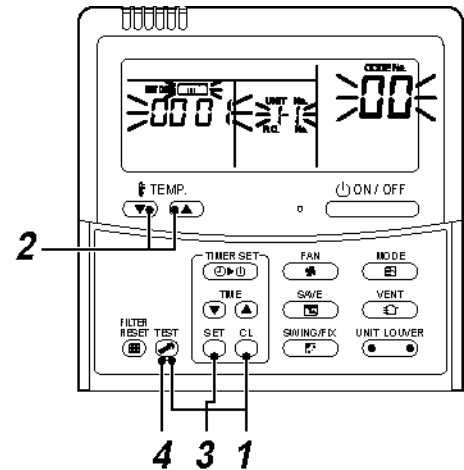

	CODE No.	Data name	Display format	Unit	Remote controller display example
Indoor unit data *2	00	Room temperature (During control)	×1	°C	[0024] = 24 °C
	01	Room temperature (Remote controller)	×1	°C	
	02	Indoor suction temperature (TA)	×1	°C	
	03	Indoor coil temperature (TCJ)	×1	°C	
	04	Indoor coil temperature (TC2)	×1	°C	
	05	Indoor coil temperature (TC1)	×1	°C	
	06	Indoor discharge temperature (TF) *1	×1	°C	
	08	Indoor PMV opening	×1 / 10	pls	
System data	0A	No. of connected indoor units	×1	unit	[0008] = 8 units
	0B	Total horsepower of connected indoor units	×10	HP	[0100] = 10 HP
	0C	No. of connected outdoor units	×1	unit	[0001] = 1 units
	0D	Total horsepower of outdoor units	×10	HP	[0100] = 10 HP
Outdoor unit individual data *3	10	Compressor discharge temperature (TD)	×1	°C	[0024] = 24 °C
	12	High-pressure sensor detection pressure (PD)	×100	MPa	[0123] = 1.23 MPa
	13	Low-pressure sensor detection pressure (PS)	×100	MPa	
	14	Suction temperature (TS1)	×1	°C	[0024] = 24 °C
	15	Outdoor coil temperature (TE)	×1	°C	
	16	Temperature at liquid side (TL1)	×1	°C	
	17	Outside ambient temperature (TO)	×1	°C	
	18	Low-pressure saturation temperature (TU)	×1		
	19	Compressor current (I)	×10	A	[0105] = 10.5 A
	1B	PMV1 opening	×1 / 10	pls	[0050] = 500 pls
	1C	PMV4 opening	×1 / 10	pls	[0050] = 500 pls
	1D	Compressor revolutions	×10	rps	[0933] = 93.3 rps
	1E	Outdoor fan mode	×1	mode	[0027] = 27 mode
	1F	Outdoor unit horsepower	×10	HP	[0100] = 10 HP
	20	High-pressure saturation temperature (TG)	×1	°C	[0024] = 24 °C
21	Compressor oil temperature (TK)	×1	°C		
22	Suction temperature (TS3)	×1	°C		
23	Temperature at liquid side (TL3)	×1	°C		

*1 Only a part of indoor unit types is installed with the discharge temperature sensor. This temperature is not displayed for other types.

*2 When the units are connected to group, data of the header indoor unit only can be displayed.

*3 The upper digit of "CODE No." indicates the outdoor unit number.

9 Troubleshooting

9-1. Overview

(1) Before engaging in troubleshooting

(a) Applicable models

Indoor units: MM*-AP***, MM*-UP*** Outdoor units: MCY-MHP0806*, MCY-MHP0906*, MCY-MHP1006*

(b) Tools and measuring devices required

- Screwdrivers (Philips, flat head), spanners, long-nose pliers, nipper, pin to push reset switch, torque drivers (Philips), etc.
- Multimeter, thermometer, pressure gauge, etc.

(c) Things to check prior to troubleshooting (behaviors listed below are normal)

NO.	Behavior	Possible cause
1	A compressor would not start	<ul style="list-style-type: none"> • Could it just be the 3-minute delay period (3 minutes after compressor shutdown)? • Could it just be the air conditioner having gone thermostat OFF? • Could it just be the air conditioner operating in fan mode or put on the timer? • Could it just be the system going through initial communication?
2	An indoor fan would not start	<ul style="list-style-type: none"> • Could it just be cold air discharge prevention control, which is part of heating?
3	An outdoor fan would not start or would change speed for no reason	<ul style="list-style-type: none"> • Could it just be cooling operation under low outside temperature conditions? • Could it just be defrosting operation?
4	An indoor fan would not stop	<ul style="list-style-type: none"> • Could it just be the elimination of residual heat being performed as part of the air conditioner shutdown process after heating operation?
5	The air conditioner would not respond to a start / stop command from a remote controller	<ul style="list-style-type: none"> • Could it just be the air conditioner operation under external or remote controller?

(2) Troubleshooting procedure

When a trouble occurs, proceed with troubleshooting in accordance with the procedure shown below.

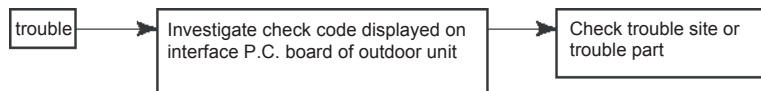

NOTE

Rather than a genuine trouble (see the List of Check Codes below), the problem could have been caused by a microprocessor malfunction attributable to a poor quality of the power source or an external noise. Check for possible noise sources, and shield the remote controller wiring and signal wires as necessary.

9-2. Troubleshooting method

The remote controllers (main remote controller and central controller) and the interface P.C. board of an outdoor unit are provided with an LCD display (remote controller) or a 7-segment display (outdoor interface P.C. board) to display operational status. Using this self-diagnosis feature, the trouble site / trouble part may be identified in the event of a trouble by following the method described below.

The list below summarizes check codes detected by various devices. Analyze the check code according to where it is displayed and work out the nature of the trouble in consultation with the list.

- When investigating a trouble on the basis of a display provided on the indoor remote controller or TCC-LINK central controller - See the “TCC-LINK remote controller or main remote controller display” section of the list.
- When investigating a trouble on the basis of a display provided on an outdoor unit - See the “Outdoor 7-segment display” section of the list.
- When investigating a trouble on the basis of a wireless remote controller-controlled indoor unit - See the “Light sensor indicator light block” section of the list.

List of Check Codes (Indoor Unit)

(Check code detected by indoor unit)

IPDU: Intelligent Power Drive Unit (Inverter P.C. board)



● : Lighting, ✱ : Flashing, ● : Goes off

ALT: Flashing is alternately when there are two flashing LED



SIM: Simultaneous flashing when there are two flashing LED

Check code			Display of receiving unit				Typical trouble site	Description of check code
TCC-LINK central control or main remote controller display	Outdoor 7-segment display		Indicator light block					
		Sub-code	Operation ⏻	Timer ⌚	Ready ⦿	Flash		
E03	–	–	✱	●	●		Indoor-remote controller periodic communication trouble	Communication from remote controller or network adaptor has been lost (so has central control communication).
E04	–	–	●	●	✱		Indoor-outdoor periodic communication trouble	Signals are not being received from outdoor unit.
E08	E08	Duplicated indoor address	✱	●	●		Duplicated indoor address	Indoor unit detects address identical to its own.
E10	–	–	✱	●	●		Indoor inter-MCU communication trouble	MCU communication between main controller and motor microcontroller is troubled.
E18	–	–	✱	●	●		Trouble in periodic communication between indoor header and follower unit	Periodic communication between indoor header and follower units cannot be maintained.
F01	–	–	✱	✱	●	ALT	Indoor heat exchanger temperature sensor (TCJ) trouble	Heat exchanger temperature sensor (TCJ) has been open / short-circuited.
F02	–	–	✱	✱	●	ALT	Indoor heat exchanger temperature sensor (TC2) trouble	Heat exchanger temperature sensor (TC2) has been open / short-circuited.
F03	–	–	✱	✱	●	ALT	Indoor heat exchanger temperature sensor (TC1) trouble	Heat exchanger temperature sensor (TC1) has been open / short-circuited.
F10	–	–	✱	✱	●	ALT	Ambient temperature sensor (TA) Trouble	Ambient temperature sensor (TA) has been open / short-circuited.
F11	–	–	✱	✱	●	ALT	Discharge temperature sensor (TF) trouble	Discharge temperature sensor (TF) has been open / short-circuited.
F29	–	–	✱	✱	●	SIM	P.C. board or other indoor trouble	Indoor EEPROM is abnormal (some other trouble may be detected).
L03	–	–	✱	●	✱	SIM	Duplicated indoor group outdoor unit	There is more than one outdoor unit in group.
L07	–	–	✱	●	✱	SIM	Connection of group control cable to stand-alone indoor unit	There is at least one stand-alone indoor unit to which group control cable is connected.
L08	L08	–	✱	●	✱	SIM	Indoor group address not set	Address setting has not been performed for one or more indoor units (also detected at outdoor unit end).
L09	–	–	✱	●	✱	SIM	Indoor capacity not set	Capacity setting has not been performed for indoor unit.
L20	–	–	✱	⦿	✱	SIM	Duplicated central control address	There is duplication in central control address setting.
L30	L30	Detected indoor unit No.	✱	⦿	✱	SIM	Indoor external trouble input (interlock)	Unit shutdown has been caused by external trouble input (CN80).
P01	–	–	●	✱	✱	ALT	Indoor AC fan trouble	Indoor AC fan trouble is detected (activation of fan motor thermal relay).
P10	P10	Detected indoor unit No.	●	✱	✱	ALT	Indoor overflow trouble	Float switch has been activated.
P12	–	–	●	✱	✱	ALT	Indoor DC fan trouble	Indoor DC fan trouble (e.g. overcurrent or lock-up) is detected.
P31	–	–	✱	●	✱	ALT	Other indoor unit trouble	Follower unit cannot be operated due to outdoor unit alarm (E03 / L03 / L07 / L08).

(Check code detected by main remote controller)

Check code		Display of receiving unit				Typical trouble site	Description of check code
Main remote controller	Outdoor 7-segment display	Indicator light block					
	Sub-code	Operation 	Timer 	Ready 	Flash		
E01	–	–	✳	●	●	No master remote controller, troubled remote controller communication (reception)	Signals cannot be received from indoor unit; master remote controller has not been set (including two remote controller control).
E02	–	–	✳	●	●	Troubled remote controller communication (transmission)	Signals cannot be transmitted to indoor unit.
E09	–	–	✳	●	●	Duplicated master remote controller	Both remote controllers have been set as master remote controller in two remote controller control (alarm and shutdown for outdoor unit and continued operation for follower unit).

(Check code detected by central control device)

Check code		Display of receiving unit				Typical trouble site	Description of check code
TCC-LINK central control	Outdoor 7-segment display	Indicator light block					
	Sub-code	Operation 	Timer 	Ready 	Flash		
C05	–	–	No indication (when main remote controller also in use)	–	–	Troubled central control communication (transmission)	Central control device is unable to transmit signal due to duplication of central control device.
C06	–	–				Troubled central control communication (reception)	Central control device is unable to receive signal.
–	–	–				Multiple network adapters	Multiple network adapters are connected to remote controller communication line.
C12	–	–	–	–	–	Blanket alarm for general-purpose device control interface	Device connected to general-purpose device control interface for TCC-LINK is faulty.
P30	–	–	As per alarm unit (see above)	–	–	Group trouble follower unit trouble	Group follower unit is troubled (unit No. and above detail [***] displayed on main remote controller).

Note: The same trouble, e.g. a communication trouble, may result in the display of different check codes depending on the device that detects it. Moreover, check codes detected by the main remote controller / central control device do not necessarily have a direct impact on air conditioner operation.

List of Check Codes (Outdoor Unit)

(Check codes detected by outdoor interface - typical examples)

IPDU: Intelligent Power Drive Unit (Inverter P.C. board)

○: Lighting, ✖: Flashing, ●: Goes off

ALT: Flashing is alternately when there are two flashing LED

SIM: Simultaneous flashing when there are two flashing LED

Check code		Display of receiving unit				Typical trouble site	Description of check code																																		
Outdoor 7-segment display	TCC-LINK central control or main remote controller display	Indicator light block			Flash																																				
Sub-code		Operation	Timer	Ready																																					
E06	– Number of indoor units from which signal is received normally	E06	●	●	✖		Dropping out of indoor unit HWM initially communicating normally fails to return signal (reduction in number of HWM connected). Indoor unit initially communicating normally fails to return signal (reduction in number of indoor units connected).																																		
E07	–	(E04)	●	●	✖		Indoor-outdoor communication circuit trouble Signal cannot be transmitted to indoor units (→ indoor units left without communication from outdoor unit).																																		
E08	Duplicated indoor address	(E08)	✖	●	●		Duplicated indoor address More than one indoor unit is assigned same address (also detected at indoor unit end).																																		
E12	–	E12	✖	●	●		Automatic address starting trouble Indoor automatic address setting is started while automatic address setting for equipment in other refrigerant line is in progress.																																		
E15	–	E15	●	●	✖		Indoor unit not found during automatic address setting Indoor unit fails to communicate while automatic address setting for indoor units is in progress.																																		
E16	00: Overloading 01 or more: Number of units connected.	E16	●	●	✖		Too many indoor units connected / overloading Combined capacity of indoor units is too large (more than 200% (included HWM) or 130% (not included HWM) of combined capacity of outdoor units).																																		
E20	01: Connection of outdoor unit from other refrigerant line 02: Connection of indoor unit from other refrigerant line	E20	●	●	✖		Connection to other refrigerant line found during automatic address setting Indoor unit from other refrigerant line is detected while indoor automatic address setting is in progress.																																		
E31	<table border="1"> <thead> <tr> <th rowspan="2"></th> <th rowspan="2">A3-IPDU</th> <th colspan="2">Fan IPDU</th> </tr> <tr> <th>1 (Upper)</th> <th>2 (Lower)</th> </tr> </thead> <tbody> <tr> <td>01</td> <td>○</td> <td></td> <td></td> </tr> <tr> <td>02</td> <td></td> <td>○</td> <td></td> </tr> <tr> <td>03</td> <td>○</td> <td>○</td> <td></td> </tr> <tr> <td>04</td> <td></td> <td></td> <td>○</td> </tr> <tr> <td>05</td> <td>○</td> <td></td> <td>○</td> </tr> <tr> <td>06</td> <td></td> <td>○</td> <td>○</td> </tr> <tr> <td>07</td> <td>○</td> <td>○</td> <td>○</td> </tr> </tbody> </table> <p>Circle (O): Faulty IPDU</p>		A3-IPDU	Fan IPDU		1 (Upper)	2 (Lower)	01	○			02		○		03	○	○		04			○	05	○		○	06		○	○	07	○	○	○	E31	●	●	✖		IPDU communication trouble There is no communication between IPDUs (P.C. boards) in inverter box.
	A3-IPDU			Fan IPDU																																					
		1 (Upper)	2 (Lower)																																						
01	○																																								
02		○																																							
03	○	○																																							
04			○																																						
05	○		○																																						
06		○	○																																						
07	○	○	○																																						
F04	–	F04	✖	✖	○	ALT	Outdoor discharge temperature sensor (TD) trouble Outdoor discharge temperature sensor (TD) has been open / short-circuited.																																		
F06	–	F06	✖	✖	○	ALT	Outdoor heat exchanger temperature sensor (TE) trouble Outdoor heat exchanger temperature sensors (TE) have been open / short-circuited.																																		
F07	01: TL1 03: TL3	F07	✖	✖	○	ALT	Outdoor liquid temperature sensor (TL1, TL3) trouble Outdoor liquid temperature sensor (TL1, TL3) has been open / short-circuited.																																		
F08	–	F08	✖	✖	○	ALT	Outdoor outside air temperature sensor (TO) trouble Outdoor outside air temperature sensor (TO) has been open / short-circuited.																																		
F12	01: TS1 03,04: TS4	F12	✖	✖	○	ALT	Outdoor suction temperature sensor (TS1, TS3) trouble Outdoor suction temperature sensor (TS1, TS3) has been open / short-circuited. • TS3 sensor position trouble.																																		
F15	–	F15	✖	✖	○	ALT	Outdoor temperature sensor (TE, TL1) wiring trouble Wiring trouble in outdoor temperature sensors (TE, TL1) has been detected.																																		
F16	–	F16	✖	✖	○	ALT	Outdoor pressure sensor (PD, PS) wiring trouble Wiring trouble in outdoor pressure sensors (PD, PS) has been detected.																																		
F23	–	F23	✖	✖	○	ALT	Low pressure sensor (PS) trouble Output voltage of low pressure sensor (PS) is zero.																																		

Check code		Display of receiving unit				Typical trouble site	Description of check code																																		
Outdoor 7-segment display		TCC-LINK central control or main remote controller display	Indicator light block																																						
Sub-code				Operation 	Timer 	Ready 	Flash																																		
F24	–	F24	✳	✳	○	ALT	High pressure sensor (PD) trouble Output voltage of high pressure sensor (PD) is zero or provides abnormal readings when compressors have been turned off.																																		
F31	–	F31	✳	✳	○	SIM	Outdoor EEPROM check code Outdoor EEPROM is troubled (alarm and shutdown for outdoor unit and continued operation for follower unit).																																		
H05	–	H05	●	✳	●		Outdoor discharge temperature sensor (TD) wiring trouble Wiring / installation trouble or detachment of outdoor discharge temperature sensor (TD) has been detected.																																		
H06	–	H06	●	✳	●		Activation of low-pressure protection Low pressure (PS) sensor detects abnormally low operating pressure.																																		
H07	–	H07	●	✳	●		Lower oil level protection Temperature sensor for oil level detection (TK) detects abnormally low oil level.																																		
H08		H08	●	✳	●		Trouble in temperature sensor for oil level detection (TK) Temperature sensor for oil level detection (TK) has been open/short-circuited.																																		
H16		H16	●	✳	●		Oil level detection circuit trouble No temperature change is detected by temperature sensor for oil level detection (TK) despite compressor having been started.																																		
L04	–	L04	✳	○	✳	SIM	Duplicated outdoor refrigerant line address Identical refrigerant line address has been assigned to outdoor units belonging to different refrigerant piping systems.																																		
L06	Number of priority indoor units (check code L05 or L06 depending on individual unit)	L05	✳	●	✳	SIM	Duplicated priority indoor unit (as displayed on priority indoor unit) More than one indoor unit has been set up as priority indoor unit.																																		
		L06	✳	●	✳	SIM	Duplicated priority indoor unit (as displayed on indoor unit other than priority indoor unit) More than one indoor unit has been set up as priority indoor unit.																																		
L08	–	(L08)	✳	●	✳	SIM	Indoor group address not set Address setting has not been performed for one or more indoor units (also detected at indoor end).																																		
L10	–	L10	✳	○	✳	SIM	Outdoor capacity not set Outdoor unit capacity has not been set (after P.C. board replacement).																																		
L23	02:SW setting mistake when HWM is connected	L23	✳	○	✳	SIM	SW setting mistake Bit4 of SW09 is not turned on when HWM is connected.																																		
L29	<table border="1"> <thead> <tr> <th rowspan="2"></th> <th rowspan="2">A3-IPDU</th> <th colspan="2">Fan IPDU</th> </tr> <tr> <th>1 (Upper)</th> <th>2 (Middle)</th> </tr> </thead> <tbody> <tr> <td>01</td> <td>○</td> <td></td> <td></td> </tr> <tr> <td>02</td> <td></td> <td>○</td> <td></td> </tr> <tr> <td>03</td> <td>○</td> <td>○</td> <td></td> </tr> <tr> <td>04</td> <td></td> <td></td> <td>○</td> </tr> <tr> <td>05</td> <td>○</td> <td></td> <td>○</td> </tr> <tr> <td>06</td> <td></td> <td>○</td> <td>○</td> </tr> <tr> <td>07</td> <td>○</td> <td>○</td> <td>○</td> </tr> </tbody> </table> <p>Circle (O): Faulty IPDU</p> <p>(*) Concerning the "00" auxiliary code 1) The wrong model setting for the interface P.C. board was used when the board was replaced with the service P.C. board. In such a case, the sub-codes "08" to "0F" for L29, which are not included in the table above, may be displayed. 2) The wrong model setting for the IPDU P.C. board was used when the board was replaced with the service P.C. board.</p>		A3-IPDU	Fan IPDU		1 (Upper)	2 (Middle)	01	○			02		○		03	○	○		04			○	05	○		○	06		○	○	07	○	○	○	L29	✳	○	✳	SIM	Trouble in number of IPDUs There are insufficient number of IPDUs (P.C. boards) in inverter box.
	A3-IPDU			Fan IPDU																																					
		1 (Upper)	2 (Middle)																																						
01	○																																								
02		○																																							
03	○	○																																							
04			○																																						
05	○		○																																						
06		○	○																																						
07	○	○	○																																						

(Errors detected by IPDU featuring in outdoor unit - typical examples)

Check code		TCC-LINK central control or main remote controller display	Display of receiving unit				Typical trouble site	Description of check code
Outdoor 7-segment display	Sub-code		Indicator light block					
			Operation 	Timer 	Ready 	Flash		
L30	Detected indoor unit No.	(L30)	✳	●	✳	SIM	Indoor external error input (interlock) Indoor unit has been shut down for external error input in one refrigerant line (detected by indoor unit).	
P03	–	P03	✳	●	✳	ALT	Outdoor discharge (TD) temperature trouble Outdoor discharge temperature sensor (TD) has detected abnormally high temperature.	
P04	–	P04	○	●	○	ALT	Activation of high-pressure SW High-pressure SW is activated.	
P05	00: Open phase detected	P05	✳	●	✳	ALT	Phase missing detection	
	E(: Fan motor number)						Fan motor Vdc trouble	
	–						Compressor Vdc trouble	
P07	–	P07	✳	●	✳	ALT	Heat sink overheating trouble Temperature sensor built into IGBT (TH) detects overheating.	
P10	Indoor unit No. detected	(P10)	●	✳	✳	ALT	Indoor unit overflow Indoor unit has been shutdown in one refrigerant line due to detection of overflow (detected by indoor unit).	
P13	–	P13	●	✳	✳	ALT	Outdoor liquid backflow detection trouble State of refrigerant cycle circuit indicates liquid backflow operation.	
P15	01: TS1 condition 02: TD condition	P15	✳	●	✳	ALT	Gas leak detection Outdoor suction temperature sensor (TS1) or Outdoor discharge temperature sensor (TD) detects sustained and repeated high temperatures that exceed standard value.	
P19	–	P19	✳	●	✳	ALT	4-way valve reversing trouble Abnormality in refrigerating cycle is detected during heating operation.	
P20	–	P20	✳	●	✳	ALT	Activation of high-pressure protection High pressure (PD) sensor detects high pressure that exceeds standard value.	
F13	–	F13	✳	✳	○	ALT	Trouble in temperature sensor built into outdoor IGBT (TH) Temperature sensor built into outdoor IGBT (TH) has been open / short-circuited.	
H01	–	H01	●	✳	●		Compressor breakdown Inverter current (Idc) detection circuit detects overcurrent.	
H02	–	H02	●	✳	●		Compressor trouble (lockup) Compressor lockup is detected.	
H03	–	H03	●	✳	●		Current detection circuit trouble Abnormal current is detected while inverter compressor is turned off.	
P07	–	P07	✳	●	✳	ALT	Heat sink overheating trouble Temperature sensor built into IGBT (TH) detects overheating.	
P22	*0: IGBT shortcircuit *1: Position detection circuit trouble *3: Motor lockup trouble *C: TH Sensor temperature trouble (*: Fan motor number)	P22	✳	●	✳	ALT	Outdoor fan IPDU trouble Outdoor fan IPDU detects trouble.	
P26	–	P26	✳	●	✳	ALT	Activation of IGBT (IPM) short-circuit protection Short-circuit protection for compressor motor driver circuit components is activated (momentary overcurrent).	
P29	–	P29	✳	●	✳	ALT	Compressor position detection circuit trouble Compressor motor position detection trouble is detected.	

Note: The above check codes are examples only, and different check codes may be displayed depending on the outdoor unit configuration (e.g. a Super heat recovery multi system). For details, see the service manual for the outdoor unit.

9-3. Troubleshooting based on information displayed on remote controller

Using main remote controller (RBC-AMT32E)

(1) Checking and testing

When a trouble occurs to an air conditioner, a check code and indoor unit No. are displayed on the display window of the remote controller.

Check codes are only displayed while the air conditioner is in operation.

If the display has already disappeared, access check code history by following the procedure described below.

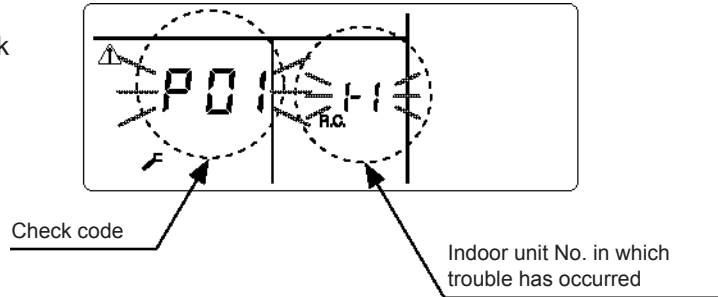

(2) Check code history

The check code history access procedure is described below (up to four check codes stored in memory). Check code history can be accessed regardless of whether the air conditioner is in operation or shut down.

<Procedure> To be performed when system at rest

- 1 Invoke the **SERVICE CHECK** mode by pressing the **TEST** + **SET** buttons simultaneously and holding for at least 4 seconds.

The letters "SERVICE CHECK" light up, and the check code "01" is displayed, indicating the check code history. This is accompanied by the indoor unit No. to which the error history is related and a check code.

- 2 To check other check code history items, press the **TEMP.** button to select another check code.

Check code "01" (latest) → Check code "04" (oldest)
Note: Check code history contains four items.

- 3 When the **TEST** button is pushed, normal display is restored.

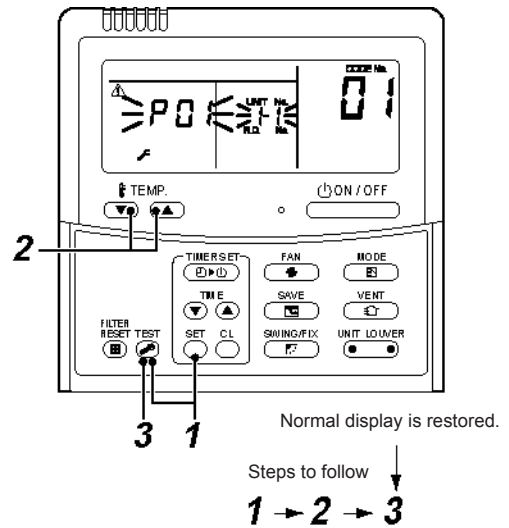

REQUIREMENT

Do not push the **CL** button as it would erase the whole check code history of the indoor unit.

How to read displayed information

<7-segment display symbols>



<Corresponding alphanumerical letters>

0 1 2 3 4 5 6 7 8 9 A b C d E F H J L P

Using TCC-LINK central remote controller (TCB-SC642TLE2)

(1) Checking and testing

When a trouble occurs to an air conditioner, a check code and indoor unit No. are displayed on the display window of the remote controller. Check codes are only displayed while the air conditioner is in operation.

If the display has already disappeared, access check code history by following the procedure described below.

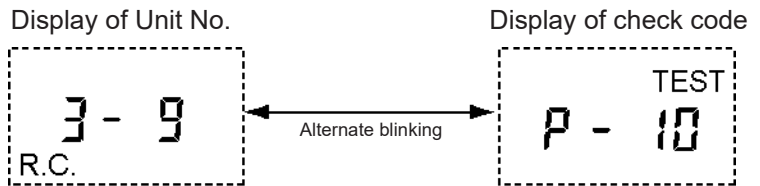

(2) Check code history

The check code history access procedure is described below (up to four check codes stored in memory). Check code history can be accessed regardless of whether the air conditioner is in operation or shut down.

- 1** Push the + buttons simultaneously and hold for at least 4 seconds.
- 2** The letters “ SERVICE CHECK” light up, and the check code “01” is displayed.
- 3** When a group No. is selected (blinking), if there is a check code history, the UNIT No. and the latest check code history information are displayed alternately.

*During this procedure, the temperature setting feature is unavailable.

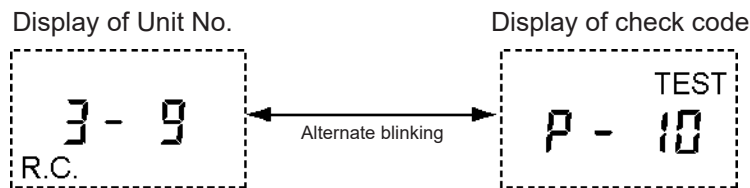

- 4** To check other check code history items, push the button to select another check code (01-04.).
- 5** To check check code relating to another group, push (ZONE) and (GROUP) buttons to select a group No.
Do not push the button as it would erase the whole check code history of the selected group.
- 6** To finish off the service check, push the button.

Using indoor unit indicators (receiving unit light block) (wireless type)

To identify the check code, check the 7-segment display on the outdoor unit. To check for check codes not displayed on the 7-segment display, consult the “List of Check Codes (Indoor Unit)” in “9-2. Troubleshooting method”.

●: Goes off ○: Lighting ☀: Blinking (0.5 seconds)

Light block	Check code	Cause of check code	
Operation Timer Ready ● ● ● All lights out	–	Power turned off or trouble in wiring between receiving and indoor units	
Operation Timer Ready ☀ ● ● Blinking	E01	Troubled reception	Receiving unit trouble or poor contact in wiring between receiving and indoor units
	E02	Troubled transmission	
	E03	Loss of communication	
	E08	Duplicated indoor unit No. (address)	Setting trouble
	E09	Duplicated master remote controller	
	E10	Indoor unit inter-MCU communication trouble	
	E12	Automatic address starting trouble	
	E18	Trouble or poor contact in wiring between indoor units, indoor power turned off	
Operation Timer Ready ● ● ☀ Blinking	E04	Trouble or poor contact in wiring between indoor and outdoor units (loss of indoor-outdoor communication)	
	E06	Troubled reception in indoor-outdoor communication (dropping out of indoor unit)	
	E07	Troubled transmission in indoor-outdoor communication	
	E15	Indoor unit not found during automatic address setting	
	E16	Too many indoor units connected / overloading	
	E20	Detection of refrigerant piping communication trouble during automatic address setting	
	E31	IPDU communication trouble	
Operation Timer Ready ● ☀ ☀ Alternate blinking	P01	Indoor AC fan motor trouble	
	P10	Indoor overflow trouble	
	P12	Indoor DC fan motor trouble	
	P13	Outdoor liquid backflow detection trouble	
Operation Timer Ready ☀ ● ☀ Alternate blinking	P03	Outdoor discharge (TD) temperature trouble	
	P04	Outdoor unit High-pressure SW is activated.	
	P05	Open phase / power failure Inverter DC voltage (Vdc) trouble	
	P07	Outdoor heat sink overheating trouble - Poor cooling of electrical component (IGBT) of outdoor unit	
	P15	Gas leak detection - insufficient refrigerant charging	
	P19	Outdoor 4-way valve reversing trouble	
	P20	Activation of high-pressure protection	
	P22	Outdoor fan IPDU trouble	
	P26	Outdoor G-Tr short-circuit trouble	
	P29	Compressor position detection circuit trouble	
	P31	Shutdown of other indoor unit in group due to trouble (group follower unit trouble)	
	Operation Timer Ready ☀ ☀ ● Alternate blinking	F01	Heat exchanger temperature sensor (TCJ) trouble
F02		Heat exchanger temperature sensor (TC2) trouble	
F03		Heat exchanger temperature sensor (TC1) trouble	
F10		Ambient temperature sensor (TA) trouble	
F11		Discharge temperature sensor (TF) trouble	

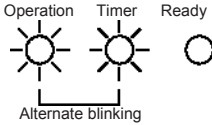
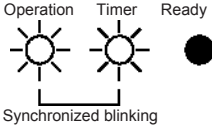
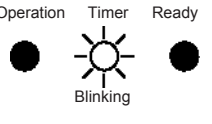
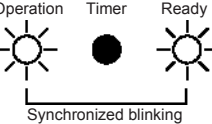
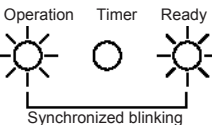
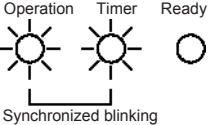
Light block	Check code	Cause of check code					
 <p>Alternate blinking</p>	F04	Discharge temperature sensor (TD) trouble	Outdoor unit temperature sensor troubles				
	F06	Heat exchanger temperature sensor (TE) trouble					
	F07	Liquid temperature sensor (TL1, TL3) trouble					
	F08	Outside air temperature sensor (TO) trouble					
	F12	Suction temperature sensor (TS1, TS3) trouble					
	F13	Heat sink sensor (TH) trouble					
	F15	Wiring trouble in heat exchanger sensor (TE) and liquid temperature sensor (TL1) Outdoor unit temperature sensor wiring / installation trouble					
	F16	Wiring trouble in outdoor high pressure sensor (PD) and low pressure sensor (PS) Outdoor pressure sensor wiring trouble					
	F23	Low pressure sensor (PS) trouble	Outdoor unit pressure sensor troubles				
F24	High pressure sensor (PD) trouble						
 <p>Synchronized blinking</p>	F29	Trouble in indoor EEPROM					
 <p>Blinking</p>	H01	Compressor breakdown	Outdoor unit compressor-related troubles				
	H02	Compressor lockup					
	H03	Current detection circuit trouble					
	H05	Wiring/installation trouble or detachment of outdoor discharge temperature sensor (TD)				Protective shutdown of outdoor unit	
	H06	Abnormal drop in low-pressure sensor (PS) reading					
	H07	Abnormal drop in oil level					
	H08	Trouble in temperature sensor for oil level detection circuit (TK)					
H16	Oil level detection circuit trouble - Trouble in outdoor unit TK circuit						
 <p>Synchronized blinking</p>	L03	Duplicated indoor group outdoor unit					
	L05	Duplicated priority indoor unit (as displayed on priority indoor unit)					
	L06	Duplicated priority indoor unit (as displayed on indoor unit other than priority indoor unit)					
	L07	Connection of group control cable to stand-alone indoor unit					
	L08	Indoor group address not set					
	L09	Indoor capacity not set					
 <p>Synchronized blinking</p>	L04	Duplicated outdoor refrigerant line address					
	L10	Outdoor capacity not set					
	L23	SW setting mistake					
	L29	Trouble in number of IPDUs					
	L30	Indoor external interlock trouble					
 <p>Synchronized blinking</p>	F31	Outdoor EEPROM trouble					

Other (indications not involving check code)

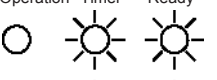
Light block	Check code	Cause of check code
<p>Operation Timer Ready</p>  <p>Synchronized blinking</p>	<p>–</p>	<p>Test run in progress</p>
<p>Operation Timer Ready</p>  <p>Alternate blinking</p>	<p>–</p>	<p>Setting incompatibility (automatic cooling / heating setting for model incapable of it and heating setting for cooling-only model)</p>

9-4. Check codes displayed on remote controller and outdoor unit (7-segment display on I/F board) and locations to be checked

For other types of outdoor units, refer to their own service manuals.

Main remote controller	Check code		Location of detection	Description	System status	Check code detection condition(s)	Check items (locations)
	Outdoor 7-segment display						
	Check code	Sub-code					
E01	-	-	Remote controller	Indoor-remote controller communication trouble (detected at remote controller end)	Stop of corresponding unit	Communication between indoor P.C. board and remote controller is disrupted.	<ul style="list-style-type: none"> • Check remote controller inter-unit tie cable (A / B). • Check for broken wire or connector bad contact. • Check indoor power supply. • Check for defect in indoor P.C. board. • Check remote controller address settings (when two remote controllers are in use). • Check remote controller P.C. board.
E02	-	-	Remote controller	Remote controller transmission trouble	Stop of corresponding unit	Signal cannot be transmitted from remote controller to indoor unit.	<ul style="list-style-type: none"> • Check internal transmission circuit of remote controller. --- Replace remote controller as necessary.
E03	-	-	Indoor unit	Indoor-remote controller communication trouble (detected at indoor end)	Stop of corresponding unit	There is no communication from remote controller (including wireless) or network adaptor.	<ul style="list-style-type: none"> • Check remote controller and network adaptor wiring.
E04	-	-	Indoor unit	Indoor-outdoor communication circuit trouble (detected at indoor end)	Stop of corresponding unit	Indoor unit is not receiving signal from outdoor unit.	<ul style="list-style-type: none"> • Check order in which power was turned on for indoor and outdoor units. • Check indoor address setting. • Check indoor-outdoor tie cable. • Check outdoor terminator resistor setting (SW30, Bit 2).
E06	E06	No. of indoor units from which signal is received normally	I/F	Dropping out of indoor unit	All stop	<p>HWM initially communicating normally fails to return signal.</p> <p>Indoor unit initially communicating normally fails to return signal for specified length of time.</p>	<ul style="list-style-type: none"> • Check power supply to indoor unit.(Is power turned on?) • Check connection of indoor-outdoor communication cable. • Check connection of communication connectors on indoor P.C. board. • Check connection of communication connectors on outdoor P.C. board. • Check for trouble in indoor P.C. board. • Check for trouble in outdoor P.C. board (I/F).
-	E07	-	I/F	Indoor-outdoor communication circuit trouble (detected at outdoor end)	All stop	Signal cannot be transmitted from outdoor to indoor units for 30 seconds continuously.	<ul style="list-style-type: none"> • Check outdoor terminator resistor setting (SW30, Bit 2). • Check connection of indoor-outdoor communication circuit.
E08	E08	Duplicated indoor address	Indoor unit I/F	Duplicated indoor address	All stop	More than one indoor unit is assigned same address.	<ul style="list-style-type: none"> • Check indoor addresses. • Check for any change made to remote controller connection (group / individual) since indoor address setting.

Check code			Location of detection	Description	System status	Check code detection condition(s)	Check items (locations)																																				
Main remote controller	Outdoor 7-segment display																																										
	Check code	Sub-code																																									
E09	-	-	Remote controller	Duplicated master remote controller	Stop of corresponding unit	In two remote controller configuration (including wireless), both controllers are set up as master. (Header indoor unit is shut down with alarm, while follower indoor units continue operating.)	<ul style="list-style-type: none"> Check remote controller settings. Check remote controller P.C. boards. 																																				
E10	-	-	Indoor unit	Indoor inter-MCU communication trouble	Stop of corresponding unit	Communication cannot be established / maintained upon turning on of power or during communication.	<ul style="list-style-type: none"> Check for trouble in indoor P.C. board. 																																				
E12	E12	-	I/F	Automatic address starting trouble	All stop	Indoor automatic address setting is started while automatic address setting for equipment in other refrigerant line is in progress.	<ul style="list-style-type: none"> Perform automatic address setting again after disconnecting communication cable to that refrigerant line. 																																				
E15	E15	-	I/F	Indoor unit not found during automatic address setting	All stop	Indoor unit cannot be detected after indoor automatic address setting is started.	<ul style="list-style-type: none"> Check connection of indoor-outdoor communication line. Check for trouble in indoor power supply system. Check for noise from other devices. Check for power failure. Check for trouble in indoor P.C. board. 																																				
E16	E16	00: Overloading 01-: No. of units connected	I/F	Too many indoor units connected	All stop	<ul style="list-style-type: none"> Combined capacity of indoor units exceeds 200% (included HWM) or 130% (not included HWM) of combined capacity of outdoor units. <p>Note: If this code comes up after backup setting for outdoor unit failure is performed, perform "No overloading detected" setting.</p> <p><"No overloading detected" setting method> Turn on SW09 / Bit 2 on I/F P.C. board of outdoor unit.</p> <ul style="list-style-type: none"> More than 12 indoor units are connected for MCY-MHP0806*, MHP0906* More than 16 indoor units are connected for MCY-MHP1006*. 	<ul style="list-style-type: none"> Check capacities of indoor units connected. Check combined HP capacities of indoor units. Check HP capacity settings of outdoor units. Check No. of indoor units connected. Check for trouble in outdoor P.C. board (I/F). 																																				
E18	-	-	Indoor unit	Trouble in communication between indoor header and follower units	Stop of corresponding unit	Periodic communication between indoor header and follower units cannot be maintained.	<ul style="list-style-type: none"> Check remote controller wiring. Check indoor power supply wiring. Check P.C. boards of indoor units. 																																				
E20	E20	01: Connection of outdoor unit from other line 02: Connection of indoor unit from other line	I/F	Connection to other line found during automatic address setting	All stop	Equipment from other line is found to have been connected when indoor automatic address setting is in progress.	<ul style="list-style-type: none"> Disconnect inter-line tie cable in accordance with automatic address setting method explained in "Address setting" section. 																																				
E31	E31	<table border="1"> <thead> <tr> <th></th> <th>A3-IPDU</th> <th colspan="2">Fan IPDU</th> </tr> <tr> <th></th> <th></th> <th>1 (Upper)</th> <th>2 (Lower)</th> </tr> </thead> <tbody> <tr> <td>01</td> <td>0</td> <td></td> <td></td> </tr> <tr> <td>02</td> <td></td> <td>0</td> <td></td> </tr> <tr> <td>03</td> <td>0</td> <td>0</td> <td></td> </tr> <tr> <td>04</td> <td></td> <td></td> <td>0</td> </tr> <tr> <td>05</td> <td>0</td> <td></td> <td>0</td> </tr> <tr> <td>06</td> <td></td> <td>0</td> <td>0</td> </tr> <tr> <td>07</td> <td>0</td> <td>0</td> <td>0</td> </tr> </tbody> </table> <p>Circle (O): Faulty IPDU</p>		A3-IPDU	Fan IPDU				1 (Upper)	2 (Lower)	01	0			02		0		03	0	0		04			0	05	0		0	06		0	0	07	0	0	0	I/F	IPDU communication trouble	All stop	Communication is disrupted between IPDUs (P.C. boards) in inverter box.	<ul style="list-style-type: none"> Check wiring and connectors involved in communication between IPDU-I/F P.C. board for bad contact or broken wire. Check for defect in outdoor P.C. board (I/F, A3-IPDU or Fan IPDU). Check for external noise.
	A3-IPDU	Fan IPDU																																									
		1 (Upper)	2 (Lower)																																								
01	0																																										
02		0																																									
03	0	0																																									
04			0																																								
05	0		0																																								
06		0	0																																								
07	0	0	0																																								

Check code			Location of detection	Description	System status	Check code detection condition(s)	Check items (locations)
Main remote controller	Outdoor 7-segment display						
	Check code	Sub-code					
F01	-	-	Indoor unit	Indoor TCJ sensor trouble	Stop of corresponding unit	Sensor resistance is infinity or zero (open / short circuit).	<ul style="list-style-type: none"> • Check connection of TCJ sensor connector and wiring. • Check resistance characteristics of TCJ sensor. • Check for trouble in indoor P.C. board.
F02	-	-	Indoor unit	Indoor TC2 sensor trouble	Stop of corresponding unit	Sensor resistance is infinity or zero (open / short circuit).	<ul style="list-style-type: none"> • Check connection of TC2 sensor connector and wiring. • Check resistance characteristics of TC2 sensor. • Check for trouble in indoor P.C. board.
F03	-	-	Indoor unit	Indoor TC1 sensor trouble	Stop of corresponding unit	Sensor resistance is infinity or zero (open / short circuit).	<ul style="list-style-type: none"> • Check connection of TC1 sensor connector and wiring. • Check resistance characteristics of TC1 sensor. • Check for trouble in indoor P.C. board.
F04	F04	-	I/F	TD sensor trouble	All stop	Sensor resistance is infinity or zero (open / short circuit).	<ul style="list-style-type: none"> • Check connection of TD sensor connector. • Check resistance characteristics of TD sensor. • Check for trouble in outdoor P.C. board (I/F).
F06	F06	-	I/F	TE sensor trouble	All stop	Sensor resistance is infinity or zero (open / short circuit).	<ul style="list-style-type: none"> • Check connection of TE sensor connectors. • Check resistance characteristics of TE sensors. • Check for trouble in outdoor P.C. board (I/F).
F07	F07	01: TL1 sensor trouble 03: TL3 sensor trouble	I/F	TL1, TL3 sensor trouble	All stop	Sensor resistance is infinity or zero (open / short circuit).	<ul style="list-style-type: none"> • Check connection of TL1, TL3 sensor connector. • Check resistance characteristics of TL1, TL3 sensor. • Check for trouble in outdoor P.C. board (I/F).
F08	F08	-	I/F	TO sensor trouble	All stop	Sensor resistance is infinity or zero (open / short circuit).	<ul style="list-style-type: none"> • Check connection of TO sensor connector. • Check resistance characteristics of TO sensor. • Check for trouble in outdoor P.C. board (I/F).
F10	-	-	Indoor unit	Indoor TA sensor trouble	Stop of corresponding unit	Sensor resistance is infinity or zero (open / short circuit).	<ul style="list-style-type: none"> • Check connection of TA sensor connector and wiring. • Check resistance characteristics of TA sensor. • Check for trouble in indoor P.C. board.
F11	-	-	Indoor unit	Indoor TF sensor trouble	Stop of corresponding unit	Sensor resistance is infinity or zero (open / short circuit).	<ul style="list-style-type: none"> • Check connection of TF sensor connector and wiring. • Check resistance characteristics of TF sensor. • Check for trouble in indoor P.C. board.
F12	F12	01: TS1 sensor trouble 03: TS3 sensor trouble 04: TS3 sensor position trouble	I/F	TS1, TS3 sensor trouble	All stop	Sensor resistance is infinity or zero (open / short circuit).	<ul style="list-style-type: none"> • Check connection of TS1, TS3 sensor connector. • Check resistance characteristics of TS1, TS3 sensor. • Check for trouble in outdoor P.C. board (I/F). • Check TS3 sensor position

Check code			Location of detection	Description	System status	Check code detection condition(s)	Check items (locations)
Main remote controller	Outdoor 7-segment display						
	Check code	Sub-code					
F13	F13	–	IPDU	TH sensor trouble	All stop	Sensor resistance is zero (short circuit).	<ul style="list-style-type: none"> Trouble in IGBT built-in temperature sensor → Replace A3-IPDU board.
F15	F15	–	I/F	Outdoor temperature sensor wiring trouble (TE, TL1)	All stop	During compressor operation in HEAT mode, TE continuously provides temperature reading higher than indicated by TL1 by at least specified margin for 3 minutes or more.	<ul style="list-style-type: none"> Check installation of TE and TL1 sensors. Check resistance characteristics of TE and TL1 sensors. Check for outdoor P.C. board (I/F) trouble.
F16	F16	–	I/F	Outdoor pressure sensor wiring trouble (PD, PS)	All stop	Readings of high-pressure PD sensor and low-pressure PS sensor are switched. Output voltages of both sensors are zero.	<ul style="list-style-type: none"> Check connection of high-pressure PD sensor connector. Check connection of low-pressure PS sensor connector. Check for trouble in pressure sensors PD and PS. Check for trouble in outdoor P.C. board (I/F). Check for troubled in compressive output of compressor. Check 4-way valve trouble.
F23	F23	–	I/F	PS sensor trouble	All stop	Output voltage of PS sensor is zero.	<ul style="list-style-type: none"> Check for connection trouble involving PS sensor and PD sensor connectors. Check connection of PS sensor connector. Check for trouble in PS sensor. Check for troubled in compressive output of compressor. Check for trouble in 4-way valve. Check for trouble in outdoor P.C. board (I/F). Check for trouble in SV4 circuit.
F24	F24	–	I/F	PD sensor trouble	All stop	Output voltage of PD sensor is zero (sensor open-circuited). Pd > 4.15 MPa despite compressor having been turned off.	<ul style="list-style-type: none"> Check connection of PD sensor connector. Check for trouble in PD sensor. Check for trouble in outdoor P.C. board (I/F).
F29	–	–	Indoor unit	Other indoor trouble	Stop of corresponding unit	Indoor P.C. board does not operate normally.	<ul style="list-style-type: none"> Check for trouble in indoor P.C. board (troubled EEPROM)
F31	F31	–	I/F	Outdoor EEPROM trouble	All stop	Outdoor P.C. board (I/F) does not operate normally.	<ul style="list-style-type: none"> Check power supply voltage. Check power supply noise. Check for trouble in outdoor P.C. board (I/F).
H01	H01	–	IPDU	Compressor breakdown	All stop	Inverter current detection circuit detects overcurrent and shuts system down.	<ul style="list-style-type: none"> Check power supply voltage. (AC380-415V ± 10%) Check for trouble in compressor. Check for possible cause of abnormal overloading. Check for trouble in outdoor P.C. board (A3-IPDU). Check miswiring, misinstallation SV5.
H02	H02	–	IPDU	Compressor trouble (lockup)	All stop	Overcurrent is detected several seconds after startup of inverter compressor.	<ul style="list-style-type: none"> Check for trouble in compressor. Check power supply voltage. (AC380-415V ± 10%) Check compressor system wiring, particularly for open phase. Check connection of connectors / terminals on A3-IPDU P.C. board. Check for trouble in outdoor P.C. board (A3-IPDU).

Check code			Location of detection	Description	System status	Check code detection condition(s)	Check items (locations)
Main remote controller	Outdoor 7-segment display						
	Check code	Sub-code					
H03	H03	–	IPDU	Current detection circuit trouble	All stop	Current flow of at least specified magnitude is detected despite inverter compressor having been shut turned off.	<ul style="list-style-type: none"> • Check current detection circuit wiring. • Check trouble in outdoor P.C. board (A3-IPDU).
H05	H05	–	I/F	TD sensor miswiring (incomplete insertion)	All stop	Discharge temperature of compressor (TD) does not increase despite compressor operating.	<ul style="list-style-type: none"> • Check installation of TD sensor. • Check connection of TD sensor connector and wiring. • Check resistance characteristics of TD sensor. • Check for defect in outdoor P.C. board (I/F).
H06	H06	–	I/F	Activation of low-pressure protection	All stop	Low-pressure PS sensor detects operating pressure lower than 0.02 MPa.	<ul style="list-style-type: none"> • Check service valves to confirm full opening (both gas and liquid sides). • Check outdoor PMV1 for clogging. • Check for trouble in SV2 or SV4 circuits. • Check for defect in low-pressure PS sensor. • Check indoor filter for clogging. • Check valve opening status of indoor PMV1. • Check refrigerant piping for clogging. • Check operation of outdoor fan (during heating). • Check for insufficiency in refrigerant quantity.
H07	H07	–	I/F	Low oil level protection	All stop	Operating compressor detects continuous state of low oil level for about 1 hour.	<ul style="list-style-type: none"> • Check connection and installation of TK. • Check resistance characteristics of TK. • Check for gas or oil leak. • Check SV3 valve for trouble. • Check oil level detection circuit for clogging.
H08	H08	–	I/F	Trouble in temperature sensor for oil level detection	All stop	Sensor resistance is infinity or zero (open/short circuit).	<ul style="list-style-type: none"> • Check connection of TK sensor connector. • Check resistance characteristics of TK sensor. • Check for trouble in outdoor P.C. board (I/F).
H16	H16	–	I/F	Oil level detection circuit trouble	All stop	No temperature change is detected by TK despite compressor having been started.	<ul style="list-style-type: none"> • Check for disconnection of TK sensor. • Check resistance characteristics of TK sensor. • Check for clogging in oil level detection circuit capillary. • Check for stagnation of the refrigerant inside compressor.
L03	–	–	Indoor unit	Duplicated indoor outdoor unit	Stop of corresponding unit	There is more than one outdoor unit in group.	<ul style="list-style-type: none"> • Check indoor addresses. • Check for any change made to remote controller connection (group / individual) since indoor address setting.
L04	L04	–	I/F	Duplicated outdoor line address	All stop	There is duplication in line address setting for outdoor units belonging to different refrigerant piping systems.	<ul style="list-style-type: none"> • Check line addresses.
L05	–	–	I/F	Duplicated priority indoor unit (as displayed on priority indoor unit)	All stop	More than one indoor unit has been set up as priority indoor unit.	<ul style="list-style-type: none"> • Check display on priority indoor unit.

Check code			Location of detection	Description	System status	Check code detection condition(s)	Check items (locations)																																		
Main remote controller	Outdoor 7-segment display																																								
	Check code	Sub-code																																							
L06	L06	No. of priority indoor units	I/F	Duplicated priority indoor unit (as displayed on indoor unit other than priority indoor unit)	All stop	More than one indoor unit have been set up as priority indoor unit.	• Check displays on priority indoor unit and outdoor unit.																																		
L07	-	-	Indoor unit	Connection of group control cable to stand-alone indoor unit	Stop of corresponding unit	There is at least one stand-alone indoor unit to which group control cable is connected.	• Check indoor addresses.																																		
L08	L08	-	Indoor unit	Indoor group / addresses not set	Stop of corresponding unit	Address setting has not been performed for indoor units.	• Check indoor addresses. Note: This code is displayed when power is turned on for the first time after installation.																																		
L09	-	-	Indoor unit	Indoor capacity not set	Stop of corresponding unit	Capacity setting has not been performed for indoor unit.	Set indoor capacity. (DN = 11)																																		
L10	L10	-	I/F	Outdoor capacity not set	All stop	Jumper wire provided on P.C. board for servicing I/F P.C. board has not been removed as required for given model.	Check model setting of P.C. board for servicing outdoor I/F P.C. board.																																		
L20	-	-	AI-NET Indoor unit	Duplicated central control address	All stop	There is duplication in central control address setting.	• Check central control addresses. • Check network adaptor P.C. board.																																		
L23	-	02: SW setting mistake when HWM is connected	I/F	SW setting mistake	All stop	Bit4 of SW09 is not turned on when HWM is connected.	• Check switch setting of Bit4 of SW09 in outdoor P.C. board (I/F).																																		
L29	L29	<table border="1"> <thead> <tr> <th rowspan="2"></th> <th rowspan="2">A3-IPDU</th> <th colspan="2">Fan IPDU</th> </tr> <tr> <th>1 (Upper)</th> <th>2 (Lower)</th> </tr> </thead> <tbody> <tr><td>01</td><td>0</td><td></td><td></td></tr> <tr><td>02</td><td></td><td>0</td><td></td></tr> <tr><td>03</td><td>0</td><td>0</td><td></td></tr> <tr><td>04</td><td></td><td></td><td>0</td></tr> <tr><td>05</td><td>0</td><td></td><td>0</td></tr> <tr><td>06</td><td></td><td>0</td><td>0</td></tr> <tr><td>07</td><td>0</td><td>0</td><td>0</td></tr> </tbody> </table> <p>Circle (O): Faulty IPDU (*) Concerning the "00" auxiliary code 1) The wrong model setting for the interface P.C. board was used when the board was replaced with the service P.C. board. In such a case, the sub-codes "08" to "0F" for L29, which are not included in the table above, may be displayed. 2) The wrong model setting for the IPDU P.C. board was used when the board was replaced with the service P.C. board.</p>		A3-IPDU	Fan IPDU		1 (Upper)	2 (Lower)	01	0			02		0		03	0	0		04			0	05	0		0	06		0	0	07	0	0	0	I/F	Trouble in No. of IPDUs	All stop	Insufficient number of IPDUs are detected when power is turned on.	• Check model setting of P.C. board for servicing outdoor I/F P.C. board. • Check connection of UART communication connector. • Check A3-IPDU, fan IPDU, and I/F P.C. board for defect.
	A3-IPDU	Fan IPDU																																							
		1 (Upper)	2 (Lower)																																						
01	0																																								
02		0																																							
03	0	0																																							
04			0																																						
05	0		0																																						
06		0	0																																						
07	0	0	0																																						
L30	L30	Detected indoor address	Indoor unit	External interlock of indoor unit	Stop of corresponding unit	• Signal is present at external error input terminal (CN80) for 1 minute.	When external device is connected to CN80 connector: 1) Check for defect in external device. 2) Check for trouble in indoor P.C. board. When external device is not connected to CN80 connector: 1) Check for trouble in indoor P.C. board.																																		
-	L31	-	I/F	Extended IC trouble	Continued operation	There is part failure in P.C. board (I/F).	Check outdoor P.C. board (I/F).																																		

Check code			Location of detection	Description	System status	Check code detection condition(s)	Check items (locations)
Main remote controller	Outdoor 7-segment display						
	Check code	Sub-code					
P01	-	-	Indoor unit	Indoor fan motor trouble	Stop of corresponding unit		<ul style="list-style-type: none"> • Check the lock of fan motor (AC fan). • Check wiring.
P03	P03	-	I/F	Discharge temperature TD trouble	All stop	Discharge temperature (TD) exceeds 115 °C.	<ul style="list-style-type: none"> • Check outdoor service valves (gas side, liquid side) to confirm full opening. • Check outdoor PMV1 for clogging. • Check resistance characteristics of TD sensor. • Check for insufficiency in refrigerant quantity. • Check for trouble in 4-way valve. • Check leakage of SV4 circuit. • Check SV4 circuit (wiring or installation trouble in SV4). • Check leakage of SV5 circuit.
P04	P04		I/F	Activation of high-pressure SW	All stop	High-pressure SW is activated.	<ul style="list-style-type: none"> • Check connection of high-pressure SW connector. • Check for trouble in PD pressure sensor. • Check outdoor service valves (gas side, liquid side) to confirm full opening. • Check for trouble in outdoor fan. • Check for trouble in outdoor fan motor. • Check outdoor PMV1 for clogging. • Check indoor/outdoor heat exchangers for clogging. • Check for short-circuiting of outdoor suction/discharge air flows. • Check SV2 circuit for clogging. • Check for trouble in outdoor P.C. board (I/F). • Check for trouble in indoor fan system (possible cause of air flow reduction). • Check opening status of indoor PMV. • Check indoor-outdoor communication line for wiring trouble. • Check for faulty operation of check valve in discharge pipe convergent section. • Check gas balancing SV4 valve circuit. • Check SV5 valve circuit. • Check for refrigerant overcharging.

		Check code		Location of detection	Description	System status	Check code detection condition(s)	Check items (locations)
Main remote controller	Outdoor 7-segment display							
	Check code	Sub-code						
P05	P05	00: Open phase detected	I/F	Detection of open phase / phase sequence	All stop	<ul style="list-style-type: none"> Open phase is detected when power is turned on. Inverter DC voltage is too high (overvoltage) or too low (undervoltage). 	<ul style="list-style-type: none"> Check for defect in outdoor P.C. board (I/F). Check for trouble in outdoor P.C. board (A3-IPDU). Check for defect in fan IPDU P.C. board. Check for defect in outdoor power supply wiring. Check for defect in wiring of CN400 and CN530 on interface P.C. board. 	
		E(: Fan motor number)	IPDU	Inverter DC voltage (Vdc) trouble (outdoor fan motor)				
		–		Inverter DC voltage (Vdc) trouble (compressor)				
P07	P07	–	IPDU I/F	Heat sink overheating trouble	All stop	Temperature sensor built into IGBT (TH) is overheated.	<ul style="list-style-type: none"> Check power supply voltage. Check outdoor fan system trouble. Check heat sink cooling duct for clogging. Check IGBT and heat sink for thermal performance for troubled installation. (e.g. mounting screws and thermal conductivity) Check for trouble in A3-IPDU (troubled IGBT built-in temperature sensor (TH)) 	
P10	P10	Detected indoor address	Indoor unit	Indoor overflow trouble	All stop	<ul style="list-style-type: none"> Float switch operates. Float switch circuit is open-circuited or disconnected at connector. 	<ul style="list-style-type: none"> Check float switch connector. Check operation of drain pump. Check drain pump circuit. Check drain pipe for clogging. Check for trouble in indoor P.C. board. 	
P12	–	–	Indoor unit	Indoor fan motor trouble	Stop of corresponding unit	<ul style="list-style-type: none"> Motor speed measurements continuously deviate from target value. Overcurrent protection is activated. 	<ul style="list-style-type: none"> Check connection of fan connector and wiring. Check for trouble in fan motor. Check for trouble in indoor P.C. board. Check impact of outside air treatment (OA). 	
P13	P13	–	I/F	Outdoor liquid backflow detection trouble	All stop	<During heating operation> When system is in heating operation, outdoor PMV1 continuously registers opening of 300 pulse or less while under super heat control.	<ul style="list-style-type: none"> Check full-close operation of outdoor PMV1. Check for trouble in PD or PS sensor. Check gas balancing circuit (SV2) for clogging. Check trouble in outdoor P.C. board (I/F). Check capillary of oil separator oil return circuit for clogging. Check for leakage of check valve in discharge pipe convergent section. 	

Check code			Location of detection	Description	System status	Check code detection condition(s)	Check items (locations)
Main remote controller	Outdoor 7-segment display						
	Check code	Sub-code					
P15	P15	01: TS1 condition	I/F	Gas leakdetection (TS condition)	All stop	Protective shutdown due to sustained suction temperature at or above judgment criterion for at least 10 minutes is repeated four times or more. <TS1 failure judgment criterion> In cooling operation: 60 °C In heating operation: 40 °C	<ul style="list-style-type: none"> • Check for insufficiency in refrigerant quantity. • Check outdoor service valves (gas side, liquid side) to confirm full opening. • Check outdoor PMV1 for clogging. • Check resistance characteristics of TS1 sensor. • Check for trouble in 4-way valve. • Check SV4, SV5 circuit for leakage
		02: TD condition	I/F	Gas leak detection (TD condition)	All stop	Protective shutdown due to sustained discharge temperature (TD) at or above 108 °C for at least 10 minutes is repeated four times or more.	<ul style="list-style-type: none"> • Check for insufficiency in refrigerant quantity. • Check outdoor PMV1 for clogging. • Check resistance characteristics of TD sensor. • Check indoor filter for clogging. • Check piping for clogging. • Check SV4 circuit (for leakage or coil installation trouble).
P19	P19	Detected outdoor unit No.	I/F	4-way valve reversing trouble	All stop	Abnormal refrigerating cycle data is collected during heating operation.	<ul style="list-style-type: none"> • heck for trouble in main body of 4-way valve. • Check for coil trouble in 4-way valve and loose connection of its connector. • Check resistance characteristics of TS1 and TE sensors. • Check output voltage characteristics of Pd and PS pressure sensors. • Check for wiring trouble involving TE and TL1 sensors.
P20	P20	—	I/F	Activation of high-pressure protection	All stop	PD sensor detects pressure equal to or greater than the following values: 3.9 MPa (Cooling), 3.7 MPa (Heating).	<ul style="list-style-type: none"> • Check for trouble in Pd pressure sensor. • Check service valves (gas side, liquid side) to confirm full opening. • Check for trouble in outdoor fan. • Check for trouble in outdoor fan motor. • Check outdoor PMV1 for clogging. • Check indoor / outdoor heat exchangers for clogging. • Check for short-circuiting of outdoor suction / discharge air flows. • Check SV2 circuit for clogging. • Check for trouble in outdoor P.C. board (I/F). • Check for trouble in indoor fan system (possible cause of air flow reduction). • Check opening status of indoor PMV. • Check indoor-outdoor communication line for wiring trouble. • Check for troubled operation of check valve in discharge pipe convergent section. • Check gas balancing SV4 valve circuit. • Check SV5 valve circuit. • Check for refrigerant overcharging.

Main remote controller	Check code		Location of detection	Description	System status	Check code detection condition(s)	Check items (locations)
	Outdoor 7-segment display						
	Check code	Sub-code					
P22	P22	*0: IGBT shortcircuit *1: Position detection circuit trouble *3: Motor lockup trouble *C: TH Sensor temperature trouble (*: Fan motor number)	IPDU	Outdoor fan IPDU trouble	All stop	(Sub code: *0) Fan IPDU over current protection circuit Flow of current equal to or greater than the specified value is detected during startup of the fan.	<ul style="list-style-type: none"> • Check fan motor. • Check for defect in fan IPDU P.C. board.
					All stop	(Sub code: *1) Fan IPDU position detection circuit Position detection is not going on normally.	<ul style="list-style-type: none"> • Check fan motor. • Check connection of fan motor connector. • Check for defect in fan IPDU P.C. board.
					All stop	(Sub code: *3) Gusty wind, an obstruction, or another external factor Speed estimation is not going on normally.	<ul style="list-style-type: none"> • Check fan motor. • Check for defect in fan IPDU P.C. board.
					All stop	(Sub code: *C) Higher temperature than the specified value is detected during operation of the fan.	<ul style="list-style-type: none"> • Check fan motor. • Check for defect in fan IPDU P.C. board.
P26	P26	–	IPDU	IGBT (IPM) short-circuit protection trouble	All stop	Overcurrent is momentarily detected during startup of compressor.	<ul style="list-style-type: none"> • Check connector connection and wiring on A3-IPDU P.C. board. • Check for trouble in compressor (layer short-circuit). • Check for defect in outdoor P.C. board (A3-IPDU).
P29	P29	–	IPDU	Compressor position detection circuit trouble	All stop	Position detection is not going on normally.	<ul style="list-style-type: none"> • Check wiring and connector connection. • Check for compressor layer short-circuit. • Check for trouble in A3-IPDU P.C. board.
P31	–	–	Indoor unit	Other indoor trouble (group follower unit trouble)	Stop of corresponding unit	There is trouble in other indoor unit in group, resulting in detection of E07 / L07 / L03 / L08.	<ul style="list-style-type: none"> • Check indoor P.C. board.

Errors detected by TCC-LINK central control device

Check code		Location of detection	Description	System status	Check code detection condition(s)	Check items (locations)
Main remote controller	Outdoor 7-segment display					
Sub-code						
C05	–	TCC-LINK	TCC-LINK central control device transmission trouble	Continued operation	Central control device is unable to transmit signal.	<ul style="list-style-type: none"> • Check for trouble in central control device. • Check for trouble in central control communication line. • Check termination resistance setting.
C06	–		TCC-LINK central control device reception trouble	Continued operation	Central control device is unable to receive signal.	<ul style="list-style-type: none"> • Check for trouble in central control device. • Check for trouble in central control communication line. • Check termination resistance setting. • Check power supply for devices at other end of central control communication line. • Check trouble in P.C. boards of devices at other end of central control communication line.
C12	–	General-purpose device I/F	Blanket alarm for general-purpose device control interface	Continued operation	Trouble signal is input to control interface for general-purpose devices.	<ul style="list-style-type: none"> • Check check code input.
P30	Differs according to nature of alarm-causing trouble	TCC-LINK	Group control follower unit trouble	Continued operation	Trouble occurs in follower unit under group control. ([P30] is displayed on central control remote controller.)	<ul style="list-style-type: none"> • Check check code of unit that has generated alarm.
	(L20 displayed.)		Duplicated central control address	Continued operation	There is duplication in central control addresses.	<ul style="list-style-type: none"> • Check address settings.

▼ Points to Note When Servicing Compressor

- (1) When checking the outputs of inverters, remove the wiring from the compressors.

▼ How to Check Inverter Output

- (1) Turn off the power supply.
- (2) Remove compressor leads from the IPDU P.C. board (A3-IPDU). (Be sure to remove all the leads.)
- (3) Turn on the power supply and start cooling or heating operation.

Be careful not to make simultaneous contact with two or more ring tongue terminals for compressor leads or a ring tongue terminal and some other object (e.g. the unit cabinet).

- (4) Check the output voltage inverter-side (CN201, 202, 203).

If the result is unsatisfactory according to the judgment criteria given in the table below, replace the IPDU P.C. board.

No.	Measured leads	Criterion
1	Red-White	320 - 480V
2	White-Black	320 - 480V
3	Black-Red	320 - 480V

- * When connecting the compressor leads back to the compressor terminals after checking the output, check the faston connectors thoroughly to ensure that they are not crooked. If there is any loose connector, tighten it with a pair of pliers, etc. before connecting the lead.

▼ How to Check Resistance of Compressor Winding

- (1) Turn off the power supply.
- (2) Remove compressor leads from the compressors.
- (3) With compressor, check the phase-to-phase winding resistances and winding-to-outdoor cabinet resistance using a multimeter.
 - Earth fault?
 - It is normal if the winding-to-outdoor cabinet resistance is 10 MΩ or more.
 - Inter-winding short circuit?
 - It is normal if the phase-to-phase resistances are in the 0.3-0.6 Ω range. (Use a digital multimeter.)

▼ How to Check Outdoor Fan Motor

- (1) Turn off the power supply.
- (2) Remove fan motor leads from the IPDU P.C. board for the outdoor fan (CN750 (Under side FM), CN700 (Upper side FM)).
- (3) Rotate the fan by hand. If the fan does not turn, the fan motor is faulty (locked up). Replace the fan motor. If the fan turns, measure the phase-to-phase winding resistances using a multimeter. It is normal if the measurements are in the 15.6-19.0 Ω range. (Use a digital multimeter.)

9-5. Diagnosis procedure for each check code

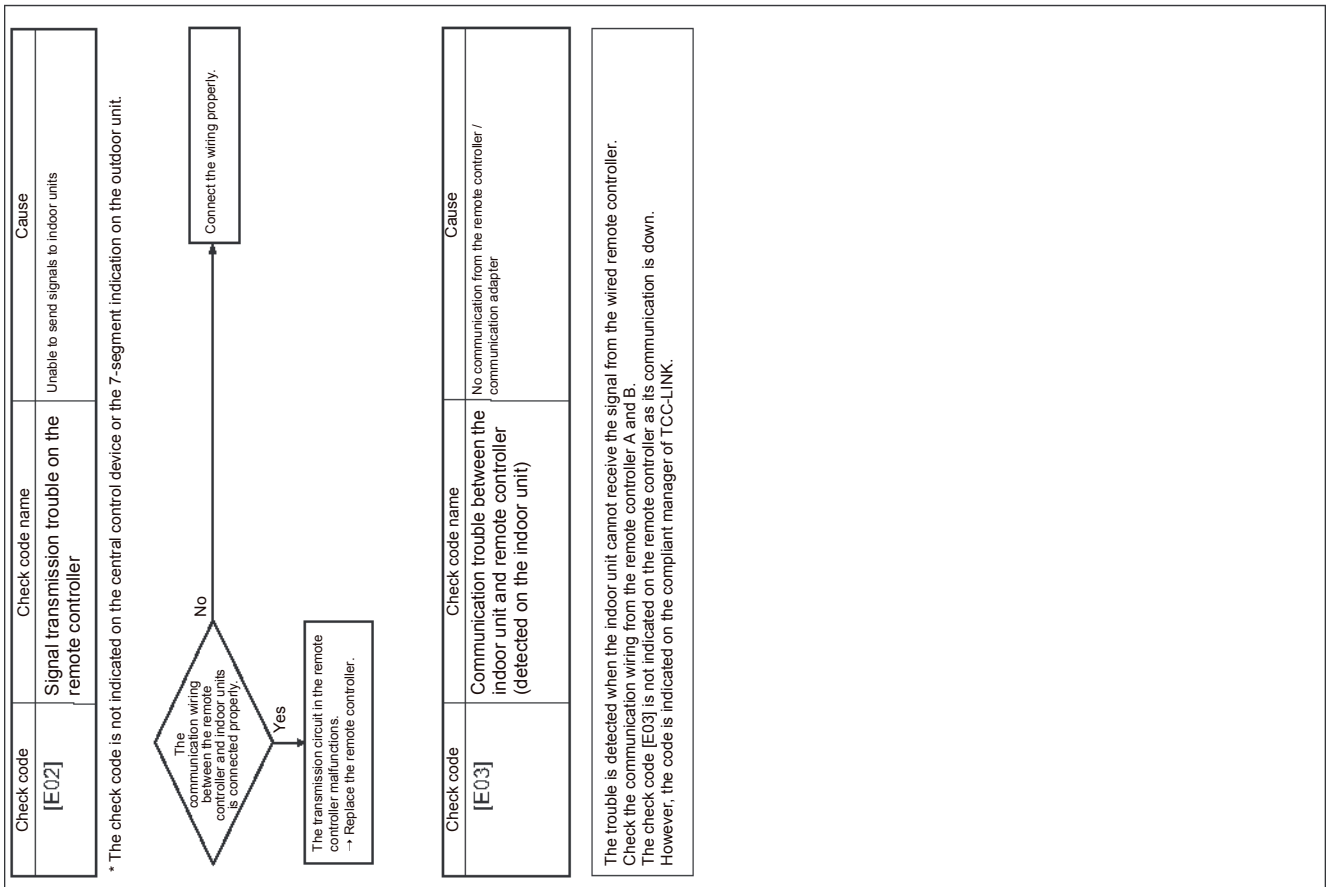
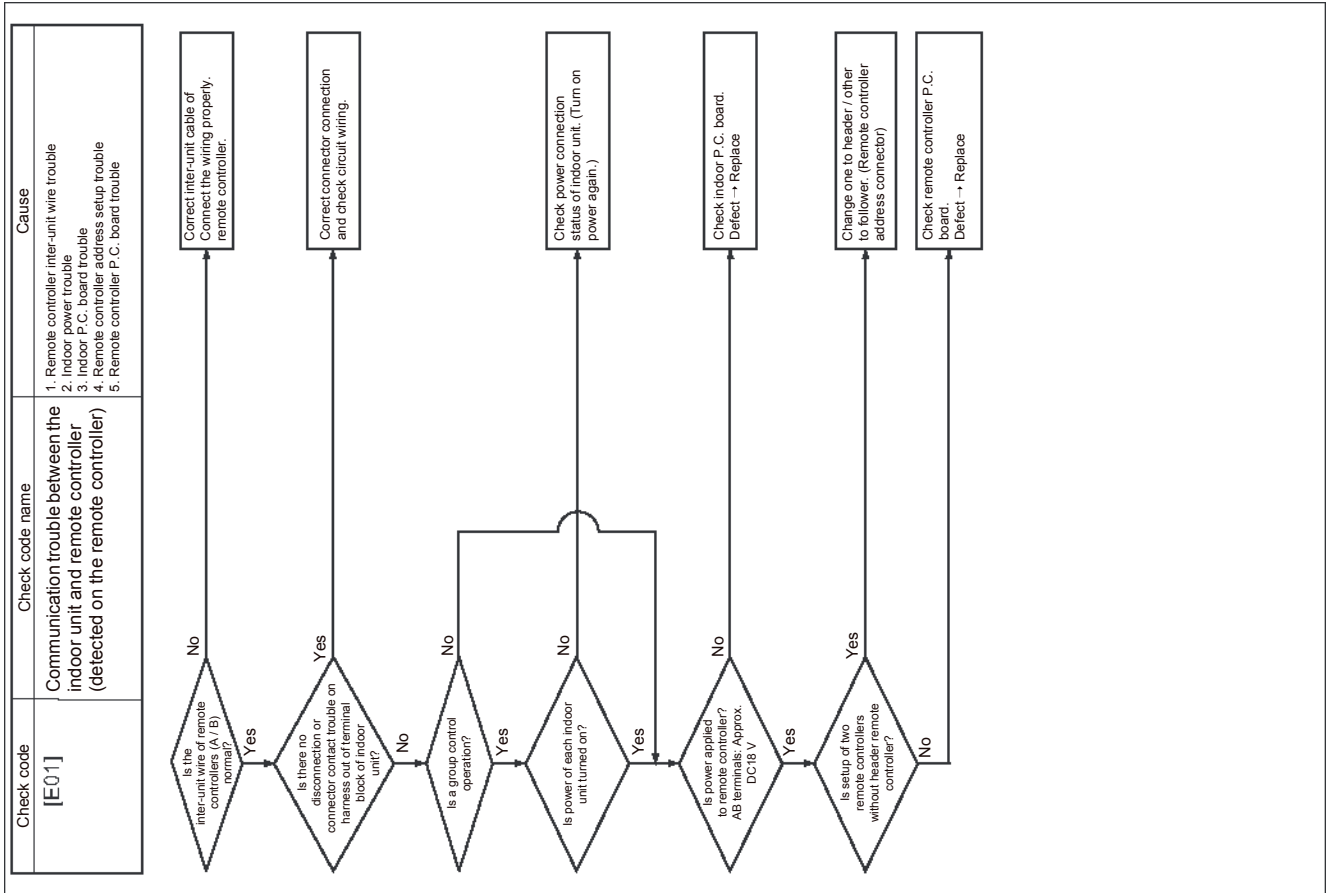

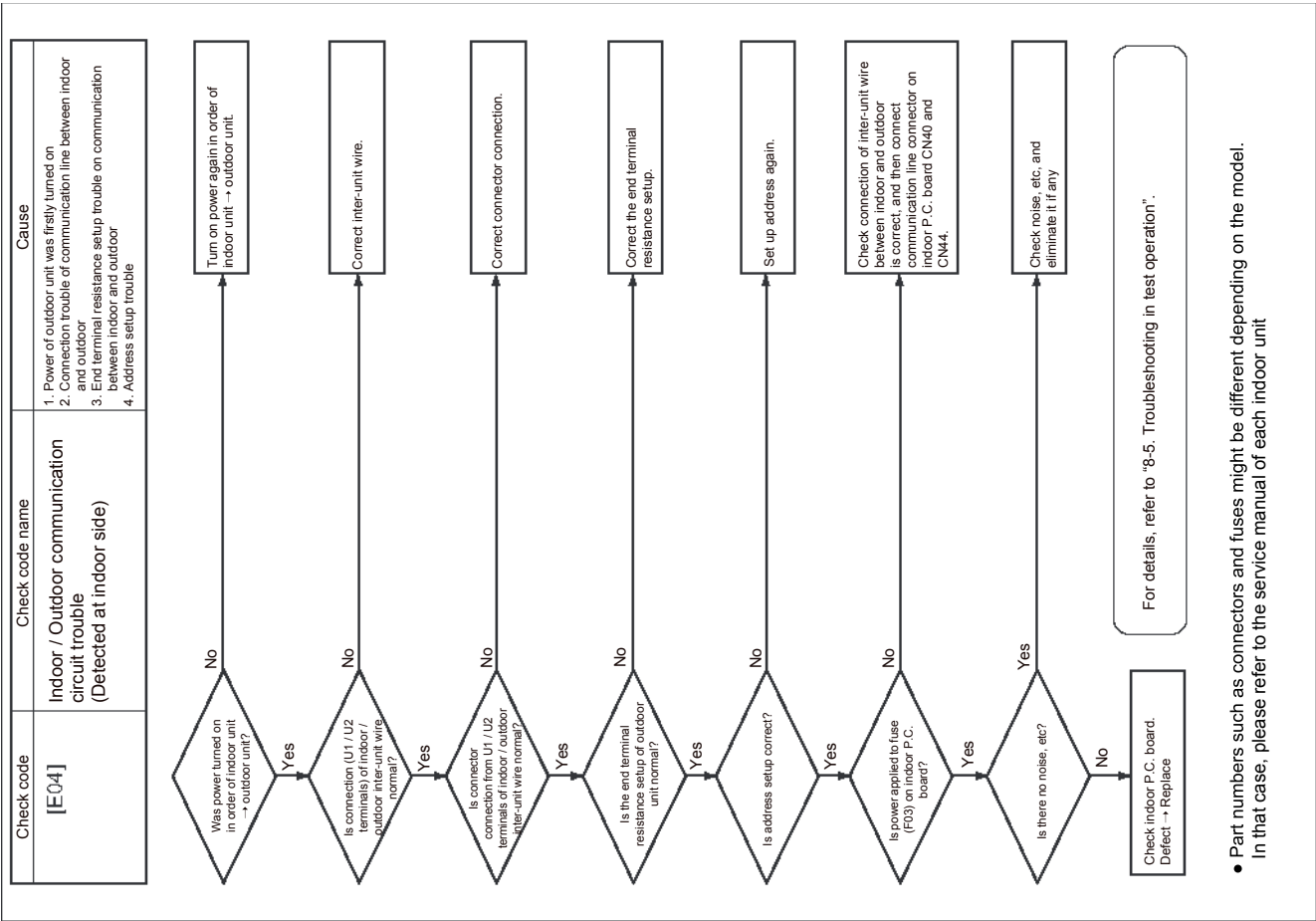

- Part numbers such as connectors and fuses might be different depending on the model. In that case, please refer to the service manual of each indoor unit

Check code	Check code name	Cause
[E06]	Decreased number of indoor units	1. Communication lines (U1, U2) connection trouble between indoor and outdoor 2. Communication connector's connection trouble on indoor unit, trouble on P.C. board 3. Communication connector's connection trouble on outdoor unit, trouble on I/F board 4. Power supply of indoor unit. (Is power turned on?)

Sub-code -: Reduction in number of HWM connected
 00: No. of indoor units which received signals normally

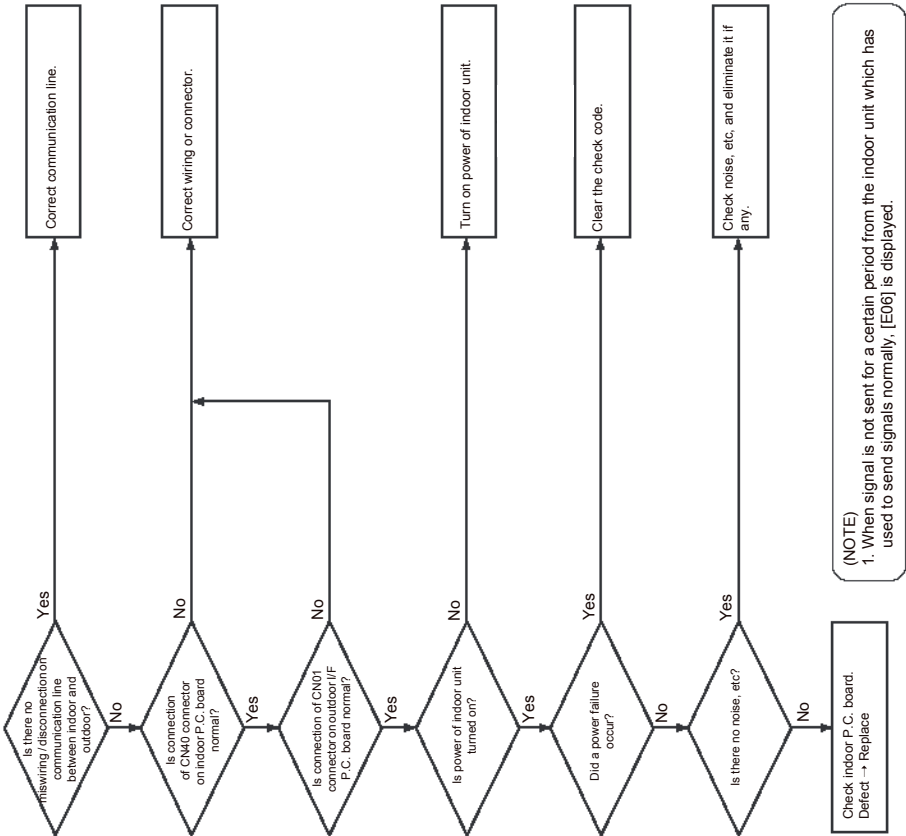

- Part numbers such as connectors and fuses might be different depending on the model. In that case, please refer to the service manual of each indoor unit.
- The error code [E06] will be displayed when the number of HWM in the system are reduced (such as turn off the HWM or remove it). Please check the power of indoor units (including HWM) is turn on or not. If there is no problem with the indoor unit, please make sure the number of HWM recorded in I/F PCBA is the same as the number of HWM which is currently connected in the system. If the former is less than the latter, [E06] will be displayed. While the number of HWM is reduced, please turn off the bit4 of SW09 in I/F PCBA so that the number of HWM which recorded in I/F PCBA will be cleared. When the bit4 of SW09 is off, and the [L23-2] is showing, please turn on the power of indoor units (including HWM) and then turn on the bit4 of SW09 again. Through the above operation, the display of [E06] and [L23-2] will disappear. Finally, please check the number of HWM in the I/F PCBA. And make sure the number of HWM recorded in I/F PCBA is the same as the number of HWM which is currently connected in the system. How to check the number of HWM recorded in I/F PCBA, please refer to [9-6.7-segment display function].

Note: When turn on the bit4 of SW09, please make sure that the power of indoor units (including HWM) are turned on. If the number of HWM is not correctly recorded on the I/F PCBA, the heat exchanger of HWM may be damaged by freezing.

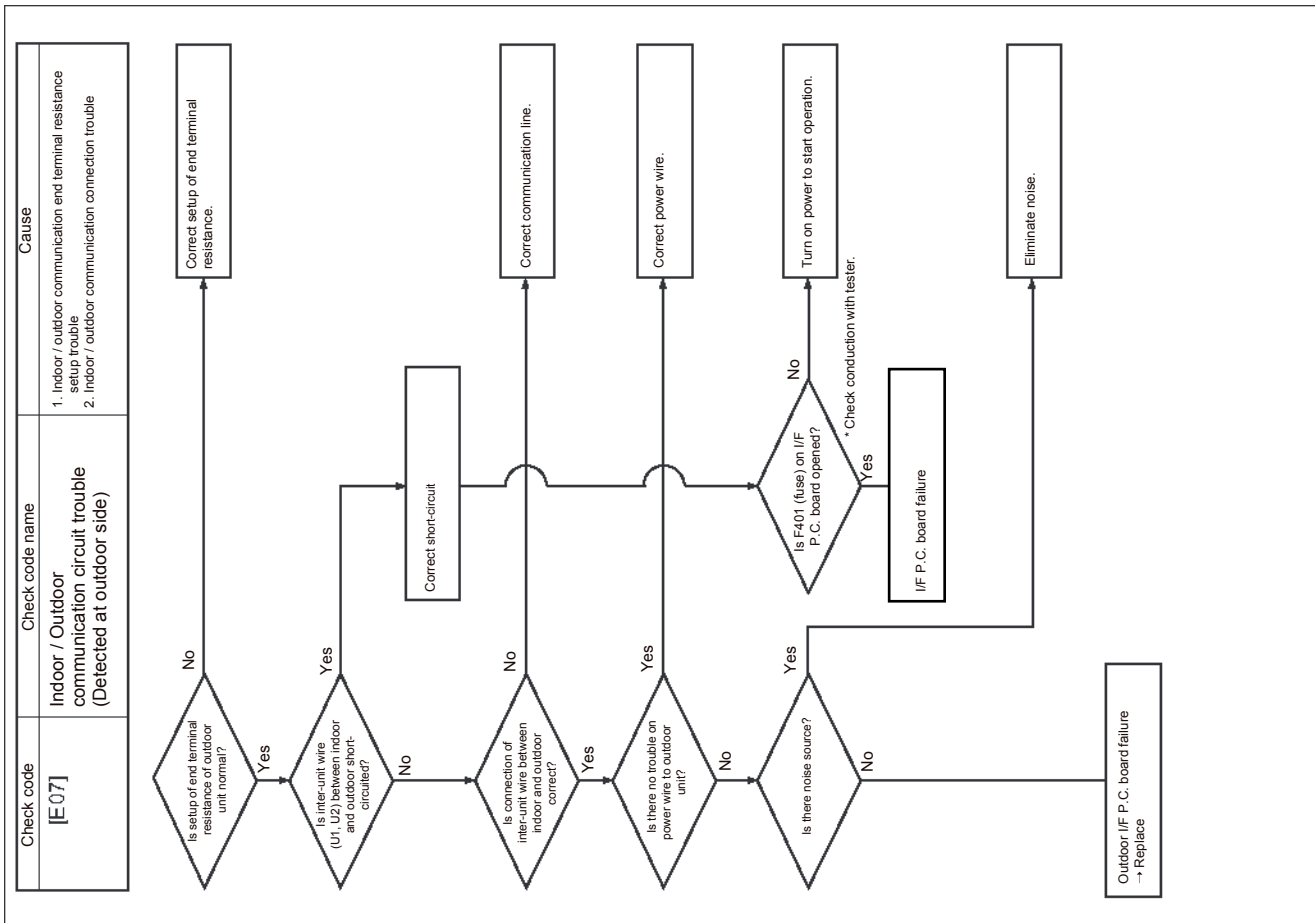
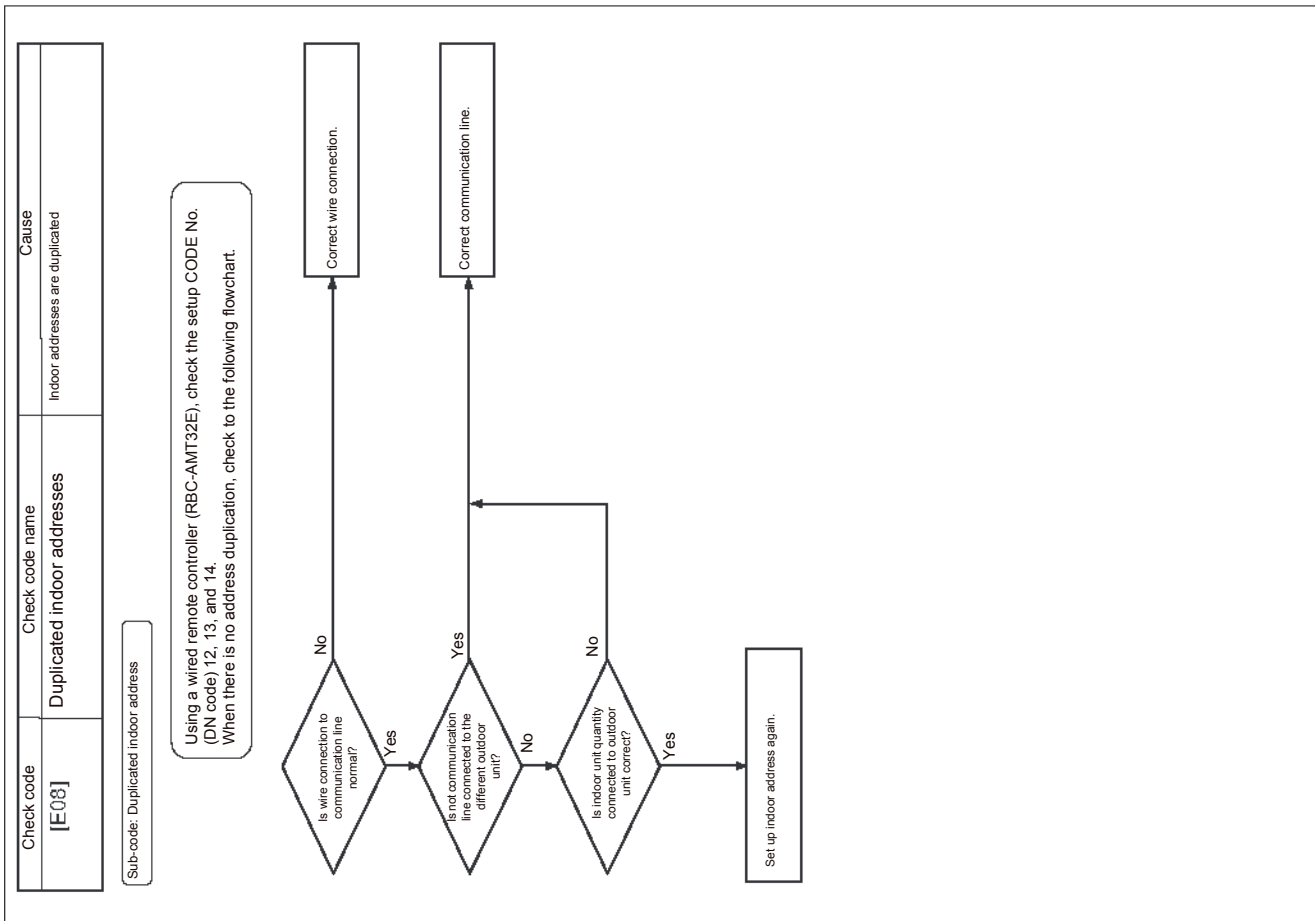

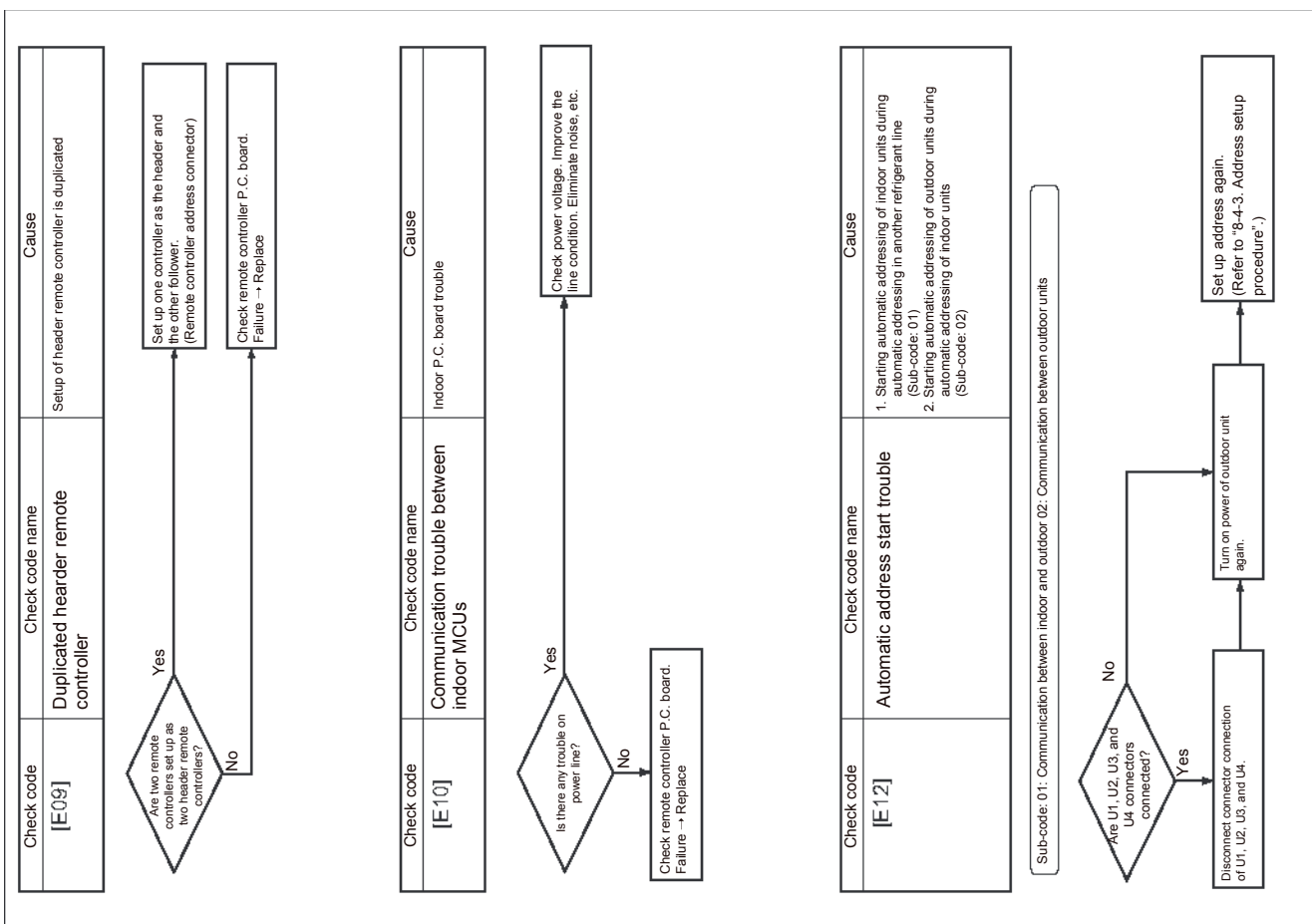
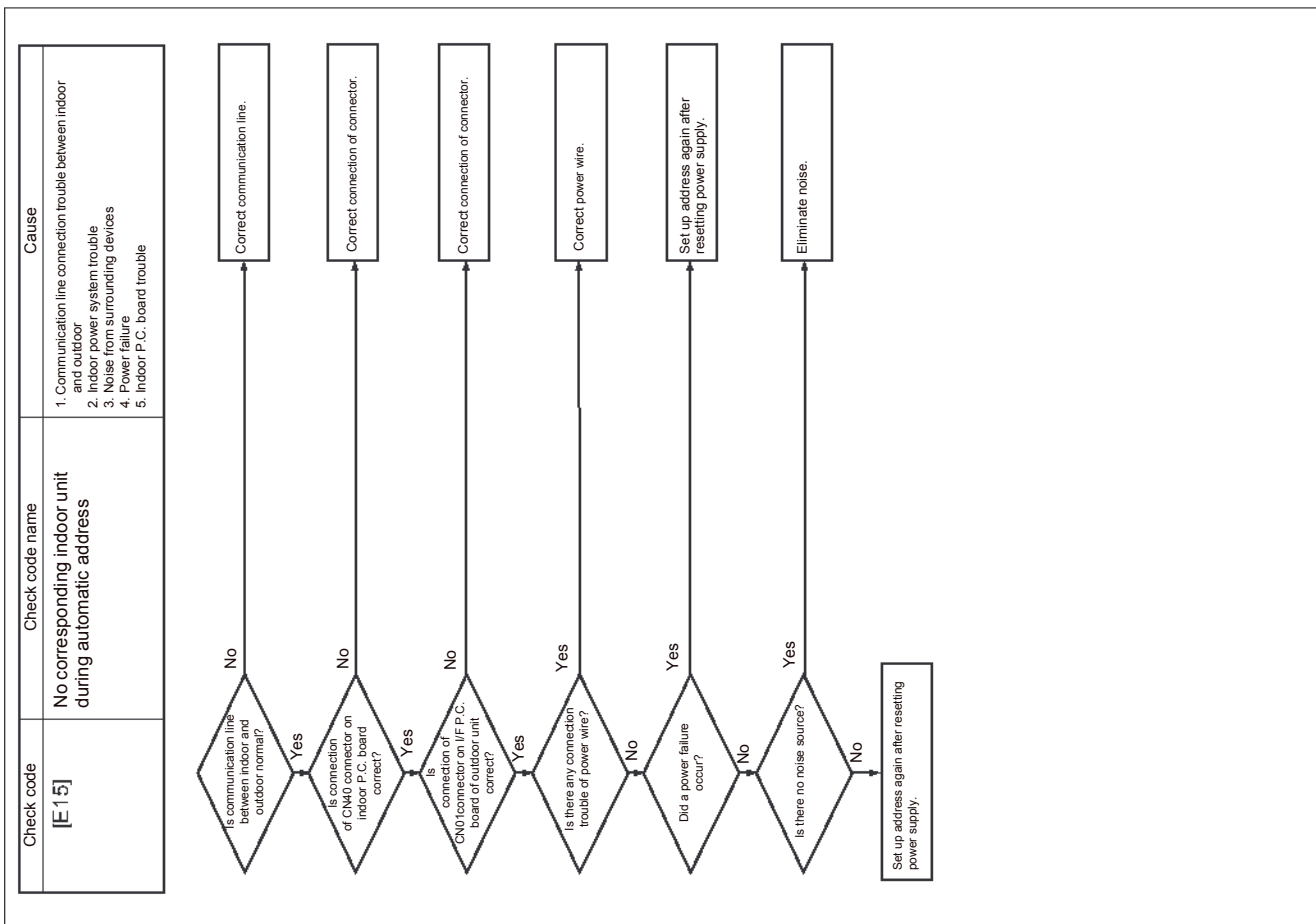

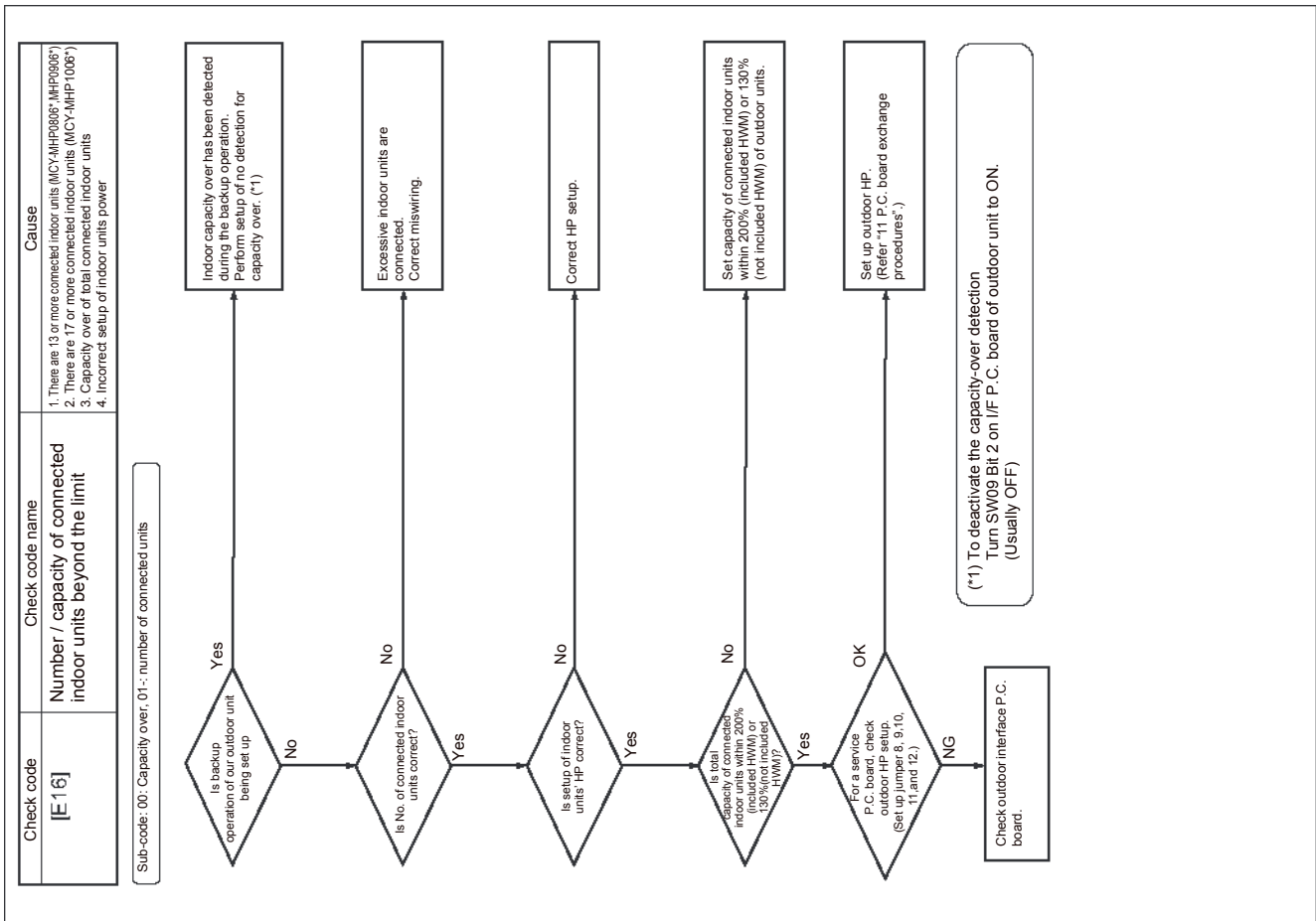
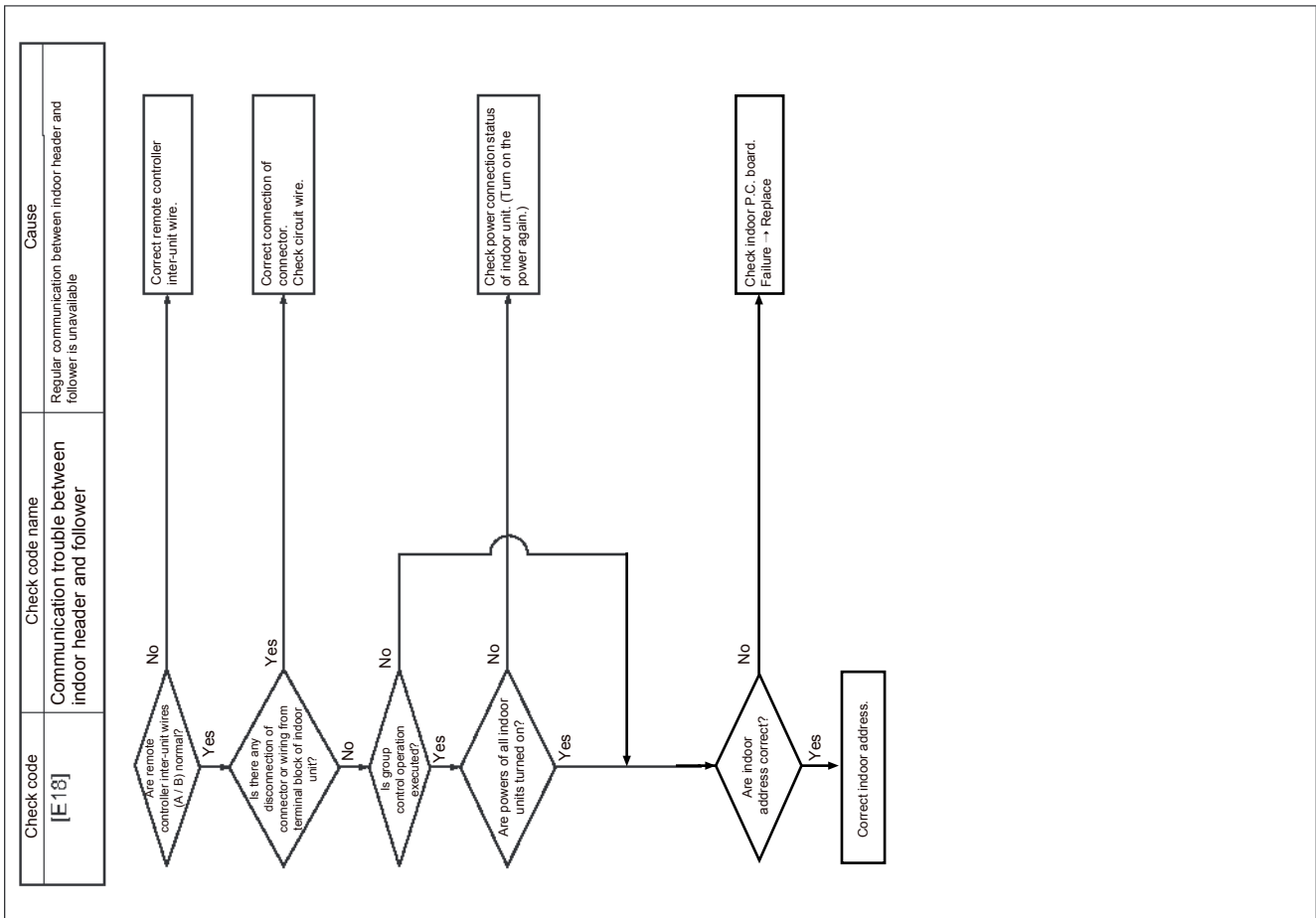

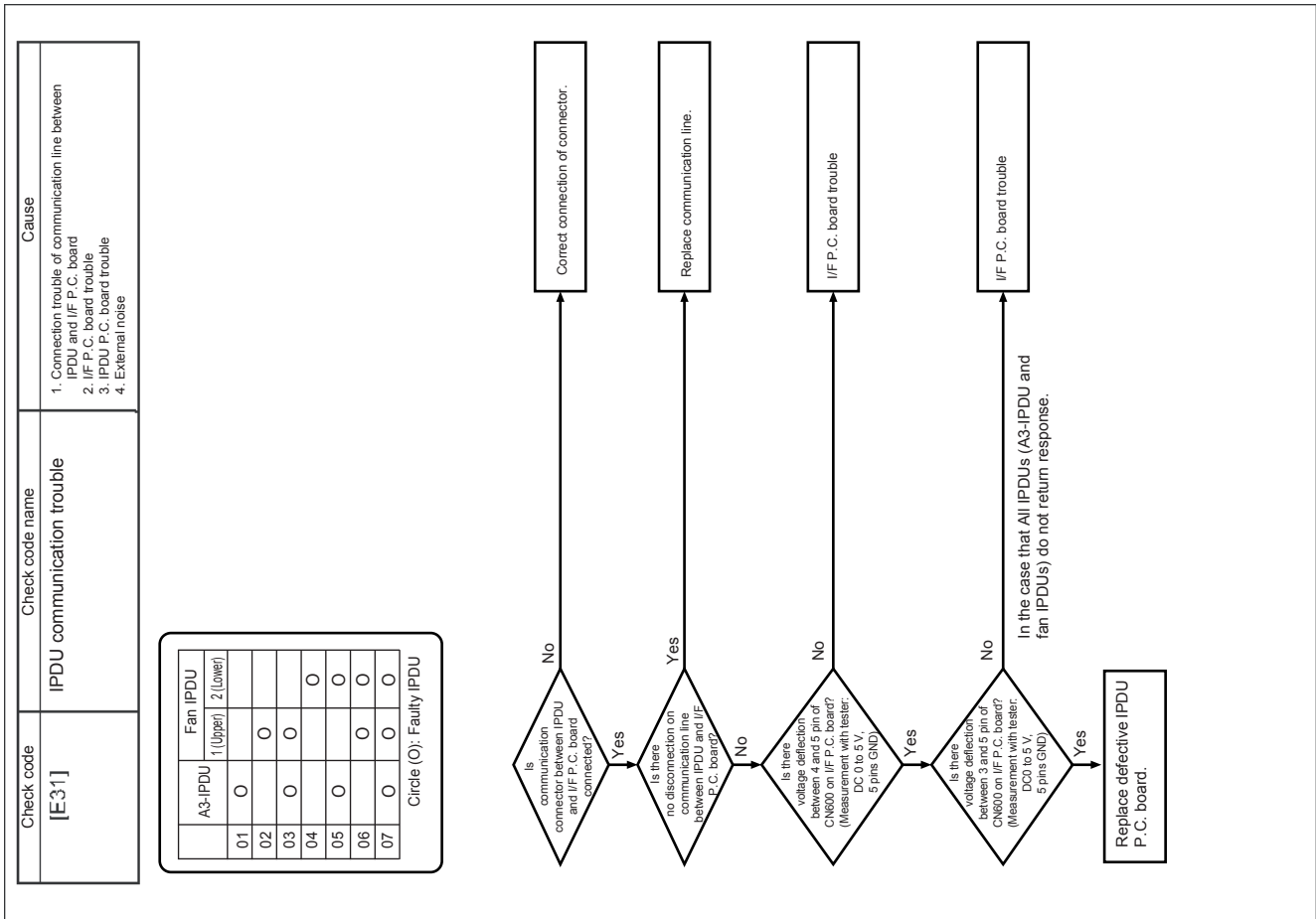
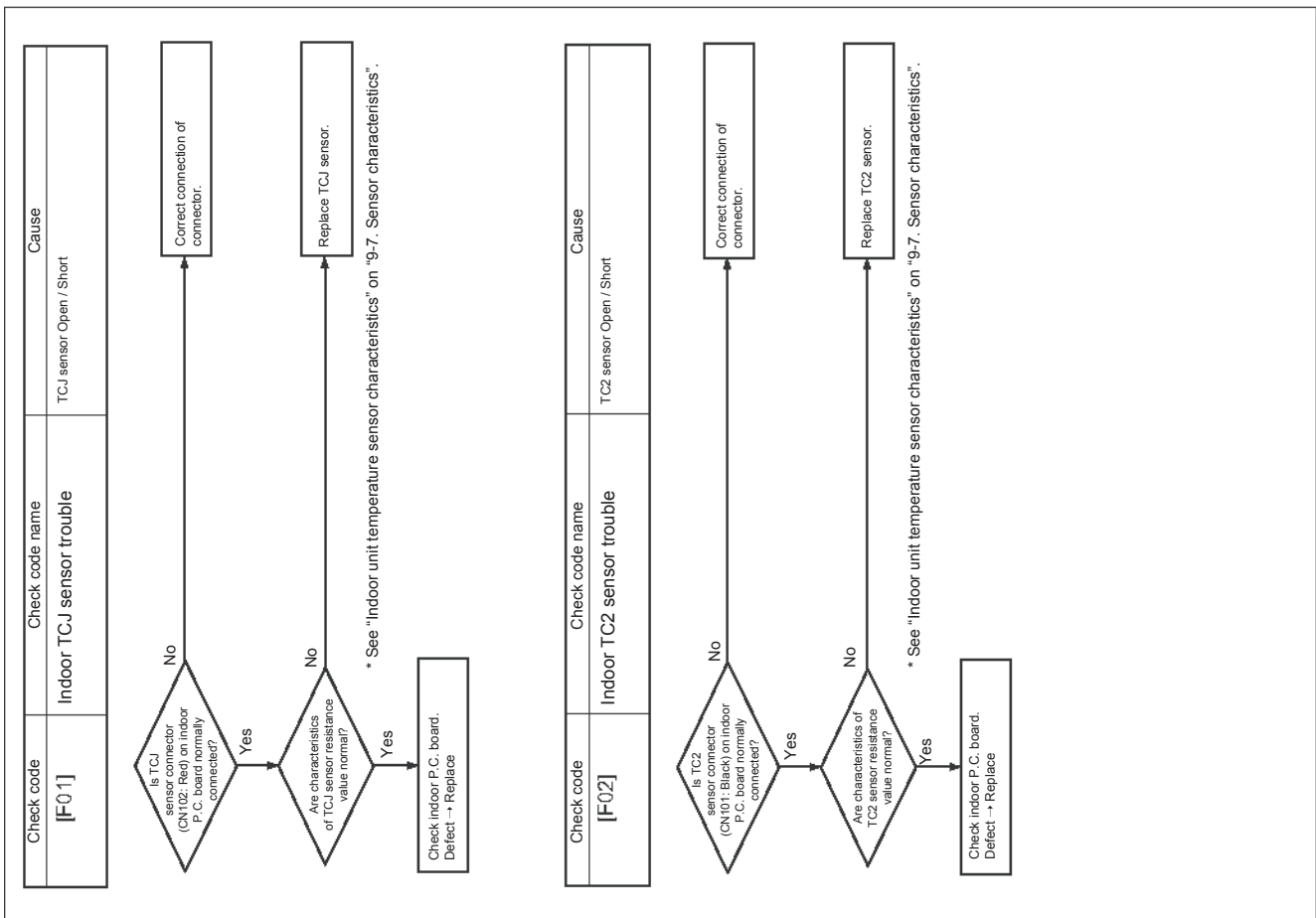

Check code [F08]	Check code name TO sensor trouble	Cause TO sensor Open / Short
<p>This trouble code means detection of Open / Short of TO sensor. Check disconnection of circuit for connection of connector (TO sensor: CN507, Yellow) and characteristics of sensor resistance value. (See "Outdoor unit temperature sensor characteristics" on "9-7. Sensor characteristics".) If sensor is normal, replace outdoor I/F P.C. board.</p>		
Check code [F10]	Check code name Indoor TA sensor trouble	Cause TA sensor Open / Short
<p>This trouble code means detection of Open / Short of TA sensor. Check disconnection of circuit for connection of connector (TA sensor: CN104, Yellow) and characteristics of sensor resistance value. (See "Indoor unit temperature sensor characteristics" on "9-7. Sensor characteristics".) If sensor is normal, replace indoor P.C. board.</p>		
<p>• Part numbers such as connectors and fuses might be different depending on the model. In that case, please refer to the service manual of each indoor unit.</p>		
Check code [F12]	Check code name TS1, TS3 sensor trouble	Cause TS1, TS3 sensor Open/Short TS3 sensor position trouble
<p>Sub-code:01:TS1,03:TS3,04:TS3</p> <p>This trouble code means detection of Open / Short of TS1, TS3 sensor. Check disconnection of circuit for connection of connector (TS1 sensor: CN505 White, TS3 sensor: CN506 Black) and characteristics of sensor resistance value. (See "Outdoor unit temperature sensor characteristics" on "9-7. Sensor characteristics".) If sensor is normal, replace outdoor I/F P.C. board.</p>		
Check code [F13]	Check code name TH sensor trouble	Cause IGBT built-in sensor trouble in A3-IPDU
<p>This trouble code means IGBT built-in temperature sensor trouble. Check connection of connectors CN852 on IPDU P.C. board and CN600 on I/F P.C. board. If sensor is normal, replace IPDU P.C. board.</p>		

Check code [F03]	Check code name Indoor TC1 sensor trouble	Cause TC1 sensor Open / Short
<pre> graph TD Q1{Is TC1 sensor connector (CN100: Brown) on indoor P.C. board normally connected?} Q2{Are characteristics of TC1 sensor resistance value normal?} A1[Correct connection of connector.] A2[Replace TC1 sensor.] A3[Check indoor main P.C. board. Detect -> Replace.] Q1 -- No --> A1 Q1 -- Yes --> Q2 Q2 -- No --> A2 Q2 -- Yes --> A3 </pre> <p>* See "Indoor unit temperature sensor characteristics" on "9-7. Sensor characteristics".</p>		
<p>• Part numbers such as connectors and fuses might be different depending on the model. In that case, please refer to the service manual of each indoor unit.</p>		
Check code [F04]	Check code name TD sensor trouble	Cause TD sensor Open / Short
<p>This trouble code means detection of Open / Short of TD sensor. Check disconnection of circuit for connection of connector (TD sensor: CN502, White) and characteristics of sensor resistance value. (See "Outdoor unit temperature sensor characteristics" on "9-7. Sensor characteristics".) If sensor is normal, replace outdoor I/F P.C. board.</p>		
Check code [F06]	Check code name TE sensor trouble	Cause TE sensor Open / Short
<p>This trouble code means detection of Open / Short of TE sensor. Check disconnection of circuit for connection of connector (TE sensor: CN520, Green) and characteristics of sensor resistance value. (See "Outdoor unit temperature sensor characteristics" on "9-7. Sensor characteristics".) If sensor is normal, replace outdoor I/F P.C. board.</p>		
Check code [F07]	Check code name TL1, TL3 sensor trouble	Cause TL1, TL3 sensor Open/Short
<p>Sub-code: 01:TL1, 03: TL3</p> <p>This trouble code means detection of Open / Short of TL1, TL3 sensor. Check disconnection of circuit for connection of connector (TL1 sensor: CN523 White, TL3 sensor: CN525 Red) and characteristics of sensor resistance value. (See "Outdoor unit temperature sensor characteristics" on "9-7. Sensor characteristics".) If sensor is normal, replace outdoor I/F P.C. board.</p>		

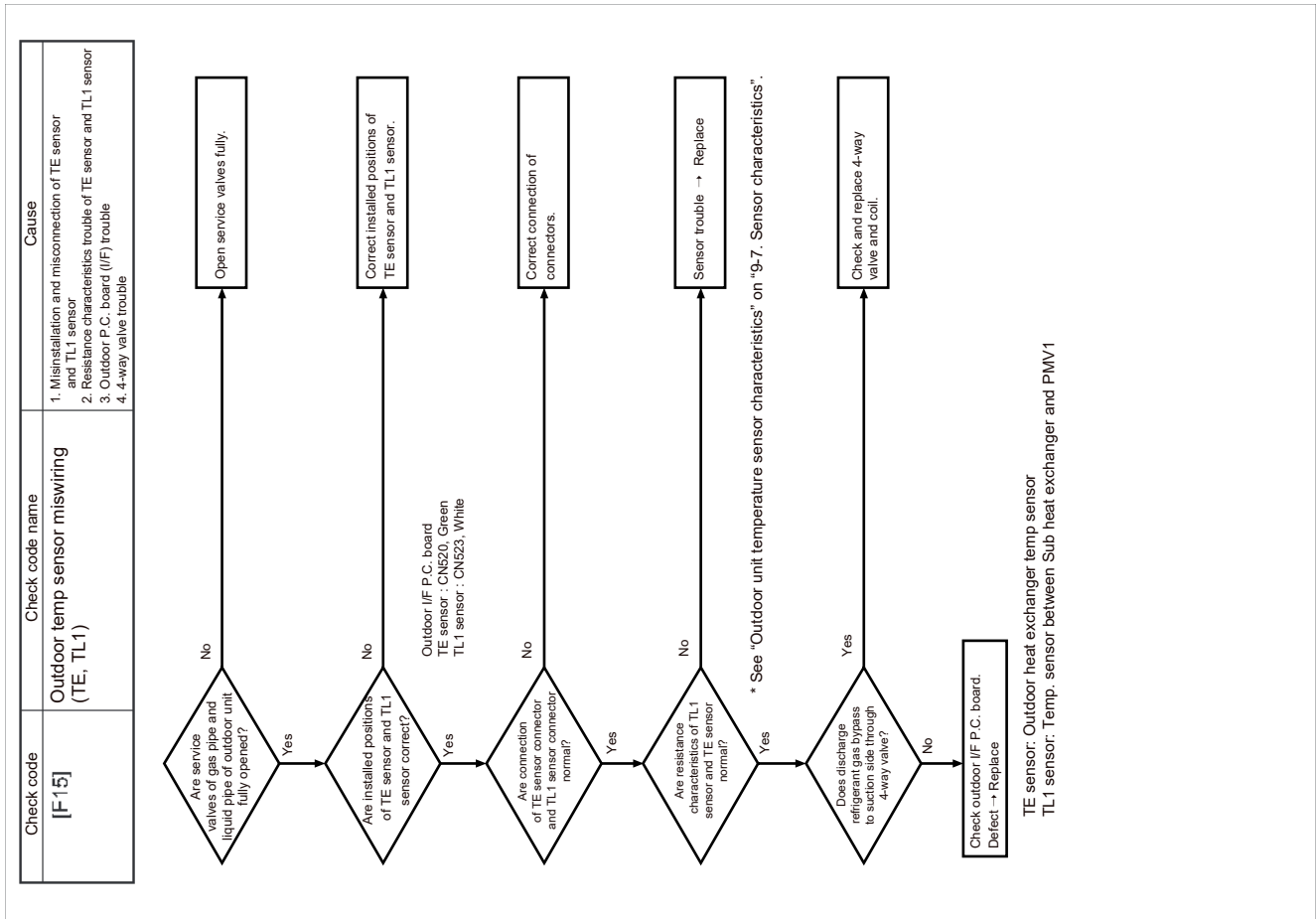
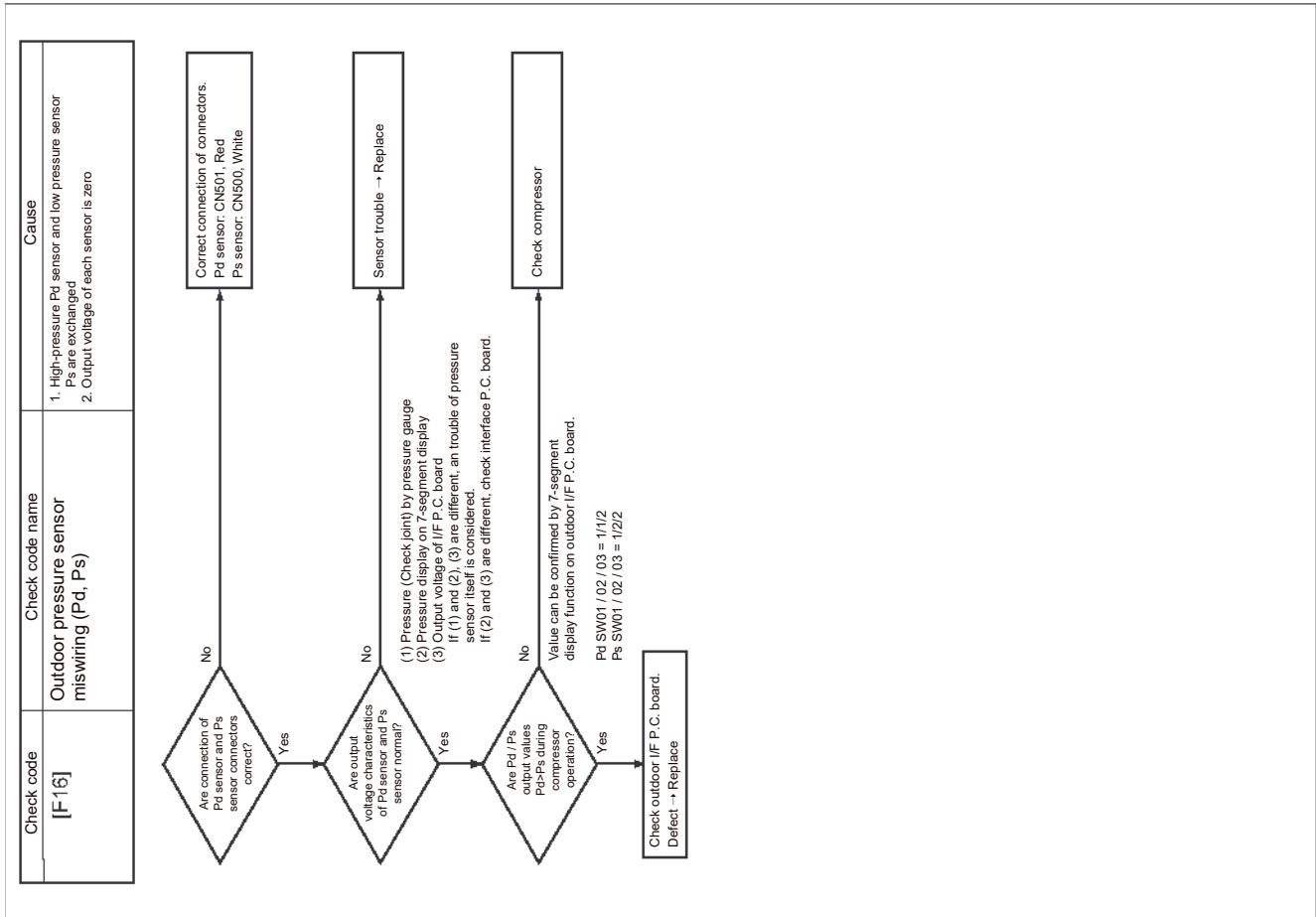

Check code	Check code name	Cause
[F29]	Indoor other trouble	Indoor P.C. board trouble

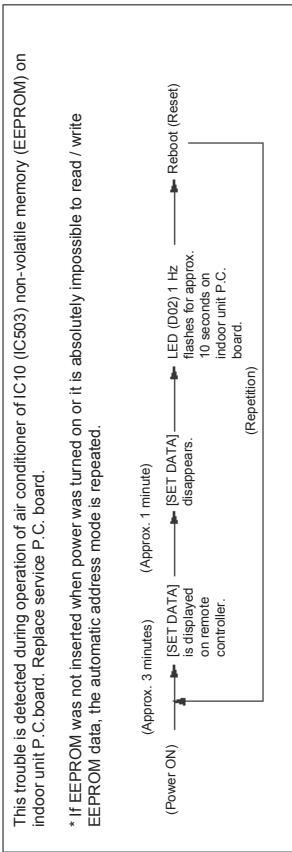

- Part numbers such as connectors and fuses might be different depending on the model. In that case, please refer to the service manual of each indoor unit.

Check code	Check code name	Cause
[F31]	Outdoor EEPROM trouble	1. Outdoor unit power trouble (Voltage, noise, etc.) 2. Outdoor I/F P.C. board trouble

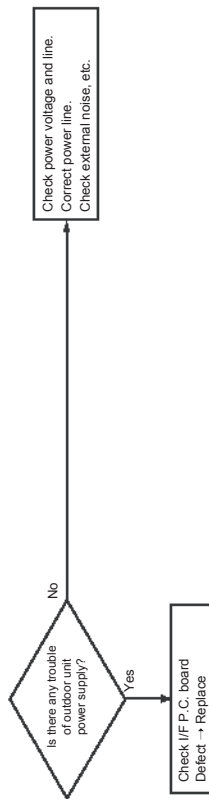

Check code	Check code name	Cause
[F23]	Ps sensor trouble	Output voltage trouble of Ps sensor

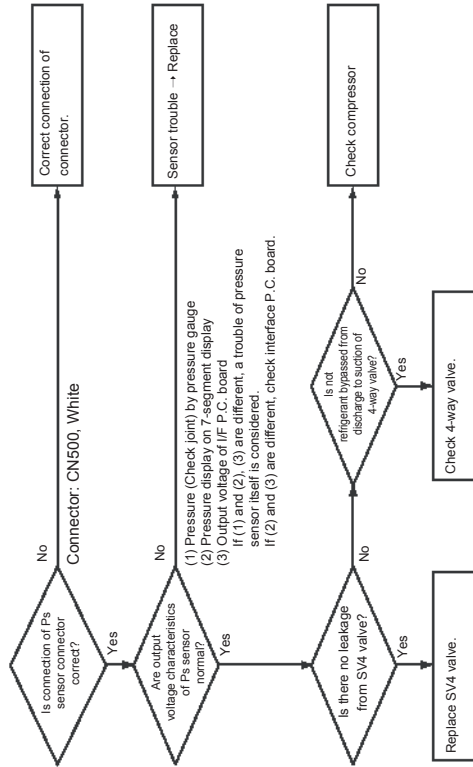

Check code	Check code name	Cause
[F24]	Pd sensor trouble	Output voltage trouble of Pd sensor

It is output voltage trouble of Pd sensor. Check disconnection of connection of connector (Pd sensor: CN501, red) circuit and output voltage of sensor.
If the sensor is normal, replace outdoor I/F P.C. board.

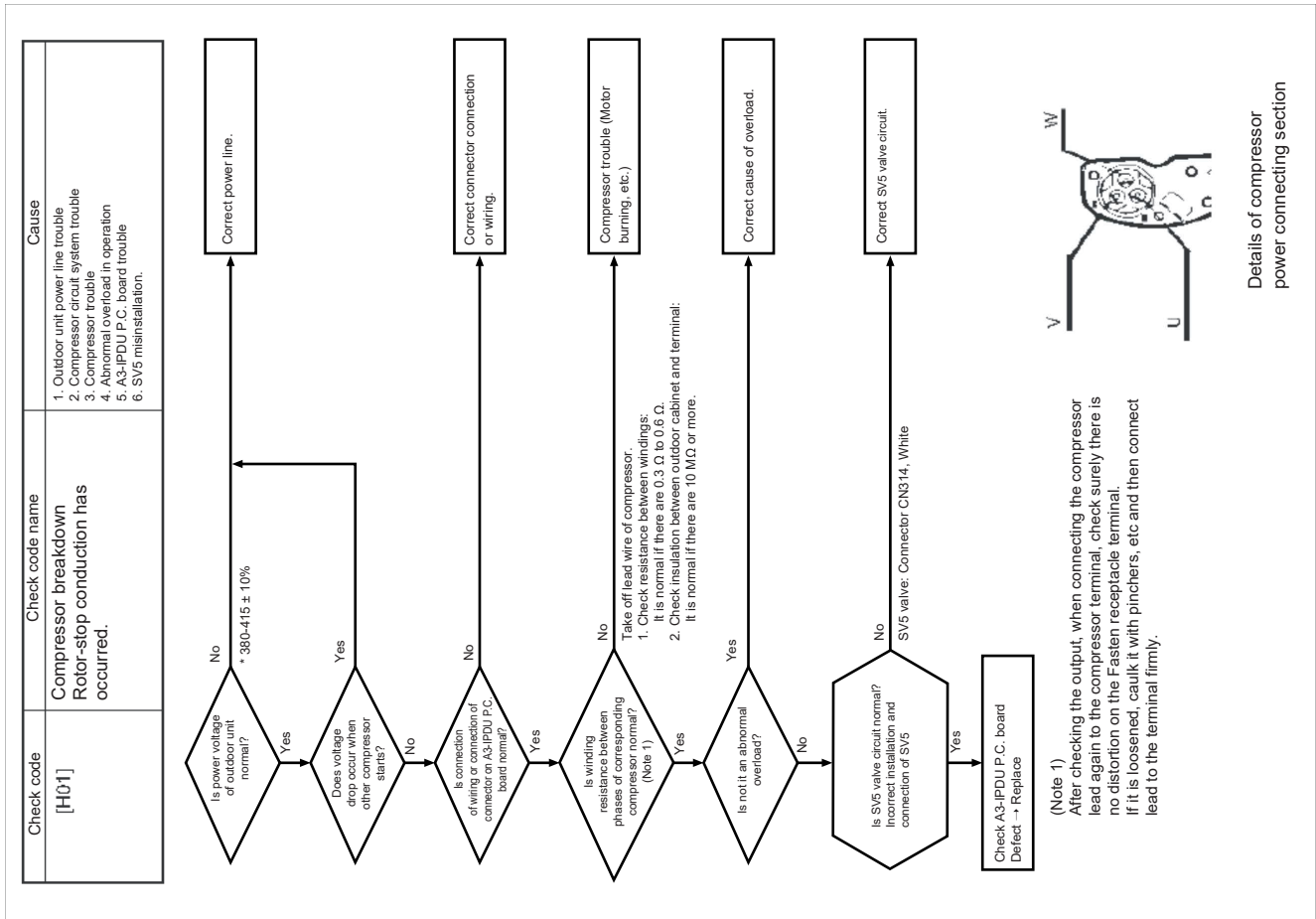
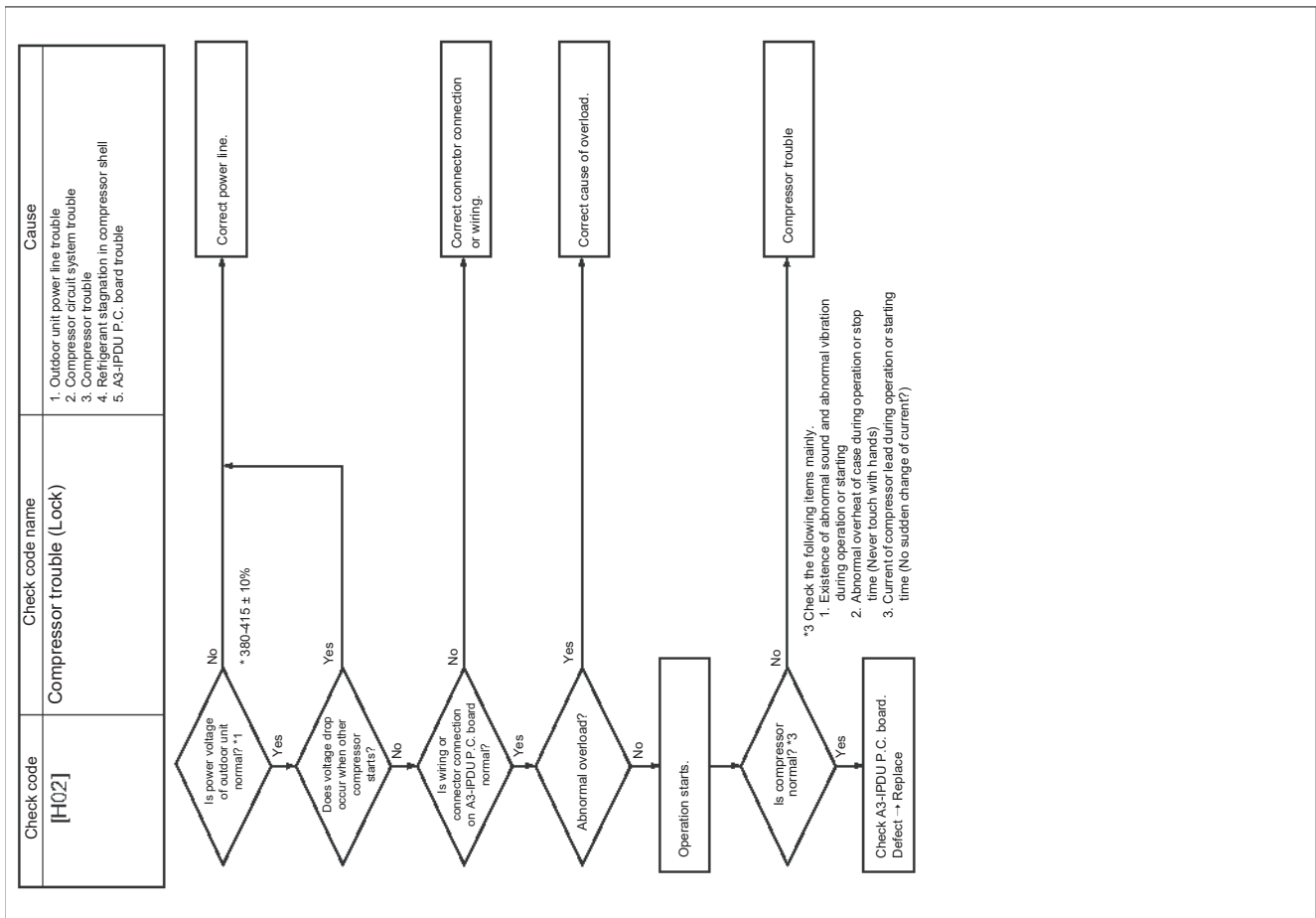

Details of compressor power connecting section

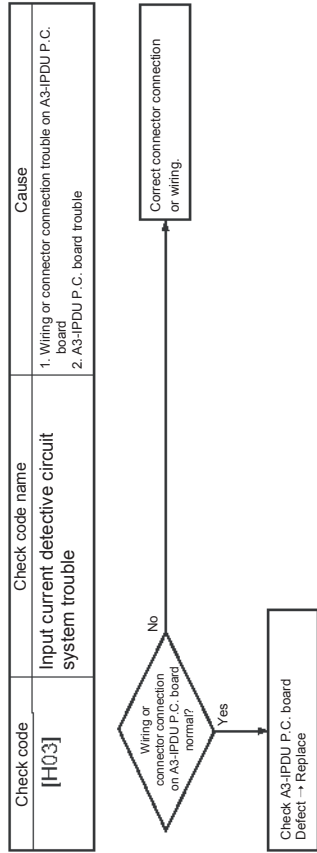
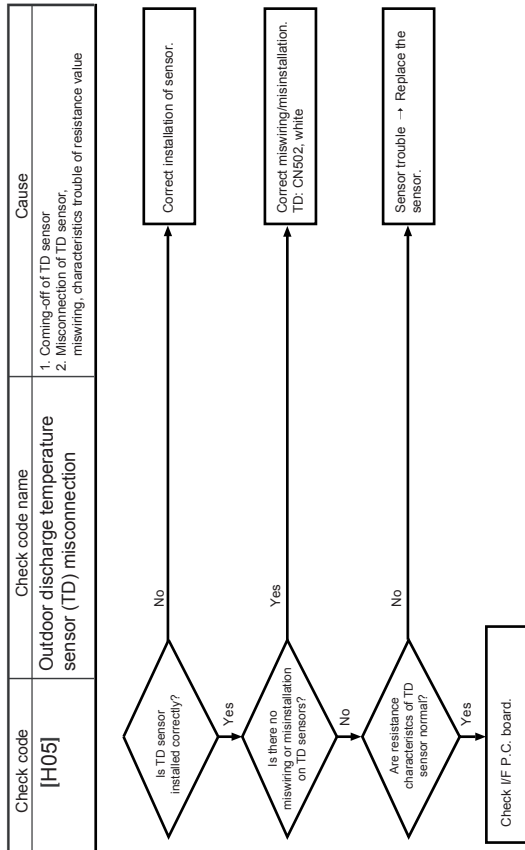

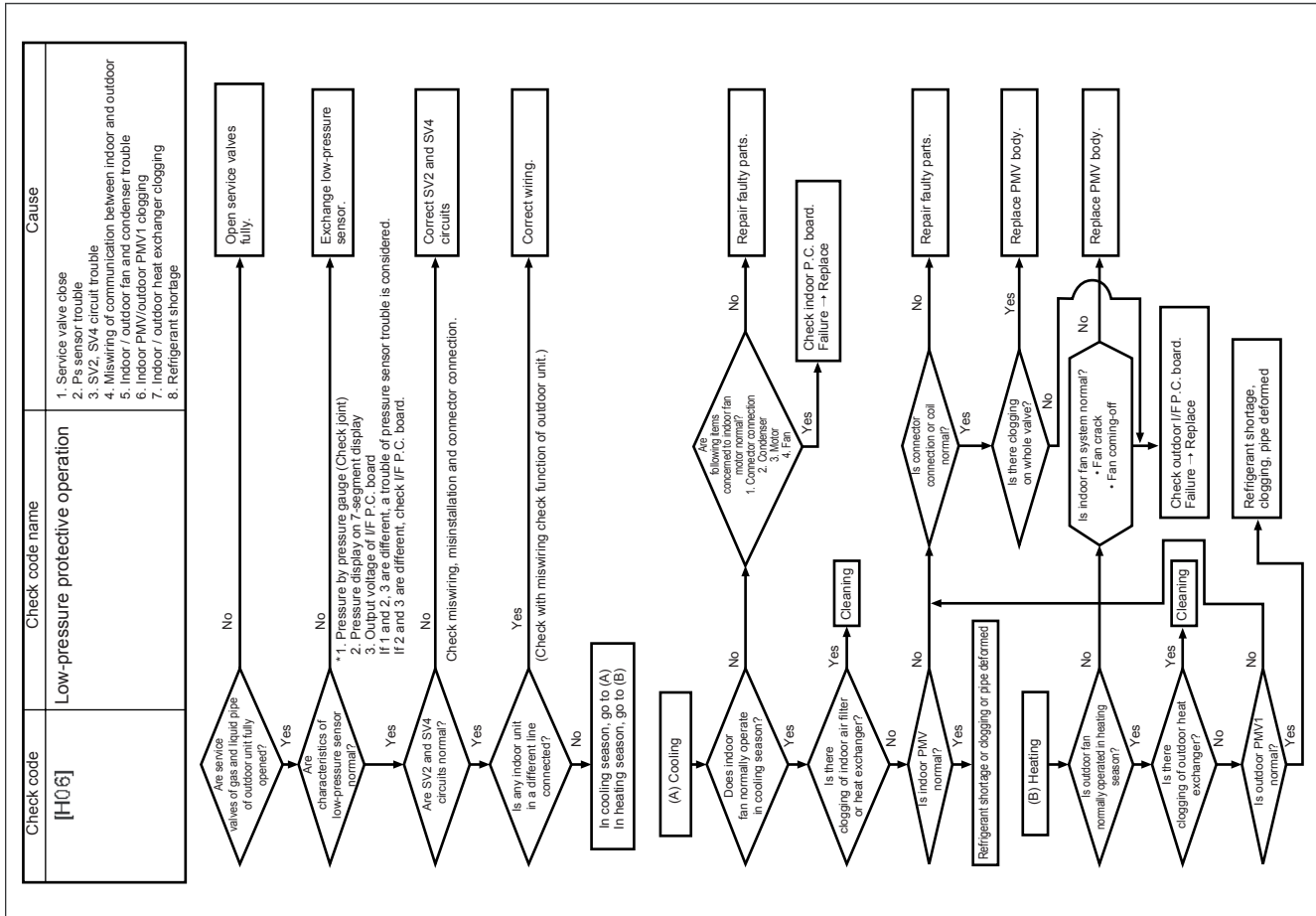
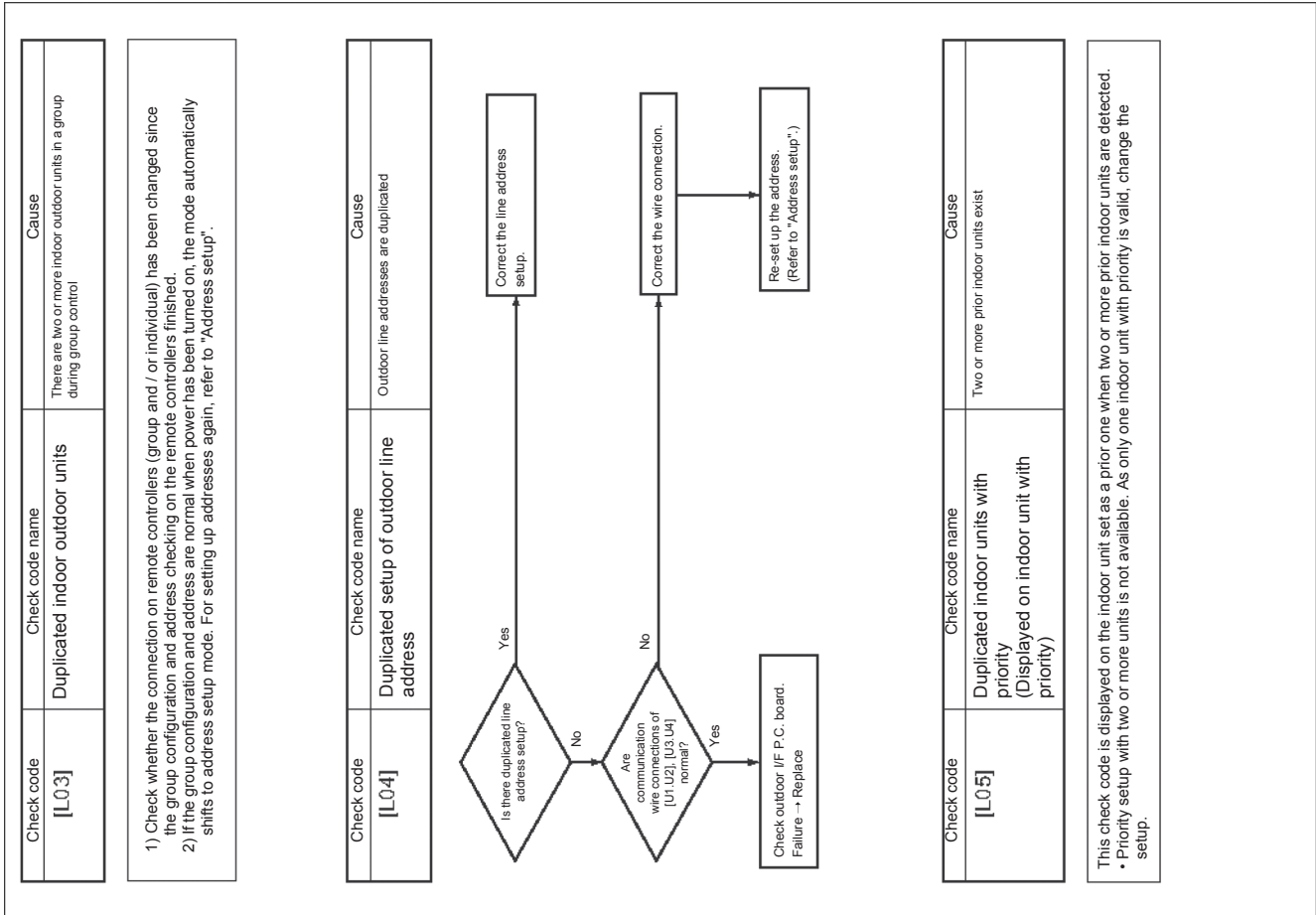

Check code	Check code name	Cause
[H07]	Oil level down detection protection	1. Miswiring or misinstallation of TK sensor. 2. TK sensor trouble 3. Gas leak or oil leak 4. SV3 valve trouble 5. Clogging of oil level detection circuit

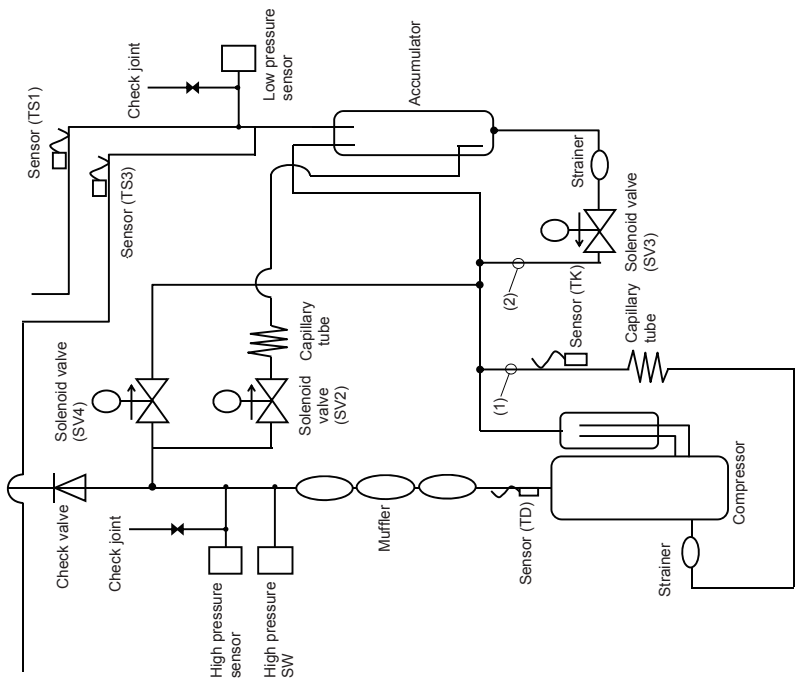
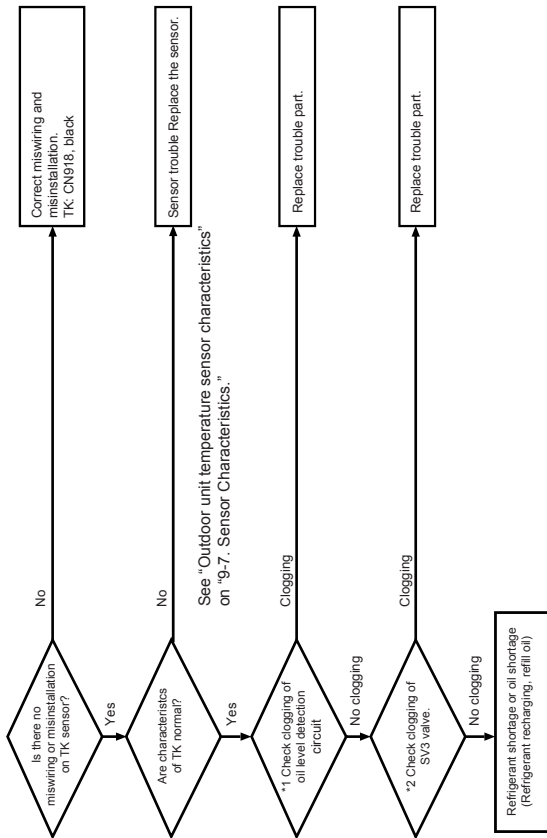

In some cases, it may be difficult to check the leakage of clogging in the following condition of refrigerant stagnation in low ambient temperature condition.
 In this case, take a longer operating time prior to check.
 (Criterion: Discharge temperature of TD is 60°C or higher)

(*1) Clogging check for oil level detection circuit
 • Operate the outdoor unit.
 • After operating for 10 minutes or more, check the temperature of TK sensor and oil level detection circuit (1) in the figure has increased.
 (Criterion)

TK temperature=TD temperature - Approx. 10 to 30°C
 Oil level detection circuit capillary tubes should be higher sufficiently than outside air temperature and suction temperature.
 • If the temperature of TK sensor and oil level detection circuit is low, clogging of capillary or strainer is considered. Repair the defective parts.

(*2) Clogging check for SV3 valve
 • While outdoor unit is operated, set up SW01/02/03 = [2][1][3] (7-segment display [Hr] [.....]), and push SW04 for 2 seconds or more.
 • Set up SW02 = [5], and turn on SV3 valve. (7-segment display [Hr] [.3.1])
 • If the temperature of the downstream side of the valve (2) in the figure) does not change, clogging of valve. Replace the clogged part.

Check code	Check code name	Cause
[H08]	Oil level detection temperature sensor trouble	TK sensor Open/Short

This is an oil level detection temperature sensor trouble. Check disconnection of the wiring and resistance value of the sensor.
If the sensor is normal, replace the outdoor I/F P.C. board.

Circuit	Connector
TK	CN918 (Black)

Check code	Check code name	Cause
[H16]	Oil level detection circuit trouble	1. Coming-off of TK sensor, miswiring, characteristics trouble or resistance value 2. Oil level detection circuit trouble (capillary clogging, strainer clogging) 3. Refrigerant stagnation on the compressor case

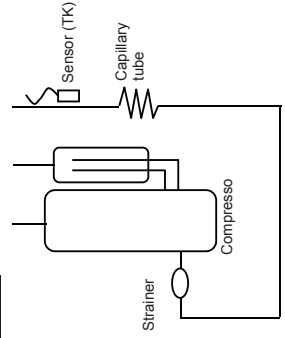
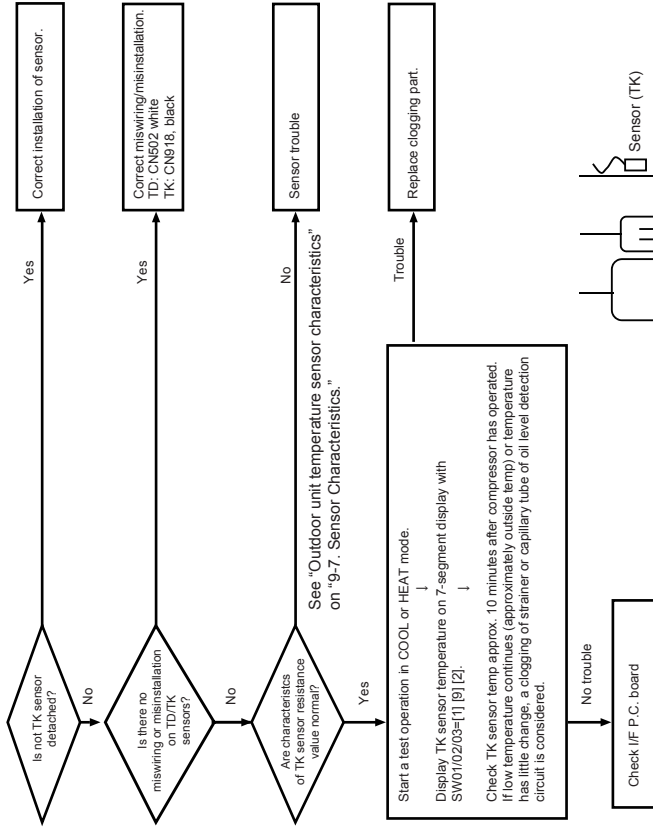

Check code	Check code name	Cause
[L08]	Indoor group / address unset	Indoor unit address is unset

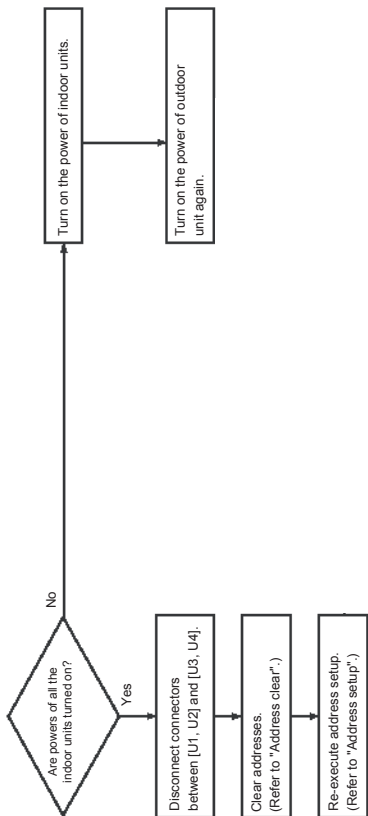

(Note) This code is displayed when the power is turned on at the first time after installation. (Because the address is not yet set up)

Check code	Check code name	Cause
[L09]	Indoor capacity unset	Indoor units capacity is unset



Check code	Check code name	Cause
[L10]	Outdoor capacity unset	On the outdoor IF P.C. board for service, the model selecting jumper has not been set up so as to match with the model

I/F P.C. board Assy service for the outdoor unit is common to this series. A setup for model selection different from that for P.C. board with trouble is necessary. Set up a model based upon the P.C. board Assy exchange procedure.

Check code	Check code name	Cause
[L06]	Duplicated indoor units with priority (Displayed on the indoor units other than ones with priority and on the outdoor unit)	Two or more indoor units with priority are duplicated

Sub-code: amount of indoor units with priority

When priority is given to two or more indoor units, this check code is displayed on indoor units other than the units set as prior ones and the outdoor unit.
 • As only one indoor unit with priority is valid, change the setup.

Check code	Check code name	Cause
[L07]	A group line exists in an individual indoor unit	A group line is connected to an individual indoor unit

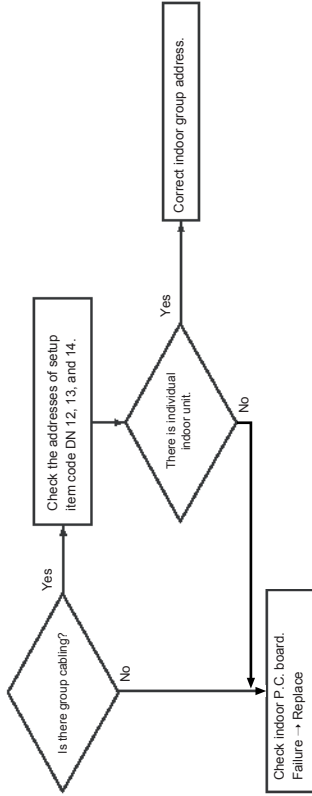

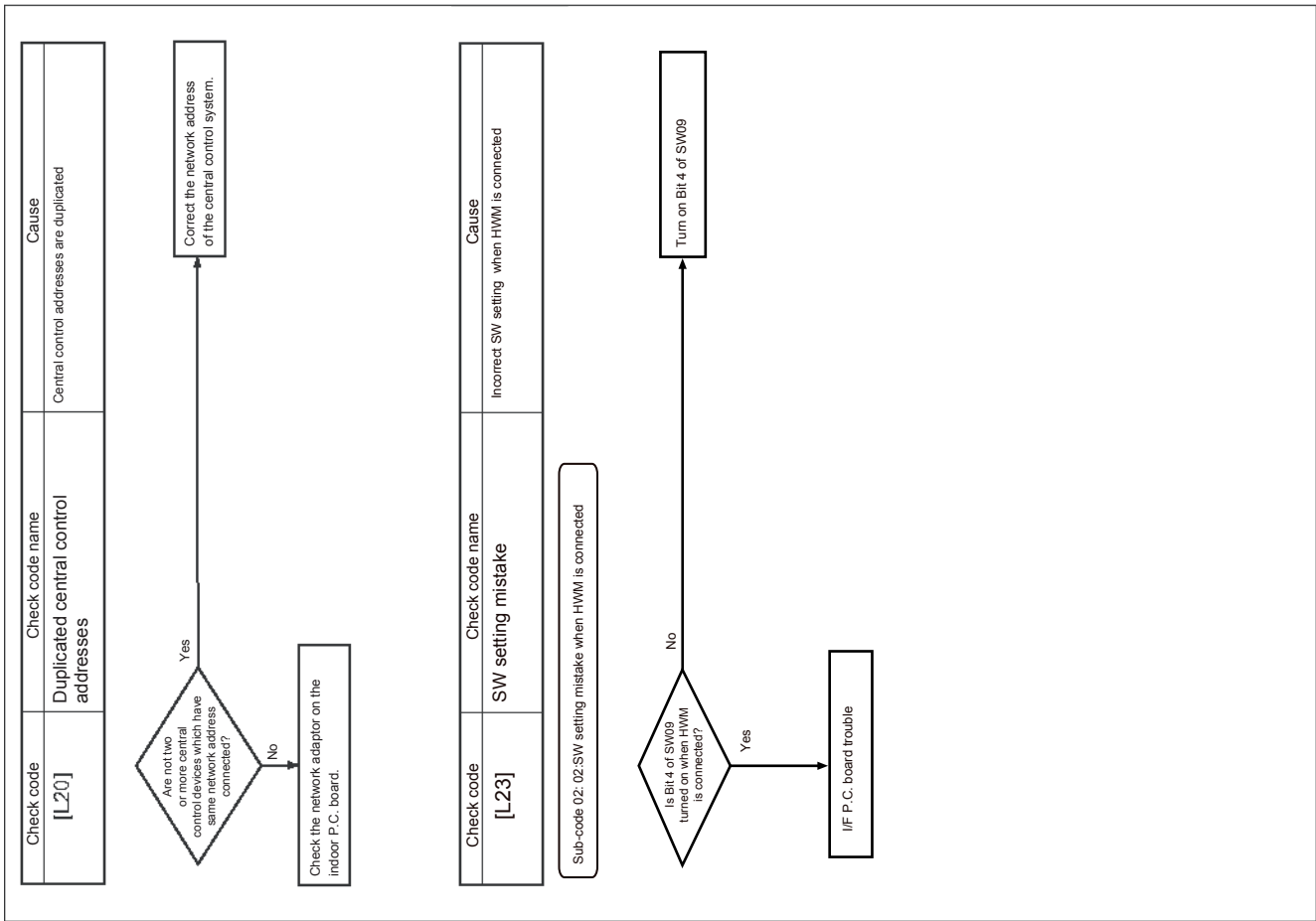
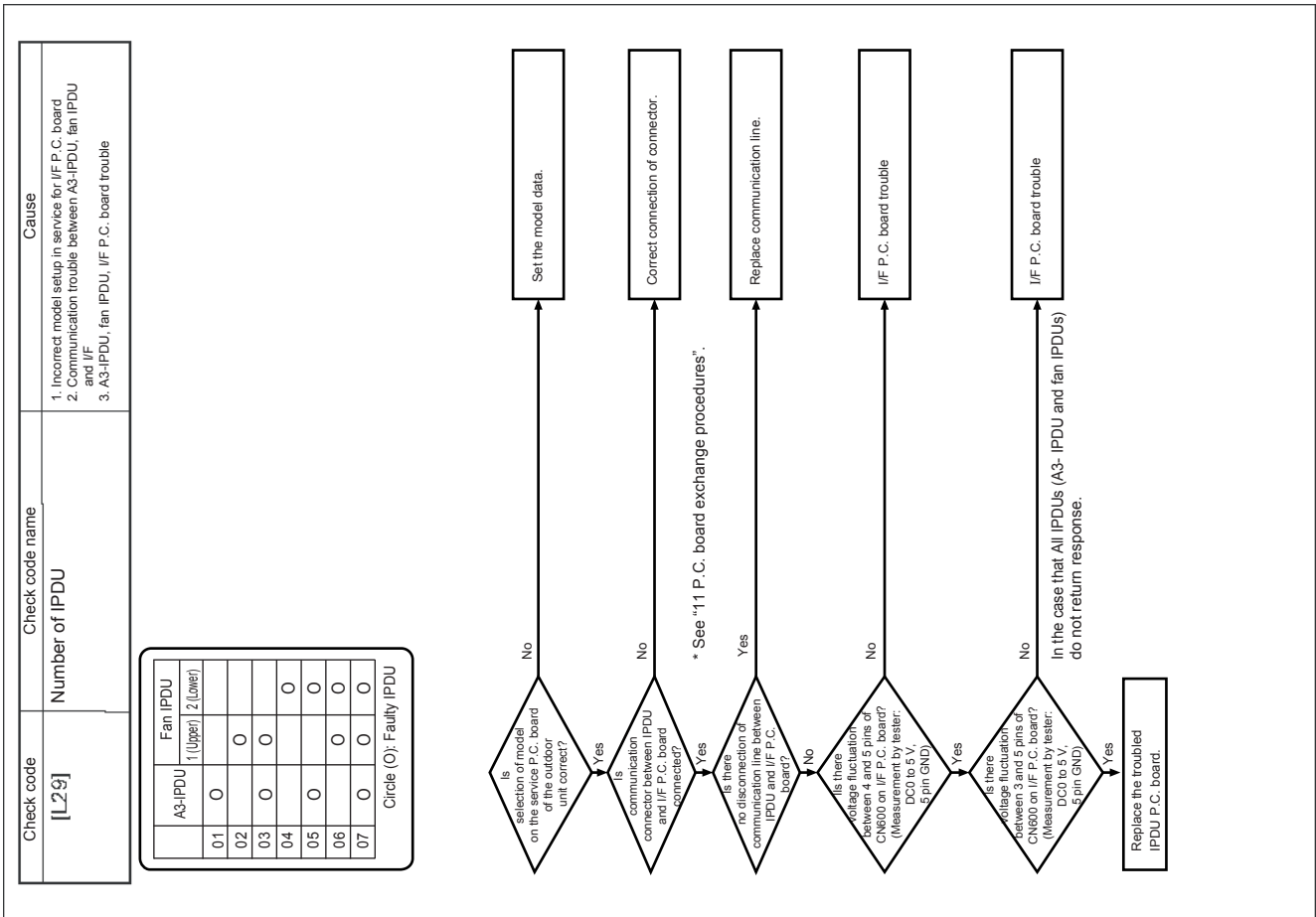

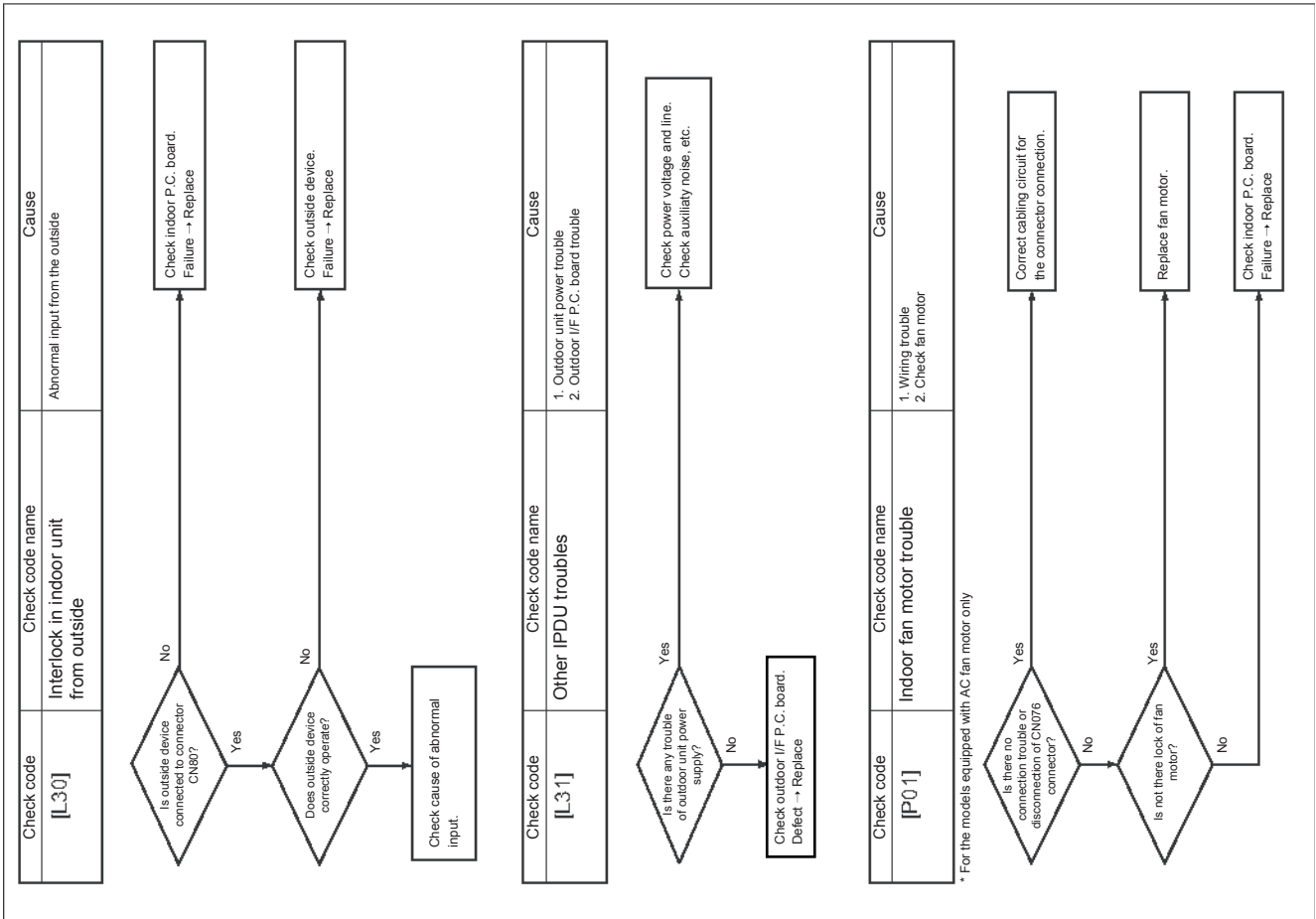
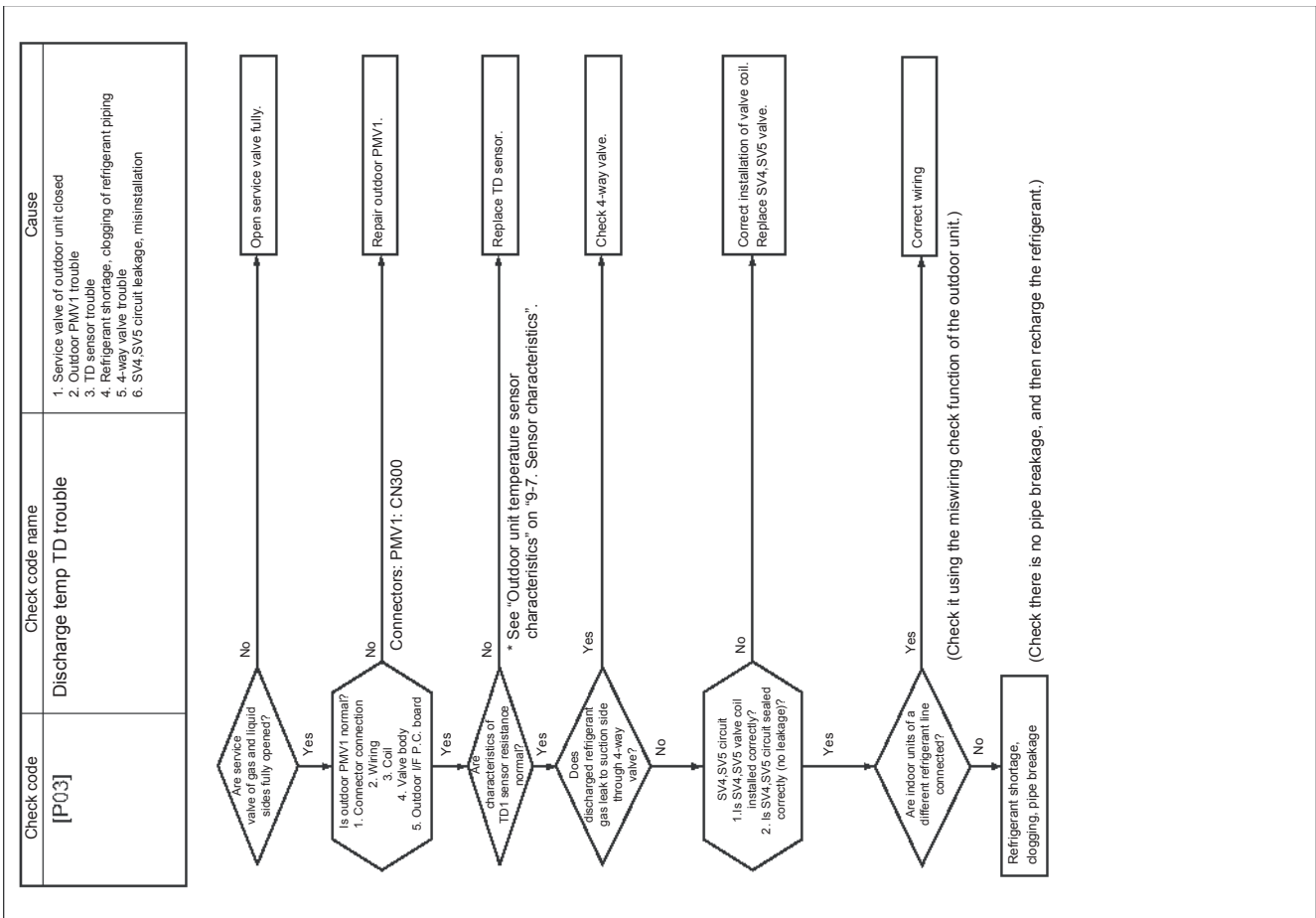

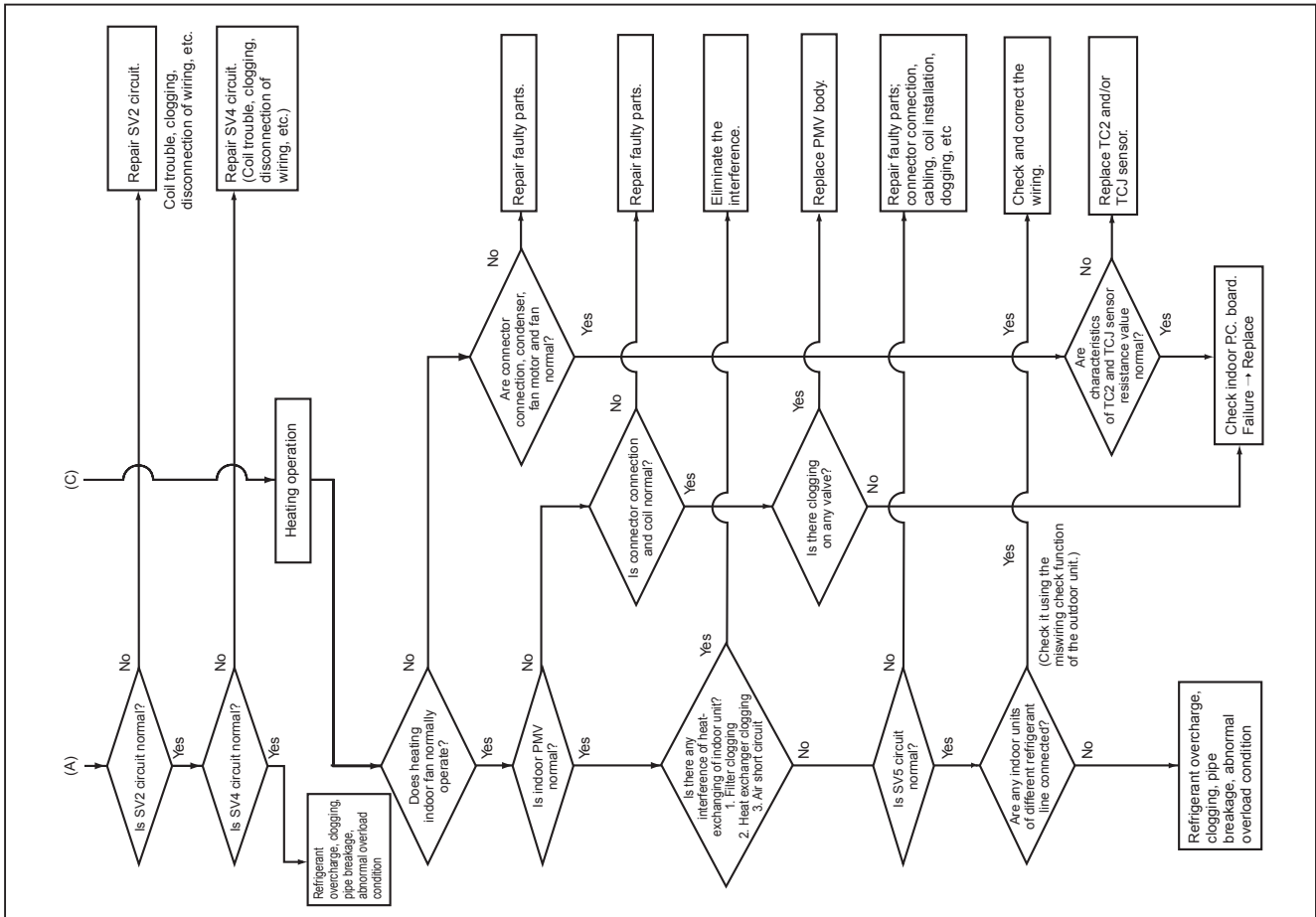
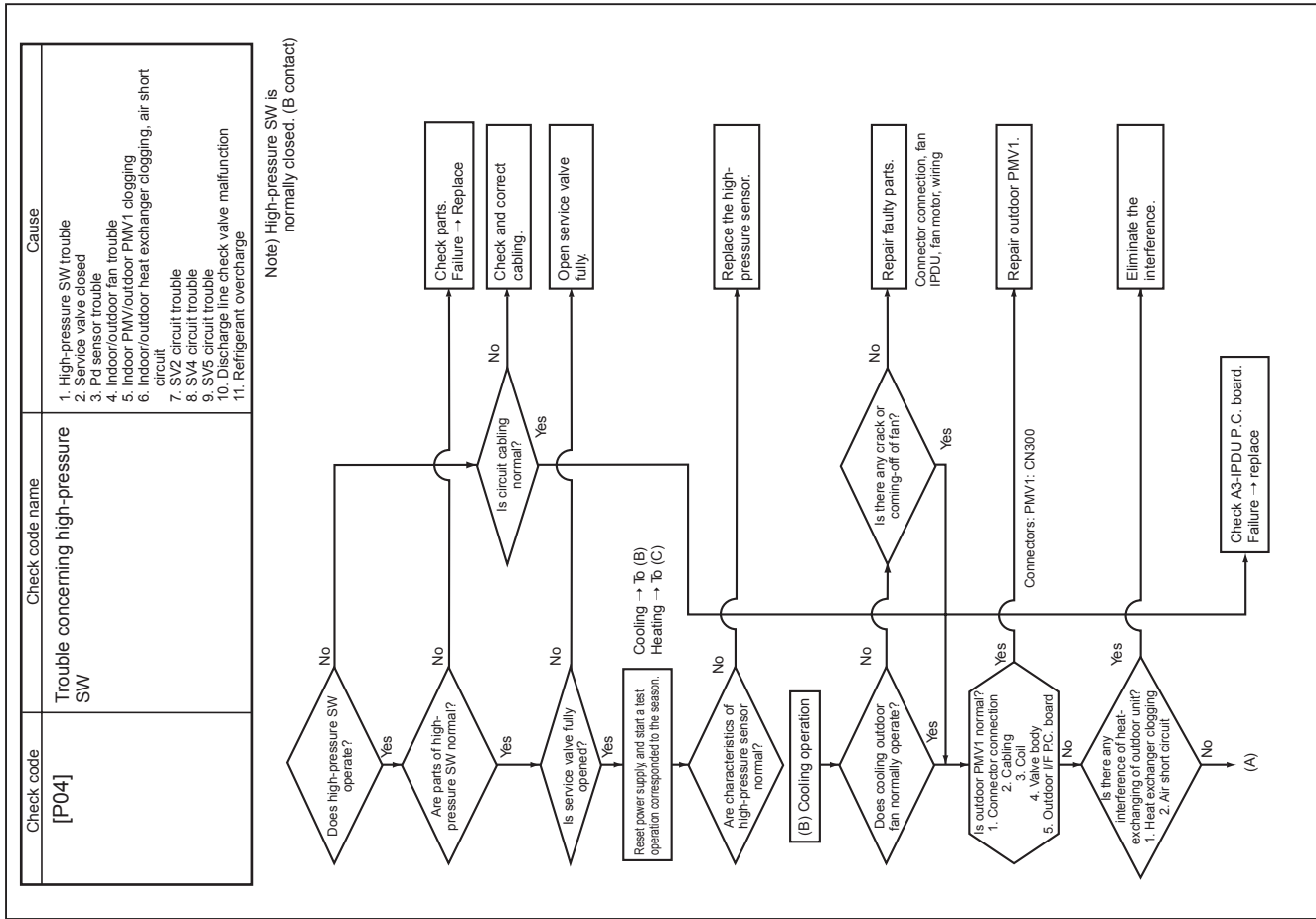

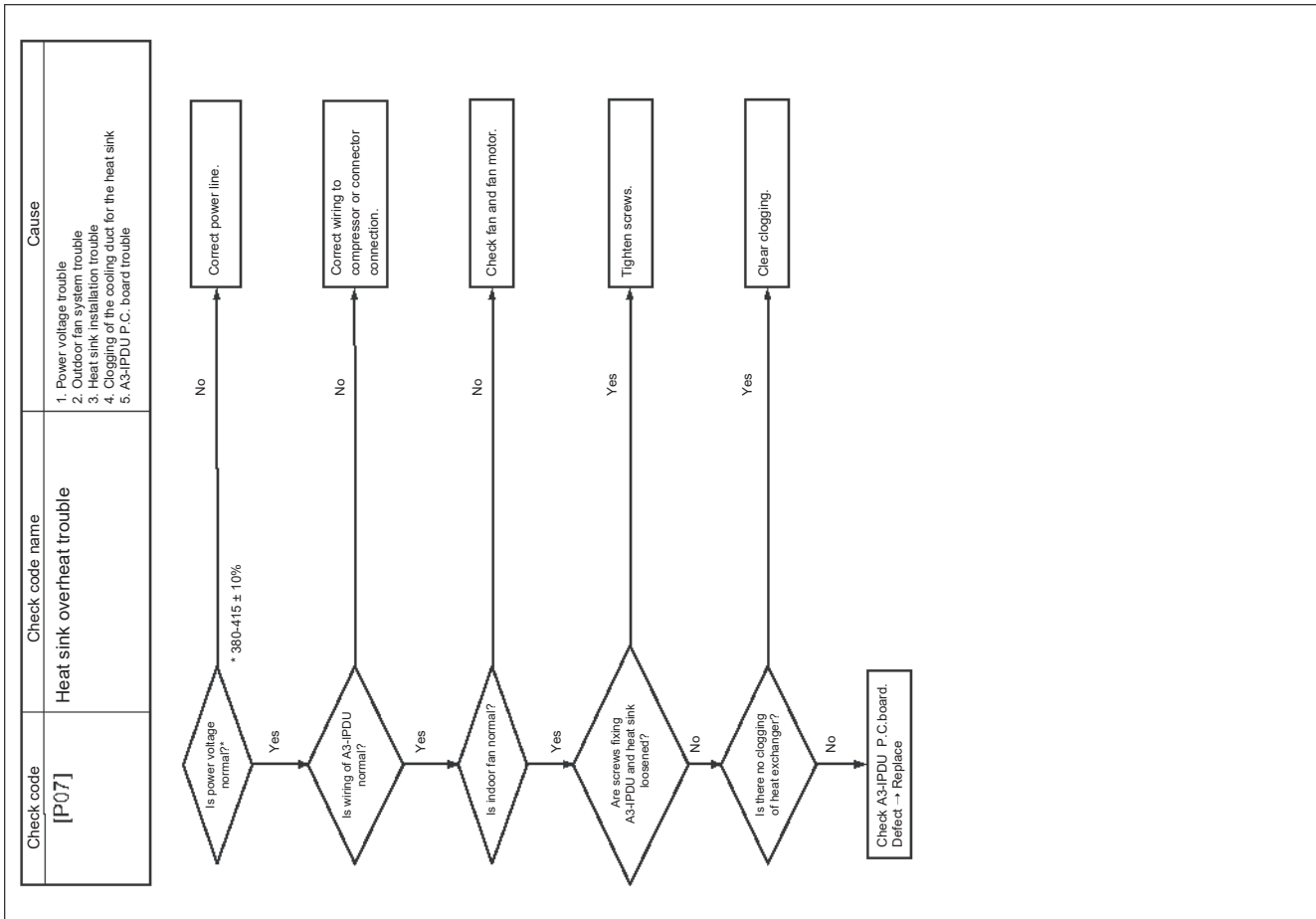

Check code	Check code name	Cause
[P05]	Phase trouble detected, power failure detected, abnormal inverter DC voltage (on compressor and outdoor fan motor)	Phase trouble or power failure of the power supply to the outdoor unit

Sub-code: 00: Phase trouble / power failure is detected.
 *E: Abnormal inverter DC voltage on outdoor fan motor.
 (*: Fan motor number)
 -: Abnormal inverter DC voltage on compressor.

- Check the phase of the power line to the outdoor unit.
- Check trouble of outdoor I/F C. board.
- Check there are no loosened connectors, etc.
- Check for defect in wiring connection of CN400 and CN530 on interface P.C. board.

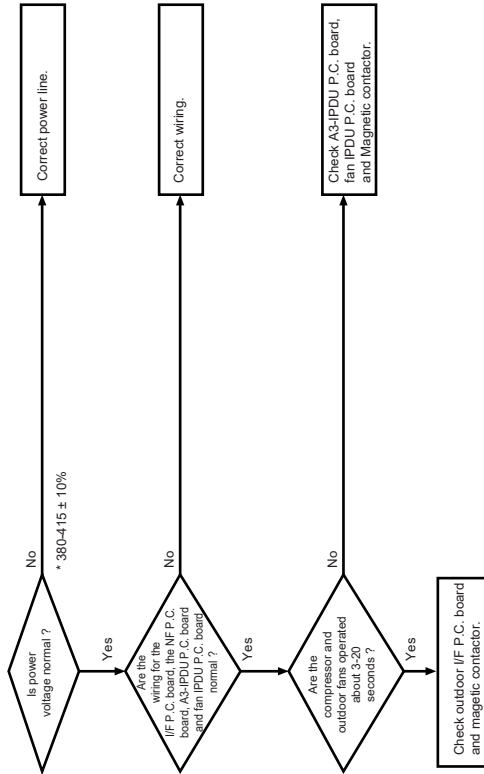

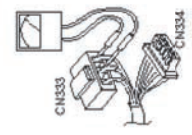
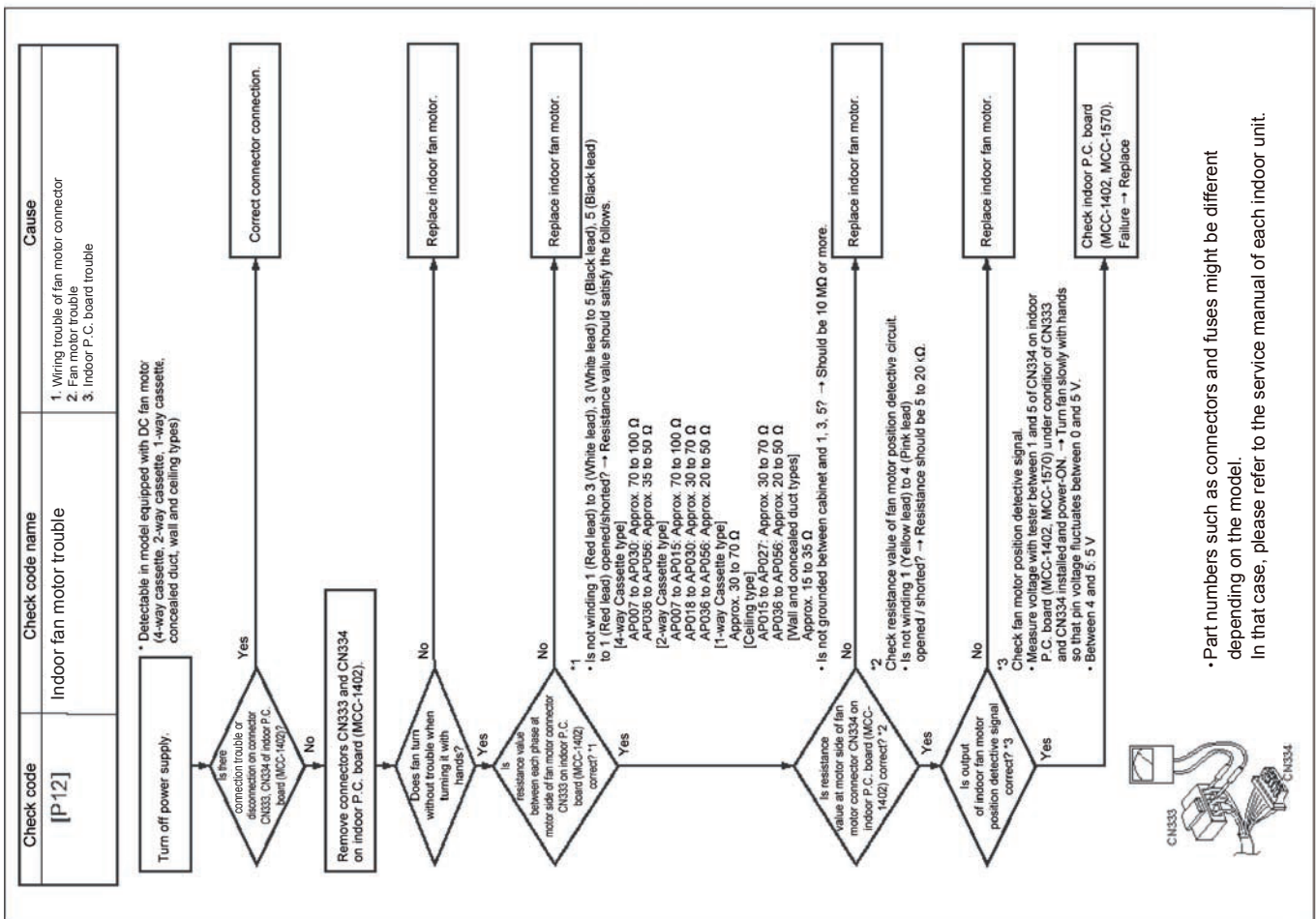

• Part numbers such as connectors and fuses might be different depending on the model. In that case, please refer to the service manual of each indoor unit.

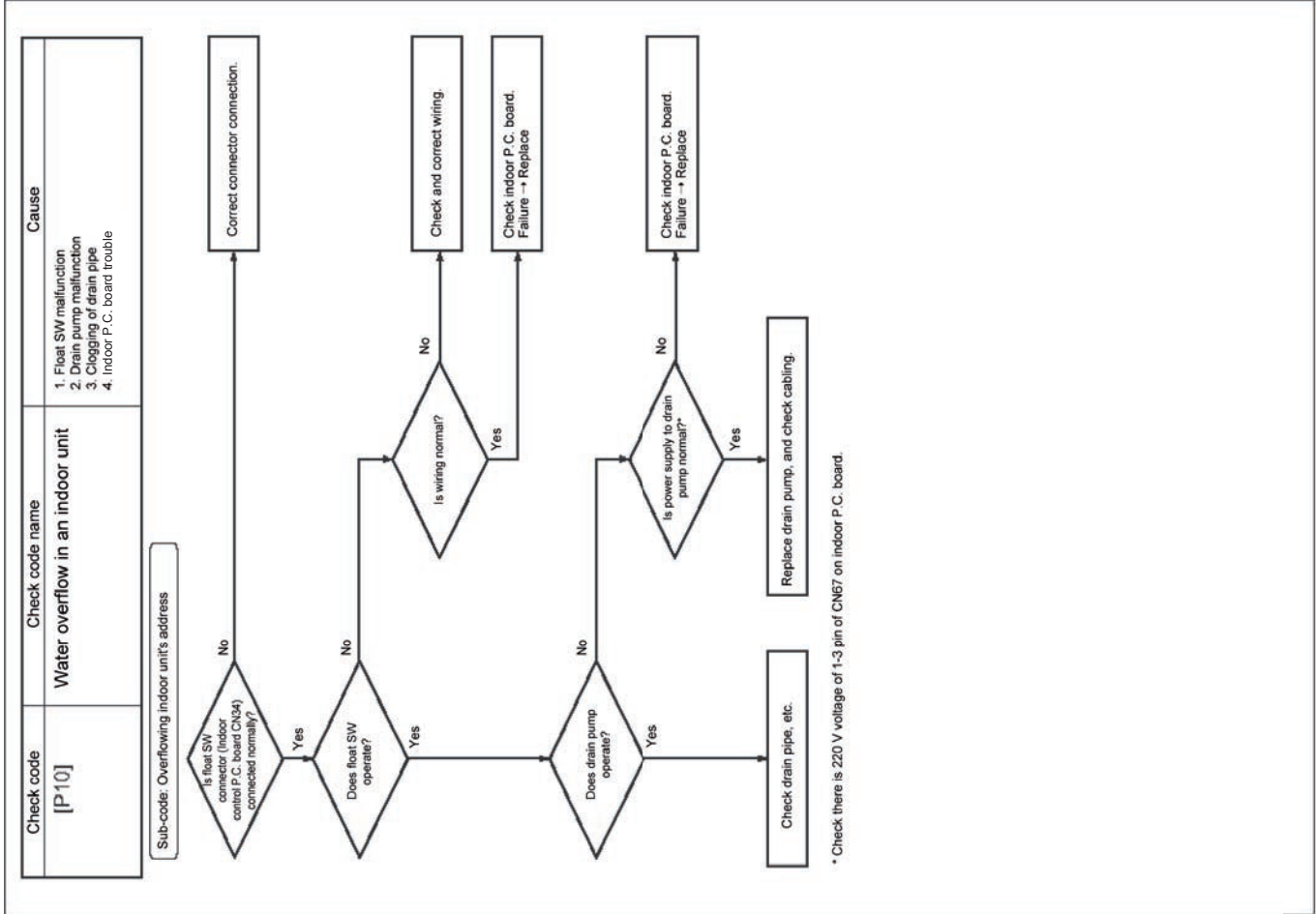

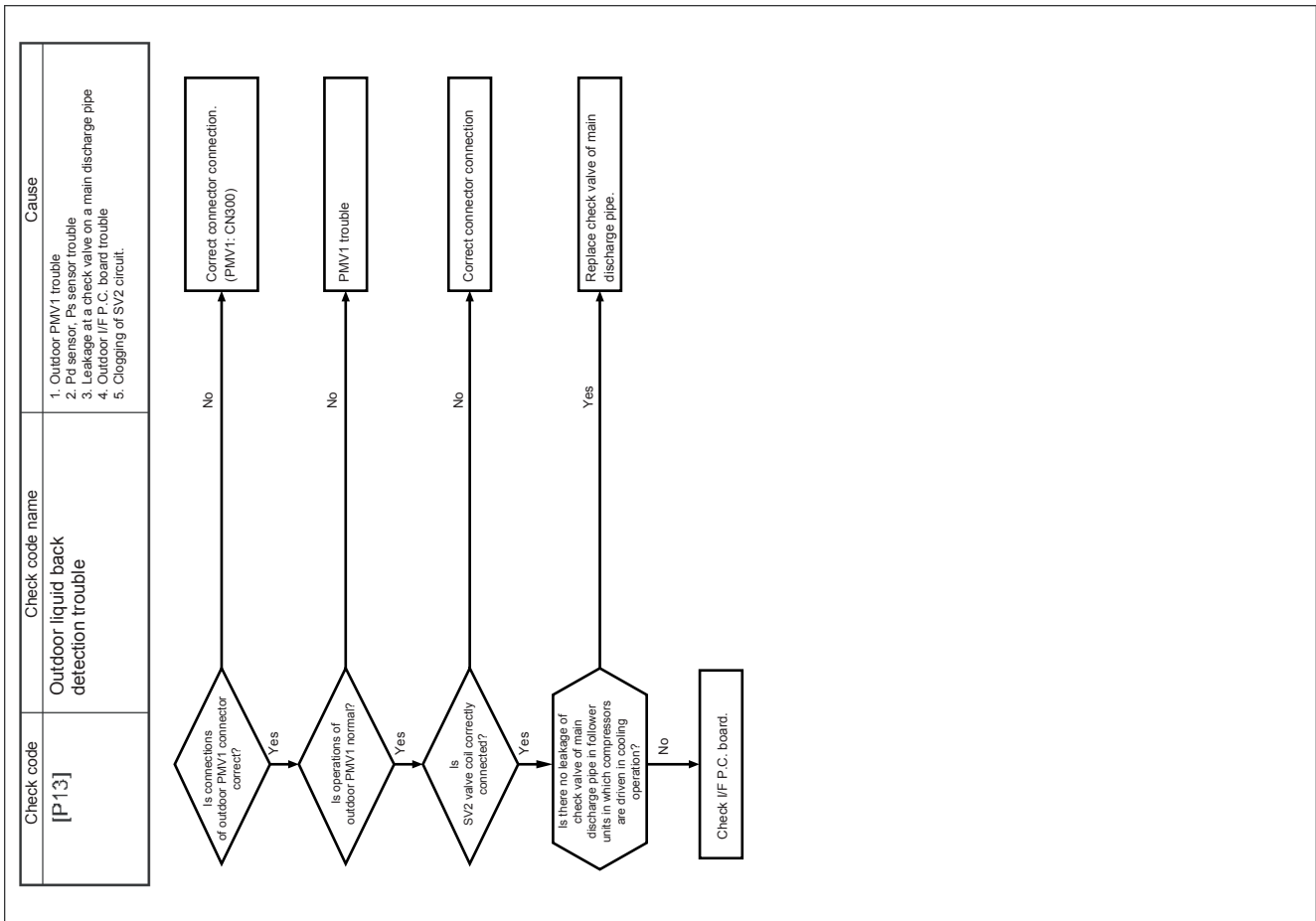
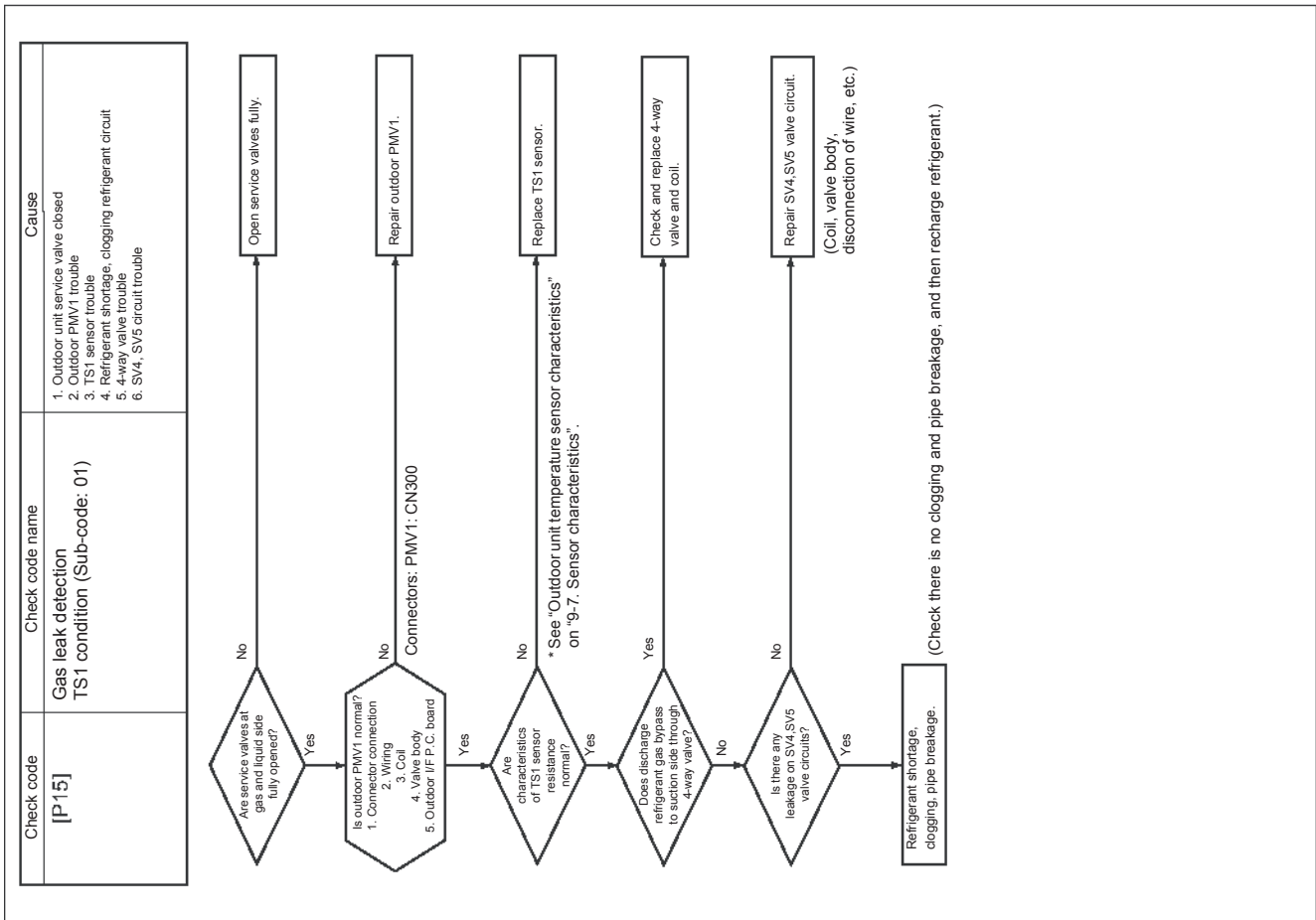

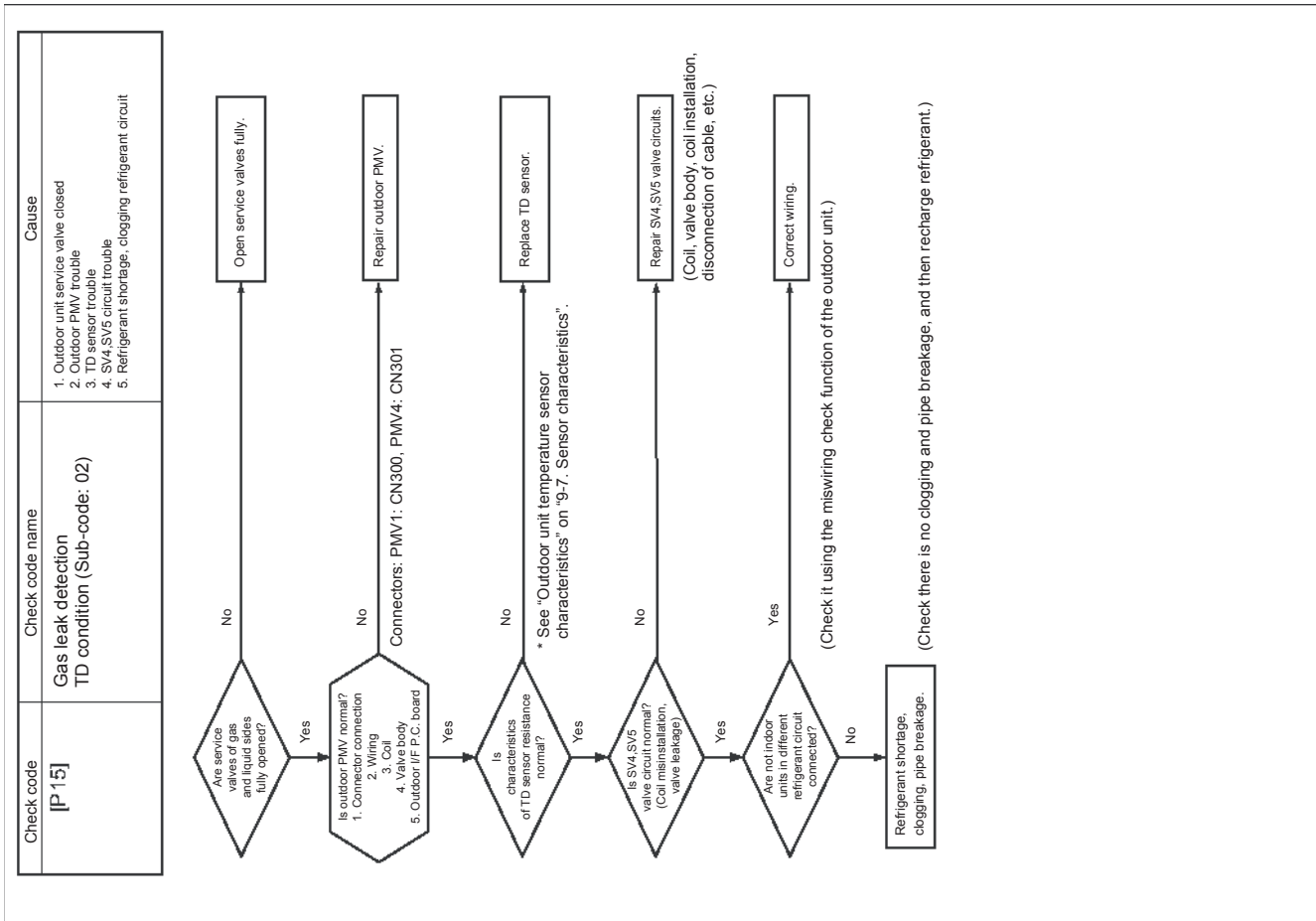
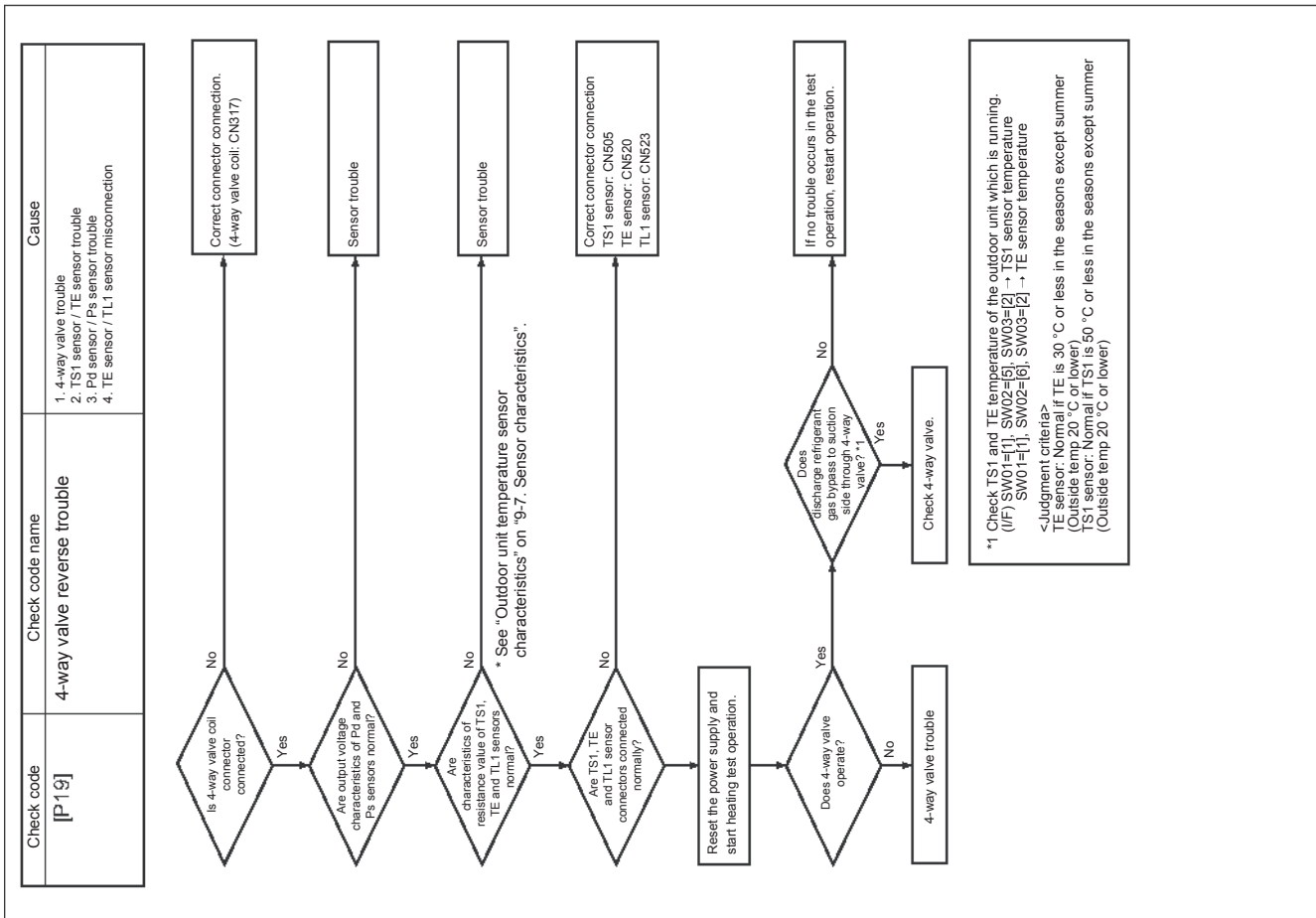

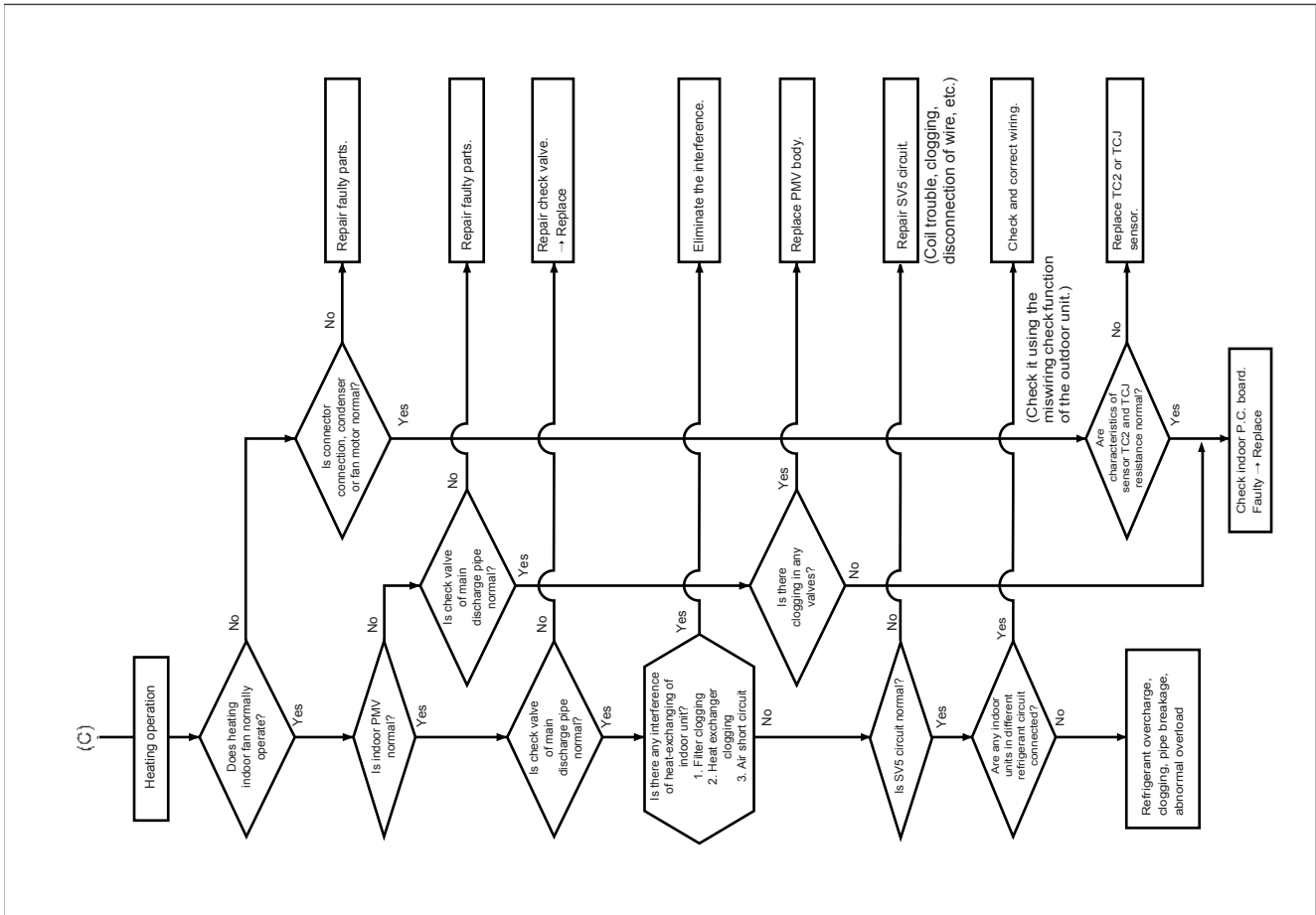
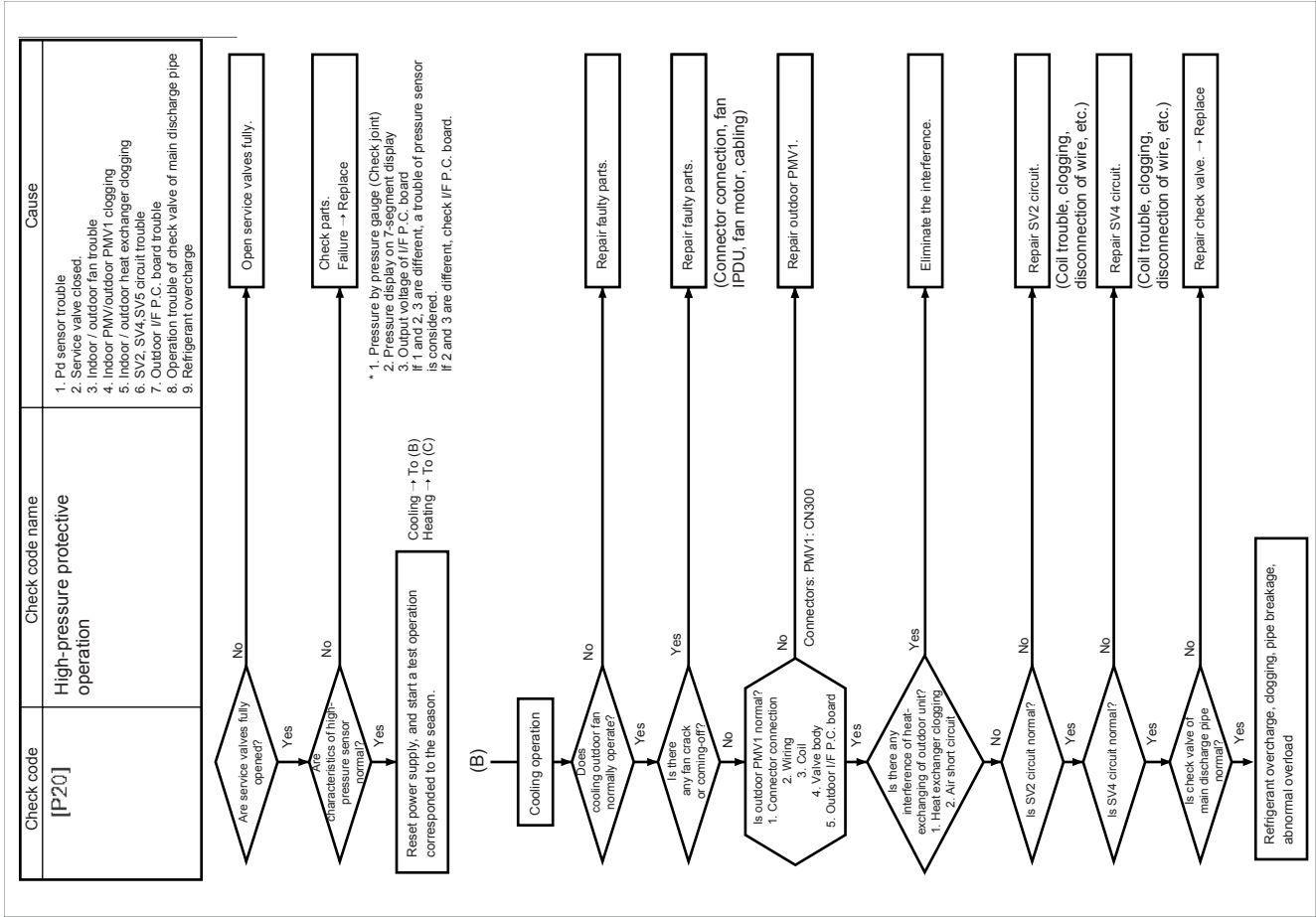

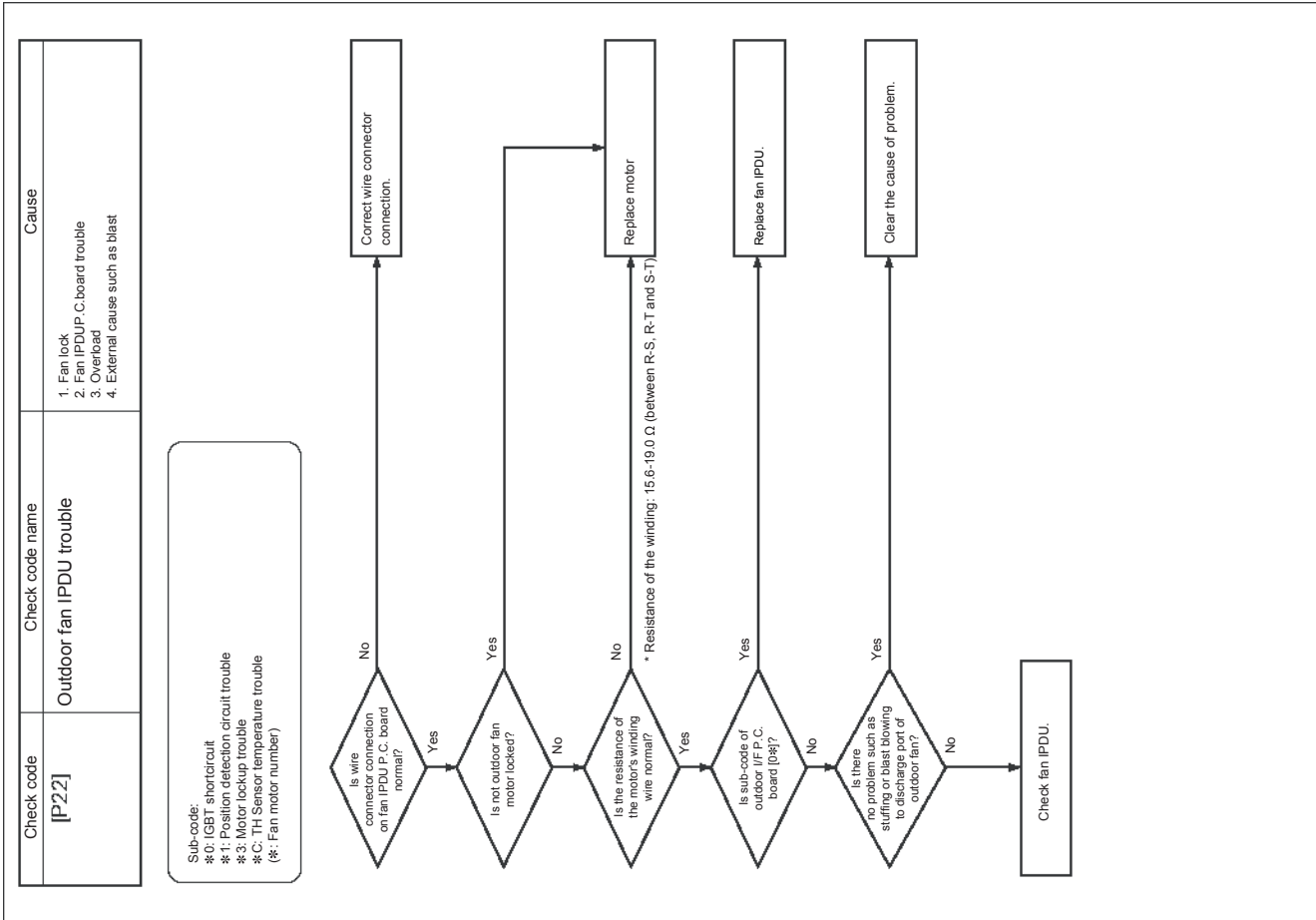
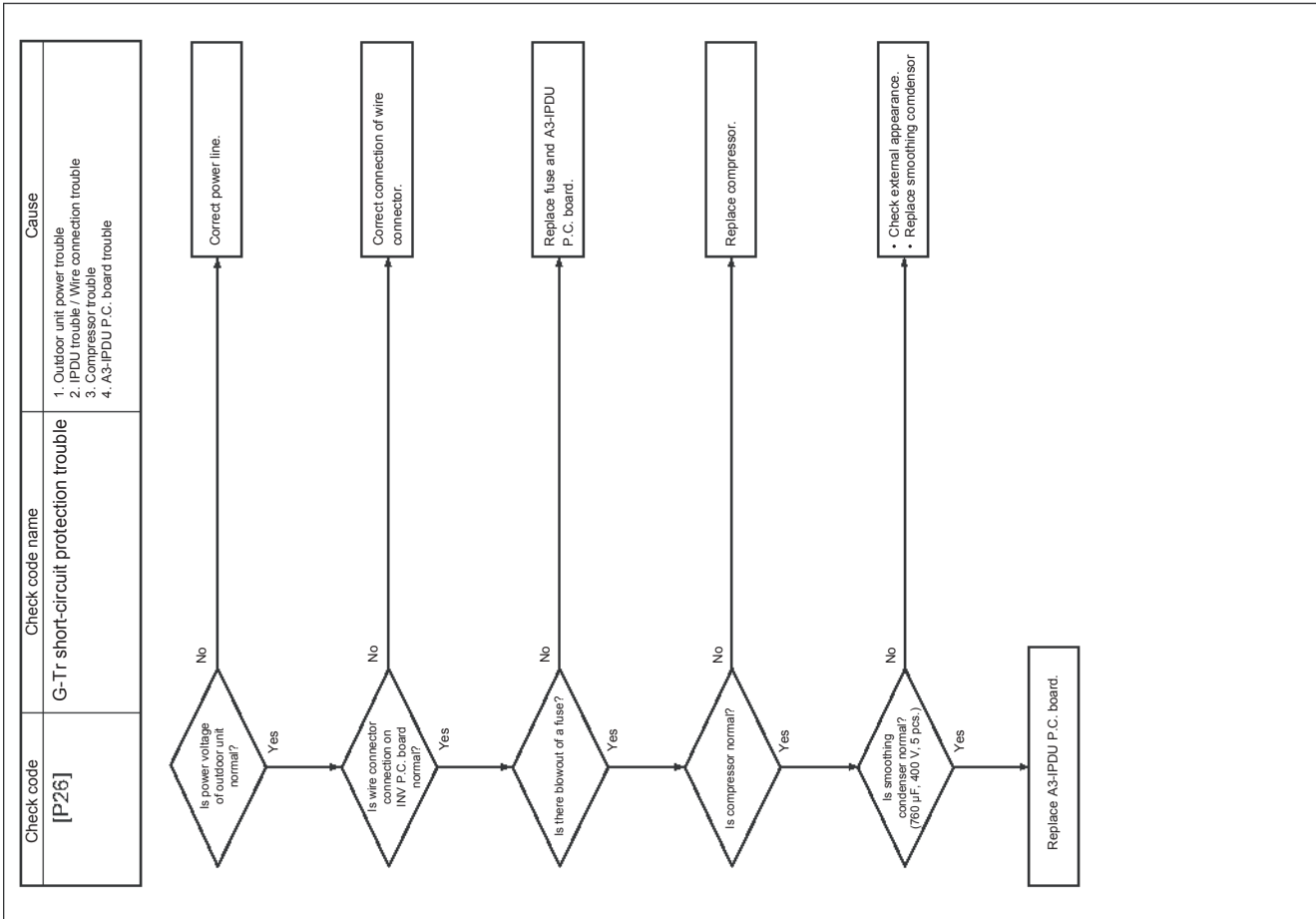

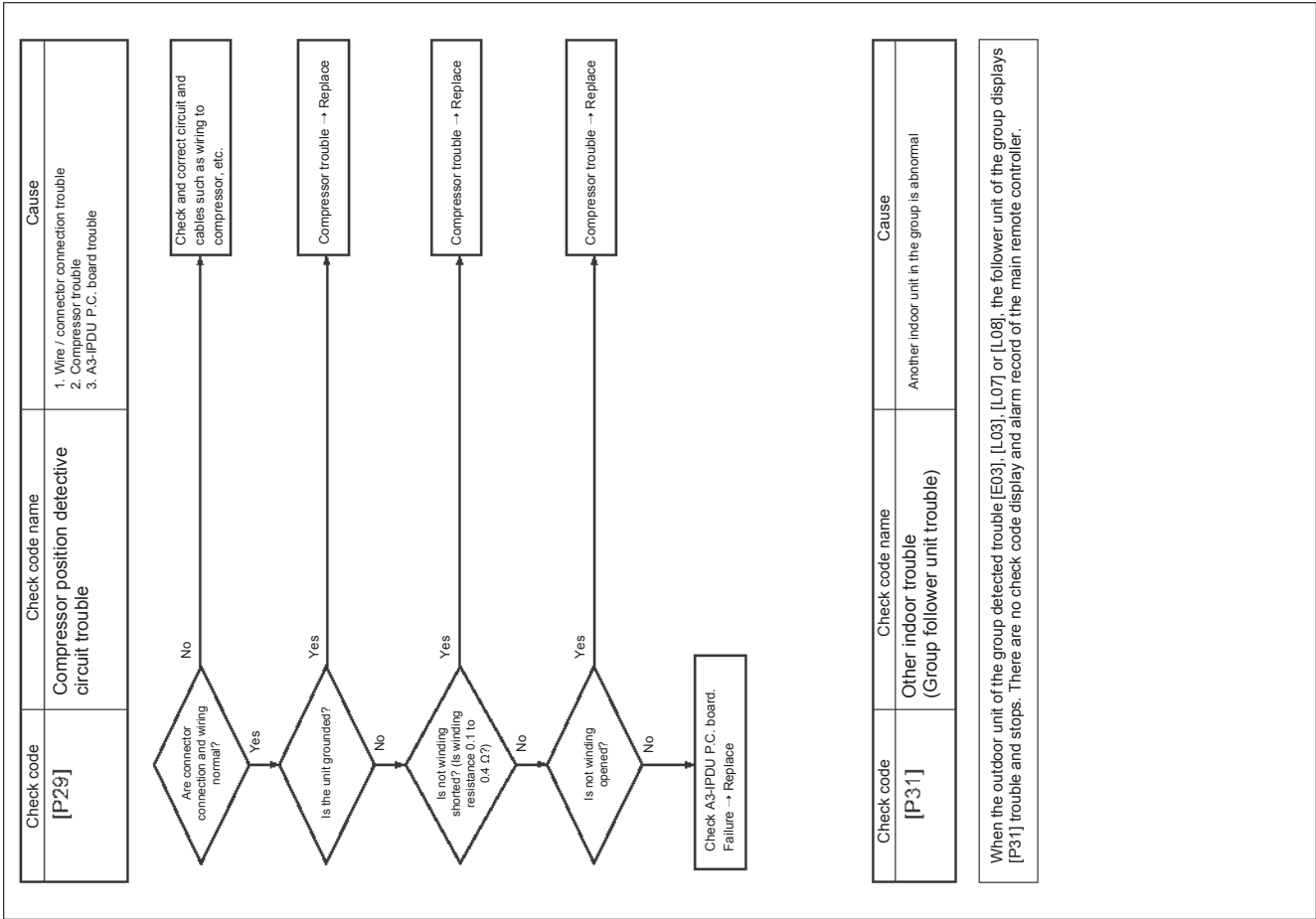

9-6. 7-segment display function

7-segment display on outdoor unit (interface P.C. board)

The interface control P.C. board features a 7-segment LED display designed to check operational status. Display items can be changed by changing the combination of the number settings of rotary switches provided on the P.C. board (SW01, SW02 and SW03).

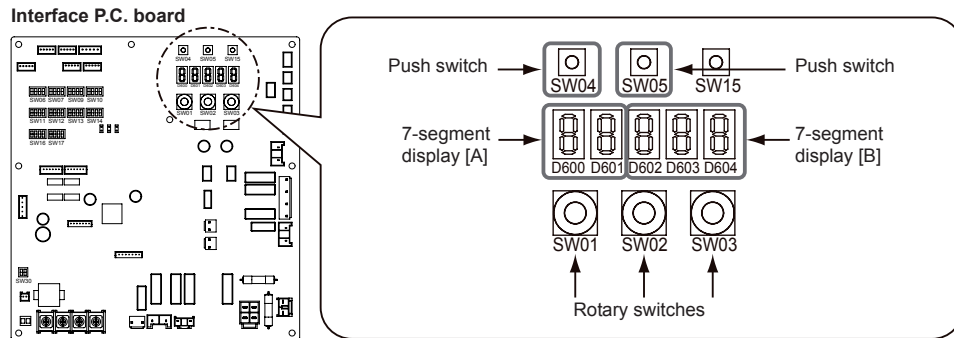

Checking procedure to be followed in event of abnormal shutdown

If the system is shut down due to a trouble in the outdoor unit, perform checks in the following steps:

1 Open the panel of the outdoor unit, and check the 7-segment display.

The check code is displayed in the right-hand section of the 7-segment display [B].

[U1] [000] ([000]: Check code)

* To check the check code, set the rotary switches SW01 / SW02 / SW03 to [1/1/1].

If there is a sub-code, the display alternates between the check code [000] (3 seconds) and the sub-code [000] (1 second).

2 Check the check code and follow the applicable diagnostic procedure.

3 Perform checks in accordance with the diagnostic procedure applicable to the check code.

(1) Display of system information (displayed on outdoor unit)

SW01	SW02	SW03	Display detail				
1	1	3	Refrigerant name	Display refrigerant name		A	B
				Refrigerant R410A		r4	10A
	2		System capacity	A	[8]~[10]: 8 to 10 HP		
				B	[HP]		
	3		Total capacity of indoor units	A	[i. **. **]		
				B			
	4		No. of indoor units connected / No. of units with cooling thermostat ON	A	[...0.]~[16.]:0 to 16 (No. of units connected)		
				B	[C...0]~[C16]:0 to 16 (No. of units with cooling thermostat ON)		
	5		No. of indoor units connected / No. of units with heating thermostat ON	A	[...0.]~[16.]:0 to 16 (No. of units connected)		
				B	[H...0]~[H16]:0 to 16 (No. of units with heating thermostat ON)		
	6		Amount of compressor command correction	A	Value displayed in hexadecimal format		
				B			
	7		Release control	A	Normal: [r. ...], During release control: [r.1]		
				B	[P. **]		
	8		-	A	-		
				B	-		
	9		-	A	-		
				B	-		
	10		Refrigerant / oil recovery operation	A	Oil recovery in cooling: [C1], Normal: [C ...]		
				B	Refrigerant recovery in heating: [H1], Normal: [H ...]		
	11		Automatic addressing	A	[Ad]		
				B	During automatic addressing: [... FF], Normal: [... .. .]		
	12		Power pick-cut	A	[dU]		
				B	Normal: [... .. .], During 50-90 % capacity operation: [_50-_90] While control is based on BUS line input: [E50-E90]		
	13		Optional control (P.C. board input)	Displays optional control status		A	B
				Operation mode selection: During priority heating (normal)		-. *	*.*.*.
				Priority cooling		c.*.	*.*.*.
				Heating only		H.*.	*.*.*.
Cooling only		C.*.		*.*.*.			
Priority given to quantity of indoor units in operation		n.*.		*.*.*.			
Priority given to specific indoor unit		U.*.		*.*.*.			
External master ON / OFF: Normal		*....		*.*.*.			
Start input		*.1.		*.*.*.			
Stop input		*.0.		*.*.*.			
Night operation: Normal		*.*.		...*.*.			
Start input		*.*.		1.*.*.			
Snowfall operation: Normal		*.*.		*....*.			
Start input		*.*.	*.1.*.				
14	Optional control (BUS line input)	Same as above					
15	Unused						
16	-	A	-				
		B	-				
15	No. of initial HWM connected	A	[ho.]				
		B	[...0.]~[4.]: 0 to 4 (No. of units connected)				

(2) Display of outdoor unit information (displayed on outdoor unit)

SW01	SW02	SW03	Display detail				
1	1	1	Check code data	A	Outdoor unit No.: [U1]		
				B	Check code (only latest one displayed) If there is no check code, [---] is displayed. If there is sub-code, check code [* * *] and sub-code [- * *] are displayed alternately, for 3 seconds and 1 second, respectively.		
	2		-	A	-		
				B	-		
	3		Operation mode	A	Stop [... ..] Normal cooling: [... C], Normal heating: [... H], Normal defrosting: [... J]		
				B	-		
	4		Outdoor unit HP capacity	A	[8]-[10]: 8 to 10 HP		
				B	[...HP]		
	5		Compressor operation command	* Operation data of compressor is displayed. Data display with hexadecimal notation.			
	6		Outdoor fan mode	A	[FP]		
				B	Mode 0 to 31: [... 0] to [31]		
	7		-	A	-		
				B	-		
	8		-	A	-		
				B	-		
	9		4-way valve output data	Displays control output status of solenoid valve		A	B
4-way valve: ON		H. 1				
4-way valve: OFF		H. 0				
10	SV2 and SV5 valve output data	SV2: ON / SV5: OFF		2.1	5.0		
		SV2: OFF / SV5: ON		2.0	5.1		
11	SV4 valve output data	SV4: ON		4. 1		
		SV4: OFF		4. 0		
12	SV3 valve output data	SV3: ON		3. 1		
		SV3: OFF		3. 0		
13	-	-		-	-		
14	PMV1 opening	Displays opening data in decimal format (total opening)		* *	* *. P		
15	PMV4 opening	Displays opening data in decimal format.		PMV4 ... *	* *. P		
16	Oil level judgment status						
	Normal	A	[o L]				
		B	Initial display: [... ..], Oil level judgment result: [... * ...] Displayed letters * represent judgment results for compressor Nos. 1 and 2, respectively ("0" for normal and "1" or "2" for low level.				
	<SW04> push SW function: Displays low level confirmed judgment result of each compressor.						
• Pressing of <SW05> restores normal display.	A	[L d]					
	B	Compressor low level being confirmed: [... L ...]					

(3) Display of outdoor cycle data (displayed on outdoor unit)

SW01	SW02	SW03	Display detail				
1	1	2	PD pressure data	PD pressure (MPaG) is displayed in decimal format. (MPaG: Approx. 10 times magnitude of kg/cm ² G)	A	B	
					P d.	*. * *	
			PS pressure data	PS pressure (MPaG) is displayed in decimal format.	P S.	*. * *	
			PL pressure conversion data	Converted PL pressure (MPaG) is displayed in decimal format.	P L.	*. * *	
			TD sensor data	Temperature sensor reading (°C) is displayed in decimal format. • Letter symbol and data are displayed alternately, for 1 second and display for 3 seconds, respectively. • Data with negative value is displayed as [- *] [* * *].	Letter symbol	t d
					Data	*	* * *
			TS1 sensor data		Letter symbol	t S	1
					Data	*	* * *
			TE sensor data		Letter symbol	t E
					Data	*	* * *
			TL1 sensor data		Letter symbol	t L	1
					Data	*	* * *
			TO sensor data		Letter symbol	t o
					Data	*	* * *
TK sensor data	Letter symbol	F...				
	Data	*	* * *				
TS3 sensor data	Letter symbol	t S	3				
	Data	*	* * *				
TL3 sensor data	Letter symbol	t L	3				
	Data	*	* * *				
		-	-	-			
		-	-	-			
		-	-	-			
		-	-	-			
		-	-	-			
		-	-	-			

(4) Display of indoor unit information (displayed on outdoor unit)

SW01	SW02	SW03	Display detail	
4	1~16	1~4	Indoor BUS communication signal receiving status	B Upon receiving signal: [... .. 1], Other times: [... ..]
5			Indoor check code	B No check code: [-- --]
6			Indoor HP capacity	B 0.6 to 10 HP : [...0.6] to [...10]
7			Indoor request command (S code, operation mode)	B [# *] # represents mode: COOL: [C. ... *], HEAT: [H. ... *] FAN: [F. ... *], OFF: [S. ... *] * represents S code: [# 0] to [# F]
8			Indoor PMV opening data	B Displayed in decimal format 30~1500pls : [... .. 3]~[150]
9			Indoor TA sensor data	B Displayed in decimal format
11		1~4	Indoor TCJ sensor data	B Displayed in decimal format
12			Indoor TC1 sensor data	B Displayed in decimal format
13			Indoor TC2 sensor data	B Displayed in decimal format

Note: Indoor address No. is selected by setting SW02 and SW03 and displayed on 7-segment display, section A.

SW03	SW02	Indoor address	7-segment display section A
1	1~16	SW02 setting number	[...1.]~[16.]
2	1~16	SW02 setting number +16	[17.]~[32.]
3	1~16	SW02 setting number +32	[33.]~[48.]
4	1~16	SW02 setting number +48	[49.]~[64.]

* Although 64 indoor unit addresses (Nos. 01-64) are theoretically available, the number of indoor units that can be connected to the same refrigerant piping system is limited to 16.

(5) Display of outdoor EEPROM writing check code (displayed on outdoor unit)

* The latest check code written in the EEPROM of outdoor unit is displayed.

(This function is used to check the check code after the resetting of the power supply.)

To display the check code, press SW04 and hold for at least 5 seconds after setting SW01 to 03 as shown in the table below.

SW01	SW02	SW03	Indoor address	7-segment display section A	
1	1	16	Latest check code of outdoor unit (U1)	E. 1.	***

• 7-Segment Display

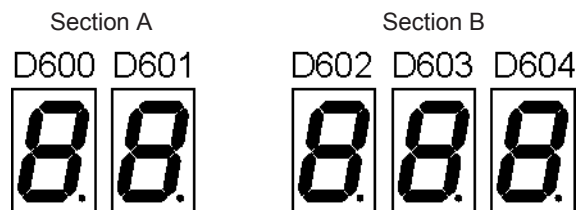

Set SW01 / SW02 / SW03 to [1/1/16] and press SW04 and hold for at least 5 seconds. The latest check code of the outdoor unit (U1) will be displayed.

9-7. Sensor characteristics

Outdoor Unit

▼ Temperature sensor characteristics

Outdoor TS1, TS3, TE, TL1, TL3, and TO sensors

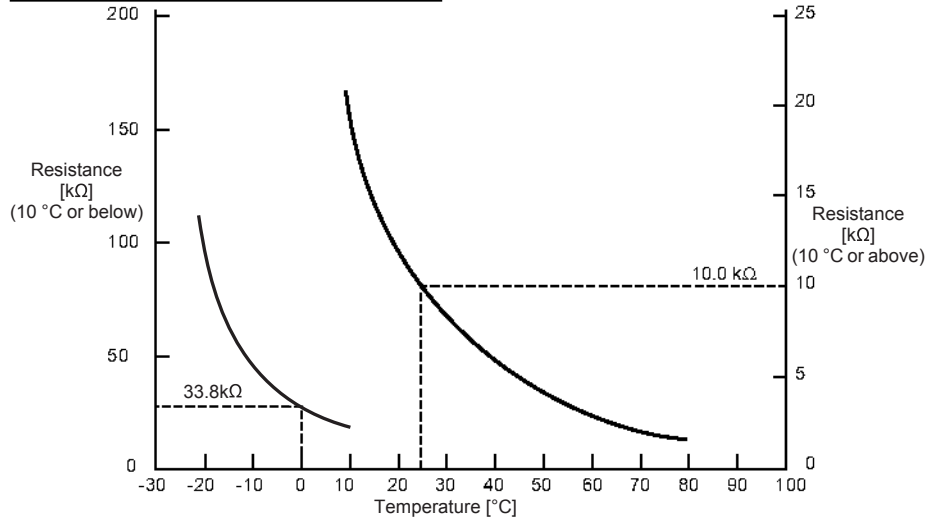

Temperature [°C]	Resistance [kΩ]
-20	101.7
-15	76.3
-10	57.7
-5	44.0
0	33.8
5	26.1
10	20.4
15	16.0
20	12.6
25	10.0
30	8.0
35	6.4
40	5.2
45	4.2
50	3.5
55	2.8
60	2.3
65	1.9
70	1.6
75	1.4
80	1.2

Outdoor, TD, TK sensor

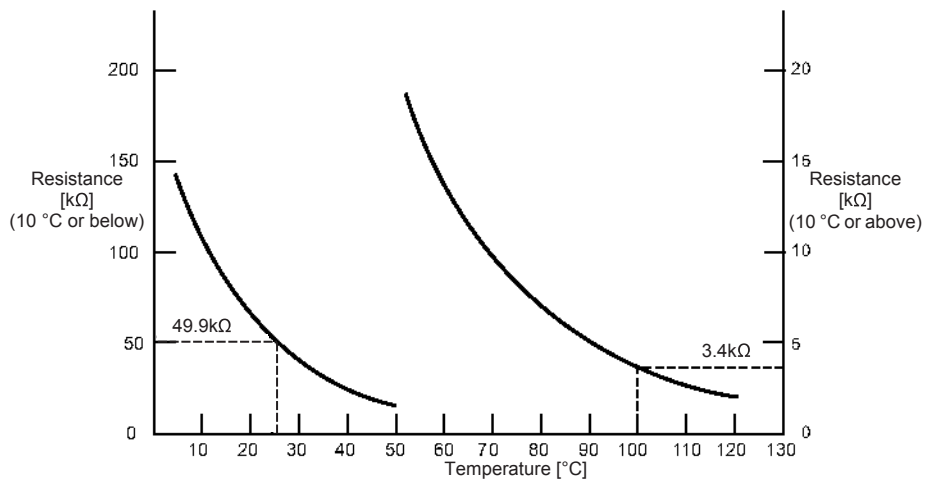

Temperature [°C]	Resistance [kΩ]
0	159.2
5	124.5
10	98.1
15	77.8
20	62.1
25	49.9
30	40.3
35	32.8
40	26.7
45	22.0
50	18.1
55	15.0
60	12.5
65	10.4
70	8.8
75	7.4
80	6.3
85	5.3
90	4.6
95	3.9
100	3.4
105	2.9
110	2.5
115	2.2
120	1.9

Outdoor Unit

▼ Pressure sensor characteristics

- Input / output wiring summary

Pin No.	High pressure side (PD)		Low pressure side (PS)	
	Input / output name	Lead wire color	Input / output name	Lead wire color
1	OUTPUT	White	—	—
2	—	—	OUTPUT	White
3	GND	Black	GND	Black
4	+5 V	Red	+5 V	Red

- Output voltage vs. pressure

High pressure side (PD)	Low pressure side (PS)
0.5~4.5 V 0~3.92 MPa	0.5~3.5 V 0~0.98 MPa

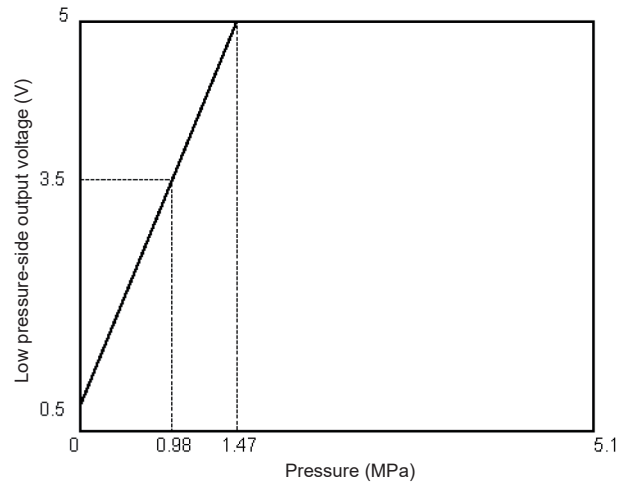
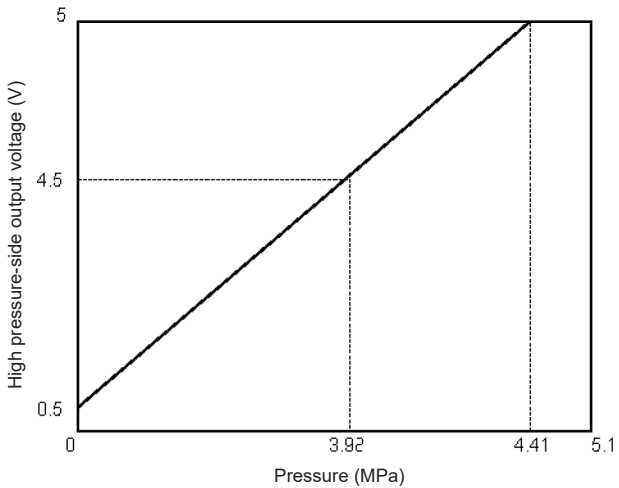

Indoor Unit

▼ Temperature sensor characteristics

Indoor TA sensor

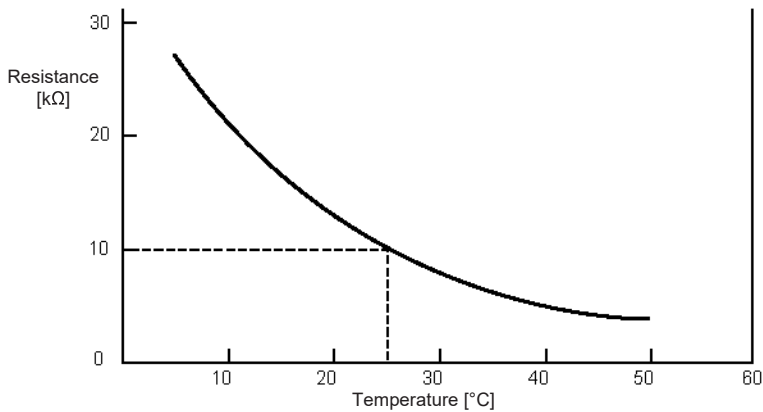

Temperature [°C]	Resistance [kΩ]
0	33.9
5	26.1
10	20.3
15	15.9
20	12.6
25	10.0
30	8.0
35	6.4
40	5.2
45	4.2
50	3.5
55	2.8
60	2.4

Indoor TC1 sensor

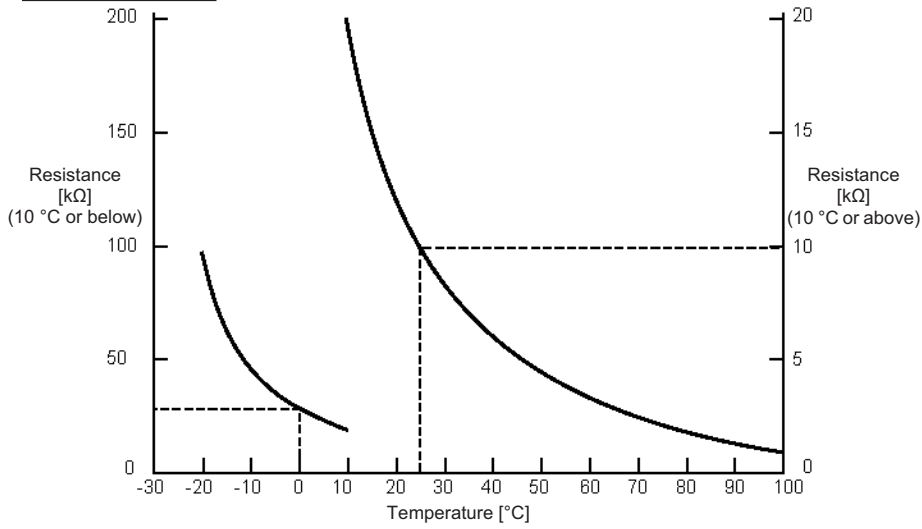

Temperature [°C]	Resistance [kΩ]
-20	99.9
-15	74.1
-10	55.6
-5	42.2
0	32.8
5	25.4
10	19.8
15	15.6
20	12.4
25	10.0
30	8.1
35	6.5
40	5.3
45	4.4
50	3.6
55	3.0
60	2.5
65	2.1
70	1.8
75	1.5
80	1.3
85	1.1
90	1.0
95	0.8
100	0.7

Indoor TC2 and TCJ sensors

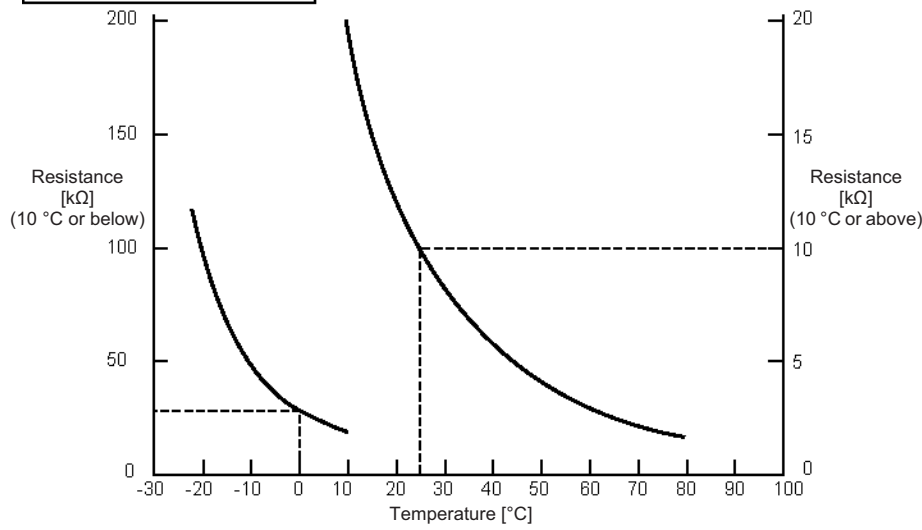

Temperature [°C]	Resistance [kΩ]
-20	115.2
-15	84.2
-10	62.3
-5	46.6
0	35.2
5	26.9
10	20.7
15	16.1
20	12.6
25	10.0
30	8.0
35	6.4
40	5.2
45	4.2
50	3.5
55	2.8
60	2.4
65	2.0
70	1.6
75	1.4
80	1.2

9-8. Pressure sensor output check

Outdoor Unit

▼ Pd sensor characteristics

0 to 3.92 MPa (0.5 to 4.5 V output for 0 to 3.92 MPa)

Voltage readings across pins 1 and 3 of CN501 on I/F P.C. board (with negative-side probe of multimeter placed on pin 3)

VOLT	Pd (MPa)	Pd (kg/cm ²)	VOLT	Pd (MPa)	Pd (kg/cm ²)	VOLT	Pd (MPa)	Pd (kg/cm ²)	VOLT	Pd (MPa)	Pd (kg/cm ²)	VOLT	Pd (MPa)	Pd (kg/cm ²)
0	0	0	1.00	0.4870	5.03	1.99	1.4647	15.00	2.99	2.4424	24.97	4.00	3.4394	35.14
0.02	0	0	1.02	0.5061	5.23	2.01	1.4839	15.20	3.01	2.4616	25.17	4.02	3.4585	35.34
0.04	0	0	1.04	0.5253	5.42	2.03	1.5030	15.40	3.03	2.4808	25.37	4.04	3.4777	35.53
0.06	0	0	1.05	0.5445	5.62	2.05	1.5222	15.59	3.05	2.5000	25.56	4.06	3.4969	35.73
0.08	0	0	1.07	0.5636	5.82	2.07	1.5414	15.79	3.07	2.5191	25.76	4.08	3.5160	35.92
0.10	0	0	1.09	0.5828	6.01	2.09	1.5606	15.98	3.09	2.5383	25.95	4.10	3.5352	36.12
0.12	0	0	1.11	0.6020	6.21	2.11	1.5797	16.18	3.11	2.5575	26.15	4.12	3.5544	36.31
0.14	0	0	1.13	0.6212	6.40	2.13	1.5989	16.37	3.13	2.5766	26.34	4.14	3.5736	36.51
0.16	0	0	1.15	0.6403	6.60	2.15	1.6181	16.57	3.14	2.5958	26.54	4.16	3.5927	36.70
0.18	0	0	1.17	0.6595	6.79	2.17	1.6372	16.76	3.16	2.6150	26.73	4.18	3.6119	36.90
0.20	0	0	1.19	0.6787	6.99	2.19	1.6564	16.96	3.18	2.6342	26.93	4.20	3.6311	37.09
0.21	0	0	1.21	0.6978	7.18	2.21	1.6756	17.15	3.20	2.6533	27.12	4.22	3.6502	37.29
0.23	0	0	1.23	0.7170	7.38	2.23	1.6948	17.35	3.22	2.6725	27.32	4.24	3.6694	37.49
0.25	0	0	1.25	0.7362	7.58	2.25	1.7139	17.55	3.24	2.6917	27.52	4.26	3.6886	37.68
0.27	0	0	1.27	0.7554	7.77	2.27	1.7331	17.74	3.26	2.7108	27.71	4.28	3.7078	37.88
0.29	0	0	1.29	0.7745	7.97	2.29	1.7523	17.94	3.28	2.7300	27.91	4.30	3.7269	38.07
0.31	0	0	1.31	0.7937	8.16	2.30	1.7714	18.13	3.30	2.7492	28.10	4.32	3.7461	38.27
0.33	0	0	1.33	0.8129	8.36	2.32	1.7906	18.33	3.32	2.7684	28.30	4.34	3.7653	38.46
0.35	0	0	1.35	0.8320	8.55	2.34	1.8098	18.52	3.34	2.7875	28.49	4.36	3.7844	38.66
0.37	0	0	1.37	0.8512	8.75	2.36	1.8290	18.72	3.36	2.8067	28.69	4.38	3.8036	38.85
0.39	0	0	1.39	0.8704	8.94	2.38	1.8481	18.91	3.38	2.8259	28.88	4.39	3.8228	39.05
0.41	0	0	1.41	0.8896	9.14	2.40	1.8673	19.11	3.40	2.8450	29.08	4.41	3.8420	39.25
0.43	0	0	1.43	0.9087	9.33	2.42	1.8865	19.30	3.42	2.8642	29.28	4.43	3.8611	39.44
0.45	0	0	1.45	0.9279	9.53	2.44	1.9056	19.50	3.44	2.8834	29.47	4.45	3.8803	39.64
0.47	0	0	1.46	0.9471	9.73	2.46	1.9248	19.70	3.46	2.9026	29.67	4.47	3.8995	39.83
0.49	0	0	1.48	0.9662	9.92	2.48	1.9440	19.89	3.48	2.9217	29.86	4.49	3.9186	40.03
0.51	0.0077	0.15	1.50	0.9854	10.12	2.50	1.9632	20.09	3.50	2.9409	30.06	4.51	3.9378	40.22
0.53	0.0268	0.34	1.52	1.0046	10.31	2.52	1.9823	20.28	3.52	2.9601	30.25	4.53	3.9570	40.42
0.55	0.0460	0.54	1.54	1.0238	10.51	2.54	2.0015	20.48	3.54	2.9792	30.45	4.55	3.9762	40.61
0.57	0.0652	0.73	1.56	1.0429	10.70	2.56	2.0207	20.67	3.55	2.9984	30.64	4.57	3.9953	40.81
0.59	0.0844	0.93	1.58	1.0621	10.90	2.58	2.0398	20.87	3.57	3.0176	30.84	4.59	4.0145	41.00
0.61	0.1035	1.12	1.60	1.0813	11.09	2.60	2.0590	21.06	3.59	3.0368	31.03	4.61	4.0337	41.20
0.63	0.1227	1.32	1.62	1.1004	11.29	2.62	2.0782	21.26	3.61	3.0559	31.23	4.63	4.0528	41.40
0.64	0.1419	1.51	1.64	1.1196	11.49	2.64	2.0974	21.46	3.63	3.0751	31.43	4.65	4.0720	41.59
0.66	0.1610	1.71	1.66	1.1388	11.68	2.66	2.1165	21.65	3.65	3.0943	31.62	4.67	4.0912	41.79
0.68	0.1802	1.91	1.68	1.1580	11.88	2.68	2.1357	21.85	3.67	3.1134	31.82	4.69	4.1104	41.98
0.70	0.1994	2.10	1.70	1.1771	12.07	2.70	2.1549	22.04	3.69	3.1326	32.01	4.71	4.1295	42.18
0.72	0.2186	2.30	1.72	1.1963	12.27	2.71	2.1740	22.24	3.71	3.1518	32.21	4.73	4.1487	42.37
0.74	0.2377	2.49	1.74	1.2155	12.46	2.73	2.1932	22.43	3.73	3.1710	32.40	4.75	4.1679	42.57
0.76	0.2569	2.69	1.76	1.2346	12.66	2.75	2.2124	22.63	3.75	3.1901	32.60	4.77	4.1870	42.76
0.78	0.2761	2.88	1.78	1.2538	12.85	2.77	2.2316	22.82	3.77	3.2093	32.79	4.79	4.2062	42.96
0.80	0.2952	3.08	1.80	1.2730	13.05	2.79	2.2507	23.02	3.79	3.2285	32.99	4.80	4.2254	43.16
0.82	0.3144	3.27	1.82	1.2922	13.24	2.81	2.2699	23.21	3.81	3.2476	33.19	4.82	4.2446	43.35
0.84	0.3336	3.47	1.84	1.3113	13.44	2.83	2.2891	23.41	3.83	3.2668	33.38	4.84	4.2637	43.55
0.86	0.3528	3.67	1.86	1.3305	13.64	2.85	2.3082	23.61	3.85	3.2860	33.58	4.86	4.2829	43.74
0.88	0.3719	3.86	1.88	1.3497	13.83	2.87	2.3274	23.80	3.87	3.3052	33.77	4.88	4.3021	43.94
0.90	0.3911	4.06	1.89	1.3688	14.03	2.89	2.3466	24.00	3.89	3.3243	33.97	4.90	4.3212	44.13
0.92	0.4103	4.25	1.91	1.3880	14.22	2.91	2.3658	24.19	3.91	3.3435	34.16	4.92	4.3404	44.33
0.94	0.4294	4.45	1.93	1.4072	14.42	2.93	2.3849	24.39	3.93	3.3627	34.36	4.94	4.3596	44.52
0.96	0.4486	4.64	1.95	1.4264	14.61	2.95	2.4041	24.58	3.95	3.3818	34.55	4.96	4.3788	44.72
0.98	0.4678	4.84	1.97	1.4455	14.81	2.97	2.4233	24.78	3.96	3.4010	34.75	4.98	4.3979	44.93
									3.98	3.4202	34.94	5.00	4.4171	44.93

Outdoor Unit

▼ Ps sensor characteristics

0 to 0.98 MPa (0.5 to 3.5 V output for 0 to 0.98 MPa)

Voltage readings across pins 2 and 3 of CN500 on I/F P.C. board (with negative-side probe of multimeter placed on pin 3)

VOLT	Ps (MPa)	Ps (kg/cm ²)	VOLT	Ps (MPa)	Ps (kg/cm ²)	VOLT	Ps (MPa)	Ps (kg/cm ²)	VOLT	Ps (MPa)	Ps (kg/cm ²)	VOLT	Ps (MPa)	Ps (kg/cm ²)
0	0	0	1.00	0.1621	1.67	1.99	0.4874	4.99	2.99	0.8128	8.31	4.00	1.1446	11.69
0.02	0	0	1.02	0.1621	1.74	2.01	0.4938	5.06	3.01	0.8192	8.37	4.02	1.151	11.76
0.04	0	0	1.04	0.1684	1.80	2.03	0.5002	5.12	3.03	0.8256	8.44	4.04	1.157	11.82
0.06	0	0	1.05	0.1748	1.87	2.05	0.5066	5.19	3.05	0.8320	8.50	4.06	1.164	11.89
0.08	0	0	1.07	0.1812	1.93	2.07	0.5130	5.25	3.07	0.8384	8.57	4.08	1.170	11.95
0.10	0	0	1.09	0.1876	2.00	2.09	0.5193	5.32	3.09	0.8447	8.63	4.10	1.177	12.02
0.12	0	0	1.11	0.1940	2.06	2.11	0.5257	5.38	3.11	0.8511	8.70	4.12	1.183	12.08
0.14	0	0	1.13	0.2003	2.13	2.13	0.5321	5.45	3.13	0.8575	8.76	4.14	1.189	12.15
0.16	0	0	1.15	0.2067	2.19	2.15	0.5385	5.51	3.14	0.8639	8.83	4.16	1.196	12.21
0.18	0	0	1.17	0.2131	2.26	2.17	0.5449	5.58	3.16	0.8703	8.89	4.18	1.202	12.28
0.20	0	0	1.19	0.2195	2.32	2.19	0.5513	5.64	3.18	0.8766	8.96	4.20	1.208	12.34
0.21	0	0	1.21	0.2259	2.39	2.21	0.5576	5.71	3.20	0.8830	9.02	4.22	1.215	12.41
0.23	0	0	1.23	0.2322	2.45	2.23	0.5640	5.77	3.22	0.8894	9.09	4.24	1.221	12.47
0.25	0	0	1.25	0.2386	2.52	2.25	0.5704	5.84	3.24	0.8958	9.15	4.26	1.228	12.54
0.27	0	0	1.27	0.2450	2.58	2.27	0.5768	5.90	3.26	0.9022	9.22	4.28	1.234	12.60
0.29	0	0	1.29	0.2514	2.65	2.29	0.5832	5.97	3.28	0.9085	9.28	4.30	1.240	12.67
0.31	0	0	1.31	0.2578	2.71	2.30	0.5895	6.03	3.30	0.9149	9.35	4.32	1.247	12.73
0.33	0	0	1.33	0.2641	2.78	2.32	0.5959	6.10	3.32	0.9213	9.41	4.34	1.253	12.80
0.35	0	0	1.35	0.2705	2.84	2.34	0.6023	6.16	3.34	0.9277	9.48	4.36	1.260	12.86
0.37	0	0	1.37	0.2769	2.91	2.36	0.6087	6.23	3.36	0.9341	9.54	4.38	1.266	12.93
0.39	0	0	1.39	0.2833	2.97	2.38	0.6151	6.29	3.38	0.9404	9.61	4.39	1.272	12.99
0.41	0	0	1.41	0.2897	3.04	2.40	0.6214	6.36	3.40	0.9468	9.67	4.41	1.279	13.06
0.43	0	0	1.43	0.2960	3.10	2.42	0.6278	6.42	3.42	0.9532	9.74	4.43	1.285	13.12
0.45	0	0	1.45	0.3024	3.17	2.44	0.6342	6.49	3.44	0.9596	9.80	4.45	1.291	13.19
0.47	0	0	1.46	0.3088	3.23	2.46	0.6406	6.55	3.46	0.9660	9.87	4.47	1.298	13.25
0.49	0	0	1.48	0.3152	3.30	2.48	0.6470	6.62	3.48	0.9723	9.93	4.49	1.304	13.32
0.51	0.0026	0.05	1.50	0.3216	3.36	2.50	0.6533	6.68	3.50	0.9787	10.00	4.51	1.311	13.38
0.53	0.0089	0.11	1.52	0.3279	3.43	2.52	0.6597	6.75	3.52	0.9851	10.06	4.53	1.317	13.45
0.55	0.0153	0.18	1.54	0.3343	3.49	2.54	0.6661	6.81	3.54	0.9915	10.13	4.55	1.323	13.51
0.57	0.0217	0.24	1.56	0.3407	3.56	2.56	0.6725	6.88	3.55	0.9979	10.19	4.57	1.330	13.58
0.59	0.0281	0.31	1.58	0.3471	3.62	2.58	0.6789	6.94	3.57	1.0042	10.26	4.59	1.336	13.64
0.61	0.0345	0.37	1.60	0.3535	3.69	2.60	0.6852	7.01	3.59	1.0106	10.32	4.61	1.342	13.71
0.63	0.0408	0.44	1.62	0.3598	3.75	2.62	0.6916	7.07	3.61	1.0170	10.39	4.63	1.349	13.77
0.64	0.0472	0.50	1.64	0.3662	3.82	2.64	0.6980	7.14	3.63	1.0234	10.46	4.65	1.355	13.84
0.66	0.0536	0.57	1.66	0.3726	3.88	2.66	0.7044	7.20	3.65	1.0298	10.52	4.67	1.362	13.90
0.68	0.0600	0.63	1.68	0.3790	3.95	2.68	0.7108	7.27	3.67	1.0361	10.59	4.69	1.368	13.97
0.70	0.0664	0.70	1.70	0.3854	4.01	2.70	0.7171	7.33	3.69	1.0425	10.65	4.71	1.374	14.03
0.72	0.0727	0.76	1.72	0.3917	4.08	2.71	0.7235	7.40	3.71	1.0489	10.72	4.73	1.381	14.10
0.74	0.0791	0.83	1.74	0.3981	4.14	2.73	0.7299	7.46	3.73	1.0553	10.78	4.75	1.387	14.16
0.76	0.0855	0.89	1.76	0.4045	4.21	2.75	0.7363	7.53	3.75	1.0617	10.85	4.77	1.393	14.23
0.78	0.0919	0.96	1.78	0.4109	4.27	2.77	0.7427	7.59	3.77	1.0680	10.91	4.79	1.400	14.29
0.80	0.0983	1.02	1.80	0.4173	4.34	2.79	0.7490	7.66	3.79	1.0744	10.98	4.80	1.406	14.36
0.82	0.1046	1.09	1.82	0.4236	4.40	2.81	0.7554	7.72	3.81	1.0808	11.04	4.82	1.413	14.42
0.84	0.1110	1.15	1.84	0.4300	4.47	2.83	0.7618	7.79	3.83	1.0872	11.11	4.84	1.419	14.49
0.86	0.1174	1.22	1.86	0.4364	4.53	2.85	0.7682	7.85	3.85	1.0936	11.17	4.86	1.425	14.55
0.88	0.1238	1.28	1.88	0.4428	4.60	2.87	0.7746	7.92	3.87	1.0999	11.24	4.88	1.432	14.62
0.90	0.1302	1.35	1.89	0.4492	4.66	2.89	0.7809	7.98	3.89	1.1063	11.30	4.90	1.438	14.68
0.92	0.1365	1.41	1.91	0.4555	4.73	2.91	0.7873	8.05	3.91	1.1127	11.37	4.92	1.445	14.75
0.94	0.1429	1.48	1.93	0.4619	4.79	2.93	0.7937	8.11	3.93	1.1191	11.43	4.94	1.451	14.81
0.96	0.1493	1.54	1.95	0.4683	4.86	2.95	0.8001	8.18	3.95	1.1255	11.50	4.96	1.457	14.88
0.98	0.1557	1.61	1.97	0.4747	4.92	2.97	0.8065	8.24	3.96	1.1318	11.56	4.98	1.464	14.94
									3.98	1.1382	11.63	5.00	1.470	14.98

10 Outdoor unit parts replacement methods

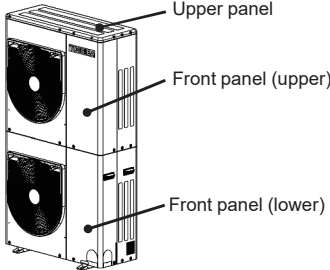
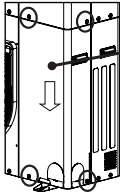
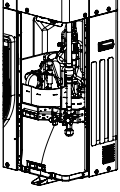
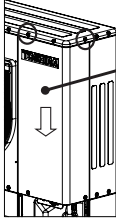
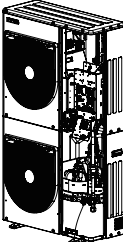
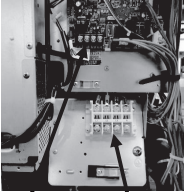
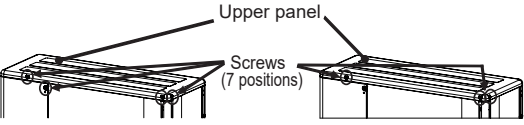

Step	Component	Procedure	Remarks
1	Common (Front panels, upper panel)	<p>⚠ WARNING</p> <p>Do not detach the inverter for 5 minutes after turning off the breaker as doing so may cause electric shocks.</p> <hr/> <p>⚠ CAUTION</p> <p>Wear gloves when working on it. Failure to observe this precaution may cause injury due to components, etc.</p> <hr/> <p>1. Detachment</p> <ol style="list-style-type: none"> 1) Turn off the air conditioner and the breaker switch. 2) Remove the lower part of front panel. (screws: M4×10, 4) (Fig. 1-2) <ul style="list-style-type: none"> • Remove the screws, and then pull the front panel downward to remove it. 3) Remove the upper part of front panel. (screws: M4×10, 2) (Fig. 1-4) <ul style="list-style-type: none"> • Remove the screws, and then pull the front panel downward to remove it. 4) Remove the power wire and indoor / outdoor communication wire from the power supply terminal block and communication terminal block. (Fig. 1-6) 5) Remove the upper panel. (screws: M4×10, 7) (Fig. 1-7) <p>2. Attachment</p> <ol style="list-style-type: none"> 1) Mount the upper panel. (screws: M4×10, 7) (Fig. 1-7) 2) Connect the power wire and indoor / outdoor connection wire to the terminals, and fix them with the cord clamp. (Fig. 1-6) <p>⚠ CAUTION</p> <p>Fix the power wire and indoor / outdoor communication wire along the pipes using commercially available binding bands so that they do not come into contact with the compressor, gas side valve, gas side pipe, and discharge pipe.</p> <hr/> <ol style="list-style-type: none"> 3) Attach the front panel in the order of upper, and lower in the reverse of disassembly. 	 <p>(Fig. 1-1)</p>  <p>(Fig. 1-2)</p>  <p>(Fig. 1-3)</p>  <p>(Fig. 1-4)</p>  <p>(Fig. 1-5)</p>  <p>(Fig. 1-6)</p>  <p>(Fig. 1-7)</p>

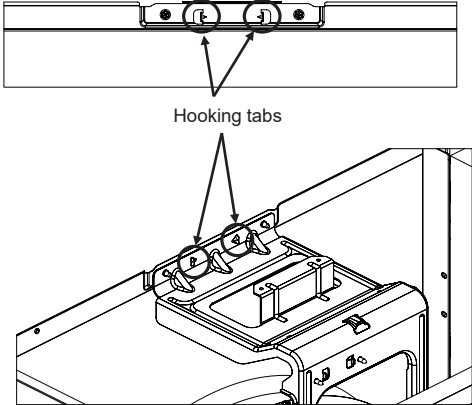
Step	Component	Procedure	Remarks
2	Discharge cabinet	<p>1. Detachment</p> <p>1) Remove the front panels and upper panel. [Step.1]</p> <p>2) Remove the screws of the discharge cabinet (upper), top of the heat exchanger plate. (M4×10, 2) (Fig. 2-1)</p> <div data-bbox="416 472 815 636" data-label="Image"> <p>Heat exchanger (upper) screws (2 positions)</p> </div> <p>(Fig. 2-1)</p> <p>3) Remove the screws of the discharge cabinet (upper) and discharge cabinet (lower). (M4×10, 2) (Fig. 2-3)</p> <p>4) Remove the screws of the discharge cabinet (upper) and partition plate. (M4×10, 3) (Fig. 2-3)</p> <p>5) Remove the screws of the discharge cabinet (upper) and fin guard (upper). (M4×10, 3) (Fig. 2-4)</p> <p>6) Remove the screws of the discharge cabinet (upper) and motor base, and remove the discharge cabinet (upper). (M4×10, 2) (Fig. 2-5)</p> <div data-bbox="403 1064 828 1214" data-label="Image"> <p>Motor base (upper) screws (2 positions)</p> </div> <p>(Fig. 2-5)</p> <p>7) Remove the screws of the discharge cabinet (lower), middle of the heat exchanger plate. (M4×10, 2) (Fig. 2-6)</p> <div data-bbox="387 1285 844 1458" data-label="Image"> <p>Middle of the heat exchanger plate screw (2 positions)</p> </div> <p>(Fig. 2-6)</p> <p>8) Remove the screws of the discharge cabinet and baseplate. (M4×10, 2) (Fig. 2-7)</p> <p>9) Remove the screws of the discharge cabinet (lower) and partition plate. (M4×10, 3) (Fig. 2-7)</p> <p>10) Remove the screws of the discharge cabinet (lower) and fin guard (lower). (M4×10, 3) (Fig. 2-8)</p> <p>11) Remove the screws of the discharge cabinet (lower) and motor base, and remove the discharge cabinet (lower). (M4×10, 2) (Fig. 2-9)</p> <div data-bbox="387 1895 844 2067" data-label="Image"> <p>Motor base (lower) screws (2 positions)</p> </div> <p>(Fig. 2-9)</p>	<div data-bbox="970 300 1356 654" data-label="Image"> <p>Discharge cabinet (upper)</p> <p>Discharge cabinet (lower)</p> </div> <p>(Fig. 2-2)</p> <div data-bbox="919 748 1445 1294" data-label="Image"> <p>Discharge cabinet (upper)</p> <p>Discharge cabinet (upper) screws (2 positions)</p> <p>Partition plate screws (3 positions)</p> </div> <p>(Fig. 2-3)</p> <div data-bbox="1299 826 1445 1294" data-label="Image"> <p>Fin guard screws (3 positions)</p> </div> <p>(Fig. 2-4)</p> <div data-bbox="906 1337 1267 1861" data-label="Image"> <p>Discharge cabinet (lower)</p> <p>Base plate screws (2 positions)</p> <p>Partition plate screws (3 positions)</p> </div> <p>(Fig. 2-7)</p> <div data-bbox="1299 1384 1445 1861" data-label="Image"> <p>Fin guard screws (3 positions)</p> </div> <p>(Fig. 2-8)</p>

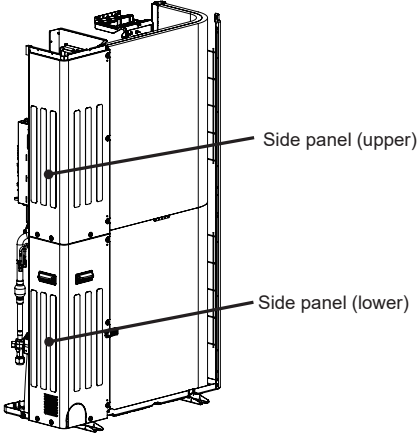
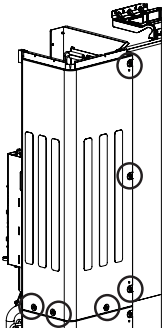
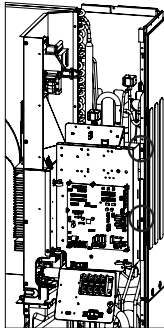
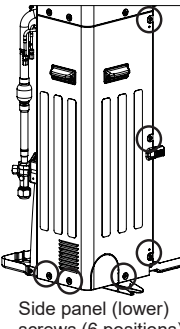
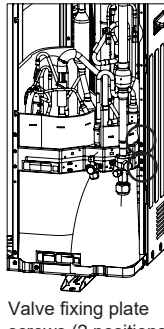

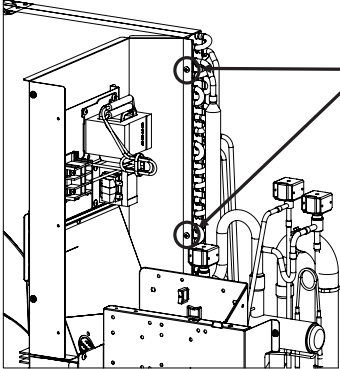
Step	Component	Procedure	Remarks
2	Discharge cabinet (continued)	<p>2. Attachment</p> <p>1) Mount by reversing the detachment procedure, attaching the lower and upper discharge cabinets in order.</p> <ul style="list-style-type: none"> • Insert the hooking tabs into the holes in the motor base and fix each discharge cabinet in place with screws. (Fig. 2-10)  <p style="text-align: center;">(Fig. 2-10)</p>	

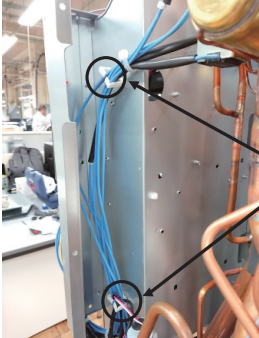

Step	Component	Procedure	Remarks
3	Side panel	<p>1. Detachment</p> <ol style="list-style-type: none"> 1) Remove the front panels and upper panel. [Step.1] 2) Remove the screws of the side panel (upper), top of the heat exchanger plate, and side panel (lower). (M4×10, 6) (Fig. 3-2) 3) Remove the screws of the side panel (upper) and inverter assembly, and remove the side panel (upper). (M4×10, 2) (Fig. 3-3) 4) Remove the screws of the side panel (lower) and heat exchanger plate (lower), and bottom plate. (M4×10, 6) (Fig. 3-4) 5) Remove the screws of the side panel (lower) and valve fixing plate, and remove the side panel (lower). (M4×10, 2) (Fig. 3-5) <p>2. Attachment</p> <ol style="list-style-type: none"> 1) Mount by reversing the detachment procedure, attaching the lower and upper side panel in order. 	 <p>(Fig. 3-1)</p>  <p>Side panel (upper) screws (6 positions) (Fig. 3-2)</p>  <p>Inverter assembly (2 positions) (Fig. 3-3)</p>  <p>Side panel (lower) screws (6 positions) (Fig. 3-4)</p>  <p>Valve fixing plate screws (2 positions) (Fig. 3-5)</p>

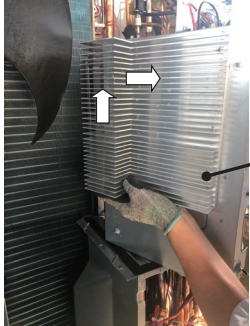
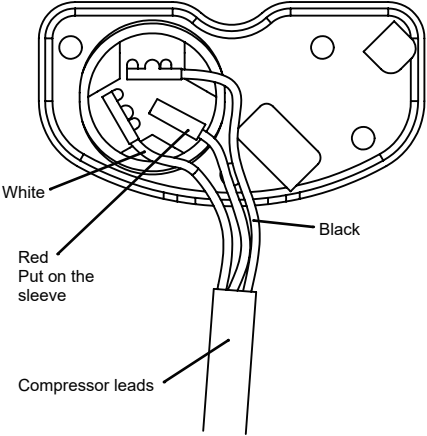
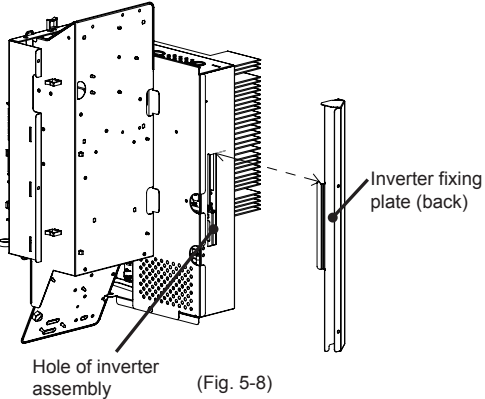
Step	Component	Procedure	Remarks
4	Partition plate (upper) replacement	<p>⚠ WARNING</p> <hr/> <p>Do not detach the inverter for 5 minutes after turning off the breaker as doing so may cause electric shocks.</p> <hr/> <p>1. Detachment</p> <ol style="list-style-type: none"> 1) Remove the front panels, upper panel and discharge cabinets. [Step.1 and Step.2] 2) Remove the screws of the reactor (CH-90) from terminal block.(M5×10,2) (Fig.4-1) Remove the fast-on terminal of the reactor (CH-98). (2 positions) (Fig.4-1) 3) Remove the screws for the partition plate (upper) and heat exchanger's side metal plate. (Fig.4-2) 4) Lift the assembly and remove it. (Fig.4-2) <p>⚠ CAUTION</p> <hr/> <p>Disengage the locks on the housing to unplug the connectors.</p> <hr/> <p>2. Attachment</p> <ol style="list-style-type: none"> 1) Install it in the reverse of the procedure to remove it. Tighten the screws of terminal block to 1.2Nm. 	 <p>(Fig. 4-1)</p>  <p>(Fig. 4-2)</p>

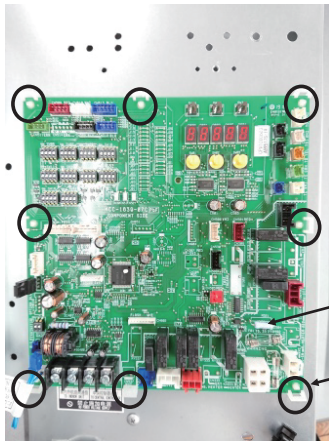

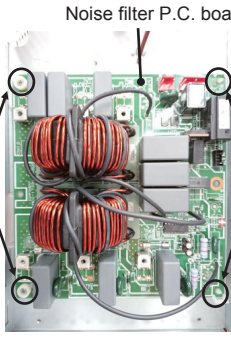
Step	Component	Procedure	Remarks
5	Inverter assembly	<p>⚠ WARNING</p> <p>Do not detach the inverter for 5 minutes after turning off the breaker as doing so may cause electric shocks.</p> <hr/> <p>1. Detachment</p> <p>1) Remove the front panels, upper panel, discharge cabinets, side panels, and partition plate (upper). [Step.1, Step.2, Step.3, and Step.4]</p> <p>2) Unplug two motor lead connector of fan, from pc board. (2positions) (Fig.5-1)</p> <p>⚠ CAUTION</p> <p>Disengage the locks on the housing to unplug the connectors.</p> <p>CN750...Fan motor lead (lower) (3P: White) CN700...Fan motor lead (upper) (3P: Blue)</p> <p>3) Remove two metal bands,and disengage inverter fixing plate hooks and cut the tie wrap (totally 5 positions). (Fig. 5-2)</p> <p>4) Remove sensor lead wire clamps and banding band in Fig.5-3.</p> <p>5) Unplug all the connectors that connected to other components on the interface P.C board.</p> <p>⚠ CAUTION</p> <p>Disengage the locks on the housing to unplug the connectors.</p> <p>CN502 ...TD sensor (3P: white) CN506...TS3 sensor (2P: Black) CN507 ...TO sensor (2P: yellow) CN520 ...TE sensor (2P: green) CN505 ...TS1 sensor (2P: white) CN523 ...TL1 sensor (2P: white) CN525...TL3 sensor (2P: Red) CN918 ...TK sensor (3P: black) CN317 ...4-way valve coil (3P: blue) CN300 ...PMV1 coil (6P: white) CN301...PMV4 coil (6P: White) CN312 ...2-way valve coil (3P: red) CN314 ...2-way valve coil (4P: white) CN311 ...2-way valve coil (3P: white) CN316 ...2-way valve coil (3P: black) CN305 ...High-pressure switch (2P: red) CN501 ...High-pressure sensor (4P: red) CN500 ...Low-pressure sensor (4P: white) CN600 ...Connection with fan P.C. board (CN504) (5P: white) CN304 ...Connection with power relay (No.5: red), (No.6: gray), (3P: red) CN400 ...Connection with noise filter P.C. board (CN102) (2P: white) CN530 ...Connection with noise filter P.C. board (CN50) (4P: black)</p> <p>6) Remove all sensor leads from clamp wires. (2 positions) (Fig.5-4)</p>	 <p>(Fig. 5-1)</p>  <p>(Fig. 5-2)</p>  <p>(Fig. 5-3)</p>  <p>(Fig. 5-4)</p>

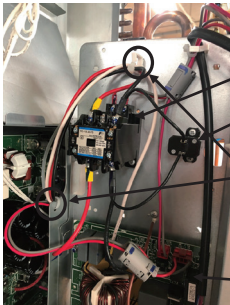
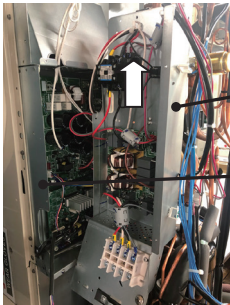
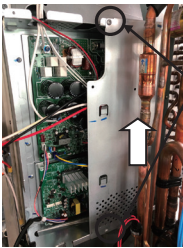

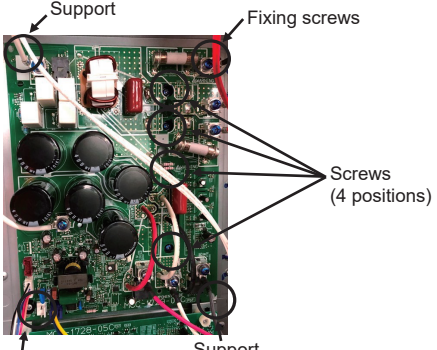
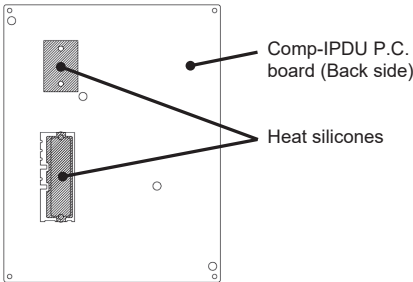
Step	Component	Procedure	Remarks
5	Inverter assembly (continued)	<p>7) Remove the terminal cover of the compressor, and disconnect the compressor leads from the compressor. (Fig. 5-5)</p> <p>⚠ WARNING</p> <p>If the strap terminal of the compressor lead line is struck diagonally, it may overheat and cause fire.</p> <p>8) Remove the screw of the inverter assembly and inverter fixing plate (lower). (M4×10, 1) (Fig. 5-6)</p> <p>9) Lift up on the inverter assembly and move it forward and out. (Fig. 5-7)</p>  <p>(Fig. 5-6)</p>  <p>(Fig. 5-7)</p> <p>2. Attachment</p> <p>1) Install it in the reverse of the procedure to remove it.</p> <p>Built-in precautions for INV</p> <ul style="list-style-type: none"> • Hook the Inverter fixing plate (back) hooks securely on the hole of inverter assembly. (1 position) (Fig. 5-8) 	 <p>(Fig. 5-5)</p> <p>Notes on Compressor leads</p> <ul style="list-style-type: none"> • Connect each compressor lead wire to its designated terminal. • Do not press the fast-on terminals twice. • After disconnecting the fast-on terminals that have been inserted once, replace the compressor leads. • Make sure to keep the exposed compressor lead wires straight. • Be careful not to apply excess stress to the terminals and lead wires. • Attach the terminal cover after passing the lead wires through the bushing. At this time, be careful not to let the lead wires get caught in the gap with the terminal cover.  <p>(Fig. 5-8)</p>

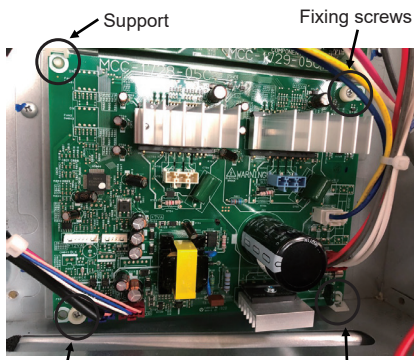
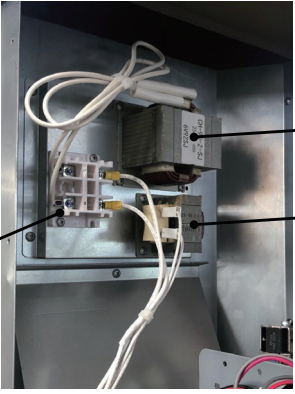
Step	Component	Procedure	Remarks
6	Interface P.C. board	<p>⚠ WARNING</p> <p>Do not detach the inverter for 5 minutes after turning off the breaker as doing so may cause electric shocks.</p> <hr/> <p>1. Detachment</p> <ol style="list-style-type: none"> 1) Remove the front panels. [Step.1] Disconnect all the connectors on the Interface PC board. [“5” of Step.5] 2) Remove the support hooks (8 positions) fixing the board to remove the interface P.C.board. (Fig. 6-1) <p>2. Attachment</p> <ol style="list-style-type: none"> 1) Install it in the reverse of the procedure to remove it. 2) Set the jumper wires of P.C. board according to “11 P.C.board exchange procedure”. 	 <p>Interface P.C. board</p> <p>Support (8 positions)</p> <p>(Fig. 6-1)</p>
7	Noise filter P.C. board	<p>⚠ WARNING</p> <p>Do not detach the inverter for 5 minutes after turning off the breaker as doing so may cause electric shocks.</p> <hr/> <p>1. Detachment</p> <ol style="list-style-type: none"> 1) Remove the front panels. [Step.1] Disconnect the sensor connectors and remove the clamp and banding band. [“4” and “5” of Step.5] 2) Remove the screws fixing the interface P.C. board attachment plate, and pull the attachment plate in the direction of the arrow to remove it. (M4×8, 4) (Fig. 7-1, 7-2) 3) Remove the connector connected between the noise filter P.C. board and another component. <p>⚠ CAUTION</p> <p>Disengage the locks on the housing to unplug the connectors.</p> <hr/> <p>CN01Connection with terminal block (L1) (red) CN02Connection with terminal block (L2) (white) CN03Connection with terminal block (L3) (black) CN04Connection with terminal block (N) (gray) CN50Connection with Interface PC Board (CN530) (4P: black) CN15Earth Wire (1P: brown) CN21Connection with magnetic contactor (No2) (red) CN22Connection with compressor IPDU board (CN02) (white) CN23Connection with magnetic contactor (No6) (black) CN101 ...Connection with fan IPDU board (5P: red) CN102 ...Connection with Interface PC board (CN400) (3P: red)</p> <ol style="list-style-type: none"> 4) Remove the two screws and the two support hooks from the noise filter P.C. board, and remove it. (Fig. 7-3) <p>2. Attachment</p> <ol style="list-style-type: none"> 1) Install it in the reverse of the procedure to remove it. 2) The tightening torques are as follows. M3: 0.55±0.1N·m M4: 1.20±0.1N·m 	 <p>Screws (4 positions)</p> <p>(Fig. 7-1)</p>  <p>Interface P.C. board attachment plate</p> <p>(Fig. 7-2)</p>  <p>Noise filter P.C. board.</p> <p>Screws (2 positions)</p> <p>Support (2 positions)</p> <p>(Fig. 7-3)</p>

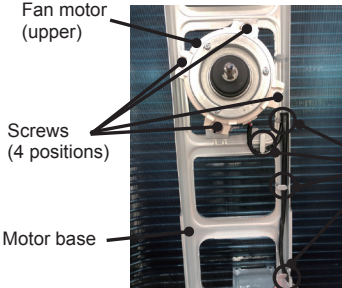
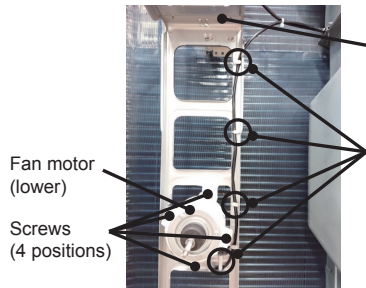
Step	Component	Procedure	Remarks
8	Comp-IPDU P.C. board	<p>⚠ WARNING</p> <p>Do not detach the inverter for 5 minutes after turning off the breaker as doing so may cause electric shocks.</p> <p>1. Detachment</p> <p>Remove the front panels. [Step.1] Unplug the connector of the sensors, and remove the clamps, etc. ["5" and "6" of Step.5] Remove the screws of the interface P.C.board attachment plate. ["1" and "2" of Step.7]</p> <p>3) Disconnect the connectors which are connected to the magnetic contactor. (Fig. 8-1) No1 : Connection with Comp-IPDU P.C. board (CN01) (red) No5 : Connection with Comp-IPDU P.C. board (CN03) (black)</p> <p>4) Disconnect the connector which is connected to the PTC thermistor. (Fig. 8-1) Connection with compressor P.C. board (CN03) (black)</p> <p>5) Disconnect the connectors which are connected to the noise filter P.C. board.</p> <p>⚠ CAUTION</p> <p>Disengage the locks on the housing to unplug the connectors.</p> <p>CN22Connection with compressor P.C. board (CN02) (white) CN101 ...Connection with fan IPDU board (5P: red)</p> <p>6) Remove the 2 banding bands which is used to tie the lead wires and metal plate, and cable clamp. (Fig. 8-1)</p> <p>7) Remove the Noise filter P.C. board attachment plate from inverter assembly box. (Fig. 8-2)</p> <p>8) Remove the screws for inverter box and inverter cover (A). (M4×10, 2) (Fig. 8-3)</p> <p>9) Remove the connector connected between the Comp-IPDU P.C. board and another component.</p> <p>⚠ CAUTION</p> <p>Disengage the locks on the housing to unplug the connectors.</p> <p>CN201 ...Compressor lead (red) CN202 ...Compressor lead (white) CN203 ...Compressor lead (black) CN102 ...Connection with fan IPDU board (3P: blue) CN04, CN05 ... Connection with reactor (CH-90) (white) CN01 Connection with magnetic contactor (No1) (red) CN02 Connection with noise filter P.C. board (CN22) (white) CN03 Connection with magnetic contactor (No5) (black) CN852 ...Connection with fan IPDU board (5P: white)</p> <p>10) Remove the Comp-IPDU P.C. board fixing 2 screws and 2 supports. (Fig. 8-5)</p> <p>11) Remove the screws on the Comp-IPDU P.C. board. (M4×15, 4) (Fig. 8-5)</p> <p>2. Attachment</p> <p>1) Install it in the reverse of the procedure to remove it.</p> <p>2) Apply heat silicones to the Comp-IPDU P.C. board before replacing it. (Fig. 8-6) * Standard for heat silicone heat sinkcompound: Manufacturer: Shin-Etsu Chemical Co., Ltd. Type: G746 or G747</p> <p>3) The tightening torques are as follows. M3: 0.55±0.1N·m M4: 1.20±0.1N·m</p>	 <p>Magnetic contactor PTC thermistor Banding bands (2 positions) Noise filter P.C. board</p> <p>(Fig. 8-1)</p>  <p>Noise filter P.C. board attachment plate Inverter box</p> <p>(Fig. 8-2)</p>  <p>Inverter cover (A) screws (2 positions)</p>  <p>Comp-IPDU P.C. board</p> <p>(Fig. 8-3) (Fig. 8-4)</p>  <p>Support Fixing screws Screws (4 positions)</p> <p>Fixing screws Support</p> <p>(Fig. 8-5)</p>  <p>Comp-IPDU P.C. board (Back side) Heat silicones</p> <p>(Fig. 8-6)</p>

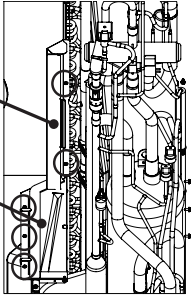
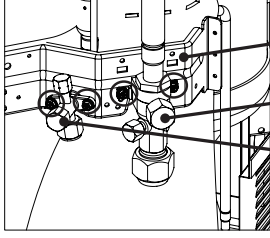
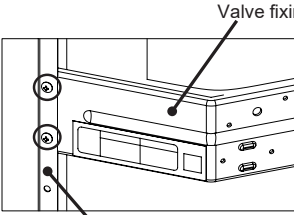
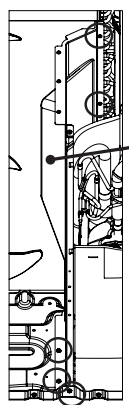

Step	Component	Procedure	Remarks
9	Fan IPDU P.C. board	<p>1. Detachment</p> <ol style="list-style-type: none"> 1) Remove the front panels. [Step.1] Unplug the connector of the sensors, and remove the clamps, etc. ["1" to "5" of Step.5] Remove the screws of the inverter cover (A), and remove it. ["1" to "7" of Step.8] 2) Remove the connector connected between the Fan IPDU P.C. board and another component. <p>CAUTION</p> <p>Disengage the locks on the housing to unplug the connectors.</p> <p>Fan IPDU P.C. board CN500 ... Connection with noise filter PC board (CN101) Connection with reactor (CH98) (7P: RED) CN502 ... Connection with compressor IPDU board (CN102) (3P: white) CN505 ... Connection with compressor IPDU board (CN852) (5P: RED) CN504 ... Connection with interface PC board (CN600) (5P: blue)</p> <ol style="list-style-type: none"> 3) Remove the fan IPDU PC board fixing support hooks and fixing screws (4 positions) (Fig. 9-2) <p>2. Attachment</p> <ol style="list-style-type: none"> 1) Install it in the reverse of the procedure to remove it. 	 <p>Fan-IPDU P.C. board</p> <p>(Fig. 9-1)</p>  <p>Support Fixing screws</p> <p>Fixing screws Support</p> <p>(Fig. 9-2)</p>
10	Reactor replacement	<p>WARNING</p> <p>Do not detach the inverter for 5 minutes after turning off the breaker as doing so may cause electric shocks.</p> <p>1. Detachment</p> <ol style="list-style-type: none"> 1) Remove the front panels, upper panel. [Step.1 and Step.2] 2) Remove the screws on the reactor CH-98 or CH-90. (M4×8, 4) (Fig. 10-1) 3) Remove a connector of the CH-98, or screws of the CH-90, and remove the reactor to be replaced. <p>2. Attachment</p> <ol style="list-style-type: none"> 1) Install it in the reverse of the procedure to remove it. Tighten the screws of terminal block to 1.2Nm. 	 <p>Reactor CH-90</p> <p>Reactor CH-98</p> <p>Terminal block</p> <p>(Fig. 10-1)</p>

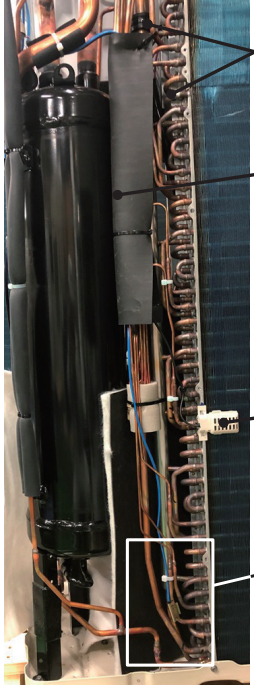
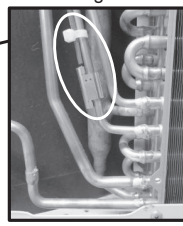

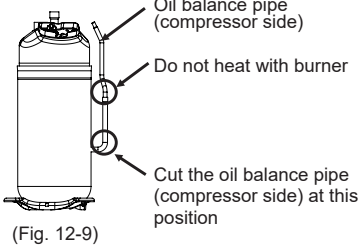
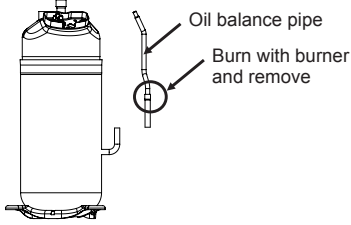
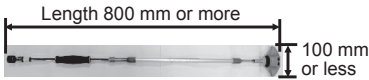
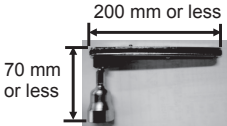
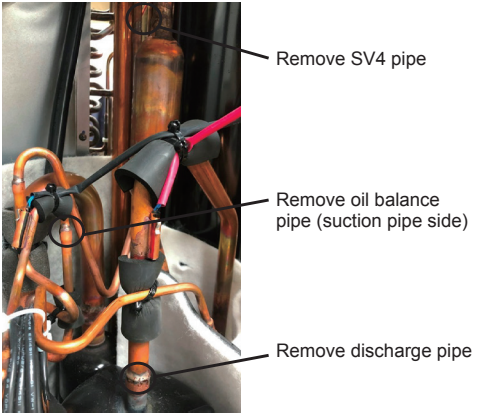
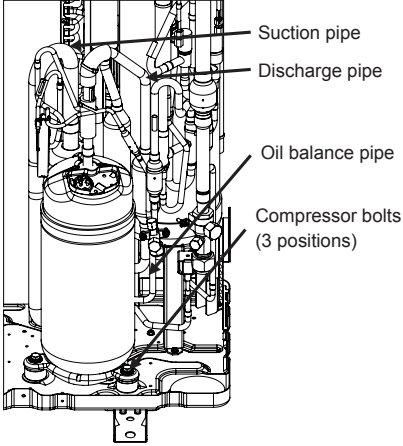
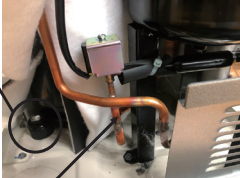
Step	Component	Procedure	Remarks
11	Fan motor replacement	<p>⚠ WARNING</p> <p>Do not detach the inverter for 5 minutes after turning off the breaker as doing so may cause electric shocks.</p> <p>1. Detachment</p> <ol style="list-style-type: none"> 1) Remove the front panels, upper panel, and discharge cabinets, and fan motor leads. [Step.1, Step.2, and "3)" of Step.5] 2) Remove the flange nut fixing the fan motor and propeller fan. (Fig. 11-1) <ul style="list-style-type: none"> • Turn the flange nut clockwise to loosen it. (To tighten it, turn it counterclockwise.) 3) Remove the propeller fan. 4) Remove the fan motor leads from the motor base. (Fig. 11-2, 11-3) 5) Hold the fan motor and remove the 4 fixing screws so that the fan motor does not fall off. (Fig. 11-2, 11-3) <p>2. Attachment</p> <ol style="list-style-type: none"> 1) Install it in the reverse of the procedure to remove it. Bundle the upper and lower fan motor leads with commercially available cable ties. (Fig. 11-4) (1 positions) <ul style="list-style-type: none"> * If not bundled, the fan motor leads may come in contact with the propeller fan. <p>⚠ CAUTION</p> <ul style="list-style-type: none"> • Note that the wiring paths of the motor bases (upper and lower) are different. Also, make sure to arrange the lead wires such that water cannot get inside the mechanical compartment. • Tighten the flange nut by 4.9 N·m (50 kgf·cm). • Adjust the length of the fan motor leads at the inverter box to take up any excess slack and ensure that the fan motor leads do not come in contact with the propeller fan. • Be careful so that the heat exchanger and fan motor lead do not come into contact. 	<p>Turn the flange nut clockwise to loosen it.</p>  <p>Flange nut Propeller fan (Fig. 11-1)</p>  <p>Fan motor (upper) Screws (4 positions) Motor base Hooks (4 positions) (Fig. 11-2)</p>  <p>Motor base Fan motor (lower) Screws (4 positions) Hooks (5 positions) (Fig. 11-3)</p>  <p>Cable tie (Fig. 11-4)</p>

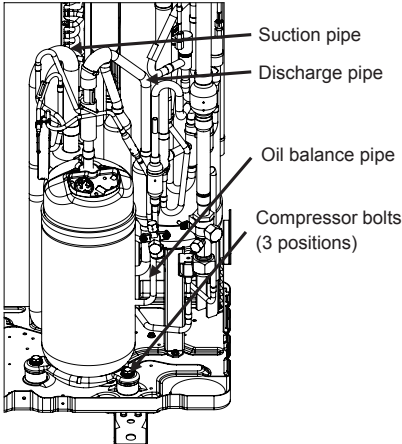
Step	Component	Procedure	Remarks
12	Compressor replacement	<p>1. Removing the malfunctioning compressor</p> <ol style="list-style-type: none"> 1) Collect the refrigerant gas with the recovery equipment. 2) Remove the front panels, upper panel, discharge cabinets, side panels, partition plate (upper), and inverter assembly. [Step.1, Step.2, Step.3, Step.4, and Step.5] 3) Remove the screws the inverter fixing plate (back), heat exchanger, and remove the inverter fixing plate (back). (M4×10, 2) (Fig. 12-1) 4) Remove the screws the partition plate and inverter fixing plate (lower), and remove the inverter fixing plate (lower). (M4×10, 3) (Fig. 12-1) 5) Remove the screws the packed valve and ball valve from the valve fixing plate. (hexagonal screws: M5×16, each 2) (Fig. 12-2) 6) Remove the screws the partition plate (lower) and valve fixing plate. (M4×10, 2) (Fig. 12-3) 7) Remove the sound-insulation mat (outside, inside). 8) Remove the screws the partition plate (lower), bottom plate, and heat exchanger (lower), and remove the partition plate (lower). (M4×10, 5) (Fig. 12-4) 9) Remove the TD sensor, TK sensor, TL3 sensor, binding band and pipe cover around the compressor. (Fig. 12-5) 10) Remove the pipe fixed rubber and the rubber sheet. (Fig. 12-6) 11) Remove the TO sensor, TE sensor, and binding band. (Fig. 12-6, 7) 	 <p>Inverter fixing plate (back) screws (2 positions)</p> <p>Inverter fixing plate (lower) screws (3 positions)</p> <p>(Fig. 12-1)</p>  <p>Valve fixing plate</p> <p>Ball valve</p> <p>Packed valve</p> <p>Hexagonal screws: M5×16,4</p> <p>(Fig. 12-2)</p>  <p>Valve fixing plate</p> <p>Partition plate (lower)</p> <p>(Fig. 12-3)</p>  <p>Partition plate (lower)</p> <p>(Fig. 12-4)</p>  <p>TK sensor TD sensor</p> <p>TL3 sensor</p> <p>(Fig. 12-5)</p>  <p>Pipe fixed rubber</p> <p>Rubber sheet</p> <p>TO sensor</p> <p>(Fig. 12-6)</p>  <p>TE sensor and binding band</p> <p>(Fig. 12-7)</p>

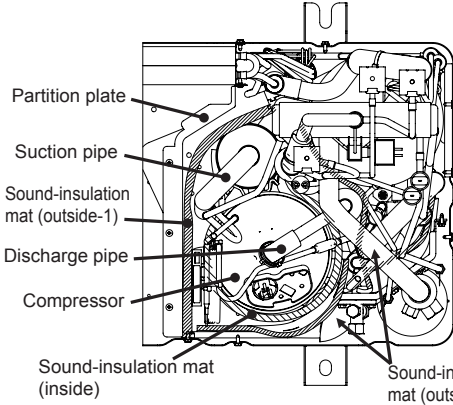
Step	Component	Procedure	Remarks
12	Compressor replacement (continued)	<p>12) Burn the connection parts of the SV4 pipe, oil balance pipe (suction pipe side) and discharge pipe with the burner, and remove. (3 positions) (Fig. 12-8)</p> <p>CAUTION</p> <ul style="list-style-type: none"> • Be careful when brazing by the burner to remove the pipes. Oil remaining in the pipes may generate fire when the brazing melts. • Apply protection to painted surfaces on the compressor and accumulator to prevent burning when brazing. <p>13) Cut the oil balance pipe (compressor side) at the instructed position. (Fig. 12-9)</p>  <p>(Fig. 12-9)</p> <p>CAUTION</p> <p>Burning the brazed areas of the oil balance pipe assembly with the burner before cutting the compressor oil balance pipe may cause a fire. (Fig. 12-9)</p> <p>14) Burn the brazed areas of the oil balance pipe with the burner, and remove. (1 position) (Fig. 12-10)</p>  <p>(Fig. 12-10)</p> <p>15) Burn the suction pipe (compressor side, accumulator side) and discharge pipe (compressor side) with the burner and remove its from compressor. (Fig. 12-11)</p> <p>* The SV3 connection piping is connected to the suction pipe, so when removing the suction pipe pay careful attention not to deform the SV3 connection piping. (Fig. 12-12)</p> <p>16) Remove the compressor bolts fixing the compressor to the bottom plate. (hexagonal bolts: M6×15, 3) (Fig. 12-12)</p> <p>* Recommended tool size when removing compressor bolt A (M6). (Fig. 12-12)</p> <ul style="list-style-type: none"> • When removing the bolt from the top panel side (ratchet type) (Fig. 12-13)  <p>(Fig. 12-13)</p> <ul style="list-style-type: none"> • When removing the bolt from the side panel side. (ratchet type) (Fig. 12-14)  <p>(Fig. 12-14)</p> <p>17) Pull out the compressor.</p> <p>CAUTION</p> <p>The compressor weighs over 20 kg. Two persons should work together.</p>	 <p>(Fig. 12-8)</p>  <p>(Fig. 12-11)</p>  <p>(Fig. 12-12)</p>

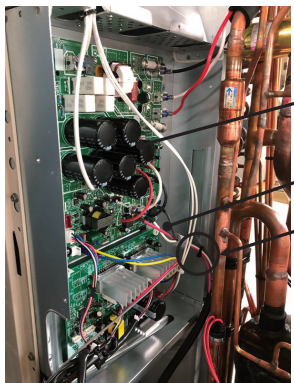
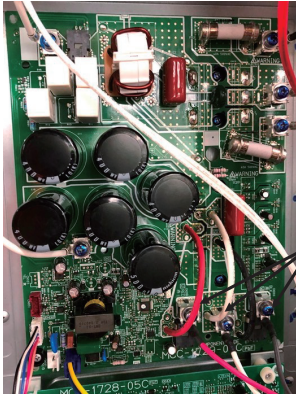
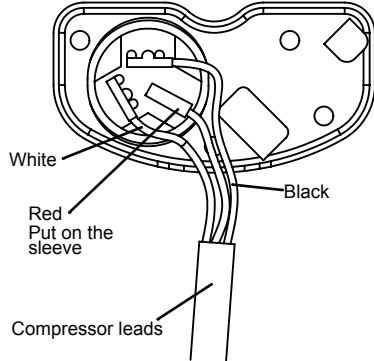
Step	Component	Procedure	Remarks
13	Compressor installation	<p>1. Installation of compressor</p> <p>1) Mount the new compressor and secure with the compressor bolts. (Fig. 13-1)</p> <hr/> <p>CAUTION</p> <p>The tightening torque of the hexagonal bolt to fix the compressor is 11.0 N·m (110 Kgf·cm).</p> <hr/> <p>2) Braze discharge pipe, suction pipe, and oil balance pipe. (Fig. 13-1)</p> <p>2. Vacuuming</p> <p>1) Connect the vacuum pump to the valve charge ports on the liquid and gas pipes.</p> <p>2) Vacuum until the vacuum low-pressure gauge indicates -755 mmHg.</p> <hr/> <p>CAUTION</p> <p>Before vacuuming, open PMV1 fully. Vacuuming of the outdoor heat exchanger will not occur if PMV1 is closed.</p> <hr/> <p>Method of opening compulsion of PMV1 completely</p> <ul style="list-style-type: none"> • Turn on the power to the outdoor unit. • Short CN300 on I/F P.C. board. • Turn off the power to the outdoor unit within 2 minutes of short-circuiting. <p>3. Refrigerant charging</p> <p>Add the same amount of refrigerant as the remaining refrigerant from the charge port of the valve.</p>	 <p>(Fig. 13-1)</p>

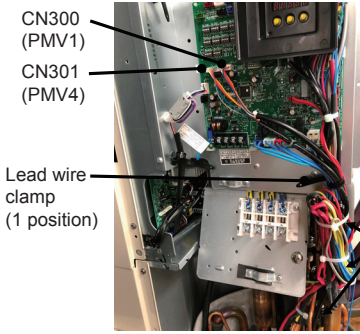

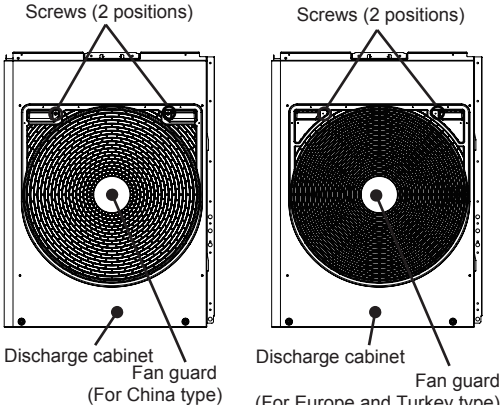
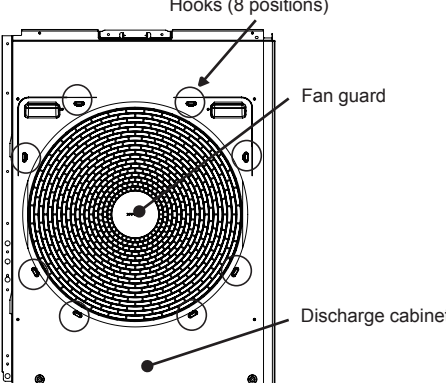
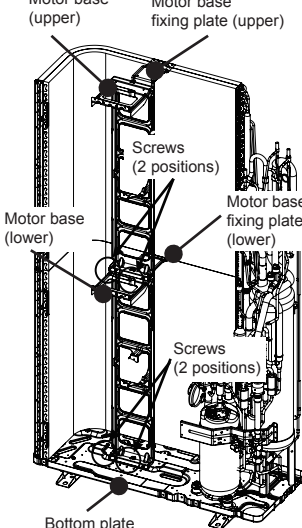
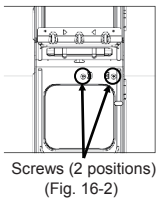

Step	Component	Procedure	Remarks
13	Compressor installation (continued)	<p>4. Installation of sound-insulation mat</p> <ol style="list-style-type: none"> 1) Fix the sound insulation mat (inside) around the compressor. (Fig. 13-2) 2) Fix the sound insulation mat (outside-1) between the partition plate and suction pipe. (Fig. 13-2) 3) Fix the sound insulation mat (outside-2) between the valve fixing plate and the sound insulation mat (inside). (Fig. 13-2) 4) Fix the sound insulation mat (outside-2) between the accumulator and the sound insulation mat (inside). (Fig. 13-2) 5) Fix the sound insulation mat (outside-2) to the pipe with banding band. (Fig. 13-3) <p>5. Replace compressor lead lines</p> <p>When replacing the compressor, it is necessary to replace the lead lines to prevent damage to the terminals.</p> <ol style="list-style-type: none"> 1) Remove the interface P.C.board attachment plate, noise filter P.C.board attachment plate, and inverter cover. ("1" to "7") of Step8) 2) Remove the binding band of lead lines and metal plate. (Fig. 13-4) 3) Remove the compressor lead line (red, white, black) screws from the comp-IPDU P.C board. (Fig. 13-5) CN201...Compressor lead (red) CN202...Compressor lead (white) CN203...Compressor lead (black) (M5×10, 1 each) 4) Fasten the attached new compressor lead lines to comp-IPDU P.C. board with a torque wrench. (Tightening torque: 1.8Nm) (Fig.13-5) 5) Attach the lead to the compressor. Please make sure to put the correct place. (Fig.13-6) <p>6) Install all parts Install all parts in the reverse of the procedure to remove it.</p>	 <p>(Fig. 13-2)</p>  <p>(Fig. 13-3)</p>  <p>(Fig. 13-4)</p>  <p>(Fig. 13-5)</p>  <p>(Fig. 13-6)</p>

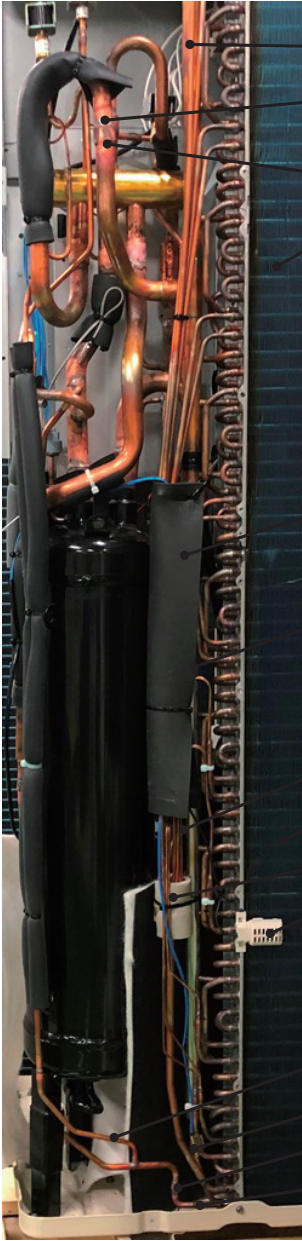
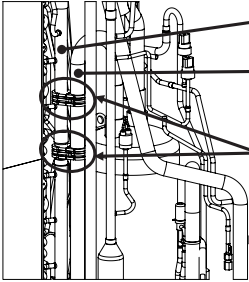
Step	Component	Procedure	Remarks
14	PMV1 coil PMV4 coil	<p>1. Detachment</p> <ol style="list-style-type: none"> 1) Remove the front panels. [Step.1] 2) Remove the connector connected between the interface P.C. board and PMV coil (PMV1 coil or PMV4 coil). <p>⚠ CAUTION</p> <hr/> <p>Disengage the locks on the housing to unplug the connectors.</p> <hr/> <p>CN300 ...PMV1 coil (6P: white) CN301 ...PMV4 coil (6P: white)</p> <ol style="list-style-type: none"> 3) Remove the lead wire from the lead wire clamp (1 position) and the banding bands. (Fig 14-1) 4) Rotate the coil, and remove while pulling it up after the fingernail is removed. (Fig. 14-2) <p>2. Attachment</p> <ol style="list-style-type: none"> 1) Match the positioning extrusion of the coil surely to the concavity of PMV body to fix it. <p>⚠ CAUTION</p> <hr/> <p>Using a banding band on the market, be sure to fix the lead wire.</p> <hr/>	 <p>CN300 (PMV1) CN301 (PMV4) Lead wire clamp (1 position) Banding bands</p> <p>(Fig. 14-1)</p>  <p>PMV4 coil PMV1 coil</p> <p>(Fig. 14-2)</p>

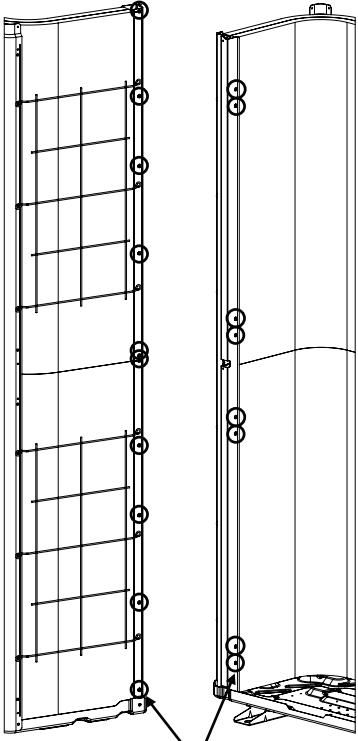
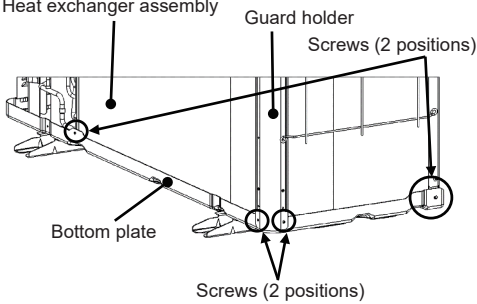
Step	Component	Procedure	Remarks
15	Fan guard	<p>1. Detachment</p> <p>1) Remove the discharge cabinets. [Step.2]</p> <p>⚠ CAUTION</p> <p>For scratch protection, work on a carton box, cloth, or the like.</p> <p>2) Remove the screws from the discharge cabinet and fan guard knob. (M4×10, 2) (Fig. 15-1)</p> <p>3) Remove the hooks (8 positions) of the fan guard by pushing it with a flat-head driver or the like. (Fig. 15-2, 15-3)</p> <p>4) Remove the fan guard from the discharge cabinet.</p> <p>2. Attachment</p> <p>1) Insert the upper protrusion of the fan guard into the square hole of the discharge cabinet, and insert the hooks (8 positions).</p> <p>2) Install the two screws in their original positions.</p> <p>⚠ CAUTION</p> <p>Confirm that all the hooks are securely fixed to specified positions.</p>  <p>(Fig. 15-3)</p>	 <p>(Fig. 15-1)</p>  <p>(Fig. 15-2)</p>
16	Heat exchanger assembly	<p>1. Detachment</p> <p>1) Collect the refrigerant gas with the recovery equipment.</p> <p>2) Remove the screw of the inverter assembly, etc. [Step.5]</p> <p>3) Remove the screws fixing the motor base (upper) and motor base (lower), and remove the motor base (upper). (M4×10, 2) (Fig. 16-1)</p> <p>4) Remove the screws fixing the motor base (lower), bottom plate and motor base fixing plate (lower), and remove the motor base (lower). (M4×10, 4) (Fig. 16-1,16-2)</p>	 <p>(Fig. 16-1)</p>  <p>(Fig. 16-2)</p>

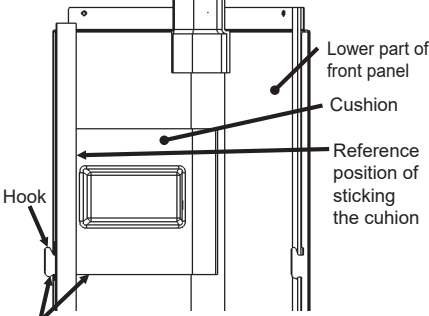
Step	Component	Procedure	Remarks
16	Heat exchanger assembly (continued)	<p>5) Remove the TO sensor holder , TE sensor holder, and binding band to fix it. (Fig. 16-3)</p> <p>6) Remove the pipe fixing rubber (2 positions), rubber sheet, and the binding bands. (Fig.16-3) (Fig.16-4)</p> <p>7) Using the burner, remove the header and heat exchanger 4-way valve connecting pipe (Fig. 16-3))</p> <p>8) Using the burner, remove the liquid pipe and heat exchanger connecting pipe. (Fig. 16-3)</p> <p>CAUTION</p> <p>Pay careful attention when removing the pipes by passing the burner over the brazed areas since if there is any oil inside the pipes, flames may shoot out at the very moment when the brazing melts.</p> <p>9) Pull the heat exchanger 4-way valve connecting pipe and liquid pipe upward, and draw them out.</p> <p>10) Using the burner, remove the distributor assembly which is connected to the heat exchanger assembly. (Fig. 16-4)</p> <p>11) Using the burner, remove the header (upper) and header (lower). (Fig. 16-4)</p>	 <p>(Fig. 16-3)</p>  <p>(Fig. 16-4)</p>

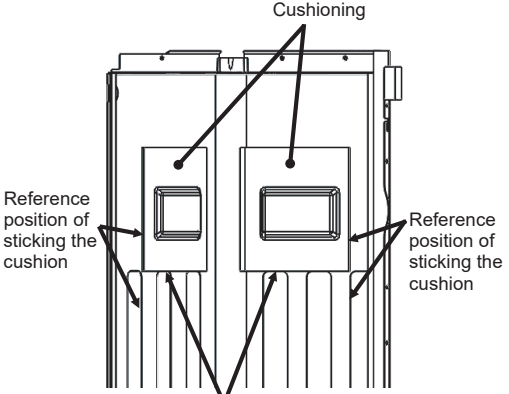
Step	Component	Procedure	Remarks
16	Heat exchanger assembly (continued)	<p>12) Remove the screws of the condenser coupling plate and heat exchanger assembly. (M4×10,18) (Fig. 16-5)</p> <p>13) Remove the screws of the bottom plate and heat exchanger assembly. (M4×10, 2) (Fig. 16-6)</p> <p>CAUTION</p> <ul style="list-style-type: none"> • Carry out the work with the number of individuals which is sufficient to avoid danger and ensure safety. • Be careful to ensure that the pipes will not be deformed as a result of applying force to them. • Be careful to avoid injury as a result of contact with the heat exchanger fins and sheet metal parts. <p>14) Remove the screws of the guard holder and bottom plate. (M4×10,2) (Fig. 16-6)</p> <p>15) Replace the heat exchanger assembly.</p> <p>2. Heat exchanger assembly installation</p> <p>1) Install the assembly by following the procedure or its removal in reverse.</p>	 <p>Condenser coupling plate screws (18 positions) (Fig. 16-5)</p>  <p>Heat exchanger assembly Guard holder Screws (2 positions)</p> <p>Bottom plate</p> <p>Screws (2 positions)</p> <p>(Fig. 16-6)</p>

Step	Component	Procedure	Remarks
17	Handle (Front panel)	<p>1. Detachment</p> <ol style="list-style-type: none"> 1) Remove the lower part of front panel. ["2" of Step.1] 2) Remove the cushion without tearing it. (Fig.17-1) 3) Use a flathead screwdriver or something to press on the 3 clamp hooks on the handle and remove it. (Fig.17-2) <p>2. Attachment</p> <ol style="list-style-type: none"> 1) install it in the reverse of the procedure to remove it. <ul style="list-style-type: none"> • The cushioning for the handles acts as waterproofing, so carefully stick it back on its original position so there are no gaps caused by it ripping or lifting up. • Refer to the fig.17-1 for the vertical and horizontal positions where the cushion is to be attached. 	 <p>Lower part of front panel Cushion Reference position of sticking the cushion Hook Reference position of sticking the cushion (Fig.17-1)</p>  <p>Flathead screwdriver Clamp hook (3 positions) (Fig.17-2)</p>
18	Handle (Side panel)	<p>1. Detachment</p> <ol style="list-style-type: none"> 1) Remove the lower part of side panel. [Step.3] 2) Remove the cushion without tearing it. (Fig.18-1) 3) Use a flathead screwdriver or something to press on the 3 clamp hooks on the handle and remove it. (Fig.18-2) <p>2. Attachment</p> <ol style="list-style-type: none"> 1) Install it in the reverse of the procedure to remove it. <ul style="list-style-type: none"> • The cushioning for the handles acts as waterproofing, so carefully stick it back on its original position so there are no gaps caused by it ripping or lifting up. • Refer to the fig.18-1 for the vertical and horizontal positions where the cushion is to be attached. 	 <p>Cushioning Reference position of sticking the cushion Reference position of sticking the cushion Reference position of sticking the cushion (Fig.18-1)</p>  <p>Flathead screwdriver Clamp hook (3 positions) (Fig.18-2)</p>

11 P.C. board exchange procedures

11-1. Interface P.C. board replacement procedure (MCC-1639:43H69066)

1. Applicable models

MCY-MHP0806HT8-(C)(CF)
 MCY-MHP0906HT8-(C)(CF)
 MCY-MHP1006HT8-(C)(CF)
 MCY-MHP0806HS8-(E)(TR)
 MCY-MHP1006HS8-(E)(TR)

2. Shipped parts list

Please make sure that before you do the work, the following parts are shipped all.

No	Parts name	Quantity
1	P.C. board Replacement Procedure Manual (English and Chinese each 1 page A4 paper double side print.)	1
2	Service P.C. board MCC-1639 -08C (Interface P.C. board) in Antistatic air cap	1

3. Replacement steps

- Turn off the power of the outdoor control unit. (Turn off the power of the outdoor unit.)
- Immediately after turning off the power of the outdoor unit, the electrolytic capacitors inside the unit will still have a high voltage, and there is a risk of electric shocks. Therefore, wait at least 5 minutes after turning off the power then start the replacement procedure.
- Disconnect all the connectors which are connected to the interface P.C. board.
(Since the connectors may be damaged if they are pulled out by grasping their lead wires, be sure to take hold of the connectors themselves when disconnecting them.)
- Remove the malfunctioning interface P.C. board, from the eight card edge spacers ①.
- Cut the jumper wires of the service P.C. board as indicated in the table below.
These settings are different from the settings for the jumpers on the P.C. board (malfunctioning board) prior to its replacement.
If the model setting is not selected, inspection code "L10" will be displayed, and the outdoor unit operation will remain stopped.

Model name	Jumper wires				
	J08	J09	J10	J11	J12
Service P.C. board Factory Default	Yes	Yes	Yes	Yes	Yes
MCY-MHP0806HT8-(C)(CF)	Disconnect	Disconnect	Leave intact	Leave intact	Leave intact
MCY-MHP0906HT8-(C)(CF)	Leave intact	Leave intact	Disconnect	Leave intact	Leave intact
MCY-MHP1006HT8-(C)(CF)	Disconnect	Leave intact	Disconnect	Leave intact	Leave intact
MCY-MHP0806HS8-(E)(TR)	Disconnect	Leave intact	Leave intact	Leave intact	Leave intact
MCY-MHP1006HS8-(E)(TR)	Leave intact	Disconnect	Leave intact	Leave intact	Leave intact

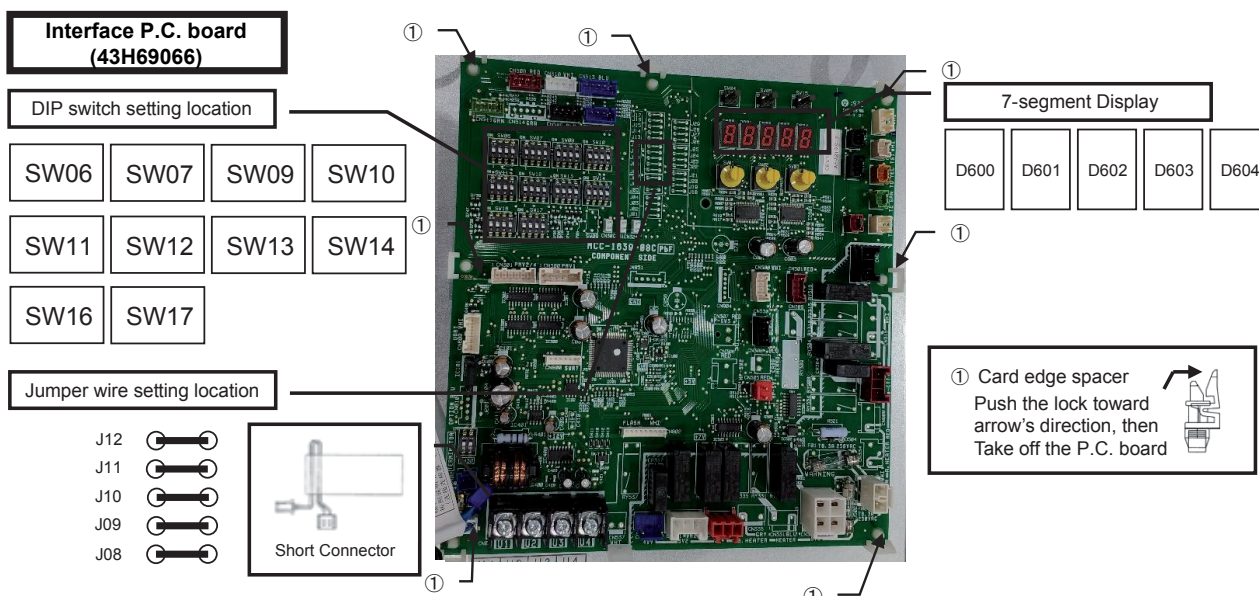

- Set the DIP switches of the service P.C. board to the settings used before replacement.
- The short connectors must be connected at the address setup stage. Therefore, when replacing the P.C. board, leave the shipment settings unchanged, and after having replaced the board, follow the instructions in section 8-4. "Address setup" in the service manual.
- After setting the jumper wires of the service P.C. board, install the board in the outdoor control unit.
(Check that the card edge spacers are securely fixed in place.)
- Connect the connectors of lead wires which were disconnected when the P.C. board was replaced, as shown on the wiring diagram display panel. (Check that the connectors have been inserted correctly and securely to prevent connection errors.)
- If any of the components on the P.C. board have been bent in the course of the replacing the board, rework them so that they do not come into contact with the other components.
- Install the cover, turn on the power, and check operation.

11-2. Comp-IPDU P.C. board replacement procedure (MCC-1729:43H69065)

1. Applicable models

MCY-MHP0806HT8-(C)(CF)
 MCY-MHP0906HT8-(C)(CF)
 MCY-MHP1006HT8-(C)(CF)
 MCY-MHP0806HS8-(E)(TR)
 MCY-MHP1006HS8-(E)(TR)

2. Shipped parts list

Please make sure that before you do the work, the following parts are shipped all.

No	Parts name	Quantity
1	P.C.board Replacement Procedure Manual (English 1 page and Chinese1 page A4 paper double side print)	1
2	Service P.C.board MCC-1729-05C (Comp-IPDU P.C. board) in Antistatic air cap	1
3	Card Spacer (No.①) in Plastic bag	2

3. Replacement steps

- Turn off the power of the outdoor control unit. (Turn off the power of the outdoor unit.)
- Immediately after turning off the power of the outdoor unit, the electrolytic capacitors inside the unit will still have a high voltage, and there is a risk of electric shocks. Therefore, wait at least 5 minutes after turning off the power before starting the replacement procedure.
- Disconnect all the screws ④ and screws ⑤ and connectors which are connected to the malfunctioning comp-IPDU P.C. board. (Since the connectors may be damaged if they are pulled out by grasping their lead wires, be sure to take hold of the connectors themselves when disconnecting them.)
- To remove the malfunctioning comp-IPDU P.C. board, remove the 2 card spacers ① and 2 single-touch spacers ② first. (Take care when removing the comp-IPDU P.C. board not to damage the 2 card spacers ①. If a card spacer ① has been damaged, be sure to use a ① card spacer packed with the board, and replace the damaged card spacer by following the steps in the service guide. Failure to replace it may cause the comp-IPDU P.C. board to malfunction.)
- The screws ③ ④ ⑤ and single-touch spacers ② which were removed will be used again when the service P.C. board is installed so keep them in a safe place to ensure that they will not be lost or misplaced.
- When replacing the board, install the removed single-touch spacers ② on the service P.C. board, and evenly apply silicone heat sink compound to the heat-sink surfaces of the IPM and rectifier devices on the service P.C. board. Then install the board in the outdoor control unit. Failure to apply the silicone heat sink compound may cause the service P.C. board to malfunction. **(Tightening torque for screws ③ (M4x14) used to secure single-touch spacers ②: 1.2±0.1 N·m)**
- When replacing the board, use the removed screws ③ (M4x14) screws ④ (M4x15) and screws ⑤ (M5x10) to connect the disconnected lead wires following the wiring diagram display panel. (Check that the wires have been inserted correctly and securely to prevent connection errors.)
- If screws ④ and screws ⑤ are not tightened sufficiently, the contact between the terminals will deteriorate, possibly causing malfunctioning so pay attention when tightening the screws. However, under no circumstances must power-driven screwdrivers or air screwdrivers be used when installing the replacement P.C. board using such a device may damage the components. **(Screw ③ ④ tightening torque: 1.2 ±0.1 N·m, Screw ⑤ tightening torque: 1.2 ±0.1 N·m)**
- If any of the components on the P.C. board have been bent in the course of the replacing the board, rework them so that they do not come into contact with the other components.
- Install the cover, turn on the power, and check operation.

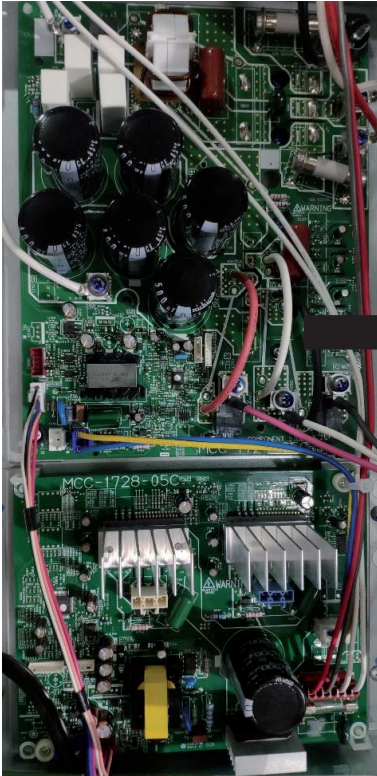

**Comp-IPDU P.C. board
(43H69065)**

① Card spacer

Hold it from the Two sides, and Remove the board.

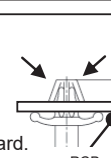

PCB

⑤ Screw (M5×10)
Be used to secure the lead wire to the reactor.
Tightening torque:
1.8 ±0.1 N·m

② Single-touch spacer
③ Screw (M4×14)
Torque: 1.2±0.1 N·m

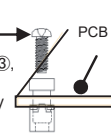

Remove the screw③, Then take off the P.C.board assembly

PCB

⑤ Screw (M5×10)
Be used to secure the lead wire of power input
torque: 1.8±0.1 N·m

④ Screw (M4×15)
Be used to secure the ceftifiers
torque: 1.2±0.1 N·m

⑤ Screw (M5×10)
Be used to secure Compressor's lead wire
Torque: 1.8±0.1 N·m

① Card spacer

Evenly apply the silicon heat sink compound to the heat-sink surfaces of the IPM and rectifier devices.
Caution: It must be ensured that no dust, etc. adheres to the heat-sink surfaces of the IPM and rectifier devices.

Standard for heat silicone heat sink compound:
Manufacturer: Shin-Etsu Chemical Co., Ltd.
Type: G746 or G747

11-3. Fan IPDU P.C. board replacement procedure (MCC-1728:43H69055)

1. Applicable models

- MCY-MHP0806HT8-(C)(CF)
- MCY-MHP0906HT8-(C)(CF)
- MCY-MHP1006HT8-(C)(CF)
- MCY-MHP0806HS8-(E)(TR)
- MCY-MHP1006HS8-(E)(TR)

2. Shipped parts list

Please make sure that before you do the work, the following parts are shipped all.

No	Parts name	Quantity
1	P.C.board Replacement Procedure Manual (English and Chinese each 4 page A3 paper double side print.)	1
2	Service P.C.board MCC-1728-05C(Fan IPDU P.C.board) in Antistatic air cap	1

3. Fan IPDU P.C. board setting

This same service P.C. board is used for both one fan and two fans. If the P.C. board assembly is to be replaced, check whether it is the board for one fan or two fans that will be replaced, set the dip switches as specified below, and then follow the replacement steps below to replace the board. If the dip switched are not set properly, inspection code "L29" will appear on the 7-segment display of the interface P.C. board, and the outdoor unit operation will remain stopped.

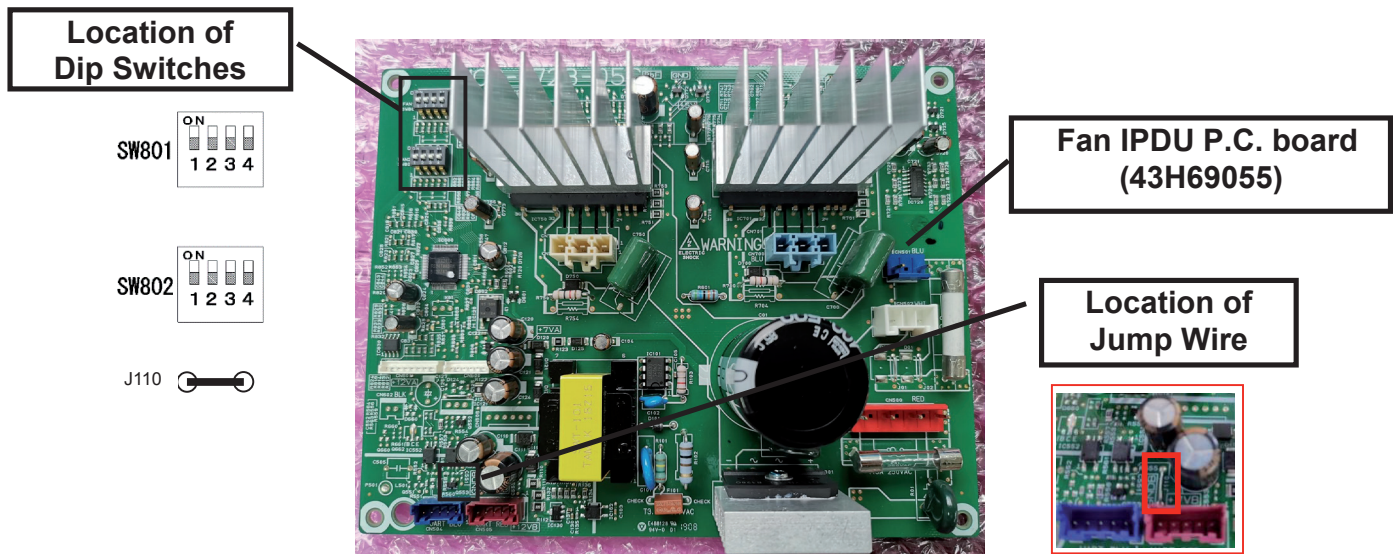

[Dip switches setting table]

Item	SW801				SW802				J110
	1	2	3	4	1	2	3	4	
Factory default	OFF	OFF	OFF	OFF	OFF	OFF	OFF	OFF	YES
For two fans	OFF	ON	OFF	OFF	ON	ON	OFF	OFF	Leave intact

4. Replacement steps

- (1) Turn off the power of the outdoor control unit. (Turn off the power of the outdoor unit.)
- (2) Immediately after turning off the power of the outdoor unit, the electrolytic capacitors inside the unit will still have a high voltage, and there is a risk of electric shocks. Therefore, wait at least 5 minutes after turning off the power then start the replacement procedure.

- (3) Disconnect all the screws ② and connectors which are connected to the malfunctioning fan IPDU P.C. board. (Since the connectors may be damaged if they are pulled out by grasping their lead wires, be sure to take hold of the connectors themselves when disconnecting them.)
- (4) Remove the malfunctioning fan IPDU P.C. board from the four card spacers ① and ②. (When removing the fan IPDU P.C. board, take care not to damage any of the four card spacers.)
- (5) The removed screws ③ will be used again when the service P.C. board is installed so keep them in a safe place to ensure that they will not be lost or misplaced.
- (6) When replacing the board, assemble the spacer ② onto the P.C.board, then install the board in the outdoor control unit (spacer②'s screw tightening torque: $0.55 \pm 0.1 \text{ N}\cdot\text{m}$).
- (7) Connect the disconnected lead wires following the wiring diagram display panel. (Check that the wires have been inserted correctly and securely to prevent connection errors.)
- (8) If any of the components on the P.C. board have been bent in the course of the replacing the board, rework them so that they do not come into contact with the other components.
- (9) Install the cover, turn on the power, and check operation.

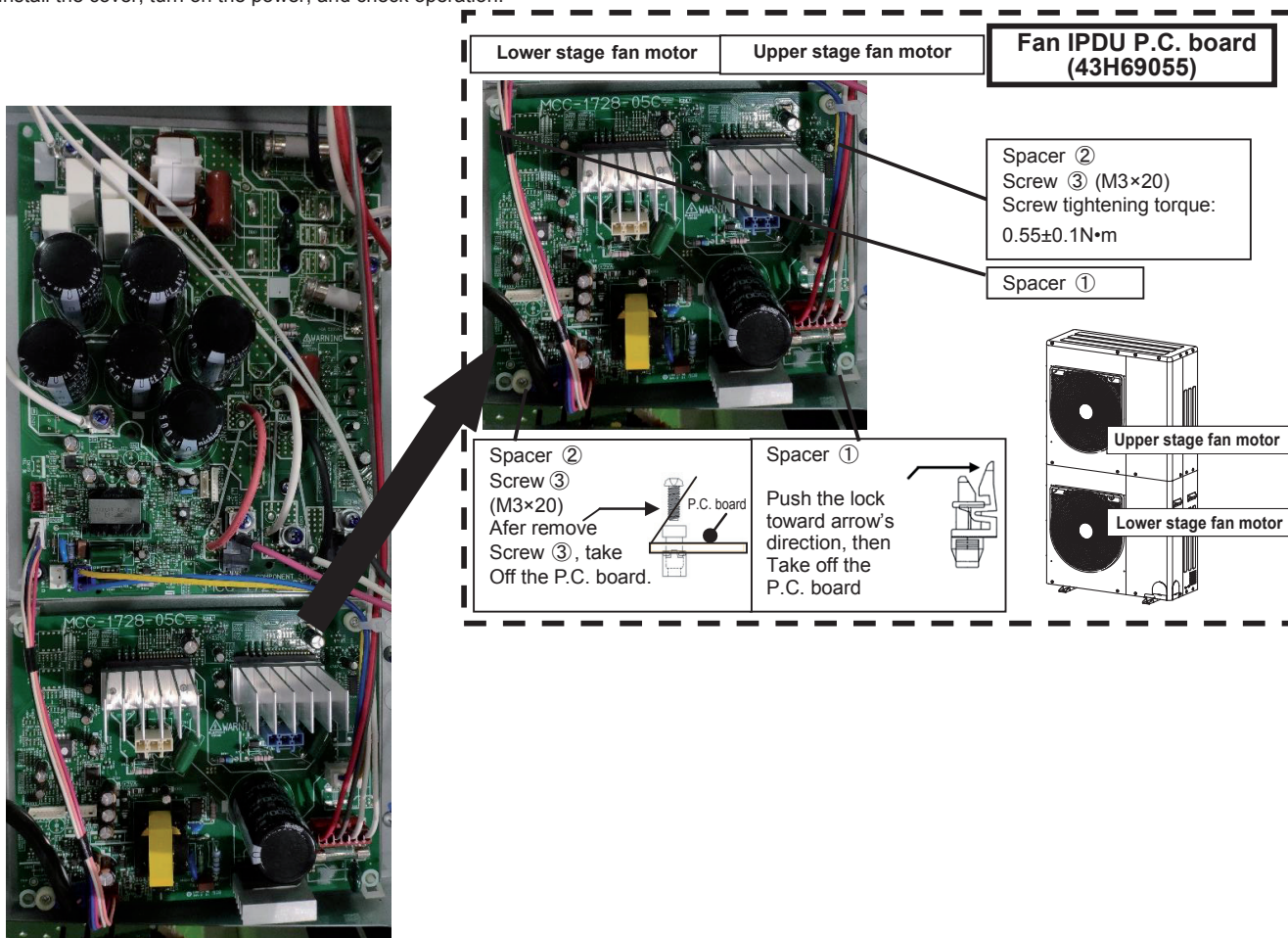

11-4. Noise filter P.C. board replacement procedure (MCC-1733:43H69057)

1. Applicable models

MCY-MHP0806HT8-(C)(CF)
 MCY-MHP0906HT8-(C)(CF)
 MCY-MHP1006HT8-(C)(CF)
 MCY-MHP0806HS8-(E)(TR)
 MCY-MHP1006HS8-(E)(TR)

2. Shipped parts list

Please make sure that before you do the work, the following parts are shipped all.

No	Parts name	Quantity
1	P.C. board Replacement Procedure Manual (English and Chinese each 1page A4 paper double side print.)	1
2	Service P.C. board MCC-1733-05C (Noisefilter P.C. board) in Antistatic air cap	1

3. Replacement steps

- (1) Turn off the power of the outdoor control unit. (Turn off the power of the outdoor unit.)
- (2) Immediately after turning off the power of the outdoor unit, the electrolytic capacitors inside the unit will still have a high voltage, And there is a risk of electric shocks. Therefore, wait at least 5 minutes after turning off the power before starting the replacement procedure.
- (3) Disconnect all the screws ④ and connectors which are connected to the malfunctioning noise filter P.C. board.
(Since the connectors may be damaged if they are pulled out by grasping their lead wires, be sure to take hold of the connectors themselves when disconnecting them.)
- (4) To remove the malfunctioning noise filter P.C. board, remove the two card edge spacers ① and two single-touch spacers ② first.
- (5) The screws ③ ④ and single-touch spacers ② which were removed will be used again when the service P.C. board is installed so keep them in a safe place to ensure that they will not be lost or misplaced.
- (6) When replacing the board, install the removed single-touch spacers ② on the service P.C. board, and install the board in the outdoor control unit.
(Tightening torque for screws ③ (M3x20) used to secure single-touch spacers ②: 0.55 ±0.1 N•m)
- (7) When replacing the board, use the removed screws ④ (M4x8) to connect the disconnected lead wires following the wiring diagram display panel.
(Check that the wires have been inserted correctly and securely to prevent connection errors.)
- (8) If screws ④ are not tightened sufficiently, the contact between the terminals will deteriorate, possibly causing malfunctioning so pay attention when tightening the screws. However, under no circumstances must power driven screwdrivers or air screwdrivers be used when installing the replacement P.C. board using such a device may damage the components. **(Screw ④ tightening torque: 1.2 ±0.1 N•m)**
- (9) If any of the components on the P.C. board have been bent in the course of the replacing the board, rework them so that they do not come into contact with the other components.
- (10) Install the cover, turn on the power, and check operation.

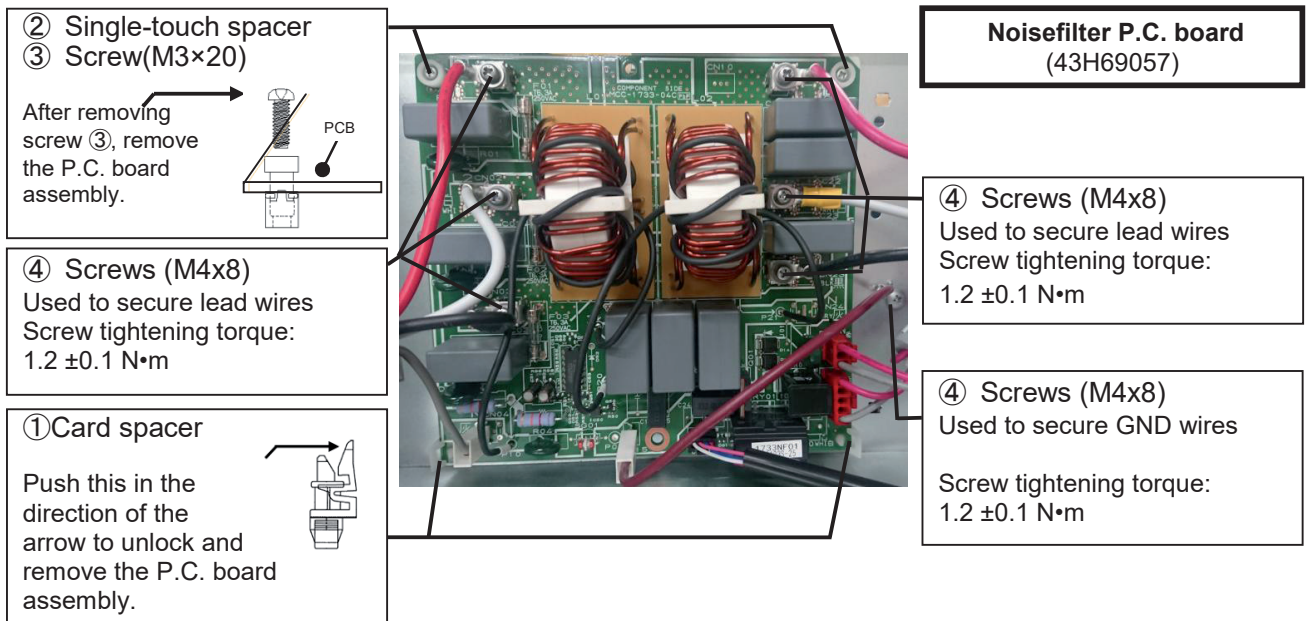

12 Exploded diagram / parts list

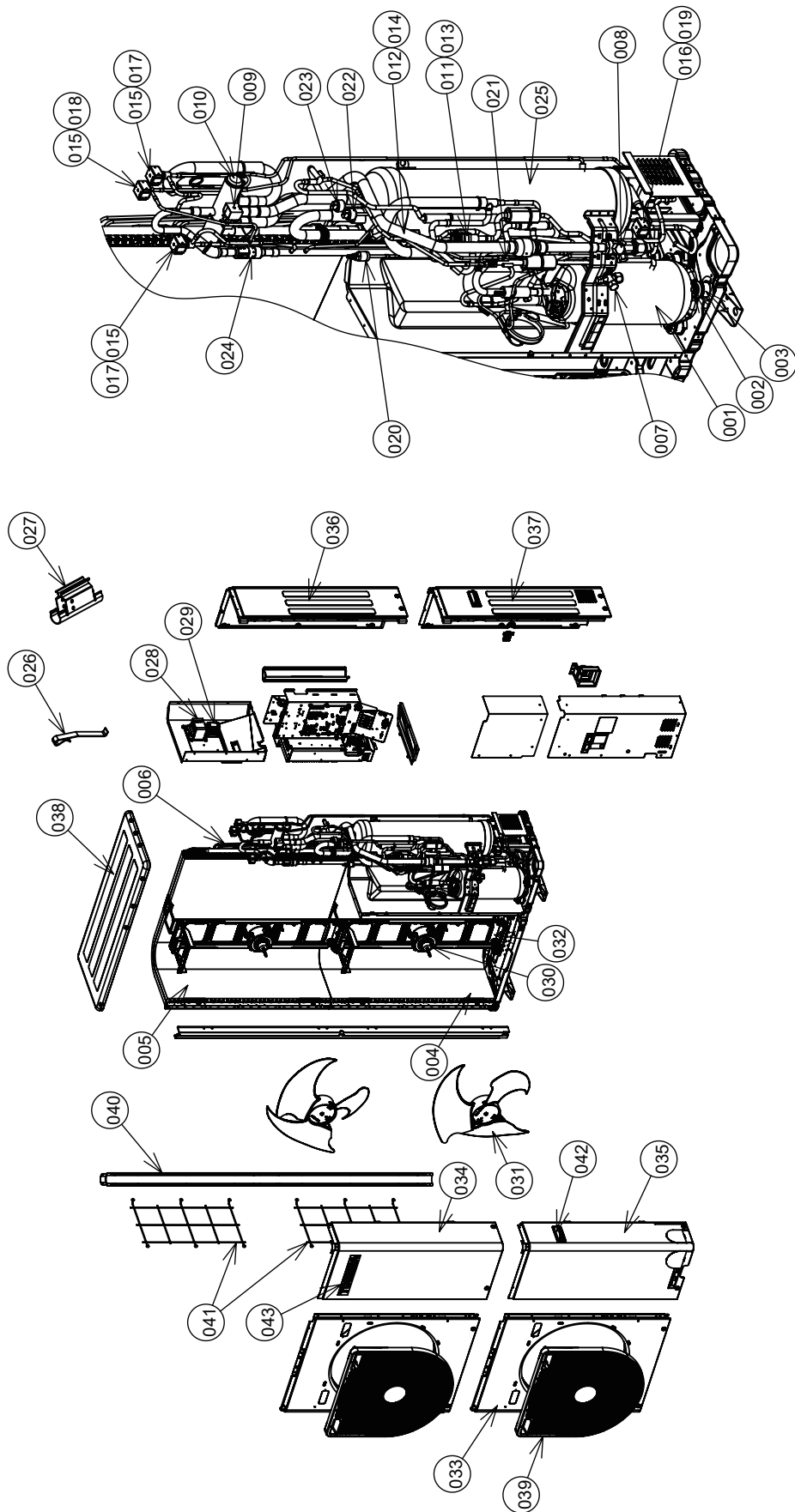

Ref.No.	Part.No.	Description	Q'ty/Set MCY-MHP									
			0806HS8-E	1006HS8-E	0806HS8-TR	1006HS8-TR	0806HT8-C	0906HT8-C	1006HT8-C	0806HT8-CF	0906HT8-CF	1006HT8-CF
1	43H41602	COMPRESSOR, RA641A3TB-22M	1	1	1	1	1	1	1	1	1	1
2	43H97003	BOLT, COMPRESSOR	3	3	3	3	3	3	3	3	3	3
3	43H42002	RUBBER, CUSHION	3	3	3	3	3	3	3	3	3	3
4	43H43054	CONDENSER ASSY, LOWER	1	1	1	1	1	1	1	1	1	1
5	43H43055	CONDENSER ASSY, UP	1	1	1	1	1	1	1	1	1	1
6	43H43056	DISTRIBUTOR ASSY	1	1	1	1	1	1	1	1	1	1
7	43H46027	VALVE, PACKED, 9.52DIA	1	1	1	1	1	1	1	1	1	1
8	43H46040	VALVE, BALL, 19.05DIA	1	1	1	1	1	1	1	1	1	1
9	43H46045	COIL, 4WAY	1	1	1	1	1	1	1	1	1	1
10	43H46046	VALVE, 4WAY	1	1	1	1	1	1	1	1	1	1
11	43H43028	COIL, PMV	1	1	1	1	1	1	1	1	1	1
12	43H46061	COIL, PMV	1	1	1	1	1	1	1	1	1	1
13	43H43029	BODY, PMV	1	1	1	1	1	1	1	1	1	1
14	43H46063	BODY, PMV	1	1	1	1	1	1	1	1	1	1
15	43H46016	COIL, 2WAY	3	3	3	3	3	3	3	3	3	3
16	43H43030	COIL, 2WAY	1	1	1	1	1	1	1	1	1	1
17	43H46017	VALVE, 2WAY, FDF3A08	2	2	2	2	2	2	2	2	2	2
18	43H46018	VALVE, 2WAY, FDF2A88	1	1	1	1	1	1	1	1	1	1
19	43H43031	VALVE, 2WAY, TEV-S1920DQ50	1	1	1	1	1	1	1	1	1	1
20	43H51004	SWITCH, PRESSURE ACB-4UB154W	1	1	1	1	1	1	1	1	1	1
21	43H46019	JOINT, CHECK	2	2	2	2	2	2	2	2	2	2
22	43H51007	SENSOR ASSY, LOW PRESSURE	1	1	1	1	1	1	1	1	1	1
23	43H51008	SENSOR ASSY, HIGH PRESSURE	1	1	1	1	1	1	1	1	1	1
24	43H46020	VALVE, CHECK	1	1	1	1	1	1	1	1	1	1
25	43H48019	TANK	1	1	1	1	1	1	1	1	1	1
26	43H63003	HOLDER, SENSOR	1	1	1	1	1	1	1	1	1	1
27	43H19010	HOLDER, SENSOR (TS)	6	6	6	6	6	6	6	6	6	6
28	43H58017	REACTOR, CH-90	1	1	1	1	1	1	1	1	1	1
29	43H43033	REACTOR, CH-98	1	1	1	1	1	1	1	1	1	1
30	43H21010	MOTOR, FAN, ICF-280-A100-1	2	2	2	2	2	2	2	2	2	2
31	43H20012	FAN, PROPELLER, PP501	2	2	2	2	2	2	2	2	2	2
32	43H22017	BASE, ASSY, MOTOR	2	2	2	2	2	2	2	2	2	2
33	43H00031	PANEL, ASSY, OUT	2	2	2	2	2	2	2	2	2	2
34	43H00039	PANEL, ASSY, FRONT, UP	1	1	1	1	1	1	1	1	1	1
35	43H43034	PANEL, ASSY, FRONT, LOWER	1	1	1	1	1	1	1	1	1	1
36	43H02007	PANEL, ASSY, SIDE, UP	1	1	1	1	1	1	1	1	1	1
37	43H43035	PANEL, ASSY, SIDE, LOWER	1	1	1	1	1	1	1	1	1	1
38	43H00020	PANEL, ASSY, TOP	1	1	1	1	1	1	1	1	1	1
39	43H19004	GUARD, FAN					2	2	2	2	2	2
	43H19014	GUARD, FAN	2	2	2	2						
40	43H19019	PLATE, STAY	1	1	1	1	1	1	1	1	1	1
41	43H07004	GUARD, FIN, SIDE	2	2	2	2	2	2	2	2	2	2
42	43H07005	HANDLE	3	3	3	3	3	3	3	3	3	3
43	43H15002	MARK, TOSHIBA					1	1	1	1	1	1
	43H15004	MARK, TOSHIBA, MiNi-SMMS	1	1	1	1						

Inverter assembly

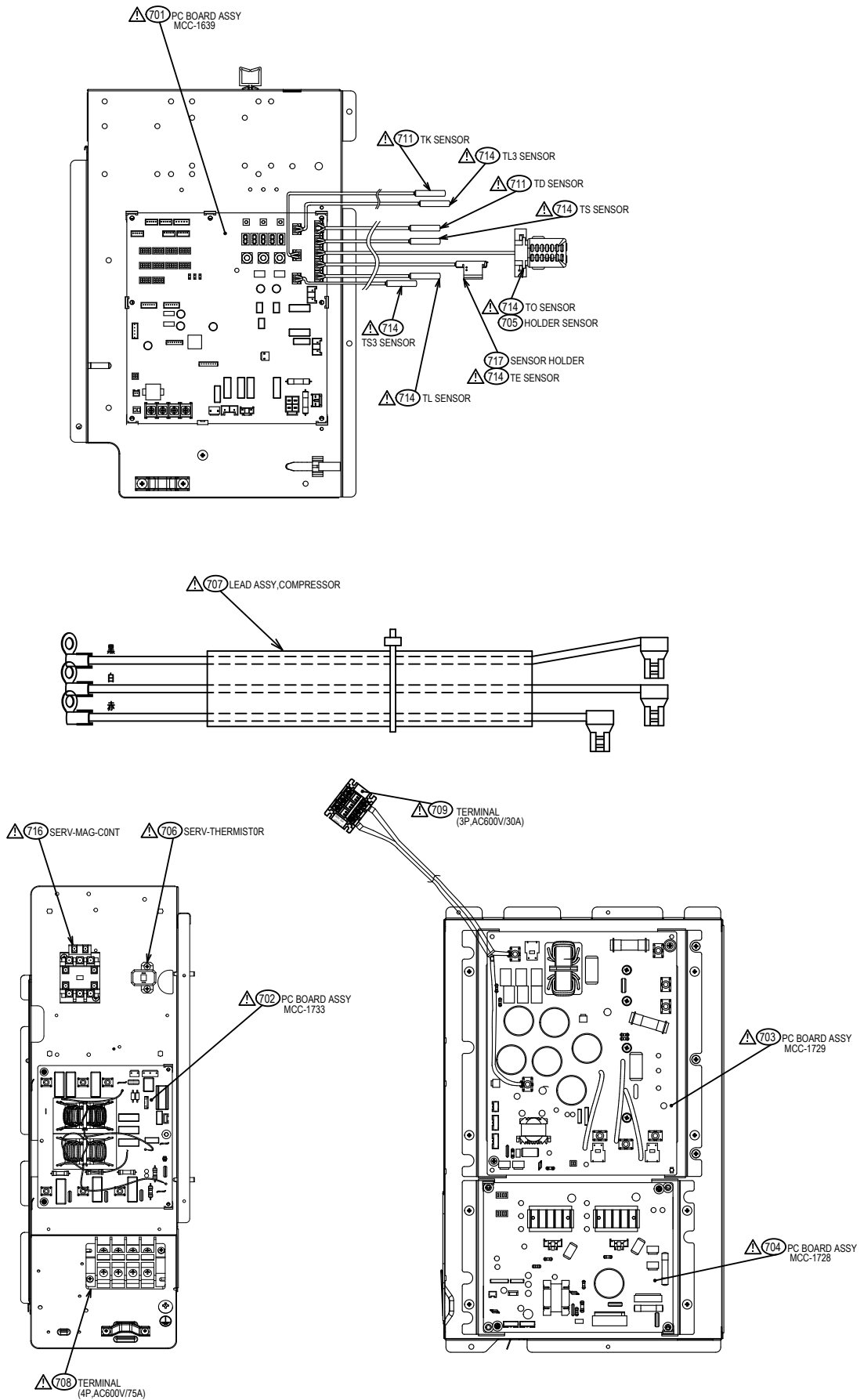

Ref.No.	Part No.	Description	Q'ty/Set MCY-MHP				
			****HT8-C(CF)			****HS8-E(TR)	
			0806	0906	1006	0806	1006
701	43H69066	PC BOARD ASSY,INTERFACE,MCC-1639	1	1	1	1	1
702	43H69057	PC BOARD ASSY,NOISE-FILTER,MCC-1733	1	1	1	1	1
703	43H69065	PC BOARD ASSY,COMP-IPDU,MCC-1729	1	1	1	1	1
704	43H69055	PC BOARD ASSY,FAN-IPDU,MCC-1728	1	1	1	1	1
705	43H50001	HOLDER SENSOR(TO)	1	1	1	1	1
706	43H53001	THERMISTOR,PTC	1	1	1	1	1
707	43H60029	LEAD ASSY,COMPRESSOR	1	1	1	1	1
708	43H60002	TERMINAL,4P(AC600V/75A)	1	1	1	1	1
709	43H60016	TERMINAL,3P(AC600V/30A)	1	1	1	1	1
711	43H50034	SENSOR,TD	2	2	2	2	2
714	43H50005	SENSOR	6	6	6	6	6
716	43H52002	CONTACTOR,MAGNETIC(CLK-26L)	1	1	1	1	1
717	43H50026	HOLDER SENSOR(TE)	1	1	1	1	1

WARNINGS ON REFRIGERANT LEAKAGE

Check of Concentration Limit

The room in which the air conditioner is to be installed requires a design that in the event of refrigerant gas leaking out, its concentration will not exceed a set limit. The refrigerant R410A which is used in the air conditioner is safe, without the toxicity or combustibility of ammonia, and is not restricted by laws to be imposed which protect the ozone layer. However, since it contains more than air, it poses the risk of suffocation if its concentration should rise excessively. Suffocation from leakage of R410A is almost non-existent. With the recent increase in the number of high concentration buildings, however, the installation of multi air conditioner systems is on the increase because of the need for effective use of floor space, individual control, energy conservation by curtailing heat and carrying power etc. Most importantly, the multi air conditioner system is able to replenish a large amount of refrigerant compared with conventional individual air conditioners. If a single unit of the multi conditioner system is to be installed in a small room, select a suitable model and installation procedure so that if the refrigerant accidentally leaks out, its concentration does not reach the limit (and in the event of an emergency, measures can be made before injury can occur). In a room where the concentration may exceed the limit, create an opening with adjacent rooms, or install mechanical ventilation combined with a gas leak detection device. The concentration is as given below.

$$\frac{\text{Total amount of refrigerant (kg)}}{\text{Min. volume of the indoor unit installed room (m}^3\text{)}} \leq \text{Concentration limit (kg/m}^3\text{)}$$

The concentration limit of R410A which is used in multi air conditioners is 0.3kg/m^3 .

NOTE 1 :

If there are 2 or more refrigerating systems in a single refrigerating device, the amounts of refrigerant should be as charged in each independent device.

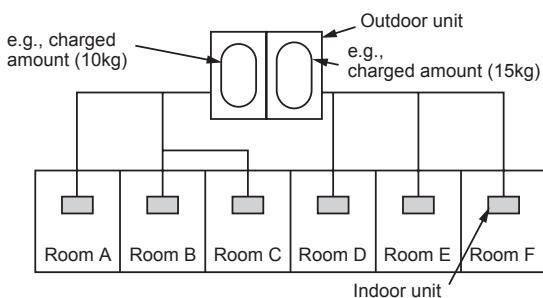

For the amount of charge in this example:
 The possible amount of leaked refrigerant gas in rooms A, B and C is 10kg.
 The possible amount of leaked refrigerant gas in rooms D, E and F is 15kg.

Important

NOTE 2 :

The standards for minimum room volume are as follows.
 (1) No partition (shaded portion)

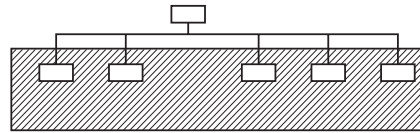

(2) When there is an effective opening with the adjacent room for ventilation of leaking refrigerant gas (opening without a door, or an opening 0.15% or larger than the respective floor spaces at the top or bottom of the door).

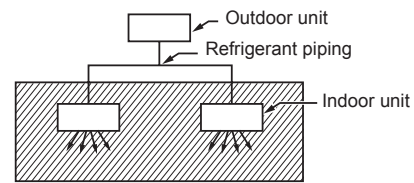

(3) If an indoor unit is installed in each partitioned room and the refrigerant piping is interconnected, the smallest room of course becomes the object. But when a mechanical ventilation is installed interlocked with a gas leakage detector in the smallest room where the density limit is exceeded, the volume of the next smallest room becomes the object.

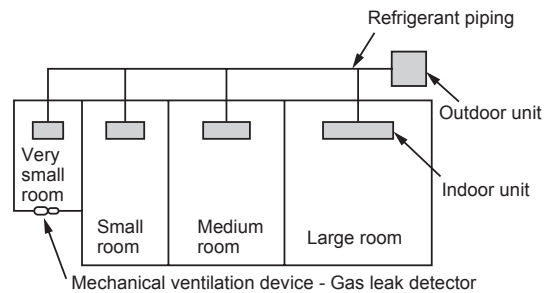

NOTE 3 :

The minimum indoor floor area compared with the amount of refrigerant is roughly as follows:
 (When the ceiling is 2.7m high)

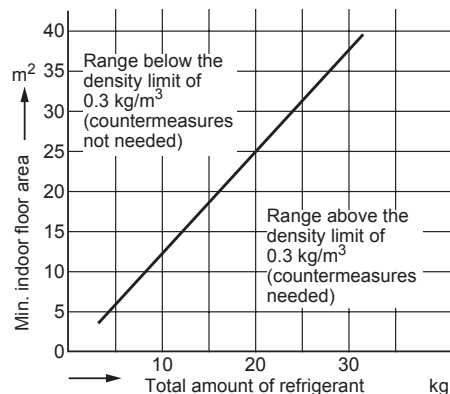

TOSHIBA CARRIER CORPORATION