

TOSHIBA

FILE NO. SVM-16041-4

SERVICE MANUAL

AIR-CONDITIONER

(MULTI TYPE)

INDOOR UNIT

<4-way cassette type>

MMU-AP0094HP1-E (TR)

MMU-AP0124HP1-E (TR)

MMU-AP0154HP1-E (TR)

MMU-AP0184HP1-E (TR)

MMU-AP0244HP1-E (TR)

MMU-AP0274HP1-E (TR)

MMU-AP0304HP1-E (TR)

MMU-AP0364HP1-E (TR)

MMU-AP0484HP1-E (TR)

MMU-AP0564HP1-E (TR)



Original instruction

Adoption of New Refrigerant

This Air Conditioner is a new type which adopts a new refrigerant HFC (R410A) instead of the conventional refrigerant R22 in order to prevent destruction of the ozone layer.

CONTENTS

SAFETY CAUTION3
1. CONSTRUCTION VIEWS (EXTERNAL VIEWS)15
1-1. MMU-AP0094HP1*, AP0124HP1*15
1-2. MMU-AP0154HP1*, AP0184HP1*16
1-3. MMU-AP0244HP1*, AP0274HP1*, AP0304HP1*17
1-4. MMU-AP0364HP1*, AP0484HP1*, AP0564HP1*18
2. WIRING DIAGRAM19
3. PARTS RATING20
4. REFRIGERATING CYCLE DIAGRAM21
5. CONTROL OUTLINE22
6. CONFIGURATION OF CONTROL CIRCUIT32
7. APPLIED CONTROL40
8. TROUBLESHOOTING57
9. DETACHMENTS89
10. P.C. BOARD EXCHANGE PROCEDURES100
11. EXPLODED VIEWS AND PARTS LIST105

SAFETY CAUTION

Please read carefully through these instructions that contain important information which complies with the “Machinery” Directive (Directive 2006/42/EC), and ensure that you understand them.

Generic Denomination: Air Conditioner

Definition of Qualified Installer or Qualified Service Person

The air conditioner must be installed, maintained, repaired and removed by a qualified installer or qualified service person. When any of these jobs is to be done, ask a qualified installer or qualified service person to do them for you.

A qualified installer or qualified service person is an agent who has the qualifications and knowledge described in the table below.

Agent	Qualifications and knowledge which the agent must have
Qualified installer	<ul style="list-style-type: none"> • The qualified installer is a person who installs, maintains, relocates and removes the air conditioners made by Toshiba Carrier Corporation. He or she has been trained to install, maintain, relocate and remove the air conditioners made by Toshiba Carrier Corporation or, alternatively, he or she has been instructed in such operations by an individual or individuals who have been trained and is thus thoroughly acquainted with the knowledge related to these operations. • The qualified installer who is allowed to do the electrical work involved in installation, relocation and removal has the qualifications pertaining to this electrical work as stipulated by the local laws and regulations, and he or she is a person who has been trained in matters relating to electrical work on the air conditioners made by Toshiba Carrier Corporation or, alternatively, he or she has been instructed in such matters by an individual or individuals who have been trained and is thus thoroughly acquainted with the knowledge related to this work. • The qualified installer who is allowed to do the refrigerant handling and piping work involved in installation, relocation and removal has the qualifications pertaining to this refrigerant handling and piping work as stipulated by the local laws and regulations, and he or she is a person who has been trained in matters relating to refrigerant handling and piping work on the air conditioners made by Toshiba Carrier Corporation or, alternatively, he or she has been instructed in such matters by an individual or individuals who have been trained and is thus thoroughly acquainted with the knowledge related to this work. • The qualified installer who is allowed to work at heights has been trained in matters relating to working at heights with the air conditioners made by Toshiba Carrier Corporation or, alternatively, he or she has been instructed in such matters by an individual or individuals who have been trained and is thus thoroughly acquainted with the knowledge related to this work.
Qualified service person	<ul style="list-style-type: none"> • The qualified service person is a person who installs, repairs, maintains, relocates and removes the air conditioners made by Toshiba Carrier Corporation. He or she has been trained to install, repair, maintain, relocate and remove the air conditioners made by Toshiba Carrier Corporation or, alternatively, he or she has been instructed in such operations by an individual or individuals who have been trained and is thus thoroughly acquainted with the knowledge related to these operations. • The qualified service person who is allowed to do the electrical work involved in installation, repair, relocation and removal has the qualifications pertaining to this electrical work as stipulated by the local laws and regulations, and he or she is a person who has been trained in matters relating to electrical work on the air conditioners made by Toshiba Carrier Corporation or, alternatively, he or she has been instructed in such matters by an individual or individuals who have been trained and is thus thoroughly acquainted with the knowledge related to this work. • The qualified service person who is allowed to do the refrigerant handling and piping work involved in installation, repair, relocation and removal has the qualifications pertaining to this refrigerant handling and piping work as stipulated by the local laws and regulations, and he or she is a person who has been trained in matters relating to refrigerant handling and piping work on the air conditioners made by Toshiba Carrier Corporation or, alternatively, he or she has been instructed in such matters by an individual or individuals who have been trained and is thus thoroughly acquainted with the knowledge related to this work. • The qualified service person who is allowed to work at heights has been trained in matters relating to working at heights with the air conditioners made by Toshiba Carrier Corporation or, alternatively, he or she has been instructed in such matters by an individual or individuals who have been trained and is thus thoroughly acquainted with the knowledge related to this work.

Definition of Protective Gear

When the air conditioner is to be transported, installed, maintained, repaired or removed, wear protective gloves and 'safety' work clothing.

In addition to such normal protective gear, wear the protective gear described below when undertaking the special work detailed in the table below.



Failure to wear the proper protective gear is dangerous because you will be more susceptible to injury, burns, electric shocks and other injuries.

Work undertaken	Protective gear worn
All types of work	Protective gloves 'Safety' working clothing
Electrical-related work	Gloves to provide protection for electricians and from heat Insulating shoes Clothing to provide protection from electric shock
Work done at heights (50 cm or more)	Helmets for use in industry
Transportation of heavy objects	Shoes with additional protective toe cap
Repair of outdoor unit	Gloves to provide protection for electricians and from heat

The important contents concerned to the safety are described on the product itself and on this Service Manual.



Please read this Service Manual after understanding the described items thoroughly in the following contents (Indications / Illustrated marks), and keep them.

[Explanation of indications]

Indication	Explanation
 DANGER	Indicates contents assumed that an imminent danger causing a death or serious injury of the repair engineers and the third parties when an incorrect work has been executed.
 WARNING	Indicates possibilities assumed that a danger causing a death or serious injury of the repair engineers, the third parties, and the users due to troubles of the product after work when an incorrect work has been executed.
 CAUTION	Indicates contents assumed that an injury or property damage (*) may be caused on the repair engineers, the third parties, and the users due to troubles of the product after work when an incorrect work has been executed.

* Property damage: Enlarged damage concerned to property, furniture, and domestic animal / pet

[Explanation of illustrated marks]







Indication	Explanation
	Indicates prohibited items (Forbidden items to do) The sentences near an illustrated mark describe the concrete prohibited contents.
	Indicates mandatory items (Compulsory items to do) The sentences near an illustrated mark describe the concrete mandatory contents.
	Indicates cautions (Including danger / warning) The sentences or illustration near or in an illustrated mark describe the concrete cautious contents.

Warning Indications on the Air Conditioner Unit

[Confirmation of warning label on the main unit]

Confirm that labels are indicated on the specified positions





If removing the label during parts replace, stick it as the original.

Warning indication		Description
	<p>WARNING</p> <p>ELECTRICAL SHOCK HAZARD Disconnect all remote electric power supplies before servicing.</p>	<p>WARNING</p> <p>ELECTRICAL SHOCK HAZARD Disconnect all remote electric power supplies before servicing.</p>
	<p>WARNING</p> <p>Moving parts. Do not operate unit with grille removed. Stop the unit before the servicing.</p>	<p>WARNING</p> <p>Moving parts. Do not operate unit with grille removed. Stop the unit before the servicing.</p>
	<p>CAUTION</p> <p>High temperature parts. You might get burned when removing this panel.</p>	<p>CAUTION</p> <p>High temperature parts. You might get burned when removing this panel.</p>
	<p>CAUTION</p> <p>Do not touch the aluminium fins of the unit. Doing so may result in injury.</p>	<p>CAUTION</p> <p>Do not touch the aluminium fins of the unit. Doing so may result in injury.</p>
	<p>CAUTION</p> <p>BURST HAZARD Open the service valves before the operation, otherwise there might be the burst.</p>	<p>CAUTION</p> <p>BURST HAZARD Open the service valves before the operation, otherwise there might be the burst.</p>
	<p>CAUTION</p> <p>Do not climb onto the fan guard. Doing so may result in injury.</p>	<p>CAUTION</p> <p>Do not climb onto the fan guard. Doing so may result in injury.</p>



PRECAUTIONS FOR SAFETY







The manufacturer shall not assume any liability for the damage caused by not observing the description of this manual.







DANGER



 Turn off braeaker	Before carrying out the installation, maintenance, repair or removal work, be sure to set the circuit breaker for both the indoor and outdoor units to the OFF position. Otherwise, electric shocks may result.
	Before opening the electrical box cover of the indoor unit or service panel of the outdoor unit, set the circuit breaker to the OFF position. Failure to set the circuit breaker to the OFF position may result in electric shocks through contact with the interior parts. Only a qualified installer (*1) or qualified service person (*1) is allowed to remove the intake grille of the indoor unit or service panel of the outdoor unit and do the work required.
	Before starting to repair the outdoor unit fan or fan guard, be absolutely sure to set the circuit breaker to the OFF position, and place a "Work in progress" sign on the circuit breaker.
	When cleaning the filter or other parts of the indoor unit, set the circuit breaker to OFF without fail, and place a "Work in progress" sign near the circuit breaker before proceeding with the work.
	When you have noticed that some kind of trouble (such as when an error display has appeared, there is a smell of burning, abnormal sounds are heard, the air conditioner fails to cool or heat or water is leaking) has occurred in the air conditioner, do not touch the air conditioner yourself but set the circuit breaker to the OFF position, and contact a qualified service person. Take steps to ensure that the power will not be turned on (by marking "out of service" near the circuit breaker, for instance) until qualified service person arrives. Continuing to use the air conditioner in the trouble status may cause mechanical problems to escalate or result in electric shocks or other failure.
 Electric shock hazard	When you access inside of the service panel to repair electric parts, wait for about five minutes after turning off the breaker. Do not start repairing immediately. Otherwise you may get electric shock by touching terminals of high-voltage capacitors. Natural discharge of the capacitor takes about five minutes.
	When checking the electric parts, removing the cover of the electric parts box of Indoor Unit and/or service panel of Outdoor Unit inevitably to determine the failure, use gloves to provide protection for electricians, insulating shoes, clothing to provide protection from electric shock and insulating tools. Be careful not to touch the live part. Electric shock may result. Only "Qualified service person" is allowed to do this work.
 Prohibition	Place a "Work in progress" sign near the circuit breaker while the installation, maintenance, repair or removal work is being carried out. There is a danger of electric shocks if the circuit breaker is set to ON by mistake.
	When checking the electric parts, removing the cover of the electric parts box of Indoor Unit and/or front panel of Outdoor Unit inevitably to determine the failure, put a sign "Do not enter" around the site before the work. Failure to do this may result in third person getting electric shock.
	Before operating the air conditioner after having completed the work, check that the electrical parts box cover of the indoor unit and service panel of the outdoor unit are closed, and set the circuit breaker to the ON position. You may receive an electric shock if the power is turned on without first conducting these checks.
 Stay on protection	If, in the course of carrying out repairs, it becomes absolutely necessary to check out the electrical parts with the electrical parts box cover of one or more of the indoor units and the service panel of the outdoor unit removed in order to find out exactly where the trouble lies, wear insulated heat-resistant gloves, insulated boots and insulated work overalls, and take care to avoid touching any live parts. You may receive an electric shock if you fail to heed this warning. Only qualified service person (*1) is allowed to do this kind of work.

 **WARNING**

 General	<p>Before starting to repair the air conditioner, read carefully through the Service Manual, and repair the air conditioner by following its instructions.</p>
	<p>Only qualified service person (*1) is allowed to repair the air conditioner. Repair of the air conditioner by unqualified person may give rise to a fire, electric shocks, injury, water leaks and / or other problems.</p>
	<p>Do not use any refrigerant different from the one specified for complement or replacement. Otherwise, abnormally high pressure may be generated in the refrigeration cycle, which may result in a failure or explosion of the product or an injury to your body.</p>
	<p>Only a qualified installer (*1) or qualified service person (*1) is allowed to carry out the electrical work of the air conditioner. Under no circumstances must this work be done by an unqualified individual since failure to carry out the work properly may result in electric shocks and / or electrical leaks.</p>
	<p>When the air conditioner is to be transported, installed, maintained, repaired or removed, wear protective gloves and 'safety' work clothing.</p>
	<p>To connect the electrical wires, repair the electrical parts or undertake other electrical jobs, wear gloves to provide protection for electricians, insulating shoes and clothing to provide protection from electric shocks. Failure to wear this protective gear may result in electric shocks.</p>
	<p>Electrical wiring work shall be conducted according to law and regulation in the community and installation manual. Failure to do so may result in electrocution or short circuit.</p>
	<p>Use wiring that meets the specifications in the Installation Manual and the stipulations in the local regulations and laws. Use of wiring which does not meet the specifications may give rise to electric shocks, electrical leakage, smoking and/or a fire.</p>
	<p>Only a qualified installer (*1) or qualified service person (*1) is allowed to undertake work at heights using a stand of 50 cm or more or to remove the intake grille of the indoor unit to undertake work.</p>
	<p>When working at heights, use a ladder which complies with the ISO 14122 standard, and follow the procedure in the ladder's instructions. Also wear a helmet for use in industry as protective gear to undertake the work.</p>
	<p>Before working at heights, put a sign in place so that no-one will approach the work location, before proceeding with the work. Parts and other objects may fall from above, possibly injuring a person below. While carrying out the work, wear a helmet for protection from falling objects.</p>
	<p>When executing address setting, test run, or troubleshooting through the checking window on the electric parts box, put on insulated gloves to provide protection from electric shock. Otherwise you may receive an electric shock.</p>
	<p>Do not touch the aluminum fin of the outdoor unit. You may injure yourself if you do so. If the fin must be touched for some reason, first put on protective gloves and safety work clothing, and then proceed.</p>
	<p>Do not climb onto or place objects on top of the outdoor unit. You may fall or the objects may fall off of the outdoor unit and result in injury.</p>
	<p>Use forklift to carry in the air conditioner units and use winch or hoist at installation of them.</p>
	<p>When transporting the air conditioner, wear shoes with protective toe caps, protective gloves and other protective clothing.</p>
	<p>When transporting the air conditioner, do not take hold of the bands around the packing carton. You may injure yourself if the bands should break.</p>
	<p>Be sure that a heavy unit (10 kg or heavier) such as a compressor is carried by two persons.</p>
	<p>This air conditioner has passed the pressure test as specified in IEC 60335-2-40 Annex EE.</p>
 Check earth wires.	<p>Before troubleshooting or repair work, check the earth wire is connected to the earth terminals of the main unit, otherwise an electric shock is caused when a leak occurs. If the earth wire is not correctly connected, contact an electric engineer for rework.</p>
	<p>After completing the repair or relocation work, check that the ground wires are connected properly.</p>
	<p>Be sure to connect earth wire. (Grounding work) Incomplete grounding causes an electric shock. Do not connect ground wires to gas pipes, water pipes, and lightning rods or ground wires for telephone wires.</p>

 Prohibition of modification.	Do not modify the products. Do not also disassemble or modify the parts. It may cause a fire, electric shock or injury.
 Use specified parts.	When any of the electrical parts are to be replaced, ensure that the replacement parts satisfy the specifications given in the Service Manual (or use the parts contained on the parts list in the Service Manual). Use of any parts which do not satisfy the required specifications may give rise to electric shocks, smoking and / or a fire.
 Do not bring a child close to the equipment.	If, in the course of carrying out repairs, it becomes absolutely necessary to check out the electrical parts with the electrical parts box cover of one or more of the indoor units and the service panel of the outdoor unit removed in order to find out exactly where the trouble lies, put a sign in place so that no-one will approach the work location before proceeding with the work. Third-party individuals may enter the work site and receive electric shocks if this warning is not heeded.
 Insulating measures	Connect the cut-off lead wires with crimp contact, etc., put the closed end side upward and then apply a watercut method, otherwise a leak or production of fire is caused at the users' side.
 No fire	When performing repairs using a gas burner, replace the refrigerant with nitrogen gas because the oil that coats the pipes may otherwise burn. When repairing the refrigerating cycle, take the following measures. 1) Be attentive to fire around the cycle. When using a gas stove, etc., be sure to put out fire before work; otherwise the oil mixed with refrigerant gas may catch fire. 2) Do not use a welder in the closed room. When using it without ventilation, carbon monoxide poisoning may be caused. 3) Do not bring inflammables close to the refrigerant cycle, otherwise fire of the welder may catch the inflammables.
 Refrigerant	The refrigerant used by this air conditioner is the R410A. Check the used refrigerant name and use tools and materials of the parts which match with it. For the products which use R410A refrigerant, the refrigerant name is indicated at a position on the outdoor unit where is easy to see. To prevent miss-charging, the route of the service port is changed from one of the former R22. Do not use any refrigerant different from the one specified for complement or replacement. Otherwise, abnormally high pressure may be generated in the refrigeration cycle, which may result in a failure or explosion of the product or an injury to your body. For an air conditioner which uses R410A, never use other refrigerant than R410A. For an air conditioner which uses other refrigerant (R22, etc.), never use R410A. If different types of refrigerant are mixed, abnormal high pressure generates in the refrigerating cycle and an injury due to breakage may be caused. When the air conditioner has been installed or relocated, follow the instructions in the Installation Manual and purge the air completely so that no gases other than the refrigerant will be mixed in the refrigerating cycle. Failure to purge the air completely may cause the air conditioner to malfunction. Do not charge refrigerant additionally. If charging refrigerant additionally when refrigerant gas leaks, the refrigerant composition in the refrigerating cycle changes resulted in change of air conditioner characteristics or refrigerant over the specified standard amount is charged and an abnormal high pressure is applied to the inside of the refrigerating cycle resulted in cause of breakage or injury. Therefore if the refrigerant gas leaks, recover the refrigerant in the air conditioner, execute vacuuming, and then newly recharge the specified amount of liquid refrigerant. In this time, never charge the refrigerant over the specified amount. When recharging the refrigerant in the refrigerating cycle, do not mix the refrigerant or air other than R410A into the specified refrigerant. If air or others is mixed with the refrigerant, abnormal high pressure generates in the refrigerating cycle resulted in cause of injury due to breakage. After installation work, check the refrigerant gas does not leak. If the refrigerant gas leaks in the room, poisonous gas generates when gas touches to fire such as fan heater, stove or cooking stove though the refrigerant gas itself is innocuous. Never recover the refrigerant into the outdoor unit. When the equipment is moved or repaired, be sure to recover the refrigerant with recovering device. The refrigerant cannot be recovered in the outdoor unit; otherwise a serious accident such as breakage or injury is caused.

 Assembly / Wiring	After repair work, surely assemble the disassembled parts, and connect and lead the removed wires as before. Perform the work so that the cabinet or panel does not catch the inner wires. If incorrect assembly or incorrect wire connection was done, a disaster such as a leak or fire is caused at user's side.
 Insulator check	After the work has finished, be sure to use an insulation tester set (500 V Megger) to check the resistance is 1 MΩ or more between the charge section and the non-charge metal section (Earth position). If the resistance value is low, a disaster such as a leak or electric shock is caused at user's side.
 Ventilation	When the refrigerant gas leaks during work, execute ventilation. If the refrigerant gas touches to a fire, poisonous gas generates. A case of leakage of the refrigerant and the closed room full with gas is dangerous because a shortage of oxygen occurs. Be sure to execute ventilation. If refrigerant gas has leaked during the installation work, ventilate the room immediately. If the leaked refrigerant gas comes in contact with fire, noxious gas may generate. After installation work, check the refrigerant gas does not leak. If the refrigerant gas leaks in the room, poisonous gas generates when gas touches to fire such as fan heater, stove or cooking stove though the refrigerant gas itself is innocuous.
 Compulsion	When the refrigerant gas leaks, find up the leaked position and repair it surely. If the leaked position cannot be found up and the repair work is interrupted, pump-down and tighten the service valve, otherwise the refrigerant gas may leak into the room. The poisonous gas generates when gas touches to fire such as fan heater, stove or cooking stove though the refrigerant gas itself is innocuous. When installing equipment which includes a large amount of charged refrigerant such as a multi air conditioner in a sub-room, it is necessary that the density does not the limit even if the refrigerant leaks. If the refrigerant leaks and exceeds the limit density, an accident of shortage of oxygen is caused. Tighten the flare nut with a torque wrench in the specified manner. Excessive tighten of the flare nut may cause a crack in the flare nut after a long period, which may result in refrigerant leakage. Nitrogen gas must be used for the airtight test. The charge hose must be connected in such a way that it is not slack. For the installation / moving / reinstallation work, follow to the Installation Manual. If an incorrect installation is done, a trouble of the refrigerating cycle, water leak, electric shock or fire is caused.
 Check after repair	Once the repair work has been completed, check for refrigerant leaks, and check the insulation resistance and water drainage. Then perform a trial run to check that the air conditioner is running properly. After repair work has finished, check there is no trouble. If check is not executed, a fire, electric shock or injury may be caused. For a check, turn off the power breaker. After repair work (installation of front panel and cabinet) has finished, execute a test run to check there is no generation of smoke or abnormal sound. If check is not executed, a fire or an electric shock is caused. Before test run, install the front panel and cabinet. Be sure to fix the screws back which have been removed for installation or other purposes.
 Do not operate the unit with the valve closed.	Check the following matters before a test run after repairing piping. • Connect the pipes surely and there is no leak of refrigerant. • The valve is opened. Running the compressor under condition that the valve closes causes an abnormal high pressure resulted in damage of the parts of the compressor and etc. and moreover if there is leak of refrigerant at connecting section of pipes, the air is sucked and causes further abnormal high pressure resulted in burst or injury.
 Check after reinstallation	Only a qualified installer (*1) or qualified service person (*1) is allowed to relocate the air conditioner. It is dangerous for the air conditioner to be relocated by an unqualified individual since a fire, electric shocks, injury, water leakage, noise and / or vibration may result. Check the following items after reinstallation. 1) The earth wire is correctly connected. 2) The power cord is not caught in the product. 3) There is no inclination or unsteadiness and the installation is stable. If check is not executed, a fire, an electric shock or an injury is caused. When carrying out the pump-down work shut down the compressor before disconnecting the refrigerant pipe. Disconnecting the refrigerant pipe with the service valve left open and the compressor still operating will cause air, etc. to be sucked in, raising the pressure inside the refrigeration cycle to an abnormally high level, and possibly resulting in reputing, injury, etc.

 Cooling check	<p>When the service panel of the outdoor unit is to be opened in order for the compressor or the area around this part to be repaired immediately after the air conditioner has been shut down, set the circuit breaker to the OFF position, and then wait at least 10 minutes before opening the service panel. If you fail to heed this warning, you will run the risk of burning yourself because the compressor pipes and other parts will be very hot to the touch. In addition, before proceeding with the repair work, wear the kind of insulated heat-resistant gloves designed to protect electricians.</p>
	<p>Take care not to get burned by compressor pipes or other parts when checking the cooling cycle while running the unit as they get heated while running. Be sure to put on gloves providing protection for heat.</p>
 Installation	<p>When the service panel of the outdoor unit is to be opened in order for the fan motor, reactor, inverter or the areas around these parts to be repaired immediately after the air conditioner has been shut down, set the circuit breaker to the OFF position, and then wait at least 10 minutes before opening the service panel. If you fail to heed this warning, you will run the risk of burning yourself because the fan motor, reactor, inverter heat sink and other parts will be very hot to the touch. In addition, before proceeding with the repair work, wear the kind of insulated heat-resistant gloves designed to protect electricians.</p>
	<p>Only a qualified installer or service person is allowed to do installation work. Inappropriate installation may result in water leakage, electric shock or fire.</p>
	<p>Before starting to install the air conditioner, read carefully through the Installation Manual, and follow its instructions to install the air conditioner.</p>
	<p>Be sure to use the company-specified products for the separately purchased parts. Use of non-specified products may result in fire, electric shock, water leakage or other failure. Have the installation performed by a qualified installer.</p>
	<p>Do not supply power from the power terminal block equipped on the outdoor unit to another outdoor unit. Capacity overflow may occur on the terminal block and may result in fire.</p>
	<p>Do not install the air conditioner in a location that may be subject to a risk of exposure to a combustible gas. If a combustible gas leaks and becomes concentrated around the unit, a fire may occur.</p>
	<p>Install the indoor unit at least 2.5 m above the floor level since otherwise the users may injure themselves or receive electric shocks if they poke their fingers or other objects into the indoor unit while the air conditioner is running.</p>
	<p>Install a circuit breaker that meets the specifications in the installation manual and the stipulations in the local regulations and laws.</p>
	<p>Install the circuit breaker where it can be easily accessed by the qualified service person (*1).</p>
	<p>If you install the unit in a small room, take appropriate measures to prevent the refrigerant from exceeding the limit concentration even if it leaks. Consult the dealer from whom you purchased the air conditioner when you implement the measures. Accumulation of highly concentrated refrigerant may cause an oxygen deficiency accident.</p>
<p>Do not place any combustion appliance in a place where it is directly exposed to the wind of air conditioner, otherwise it may cause imperfect combustion.</p>	

Explanations given to user

If you have discovered that the fan grille is damaged, do not approach the outdoor unit but set the circuit breaker to the OFF position, and contact a qualified service person to have the repairs done. Do not set the circuit breaker to the ON position until the repairs are completed.

Relocation

- Only a qualified installer (*1) or qualified service person (*1) is allowed to relocate the air conditioner. It is dangerous for the air conditioner to be relocated by an unqualified individual since a fire, electric shocks, injury, water leakage, noise and / or vibration may result.
- When carrying out the pump-down work shut down the compressor before disconnecting the refrigerant pipe. Disconnecting the refrigerant pipe with the service valve left open and the compressor still operating will cause air, etc. to be sucked in, raising the pressure inside the refrigeration cycle to an abnormally high level, and possibly resulting in reputing, injury, etc.

(*1) Refer to the "Definition of Qualified Installer or Qualified Service Person"

Declaration of Conformity

Manufacturer: TOSHIBA CARRIER (THAILAND) CO., LTD.
144 / 9 Moo 5, Bangkadi Industrial Park, Tivanon Road,
Tambon Bangkadi, Amphur Muang, Pathumthani 12000, Thailand

Authorized Representative / Nick Ball

TCF holder: Toshiba EMEA Engineering Director
Toshiba Carrier UK Ltd.
Porsham Close, Belliver Industrial Estate,
PLYMOUTH, Devon, PL6 7DB.
United Kingdom

Hereby declares that the machinery described below:

Generic Denomination: Air Conditioner

Model / type: Indoor unit
<4-way Cassette Type>
MMU-AP0094HP1-E (TR) MMU-AP0124HP1-E(TR)
MMU-AP0154HP1-E (TR) MMU-AP0184HP1-E(TR)
MMU-AP0244HP1-E (TR) MMU-AP0274HP1-E(TR)
MMU-AP0304HP1-E (TR) MMU-AP0364HP1-E(TR)
MMU-AP0484HP1-E (TR) MMU-AP0564HP1-E(TR)

Commercial name: Super Modular Multi System Air Conditioner
Super Heat Recovery Multi System Air Conditioner
MiNi-Super Modular Multi System Air Conditioner (MiNi-SMMS series)

Complies with the provisions of the "Machinery" Directive (Directive 2006/42/EC) and the regulations transposing into national law

Complies with the provisions of the following harmonized standard:
EN 378-2: 2008+A2:2012

NOTE

This declaration becomes invalid if technical or operational modifications are introduced without the manufacturer's consent.

Specifications

Model	Sound Pressure level (dBA)		Weight (kg) Main unit (Ceiling panel)
	Cooling	Heating	
MMU-AP0094HP1-E (TR)	*	*	18 (4)
MMU-AP0124HP1-E (TR)	*	*	18 (4)
MMU-AP0154HP1-E (TR)	*	*	20 (4)
MMU-AP0184HP1-E (TR)	*	*	20 (4)
MMU-AP0244HP1-E (TR)	*	*	20 (4)
MMU-AP0274HP1-E (TR)	*	*	20 (4)
MMU-AP0304HP1-E (TR)	*	*	20 (4)
MMU-AP0364HP1-E (TR)	*	*	25 (4)
MMU-AP0484HP1-E (TR)	*	*	25 (4)
MMU-AP0564HP1-E (TR)	*	*	25 (4)

* : Under 70 dBA

• New Refrigerant (R410A)

This air conditioner adopts a new HFC type refrigerant (R410A) which does not deplete the ozone layer.

1. Safety Caution Concerned to New Refrigerant

The pressure of R410A is high 1.6 times of that of the former refrigerant (R22).

Accompanied with change of refrigerant, the refrigerating oil has been also changed.

Therefore, be sure that water, dust, the former refrigerant or the former refrigerating oil is not mixed into the refrigerating cycle of the air conditioner with new refrigerant during installation work or service work.

If an incorrect work or incorrect service is performed, there is a possibility to cause a serious accident.

Use the tools and materials exclusive to R410A to purpose a safe work.

2. Cautions on Installation/Service

- (1) Do not mix the other refrigerant or refrigerating oil.

For the tools exclusive to R410A, shapes of all the joints including the service port differ from those of the former refrigerant in order to prevent mixture of them.

- (2) As the use pressure of the new refrigerant is high, use material thickness of the pipe and tools which are specified for R410A.

- (3) In the installation time, use clean pipe materials and work with great attention so that water and others do not mix in because pipes are affected by impurities such as water, oxide scales, oil, etc.

Use the clean pipes.

Be sure to brazing with flowing nitrogen gas. (Never use gas other than nitrogen gas.)

- (4) For the earth protection, use a vacuum pump for air purge.

- (5) R410A refrigerant is azeotropic mixture type refrigerant.

Therefore use liquid type to charge the refrigerant. (If using gas for charging, composition of the refrigerant changes and then characteristics of the air conditioner change.)

3. Pipe Materials

For the refrigerant pipes, copper pipe and joints are mainly used.

It is necessary to select the most appropriate pipes to conform to the standard.

Use clean material in which impurities adhere inside of pipe or joint to a minimum.

- (1) Copper pipe

<Piping>

The pipe thickness, flare finishing size, flare nut and others differ according to a refrigerant type.

When using a long copper pipe for R410A, it is recommended to select "Copper or copper-base pipe without seam" and one with bonded oil amount 40mg/10m or less.

Also do not use crushed, deformed, discolored (especially inside) pipes. (Impurities cause clogging of expansion valves and capillary tubes.)

<Flare nut>

Use the flare nuts which are attached to the air conditioner unit.

- (2) Joint

The flare joint and socket joint are used for joints of the copper pipe.

The joints are rarely used for installation of the air conditioner.

However clear impurities when using them.

4. Tools

(1) Required Tools for R410A

Mixing of different types of oil may cause a trouble such as generation of sludge, clogging of capillary, etc. Accordingly, the tools to be used are classified into the following three types.

- 1) Tools exclusive for R410A (Those which cannot be used for conventional refrigerant (R22))
- 2) Tools exclusive for R410A, but can be also used for conventional refrigerant (R22)
- 3) Tools commonly used for R410A and for conventional refrigerant (R22)

The table below shows the tools exclusive for R410A and their interchangeability.

Tools exclusive for R410A (The following tools for R410A are required.)

Tools whose specifications are changed for R410A and their interchangeability

No.	Used tool	Usage	R410A air conditioner installation		Conventional air conditioner installation
			Existence of new equipment for R410A	Whether conventional equipment can be used	Whether new equipment can be used with conventional refrigerant
①	Flare tool	Pipe flaring	Yes	*(Note 1)	Yes
②	Copper pipe gauge for adjusting projection margin	Flaring by conventional flare tool	Yes	*(Note 1)	*(Note 1)
③	Torque wrench	Connection of flare nut	Yes	No	No
④	Gauge manifold	Evacuating, refrigerant charge, run check, etc.	Yes	No	No
⑤	Charge hose				
⑥	Vacuum pump adapter	Vacuum evacuating	Yes	No	Yes
⑦	Electronic balance for refrigerant charging	Refrigerant charge	Yes	Yes	Yes
⑧	Refrigerant cylinder	Refrigerant charge	Yes	No	No
⑨	Leakage detector	Gas leakage check	Yes	No	Yes
⑨	Charging cylinder	Refrigerant charge	(Note 2)	No	No

(Note 1) When flaring is carried out for R410A using the conventional flare tools, adjustment of projection margin is necessary. For this adjustment, a copper pipe gauge, etc. are necessary.

(Note 2) Charging cylinder for R410A is being currently developed.

General tools (Conventional tools can be used.)

In addition to the above exclusive tools, the following equipments which serve also for R22 are necessary as the general tools.

- 1) Vacuum pump
Use vacuum pump by attaching vacuum pump adapter.
- 2) Torque wrench
- 3) Pipe cutter
- 4) Reamer
- 5) Pipe bender
- 6) Level vial
- 7) Screwdriver (+, -)
- 8) Spanner or Monkey wrench
- 9) Hole core drill
- 10) Hexagon wrench (Opposite side 4mm)
- 11) Tape measure
- 12) Metal saw

Also prepare the following equipments for other installation method and run check.

- 1) Clamp meter
- 2) Thermometer
- 3) Insulation resistance tester
- 4) Electroscopes

1. CONSTRUCTION VIEWS (EXTERNAL VIEWS)

MMU-AP0094HP1* , AP0124HP1*

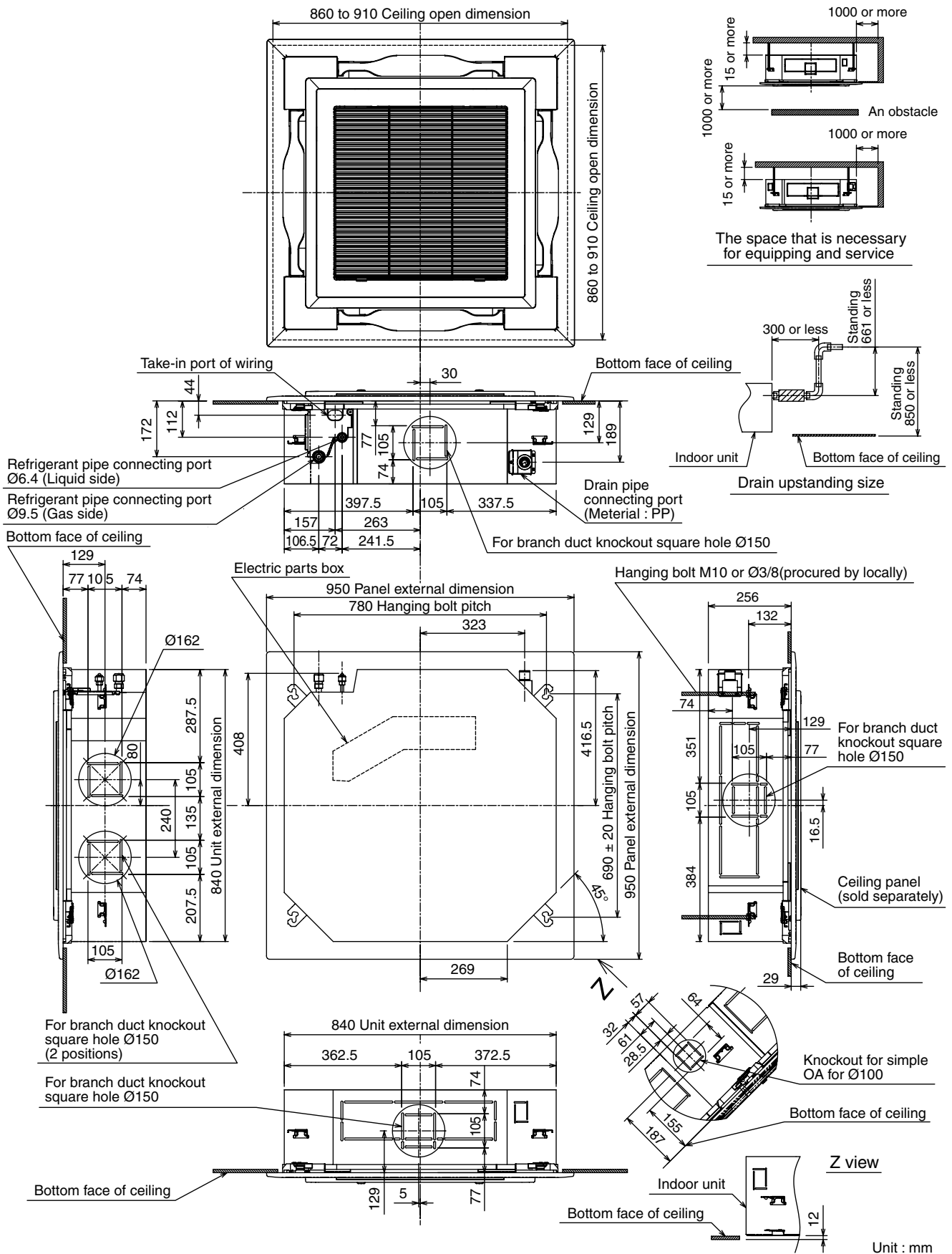

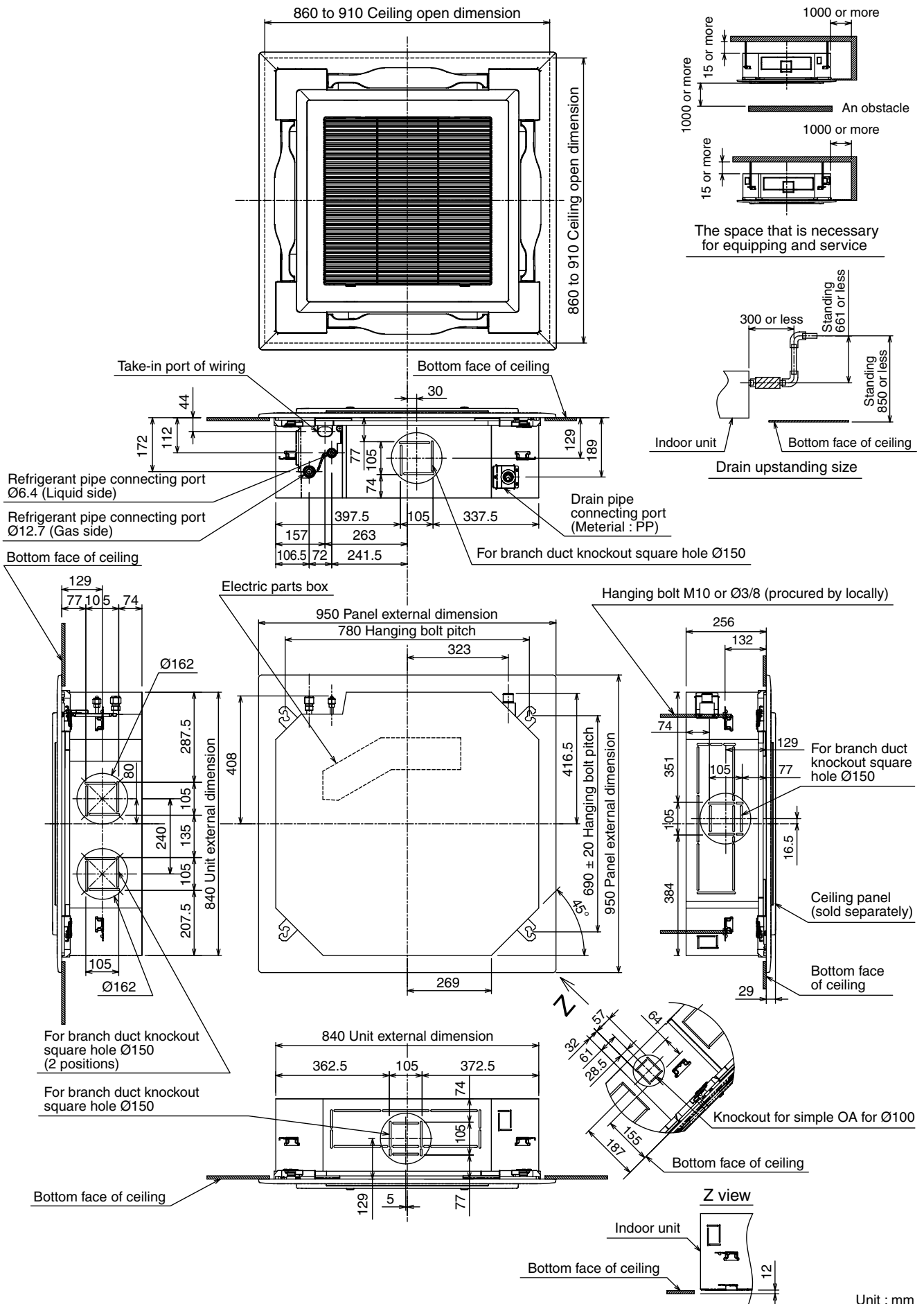

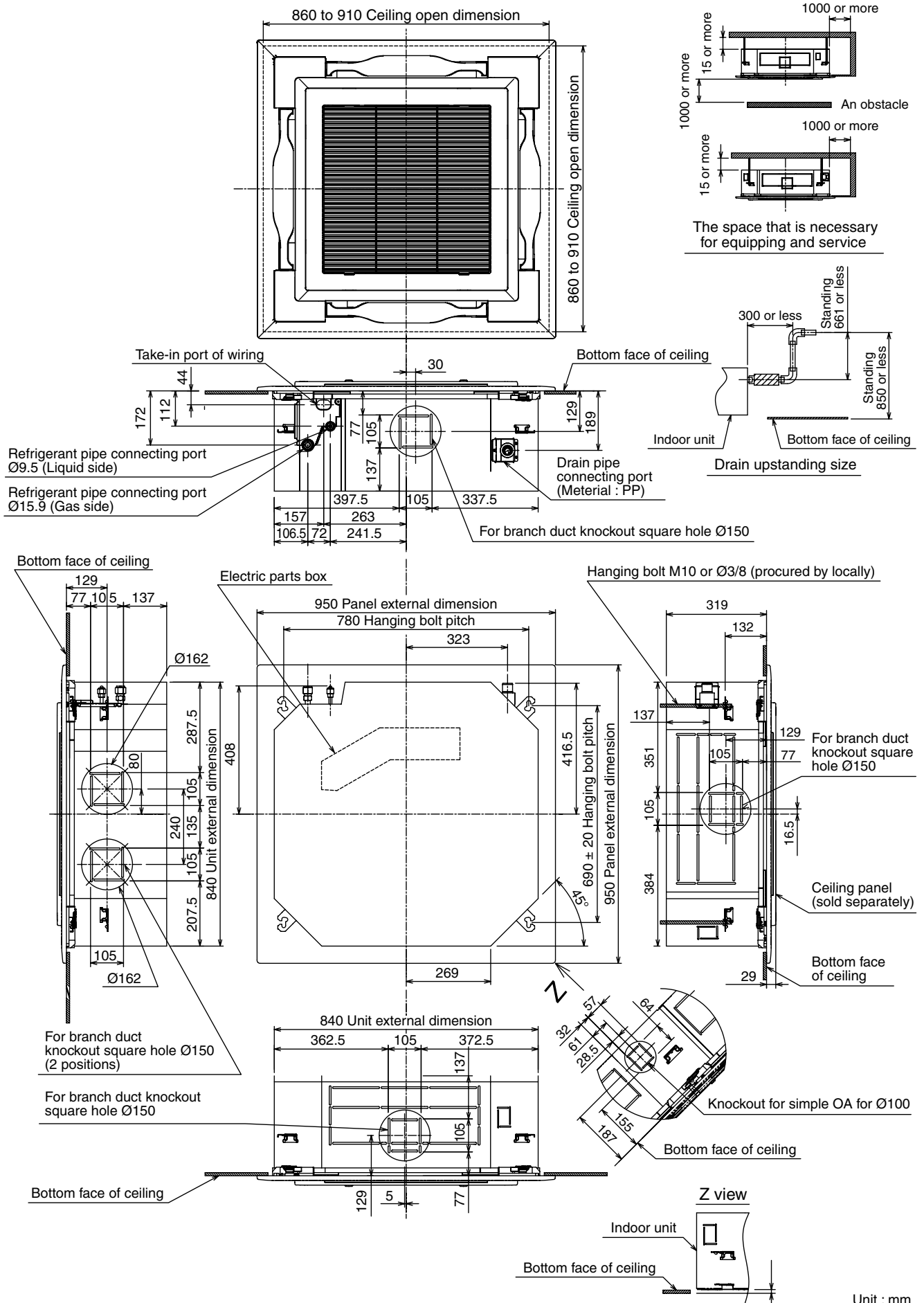

2. WIRING DIAGRAM

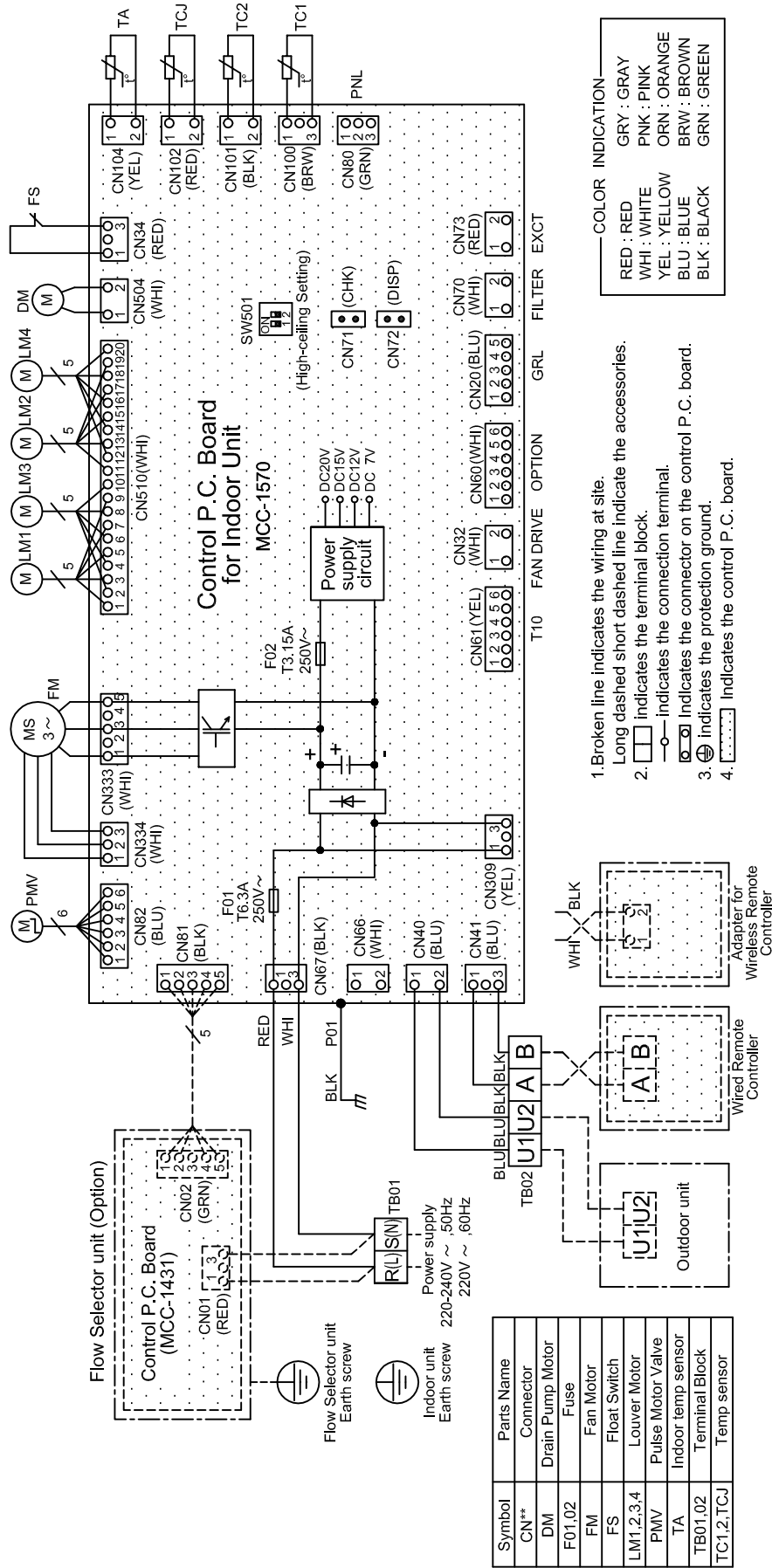

3. PARTS RATING

3-1. Part Rating

Model	MMU-						
	AP009	AP012	AP015	AP018	AP024	AP027	AP030
Fan motor	SWF-230-60-2R						
Motor for horizontal grille	MSBPC20F04						
Pulse motor	EFM-MD12TF-1						
Pulse motor valve	EFM-25YGTCTH-2		EFM-40YGTCTH-2				
TA sensor	Lead wire length : 328 mm Vinyl tube						
TC1 sensor	Ø4 size lead wire length : 1000 mm Vinyl tube (Blue)						
TC2 sensor	Ø6 size lead wire length : 1000 mm Vinyl tube (Black)						
TCJ sensor	Ø6 size lead wire length : 1000 mm Vinyl tube (Red)						
Float switch	FS-1A-31-3						
Drain pump motor	MDP-1401						

Model	MMU-		
	AP036	AP048	AP056
Fan motor	ICF-280-150-1		
Motor for horizontal grille	MSBPC20F04		
Pulse motor	EFM-MD12TF-1		
Pulse motor valve	EFM-60YGTCTH-1		
TA sensor	Lead wire length : 328 mm Vinyl tube		
TC1 sensor	Ø4 size lead wire length : 1000 mm Vinyl tube (Blue)		
TC2 sensor	Ø6 size lead wire length : 1000 mm Vinyl tube (Black)		
TCJ sensor	Ø6 size lead wire length : 1000 mm Vinyl tube (Red)		
Float switch	FS-1A-31-3		
Drain pump motor	MDP-1401		

4. REFRIGERATING CYCLE DIAGRAM

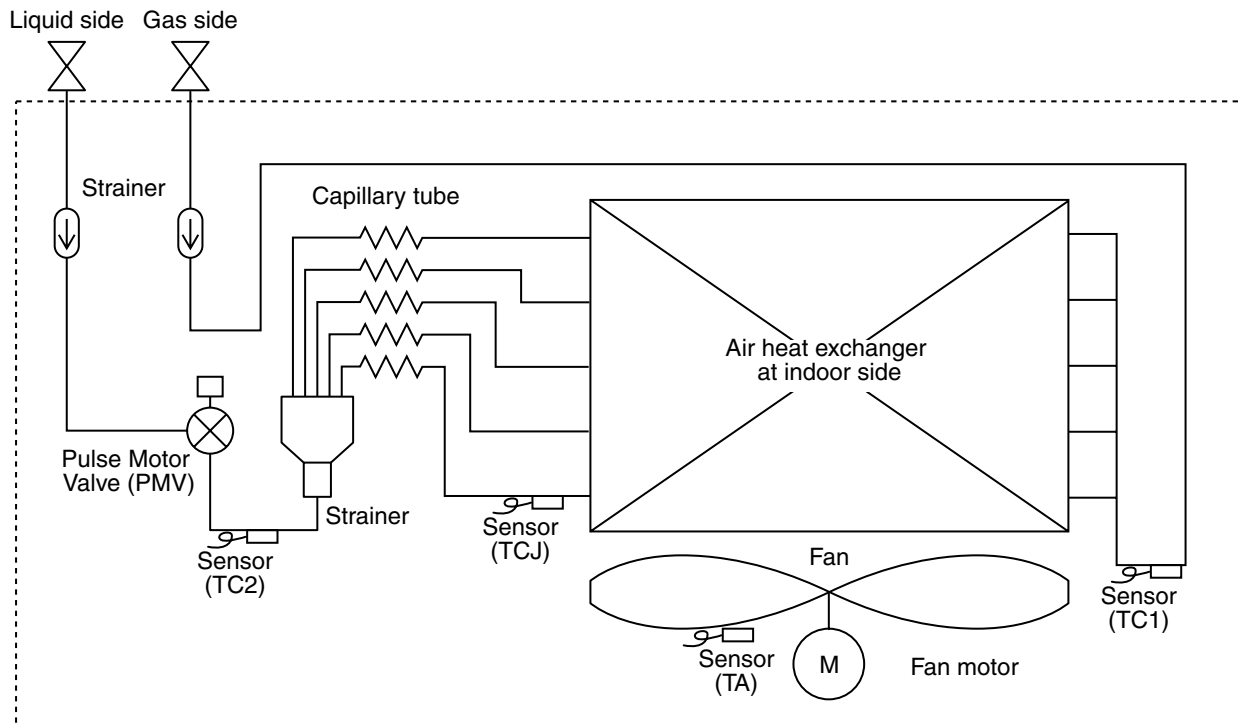

Functional part name		Functional outline
Pulse Motor Valve	PMV	(Connector CN082 (6P): Blue) 1) Controls super heat in cooling operation 2) Controls under cool in heating operation 3) Recovers refrigerant oil in cooling operation 4) Recovers refrigerant oil in heating operation
Temp. sensor	1. TA	(Connector CN104 (2P): Yellow) 1) Detects indoor suction temperature
	2. TC1	(Connector CN100 (3P): Brown) 1) Controls PMV super heat in cooling operation
	3. TC2	(Connector CN101 (2P): Black) 1) Controls PMV under cool in heating operation
	4. TCJ	(Connector CN102 (2P): Red) 1) Controls PMV super heat in cooling operation

5. CONTROL OUTLINE

5-1. Control Specifications

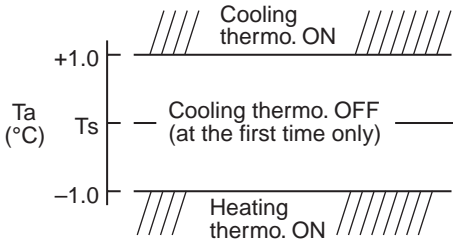
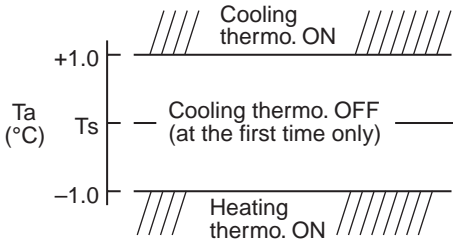
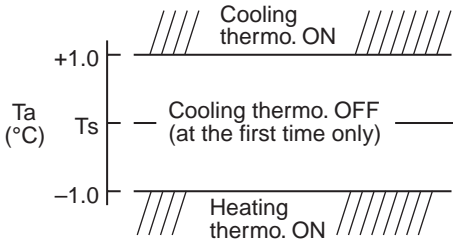

No.	Item	Outline of specifications	Remarks														
1	When power supply is reset	1) Distinction of outdoor unit When the power supply is reset, the outdoors are distinguished and the control is selected according to the distinguished result. 2) Setting of indoor fan speed and existence of air direction adjustment Based on EEPROM data, select setting of the indoor fan speed and the existence of air direction adjustment. 3) If resetting the power supply during occurrence of a trouble, the check code is once cleared. After ON/OFF button of the remote controller was pushed and the operation was resumed, if the abnormal status continues, the check code is again displayed on the remote controller.															
2	Operation mode selection	1) Based on the operation mode selecting command from the remote controller, the operation mode is selected. <table border="1" data-bbox="461 841 1130 1832" style="margin: 10px auto;"> <thead> <tr> <th data-bbox="461 841 651 932">Remote controller command</th> <th data-bbox="651 841 1130 932">Control outline</th> </tr> </thead> <tbody> <tr> <td data-bbox="461 932 651 977">STOP</td> <td data-bbox="651 932 1130 977">Air conditioner stops.</td> </tr> <tr> <td data-bbox="461 977 651 1022">FAN</td> <td data-bbox="651 977 1130 1022">Fan operation</td> </tr> <tr> <td data-bbox="461 1022 651 1068">COOL</td> <td data-bbox="651 1022 1130 1068">Cooling operation</td> </tr> <tr> <td data-bbox="461 1068 651 1113">DRY</td> <td data-bbox="651 1068 1130 1113">Dry operation</td> </tr> <tr> <td data-bbox="461 1113 651 1158">HEAT</td> <td data-bbox="651 1113 1130 1158">Heating operation</td> </tr> <tr> <td data-bbox="461 1158 651 1378">AUTO (SHRM only)</td> <td data-bbox="651 1158 1130 1378"> <ul style="list-style-type: none"> • Ta and Ts automatically select COOL/HEAT operation mode for operation. • The operation is performed as shown in the following figure according to Ta value at the first time only. (In the range of $T_s - 1 < T_a < T_s + 1$, Cooling thermo. OFF (Fan) / Setup air volume operation continues.)  <p style="font-size: small;">* In the SMMS-i and Mini-SMMS, the automatic mode cannot be selected. While a wireless remote controller is used, the mode is notified by "Pi Pi" (two times) receiving sound and the alternate flashing of [TIMER ☹] and [READY ☺]. To clear the alternate flashing, change the mode on the wireless remote controller.</p> </td> </tr> </tbody> </table>	Remote controller command	Control outline	STOP	Air conditioner stops.	FAN	Fan operation	COOL	Cooling operation	DRY	Dry operation	HEAT	Heating operation	AUTO (SHRM only)	<ul style="list-style-type: none"> • Ta and Ts automatically select COOL/HEAT operation mode for operation. • The operation is performed as shown in the following figure according to Ta value at the first time only. (In the range of $T_s - 1 < T_a < T_s + 1$, Cooling thermo. OFF (Fan) / Setup air volume operation continues.)  <p style="font-size: small;">* In the SMMS-i and Mini-SMMS, the automatic mode cannot be selected. While a wireless remote controller is used, the mode is notified by "Pi Pi" (two times) receiving sound and the alternate flashing of [TIMER ☹] and [READY ☺]. To clear the alternate flashing, change the mode on the wireless remote controller.</p>	Ta: Room temp. Ts: Setup temp.
Remote controller command	Control outline																
STOP	Air conditioner stops.																
FAN	Fan operation																
COOL	Cooling operation																
DRY	Dry operation																
HEAT	Heating operation																
AUTO (SHRM only)	<ul style="list-style-type: none"> • Ta and Ts automatically select COOL/HEAT operation mode for operation. • The operation is performed as shown in the following figure according to Ta value at the first time only. (In the range of $T_s - 1 < T_a < T_s + 1$, Cooling thermo. OFF (Fan) / Setup air volume operation continues.)  <p style="font-size: small;">* In the SMMS-i and Mini-SMMS, the automatic mode cannot be selected. While a wireless remote controller is used, the mode is notified by "Pi Pi" (two times) receiving sound and the alternate flashing of [TIMER ☹] and [READY ☺]. To clear the alternate flashing, change the mode on the wireless remote controller.</p>																
3	Room temp. control	1) Adjustment range: Remote controller setup temperature (°C) <table border="1" data-bbox="461 1923 1130 2048" style="margin: 10px auto;"> <thead> <tr> <th></th> <th>COOL/DRY</th> <th>HEAT</th> <th>AUTO*</th> </tr> </thead> <tbody> <tr> <td>Wired type</td> <td>18 to 29</td> <td>18 to 29</td> <td>18 to 29</td> </tr> <tr> <td>Wireless type</td> <td>18 to 30</td> <td>17 to 30</td> <td>17 to 27</td> </tr> </tbody> </table>		COOL/DRY	HEAT	AUTO*	Wired type	18 to 29	18 to 29	18 to 29	Wireless type	18 to 30	17 to 30	17 to 27	* For SHRM only		
	COOL/DRY	HEAT	AUTO*														
Wired type	18 to 29	18 to 29	18 to 29														
Wireless type	18 to 30	17 to 30	17 to 27														

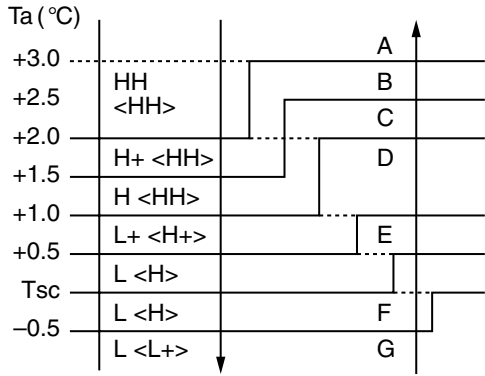
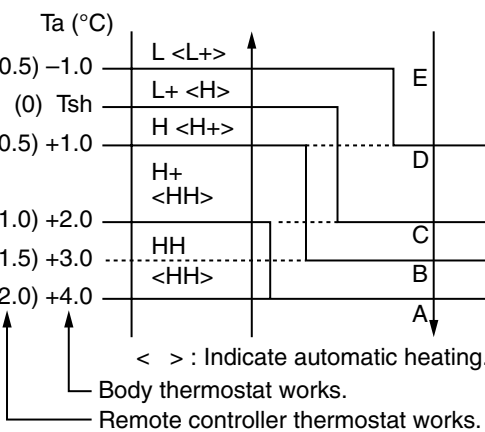

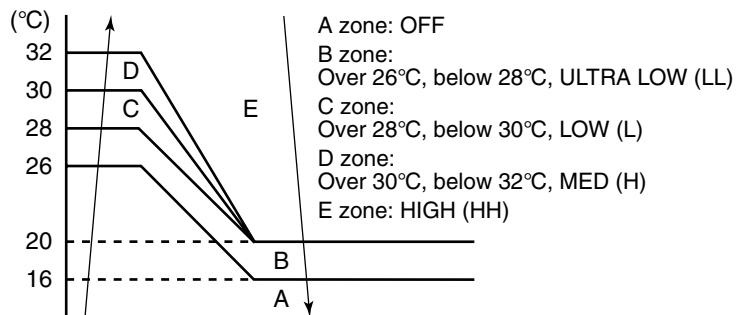

No.	Item	Outline of specifications	Remarks												
3	Room temp. control (Continued)	2) Using the CODE No. 06, the setup temperature in heating operation can be corrected. <table border="1" data-bbox="464 297 1117 381"> <tr> <td>Setup data</td> <td>0</td> <td>2</td> <td>4</td> <td>6</td> </tr> <tr> <td>Setup temp. correction</td> <td>+0°C</td> <td>+2°C</td> <td>+4°C</td> <td>+6°C</td> </tr> </table> Setting at shipment <table border="1" data-bbox="464 437 753 478"> <tr> <td>Setup data</td> <td>2</td> </tr> </table>	Setup data	0	2	4	6	Setup temp. correction	+0°C	+2°C	+4°C	+6°C	Setup data	2	Shift of suction temperature in heating operation Except while sensor of the remote controller is controlled
Setup data	0	2	4	6											
Setup temp. correction	+0°C	+2°C	+4°C	+6°C											
Setup data	2														
4	Automatic capacity control	1) Based on the difference between Ta and Ts, the operation capacity is determined by the outdoor unit. <div style="display: flex; justify-content: space-around; align-items: center;"> <div data-bbox="480 637 748 1016"> <p style="text-align: center;">COOL</p> </div> <div data-bbox="829 637 1097 1016"> <p style="text-align: center;">HEAT</p> </div> </div>	Ts: Setup temp. Ta: Room temp.												
5	Automatic cooling/heating control * For SHRM only	1) The judgment of selecting COOL/HEAT is carried out as shown below. When +1.5 exceeds against Tsh 10 minutes and after thermo.-OFF, heating operation (Thermo. OFF) exchanges to cooling operation. Description in the parentheses shows an example of cooling ON/OFF. <div style="text-align: center;"> </div> <p>When -1.5 lowers against Tsc 10 minutes and after thermo. OFF, cooling operation (Thermo. OFF) exchanges to heating operation.</p> 2) For the automatic capacity control after judgment of cooling/heating, see Item 4. 3) For temperature correction of room temp. control in automatic heating, see Item 3.	* For SHRM only Tsc: Setup temp. in cooling operation Tsh: Setup temp. in heating operation + temp. correction of room temp. control												

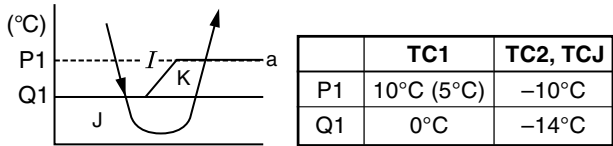
No.	Item	Outline of specifications	Remarks
6	Air speed selection	<p>1) Operation with (HH), (H), (L) or [AUTO] mode is carried out by the command from the remote controller.</p> <p>2) When the air speed mode [AUTO] is selected, the air speed varies by the difference between Ta and Ts.</p> <p><COOL></p>  <p style="text-align: center;">< > : Indicate automatic cooling.</p> <ul style="list-style-type: none"> Controlling operation in case when thermo of remote controller works is same as a case when thermo of the body works. If the air speed has been changed once, it is not changed for 3 minutes. However when the air volume is exchanged, the air speed changes. When cooling operation has started, select a downward slope for the air speed, that is, the high position. If the temperature is just on the difference boundary, the air speed does not change. <p><HEAT></p>  <p style="text-align: center;">< > : Indicate automatic heating.</p> <p style="text-align: center;">Body thermostat works.</p> <p style="text-align: center;">Remote controller thermostat works.</p> <p>Value in the parentheses indicates one when thermostat of the remote controller works.</p> <p>Value without parentheses indicates one when thermostat of the body works.</p> <ul style="list-style-type: none"> If the air speed has been changed once, it is not changed for 1 minute. However when the air speed exchanged, the air speed changes. When heating operation has started, select an upward slope for the air speed, that is, the high position. If the temperature is just on the difference boundary, the air speed does not change. 	<p>HH > H+ > H > L+ > L > UL</p> <p>Code No. 32 0000: Body thermo. (Main unit) 0001: Remote controller thermo.</p>





No.	Item	Outline of specifications	Remarks																																																																																																																																																								
6	Air speed selection (Continued):	<table border="1" data-bbox="548 369 1446 1000"> <thead> <tr> <th rowspan="2">CODE No. [5d]</th> <th colspan="2">Standard</th> <th colspan="2">Type 1</th> <th colspan="2">Type 3</th> <th colspan="2">Type 6</th> </tr> <tr> <th colspan="2">0000</th> <th colspan="2">0001</th> <th colspan="2">0003</th> <th colspan="2">0006</th> </tr> <tr> <th>SW501 (1)/(2)</th> <th colspan="2">OFF/OFF</th> <th colspan="2">ON/OFF</th> <th colspan="2">OFF/ON</th> <th colspan="2">ON/ON</th> </tr> <tr> <th>Tap</th> <th>HEAT</th> <th>COOL</th> <th>HEAT</th> <th>COOL</th> <th>HEAT</th> <th>COOL</th> <th>HEAT</th> <th>COOL</th> </tr> </thead> <tbody> <tr><td>F1</td><td></td><td></td><td></td><td></td><td>HH</td><td>HH</td><td>HH</td><td>HH</td></tr> <tr><td>F2</td><td></td><td></td><td>HH</td><td>HH</td><td></td><td></td><td></td><td></td></tr> <tr><td>F3</td><td></td><td></td><td></td><td>H+</td><td>H+, H</td><td>H+, H</td><td>H+, H L+, L</td><td>H+, H L+, L</td></tr> <tr><td>F4</td><td></td><td></td><td>H+</td><td></td><td></td><td></td><td></td><td></td></tr> <tr><td>F5</td><td></td><td>HH</td><td></td><td>H</td><td></td><td></td><td></td><td></td></tr> <tr><td>F6</td><td>HH</td><td></td><td>H</td><td></td><td>L+</td><td>L+</td><td></td><td></td></tr> <tr><td>F7</td><td>H+</td><td>H+</td><td></td><td></td><td>L</td><td>L</td><td></td><td></td></tr> <tr><td>F8</td><td></td><td>H</td><td></td><td>L+</td><td></td><td></td><td></td><td></td></tr> <tr><td>F9</td><td>H</td><td></td><td>L+</td><td>L</td><td></td><td></td><td></td><td></td></tr> <tr><td>FA</td><td></td><td>L+</td><td>L</td><td></td><td></td><td></td><td></td><td></td></tr> <tr><td>FB</td><td>L+</td><td>L</td><td></td><td></td><td></td><td></td><td></td><td></td></tr> <tr><td>FC</td><td>L</td><td></td><td></td><td></td><td></td><td></td><td></td><td></td></tr> <tr><td>FD</td><td>LL</td><td>LL</td><td>LL</td><td>LL</td><td>LL</td><td>LL</td><td>LL</td><td>LL</td></tr> </tbody> </table> <p data-bbox="532 1016 1409 1050">3) In heating operation, the mode changes to [LL] if thermostat is turned off.</p>	CODE No. [5d]	Standard		Type 1		Type 3		Type 6		0000		0001		0003		0006		SW501 (1)/(2)	OFF/OFF		ON/OFF		OFF/ON		ON/ON		Tap	HEAT	COOL	HEAT	COOL	HEAT	COOL	HEAT	COOL	F1					HH	HH	HH	HH	F2			HH	HH					F3				H+	H+, H	H+, H	H+, H L+, L	H+, H L+, L	F4			H+						F5		HH		H					F6	HH		H		L+	L+			F7	H+	H+			L	L			F8		H		L+					F9	H		L+	L					FA		L+	L						FB	L+	L							FC	L								FD	LL	LL	LL	LL	LL	LL	LL	LL	Selection of high ceiling type CODE No. : [5d] or selection of high ceiling on P.C. board SW501
CODE No. [5d]	Standard			Type 1		Type 3		Type 6																																																																																																																																																			
	0000		0001		0003		0006																																																																																																																																																				
SW501 (1)/(2)	OFF/OFF		ON/OFF		OFF/ON		ON/ON																																																																																																																																																				
Tap	HEAT	COOL	HEAT	COOL	HEAT	COOL	HEAT	COOL																																																																																																																																																			
F1					HH	HH	HH	HH																																																																																																																																																			
F2			HH	HH																																																																																																																																																							
F3				H+	H+, H	H+, H	H+, H L+, L	H+, H L+, L																																																																																																																																																			
F4			H+																																																																																																																																																								
F5		HH		H																																																																																																																																																							
F6	HH		H		L+	L+																																																																																																																																																					
F7	H+	H+			L	L																																																																																																																																																					
F8		H		L+																																																																																																																																																							
F9	H		L+	L																																																																																																																																																							
FA		L+	L																																																																																																																																																								
FB	L+	L																																																																																																																																																									
FC	L																																																																																																																																																										
FD	LL	LL	LL	LL	LL	LL	LL	LL																																																																																																																																																			
7	Prevention of cold air discharge	<p data-bbox="532 1129 1089 1276">1. In heating operation, the higher temperature of TC2 sensor and TCJ sensor is compared with temperature of TC1 sensor and then the lower temperature is used to set the upper limit of the fan tap.</p> <ul data-bbox="570 1283 1081 1401" style="list-style-type: none"> • When B zone has continued for 6 minutes, the operation shifts to C zone. • In defrost time, the control point is set to +6°C. 	<p data-bbox="1130 1129 1451 1188">TCJ: Temperature of indoor heat exchanger sensor</p> <ul data-bbox="1130 1195 1459 1317" style="list-style-type: none"> • In D and E zones, priority is given to remote controller air speed setup. • In A zone “❄️” is displayed. 																																																																																																																																																								





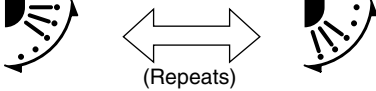

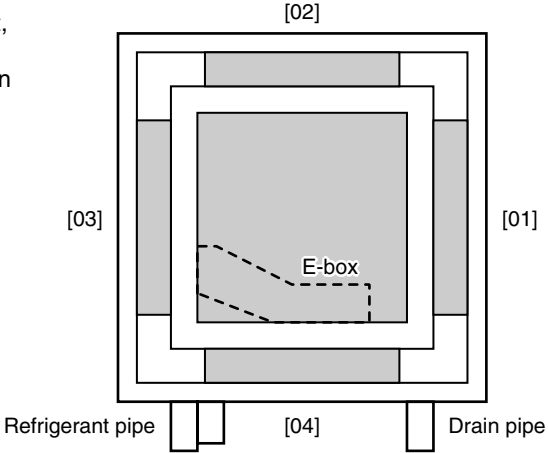

No.	Item	Outline of specifications	Remarks
8	Freeze prevention control (Low temp. release)	<p>1. In all cooling operation, the air conditioner operates as de-scribed below based upon temp. detected by TC1, TC2 and TCJ sensors.</p> <ul style="list-style-type: none"> • When “J” zone is detected for 5 minutes, the thermostat is forcedly off. • In “K” zone, the timer count is interrupted, and held. • When “I” zone is detected, the timer is cleared and the operation returns to the normal operation. • If “J” zone continues, operation of the indoor fan in LOW mode continues until it reaches the “I” zone. It is reset when the following conditions are satisfied. <p>Reset conditions</p> <p>1) TC1 > 12°C and TC2 > 12°C and TCJ > 12°C</p> <p>2) 20 minutes passed after stop.</p>  <p>2. In all cooling operation, the air conditioner operates as described below based upon temp. detected by TC2 and TCJ sensors.</p> <ul style="list-style-type: none"> • When “M” zone is detected for 45 minutes, the thermostat is forcedly off. • In “N” zone, the timer count is interrupted and held. • When shifting to “M” zone again, the timer count restarts and continues. • If “L” zone is detected, the timer is cleared and the operation returns to normal operation. <p>Reset conditions</p> <p>1) TC1 > 12°C and TC2 > 12°C and TCJ > 12°C</p> <p>2) 20 minutes passed after stop.</p> 	<p>TC1: Temperature of indoor heat exchanger sensor</p> <p>() value: When the power supply is turned on, the Forced thermo becomes OFF if the temperature is less than this indicated temperature.</p>
9	Recovery control for cooling oil (Refrigerant)	<p>The indoor unit which is under STOP/Thermo-OFF status or which operates in [FAN] mode performs the following controls when it received the cooling oil (Refrigerant) recovery signal from the outdoor unit.</p> <ol style="list-style-type: none"> 1) Opens PMV of the indoor unit with a constant opening degree. 2) Operates the drain pump for approx. 1 minute during recovery control and after finish of control. 	<ul style="list-style-type: none"> • Recovery operation is usually performed every 2 hours.

No.	Item	Outline of specifications	Remarks		
10	Recovery control for heating refrigerant (Oil)	<p>The indoor unit which is under STOP/Thermo-OFF status or which operates in [FAN] mode performs the following controls when it received the heating refrigerant (Oil) recovery signal from the outdoor unit.</p> <ol style="list-style-type: none"> 1) Opens PMV of the indoor unit with a constant opening degree. 2) Detects temperature of TC2 and then closes PMV. 3) Counts No. of recovery controls and operates the indoor fan and the drain pump for approx. 1 minute after finish of recovery control until the control count reaches the specified count. 	<ul style="list-style-type: none"> • The indoor unit which is under thermo-OFF (COOL) status or which operates in [FAN] mode stops the indoor fan and displays [READY ]. • Recovery operation is usually performed every 1 hour. 		
11	Compensation control for short intermittent operation	<ol style="list-style-type: none"> 1) For 5 minutes after start of operation, the operation is forcedly continued even if the unit enters in Thermo-OFF condition. 2) However the thermostat is OFF giving prior to COOL/HEAT selection, READY  for operation and protective control. 			
12	Drain pump control	<ol style="list-style-type: none"> 1) In cooling operation (including DRY operation), this control anytime operates the drain pump. 2) During operation of the drain pump, if the float switch operates, the drain pump continuously operates and a check code is issued. 3) During stop status of the drain pump, if the float switch operates, the thermostat is forcedly off and this control operates the drain pump. After continuous operation of the float switch for approx. 5 minutes, this control stops the operation and a check code is issued. 	Check Code [P10]		
13	Elimination of retained heat	<ol style="list-style-type: none"> 1) When the unit stopped from [HEAT] operation, the indoor fan operates with [L] for approx. 30 seconds. 			
14	HA control	<ol style="list-style-type: none"> 1) ON/OFF operation is available by input of HA signal from the remote site when connected to remote controller or the remote ON/OFF interface. 2) HA control outputs ON/OFF status to HA terminal. 3) The I/O specifications of HA conform to JEMA standard. 	<p>When using HA terminal (CN61) for the remote ON/OFF, a connector sold separately is necessary.</p> <p>In case of group operation, use the connector to connect HA terminal to either header or follower indoor unit.</p>		
15	Display of filter sign [] (Not provided to the wireless type)	<ol style="list-style-type: none"> 1) The filter sign is displayed with LC by sending the filter-reset signal to the remote controller when the specified time (150H/2500H) elapsed as a result of integration of the operation time of the indoor fan. 2) The integrated timer is cleared when the filter-reset signal is received from the remote controller. In this time, if the specified time elapsed, the counted time is reset and the LC display is deleted. <table border="1" data-bbox="486 1893 858 1932" style="margin-left: auto; margin-right: auto;"> <tr> <td style="padding: 2px;">Filter time</td> <td style="padding: 2px;">2500H</td> </tr> </table>	Filter time	2500H	[ FILTER] goes on.
Filter time	2500H				

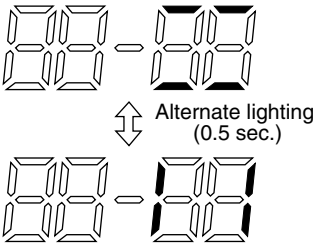
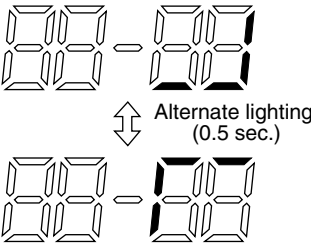
No.	Item	Outline of specifications	Remarks																																																		
16	Display of [READY] [HEAT READY]	<p>< READY > Displayed on the remote controller</p> <ol style="list-style-type: none"> 1) When the following check codes are indicated <ul style="list-style-type: none"> • Open phase of power supply wiring [P05] was detected. • There is an indoor unit that detected the indoor overflow [P10]. • There is an indoor unit that detected the interlock alarm [L30]. 2) During Force Thermo-OFF <ul style="list-style-type: none"> • [COOL/DRY] operation is unavailable because the other indoor unit operates with [HEAT] mode. • [HEAT] operation is unavailable because COOL priority (SW11-bit1 of the Outdoor I/F P. C. board is ON) is set and the other indoor unit operates with [COOL/DRY] mode. 3) The above indoor units that cannot operate stay in Thermo-OFF status. 4) The indoor fan stops because the system performs [Recovery operation for heating refrigerant (Oil)]. <p>< HEAT READY > Displayed on the remote controller The indoor fan stops in order to prevent discharge of cool air when heating operation started or during heating operation. (including the defrost operation during thermo-OFF)</p>	<ul style="list-style-type: none"> • < READY > display No display for wireless type remote controller • < HEAT READY > display 																																																		
17	Selection of central control mode	<ol style="list-style-type: none"> 1) Selection of the contents that can be operated by the remote controller at the indoor unit side is possible according to setting at the central controller side. 2) Setting contents <p>• In case of TCC-LINK central control</p> <table border="1" data-bbox="235 1122 1429 1378"> <thead> <tr> <th rowspan="2">Operation from TCC-LINK central control</th> <th colspan="6">Operation on RBC-AMT32E</th> <th rowspan="2">On RBC-AMT32E</th> </tr> <tr> <th>ON/OFF setting</th> <th>Operation selection</th> <th>Timer setting</th> <th>Temp. setting</th> <th>Air speed setting</th> <th>Air direction setting</th> </tr> </thead> <tbody> <tr> <td>Individual</td> <td>○</td> <td>○</td> <td>○</td> <td>○</td> <td>○</td> <td>○</td> <td rowspan="5">[Central control] display</td> </tr> <tr> <td>[Central 1]</td> <td>×</td> <td>○</td> <td>×</td> <td>○</td> <td>○</td> <td>○</td> </tr> <tr> <td>[Central 2]</td> <td>×</td> <td>×</td> <td>×</td> <td>×</td> <td>○</td> <td>○</td> </tr> <tr> <td>[Central 3]</td> <td>○</td> <td>×</td> <td>○</td> <td>×</td> <td>○</td> <td>○</td> </tr> <tr> <td>[Central 4]</td> <td>○</td> <td>×</td> <td>○</td> <td>○</td> <td>○</td> <td>○</td> </tr> </tbody> </table> <p>(○: Operation possible ×: Operation impossible)</p>	Operation from TCC-LINK central control	Operation on RBC-AMT32E						On RBC-AMT32E	ON/OFF setting	Operation selection	Timer setting	Temp. setting	Air speed setting	Air direction setting	Individual	○	○	○	○	○	○	[Central control] display	[Central 1]	×	○	×	○	○	○	[Central 2]	×	×	×	×	○	○	[Central 3]	○	×	○	×	○	○	[Central 4]	○	×	○	○	○	○	
Operation from TCC-LINK central control	Operation on RBC-AMT32E						On RBC-AMT32E																																														
	ON/OFF setting	Operation selection	Timer setting	Temp. setting	Air speed setting	Air direction setting																																															
Individual	○	○	○	○	○	○	[Central control] display																																														
[Central 1]	×	○	×	○	○	○																																															
[Central 2]	×	×	×	×	○	○																																															
[Central 3]	○	×	○	×	○	○																																															
[Central 4]	○	×	○	○	○	○																																															

No.	Item	Outline of specifications	Remarks
18	Louver control:	<p>1) Louver position setup</p> <ul style="list-style-type: none"> When the louver position is changed, the position moves necessarily to downward discharge position once to return to the set position. The louver position can be set up in the following operation range. <p>In cooling/dry operation In heating/fan operation</p>  <ul style="list-style-type: none"> In group twin/triple operation, the louver positions can be set up collectively or individually. In case that HEAT refrigerant recovery control was performed in STOP status, the louver position becomes horizontal when the operation is resumed. <p>2) Swing setup</p> <ul style="list-style-type: none"> [SWING] is displayed and the following display is repeated. <p style="text-align: center;">In all operations</p>  <ul style="list-style-type: none"> In group operation, the louver positions can be set up collectively or individually. <p>3) When the unit stopped or the warning was output, the louver is automatically set to full closed position.</p> <p>4) When PRE-HEAT (Heating ready) is displayed (Heating operation started or defrost operation is performed), heating thermo is off or self-cleaning is performed, the louver is automatically set to horizontal discharge position.</p> <p>* The louver which air direction is individually set or the locked louver closes fully when the unit stops and the louver is automatically set to horizontal discharge position when PRE-HEAT (Heating ready) is displayed, heating thermo is off.</p> <p><<Individual air direction setup>></p> <ul style="list-style-type: none"> Pushing  Louver select button enables every discharge port to set up the air direction. The louver numbers that are displayed on the display part correspond to those in the following figure. In case of no input (key operation) for approx. 5 seconds during setting of individual air direction (during displaying of louver No. on the remote controller screen), the remote controller screen returns to the normal display screen. For the air direction illustration during normal operation, the air direction of the least No. among the louvers which are block-set is displayed. While individual air direction is being set, the remote controller operation (Illustration of air direction) and operation of the real machine are linked. When selecting a case,  Louver select button is not pushed or louver No. is not displayed, the air directions of all the louvers are collectively set up. 	<p>The louver position at horizontal discharge position at under AP030 differs from that at over AP036.</p> <p>The swinging louver moves usually up to the ceiling side from the louver position of the set time.</p> <p>Setup from the remote controller without  button is unavailable.</p> <p>For the setup operation, refer to "How to set up louver individually" of Item "Setup at local site/ Others".</p> 

No.	Item	Outline of specifications	Remarks															
18	Louver control (Continued):	<p><<Selection of Swing mode>></p> <ul style="list-style-type: none"> For the Swing mode, the following three types of modes are selectable and settable by keeping Swing/Direction  button pushed for 4 seconds or more on the remote controller. <p>1) Standard (4 pieces: same phase) swing → Data: [0001 (At shipment)] When Swing operation is selected, four louvers align at the horizontal discharge position and then start the Swing operation at the same time.</p> <p>2) Dual swing → Data: [0002] When operation is selected, the louvers of louver No. [01] and [03] move to the horizontal discharge position, the louvers of louver No. [02] and [04] move to the downward discharge position and then start the Swing operation at the same time.</p> <p>3) Cycle swing → Data: [0003] When operation is selected, the louver No. [01] moves to the horizontal discharge position, [03] to the downward discharge position, [02] and [04] to the middle position and then start the Swing operation at the same time.</p> <ul style="list-style-type: none"> Three types of the swing modes can be also selected and set by the setup data of Item code (DN) [F0]. In case of selecting the Swing mode, “Dual swing” or “Cycle swing”, the following numerals is displayed at the center of the remote controller screen for approx. 3 seconds when  button was pushed to select [SWING]. (No display for the standard swing) <div style="display: flex; justify-content: space-around; align-items: center;"> <div style="text-align: center;">  <p>Dual swing</p> </div> <div style="text-align: center;">  <p>Cycle swing</p> </div> </div> <p><<Louver lock (Louver fix)>></p> <ul style="list-style-type: none"> For the air direction setup for each discharge port, the louver position can be locked during the normal operation. An arbitrary air direction of an arbitrary louver can be registered and set by keeping  button pushed for 4 seconds or more on the remote controller. The louver lock can be set by registering the setup data to Item code (DN) [F1] to [F4] according to the following table. <table border="1" style="width: 100%; border-collapse: collapse;"> <thead> <tr> <th>CODE No.</th> <th>Objective louver No.</th> <th>Setup data</th> </tr> </thead> <tbody> <tr> <td>F1</td> <td>01</td> <td>0000: Release (At shipment)</td> </tr> <tr> <td>F2</td> <td>02</td> <td>0001: Horizontal discharge position</td> </tr> <tr> <td>F3</td> <td>03</td> <td style="text-align: center;">~</td> </tr> <tr> <td>F4</td> <td>04</td> <td>0005: Downward discharge position</td> </tr> </tbody> </table>	CODE No.	Objective louver No.	Setup data	F1	01	0000: Release (At shipment)	F2	02	0001: Horizontal discharge position	F3	03	~	F4	04	0005: Downward discharge position	<p>Carry out setting operation during stop of the unit; otherwise the unit stops operation.</p> <p>For the setting operation, refer to [How to set up type of the swings] in Item “7 APPLIED CONTROL”</p> <p>Carry out setting operation during stop of the unit; otherwise the unit stops operation.</p>
CODE No.	Objective louver No.	Setup data																
F1	01	0000: Release (At shipment)																
F2	02	0001: Horizontal discharge position																
F3	03	~																
F4	04	0005: Downward discharge position																

No.	Item	Outline of specifications	Remarks																		
18	Louver control (Continued):	<ul style="list-style-type: none"> • If there is the locked louver in the unit, [] goes on the remote controller screen. • While the following controls are performed, the louvers operate even if executing the louver lock. <table border="1" data-bbox="474 369 1386 621" style="width: 100%; border-collapse: collapse; text-align: center;"> <thead> <tr> <th style="width: 10%;"></th> <th style="width: 55%;">Control which ignores lock</th> <th style="width: 35%;">Objective louver No.</th> </tr> </thead> <tbody> <tr> <td>①</td> <td>Operation stop</td> <td>Horizontal discharge position</td> </tr> <tr> <td>②</td> <td>When heating operation started</td> <td>Horizontal discharge position</td> </tr> <tr> <td>③</td> <td>Heating thermo. OFF</td> <td>Horizontal discharge position</td> </tr> <tr> <td>④</td> <td>During defrost operation</td> <td>Horizontal discharge position</td> </tr> <tr> <td>⑤</td> <td>Initialize operation</td> <td>Full-close position</td> </tr> </tbody> </table> <ul style="list-style-type: none"> • The real louver corresponding to the louver No. displayed on the remote controller screen during setting of louver lock operates swinging. 		Control which ignores lock	Objective louver No.	①	Operation stop	Horizontal discharge position	②	When heating operation started	Horizontal discharge position	③	Heating thermo. OFF	Horizontal discharge position	④	During defrost operation	Horizontal discharge position	⑤	Initialize operation	Full-close position	<p>For the setting operation, refer to [How to set louver lock] of Installation Manual.</p> <p>It is position check operation and it does not link with the real louver and air direction setup (Illustration on the remote controller screen).</p>
	Control which ignores lock	Objective louver No.																			
①	Operation stop	Horizontal discharge position																			
②	When heating operation started	Horizontal discharge position																			
③	Heating thermo. OFF	Horizontal discharge position																			
④	During defrost operation	Horizontal discharge position																			
⑤	Initialize operation	Full-close position																			
19	DC motor	<ol style="list-style-type: none"> 1) When the fan stator, positioning is performed for the starter and the rotor. (Vibrate slightly) 2) DC motor operates according to the command from the indoor controller. <p>(Note) If the fan rotates by entry of outside air, etc while the air conditioner stopped, the indoor unit may operate as the fan motor stops.</p> <p>(Note) If the fan lock was detected, the operation of the indoor unit stops and the error is displayed.</p>	Check code [P12]																		
20	Save operation	<ol style="list-style-type: none"> 1) The function [Save operation] is not provided to the Super Modular Multi series models. 	<ul style="list-style-type: none"> • If pushing [SAVE] button “  ” on the remote controller, “No function” is displayed. 																		

6. CONFIGURATION OF CONTROL CIRCUIT

6-1. Indoor Unit

6-1-1. Indoor Controller Block Diagram

1. Connection of wired remote controller

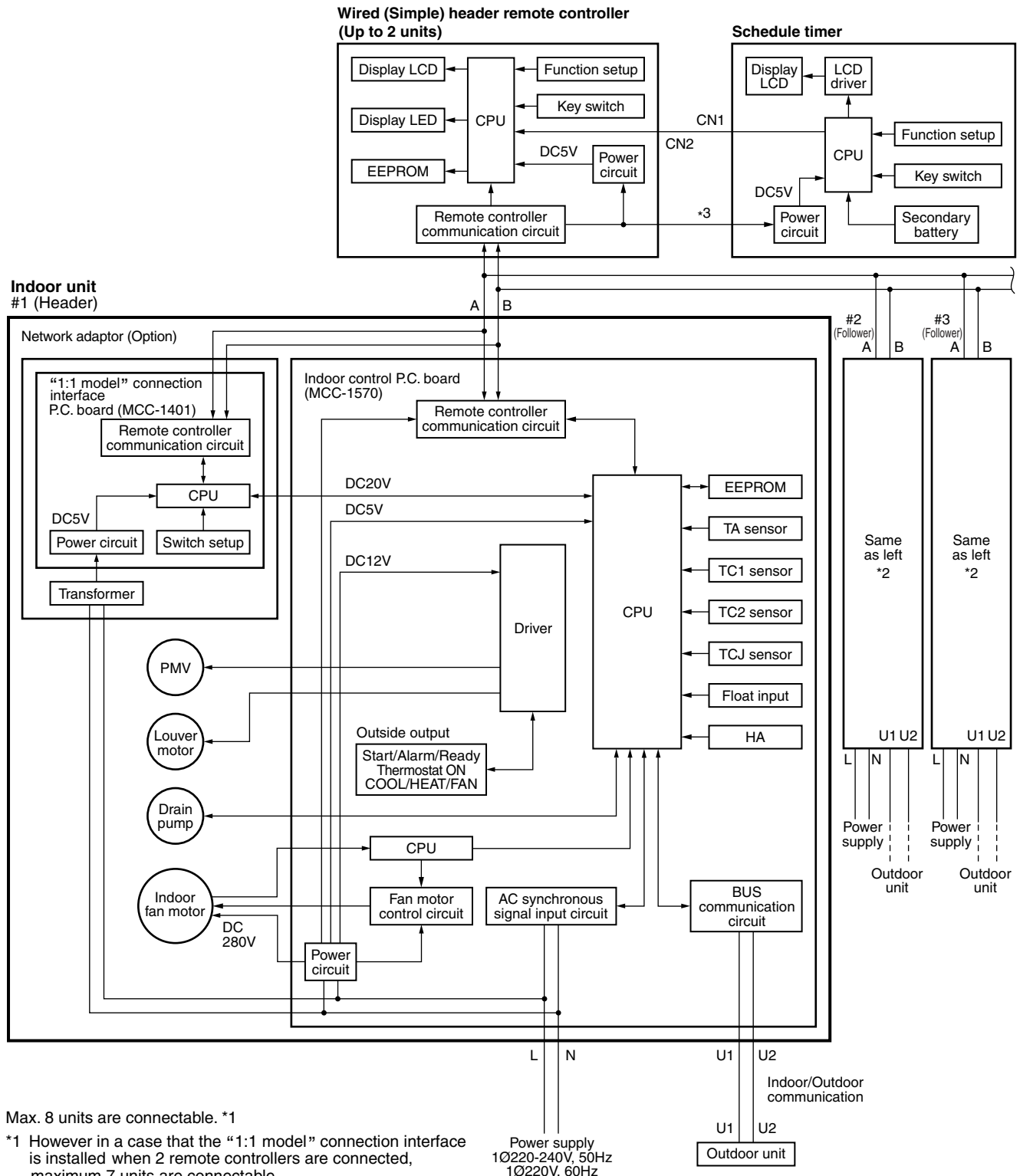

Max. 8 units are connectable. *1

*1 However in a case that the "1:1 model" connection interface is installed when 2 remote controllers are connected, maximum 7 units are connectable.

*2 The "1:1 model" connection interface is installed to only one unit.

*3 The schedule timer cannot be connected to the simple wired remote controller.

2. Connection of wired remote controller kit

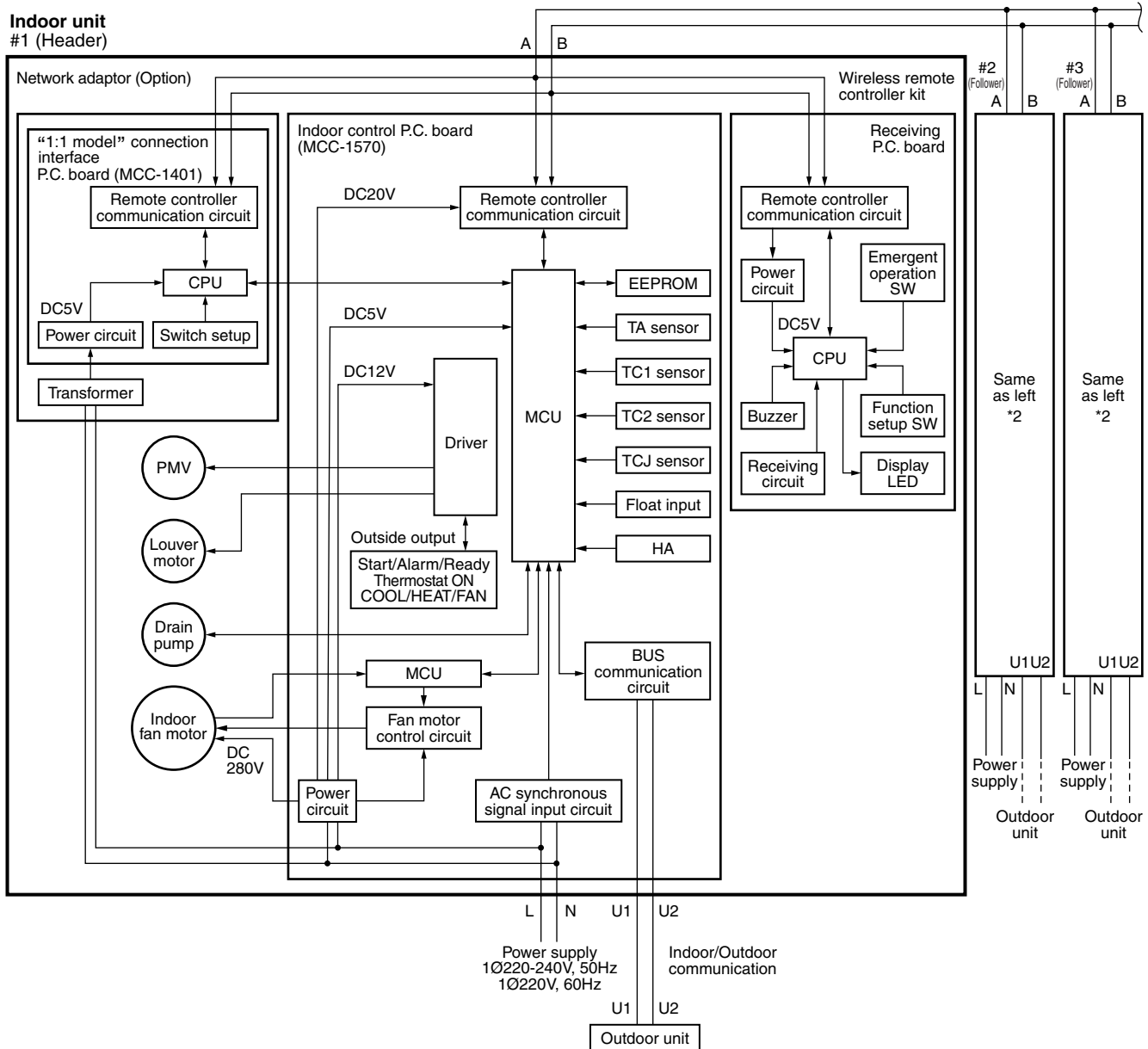

Max. 8 units are connectable. *1

*1 However in a case that the "1:1 model" connection interface is installed when 2 wireless remote controller kits are connected, maximum 7 units are connectable.

*2 The "1:1 model" connection interface is installed to only

3. Connection of both wired remote controller and wireless remote controller kit

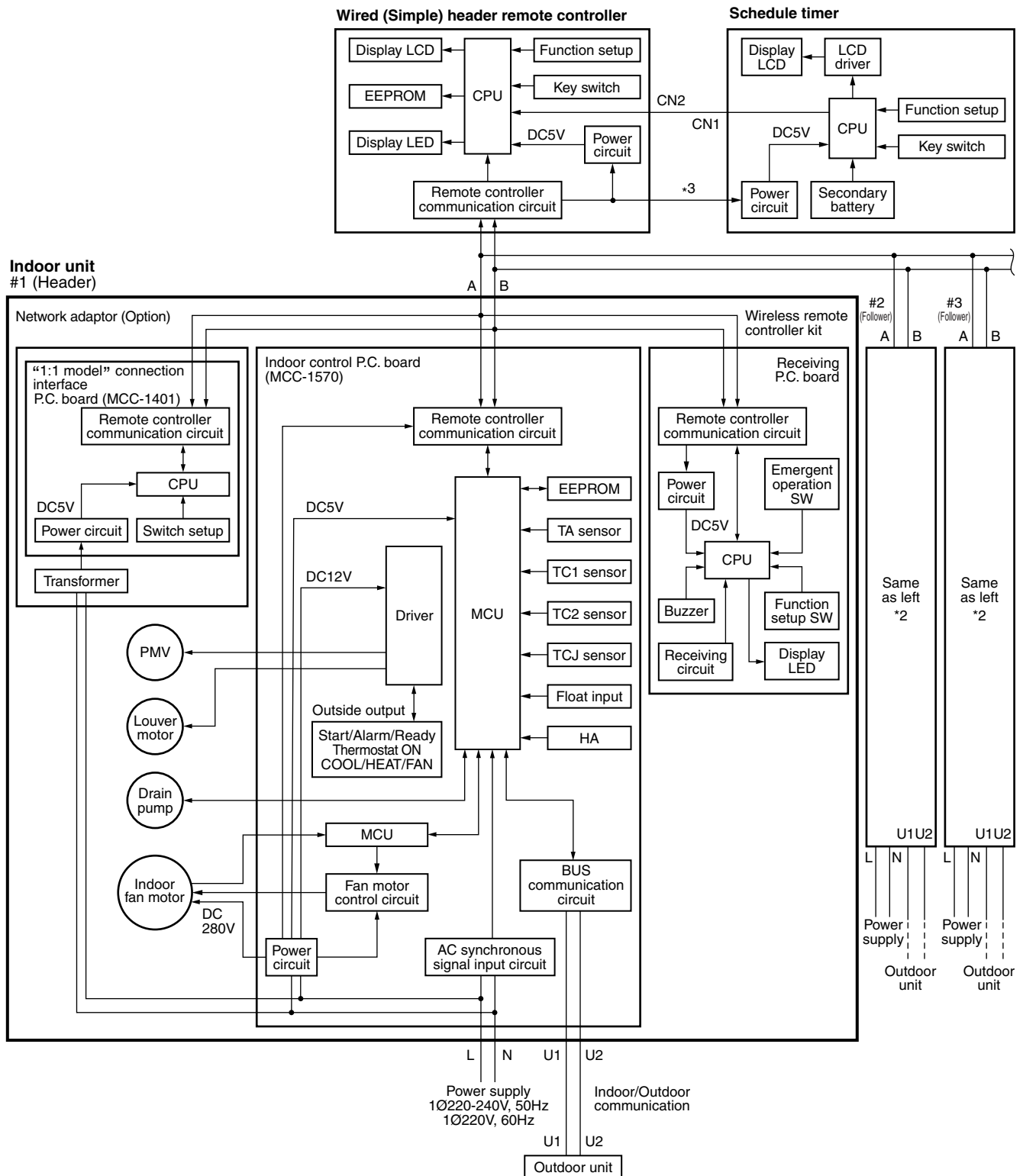

Max. 8 units are connectable. *1

*1 However in a case that the "1:1 model" connection interface is installed when 2 wireless remote controller kits are connected, maximum 7 units are connectable.

*2 The "1:1 model" connection interface is installed to only

*3 The schedule timer cannot be connected to the simple wired remote controller.

6-2. Indoor P.C. board

MCC-1570

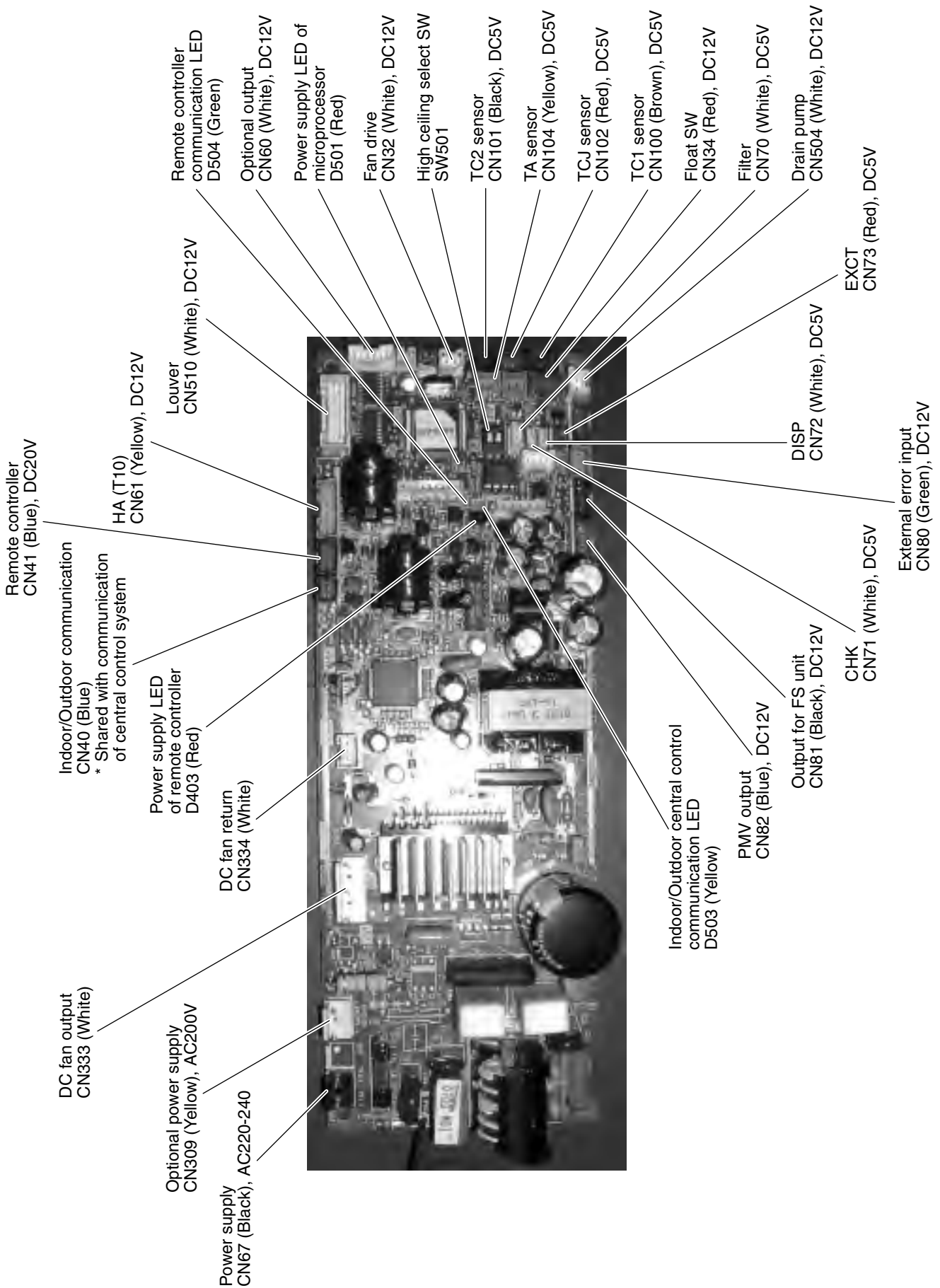

6-3. Functions at test run

■ Cooling/Heating test run check

The test run for cooling/heating can be performed from either indoor remote controller or outdoor interface P.C. board.

1. Start/Finish operation of test run

⊙ Test run from indoor remote controller

- └ Wired remote controller: Refer to the below item of “Test run” of the wired remote controller.
- └ Wireless remote controller: Refer to the next page item of “Test run” of the wireless remote controller.

◆ In case of wired remote controller

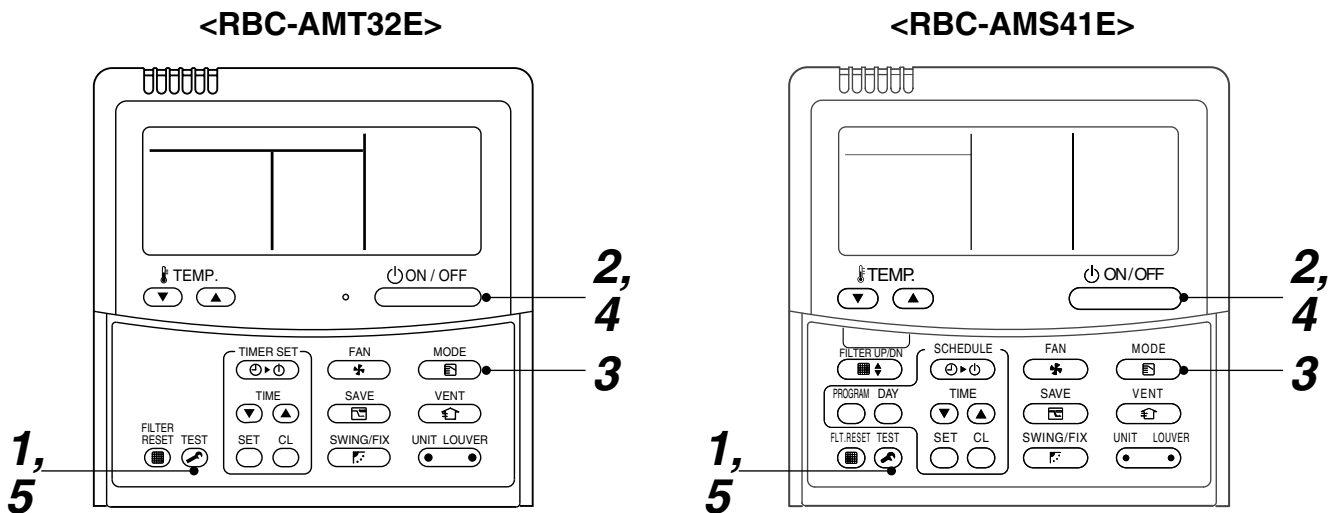

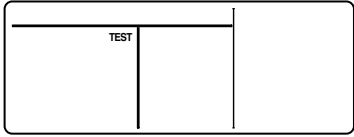
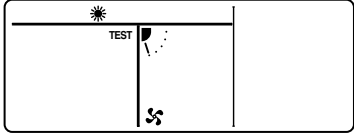
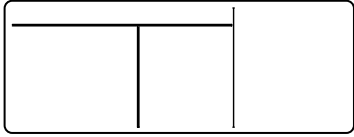
Procedure	Operation contents
1	<p>Push [TEST] button for 4 seconds or more. [TEST] is displayed at the display part and the mode enters in TEST mode.</p> 
2	<p>Push [ON/OFF] button.</p>
3	<p>Change the mode from [COOL] to [HEAT] using [MODE] button.</p> <ul style="list-style-type: none"> • Do not use [MODE] button for other mode except [COOL]/[HEAT] modes. • The temperature cannot be adjusted during test run. • The error detection is performed as usual. 
4	<p>After test run, push [ON/OFF] button to stop the operation. (Display on the display part is same to that in Procedure 1.)</p>
5	<p>Push [TEST] button to clear the TEST mode. ([TEST] display in the display part disappears and status becomes the normal stop status.)</p> 

Note) The test run returns to the normal operation after 60 minutes.

◆ In case of wireless remote controller

1. When TEMPORARY button is pushed for 10 seconds or more, "Pi!" sound is heard and the operation changes to a forced cooling operation. After approx. 3 minutes, a cooling operation starts forcedly. Check cool air starts blowing. If the operation does not start, check wiring again.
2. To stop a test operation, push TEMPORARY button once again (Approx. 1 second).
 - Check wiring / piping of the indoor and outdoor units in forced cooling operation.

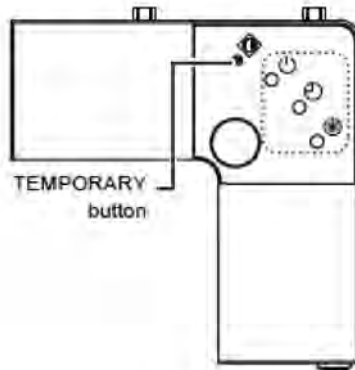

■ Check function for operation of indoor unit (Functions at indoor unit side)

This function is provided to check the operation of the indoor unit singly without communication with the remote controller or the outdoor unit. This function can be used regardless of operation or stop of the system.

However, if using this function for a long time, a trouble of the equipment may be caused. Limit using this function within several minutes.

[How to operate]

- 1) Short-circuit CHK pin (CN71 on the indoor P.C. board).

The operation mode differs according to the indoor unit status in that time.

Normal time: Both float SW and fan motor are normal.

Abnormal time: Either one of float SW or fan motor is abnormal.

- 2) Restricted to the normal time, if short-circuiting DISP pin (CN72 on the indoor P.C. board) in addition to short-circuit of CHK pin (CN71 on the indoor P.C. board), the minimum opening degree (30pls) can be set to the indoor PMV only.

When open DISP pin, the maximum opening degree (1500pls) can be obtained again.

[How to clear]

Open CHK pin. While the system is operating, it stops once but automatically returns to operation after several minutes.

	Short-circuit of CHK pin		
	Normal time		Abnormal time
	DISP pin open	DISP pin short circuit	
Fan motor	(H)	(H)	Stop
Indoor PMV (*)	Max. opening degree (1500pls)	Min. opening degree (30pls)	Min. opening degree (30pls)
Louver	Horizontal	Horizontal	Immediate stop
Drain pump	ON	ON	ON
Communication	All ignored	All ignored	All ignored
P.C. board LED	Lights	Lights	Flashes

- To exchange the indoor PMV coil, set the indoor PMV to Max. opening degree.
- For the detailed positions of CHK pin (CN71 on indoor P.C. board) and DISP pin (CN72 on indoor P.C. board), refer to the indoor P.C. board MCC-1570.

6-4. Optional Connector Specifications of Indoor P.C. Board

Function	Connector No.	Pin No.	Specifications	Remarks
—	CN66	—	—	—
Fan output	CN32	①	DC12V	Shipment setup: ON with indoor unit operation and OFF with stop are linked. * Single operation by FAN button on remote controller is set up from remote controller (DN=31)
		②	Output	
HA	CN61	①	ON/OFF input	HA ON/OFF input (J01: YES/NO= Pulse (At shipment) / Static input select)
		②	0V (COM)	
		③	Main prohibition input	Operation stop of main remote controller is permitted / prohibited by input.
		④	Operation output	ON during operation (Answerback of HA)
		⑤	DC12V (COM)	
		⑥	Alarm output	ON during alarm output
Option output	CN60	①	DC12V (COM)	
		②	Defrost output	ON when outdoor unit is defrosted
		③	Thermo ON output	ON during Real thermostat ON (Compressor ON)
		④	COOL output	ON when operation mode is cooling system (COOL, DRY, Cool/Heat Auto cooling)
		⑤	HEAT output	ON when operation mode is heating system (HEAT, Cool/Heat Auto cooling)
		⑥	Fan output	ON when indoor fan is ON (During use of air cleaner/Interlock cabling)
Outside error input	CN80	①	DC12V (COM)	Generate check code "L30" (for 1 minute continuously) to stop forcibly the operation.
		②	DC12V (COM)	
		③	Outside error input	
—	CN20	—	—	—
—	CN70	—	—	—
CHK operation check	CN71	①	Check mode input	Used for indoor operation check. (Outdoor does not communicate with remote controller, and outputs specified operation such as indoor fan "H", drain pump ON, etc.)
		②	0V	
DISP exhibition mode	CN72	①	Display mode input	Exhibition mode enables to communicate by indoor unit and remote controller only. (When power has been turned on.) Timer short (Usual)
		②	0V	
EXCT demand	CN73	①	Demand input	Indoor unit forced thermostat OFF operation
		②	0V	

7. APPLIED CONTROL

7-1. Setup of Selecting Function in Indoor Unit (Be Sure to Execute Setup by a Wired Remote Controller)

<Procedure> Execute the setup operation while the unit stops.

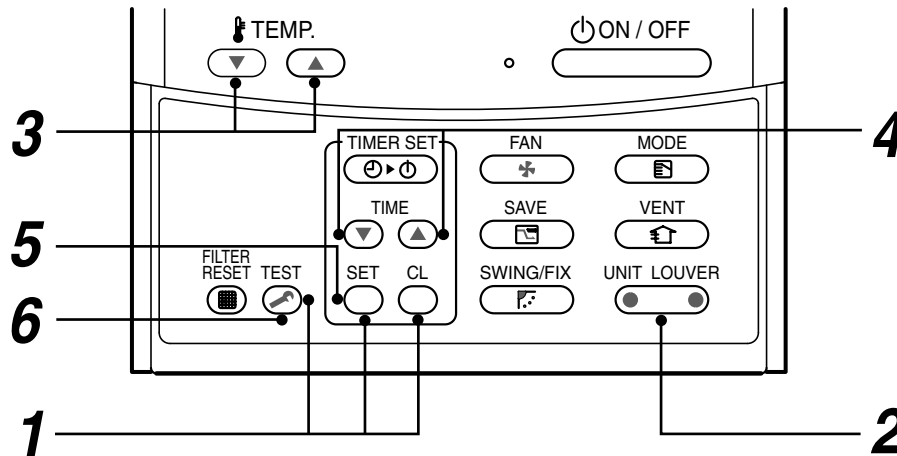

- 1** Push **SET**, **CL**, and **TEST** buttons simultaneously for 4 seconds or more.
The firstly displayed unit No. indicates the header indoor unit address in the group control.
In this time, the fan of the selected indoor unit is turned on.
- 2** Every pushing **UNIT LOUVER** (left side button) button, the indoor unit numbers in the group control are successively displayed. In this time, the fan of the selected indoor unit only is turned on.
- 3** Specify the CODE No. (DN) using the setup temperature **▼** and **▲** buttons.
- 4** Select the setup data using the timer time **▼** and **▲** buttons.
(When selecting the DN code to “33”, change the temperature indication of the unit from “°C” to “°F” on the remote controller.)
- 5** Push **SET** button. (OK if display goes on.)
 - To change the selected indoor unit, return to procedure **2**.
 - To change the CODE No. to be set up, return to procedure **3**.
- 6** Pushing **TEST** button returns the status to normal stop status.

Table: Function selecting CODE No. (DN)
(Items necessary to perform the applied control at the local site are described.)

DN	Item	Description	At shipment
01	Filter display delay timer	0000 : None 0002 : 2500H 0004 : 10000H 0001 : 150H 0003 : 5000H	0002 : 2500H
02	Dirty state of filter	0000 : Standard 0001 : High degree of dirt (Half of standard time)	0000 : Standard
03	Central control address	0001 : No.1 unit to 0064 : No.64 unit 0099 : Unfixed	0099 : Unfixed
04	Specific indoor unit priority	0000 : No priority 0001 : Priority	0000 : No priority
06	Heating temp shift	0000 : No shift to 0001 : +1°C 0002 : +2°C to 0010 : +10°C (Up to +6 recommended)	0002 : +2°C (Floor type 0000: 0°C)
0d	Existence of [AUTO] mode	0000 : Provided 0001 : Not provided (Automatic selection from connected outdoor unit)	0001 : Not provided
0F	Cooling only	0000 : Heat pump 0001 : Cooling only (No display of [AUTO] [HEAT])	0000 : Heat pump
10	Type	0001: 4-way Cassette	Depending on model type
11	Indoor unit capacity	0000 : Unfixed 0001 to 0034	According to capacity type
12	Line address	0001 : No.1 unit to 0030 : No.30 unit	0099 : Unfixed
13	Indoor unit address	0001 : No.1 unit to 0064 : No.64 unit	0099 : Unfixed
14	Group address	0000 : Individual 0002 : Follower unit of group 0001 : Header unit of group	0099 : Unfixed
19	Louver type (Air direction adjustment)	0000: No louver 0001: Swing only 0002: (1-way Cassette type, Ceiling type) 0003: (2-way Cassette type) 0004: (4-way Cassette type)	According to type
1E	Temp difference of [AUTO] mode selection COOL → HEAT, HEAT → COOL	0000 : 0 deg to 0010 : 10 deg (For setup temperature, reversal of COOL/HEAT by ± (Data value)/2)	0003 : 3 deg (Ts±1.5)
28	Automatic restart of power failure	0000 : None 0001 : Restart	0000 : None
2A	Selection of option/error input (CN70)	0000 : Filter input 0002 : None 0001 : Alarm input (Air washer, etc.)	0002 : None
2E	HA terminal (CN61) select	0000 : Usual 0002 : Fire alarm input 0001 : Leaving-ON prevention control	0000 : Usual (HA terminal)
31	Ventilating fan control	0000 : Unavailable 0001 : Available	0000 : Unavailable
32	TA sensor selection	0000 : Body TA sensor 0001 : Remote controller sensor	0000 : Body TA sensor
33	Temperature unit select	0000 : °C (at factory shipment) 0001 : °F	0000 : °C
F0	Swing mode	0001 : Standard 0003 : Cycle swing 0002 : Dual swing	0001: Standard
F1	Louver fixed position (Louver No.1)	0000 : Release 0005 : Downward discharge position 0001 : Horizontal discharge position	0000: Not fixed
F2	Louver fixed position (Louver No.2)	0000 : Release 0005 : Downward discharge position 0001 : Horizontal discharge position	0000: Not fixed
F3	Louver fixed position (Louver No.3)	0000 : Release 0005 : Downward discharge position 0001 : Horizontal discharge position	0000: Not fixed
F4	Louver fixed position (Louver No.4)	0000 : Release 0005 : Downward discharge position 0001 : Horizontal discharge position	0000: Not fixed

DN	Item	Description							At shipment			
5d	High ceiling selection (Selection of air volume)		Type			AP009, AP012			AP015, AP018			0000: Standard
			Discharge		4-way	3-way	2-way	4-way	3-way	2-way		
		0000	Standard (At shipment)		2.7m	2.8m	3.0m	2.8m	3.2m	3.5m		
		0001	High ceiling ①		—	—	—	3.2m	3.5m	3.8m		
		0003	High ceiling ③		—	—	—	3.5m	3.8m	—		
			Type		AP024 to AP030			AP036 to AP056				
			Discharge		4-way	3-way	2-way	4-way	3-way	2-way		
		0000	Standard (At shipment)		3.0m	3.3m	3.6m	3.0m	3.3m	3.6m		
		0001	High ceiling ①		3.3m	3.5m	3.8m	3.3m	3.5m	3.8m		
		0003	High ceiling ③		3.6m	3.8m	—	3.6m	3.8m	—		
	Built-in filter	0000: Standard filter (At shipment)										
60	Timer setup (Wired remote controller)	0000: Available (Operable) 0001: Unavailable (Operation prohibited)							0000: Available			

TYPE

CODE No. [10]

Setup data	Type	Abbreviated Model name
1 0001	4-way Cassette	MMU-AP XXX HP

*1: Initial setting value of EEPROM installed on the service P.C. board

Indoor unit capacity

CODE No. [11]

Setup data	Model
0003	009
0005	012
0007	015
0009	018
0011	024

Setup data	Model
0012	027
0013	030
0015	036
0017	048
0018	056

7-2. Applied Control in Indoor Unit

■ Remote location ON/OFF control box (TCB-IFCB-4E2)

[Wiring and setup]

- Use the exclusive connector for connection with the indoor control P.C. board.
- In a group control, the system can operate when connecting with any indoor unit (Control P.C. board) in the group. However when taking out the operation/error signal from the other unit, it is necessary to take out from each unit individually.

1. Control items

- 1) Start/Stop input signal : Operation start/stop in unit
- 2) Operation signal : Output during normal operation
- 3) Error signal : Output during alarm
(Serial communication error or indoor/outdoor protective device) operation

2. Wiring diagram using remote control interface (TCB-IFCB-4E2)

Input IFCB-4E2 : No voltage ON/OFF serial signal
 Output No voltage contact for operation, error display
 Contact capacity: Below Max. AC240V 0.5A

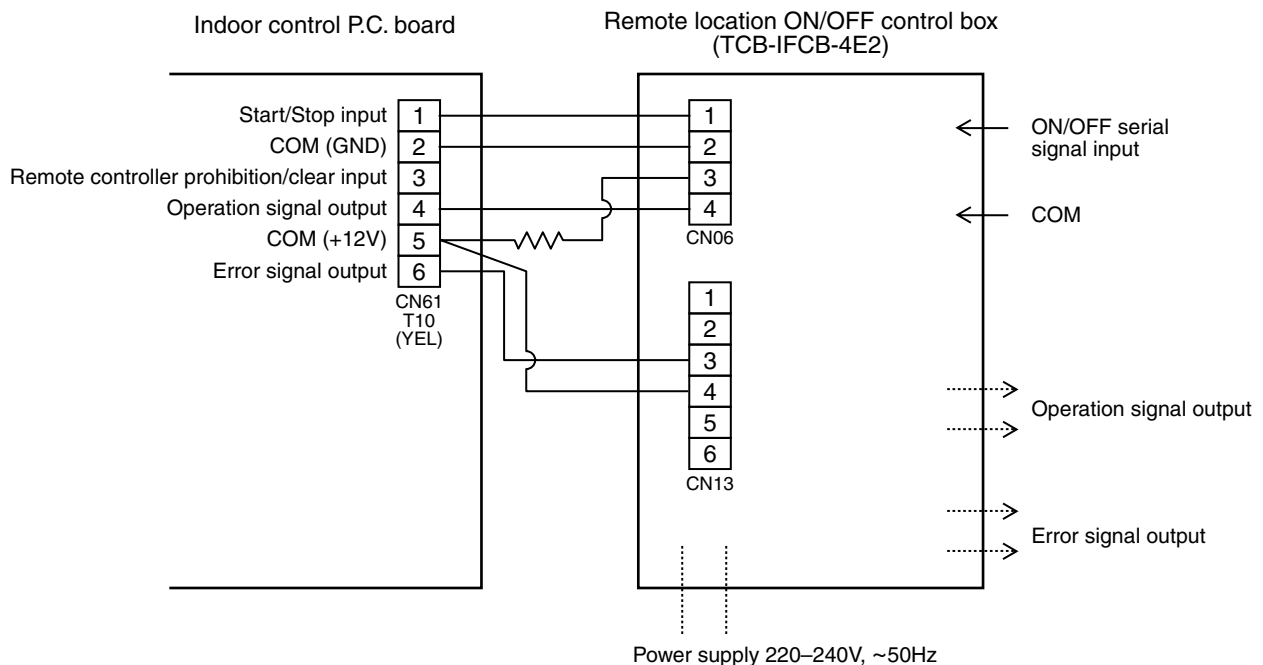

■ Ventilating fan control from remote controller

[Function]

- The start/stop operation can be operated from the wired remote controller when air to air heat exchanger or ventilating fan is installed in the system.
- The fan can be operated even if the indoor unit is not operating.
- Use a fan which can receive the no-voltage A contact as an outside input signal.
- In a group control, the units are collectively operated and they can not be individually operated.

1. Operation

Handle a wired remote controller in the following procedure.

- * Use the wired remote controller during stop of the system.
- * Be sure to set up the wired remote controller to the header unit. (Same in group control)
- * In a group control, if the wired remote controller is set up to the header unit, both header and follower units are simultaneously operable.

1 Push concurrently + + buttons for 4 seconds or more.

The unit No. displayed firstly indicates the header indoor unit address in the group control.
In this time, the fan of the selected indoor unit turns on.

2 Every pushing (left side button) button, the indoor unit numbers in group control are displayed successively.

In this time, the fan of the selected indoor unit only turns on.

3 Using the setup temp or button, specify the CODE No. 31 .

4 Using the timer time or button, select the setup data. (At shipment: 0000)

The setup data are as follows:

Setup data	Handling of operation of air to air heat exchanger or ventilating fan
0000	Unavailable (At shipment)
0001	Available

5 Push button. (OK if display goes on.)

- To change the selected indoor unit, go to the procedure 2).
- To change the item to be set up, go to the procedure 3).

6 Pushing returns the status to the usual stop status.

2. Wiring

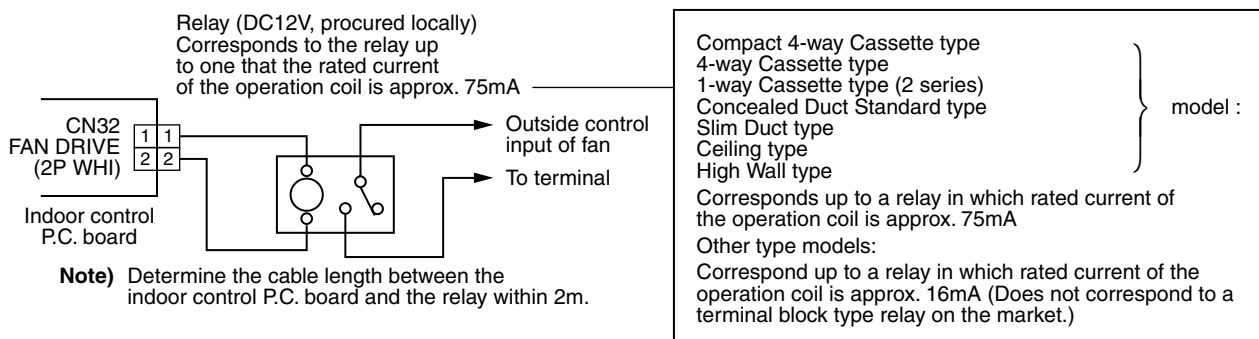

■ Leaving-ON prevention control

[Function]

- This function controls the indoor units individually. It is connected with cable to the control P.C. board of the indoor unit.
- In a group control, it is connected with cable to the indoor unit (Control P.C. board), and the CODE No. 2E is set to the connected indoor unit.
- It is used when the start operation from outside if unnecessary but the stop operation is necessary.
- Using a card switch box, card lock, etc, the forgotten-OFF of the indoor unit can be protected.
- When inserting a card, start/stop operation from the remote controller is allowed.
- When taking out a card, the system stops if the indoor unit is operating and start/stop operation from the remote controller is forbidden.

1. Control items









- 1) Outside contact ON : The start/stop operation from the remote controller is allowed.
(Status that card is inserted in the card switch box)
- 2) Outside contact OFF : If the indoor unit is operating, it is stopped forcedly.
(Start/Stop prohibited to remote controller)
(Status that card is taken out from the card switch box)

* When the card switch box does not perform the above contact operation, convert it using a relay with b contact.

2. Operation

Handle the wired remote controller switch in the following procedure.

* Use the wired remote controller switch during stop of the system.

- 1** Push concurrently  +  +  buttons for 4 seconds or more.
- 2** Using the setup temp  or  button, specify the CODE No. 2E.
- 3** Using the timer time  or  button, set 0001 to the setup data.
- 4** Push  button.
- 5** Push  button. (The status returns to the usual stop status.)

3. Wiring

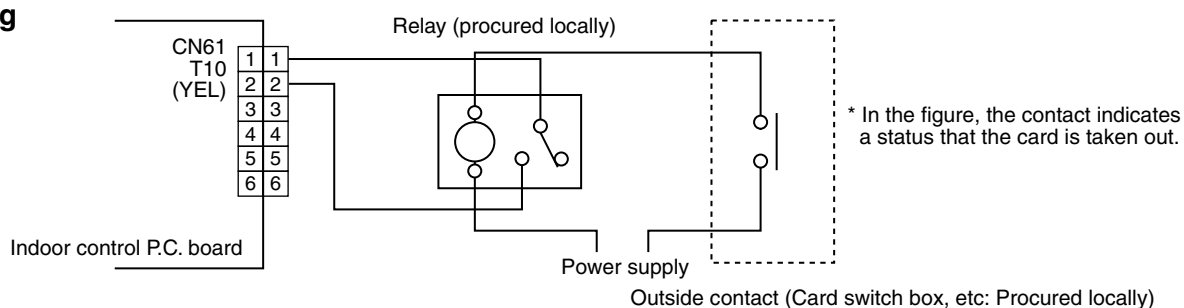

Note) Determine the cable length between the indoor control P.C. board and the relay within 2m.

■ Power peak-cut from indoor unit

When the relay is turned on, a forced thermostat-OFF operation starts.

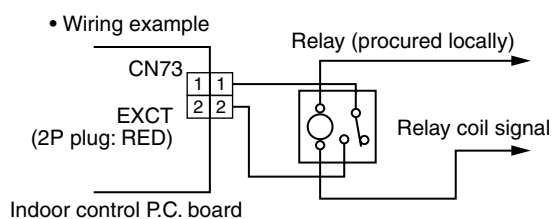

Note) Determine the cable length between the indoor or outdoor control P.C. board and the relay within 2m.

■ Address setup (Manual setting from remote controller)

In case that addresses of the indoor units will be determined prior to piping work after cabling work

- Set an indoor unit per a remote controller.
- Turn on power supply.

1 Push **SET** + **CL** + **TEST** buttons simultaneously for 4 seconds or more.

2 (Line address)
Using the temperature setup **▼** / **▲** buttons, set **1** to the CODE No.

3 Using timer time **▼** / **▲** buttons, set the line address.

4 Push **SET** button. (OK when display goes on.)

5 (Indoor unit address)
Using the temperature setup **▼** / **▲** buttons, set **1** to the CODE No.

6 Using timer time **▼** / **▲** buttons, set 1 to the line address.

7 Push **SET** button. (OK when display goes on.)

8 (Group address)
Using the temperature setup **▼** / **▲** buttons, set **1** to the CODE No.

9 Using timer time **▼** / **▲** buttons, set **0000** to Individual, **0001** to Master unit and **0002** to sub unit.

10 Push **SET** button. (OK when display goes on.)

11 Push **TEST** button.
Setup completes.
(The status returns to the usual stop status.)

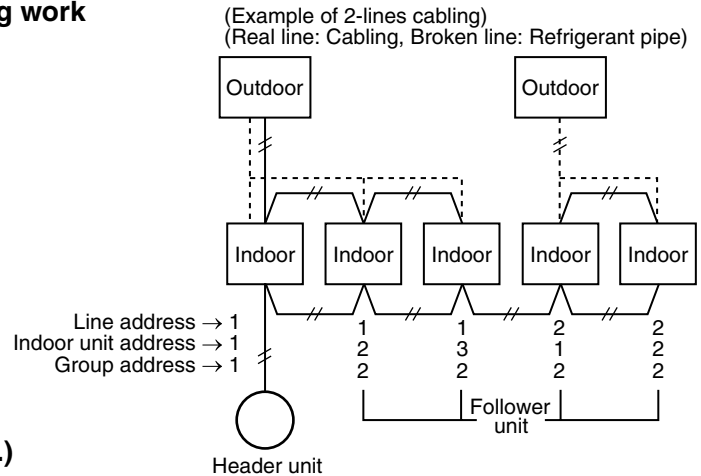

For the above example, perform setting by connecting singly the wired remote controller without remote controller inter-unit cable.

Group address
Individual : 0000
Header unit : 0001
Follower unit : 0002 } In case of group control

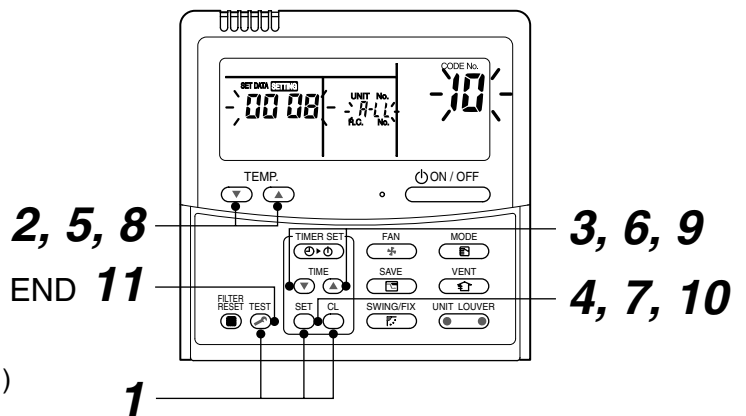

<Operation procedure>

1 → 2 → 3 → 4 → 5 → 6 →
7 → 8 → 9 → 10 → 11 END

Note 1)

When setting the line address from the remote controller, do not use Address 29 and 30.

As they are addresses which cannot be set to the outdoor unit, if they are set, the check code [E04] (Indoor/Outdoor communication circuit error) is issued.

Note 2)

When an address was manually set from the remote controller and the central control over the refrigerant lines is carried out, perform the following setting for the Master unit of each line.

- Set the line address for every line using SW13 and 14 on the interface P.C. board of the center unit in each line.
- Except the least line address No., turn off SW30-2 on the interface P.C. board of the Master units in the lines connected to the identical central control.
(Draw the terminal resistances of indoor/outdoor and central control line wirings together.)
- For each refrigerant line, connect the relay connector between Master unit [U1U2] and [U3U4] terminals.
- After then set the central control address.
(For setting of the central control address, refer to the Installation manual for the central control equipment.)

■ Confirmation of indoor unit No. position

1. To know the indoor unit addresses though position of the indoor unit is recognized

- In case of individual operation (Wired remote controller : indoor unit = 1 : 1)
(Follow to the procedure during operation)

<Procedure>

1 Push  button if the unit stops.

2 Push  (left side button) button.

Unit No. 1-1 is displayed on LCD.

(It disappears after several seconds.)

The displayed unit No. indicate line address and indoor unit address.

(When other indoor units are connected to the identical remote controller (Group control unit), other unit numbers are also displayed every pushing  (left side button) button.

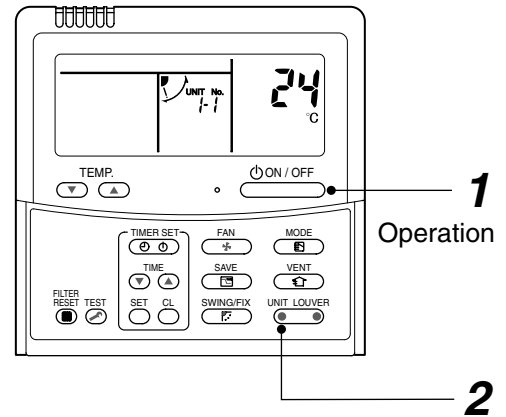

<Operation procedure>

1 → 2 END

2. To know the position of indoor unit by address

- To confirm the unit No. in the group control
(Follow to the procedure during operation) (in this procedure, the indoor units in group control stop.)

<Procedure>

The indoor unit numbers in the group control are successively displayed, and fan, louver, and drain pump of the corresponding indoor unit are turned on.
(Follow to the procedure during operation)

1 Push  and  buttons simultaneously for 4 seconds or more.

- Unit No. **ALL** is displayed.
- Fans and louvers of all the indoor units in the group control operate.

2 Every pushing  (left side button) button, the unit numbers in the group control are successively displayed.

- The unit No. displayed at the first time indicates the header unit address.
- Fan and louver of the selected indoor unit only operate.

3 Push  button to finish the procedure.
All the indoor units in the group control stop.

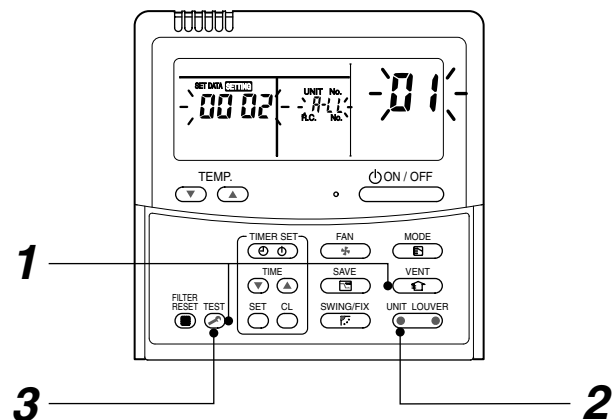

<Operation procedure>

1 → 2 → 3 END

■ How to check all the unit No. from an arbitrary wired remote controller

<Procedure> Carry out this procedure during stop of system.

The indoor unit No. and the position in the identical refrigerant piping can be checked.

An outdoor unit is selected, the identical refrigerant piping and the indoor unit No. are displayed one after the other, and then its fan and louver are on.

- 1 Push the timer time button + simultaneously for 4 seconds or more.
First line 1 and CODE No. **AC** (Address Change) are displayed. (Select outdoor unit.)



- 2 Select line address using / button.



- 3 Determine the selected line address using button.

- The address of the indoor unit connected to the refrigerant piping of the selected outdoor unit is displayed and the fan and the louver are on.



- 4 Every pushing , the indoor unit No. in the identical piping is displayed one after the other.

- Only fan and louver of the selected indoor unit start operation.

[To select the other line address]

- 5 Push button and the operation returns to Procedure 2.

- * The indoor address of other line can be continuously checked.



- 6 Push button and then the procedure finishes.

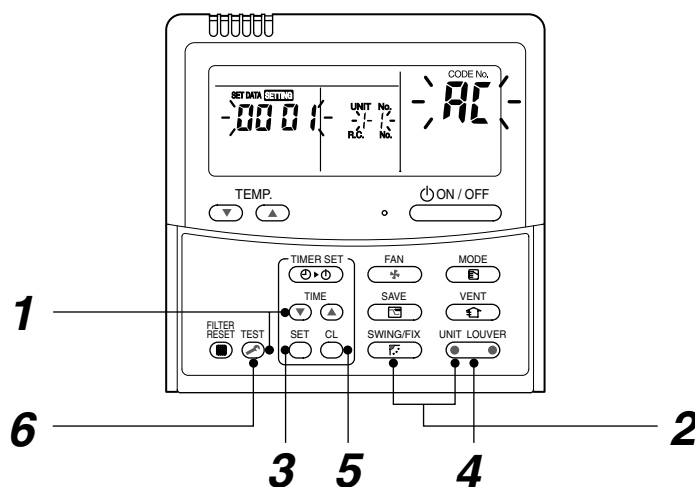

<Operation procedure>

1 → 2 → 3 → 4 → 5 → 6 END

◆ Changing the indoor unit address using a remote controller

To change an indoor unit address using a wired remote controller.

- ▼ The method to change the address of an individual indoor unit (the indoor unit is paired with a wired remote controller one-to-one), or an indoor unit in a group. (The method is available when the addresses have already been set automatically.)

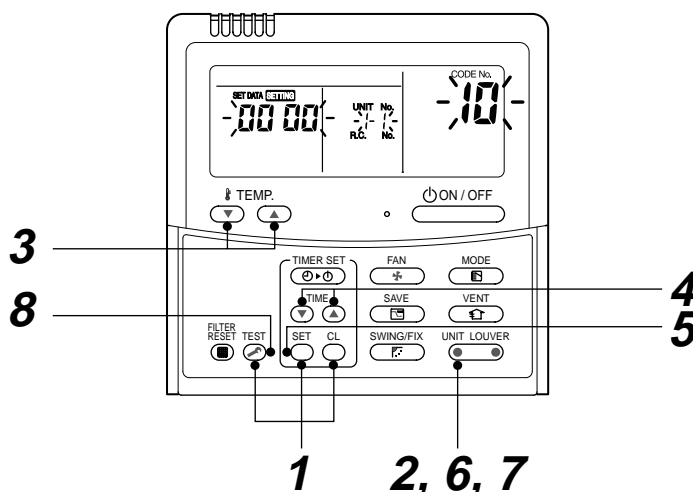

(Execute it while the units are stopped.)

- 1** Push and hold the , , and buttons at the same time for more than 4 seconds. (If 2 or more indoor units are controlled in a group, the first indicated UNIT No. is that of the head unit.)
- 2** Push the button (left side of the button) repeatedly to select an indoor unit number to change if 2 or more units are controlled in a group. (The fan and louvers of the selected indoor unit are activated.)
(The fan of the selected indoor unit is turned on.)
- 3** Push the TEMP. / buttons repeatedly to select **13** for CODE No.
- 4** Push the TIME / buttons repeatedly to change the value indicated in the SET DATA section to that you want.
- 5** Push the button.
- 6** Push the button (left side of the button) repeatedly to select another indoor UNIT No. to change.
Repeat steps **4** to **6** to change the indoor unit addresses so as to make each of them unique.
- 7** Push the button (left side of the button) to check the changed addresses.
- 8** If the addresses have been changed correctly, push the button to finish the procedure.

■ **How to change all indoor addresses from an arbitrary wired remote controller**

(It is possible when setting has finished by automatic addresses.)

Contents: The indoor unit addresses in each identical refrigerant piping line can be changed from an arbitrary wired remote controller.

⊙ **Enter in address check/change mode and then change the address.**

<Procedure> Carry out this procedure during stop of system.

1 Push the timer time button + simultaneously for 4 seconds or more.
First line 1 and CODE NO. *AC* (Address Change) are displayed.



2 Select line address using / button.



3 Push the button.

- The address of the indoor unit connected to the refrigerant piping of the selected outdoor unit is displayed and the fan and the louver are on.
First the current indoor address is displayed.
(Line address is not displayed.)



4 button push up/down the indoor address of the SET DATA.

The set data is changed to a new address.



5 Push button to determine the set data.



6 Every pushing (left side button) button, the indoor unit No. in the identical piping is displayed one after the other.

- Only fan and louver of the selected indoor unit start operation.
Repeat the Procedures **4** to **6** to change all the indoor addresses so that they are not duplicated.



7 Push button.
(All the indications of LCD go on.)



8 Push button and then the procedure finishes.

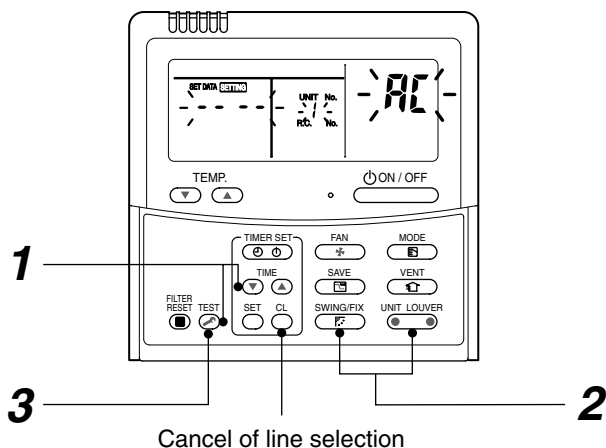

If the UNIT No. is not call up here, the outdoor unit in that line does not exist.
Push button to select a line again in the Procedure **2**.

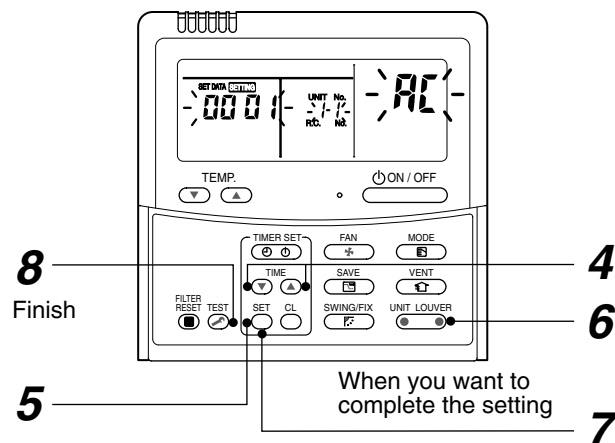

<Operation procedure>

1 → 2 → 3 → 4 → 5 → 6 → 7 → 8 END

■ Function to clear error

1. Clearing method from remote controller

⊙ How to clear error of outdoor unit

In the unit of refrigerant line connected by indoor unit of the remote controller to be operated, the error of the outdoor unit currently detected is cleared. (Error of the indoor unit is not cleared.)

The service monitor function of the remote controller is utilized.

<Method>

- 1** Push **CL** + **TEST** buttons simultaneously for 4 seconds or more to change the mode to service monitor mode.
- 2** Push **TEMP.** button to set the CODE No. to [FF].
- 3** The display of A part in the following figure is counted as “0005” → “0004” → “0003” → “0002” → “0001” → “0000” with 5-seconds interval.
When “0000” appear, the error was cleared.
* However counting from “0005” is repeated on the display screen.
- 4** When pushing **TEST** button, the status becomes normal.

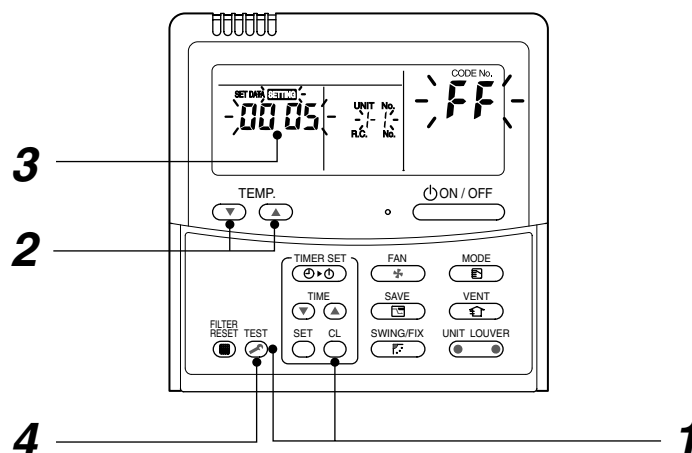

<Operation procedure>

1 → 2 → 3 → 4

Returns to normal status

⊙ How to clear error of indoor unit

The error of indoor unit is cleared by **ON/OFF** button of the remote controller.

(Only error of the indoor unit connected with remote controller to be operated is cleared.)

■ **Monitoring function of remote controller switch**

When using the remote controller (Model Name: RBC-AMT32E), the following monitoring function can be utilized.

Calling of display

<Contents>

The temperature of each sensor of the remote controller, indoor unit and outdoor unit and the operating status can be checked by calling the service monitor mode from the remote controller.

<Procedure>

- 1** Push **TEST** + **CL** buttons simultaneously for 4 seconds or more to call up the service monitor mode. The service monitor goes on and firstly the temperature of the CODE No. **00** is displayed.



- 2** Push **TEMP.** button to change CODE No. to the CODE No. to be monitored. For display code, refer to the following table.



- 3** Push **UNIT LOUVER** (left side button) button to change to item to be monitored. The sensor temperature of indoor unit or outdoor unit in its refrigerant line and the operating status are monitored.



- 4** Push **TEST** button to return the status to the normal display.

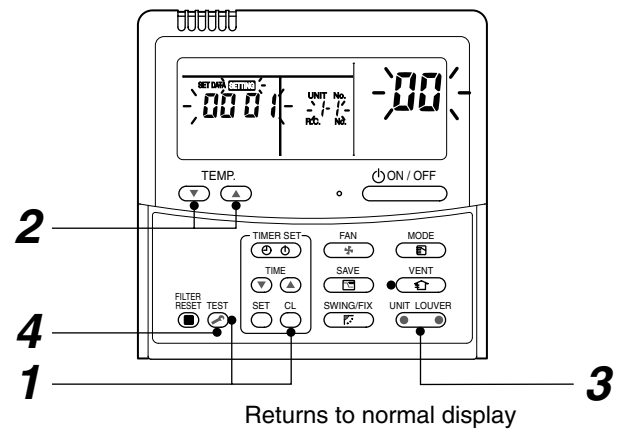

<Operation procedure>
1 → 2 → 3 → 4

◆ Target outdoor unit (SMMS, SHRM, Mini-SMMS – Series 1 – 2)

	CODE No.	Data	Format	Unit	Remote controller display example
Indoor unit data	00	Room temperature (in control) *1	x1	°C	[0024]=24 °C
	01	Room temperature (Remote controller)	x1	°C	
	02	Air Temperature (TA)	x1	°C	
	03	Coil Temperature (TCJ)	x1	°C	
	04	Coil Temperature (TC2)	x1	°C	
	05	Coil Temperature (TC1)	x1	°C	
	08	PMV	x1	pls	[0050]=500 pls
System unit data	0A	Number of connected indoor units	x1	—	[0048]=48
	0B	Total horse power of connected indoor units	x1	HP	[0415]=41.5 HP
	0C	Number of connected outdoor units	x1	—	[0004]=4
	0D	Total horse power of outdoor units	x1	HP	[0420]=42 HP

	CODE No.				Data	Format	Unit	Remote controller display example
	U1	U2	U3	U4				
Individual data 1 of outdoor unit *3	10	20	30	40	Discharge temperature of compressor 1 (Td1)	x1	°C	[0024]=24 °C
	11	21	31	41	Discharge temperature of compressor 2 (Td2)	x1	°C	
	12	22	32	42	Detection pressure of high-pressure sensor (Pd)	x1	MPa	[0123]=1.23 MPa
	13	23	33	43	Detection pressure of low-pressure sensor (Ps)	x1	MPa	
	14	24	34	44	Suction Temperature (TS)	x1	°C	[0024]=24 °C
	15	25	35	45	Coil Temperature 1 (TE)	x1	°C	
	16	26	36	46	Liquid Temperature (TL)	x1	°C	
	17	27	37	47	Outdoor Temperature (TO)	x1	°C	
	18	28	38	48	Low-pressure saturation temperature (TU)	x1	°C	
	19	29	39	49	Current of compressor 1 (I1)	x1	A	[0135]=13.5 A
	1A	2A	3A	4A	Current of compressor 2 (I2)	x1	A	
	1B	2B	3B	4B	PMV1 + 2	x1	pls	[0050]=500 pls
	1C	2C	3C	4C	PMV3	x1	pls	[0050]=500 pls
	1D	2D	3D	4D	Compressor 1, 2 ON/OFF	*2	—	
	1E	2E	3E	4E	Outdoor fan mode	x1	—	[0031]=Mode 31
	1F	2F	3F	4F	Horse power of outdoor unit	x1	HP	[0016]=16HP

*1 In the case of group connection, only the header indoor unit data can be displayed.

*2 01 ... Only compressor 1 is on
 10 ... Only compressor 2 is on
 11 ... Both compressor 1 and 2 are on

*3 The upper digit of CODE No. indicates the outdoor unit No.
 U1 outdoor unit (Header unit)
 U2 outdoor unit (follower unit 1)
 U3 outdoor unit (follower unit 2)
 U4 outdoor unit (follower unit 3)

◆ Target outdoor unit (SMMS-i – Series 4)

	CODE No.	Data	Format	Unit	Remote controller display example
Indoor unit data *2	00	Room temperature (in control)	x1	°C	[0024]=24 °C
	01	Room temperature (Remote controller)	x1	°C	
	02	Air Temperature (TA)	x1	°C	
	03	Coil Temperature (TCJ)	x1	°C	
	04	Coil Temperature (TC2)	x1	°C	
	05	Coil Temperature (TC1)	x1	°C	
	06	Discharge temperature (TF) *1	x1	°C	
	08	PMV	x1/10	pls	[0150]=1500 pls
	09	Air Suction Temperature of direct expansion coil (TSA) *1	x1	°C	[0024]=24 °C
	FA	Outdoor Air Temperature (TOA) *1	x1	°C	
System unit data	0A	Number of connected indoor units	x1	—	[0048]=48
	0B	Total horse power of connected indoor units	x10	HP	[0415]=41.5HP
	0C	Number of connected outdoor units	x1	—	[0004]=4
	0D	Total horse power of outdoor units	x10	HP	[0420]=42HP

	CODE No.				Data	Format	Unit	Remote controller display example
	U1	U2	U3	U4				
Individual data 1 of outdoor unit *3	10	20	30	40	Detection pressure of high-pressure sensor (Pd)	x100	MPa	[0123]=1.23 MPa
	11	21	31	41	Detection pressure of low-pressure sensor (Ps)	x100	MPa	
	12	22	32	42	Discharge temperature of compressor 1 (Td1)	x1	°C	[0024]=24 °C
	13	23	33	43	Discharge temperature of compressor 2 (Td2)	x1	°C	
	14	24	34	—	Discharge temperature of compressor 3 (Td3)	x1	°C	
	15	25	35	45	Suction Temperature (TS)	x1	°C	
	16	26	36	46	Coil Temperature 1 (TE1)	x1	°C	
	17	27	37	—	Coil Temperature 2 (TE2)	x1	°C	
	18	28	38	48	Liquid Temperature (TL)	x1	°C	
	19	29	39	49	Outdoor Temperature (TO)	x1	°C	
	1A	2A	3A	4A	PMV1 + 2	x1	pls	[0050]=500 pls
	1B	2B	3B	—	PMV4	x1	pls	
	1C	2C	3C	4C	Current of compressor 1 (I1)	x10	A	[0135]=13.5 A
	1D	2D	3D	4D	Current of compressor 2 (I2)	x10	A	
	1E	2E	3E	—	Current of compressor 3 (I3)	x10	A	
	1F	2F	3F	4F	Outdoor fan current (IFan)	x10	A	

*1 The TF/TSA/TOA sensors are equipped only with some types of indoor units. The data does not appear for other types.

*2 In the case of group connection, only the header indoor unit data can be displayed.

*3 The upper digit of CODE No. indicates the outdoor unit No.

*4 [(The upper digit of CODE No.) – 4] indicates the outdoor unit No.

1*, 5* ... U1 outdoor unit (Header unit)

2*, 6* ... U2 outdoor unit (follower unit 1)

3*, 7* ... U3 outdoor unit (follower unit 2)

4*, 8* ... U4 outdoor unit (follower unit 3)

*5 Only CODE No. 5• of U1 outdoor unit (Header unit) is displayed.

	CODE No.				Data	Format	Unit	Remote controller display example
	U1	U2	U3	U4				
Individual data 2 of outdoor unit *4	50	60	70	80	Rotation of compressor 1	x10	rps	[0642]=64.2 rps
	51	61	71	81	Rotation of compressor 2	x10	rps	
	52	62	72	—	Rotation of compressor 3	x10	rps	
	53	63	73	83	Outdoor fan mode	x1	Mode	[0058]=Mode 58
	54	64	74	84	Heat sink temperature of compressor IPDU1	x1	°C	[0024]=24 °C
	55	65	75	85	Heat sink temperature of compressor IPDU2	x1	°C	
	56	66	76	—	Heat sink temperature of compressor IPDU3	x1	°C	
	57	67	77	87	Heat sink temperature of outdoor fan IPDU	x1	°C	
	58	—	—	—	In heat/cool collecting control *5	0: Normal 1: In collecting control		[0010] = In heat collecting control [0001] = In cool collecting control
	59	—	—	—	Pressure release *5			[0010] = In pressure release control
	5A	—	—	—	Discharge temperature release *5			[0001] = In discharge temperature release control
	5B	—	—	—	Terminal unit release (U2 / U3 / U4 outdoor unit) *5	0: Normal 1: In release control		[0100] = In U2 outdoor unit release control [0010] = In U3 outdoor unit release control [0001] = In U4 outdoor unit release control
	5F	6F	7F	8F	Horse power of outdoor unit	x1	HP	[0016]=16HP

*1 The TF / TSA / TOA sensors are equipped only with some types of indoor units. The data does not appear for other types.

*2 In the case of group connection, only the header indoor unit data can be displayed.

*3 The upper digit of CODE No. indicates the outdoor unit No.

*4 [(The upper digit of CODE No.) – 4] indicates the outdoor unit No.

1*, 5* ... U1 outdoor unit (Center unit)

2*, 6* ... U2 outdoor unit (terminal unit 1)

3*, 7* ... U3 outdoor unit (terminal unit 2)

4*, 8* ... U4 outdoor unit (terminal unit 3)

5 Only CODE No. 5 of U1 outdoor unit (Center unit) is displayed.

■ LED display on P.C. board

1. D501 (Red)

- D501 goes on at the same time when the power supply is turned on.
(Goes on with operation of the main microprocessor)
- D501 flashes with 1-second interval (every 0.5 second) : When there is no EEPROM or write-in error
- D501 flashes with 10-seconds interval (every 5 second) : In DISP mode
- D501 flashes with 2-seconds interval (every 1 second) : During setting of function exchange
(EEPROM)

2. D403 (Red)

- D403 goes on when power is supplied to the remote controller. (ON in hardware)

3. D503 (Yellow): Indoor/Outdoor central control

- D503 goes on for 5 seconds at the first half during communication with the central controller.
- D503 flashes for 5 seconds with 0.2-second interval at the latter half during communication with outdoor unit. (Goes on for 0.1 second, goes off for 0.1 second)

4. D504 (Green): Remote controller communication

- D504 goes on for 5 seconds at the first half during communication with remote controller.
(Header unit of group)
- In the group indoor unit, D504 flashes for 5 seconds with 0.2-second interval at the latter half during communication between header and follower unit. (Goes on for 0.1 second, goes off for 0.1 second)

8. TROUBLESHOOTING

8-1. Troubleshooting Summary

1. Before troubleshooting

1) Applied models

① SMMS (i) Multi type models

Indoor unit : MMX-APXXX,

Outdoor unit : MMY-MAPXXXXT8X, MMY-MAPXXXHT7X

② Super Heat Recovery Multi type models

Indoor unit : MMX-APXXX,

Outdoor unit : MMY-MAPXXXFT8X

③ Mini-SMMS Multi type models

Indoor unit : MMX-APXXX,

Outdoor unit : MCY-MAPXXXHT, MCY-MAPXXXHT2X

2) Required tools / measuring devices

- Screwdrivers (Philips, Minus), spanner, radio pinchers, nipper, push pin for reset switch, etc.
- Tester, thermometer, pressure gauge, etc.

3) Confirmation before check (The following items are not troubles.)

No.	Operation	Check items
1	Compressor does not operate.	<ul style="list-style-type: none"> • Is not delayed for 3 minutes? (3 minutes after compressor-OFF) • Is not thermostat OFF? • Is not the fan operating or timer? • Is not the system initially communicating? Heating operation cannot be performed under condition of outside temperature 21°C or higher. Cooling operation cannot be performed under condition of outside temperature -5°C or lower.
2	Indoor fan does not work.	<ul style="list-style-type: none"> • Is not the cold draft prevention being controlled in heating operation?
3	Outdoor fan does not rotate, or fan speed changes.	<ul style="list-style-type: none"> • Is not low cooling operation being controlled? • Is not a defrost operation being performed?
4	Indoor fan does not stop.	<ul style="list-style-type: none"> • Is not after-heat elimination operation being controlled after heating operation?
5	Start/stop operation on remote controller is unavailable.	<ul style="list-style-type: none"> • Is not auxiliary unit or remote control being operated?
6	—	<ul style="list-style-type: none"> • Is connecting wire of indoor unit or remote controller correct?

2. Troubleshooting procedure

When a trouble occurred, advance the check operation in the following procedure.

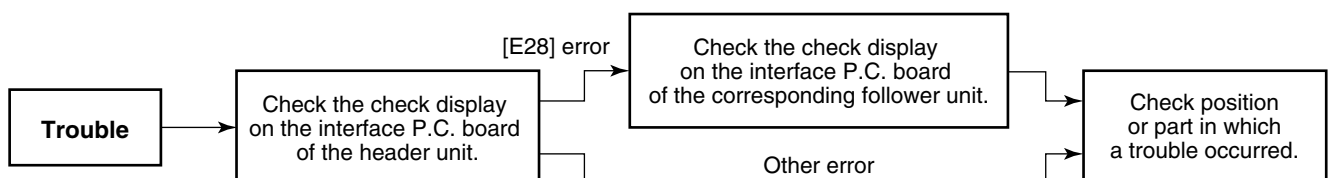

NOTE

While a check operation is performed, a malfunction of the microprocessor may be caused due to condition of the power supply or the external noise.

If there is any noise source, change wires of the remote controller and signal wires to shield wires.

8-2. How to check

On the remote controller (Wired remote controller, Central control remote controller) and on the interface P.C. board of the outdoor unit, LCD display part (Remote controller) or 7-segment display part (on outdoor interface P.C. board) is provided in order to display the operation status.
When a trouble occurred, the method to judge the trouble or defective position of the air conditioner by this self-diagnosis function is shown below.

- The following table shows the list of each check code that each device detects. Check the check contents in the following table according to position to be checked.
- Check from the indoor remote controller or TCC-LINK central controller: Refer to "Display on remote controller & TCC-LINK central controller" in the following table.
 - Check from outdoor unit: Refer to "Display of outdoor segment" in the following table.
 - Check from indoor unit of wireless remote controller: Refer to Receiver lamp display" in the following table.

Check code display list (Indoor unit)

[Indoor unit detects error.]

TCC-LINK central & remote controller	Check code display		Receiver lamp display		Main defective position	Description
	Outdoor 7-segment	Auxiliary code	Block display (*)			
			Operation	Timer Ready		
E03	—	—	⊙	●	●	No communication from remote controller and network adapter (No central control system communication also)
E04	—	—	●	●	⊙	No communication from outdoor unit
E08	E08	Duplicated indoor unit No.	⊙	●	●	An address same to self address was detected.
E10	—	—	⊙	●	●	Communication error between indoor MCU
E18	—	—	⊙	●	●	Regular communication error between header and follower in indoor unit
F01	—	—	⊙	⊙	●	Indoor heat exchanger temp. sensor (TCJ) error
F02	—	—	⊙	⊙	●	Indoor heat exchanger temp. sensor (TC2) error
F03	—	—	⊙	⊙	●	Indoor heat exchanger temp. sensor (TC1) error
F10	—	—	⊙	⊙	●	Room tem. Sensor (TA) error
F29	—	—	⊙	⊙	●	Indoor or other P.C. board error
L03	—	—	⊙	●	⊙	Duplicated setting of header in indoor group
L07	—	—	⊙	●	⊙	There is group cable in individual indoor unit.
L08	L08	—	⊙	●	⊙	Indoor group address is unset.
L09	—	—	⊙	●	⊙	Indoor capacity is unset.
L20	—	—	⊙	○	⊙	Duplicated central control system address
L30	L30	Detected indoor unit No.	⊙	○	⊙	External error was input in indoor (Interlock).
P01	—	—	●	⊙	⊙	Indoor AC fan error
P10	P10	Detected indoor unit No.	●	⊙	⊙	Indoor overflow was detected.
P12	—	—	●	⊙	⊙	Indoor DC fan error
P31	—	—	⊙	●	⊙	Other indoor unit error

Note) The check code display may be different according to the detected device even same error contents such as communication error.

[Remote controller detects error.]

(*) O : Goes on, @: Flashes, ● : Goes off
 A (Alternate) : Flashing condition is alternate when there are two flashing LED.
 S (Simultaneously) : Two LED flash simultaneously when there are two flashing LED.

Remote controller	Check code display		Receiver lamp display		Main defective position	Description
	Outdoor 7-segment	Auxiliary code	Block display (*)	Operation Timer Ready Flash		
E01	—	—	◎ ● ●	—	No remote controller header unit, remote controller communication (receive) error	When signal cannot be received from indoor unit, when header of remote controller was not set (including 2 remote controllers)
E02	—	—	◎ ● ●	—	Remote controller communication (send) error	When signal cannot be sent to indoor unit
E09	—	—	◎ ● ●	—	Duplicated remote controller header	In 2-remote controller control, both remote controllers were set to header. (Indoor header stops with alarm and follower unit continues operation.)

[Central controller detects error.]

TCC-LINK central	Check code display		Receiver lamp display		Main defective position	Description
	Outdoor 7-segment	Auxiliary code	Block display (*)	Operation Timer Ready Flash		
C05	—	—	Is not displayed (In shared use of remote controller)	—	Central control system communication (send) error	When signal of central control system cannot be sent, there are same multiple central devices (AI-NET)
C06	—	—			Central control system communication (receive) error	When signal of central control system cannot be received
—	—	—	—	—	There are multiple network adapters.	There were multiple network adapters (AI-NET) on remote controller communication line.
C12	—	—	—	—	Batched alarm of interface for general-purpose equipment control	Error of equipment connected to control interface of the general-purpose unit exclusive to TCC-LINK/AI-NET
P30	—	—	—	According to unit with alarm (Above mentioned)	Group follower unit error	Group follower unit error (For remote controller, [*:*:#] details is displayed together with unit No.)

Note) The check code display may be different according to the detected device even same error contents such as communication error.

List of check codes (outdoor unit)

(Errors detected by SMMS outdoor interface - typical examples)

IPDU: Intelligent Power Drive Unit (Inverter P.C. board)
 ○ :Lighting, ◎ : Flashing, ● : Goes off
 ALT.: Flashing is alternately when there are two flashing LED
 SIM: Simultaneous flashing when there are two flashing LED

Check code		Display of receiving unit				Typical fault site	Description of error																																																																																																																		
Outdoor 7-segment display		TCC-LINK central control or main remote controller display	Indicator light block																																																																																																																						
Sub-code			Operation ⏻	Timer ⌚	Ready ⦿	Flash																																																																																																																			
E06	Number of indoor units from which signal is received normally	E06	●	●	◎		Dropping out of indoor unit	Indoor unit initially communicating normally fails to return signal (reduction in number of indoor units connected).																																																																																																																	
E07	–	(E04)	●	●	◎		Indoor-outdoor communication circuit error	Signal cannot be transmitted to indoor units (→ indoor units left without communication from outdoor unit).																																																																																																																	
E08	Duplicated indoor address	(E08)	◎	●	●		Duplicated indoor address	More than one indoor unit is assigned same address (also detected at indoor unit end).																																																																																																																	
E12	01: Indoor-outdoor communication 02: Outdoor-outdoor communication	E12	◎	●	●		Automatic address starting error	<ul style="list-style-type: none"> Indoor automatic address setting is started while automatic address setting for equipment in other refrigerant line is in progress. Outdoor automatic address setting is started while automatic address setting for indoor units is in progress. 																																																																																																																	
E15	–	E15	●	●	◎		Indoor unit not found during automatic address setting	Indoor unit fails to communicate while automatic address setting for indoor units is in progress.																																																																																																																	
E16	00: Overloading 01: Number of units connected	E16	●	●	◎		Too many indoor units connected / overloading	Combined capacity of indoor units is too large (more than 135 % of combined capacity of outdoor units).																																																																																																																	
E19	00: No header unit 02: Two or more header units	E19	●	●	◎		Error in number of outdoor header units	There is no or more than one outdoor header unit in one refrigerant line.																																																																																																																	
E20	01: Connection of outdoor unit from other refrigerant line 02: Connection of indoor unit from other refrigerant line	E20	●	●	◎		Connection to other refrigerant line found during automatic address setting	Indoor unit from other refrigerant line is detected while indoor automatic address setting is in progress.																																																																																																																	
E23	–	E23	●	●	◎		Outdoor-outdoor communication transmission error	Signal cannot be transmitted to other outdoor units.																																																																																																																	
E25	–	E25	●	●	◎		Duplicated follower outdoor address	There is duplication in outdoor addresses set manually.																																																																																																																	
E26	Address of outdoor unit from which signal is not received normally	E26	●	●	◎		Dropping out of outdoor unit	Follower outdoor unit initially communicating normally fails to do so (reduction in number of follower outdoor units connected).																																																																																																																	
E28	Detected outdoor unit No.	E28	●	●	◎		Outdoor follower unit error	Outdoor header unit detects fault relating to follower outdoor unit (detail displayed on follower outdoor unit).																																																																																																																	
E31	<table border="1" style="font-size: small;"> <thead> <tr> <th rowspan="2"></th> <th colspan="3">A3-IPDU</th> <th rowspan="2">Fan</th> <th rowspan="2">IPDU</th> <th colspan="3">A3-IPDU</th> <th rowspan="2">Fan</th> <th rowspan="2">IPDU</th> </tr> <tr> <th>1</th> <th>2</th> <th>3</th> <th>1</th> <th>2</th> <th>3</th> </tr> </thead> <tbody> <tr> <td>01</td> <td>○</td> <td></td> <td></td> <td></td> <td>0A</td> <td>○</td> <td></td> <td>○</td> <td></td> <td></td> </tr> <tr> <td>02</td> <td>○</td> <td></td> <td></td> <td></td> <td>0B</td> <td>○</td> <td></td> <td>○</td> <td></td> <td></td> </tr> <tr> <td>03</td> <td>○</td> <td>○</td> <td></td> <td></td> <td>0C</td> <td></td> <td></td> <td>○</td> <td>○</td> <td></td> </tr> <tr> <td>04</td> <td></td> <td></td> <td>○</td> <td></td> <td>0D</td> <td>○</td> <td></td> <td>○</td> <td>○</td> <td></td> </tr> <tr> <td>05</td> <td>○</td> <td>○</td> <td></td> <td></td> <td>0E</td> <td></td> <td></td> <td>○</td> <td>○</td> <td>○</td> </tr> <tr> <td>06</td> <td>○</td> <td>○</td> <td></td> <td></td> <td>0F</td> <td>○</td> <td>○</td> <td>○</td> <td>○</td> <td>○</td> </tr> <tr> <td>07</td> <td>○</td> <td>○</td> <td>○</td> <td></td> <td colspan="5">Circle (○): Faulty IPDU</td> </tr> <tr> <td>08</td> <td></td> <td></td> <td></td> <td>○</td> <td colspan="5"></td> </tr> <tr> <td>09</td> <td>○</td> <td></td> <td></td> <td>○</td> <td colspan="5"></td> </tr> </tbody> </table>		A3-IPDU			Fan	IPDU	A3-IPDU			Fan	IPDU	1	2	3	1	2	3	01	○				0A	○		○			02	○				0B	○		○			03	○	○			0C			○	○		04			○		0D	○		○	○		05	○	○			0E			○	○	○	06	○	○			0F	○	○	○	○	○	07	○	○	○		Circle (○): Faulty IPDU					08				○						09	○			○						E31	●	●	◎		IPDU communication error	There is no communication between IPDUs (P.C. boards) in inverter box.
	A3-IPDU			Fan	IPDU			A3-IPDU					Fan	IPDU																																																																																																											
	1	2	3			1	2	3																																																																																																																	
01	○				0A	○		○																																																																																																																	
02	○				0B	○		○																																																																																																																	
03	○	○			0C			○	○																																																																																																																
04			○		0D	○		○	○																																																																																																																
05	○	○			0E			○	○	○																																																																																																															
06	○	○			0F	○	○	○	○	○																																																																																																															
07	○	○	○		Circle (○): Faulty IPDU																																																																																																																				
08				○																																																																																																																					
09	○			○																																																																																																																					
F04	–	F04	◎	◎	○	ALT	Outdoor discharge temperature sensor (TD1) error	Outdoor discharge temperature sensor (TD1) has been open / short-circuited.																																																																																																																	
F05	–	F05	◎	◎	○	ALT	Outdoor discharge temperature sensor (TD2) error	Outdoor discharge temperature sensor (TD2) has been open / short-circuited.																																																																																																																	
F06	01: TE1 02: TE2	F06	◎	◎	○	ALT	Outdoor heat exchanger temperature sensor (TE1, TE2) error	Outdoor heat exchanger temperature sensors (TE1, TE2) have been open / short-circuited.																																																																																																																	
F07	–	F07	◎	◎	○	ALT	Outdoor liquid temperature sensor (TL) error	Outdoor liquid temperature sensor (TL) has been open / short-circuited.																																																																																																																	
F08	–	F08	◎	◎	○	ALT	Outdoor outside air temperature sensor (TO) error	Outdoor outside air temperature sensor (TO) has been open / short-circuited.																																																																																																																	
F11	–	F11																																																																																																																							

Check code		Display of receiving unit				Typical fault site	Description of error	
Outdoor 7-segment display		TCC-LINK central control or main remote controller display	Indicator light block					
Sub-code			Operation Ⓞ	Timer Ⓞ	Ready Ⓞ	Flash		
F12	–	F12	Ⓞ	Ⓞ	○	ALT	Outdoor suction temperature sensor (TS1) error	Outdoor suction temperature sensor (TS1) has been open / short-circuited.
F13	01: Compressor 1 02: Compressor 2 03: Compressor 3	F13	Ⓞ	Ⓞ	○	ALT	Outdoor IGBT built-in temperature sensor (TH) error	Open-circuit or short-circuit of the outdoor IGBT built-in temperature sensor (TH) was detected.
F15	–	F15	Ⓞ	Ⓞ	○	ALT	Outdoor temperature sensor (TE1, TL) wiring error	Wiring error in outdoor temperature sensors (TE1, TL) has been detected.
F16	–	F16	Ⓞ	Ⓞ	○	ALT	Outdoor pressure sensor (Pd, Ps) wiring error	Wiring error in outdoor pressure sensors (Pd, Ps) has been detected.
F22	–	F22	Ⓞ	Ⓞ	○	ALT	Outdoor discharge temperature sensor (TD3) error	Outdoor discharge temperature sensor (TD3) has been open / short-circuited.
F23	–	F23	Ⓞ	Ⓞ	○	ALT	Low pressure sensor (Ps) error	Output voltage of low pressure sensor (Ps) is zero.
F24	–	F24	Ⓞ	Ⓞ	○	ALT	High pressure sensor (Pd) error	Output voltage of high pressure sensor (Pd) is zero or provides abnormal readings when compressors have been turned off.
F31	–	F31	Ⓞ	Ⓞ	○	SIM	Outdoor EEPROM error	Outdoor EEPROM is faulty (alarm and shutdown for header unit and continued operation for follower unit)
H01	01: Compressor 1 02: Compressor 2 03: Compressor 3	H01	●	Ⓞ	●		Compressor breakdown	Overcurrent of the inverter current (Idc) detection circuit was detected.
H02	01: Compressor 1 02: Compressor 2 03: Compressor 3	H02	●	Ⓞ	●		Compressor error (Lock)	Compressor lock was detected.
H03	01: Compressor 1 02: Compressor 2 03: Compressor 3	H03	●	Ⓞ	●		Current detection circuit error	Current error was detected while the compressor was stopped.
H04		H05	●	Ⓞ	●		Compressor 1 case thermo activation	Compressor 1 case thermo was activated for protection.
H05	–	H05	●	Ⓞ	●		Outdoor discharge temperature sensor (TD1) wiring error	Wiring / installation error or detachment of outdoor discharge temperature sensor (TD1) has been detected.
H06	–	H06	●	Ⓞ	●		Activation of low-pressure protection	Low pressure (Ps) sensor detects abnormally low operating pressure.
H07	–	H07	●	Ⓞ	●		Activation of low-pressure protection	Temperature sensor for oil level detection (TK1-5) detects abnormally low oil level.
H08	01: TK1 sensor error 02: TK2 sensor error 03: TK3 sensor error 04: TK4 sensor error 05: TK5 sensor error	H08	●	Ⓞ	●		Error in temperature sensor for oil level detection (TK1-5)	Temperature sensor for oil level detection (TK1-5) has been open / short-circuited.
H14	–	H14	●	Ⓞ	●		Compressor 2 case thermo activation	Compressor 2 case thermo was activated for protection.
H15	–	H15	●	Ⓞ	●		Outdoor discharge temperature sensor (TD2) wiring error	Wiring / installation error or detachment of outdoor discharge temperature sensor (TD2) has been detected.
H16	01: TK1 oil circuit error 02: TK2 oil circuit error 03: TK3 oil circuit error 04: TK4 oil circuit error 05: TK5 oil circuit error	H16	●	Ⓞ	●		Oil level detection circuit error	No temperature change is detected by temperature sensor for oil level detection (TK1-5) despite compressor having been started.
H25	–	H25	●	Ⓞ	●		Outdoor discharge temperature sensor (TD3) wiring error	Wiring / installation error or detachment of outdoor discharge temperature sensor (TD3) has been detected.
L04	–	L04	Ⓞ	○	Ⓞ	SIM	Duplicated outdoor refrigerant line address	Identical refrigerant line address has been assigned to outdoor units belonging to different refrigerant piping systems.
L06	Number of priority indoor units (check code L05 or L06 depending on individual unit)	L05	Ⓞ	●	Ⓞ	SIM	Duplicated priority indoor unit (as displayed on priority indoor unit)	More than one indoor unit has been set up as priority indoor unit.
		L06	Ⓞ	●	Ⓞ	SIM	Duplicated priority indoor unit (as displayed on indoor unit other than priority indoor unit)	More than one indoor unit has been set up as priority indoor unit.

Check code		Display of receiving unit				Typical fault site	Description of error																																																																																												
Outdoor 7-segment display		TCC-LINK central control or main remote controller display	Indicator light block																																																																																																
Sub-code				Operation	Timer	Ready	Flash																																																																																												
L08	-	(L08)				SIM	SIM Indoor group address not set Address setting has not been performed for one or more indoor units (also detected at indoor end).																																																																																												
L10	-	L10				SIM	Outdoor capacity not set Outdoor unit capacity has not been set (after P.C. board replacement).																																																																																												
L17	-	L17				SIM	Outdoor model incompatibility error Old model outdoor unit (prior to 3 series) has been connected.																																																																																												
L18	-	L18				SIM	FS (Flow Selector) unit error Cooling / heating cycle error resulting from piping error is detected.																																																																																												
L28	-	L28				SIM	Too many outdoor units connected More than four outdoor units have been connected.																																																																																												
L29	SMMS (Series 1) 01: A3-IPDU1 error 02: A3-IPDU2 error 03: A3-IPDU1/A3-IPDU2 error 04: Fan IPDU error 05: A3-IPDU1 + Fan IPDU error 06: A3-IPDU2 + Fan IPDU error 07: All IPDU error SMMS-i (Series 4)	L29				SIM	Error in number of IPDUs There are insufficient number of IPDUs (P.C. boards) in inverter box.																																																																																												
<table border="1"> <thead> <tr> <th rowspan="2"></th> <th colspan="3">A3-IPDU</th> <th rowspan="2">Fan IPDU</th> <th colspan="3">A3-IPDU</th> <th rowspan="2">Fan IPDU</th> </tr> <tr> <th>1</th> <th>2</th> <th>3</th> <th>1</th> <th>2</th> <th>3</th> </tr> </thead> <tbody> <tr> <td>01</td> <td></td> <td></td> <td></td> <td></td> <td>0A</td> <td></td> <td></td> <td></td> </tr> <tr> <td>02</td> <td></td> <td></td> <td></td> <td></td> <td>0B</td> <td></td> <td></td> <td></td> </tr> <tr> <td>03</td> <td></td> <td></td> <td></td> <td></td> <td>0C</td> <td></td> <td></td> <td></td> </tr> <tr> <td>04</td> <td></td> <td></td> <td></td> <td></td> <td>0D</td> <td></td> <td></td> <td></td> </tr> <tr> <td>05</td> <td></td> <td></td> <td></td> <td></td> <td>0E</td> <td></td> <td></td> <td></td> </tr> <tr> <td>06</td> <td></td> <td></td> <td></td> <td></td> <td>0F</td> <td></td> <td></td> <td></td> </tr> <tr> <td>07</td> <td></td> <td></td> <td></td> <td></td> <td colspan="3">Circle (O): Faulty IPDU</td> </tr> <tr> <td>08</td> <td></td> <td></td> <td></td> <td></td> <td colspan="3"></td> </tr> <tr> <td>09</td> <td></td> <td></td> <td></td> <td></td> <td colspan="3"></td> </tr> </tbody> </table>			A3-IPDU			Fan IPDU	A3-IPDU			Fan IPDU	1	2	3	1	2	3	01					0A				02					0B				03					0C				04					0D				05					0E				06					0F				07					Circle (O): Faulty IPDU			08								09												
	A3-IPDU			Fan IPDU	A3-IPDU			Fan IPDU																																																																																											
	1	2	3		1	2	3																																																																																												
01					0A																																																																																														
02					0B																																																																																														
03					0C																																																																																														
04					0D																																																																																														
05					0E																																																																																														
06					0F																																																																																														
07					Circle (O): Faulty IPDU																																																																																														
08																																																																																																			
09																																																																																																			
L30	Detected indoor unit No.	(L30)				SIM	Indoor external error input (interlock) Indoor unit has been shut down for external error input in one refrigerant line (detected by indoor unit).																																																																																												
P03	-					ALT	Outdoor discharge (TD1) temperature error Outdoor discharge temperature sensor (TD1) has detected abnormally high temperature.																																																																																												
P04	P0301: Compressor 1 02: Compressor 2 03: Compressor 3	P04				ALT	High-pressure SW activation High-pressure SW was activated.																																																																																												
P05	00: Open phase detected 01: Compressor 1 02: Compressor 2 03: Compressor 3	P05				ALT	Open phase / power failure Inverter DC voltage (Vdc) error MG-CTT error Open phase is detected when power is turned on. Inverter DC voltage is too high (overvoltage) or too low (undervoltage).																																																																																												
P07	01: Compressor 1 02: Compressor 2 03: Compressor 3	P07				ALT	Heat sink overheating error Temperature sensor built into IGBT (TH) detects overheating.																																																																																												
P10	Indoor unit No. detected	(P10)				ALT	Indoor unit overflow Indoor unit has been shutdown in one refrigerant line due to detection of overflow (detected by indoor unit).																																																																																												
P13	-	P13				ALT	Outdoor liquid backflow detection error State of refrigerant cycle circuit indicates liquid backflow operation.																																																																																												
P15	01: TS condition 02: TD condition	P15				ALT	Gas leak detection Outdoor suction temperature sensor (TS1) detects sustained and repeated high temperatures that exceed standard value.																																																																																												
P17	-	P17				ALT	Outdoor discharge (TD2) temperature error Outdoor discharge temperature sensor (TD2) detects abnormally high temperature.																																																																																												
P18	-	P18				ALT	Outdoor discharge (TD3) temperature error Outdoor discharge temperature sensor (TD3) detects abnormally high temperature.																																																																																												
P19	Outdoor unit No. detected	P19				ALT	4-way valve reversing error Abnormality in refrigerating cycle is detected during heating operation.																																																																																												
P20	-	P20				ALT	Activation of high-pressure protection High pressure (Pd) sensor detects high pressure that exceeds standard value.																																																																																												

MG-CTT: Magnet contactor

(Errors detected by IPDU featuring in SMMS standard outdoor unit - typical examples)

Check code		Display of receiving unit			Typical fault site	Description of error	
Outdoor 7-segment display		TCC-LINK central control or main remote controller display	Indicator light block				
Sub-code			Operation	Timer	Ready	Flash	
F13	01: Compressor 1 02: Compressor 2 03: Compressor 3	F13	⊙ ⊙ ⊙		ALT	Error in temperature sensor built into indoor IGBT (TH)	Temperature sensor built into indoor IGBT (TH) has been open / short-circuited.
H01	01: Compressor 1 02: Compressor 2 03: Compressor 3	H01	● ⊙ ●			Compressor breakdown	Inverter current (Idc) detection circuit detects overcurrent.
H02	01: Compressor 1 02: Compressor 2 03: Compressor 3	H02	● ⊙ ●			Compressor error (lockup)	Compressor lockup is detected
H03	01: Compressor 1 02: Compressor 2 03: Compressor 3	H03	● ⊙ ●			Current detection circuit error	Abnormal current is detected while inverter compressor is turned off.
P04	01: Compressor 1 02: Compressor 2 03: Compressor 3	P04	⊙ ● ⊙		ALT	Activation of high-pressure SW	High-pressure SW is activated.
P07		P07	⊙ ● ⊙		ALT	Heat sink overheating error	Temperature sensor built into IGBT (TH) detects overheating.
P20		P20	⊙ ● ⊙		ALT	High-pressure protection activation	High-pressure (Pd) sensor detected a value over the criteria.
P22	SMMS (Series 1) 04: Rotation difference error 06: Maximum rotation exceeded 08: Out of step 0A: Idc activation 0C: Fan lock 0d: Lock 0E: Sync error 0F: Control error SMMS-i (Series 4) 0..: IGBT circuit 1..: Position detection circuit error 3..: Motor lockup error 4..: Motor current detection C..: TH sensor error D..: TH sensor error E..: Inverter DC voltage error (outdoor fan) Note: Although letters 0 to F appear at locations indicated by ":", please ignore them.	P22	⊙ ● ⊙		ALT	Outdoor fan IPDU error	Outdoor fan IPDU detects error.
P26	01: Compressor 1 02: Compressor 2 03: Compressor 3	P26	⊙ ● ⊙		ALT	Activation of G-Tr (IGBT) short-circuit protection	Short-circuit protection for compressor motor driver circuit components is activated (momentary overcurrent).
P29	01: Compressor 1 02: Compressor 2 03: Compressor 3	P29	⊙ ● ⊙		ALT	Compressor position detection circuit error	Compressor motor position detection error is detected.

Note: The above check codes are examples only, and different check codes may be displayed depending on the outdoor unit configuration (e.g. a Super heat recovery multi system). For details, see the service manual for the outdoor unit.

8-3. Troubleshooting by check Display on Remote Controller

■ In case of wired remote controller (RBC-AMT32E)

1. Confirmation and check

When a trouble occurred on the air conditioner, the check code and the indoor unit No. are displayed on the display section of the remote controller.

The check code is displayed while the air conditioner operates.

If the display disappeared, operate the air conditioner and check the error based upon the following "Confirmation of error history".

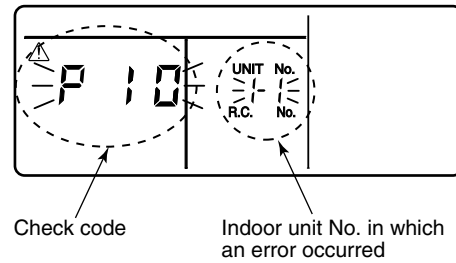

2. Confirmation of error history

When a trouble occurred on the air conditioner, the error history can be confirmed with the following procedure.

(Up to 4 error histories are stored in memory.)

This history can be confirmed from either operating status or stop status.

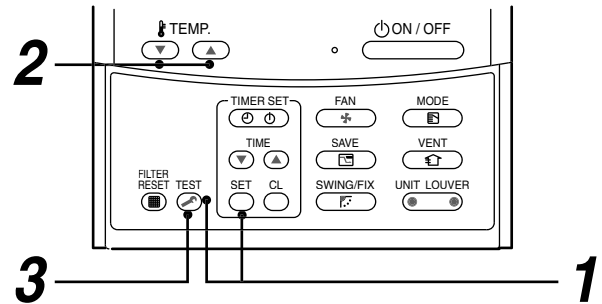

Procedure	Description
1	<p>When pushing and buttons simultaneously for 4 seconds or more, the below display appears. If [Service Check] is displayed, the mode enters in the error history mode.</p> <ul style="list-style-type: none"> • [01: Error history order] is displayed in CODE No. window. • [Check Code] is displayed in check code window. • [Indoor unit address with error] is displayed in UNIT No.
2	<p>Every pushing temp. set / buttons, the error histories stored in the memory are displayed in order. The numbers in CODE No. indicates CODE No. [01] (Latest) to [04] (Oldest).</p> <p>CAUTION Do not push button because all the error histories of the indoor unit will be deleted.</p>
3	<p>After confirmation, push button to return to the usual display.</p>

How to read the check monitor display

<7-segment display>



<How to read>

0 1 2 3 4 5 6 7 8 9 A b C d E F H J L P

■ In case of central remote controller (TCB-SC642TLE2)

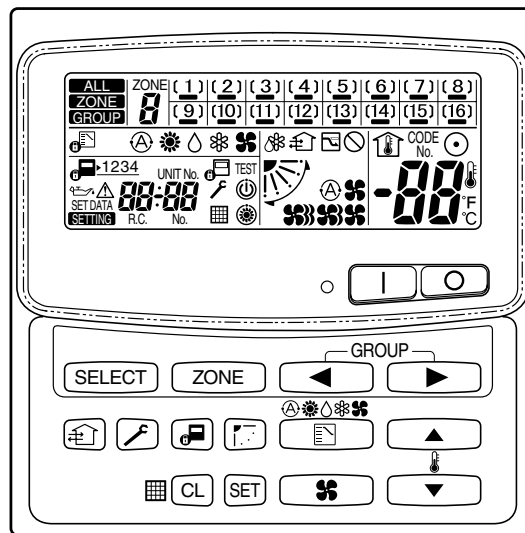

1. Confirmation and check

When a trouble occurred on the air conditioner, the check code and the indoor unit No. are displayed on the display section of the remote controller.

The check code is displayed while the air conditioner operates.

If the display disappeared, operate the air conditioner and check the error based upon the following “Confirmation of error history”.

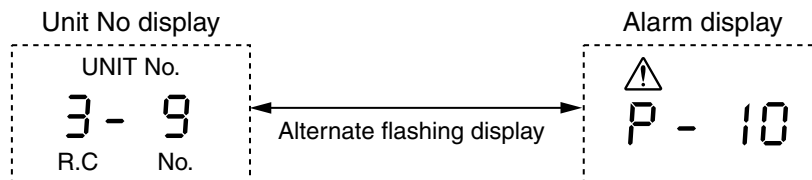

2. Confirmation of error history

When a trouble occurred on the air conditioner, the error history can be confirmed with the following procedure. (Up to 4 error histories are stored in memory.)

This history can be confirmed from either operating or stop.

- 1) Push and buttons in succession for 4 seconds or more.
- 2) SERVICE CHECK goes on and Item code 01 goes on.
- 3) When selecting (flash) the group number if there is the alarm history, the UNIT number and the latest alarm history are displayed alternately.
* In this time, the temperature cannot be set up.
- 4) To confirm the alarm history other than the latest one, push temp. set / to select Item code (01 to 04).
- 5) To confirm the alarm in the other group, push and to select the group number
Do not push button because all the alarm histories of the currently selected group are deleted.
- 6) To finish the service check, push button.

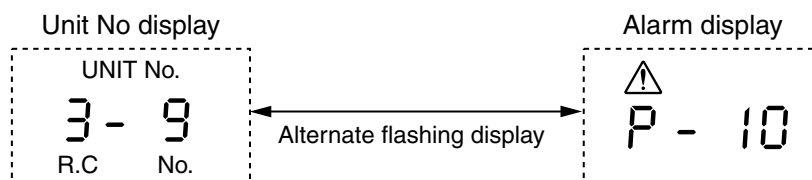





■ Indoor unit display part (Receiving unit) (Wireless type)

When specifying the check code, check 7-segment display on the center unit.

For the check code which is not displayed on the outdoor 7-segment, confirm it in Section “8-2 How to Check / Check code display list (Indoor unit)”.

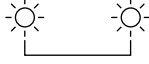
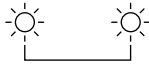
● : Goes off, ○ : Goes on, ◐ : Flash (0.5 second)

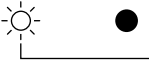
Lamp indication	Check code	Cause of trouble occurrence	
Operation Timer Ready ● ● ● No indication at all	—	Power supply OFF or miswiring between receiving unit and indoor unit	
Operation Timer Ready ◐ ● ● Flash	E01	Receiving error } Receiving unit } Miswiring or wire connection error Sending error } between receiving unit and indoor unit Communication interruption }	
	E02		
	E03		
	Operation Timer Ready ● ● ◐ Flash	E08	Duplicated indoor unit No. (Address) } Setup error Duplicated header units of remote controller }
		E09	
		E10	Communication error between MCU on indoor unit P.C. board
		E12	Automatic address start error
		E18	Wire connection error between indoor units, indoor power supply OFF
Operation Timer Ready ● ● ◐ Flash	E04	Miswiring or wire connection error between indoor unit and outdoor unit (Communication interruption between indoor and outdoor units)	
	E06	Communication (receiving) error between indoor and outdoor units, decrease of No. of connected indoor units	
	E07	Communication (sending) error between indoor and outdoor units	
	E15	No indoor unit during setting of automatic address	
	E16	No. of connected indoor units, capacity over	
	E19	Error of No. of center unit	
	E20	Disagreement of refrigerant pipe communication during setting of automatic address	
	E23	Communication (sending) error between outdoor units	
	E25	Duplicated setting of follower unit address	
	E26	Communication (receiving) error between outdoor units, decrease of No. of connected outdoor units	
	E28	Follower unit error	
E31	IPDU communication error		
Operation Timer Ready ● ◐ ◐ Alternate flash	P01	Indoor fan error	
	P10	Indoor overflow error	
	P12	Indoor fan error	
	P13	Outdoor unit liquid back detection error	
Operation Timer Ready ◐ ● ◐ Alternate flash	P03	Outdoor unit discharge temp. (TD1) error	
	P04	Outdoor unit high pressure switch operation	
	P05	Outdoor unit open phase error was detected, negative phase error was detected	
	P07	Outdoor unit heat sink overheat error: Heat radiation error of electric part (IGBT) in outdoor unit	
	P15	Gas leak was detected: Short of refrigerant charge amount	
	P17	Outdoor unit discharge temp. (TD2) error	
	P19	Outdoor unit 4-way valve inverse error	
	P20	High pressure protection error	
	P22	Outdoor unit DC fan error	
	P26	Outdoor unit G-Tr short-circuit error	
	P29	Compressor position detection circuit error	
P31	Other indoor unit stopped due to error in the group.		

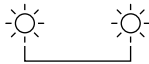
Lamp indication	Check code	Cause of trouble occurrence	
Operation Timer Ready  Alternate flash	F01	Heat exchanger sensor (TCJ) error Heat exchanger sensor (TC2) error Heat exchanger sensor (TC1) error Room temp. sensor (TA) error } Temp. sensor error in indoor unit	
	F02		
	F03		
	F10		
Operation Timer Ready  Alternate flash	F04	Discharge temp. sensor (TD1) error Discharge temp. sensor (TD2) error Heat exchanger sensor (TE1) error Liquid temp. sensor (TL) error Outside temp. sensor (TO) error Suction temp. sensor (TS1) error Heat sink sensor (TH) error } Outdoor unit temp. sensor error	
	F05		
	F06		
	F07		
	F08		
	F12		
	F13		
	F15	Misconnection of heat exchanger sensor (TE) with liquid temp. sensor (TL) → Miswiring of temp. sensor in outdoor unit or miss-mounting	
	F16	Miswiring between high pressure sensor (Pd) and low pressure sensor (Ps) → Misconnection of pressure sensor in outdoor unit	
		F23	Low pressure sensor (Ps) error High pressure sensor (Pd) error } Pressure sensor error in outdoor unit
F24			
Operation Timer Ready  Simultaneous flash	F29	Indoor unit EEPROM error	
Operation Timer Ready  Flash	H01	Compressor break-down Compressor lock Current detection circuit error } Outdoor unit compressor system error	
	H02		
	H03		
	H04	Compressor 1 case thermo operation	
	H06	Low pressure (Ps) drop error	Protections stop of outdoor unit
	H07	Oil face drop detection error	
	H08	Oil face detection circuit system temp. sensor (TK1, TK2, TK3, TK4) error	
	H14	Compressor 2 chase thermo operation: Protective device of outdoor unit operated.	
	H16	Oil face detection circuit system error: Outdoor unit TK1, TK2, TK3, TK4 circuit system error	
Operation Timer Ready  Simultaneous flash	L03	Duplicated header units in indoor unit	
	L05	Duplicated priority indoor unit (Displayed in the room with priority)	
	L06	Duplicated priority indoor unit (Displayed in a room except one with priority)	
	L07	Group cable was connected to individual indoor unit.	
	L08	Indoor group address was unset.	
	L09	Indoor capacity was unset.	
	L04	Duplicated setting of outdoor line address	
Operation Timer Ready  Simultaneous flash	L10	Outdoor capacity was unset.	
	L17	Disagreement error of outdoor unit type	
	L18	COOL/HEAT select unit system error	
	L20	Duplicated address of central control system	
	L28	No. of connected outdoor units over	
	L29	Defective No. of IPDU	
	L30	Indoor unit outside interlock error	
Operation Timer Ready  Simultaneous flash	F31	Outdoor unit EEPROM error	

■ Others (Except check code)

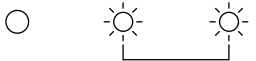
Lamp indication	Check code	Cause of trouble occurrence
Operation Timer Ready  Simultaneous flash	—	During test run
Operation Timer Ready  Alternate flash	—	COOL/HEAT disagreement (Automatic cooling/heating setup to automatic cooling/heating unavailable model, heating setup to cooling only model)

8-4. Check codes displayed on remote controller and SMMS outdoor unit (7-segment display on I/F board) and locations to be checked

For other types of outdoor units, refer to their own service manuals.

Check code			Location of detection	Description	System status	Error detection condition(s)	Check items (locations)
Main remote controller	Outdoor 7-segment display						
	Check code	Sub-code					
E01	—	—	Remote controller	Indoor-remote controller communication error (detected at remote controller end)	Stop of corresponding unit	Communication between indoor P.C. board and remote controller is disrupted.	Check remote controller inter-unit tie cable (A / B). Check for broken wire or connector bad contact. Check indoor power supply. Check for defect in indoor P.C. board. Check remote controller address settings (when two remote controllers are in use). Check remote controller P.C. board.
E02	—	—	Remote controller	Remote controller transmission error	Stop of corresponding unit	Signal cannot be transmitted from remote controller to indoor unit.	Check internal transmission circuit of remote controller. --- Replace remote controller as necessary.
E03	—	—	Indoor unit	Indoor-remote controller communication error (detected at indoor end)	Stop of corresponding unit	There is no communication from remote controller (including wireless) or network adaptor.	Check remote controller and network adaptor wiring.
E04	—	—	Indoor unit	Indoor-outdoor communication circuit error (detected at indoor end)	Stop of corresponding unit	Indoor unit is not receiving signal from outdoor unit.	Check order in which power was turned on for indoor and outdoor units. Check indoor address setting. Check indoor-outdoor tie cable. Check outdoor termination resistance setting (SW30, Bit 2).
E06	E06	No. of indoor units from which signal is received normally	I/F	Dropping out of indoor unit	All stop	Indoor unit initially communicating normally fails to return signal for specified length of time.	Check power supply to indoor unit. (Is power turned on?) Check connection of indoor-outdoor communication cable. Check connection of communication connectors on indoor P.C. board. Check connection of communication connectors on outdoor P.C. board. Check for defect in indoor P.C. board. Check for defect in outdoor P.C. board (I/F).
—	E07	—	I/F	Indoor-outdoor communication circuit error (detected at outdoor end)	All stop	Signal cannot be transmitted from outdoor to indoor units for 30 seconds continuously.	Check outdoor termination resistance setting (SW30, Bit 2). Check connection of indoor-outdoor communication circuit.

Check code			Location of detection	Description	System status	Error detection condition(s)	Check items (locations)
Main remote controller	Outdoor 7-segment display						
	Check code	Sub-code					
E08	E08	Duplicated indoor address	Indoor unit I/F	Duplicated indoor address	All stop	More than one indoor unit is assigned same address.	Check indoor addresses. Check for any change made to remote controller connection (group / individual) since indoor address setting.
E09	—	—	Remote controller	Duplicated master remote controller	Stop of corresponding unit	In two remote controller configuration (including wireless), both controllers are set up as master. (Header indoor unit is shut down with alarm, while follower indoor units continue operating.)	Check remote controller settings. Check remote controller P.C. boards.
E10	—	—	Indoor unit	Indoor inter-MCU communication error	Stop of corresponding unit	Communication cannot be established / maintained upon turning on of power or during communication.	Check for defect in indoor P.C. board
E12	E12	01: Indoor-outdoor communication 02: Outdooroutdoor communication	I/F	Automatic address starting error	All stop	Indoor automatic address setting is started while automatic address setting for equipment in other refrigerant line is in progress. Outdoor automatic address setting is started while automatic address setting for indoor units is in progress.	Perform automatic address setting again after disconnecting communication cable to that refrigerant line.
E15	E15	—	I/F	Indoor unit not found during automatic address setting	All stop	Indoor unit cannot be detected after indoor automatic address setting is started.	Check connection of indoor-outdoor communication line. Check for error in indoor power supply system. Check for noise from other devices. Check for power failure. Check for defect in indoor P.C. board.
E16	E16	00: Overloading 01-: No. of units connected	I/F	Too many indoor units connected	All stop	Combined capacity of indoor units exceeds 135 % of combined capacity of outdoor units. Note: If this code comes up after backup setting for outdoor unit failure is performed, perform "No overloading detected" setting. < "No overloading detected " setting method> Turn on SW09/Bit 2 on I/F P.C. board of outdoor header unit. More than 48 indoor units are connected.	Check capacities of indoor units connected. Check combined HP capacities of indoor units. Check HP capacity settings of outdoor units. Check No. of indoor units connected. Check for defect in outdoor P.C. board (I/F).

Check code		Location of detection	Description	System status	Error detection condition(s)	Check items (locations)	
Main remote controller	Outdoor 7-segment display						
	Check code						Sub-code
E18	—	—	Indoor unit	Error in communication between indoor header and follower units	Stop of corresponding unit	Periodic communication between indoor header and follower units cannot be maintained.	Check remote controller wiring. Check indoor power supply wiring. Check P.C. boards of indoor units.
E19	E19	00: No header unit 02: Two or more header units	I/F	Error in number of outdoor header units	All stop	There is more than one outdoor header unit in one line. There is no outdoor header unit in one line.	Outdoor header unit is outdoor unit to which indoor outdoor cable (U1,U2) is connected. Check connection of indoor-outdoor communication line. Check for defect in outdoor P.C. board (I/F).
E20	E20	01: Connection of outdoor unit from other line 02: Connection of indoor unit from other line	I/F	Connection to other line found during automatic address setting	All stop	Equipment from other line is found to have been connected when indoor automatic address setting is in progress.	Disconnect inter-line tie cable in accordance with automatic address setting method explained in gAddress setting h section.
E23	E23	—	I/F	Outdooroutdoor communication transmission error	All stop	Signal cannot be transmitted to other outdoor units for at least 30 seconds continuously.	Check power supply to outdoor units. (Is power turned on?) Check connection of tie cables between outdoor units for bad contact or broken wire. Check communication connectors on outdoor P.C. boards. Check for defect in outdoor P.C. board (I/F). Check termination resistance setting for communication between outdoor units.
E25	E25	—	I/F	Duplicated follower outdoor address	All stop	There is duplication in outdoor addresses set manually.	Note: Do not set outdoor addresses manually.
E26	E26	Address of outdoor unit from which signal is not received normally	I/F	Dropping out of outdoor unit	All stop	Outdoor unit initially communicating normally fails to return signal for specified length of time.	Backup setting is being used for outdoor units. Check power supply to outdoor unit. (Is power turned on?) Check connection of tie cables between outdoor units for bad contact or broken wire. Check communication connectors on outdoor P.C. boards. Check for defect in outdoor P.C. board (I/F).
E28	E28	Detected outdoor unit No.	I/F	Outdoor follower unit error	All stop	Outdoor header unit receives error code from outdoor follower unit.	Check check code displayed on outdoor follower unit. <Convenient functions> If SW04 is pressed and held for at least 1 second while [E28] is displayed on the 7-segmentdisplay of outdoor header unit, the fan of the outdoor unit that has been shut down due to an error comes on. If SW04 and SW05 are pressed simultaneously, the fans of normal outdoor units come on. To stop the fan or fans, press SW05 on its own.

Check code			Location of detection	Description	System status	Error detection condition(s)	Check items (locations)																																																																																			
Main remote controller	Outdoor 7-segment display																																																																																									
	Check code	Sub-code																																																																																								
E31	E31	SMMS (Series 1) 01: A3-IPDU1 error 02: A3-IPDU2 error 03: A3-IPDU1/A3-IPDU2 error 04: Fan IPDU error 05: A3-IPDU1 + Fan IPDU error 06: A3-IPDU2 + Fan IPDU error 07: All IPDU error or Communication error between IPDU and I/F circuit board or Outdoor I/F circuit board error SMMS-i (Series 4) <table border="1" style="margin-left: 20px;"> <thead> <tr> <th rowspan="2"></th> <th colspan="3">A3-IPDU</th> <th rowspan="2">Fan IPDU</th> </tr> <tr> <th>1</th> <th>2</th> <th>3</th> </tr> </thead> <tbody> <tr><td>01</td><td>○</td><td></td><td></td><td></td></tr> <tr><td>02</td><td>○</td><td></td><td></td><td></td></tr> <tr><td>03</td><td>○</td><td>○</td><td></td><td></td></tr> <tr><td>04</td><td></td><td></td><td>○</td><td></td></tr> <tr><td>05</td><td>○</td><td></td><td>○</td><td></td></tr> <tr><td>06</td><td></td><td>○</td><td>○</td><td></td></tr> <tr><td>07</td><td>○</td><td>○</td><td>○</td><td></td></tr> <tr><td>08</td><td></td><td></td><td></td><td>○</td></tr> <tr><td>09</td><td>○</td><td></td><td></td><td>○</td></tr> <tr><td>0A</td><td>○</td><td></td><td></td><td>○</td></tr> <tr><td>0B</td><td>○</td><td>○</td><td></td><td>○</td></tr> <tr><td>0C</td><td></td><td></td><td>○</td><td>○</td></tr> <tr><td>0D</td><td>○</td><td></td><td>○</td><td>○</td></tr> <tr><td>0E</td><td>○</td><td>○</td><td>○</td><td></td></tr> <tr><td>0F</td><td>○</td><td>○</td><td>○</td><td>○</td></tr> </tbody> </table> Symbol ○ signifies site of IPDU error.		A3-IPDU			Fan IPDU	1	2	3	01	○				02	○				03	○	○			04			○		05	○		○		06		○	○		07	○	○	○		08				○	09	○			○	0A	○			○	0B	○	○		○	0C			○	○	0D	○		○	○	0E	○	○	○		0F	○	○	○	○	I/F	IPDU communication error	All stop	Communication is disrupted between IPDUs (P.C. boards) in inverter box.	<ul style="list-style-type: none"> Check wiring and connectors involved in communication between IPDU-I/F P.C. board for bad contact or broken wire. Check for defect in outdoor P.C. board (I/F, A3-IPDU or Fan IPDU). Check for external noise.
	A3-IPDU			Fan IPDU																																																																																						
	1	2	3																																																																																							
01	○																																																																																									
02	○																																																																																									
03	○	○																																																																																								
04			○																																																																																							
05	○		○																																																																																							
06		○	○																																																																																							
07	○	○	○																																																																																							
08				○																																																																																						
09	○			○																																																																																						
0A	○			○																																																																																						
0B	○	○		○																																																																																						
0C			○	○																																																																																						
0D	○		○	○																																																																																						
0E	○	○	○																																																																																							
0F	○	○	○	○																																																																																						
F01	-	-	Indoor unit	Indoor TCJ sensor error	Stop of corresponding unit	Sensor resistance is infinity or zero (open / short circuit).	Check connection of TCJ sensor connector and wiring. Check resistance characteristics of TCJ sensor. Check for defect in indoor P.C. board.																																																																																			
F02	-	-	Indoor unit	Indoor TC2 sensor error	Stop of corresponding unit	Sensor resistance is infinity or zero (open / short circuit).	Check connection of TC2 sensor connector and wiring. Check resistance characteristics of TC2 sensor. Check for defect in indoor P.C. board.																																																																																			
F03	-	-	Indoor unit	Indoor TC1 sensor error	Stop of corresponding unit	Sensor resistance is infinity or zero (open / short circuit).	Check connection of TC1 sensor connector and wiring. Check resistance characteristics of TC1 sensor. Check for defect in indoor P.C. board.																																																																																			
F04	F04	-	I/F	TD1 sensor error	All stop	Sensor resistance is infinity or zero (open / short circuit).	Check connection of TD1 sensor connector. Check resistance characteristics of TD1 sensor. Check for defect in outdoor P.C. board (I/F).																																																																																			
F05	F05	-	I/F	TD2 sensor error	All stop	Sensor resistance is infinity or zero (open / short circuit).	Check connection of TD2 sensor connector. Check resistance characteristics of TD2 sensor. Check for defect in outdoor P.C. board (I/F).																																																																																			
F06	F06	TE1 sensor error 02: TE2 sensor error	I/F	TE1/TE2 sensor error	All stop	Sensor resistance is infinity or zero (open / short circuit).	Check connection of TE1/TE2 sensor connectors. Check resistance characteristics of TE1/TE2 sensors. Check for defect in outdoor P.C. board (I/F).																																																																																			

Check code		Location of detection	Description	System status	Error detection condition(s)	Check items (locations)
Main remote controller	Outdoor 7-segment display					
	Check code	Sub-code				
F07	F07	—	I/F	TL sensor error	All stop	Sensor resistance is infinity or zero (open / short circuit). Check connection of TL sensor connector. Check resistance characteristics of TL sensor. Check for defect in outdoor P.C. board (I/F).
F08	F08	—	I/F	TO sensor error	All stop	Sensor resistance is infinity or zero (open / short circuit). Check connection of TO sensor connector. Check resistance characteristics of TO sensor. Check for defect in outdoor P.C. board (I/F).
F10	—	—	Indoor unit	Indoor TA sensor error	Stop of corresponding unit	Sensor resistance is infinity or zero (open / short circuit). Check connection of TA sensor connector and wiring. Check resistance characteristics of TA sensor. Check for defect in indoor P.C. board.
F11	—	—	Indoor unit	Indoor TF sensor error	Stop of corresponding unit	Sensor resistance is infinity or zero (open / short circuit). Check connection of TF sensor connector and wiring. Check resistance characteristics of TF sensor. Check for defect in indoor P.C. board.
F12	F12	—	I/F	TS1 sensor error	All stop	Sensor resistance is infinity or zero (open / short circuit). Check connection of TS1 sensor connector. Check resistance characteristics of TS1 sensor. Check for defect in outdoor P.C. board (I/F).
F13		01: Compressor 1 side 02: Compressor 2 side 03: Compressor 3 side	IPDU	TH sensor error	All stop	Sensor resistance is infinity or zero (open / short circuit). Defect in IGBT built-in temperature sensor → Replace A3-IPDU P.C. board.
F15	F15	—	I/F	Outdoor temperature sensor wiring error (TE1, TL)	All stop	During compressor operation in HEAT mode, TE1 continuously provides temperature reading higher than indicated by TL by at least specified margin for 3 minutes or more. Check installation of TE1 and TL sensors. Check resistance characteristics of TE1 and TL sensors. Check for outdoor P.C. board (I/F) error.
F16	F16	—	I/F	Outdoor pressure sensor wiring error (Pd, Ps)	All stop	Readings of high-pressure Pd sensor and lowpressure Ps sensor are switched. Output voltages of both sensors are zero. Check connection of high-pressure Pd sensor connector. Check connection of low-pressure Ps sensor connector. Check for defect in pressure sensors Pd and Ps. Check for error in outdoor P.C. board (I/F). Check for deficiency in compressive output of compressor.
F22	F22	—	I/F	TD3 sensor error	All stop	Sensor resistance is infinity or zero. (open / short circuit) Check connection of TD3 sensor connector. Check resistance characteristics of TD3 sensor. Check for defect in outdoor P.C. board (I/F).
F23	F23	—	I/F	Ps sensor error	All stop	Output voltage of Ps sensor is zero. Check for connection error involving Ps sensor and Pd sensor connectors. Check connection of Ps sensor connector. Check for defect in Ps sensor. Check for deficiency in compressive output of compressor. Check for defect in 4-way valve. Check for defect in outdoor P.C. board (I/F). Check for defect in SV4 circuit.

Check code		Location of detection	Description	System status	Error detection condition(s)	Check items (locations)	
Main remote controller	Outdoor 7-segment display						
	Check code	Sub-code					
F24	F24	—	I/F	Pd sensor error	All stop	Output voltage of Pd sensor is zero (sensor open-circuited). Pd > 4.15 MPa despite compressor having been turned off.	Check connection of Pd sensor connector. Check for defect in Pd sensor. Check for defect in outdoor P.C. board (I/F).
F29	—	—	Indoor unit	Other indoor error	Stop of corresponding unit	Indoor P.C. board does not operate normally.	Check for defect in indoor P.C. board (faulty EEPROM)
F31	F31	—	I/F	Outdoor EEPROM error	All stop *1	Outdoor P.C. board (I/F) does not operate normally.	Check power supply voltage. Check power supply noise. Check for defect in outdoor P.C. board (I/F).
H01	H01	01: Compressor 1 side 02: Compressor 2 side 03: Compressor 3 side	IPDU	Compressor breakdown	All stop	Inverter current detection circuit detects overcurrent and shuts system down.	Check power supply voltage. (380-415V ± 10 %). Check for defect in compressor. Check for possible cause of abnormal overloading. Check for defect in outdoor P.C. board (A3-IPDU).
H02	H02	01: Compressor 1 side 02: Compressor 2 side 03: Compressor 3 side	IPDU	Compressor error (lockup) MG-CTT error	All stop	Overcurrent is detected several seconds after startup of inverter compressor.	Check for defect in compressor. Check power supply voltage. (380-415V ± 10 %). Check compressor system wiring, particularly for open phase. Check connection of connectors / terminals on A3-IPDU P.C. board. Check conductivity of case heater. (Check for refrigerant entrapment inside compressor.) Check for defect in outdoor P.C. board (A3-IPDU). Check outdoor MG-CTT.
H03	H03	01: Compressor 1 side 02: Compressor 2 side 03: Compressor 3 side	IPDU	Current detection circuit error	All stop	Current flow of at least specified magnitude is detected despite inverter compressor having been shut turned off.	Check current detection circuit wiring. Check defect in outdoor P.C. board (A3-IPDU).
H05	H05	—	I/F	TD1 sensor miswiring (incomplete insertion)	All stop	Discharge temperature of compressor 1 (TD1) does not increase despite compressor being in operation.	Check installation of TD1 sensor. Check connection of TD1 sensor connector and wiring. Check resistance characteristics of TD1 sensor. Check for defect in outdoor P.C. board (I/F).
H06	H06	—	I/F	Activation of low-pressure protection	All stop	Low-pressure Ps sensor detects operating pressure lower than 0.02 MPa.	Check service valves to confirm full opening (both gas and liquid sides). Check outdoor PMVs for clogging (PMV1, 2). Check for defect in SV2 or SV4 circuits. Check for defect in low-pressure Ps sensor. Check indoor filter for clogging. Check valve opening status of indoor PMV. Check refrigerant piping for clogging. Check operation of outdoor fan (during heating). Check for insufficiency in refrigerant quantity.

*1 Total shutdown in case of header unit
Continued operation in case of follower unit

MG-CTT: Magnet contactor

Check code		Location of detection	Description	System status	Error detection condition(s)	Check items (locations)	
Main remote controller	Outdoor 7-segment display						
	Check code	Sub-code					
H07	H07	—	I/F	Low oil level protection	All stop	Operating compressor detects continuous state of low oil level for about 2 hours.	<All outdoor units in corresponding line to be checked> Check balance pipe service valve to confirm full opening. Check connection and installation of TK1, TK2, TK3, TK4, and TK5 sensors. Check resistance characteristics of TK1, TK2, TK3, TK4, and TK5 sensors. Check for gas or oil leak in same line. Check for refrigerant entrapment inside compressor casing. Check SV3A, SV3B, SV3C, SV3D, SV3E, and SV3F valves for defect. Check oil return circuit of oil separator for clogging. Check oil equalizing circuit for clogging.
H08	H08	01: TK1 sensor error 02: TK2 sensor error 03: TK3 sensor error 04: TK4 sensor error 05: TK5 sensor error	I/F	Error in temperature sensor for oil level detection	All stop	Sensor resistance is infinity or zero (open / short circuit).	Check connection of TK1 sensor connector. Check resistance characteristics of TK1 sensor. Check for defect in outdoor P.C. board (I/F).
					All stop	Sensor resistance is infinity or zero (open / short circuit).	Check connection of TK2 sensor connector. Check resistance characteristics of TK2 sensor. Check for defect in outdoor P.C. board (I/F).
					All stop	Sensor resistance is infinity or zero (open / short circuit).	Check connection of TK3 sensor connector. Check resistance characteristics of TK3 sensor. Check for defect in outdoor P.C. board (I/F).
					All stop	Sensor resistance is infinity or zero (open / short circuit).	Check connection of TK4 sensor connector. Check resistance characteristics of TK4 sensor. Check for defect in outdoor P.C. board (I/F).
					All stop	Sensor resistance is infinity or zero (open / short circuit).	Check connection of TK5 sensor connector. Check resistance characteristics of TK5 sensor. Check for defect in outdoor P.C. board (I/F).

Main remote controller	Check code		Location of detection	Description	System status	Error detection condition(s)	Check items (locations)
	Outdoor 7-segment display						
	Check code	Sub-code					
H14	H14	—	I/F	Compressor 2 case thermo activation	All stop	Compressor 2 case thermo was activated.	Check Compressor 2 case thermo circuit. (Connector, Wiring, Circuit board) Open and check the service valve. (Gas side, Liquid side) Check the outdoor PMV clogging (PMV1, 2). Check the SV42 circuit. Check the SV4 circuit (SV41 / 42 miswiring). Check the opening status of indoor PMV. Check the four-way valve error. Check the refrigerant shortage.
H15	H15	—	I/F	TD2 sensor miswiring (incomplete insertion)	All stop	Air discharge temperature of (TD2) does not increase despite compressor 2 being in operation.	Check installation of TD2 sensor. Check connection of TD2 sensor connector and wiring. Check resistance characteristics of TD2 sensor. Check for defect in outdoor P.C. board (I/F).

Main remote controller	Check code		Location of detection	Description	System status	Error detection condition(s)	Check items (locations)
	Outdoor 7-segment display						
	Check code	Sub-code					
H16	H16	SMMS (1 series) 01: TK1 oil circuit error 02: TK2 oil circuit error 03: TK3 oil circuit error 04: TK4 oil circuit error	I/F	Oil detection circuit error	All stop	The temperature change of TK1 cannot be detected even after Compressor 1 starts operating.	Check the TK1 sensor installation. Check the TK1 sensor resistant characteristics. Check the misconnection of TK1, TK2, TK3, or TK4. Check the SV3E valve error. Check the oil circuit capillary clogging and non-return valve error Check the hibernating refrigerant in compressor.
		SMMS (1 series) 01: TK1 oil circuit error 02: TK2 oil circuit error 03: TK3 oil circuit error 04: TK4 oil circuit error	I/F	Oil detection circuit error	All stop	The temperature change of TK2 cannot be detected even after Compressor 2 starts operating.	Check the TK2 sensor installation. Check the TK2 sensor resistant characteristics. Check the misconnection of TK1, TK2, TK3, or TK4. Check the SV3E valve error. Check the oil circuit capillary clogging and non-return valve error. Check the hibernating refrigerant in compressor.
						The temperature change of TK3 cannot be detected even after Compressor 3 starts operating.	Check the TK3 sensor installation. Check the TK3 sensor resistant characteristics. Check the misconnection of TK1, TK2, TK3, or TK4. Check the SV3E valve error. Check the oil circuit capillary clogging and non-return valve error. Check the hibernating refrigerant in compressor.
						The temperature change of TK4 cannot be detected even after Compressor 4 starts operating, or the temperature difference from that of the other TK sensor changes only in the specified range for a given time or longer.	Check the TK4 sensor installation. Check the TK4 sensor resistant characteristics. Check the misconnection of TK1, TK2, TK3, or TK4. Check the SV3E valve error. Check the oil circuit capillary clogging and non-return valve error. Check the hibernating refrigerant in compressor.
		SMMS-i (4 series) 01: TK1 oil circuit error 02: TK2 oil circuit error 03: TK3 oil circuit error 04: TK4 oil circuit error 05: TK5 oil circuit error	I/F	Oil level detection circuit error	All stop	No temperature change is detected by TK1 despite compressor 1 having been started.	Check for disconnection of TK1 sensor. Check resistance characteristics of TK1 sensor. Check for connection error involving TK1, TK2, TK3, TK4, and TK5 sensors Check for faulty operation in SV3E or SV3F valve. Check for clogging in oil equalizing circuit capillary and faulty operation in check valve. Check for refrigerant entrapment inside compressor.
						No temperature change is detected by TK2 despite compressor 2 having been started.	Check for disconnection of TK2 sensor. Check resistance characteristics of TK2 sensor. Check for connection error involving TK1, TK2, TK3, TK4, and TK5 sensors Check for faulty operation in SV3E or SV3F valve. Check for clogging in oil equalizing circuit capillary and faulty operation in check valve. Check for refrigerant entrapment inside compressor.
						No temperature change is detected by TK3 despite compressor 3 having been started.	Check for disconnection of TK3 sensor. Check resistance characteristics of TK3 sensor. Check for connection error involving TK1, TK2, TK3, TK4, and TK5 sensors Check for faulty operation in SV3E or SV3F valve. Check for clogging in oil equalizing circuit capillary and faulty operation in check valve. Check for refrigerant entrapment inside compressor.

Main remote controller	Check code		Location of detection	Description	System status	Error detection condition(s)	Check items (locations)
	Outdoor 7-segment display						
	Check code	Sub-code					
H16	H16	SMMS-i (4 series) 01: TK1 oil circuit error 02: TK2 oil circuit error 03: TK3 oil circuit error 04: TK4 oil circuit error 05: TK5 oil circuit error	I/F	Oil level detection circuit error	All stop	No temperature change is detected by TK4 despite compressor having been started.	Check for disconnection of TK4 sensor. Check resistance characteristics of TK4 sensor. Check for connection error involving TK1, TK2, TK3, TK4, and TK5 sensors Check for faulty operation in SV3E or SV3F valve. Check for clogging in oil equalizing circuit capillary and faulty operation in check valve. Check for refrigerant entrapment inside compressor.
						No temperature change is detected by TK5 despite compressor having been started.	Check for disconnection of TK5 sensor. Check resistance characteristics of TK5 sensor. Check for connection error involving TK1, TK2, TK3, TK4, and TK5 sensors Check for faulty operation in SV3E valve. Check for clogging in oil equalizing circuit capillary and faulty operation in check valve. Check for refrigerant entrapment inside compressor.
H25	H25	–	I/F	TD3 sensor miswiring (incomplete insertion)	All stop	Air discharge temperature (TD3) does not increase despite compressor 3 being in operation.	Check installation of TD3 sensor. Check connection of TD3 sensor connector and wiring. Check resistance characteristics of TD3 sensor. Check for defect in outdoor P.C. board (I/F).
L02	L02	–	Indoor unit	Outdoor unit model mismatch error	Only the target unit stopped	An error was found on the outdoor unit model.	Check the model name of the outdoor unit. Check the miswiring of the communication line between indoor and outdoor.
L03	–	–	Indoor unit	Duplicated indoor header unit	Stop of corresponding unit	There is more than one header unit in group.	Check indoor addresses. Check for any change made to remote controller connection (group / individual) since indoor address setting.
L04	L04	–	I/F	Duplicated outdoor line address	All stop	There is duplication in line address setting for outdoor units belonging to different refrigerant piping systems.	Check line addresses.
L05	–	–	I/F	Duplicated priority indoor unit (as displayed on priority indoor unit)	All stop	More than one indoor unit has been set up as priority indoor unit.	Check display on priority indoor unit.
L06	L06	No. of priority indoor units	I/F	Duplicated priority indoor unit (as displayed on indoor unit other than priority indoor unit)	All stop	More than one indoor unit have been set up as priority indoor unit.	Check displays on priority indoor unit and outdoor unit.
L07	–	–	Indoor unit	Connection of group control cable to stand-alone indoor unit	Stop of corresponding unit	There is at least one stand-alone indoor unit to which group control cable is connected.	Check indoor addresses.
L08	L08	–	Indoor unit	Indoor group / addresses not set	Stop of corresponding unit	Address setting has not been performed for indoor units.	Check indoor addresses. Note: This code is displayed when power is turned on for the first time after installation.
L09	–	–	Indoor unit	Indoor capacity not set	Stop of corresponding unit	Capacity setting has not been performed for indoor unit.	Set indoor capacity. (DN = 11)

Main remote controller	Check code		Location of detection	Description	System status	Error detection condition(s)	Check items (locations)																																																																																					
	Outdoor 7-segment display																																																																																											
	Check code	Sub-code																																																																																										
L10	L10	-	I/F	Outdoor capacity not set	All stop	Jumper wire provided on P.C. board for servicing I/F P.C. board has not been removed as required for given model.	Check model setting of P.C. board for servicing outdoor I/F P.C. board.																																																																																					
L17	L17	Target indoor address	I/F	Outdoor unit model mismatch error		The outdoor unit model is duplicate. The Cool/Heat Flex series 1/2 are duplicate.	Check the outdoor unit model.																																																																																					
L18	L18	-	I/F	Cool / heat switch unit error	Only the target unit stopped	The heating operation was performed without the cool-only setting configured in a cool-only room where a cool/heat switch unit is not connected.	Check the remote controller setting. (DN="0F") Check the cool / heat switching unit. Check the piping connection of the switching unit. (Miswiring of discharge gas / suction gas) Check the SVS / SVD valve miswiring / misinstallation.																																																																																					
L20	-	-	AI-NET Indoor unit	Duplicated central control address	All stop	There is duplication in central control address setting.	Check central control addresses. Check network adaptor P.C. board (applicable to AI-NET).																																																																																					
L28	L28	-	I/F	Too many outdoor units connected	All stop	There are more than four outdoor units.	Check No. of outdoor units connected (Only up to 4 units per system allowed). Check communication lines between outdoor units. Check for defect in outdoor P.C. board (I/F).																																																																																					
L29	L29	SMMS (Series 1) 01: A3-IPDU1 error 02: A3-IPDU2 error 03: A3-IPDU1/A3-IPDU2 error 04: Fan IPDU error 05: A3-IPDU1 + Fan IPDU error 06: A3-IPDU2 + Fan IPDU error 07: All IPDU error or Communication error between IPDU and I/F circuit board or Outdoor I/F circuit board error SMMS-i (Series 4) <table border="1" style="display: inline-table; vertical-align: top;"> <thead> <tr> <th></th> <th colspan="3">A3-IPDU</th> <th>Fan IPDU</th> </tr> <tr> <th></th> <th>1</th> <th>2</th> <th>3</th> <th></th> </tr> </thead> <tbody> <tr><td>01</td><td>○</td><td></td><td></td><td></td></tr> <tr><td>02</td><td></td><td>○</td><td></td><td></td></tr> <tr><td>03</td><td>○</td><td>○</td><td></td><td></td></tr> <tr><td>04</td><td></td><td></td><td></td><td>○</td></tr> <tr><td>05</td><td>○</td><td></td><td>○</td><td></td></tr> <tr><td>06</td><td></td><td>○</td><td>○</td><td></td></tr> <tr><td>07</td><td>○</td><td>○</td><td>○</td><td></td></tr> <tr><td>08</td><td></td><td></td><td></td><td>○</td></tr> <tr><td>09</td><td>○</td><td></td><td></td><td>○</td></tr> <tr><td>0A</td><td></td><td>○</td><td></td><td>○</td></tr> <tr><td>0B</td><td>○</td><td>○</td><td></td><td>○</td></tr> <tr><td>0C</td><td></td><td></td><td>○</td><td>○</td></tr> <tr><td>0D</td><td>○</td><td></td><td>○</td><td>○</td></tr> <tr><td>0E</td><td>○</td><td>○</td><td>○</td><td>○</td></tr> <tr><td>0F</td><td>○</td><td>○</td><td>○</td><td>○</td></tr> </tbody> </table> Symbol O signifies site of IPDU error.		A3-IPDU			Fan IPDU		1	2	3		01	○				02		○			03	○	○			04				○	05	○		○		06		○	○		07	○	○	○		08				○	09	○			○	0A		○		○	0B	○	○		○	0C			○	○	0D	○		○	○	0E	○	○	○	○	0F	○	○	○	○	I/F	Error in No. of IPDUs	All stop	Insufficient number of IPDUs are detected when power is turned on.	Check model setting of P.C. board for servicing outdoor I/F P.C. board. Check connection of UART communication connector. Check A3-IPDU, fan IPDU, and I/F P.C. board for defect.
	A3-IPDU			Fan IPDU																																																																																								
	1	2	3																																																																																									
01	○																																																																																											
02		○																																																																																										
03	○	○																																																																																										
04				○																																																																																								
05	○		○																																																																																									
06		○	○																																																																																									
07	○	○	○																																																																																									
08				○																																																																																								
09	○			○																																																																																								
0A		○		○																																																																																								
0B	○	○		○																																																																																								
0C			○	○																																																																																								
0D	○		○	○																																																																																								
0E	○	○	○	○																																																																																								
0F	○	○	○	○																																																																																								

Check code		Location of detection	Description	System status	Error detection condition(s)	Check items (locations)	
Main remote controller	Outdoor 7-segment display						
	Check code						Sub-code
L30	L30	Detected indoor address	Indoor unit	External interlock of indoor unit	Stop of corresponding unit	Signal is present at external error input terminal (CN80) for 1 minute.	When external device is connected to CN80 connector: 1) Check for defect in external device. 2) Check for defect in indoor P.C. board. When external device is not connected to CN80 connector: 1) Check for defect in indoor P.C. board.
—	L31	—	I/F	Extended IC error	Continued operation	There is part failure in P.C. board (I/F).	Check outdoor P.C. board (I/F).
P01	—	—	Indoor unit	Indoor fan motor error	Stop of corresponding unit		Check the lock of fan motor (AC fan). Check wiring.
P03	P03	—	I/F	Discharge temperature TD1 error	All stop	Discharge temperature (TD1) exceeds 115 °C.	Check outdoor service valves (gas side, liquid side) to confirm full opening. Check outdoor PMVs (PMV1, 2, 4) for clogging. Check resistance characteristics of TD1 sensor. Check for insufficiency in refrigerant quantity. Check for defect in 4-way valve. Check for leakage of SV4 circuit. Check SV4 circuit (wiring or installation error in SV41, SV42 or SV43).
P04	P04	01: Compressor 1 side 02: Compressor 2 side 03: Compressor 3 side	IPDU	Activation of high-pressure SW	All stop	High-pressure SW is activated.	Check connection of high-pressure SW connector. Check for defect in Pd pressure sensor. Check outdoor service valves (gas side, liquid side) to confirm full opening. Check for defect in outdoor fan. Check for defect in outdoor fan motor. Check outdoor PMVs (PMV1, 2) for clogging. Check indoor / outdoor heat exchangers for clogging. Check for short-circuiting of outdoor suction / discharge air flows. Check SV2 circuit for clogging. Check for defect in outdoor P.C. board (I/F). Check for error in indoor fan system (possible cause of air flow reduction). Check opening status of indoor PMV. Check indoor-outdoor communication line for wiring error. Check for faulty operation of check valve in discharge pipe convergent section. Check gas balancing SV4 valve circuit. Check SV5 valve circuit. Check for refrigerant overcharging.

Main remote controller	Check code		Location of detection	Description	System status	Error detection condition(s)	Check items (locations)
	Outdoor 7-segment display						
	Check code	Sub-code					
P05	P05	SMMS (Series 1) 01: Open phase detected 02: Phase sequence error	I/F	Open phase detected, Phase sequence error	All stop	Phase sequence error was detected when the power is turned on. Open phase error was detected when the power is turned on.	Check the phase sequence of outdoor power wiring. Check the outdoor PC board (I/F) error.
		SMMS-i (Series 4) 00:	I/F	Detection of open phase / phase sequence	All stop	Open phase is detected when power is turned on. Inverter DC voltage is too high (overvoltage) or too low (undervoltage).	Check for defect in outdoor P.C. board (I/F).
		01: Compressor 1 side 02: Compressor 2 side 03: Compressor 3 side		Inverter DC voltage (Vdc) error (compressor) MG-CTT error			
P07	P07	01: Compressor 1 side 02: Compressor 2 side 03: Compressor 3 side	IPDU I/F	Heat sink overheating error	All stop	Temperature sensor built into IGBT (TH) is overheated.	Check power supply voltage. Check outdoor fan system error. Check heat sink cooling duct for clogging. Check IGBT and heat sink for thermal performance for faulty installation. (e.g. mounting screws and thermal conductivity) Check for defect in A3-IPDU. (faulty IGBT built-in temperature sensor (TH))
P10	P10	Detected indoor address	Indoor unit	Indoor overflow error	All stop	Float switch operates. Float switch circuit is open-circuited or disconnected at connector.	Check float switch connector. Check operation of drain pump. Check drain pump circuit. Check drain pipe for clogging. Check for defect in indoor P.C. board.
P12	—	—	Indoor unit	Indoor fan motor error	Stop of corresponding unit	Motor speed measurements continuously deviate from target value. Overcurrent protection is activated.	Check connection of fan connector and wiring. Check for defect in fan motor. Check for defect in indoor P.C. board. Check impact of outside air treatment (OA). Check static pressure setting.

MG-CTT: Magnet contactor

Main remote controller	Check code		Location of detection	Description	System status	Error detection condition(s)	Check items (locations)
	Outdoor 7-segment display						
	Check code	Sub-code					
P13	P13	—	I/F	Outdoor liquid backflow detection error	All stop	<p><During cooling operation> When system is in cooling operation, high pressure is detected in follower unit that has been turned off.</p> <p><During heating operation> When system is in heating operation, outdoor PMV 1 or 2 continuously registers opening of 100p or less while under SH control.</p>	<p>Check full-close operation of outdoor PMV (1, 2, 4). Check for defect in Pd or Ps sensor. Check gas balancing circuit (SV2) for clogging. Check balance pipe. Check SV3B circuit for clogging. Check defect in outdoor P.C. board (I/F). Check capillary of oil separator oil return circuit for clogging. Check for leakage of check valve in discharge pipe convergent section.</p>
P15	P15	01: TS condition	I/F	Gas leakdetection (TS1 condition)	All stop	<p>Protective shutdown due to sustained suction temperature at or above judgment criterion for at least 10 minutes is repeated four times or more. <TS error judgment criterion> In cooling operation: 60 °C In heating operation: 40 °C</p>	<p>Check for insufficiency in refrigerant quantity. Check outdoor service valves (gas side, liquid side) to confirm full opening. Check PMVs (PMV1, 2) for clogging. Check resistance characteristics of TS1 sensor. Check for defect in 4-way valve. Check SV4 circuit for leakage</p>
		02: TD condition	I/F	Gas leak detection (TD condition)	All stop	<p>Protective shutdown due to sustained discharge temperature (TD1, TD2 or TD3) at or above 108 °C for at least 10 minutes is repeated four times or more.</p>	<p>Check for insufficiency in refrigerant quantity. Check PMVs (PMV 1, 2) for clogging. Check resistance characteristics of TD1, TD2 and TD3 sensors. Check indoor filter for clogging. Check piping for clogging. Check SV4 circuit (for leakage or coil installation error).</p>
P17	P17	—	I/F	Discharge temperature TD2 error	All stop	Discharge temperature (TD2) exceeds 115 °C.	<p>Check outdoor service valves (gas side, liquid side) to confirm full opening. Check outdoor PMVs (PMV1, 2, 4) for clogging. Check resistance characteristics of TD2 sensor. Check for defect in 4-way valve. Check SV4 circuit for leakage. Check SV4 circuit (for wiring or installation error involving SV41, SV42 and SV43).</p>
P18	P18	—	I/F	Discharge temperature TD3 error	All stop	Discharge temperature (TD3) exceeds 115 °C.	<p>Check outdoor service valves (gas side, liquid side) to confirm full opening. Check outdoor PMVs (PMV1, 2, 4) for clogging. Check resistance characteristics of TD3 sensor. Check for defect in 4-way valve. Check SV43 circuit for leakage. Check SV4 circuit (for wiring or installation error involving SV41, SV42 and SV43).</p>

Main remote controller	Check code		Location of detection	Description	System status	Error detection condition(s)	Check items (locations)
	Outdoor 7-segment display						
	Check code	Sub-code					
P19	P19	Detected outdoor unit No.	I/F	4-way valve reversing error	All stop	Abnormal refrigerating cycle data is collected during heating operation.	Check for defect in main body of 4-way valve. Check for coil defect in 4-way valve and loose connection of its connector. Check resistance characteristics of TS1 and TE1 sensors. Check output voltage characteristics of Pd and Ps pressure sensors. Check for wiring error involving TE1 and TL sensors.
P20	P20	—	I/F	Activation of high-pressure protection	All stop	Pd sensor detects pressure equal to or greater than 3.6 MPa.	Check for defect in Pd pressure sensor. Check service valves (gas side, liquid side) to confirm full opening. Check for defect in outdoor fan. Check for defect in outdoor fan motor. Check outdoor PMVs (PMV1, 2, 4) for clogging. Check indoor / outdoor heat exchangers for clogging. Check for short-circuiting of outdoor suction / discharge air flows. Check SV2 circuit for clogging. Check for defect in outdoor P.C. board (I/F). Check for defect in indoor fan system (possible cause of air flow reduction). Check opening status of indoor PMV. Check indoor-outdoor communication line for wiring error. Check for faulty operation of check valve in discharge pipe convergent section. Check gas balancing SV4 valve circuit. Check SV5 valve circuit. Check for refrigerant overcharging.

Main remote controller		Check code		Location of detection	Description	System status	Error detection condition(s)	Check items (locations)
Outdoor 7-segment display		Check code	Sub-code					
P22	P22			SMMS (Series 1) 08: Out of step 0A: IDC activation 0E: Sync error 0F: Control error 06: Maximum rotation exceeded 04: Rotation difference error 0D: Lock 0C: Fan lock	PDU	Outdoor fan IPDU error	All stop	(Sub code: 08) FAN IPDU position detection circuit Position detection is not performed properly.
		All stop	(Sub code: 0A) FAN IPDU overcurrent protection circuit Overcurrent was detected when the fan started running or during operation.				Check the fan motor. Check the error of IPDU board for fan.	
		All stop	(Sub code: 0E) FAN IPDU position detection circuit Position detection is not performed properly.				Check the fan motor. Check the connector connection for fan motor. Check the error of IPDU board for fan.	
		All stop	(Sub code: 0F) FAN IPDU position detection circuit Position detection is not performed properly.				Check the fan motor. Check the connector connection for fan motor. Check the error of IPDU board for fan.	
		All stop	(Sub code: 06) External factors such as blast Position detection is not performed properly. (Restarted in 6 seconds)				Check the fan motor. Check the error of IPDU board for fan.	
		All stop	(Sub code: 04) External factors such as blast The difference between targeted rotation and actual rotation is 25% or more. (Restarted in 6 seconds)				Check the fan motor. Check the error of IPDU board for fan.	
		All stop	(Sub code: 0D) FAN IPDU position detection circuit Position detection is not performed properly. (No wind)				Check the fan motor. Check the connector connection for fan motor. Check the error of IPDU board for fan.	
		All stop	(Sub code: 0C) External factors such as blast Position detection is not performed properly. (Wind blows) (Restarted in 6 seconds)				Check the fan motor. Check the error of IPDU board for fan.	

Check code		Location of detection	Description	System status	Error detection condition(s)	Check items (locations)	
Main remote controller	Outdoor 7-segment display						
	Check code	Sub-code					
P22	P22	SMMS-i (Series 4) 0*: IGBT circuit 1*: Position detection circuit error 3*: Motor lockup error 4*: Motor current detection C*: TH sensor temperature error D*: TH sensor error E*: Inverter DC voltage error (outdoor fan) Note: Although letters 0 to F appear at locations indicated by " * ", please ignore them.	IPDU	Outdoor fan IPDU error	All stop	(Sub code: 0*) Fan IPDU over current protection circuit Flow of current equal to or greater than the specified value is detected during startup of the fan.	Check fan motor. Check for defect in fan IPDU P.C. board.
					All stop	(Sub code: 1*) Fan IPDU position detection circuit Position detection is not going on normally.	Check fan motor. Check connection of fan motor connector. Check for defect in fan IPDU P.C. board.
					All stop	(Sub code: 3*) Gusty wind, an obstruction, or another external factor Speed estimation is not going on normally.	Check fan motor. Check for defect in fan IPDU P.C. board.
					All stop	(Sub code: 4*) Fan IPDU over current protection circuit Flow of current equal to or greater than the specified value is detected during operation of the fan.	Check fan motor. Check connection of fan motor connector. Check for defect in fan IPDU P.C. board.
					All stop	(Sub code: C*) Higher temperature than the specified value is detected during operation of the fan.	Check fan motor. Check for defect in fan IPDU P.C. board.
					All stop	(Sub code: D*) The resistance value of the sensor is infinite or zero (open or short circuit).	Check for defect in fan IPDU P.C. board.
					All stop	(Sub code: E*) Fan IPDU DC voltage protection circuit The DC voltage higher or lower than the specified value is detected.	Check power voltage of the main power supply. Check for defect in fan IPDU P.C. board. Check connection of fan IPDU P.C. board.
P26	P26	01: Compressor 1 side 02: Compressor 2 side 03: Compressor 3 side	IPDU	G-TR shortcircuit protection error	All stop	Overcurrent is momentarily detected during startup of compressor.	Check connector connection and wiring on A3-IPDU P.C. board. Check for defect in compressor (layer short-circuit). Check for defect in outdoor P.C. board (A3-IPDU).
P29	P29	01: Compressor 1 side 02: Compressor 2 side 03: Compressor 3 side	IPDU	Compressor position detection circuit error	All stop	Position detection is not going on normally.	Check wiring and connector connection. Check for compressor layer short-circuit. Check for defect in A3-IPDU P.C. board.
P31	—	—	Indoor unit	Other indoor error (group follower unit error)	Stop of corresponding unit	There is error in other indoor unit in group, resulting in detection of E07/L07/L03/L08.	Check indoor P.C. board.

Errors detected by TCC-LINK central control device

Check code			Location of detection	Description	System status	Error detection condition(s)	Check items (locations)
Main remote controller	Outdoor 7-segment display						
	Check code	Sub-code					
C05	–		TCC-LINK	TCC-LINK central control device transmission error	Continued operation	Central control device is unable to transmit signal.	Check for defect in central control device. Check for defect in central control communication line. Check termination resistance setting.
C06	–			TCC-LINK central control device reception error	Continued operation	Central control device is unable to receive signal.	Check for defect in central control device. Check for defect in central control communication line. Check termination resistance setting. Check power supply for devices at other end of central control communication line. Check defect in P.C. boards of devices at other end of central control communication line.
C12	–		General-purpose device I/F	Blanket alarm for general-purpose device control interface	Continued operation	Error signal is input to control interface for general-purpose devices.	Check error input.
P30	Differs according to nature of alarm-causing error		TCC-LINK	Group control follower unit error	Continued operation	Error occurs in follower unit under group control. ([P30] is displayed on central control remote controller.)	Check check code of unit that has generated alarm.
	(L20 displayed.)			Duplicated central control address	Continued operation	There is duplication in central control addresses.	Check address settings.

8-5. Sensor characteristics

Indoor unit

▼ Temperature sensor characteristics

Indoor TA sensor

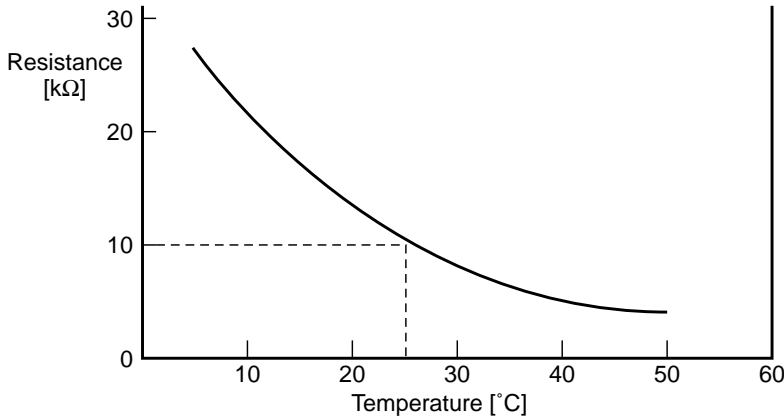

Temperature [°C]	Resistance [kΩ]
0	33.9
5	26.1
10	20.3
15	15.9
20	12.6
25	10.0
30	8.0
35	6.4
40	5.2
45	4.2
50	3.5
55	2.6
60	2.4

Indoor TC1 sensor

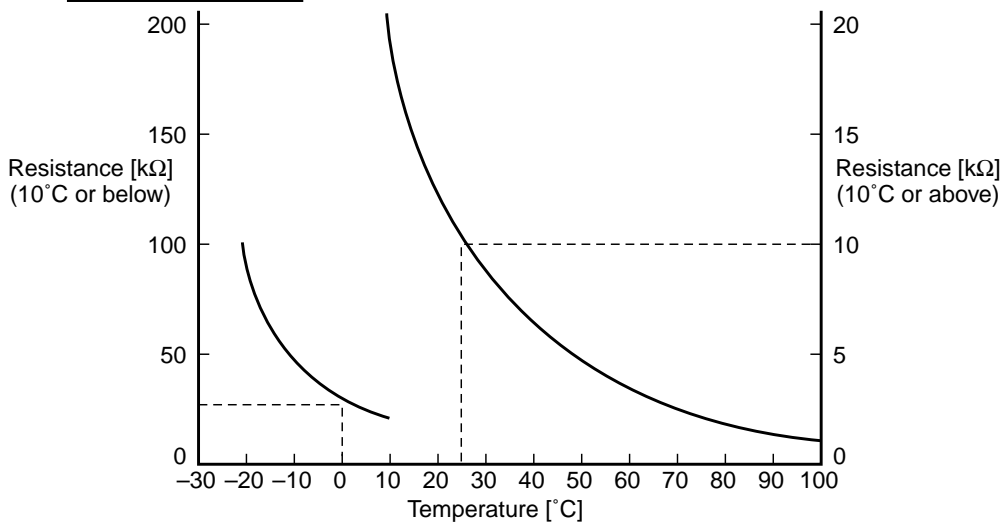

Temperature [°C]	Resistance [kΩ]
-20	99.9
-15	74.1
-10	55.6
-5	42.2
0	32.8
5	25.4
10	19.8
15	15.6
20	12.4
25	10.0
30	8.1
35	6.5
40	5.3
45	4.4
50	3.6
55	3.0
60	2.5
65	2.1
70	1.8
75	1.5
80	1.3
85	1.1
90	1.0
95	0.8
100	0.7

Indoor TC2 and TCJ sensors

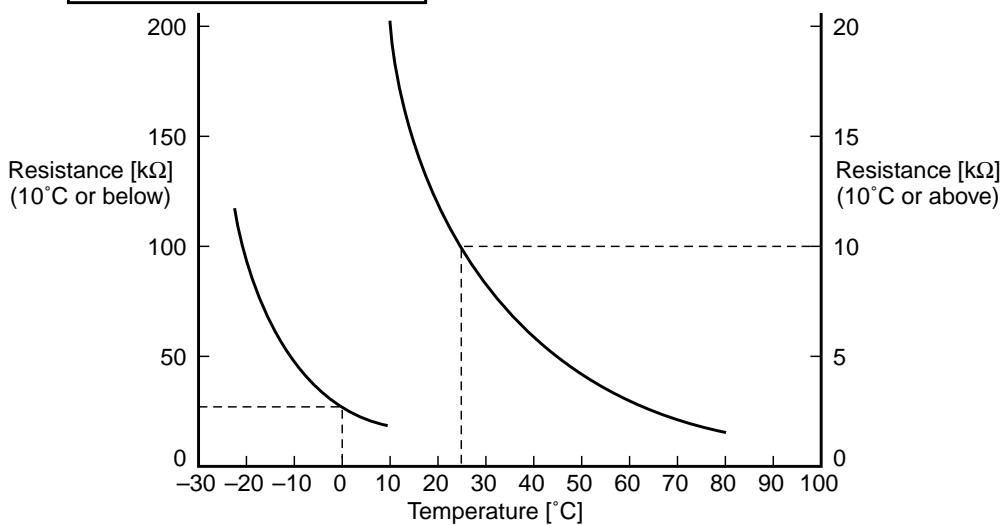

Temperature [°C]	Resistance [kΩ]
-20	115.2
-15	84.2
-10	62.3
-5	46.6
0	35.2
5	26.9
10	20.7
15	16.1
20	12.6
25	10.0
30	8.0
35	6.4
40	5.2
45	4.2
50	3.5
55	2.8
60	2.4
65	2.0
70	1.6
75	1.4
80	1.2

Winding Resistance of Fan Motor

Part name	Checking procedure																
<p>SWF-230-60-2R AP009,AP012,AP015, AP018,AP024,AP027, AP030</p> <p>ICF-280-150-1 AP036,AP048,AP056</p>	<p>Measure the resistance value of each winding by using the tester.</p> <p style="text-align: center;">SWF-230-60-2R</p> <table border="1" style="margin-left: auto; margin-right: auto;"> <thead> <tr> <th>Position</th> <th>Resistance value</th> </tr> </thead> <tbody> <tr> <td>Black – Red</td> <td>$87 \pm 8.7 \ \Omega$</td> </tr> <tr> <td>Black – White</td> <td>$87 \pm 8.7 \ \Omega$</td> </tr> <tr> <td>Red – White</td> <td>$87 \pm 8.7 \ \Omega$</td> </tr> </tbody> </table> <p style="text-align: center;">ICF-280-150-1</p> <table border="1" style="margin-left: auto; margin-right: auto;"> <thead> <tr> <th>Position</th> <th>Resistance value</th> </tr> </thead> <tbody> <tr> <td>Black – Red</td> <td>$32.4 \pm 3.3 \ \Omega$</td> </tr> <tr> <td>Black – White</td> <td>$32.4 \pm 3.3 \ \Omega$</td> </tr> <tr> <td>Red – White</td> <td>$32.4 \pm 3.3 \ \Omega$</td> </tr> </tbody> </table> <p style="text-align: right;">Under 20 °C</p>	Position	Resistance value	Black – Red	$87 \pm 8.7 \ \Omega$	Black – White	$87 \pm 8.7 \ \Omega$	Red – White	$87 \pm 8.7 \ \Omega$	Position	Resistance value	Black – Red	$32.4 \pm 3.3 \ \Omega$	Black – White	$32.4 \pm 3.3 \ \Omega$	Red – White	$32.4 \pm 3.3 \ \Omega$
Position	Resistance value																
Black – Red	$87 \pm 8.7 \ \Omega$																
Black – White	$87 \pm 8.7 \ \Omega$																
Red – White	$87 \pm 8.7 \ \Omega$																
Position	Resistance value																
Black – Red	$32.4 \pm 3.3 \ \Omega$																
Black – White	$32.4 \pm 3.3 \ \Omega$																
Red – White	$32.4 \pm 3.3 \ \Omega$																

Fan motor inside wiring diagram

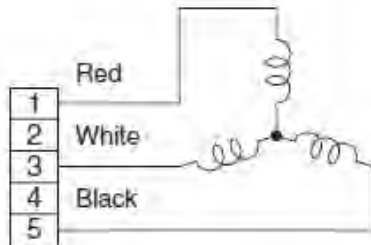

9. DETACHMENTS

No.	Part name	Procedure	Remarks
①	Suction grille	<p style="text-align: center;">CAUTION</p> <p>Be sure to put on the gloves and long-sleeved shirt at disassembling work; otherwise an injury will be caused by a part, etc.</p> <p>1. Detachment</p> <ol style="list-style-type: none"> 1) Stop operation of the air conditioner and then turn off switch of the breaker. 2) Slide the 2 knobs of the suction grille inward and then hang down the suction grille. 3) Remove a strap connecting the panel and the suction grille and then remove the suction grille. <p>2. Attachment</p> <ol style="list-style-type: none"> 1) Hook the suction grille to the panel. 2) Attach strap of the suction grille to the panel as before. 3) Close the suction grille, slide the knobs outward and then fix the panel. 	
②	Electric parts cover	<p>1. Detachment</p> <ol style="list-style-type: none"> 1) Carry out work of item 1. of ①. 2) Remove the fixing screw A which fixes the electric parts cover and loosen the fixing screw B. 3) Pull down the electric parts cover, remove pin of the bell mouth and then slide it to the arrow direction in order to open the claws and the electric parts box cover. <p>2. Attachment</p> <ol style="list-style-type: none"> 1) Close the electric parts cover and slide it, hook claw of the electric parts box, claw of the electric parts box cover and the Dharma doll hole, and then insert pin of the bell mouth into hole of the electric parts box cover. 2) Tighten the fixing screws A and B and then fix the electric parts box cover. 3) Following to work of item 2 of ①, mount the suction grille as before. 	

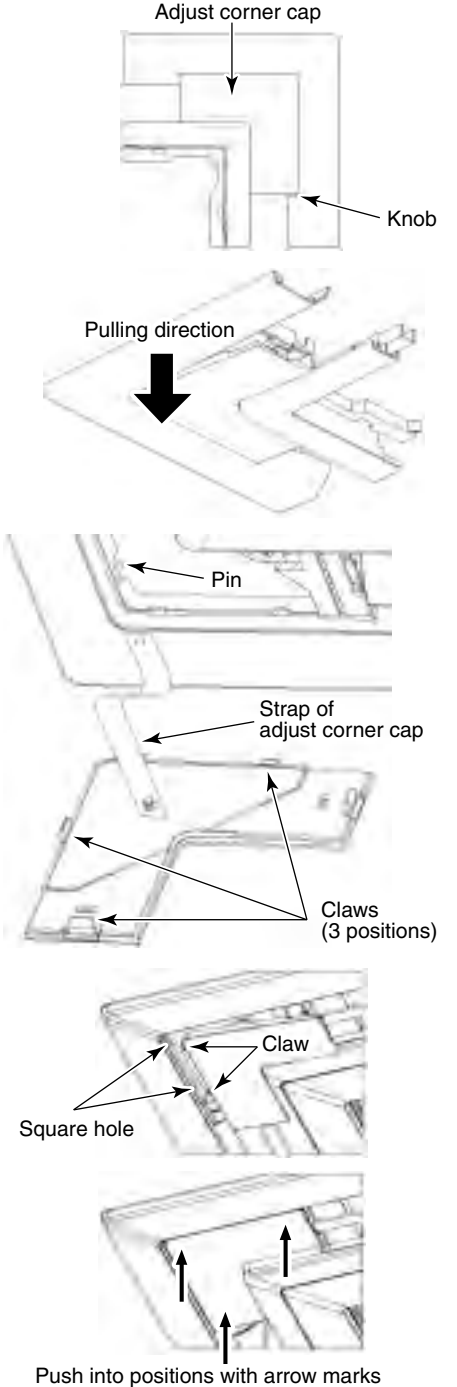
No.	Part name	Procedure	Remarks
②	Electric parts cover (Continued)		
③	Adjust corner cap	<p>1. Detachment</p> <p>1) Pull knob of the adjust corner cap to the arrow direction, remove strap of the adjust corner cap from pin of the panel and then remove all the 4 corners of the cap.</p> <div style="border: 1px solid black; padding: 5px; margin: 10px 0;"> <p>NOTE : The knob is provided to only one side. Be sure to remove the cap of the knob side at first.</p> </div> <p>2. Attachment</p> <p>1) Hook strap of the adjust corner cap securely to pin of the ceiling panel.</p> <p>2) Insert claw of the adjust corner cap into the square hole of the panel. (2 positions)</p> <p>3) Push claws of the adjust corner cap into the positions indicated with arrow marks so that they fit in 3 positions.</p>	

No.	Part name	Procedure	Remarks
④	Ceiling panel	<p>1. Detachment</p> <ol style="list-style-type: none"> 1) Carry out works of item 1 of ② and item 1 of ③. 2) Remove the flap connector (CN510, White, 20P) connected to the control P.C. board and then remove the lead wire from the clamp. <div style="border: 1px solid black; padding: 5px; margin: 10px 0;"> <p>NOTE : Unlock the lock of the housing part and then remove the connector.</p> </div> <ol style="list-style-type: none"> 3) Loosen the panel fixing 4 screws. 4) Slide the panel fixing brackets (4 positions) outward. 5) Push the tentative bracket outward and then remove the ceiling panel. <p>2. Attachment</p> <ol style="list-style-type: none"> 1) Insert the tentative brackets (2 positions) of the ceiling panel into square holes of the indoor unit and then hook the panel tentatively. <div style="border: 1px solid black; padding: 5px; margin: 10px 0;"> <p>NOTE : The ceiling panel has the directional properties against the indoor unit. Direct the louver motor wire to the electric parts box side of the indoor unit.</p> </div> <ol style="list-style-type: none"> 2) Pass the head of the panel fixing screw through hole of the panel fixing bracket and then slide the panel fixing bracket inward. 3) Tighten in the panel fixing screw to fix the ceiling panel. 4) Following to work of item 2 of ③, attach the adjust corner cap as before. 5) Connect the louver connector (CN510, White, 20P) as before and then fix the lead wire with clamp. 6) Following to work of item 2 of ②, mount the electric parts box cover and the suction grille as before. 	

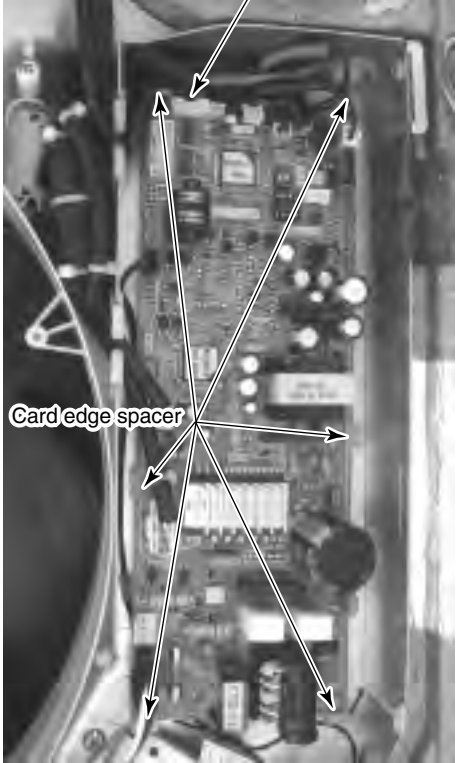
No.	Part name	Procedure	Remarks
⑤	Control P.C. board	<p>1. Detachment</p> <ol style="list-style-type: none"> 1) Carry out work of item 1 of ②. 2) Remove connectors which are connected from the control P.C. board to the other parts and then remove wiring from the clamp. <p>CN510 : Louver motor (20P, White) CN34 : Float switch (3P, Red) CN504 : Drain pump (2P, White) CN100 : TC1 sensor (3P, Brown) CN101 : TC2 sensor (2P, Black) CN102 : TCJ sensor (2P, Red) CN104 : Room temp. Sensor (2P, Yellow) CN333 : Fan motor power supply (5P, White) CN334 : Fan motor position detection (3P, White) CN82 : PMV (6P, Blue)</p> <div style="border: 1px solid black; padding: 5px; margin: 10px 0;"> <p>NOTE : Unlock the lock of the housing part and then remove the connector.</p> </div> <ol style="list-style-type: none"> 3) Unlock the locks of the card edge spacer (6 positions) and then remove the control P.C. board. <p>2. Attachment</p> <ol style="list-style-type: none"> 1) Fix the control P.C. board to the card edge spacer (6 positions) 2) Connect the connector removed in item 1 as before and then fix the wiring with the clamp. 3) Following to work of item 2 of ②, mount the electric parts box cover and the suction grille as before. <hr/> <p style="text-align: center;">CAUTION</p> <p>When exchanging P.C. board, mount the ferrite core attached to the existing earth lead to the earth lead of the new P.C. board.</p> <hr/>	

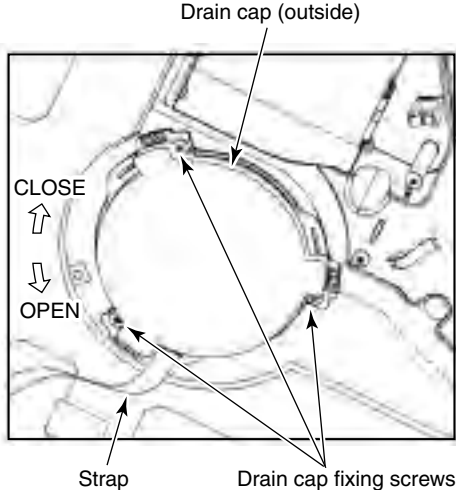
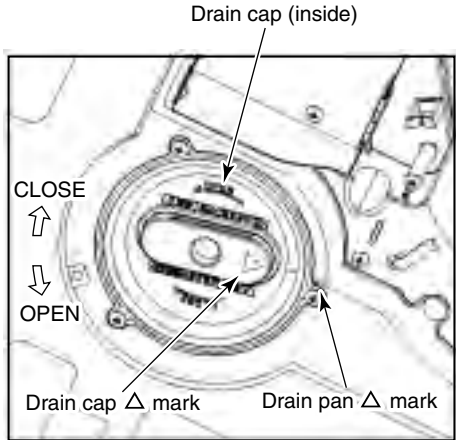
No.	Part name	Procedure	Remarks
⑥	Drain cap	<p>1. Detachment</p> <ol style="list-style-type: none"> 1) Carry out work of item 1 of ①. 2) Loosen screws (3 positions) fixing the drain cap (outside) and then turn the drain cap to the arrow mark direction to remove it. <div style="border: 1px solid black; padding: 5px; margin: 10px 0;"> <p>NOTE : The drain cap is hung down because a strap is attached to it (outside).</p> </div> <ol style="list-style-type: none"> 3) Loosen the cap by turn the drain cap (inside) for approx. 1 turn to OPEN → direction and then drain the drain water accumulated in the drain pan. <div style="border: 1px solid black; padding: 5px; margin: 10px 0;"> <p>NOTE : Be sure to catch drain water using a bucket, etc. when loosening the drain cap. The insulating materials are adhered to the drain cap (outside) and opening part of the drain pan; be careful that they are not come off. If they are come off, stick them as before using double-faces tape, etc.</p> </div> <ol style="list-style-type: none"> 4) Turn the drain cap once again to OPEN → direction to remove it. <p>2. Attachment</p> <ol style="list-style-type: none"> 1) Insert the drain cap (inside), turn it to CLOSE → direction until the position where “Clashed sound” is heard and it cannot be turned more over (Position where △ mark of the drain pan matches with △ mark of the drain cap (inside)) and then fix it. <div style="border: 1px solid black; padding: 5px; margin: 10px 0;"> <p>NOTE : When attaching the drain cap (inside), remove dirt attached to the packing. And tighten in it noting so that the cap is not slantingly set. If attaching the drain cap as dust or dirt is attached or the cap is set slantingly, water leakage is caused.</p> </div> <ol style="list-style-type: none"> 2) Turn the drain cap (outside) to → direction and then attach it using the fixing screw as original. 3) Following to work of item 2 of ① , mount the suction grille as before. 	 

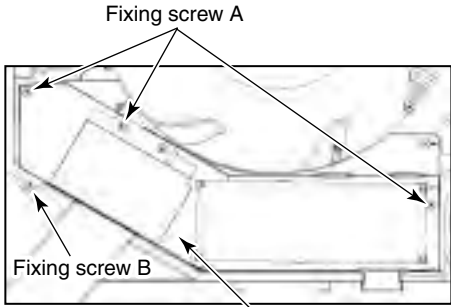
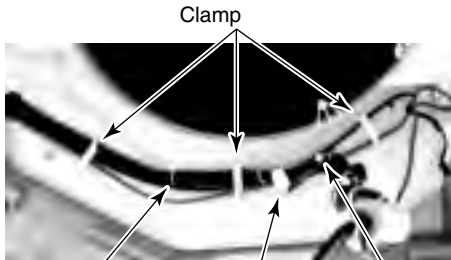
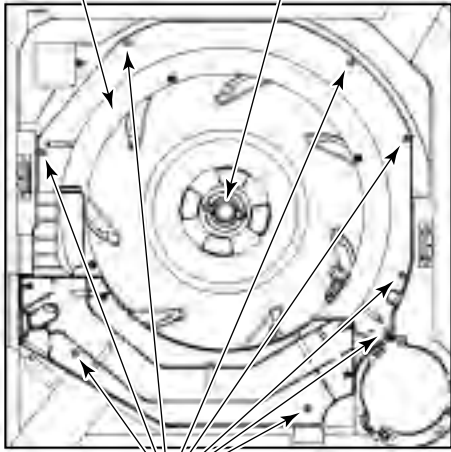
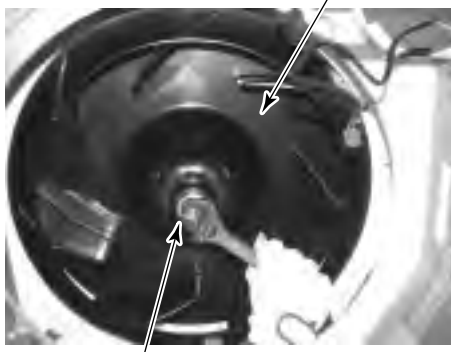
No.	Part name	Procedure	Remarks
⑦	Fan motor	<p>1. Detachment</p> <ol style="list-style-type: none"> 1) Carry out work of item 1 of ②. 2) Remove connectors which are connected from the control P.C. board to the other parts and then remove each wiring from the clamp. CN510 : Louver motor (20P, White) CN34 : Float switch (3P, Red) CN504 : Drain pump (2P, White) CN100 : TC1 sensor (3P, Brown) CN101 : TC2 sensor (2P, Black) CN102 : TCJ sensor (2P, Red) CN104 : Room temp. Sensor (2P, Yellow) CN333 : Fan motor power supply (5P, White) CN334 : Fan motor position detection (3P, White) CN82 : PMV (6P, Blue) <div style="border: 1px solid black; padding: 5px; margin: 10px 0;"> <p>NOTE : Unlock the lock of the housing part and then remove the connector.</p> </div> <ol style="list-style-type: none"> 3) Remove the fixing screws A and B, and then remove the electric parts box. (Fixing screw A: $\varnothing 4 \times 10$, 3 pcs, Fixing screw B: $\varnothing 4 \times 10$, 1 pc.) 4) Remove the fan motor lead, TC sensor and TCJ sensor from clamp of the bell mouth. 5) Remove the fixing screws and then remove the bell mouth. ($\varnothing 4 \times 10$, 8 pcs.) 6) Remove the fixing screws and then remove the nut cap. ($\varnothing 4 \times 10$, 2 pcs.) 7) Remove the fixing nut and then remove the turbo fan. (M8 nut with flange, 1 pc.) 8) Remove the fixing screws and then remove the motor lead holding bracket. ($\varnothing 4 \times 8$, 2 pcs.) 9) Cut the bundling band and then remove it from the clamp. 10) Remove the fixing nut and then remove the fan motor. ($\varnothing 6$ nut, 3 pcs.) <p>2. Attachment</p> <ol style="list-style-type: none"> 1) Fix the parts as before in order of fan motor → motor lead holding bracket → turbo fan → nut cap → bell mouth. <div style="border: 1px solid black; padding: 5px; margin: 10px 0;"> <p>NOTE : Fix the motor lead to the clamp without slack as before using bundling band. When fixing the turbo fan, be sure to match the D-cut of the fan boss with D-cut of the motor shaft. Using a torque wrench, fix the turbo fan and tighten it to $5.4^{+0.5}_{-0.2}$ Nm. Using torque wrench, fix the fan motor (at 3 positions) and tighten it to $4.9^{+0.5}_{-0.2}$ Nm.</p> </div>	 <p>Fixing screw A</p> <p>Fixing screw B</p> <p>Electric parts box</p>  <p>Clamp</p> <p>Fan motor lead TC sensor TCJ sensor</p>  <p>Bell mouth Nut cap</p> <p>Fixing screw</p>  <p>Turbo fan</p> <p>M8 nut with flange</p>

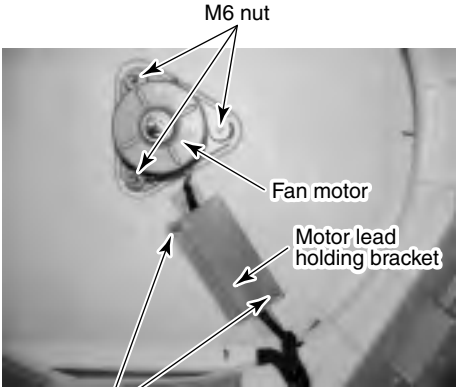
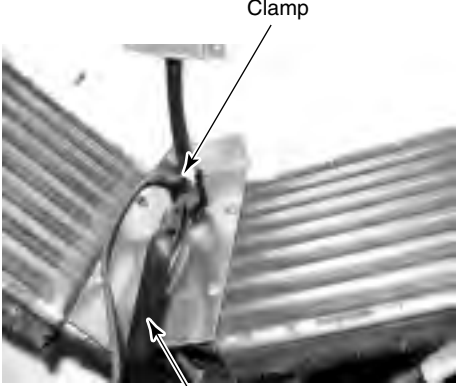
No.	Part name	Procedure	Remarks
⑦	Fan motor (Continued)	<p>2. Attachment</p> <p>2) Fix the fan motor lead, TC sensor and TCJ sensor with the clamp of the bell mouth.</p> <p>3) Mount the electric parts box with the fixing screws A and B. ($\varnothing 4 \times 10$, 3 pcs. $\varnothing 4 \times 10$, 1 pc.)</p> <p>4) Connect the connector removed in item 1 as before and then fix wiring with the clamp.</p> <p>5) Following to work of item 2 of ②, mount the electric parts box cover and the suction grille as before.</p> <hr/> <p style="text-align: center;">CAUTION</p> <hr/> <p>When exchanging the fan motors of the models MMU-AP009 to AP030, take off lead wire from the clamp filter, which is connected to CN334 of the fan motor to be exchanged and then connect the removed lead wire to a new fan motor.</p> <hr/>	 <p>M6 nut</p> <p>Fan motor</p> <p>Motor lead holding bracket</p> <p>Fixing screws ($\varnothing 4 \times 8$)</p>  <p>Clamp</p> <p>Fan motor lead</p>

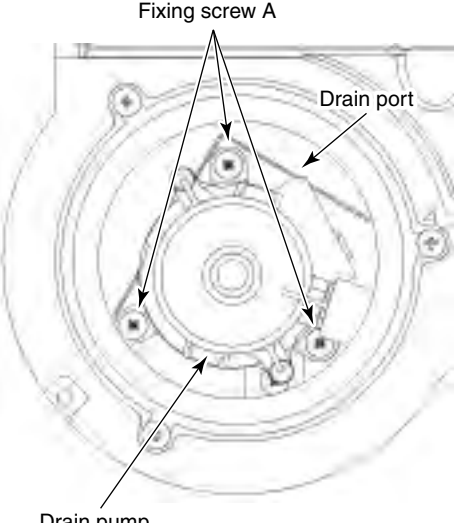
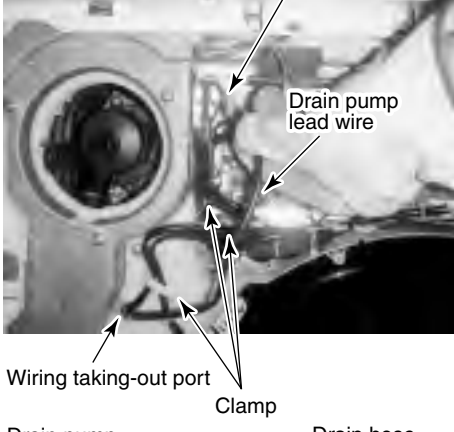
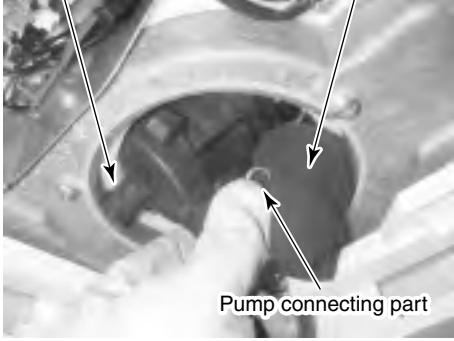
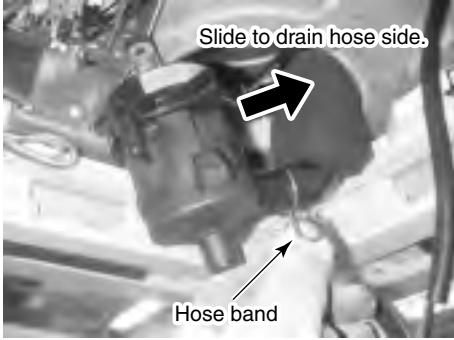
No.	Part name	Procedure	Remarks
⑧	Drain pump	<p>1. Detachment</p> <ol style="list-style-type: none"> 1) Carry out works of item 1 of ② and item 1 of ⑥. 2) Remove the drain pump connector (CN504, White, 2P) connected to the control P.C. board and then remove the lead wire from the clamp. 3) Remove the fixing screws and then remove the drain pump. (Ø4 × 10, 3 pcs.) 4) As shown in the right figure, first pull out the connecting part of the drain pump and the drain hose from the drain port and then take out the drain pump. 5) Set direction of the knob of the hose band downward, slide it from the pump connecting part to the hose side and then remove the drain hose from the drain pump. 6) Pass the connector of the drain pump lead wire through the wiring taking-out port and then take out the drain pump. <p>2. Attachment</p> <ol style="list-style-type: none"> 1) Enter your hand into the drain port and pass the connector of the drain pump lead wire through the wiring taking-out port. 2) Connect the drain hose to the drain pump as before. <div style="border: 1px solid black; padding: 5px; margin: 10px 0;"> <p>NOTE : Insert the drain hose up to the end of the drain pump connecting part, apply band to the white mark position of the hose and then set the band knob upward.</p> </div> <ol style="list-style-type: none"> 3) Return the drain pump to the indoor unit and then mount it as before using the fixing screws. (Ø4 × 10, 3 pcs.) 4) Connect the drain pump connector (CN504, White, 2P) to the control P.C. board and then fix it as before with the clamp. 5) Following to words of item 2 of ⑥ and item 2 of ②, mount the drain cap, the electric parts box cover and the suction grille as before. 	   

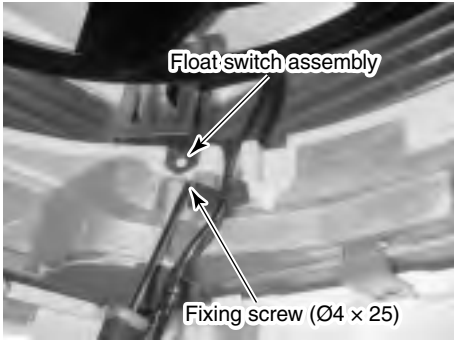
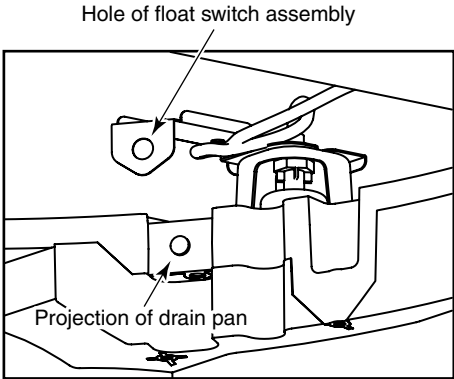
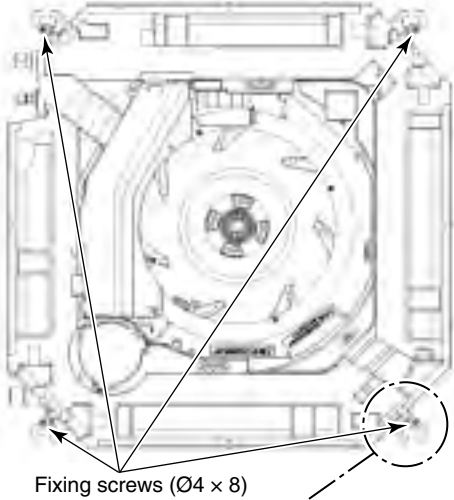
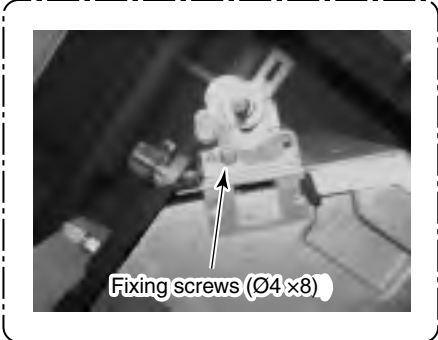
No.	Part name	Procedure	Remarks
⑨	Float switch assembly	<p>1. Detachment</p> <ol style="list-style-type: none"> 1) Carry out works of item 1 of ⑦ and works from 1) to 5). 2) Remove the fixing screw and then remove the float switch assembly. (Ø4 × 25, 1 pc.) <p>2. Attachment</p> <ol style="list-style-type: none"> 1) Mount the float switch assembly as before with the fixing screw. <div data-bbox="402 573 938 698" style="border: 1px solid black; padding: 5px; margin: 10px 0;"> <p>NOTE : When mounting, match hole of the float switch assembly with projection of the drain pan.</p> </div> <ol style="list-style-type: none"> 2) Mount the bell mouth as before. (Ø4 × 10, 8 pcs.) 3) Following to works of item 2 of ⑦ and works from 2) to 5), attach the parts as before. 	 <p>Float switch assembly</p> <p>Fixing screw (Ø4 × 25)</p>  <p>Hole of float switch assembly</p> <p>Projection of drain pan</p>
⑩	Drain pan	<p>1. Detachment</p> <ol style="list-style-type: none"> 1) Carry out works of item 1 of ④, item 1 of ⑥, item 1 of ⑦ and works from 2) to 5). 2) Remove the fixing screws to remove the drain pan. (Ø4 × 8, 4 pcs.) <p>2. Attachment</p> <ol style="list-style-type: none"> 1) Fix parts as before in order of drain cap → drain pan → bell mouth. 2) Following to works of item 2 of ⑦ and works from 2) to 5), attach parts as before. 	 <p>Fixing screws (Ø4 × 8)</p>  <p>Fixing screws (Ø4 × 8)</p>

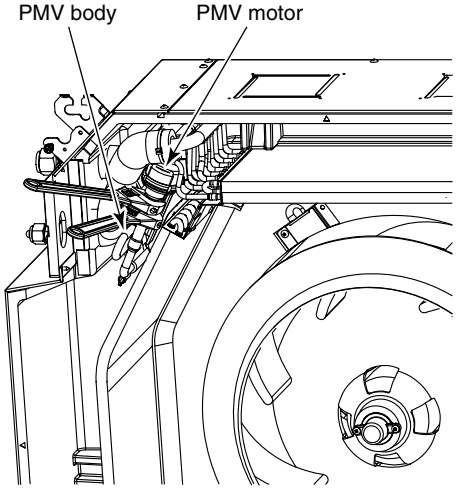
No.	Part name	Procedure	Remarks
⑪	PMV motor	<p>1. Detachment</p> <ol style="list-style-type: none"> 1) Carry out work of item 1 of ⑩ . 2) Remove the relay connector of PMV motor. 3) Peel the butyl rubber adhered to the main unit of the pulse motor valve (PMV) until PMV can be seen and then loosen the nuts fixing PMV motor with double spanner to remove PMV motor. <p>2. Attachment</p> <ol style="list-style-type: none"> 1) Mount PMV motor and relay connector as before. <div style="border: 1px solid black; padding: 5px; margin-top: 10px;"> <p>NOTE : Control the tightening torque for the PMV body and PMV motor to $7.84 \pm 0.98\text{Nm}$.</p> </div>	

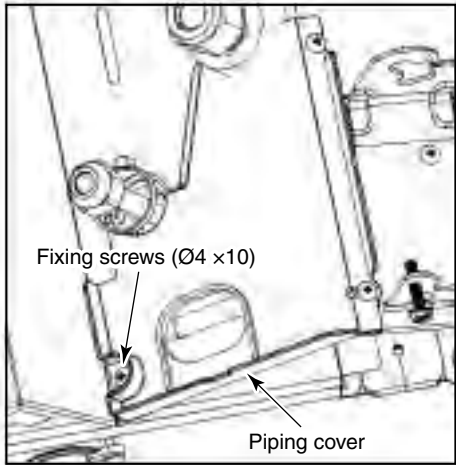
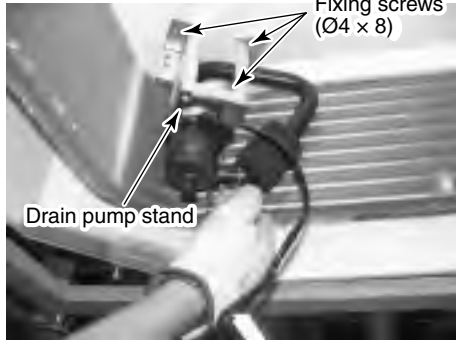
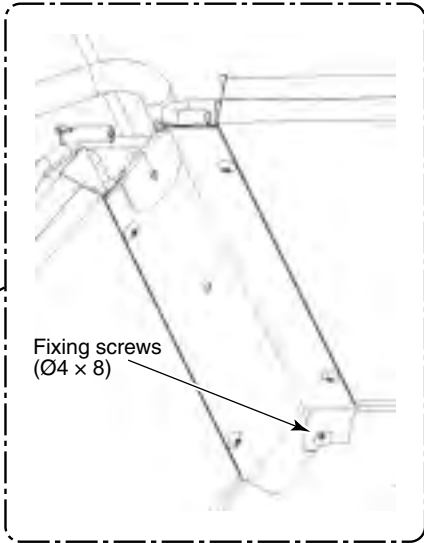
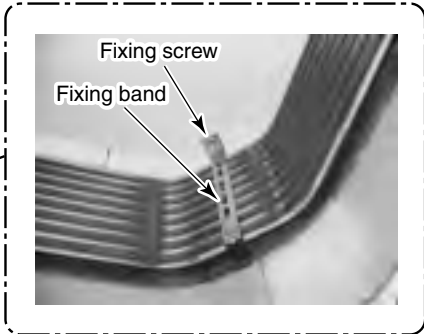
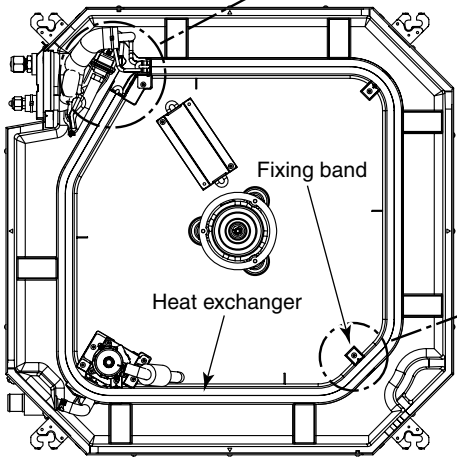
No.	Part name	Procedure	Remarks
⑫	Heat exchanger	<p>1. Detachment</p> <ol style="list-style-type: none"> 1) Recover the refrigerant gas. 2) Carry out work of item 1 of ⑩. 3) Remove refrigerant pipe at indoor unit side. 4) Remove the fixing screws and then remove the piping cover. (Ø4 ×10, 3 pcs.) 5) Remove the drain hose from the drain pump and remove the fixing screws to remove the drain pump stand. (Ø4 ×8, 3 pcs.) 6) While pushing the heat exchanger, remove the fixing band, fixing screws and the heat exchanger. (Ø4 ×8, 3 pcs.) <p>2. Attachment</p> <ol style="list-style-type: none"> 1) Mount the heat exchanger with the fixing band and the fixing screws. (Ø4 ×8, 3 pcs.) 2) Fix the parts as before in order of drain pump stand → piping cover. 3) Connect the refrigerant pipe as before and then apply vacuuming. 4) Following to work of item 2 of ⑩, attach the parts as before. 	 <p>Fixing screws (Ø4 ×10)</p> <p>Piping cover</p>  <p>Fixing screws (Ø4 ×8)</p> <p>Drain pump stand</p>  <p>Fixing screws (Ø4 ×8)</p>  <p>Fixing screw</p> <p>Fixing band</p>  <p>Fixing band</p> <p>Heat exchanger</p>

10. P.C. BOARD EXCHANGE PROCEDURES

10-1. Exchange of P.C. Board for Indoor Service

Part code	Models	P.C. board
431-6V-379	MMU-AP *** 4HP* series	MCC-1570

CAUTION

<Model Name: MMU-AP *** 4HP* >

For the above models, set the CODE No. to “ LE ” and the setting data 0000 (initial) to “0001”

<Note: when replacing the P.C. board for indoor unit servicing>

The nonvolatile memory (hereafter called EEPROM, IC503) on the indoor unit P.C. board before replacement includes the model specific type information and capacity codes as the factory-set value and the important setting data which have been automatically or manually set when the indoor unit is installed, such as system/indoor/group addresses, high ceiling select setting, etc. When replacing the P.C. board for indoor unit servicing, follow the procedures below.

After replacement completes, confirm whether the settings are correct by checking the indoor unit No., Group header unit/follower unit settings and perform the cooling cycle confirmation through the trial operation.

<Replacement procedures>

Case 1

Before replacement, the indoor unit can be turned on and the setting data can be read out by wired remote controller operation.

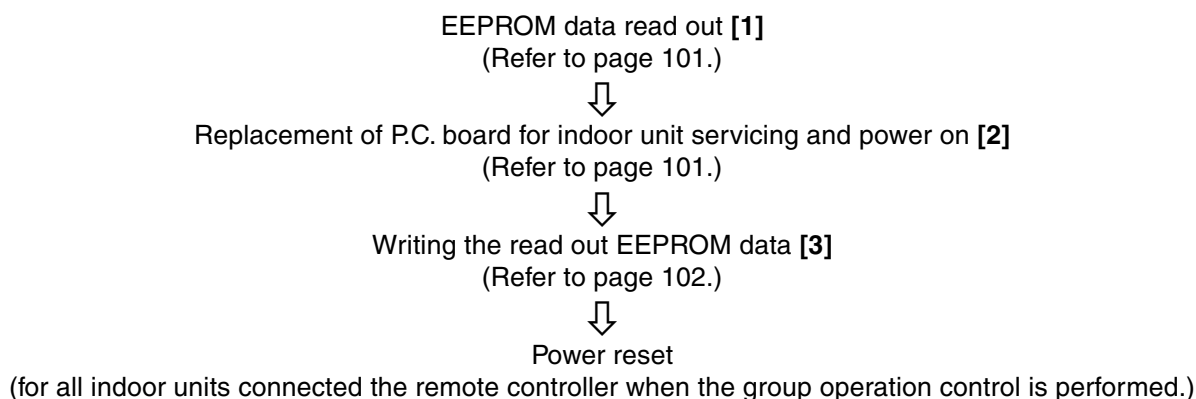

Case 2

The EEPROM before replacement is defective and the setting data cannot be read out.

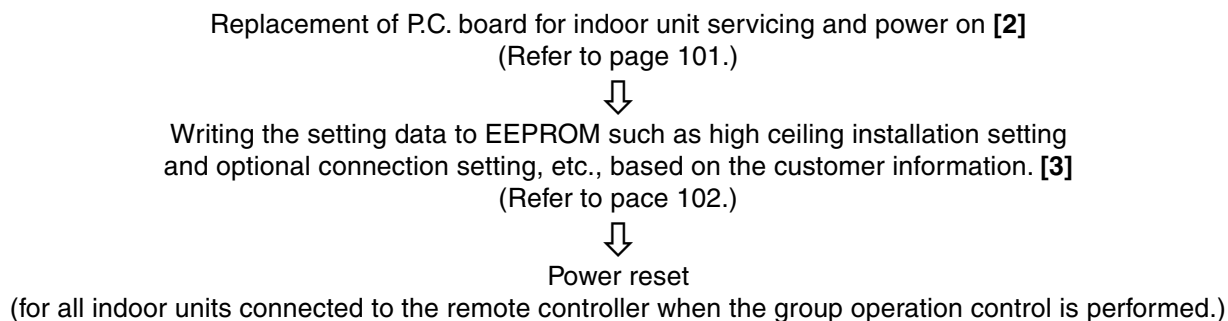

[1] Setting data read out from EEPROM

The setting data modified on the site, other than factory-set value, stored in the EEPROM shall be read out.

Step 1 Push SET , CL and TEST buttons on the remote controller simultaneously for more than 4 seconds.

* When the group operation control is performed, the unit No. displayed for the first time is the header unit No. At this time, the CODE No. (DN) shows “/0”. Also, the fan of the indoor unit selected starts its operation and the swing operation also starts if it has the louvers.

Step 2 Every time when the UNIT LOUVER button is pushed, the indoor unit No. under the group control is displayed in order. Specify the indoor unit No. to be replaced.

1. **Change the CODE No. (DN) from /0 to 0/ by pushing DOWN / UP buttons for the temperature setting. (This is the setting for the filter sign lighting time.)**

At this time, be sure to write down the setting data displayed.

2. Change the CODE No. (DN) by pushing DOWN / UP buttons for the temperature setting. Similarly, be sure to write down the setting data displayed.

3. Repeat the step 2-2 to set the other settings in the same way and write down the setting data as shown in the table 1 (example) on page 104.

• The CODE No. (DN) are ranged from “0/” to “FF”. The CODE No. (DN) may skip.

Step 3 After writing down all setting data, push TEST button to return to the normal stop status. (It takes approx. 1 min until the remote controller operation is available again.)

CODE No. required at least

DN	Contents
10	Type
11	Indoor unit capacity
12	System address
13	Indoor unit address
14	Group address

1. The CODE No. for the Indoor unit type and Indoor unit capacity are required to set the rotation number setting of the fan.
2. If the system/indoor/group addresses are different from those before replacement, the auto-address setting mode starts and the manual resetting may be required again. (When the multiple units group operation including twin system)

[2] P.C. Board for indoor unit servicing replacement procedures

Step 1 Replace the P.C. board for indoor unit servicing.

At this time, perform the same setting of the jumper wire (J01) setting (cut), switch SW501 (short-circuit) connector CN34 as the setting of the P.C. board before replacement.

Step 2 It is necessary to set indoor unit to be exchanged: Remote controller = 1 : 1

Based upon the system configuration, turn on power of the indoor unit with one of the following items.

- 1) Single (Individual) operation. Turn on power of the indoor units and proceed to [3].
- 2) Group operation
 - A) In case that power of the exchanged indoor unit only can be turned on
Turn on power of the exchanger indoor unit only and proceed to [3].
 - B) In case that power of the indoor units cannot be turned on individually (**Case 1**)
 - a) Remove temporarily the group wire connected to the terminal blocks A and B of the exchanged indoor unit.
 - b) After connecting the remote controller wire only to the removed terminal block, turn on power of the indoor units and proceed to [3].

* When the above methods cannot be used, follow to the two cases below.
 - C) In case that power of the indoor units cannot be turned in individually (**Case 2**)
 - a) Remove all CN41 connectors of the indoor units in the same group except those of the exchanged indoor unit.
 - b) Turn on power of the indoor units and proceed to [3].

* After [3] operation has finished, be sure to return the temporarily removed group wire or CN41 connector to the original connection.

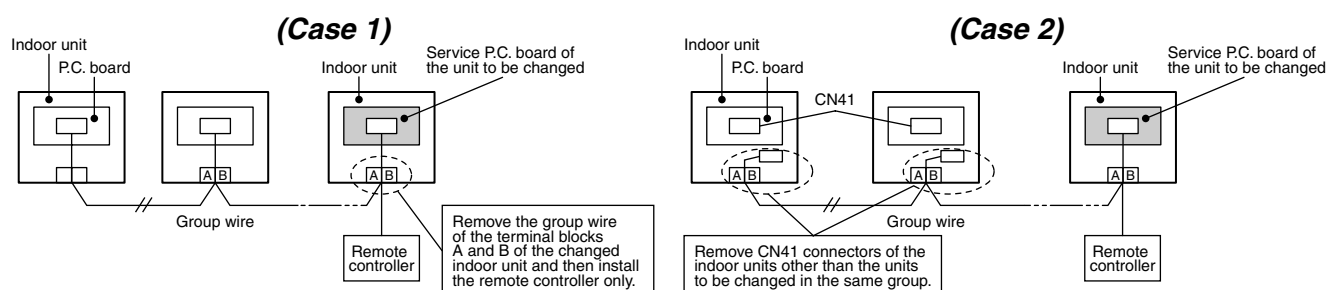

[3] Wiring the setting data to EEPROM

The settings stored in the EEPROM of the P.C. board for indoor unit servicing are the factory-set values.

- Step 1** Push , and buttons on the remote controller simultaneously for more than 4 seconds. **1**
- * In the group control operation, the unit No. displayed for the first time is the header unit No.
(*ALL* is displayed in the Unit No. box.)
- At this time, the CODE No. (DN) shows “/0”. Also, the fan of the indoor unit selected starts its operation and the swing operation starts if it has the louvers.
- Step 2** Every time when the button is pushed, the indoor unit Nos. in the group control operation are displayed in order. **2** (The settings stored in the EEPROM of the P.C. board for indoor unit servicing are the factory-set values.) Specify the indoor unit No. with its P.C. board replaced to the P.C. board for indoor unit servicing.

<Fig. 1 RBC-AMT32E>

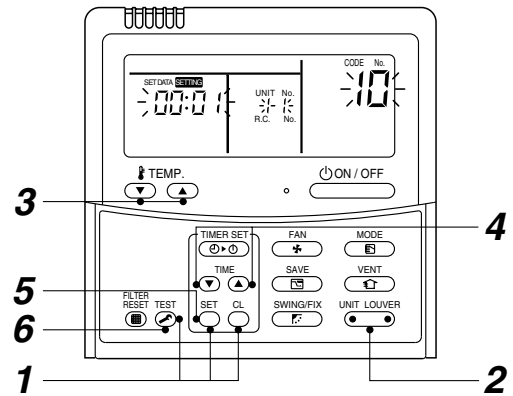

- Step 3** Select the CODE No. (DN) can be selected by pushing the button for the temperature setting. **3**

- Set the indoor unit type and capacity.

The factory-set values shall be written to the EEPROM by changing the type and capacity.

 1. Set the CODE No. (DN) to “/0”. (without change)
 2. Select the type by pushing buttons for the timer setting. **4** (For example, 4-way Cassette Type in set to “0001”. Refer to CODE No. [10] on page 122.)
 3. Push button. (The operation completes if the setting data is displayed.) **5**
 4. Change the CODE No. (DN) to “//” by pushing buttons for the temperature setting. **3**
 5. Select the capacity by pushing buttons for the timer setting. **4** (For example, 027 Type is set to “0012”. Refer to CODE No. [11] on page 104.)
 6. Push button. (The setting completes if the setting data are displayed.) **5**

<Fig. 2 RBC-AMS41E>

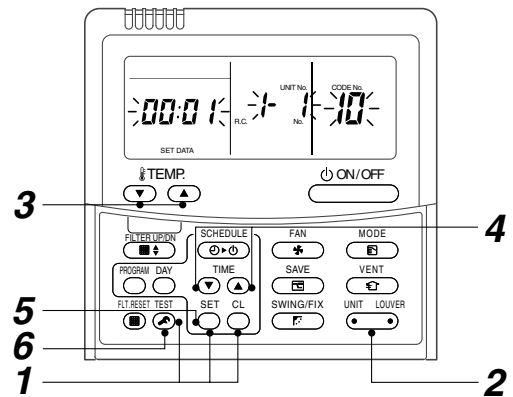

Setting 4-way Cassette indoor unit model only

7. Using the set temperature buttons, set “LE” to the CODE No. (DN).
8. Using the timer time buttons, set the dat. (0001)
9. Push button (The setting completes if the setting data are displayed.)

CAUTION

Be sure to set the jumper wire since the motor protection level setting selection is preformed on it.

If the plug short-circuit is attached on the P.C. board before replacement, attach it on the P.C. board replaced.

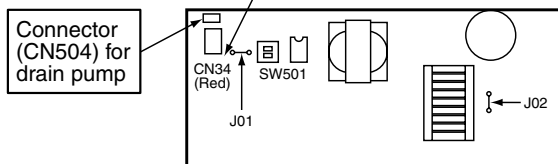

* Set J02 as follows depending on the capacity class.

	Jumper wire (J02)
AP009 to AP030 type	None
AP036 to AP056 type	Required (Factory setting)

10. Push the button to return to the normal stop status
(It takes approx. 1 min until the remote control operation is available again.)

- Step 4** Write the on-site setting data to the EEPROM such as address setting, etc. Perform the steps 1 and 2 above again.

- Step 5** Change the CODE No. (DN) to “/1” by pushing buttons for the temperature setting. (This is the setting for the filter sign lighting time.)

Step 6 Check the setting data displayed at this time with the setting data down in [1] (on page 104).

1. If the setting data is different, modify the setting data by pushing \blacktriangledown / \blacktriangle buttons for the timer setting to the data put down in [1]. The operation completes if the setting data is displayed.
2. If the data is the same, proceed to next step.

Step 7 Change the CODE No. (DN) by pushing \blacktriangledown / \blacktriangle buttons for the temperature setting.

As described above, check the setting data and modify to the data put down in [1].

Step 8 Repeat the steps 6 and 7.

Step 9 After the setting completes, push TEST button to return to the normal stop status. **6**

In a group operation, turn off the power supply once, return the group wires between indoor units and CN41 connectors as before, and then turn on power of all the indoor unit.

(It takes approx. 1 min until the remote controller operation is available again.)

- The CODE No. (DN) are ranged from "01" to "FF". The CODE No. (DN) is not limited to be serial No. Even after modifying the data wrongly and pushing SET button, it is possible to return to the data before modification by pushing CL button if the CODE No. (DN) is not changed.

<Fig.3 EEPROM layout diagram>

The EEPROM (IC503) is attached to the IC socket.

When detaching the EEPROM, use a tweezers, etc.

Be sure to attach the EEPROM by fitting its direction as shown in the figure.

* Do not bend the IC lead when replacing.

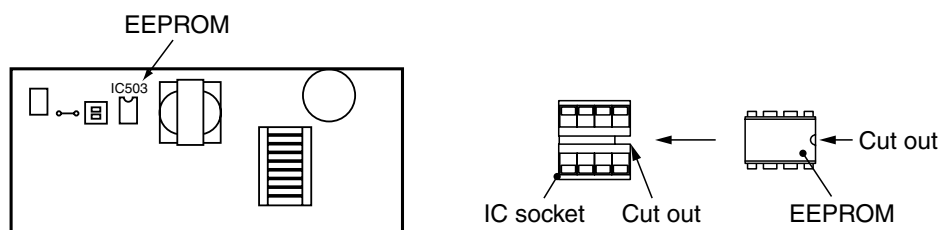

<Fig. 3>

<Make a note of the setup contents. (CODE No. (DN) list (Example))>

DN	Item	Setting data	Factory-set value
01	Filter sign lighting time		Depending on Type
02	Filter pollution leve		0000: standard
03	Central control address		0099: Not determined
06	Heating suction temperature shift		0002: +2°C (flooring installation type: 0)
0d	Existence of automatic COOL/HEAT mode		0001: No auto mode cooling/heating
0F	Cooling only		0000: Heat pump
10	Type		Depending on model type
11	Indoor unit capacity		Depending on capacity type
12	System address		0099: Not determined
13	Indoor unit address		0099: Not determined
14	Group address		0099: Not determined
19	Louver type (wind direction adjustment)		Depending on Type.
1E	Temperature range of cooling/heating automatic SW control point		0003: 3 deg (Ts ± 1.5)
28	Power failure automatic recovery		0000: None
2A	Option/Abnormal input (CN70) SW		0002: Humidifier
31	Ventilation fan (standalone)		0000: Not available
32	Sensor SW (Selection of static pressure)		0000: Body sensor
5d	High ceiling SW		0000: Standard
60	Timer setting (wired remote controller)		0000: Available
F0	Swing mode		0001: Standard
F1	Louver fixing position (Flap No. 1)		0000: Not fixed
F2	Louver fixing position (Flap No. 2)		0000: Not fixed
F3	Louver fixing position (Flap No. 3)		0000: Not fixed
F4	Louver fixing position (Flap No. 4)		0000: Not fixed

Type
CODE No. [10]

Setup data	Type	Model abb. name
0000	1-way Cassette	MMU-AP***SH
0001 *1, *2	4-way Cassette	MMU-AP***4HP*
0002	2-way Cassette	MMU-AP***WH
0003	1-way Cassette (Compact type)	MMU-AP***YH
0004	Concealed Duct Standard	MMD-AP***BH
0005	Slim Duct	MMD-AP***SPH MMD-AP***SH
0006	Concealed Duct High Static Pressure	MMD-AP***H
0007	Ceiling	MMC-AP***H
0008	High Wall	MMK-AP***H
0009	—	—
0010	Floor Standing Cabinet	MML-AP***H
0011	Floor Standing Concealed	MML-AP***BH
0012	—	—
0013	Floor Standing (Below 6HP)	MMF-AP***H
0014	Compact 4-way Cassette	MMU-AP***MH

Indoor unit capacity
CODE No. [11]

Setup data	Model	Setup data	Model
0000*	Invalid	0016	—
0001	007 type	0017	048 type
0002	—	0018	056 type
0003	009 type	0019	—
0004	—	0020	—
0005	012 type	0021	072 type
0006	—	0022	—
0007	015 type	0023	096 type
0008	—	0024	—
0009	018 type	0025	—
0010	—	0026	—
0011	024 type	0027	—
0012	027 type	0028	—
0013	030 type	~	—
0014	—	0034	—
0015	036 type		

*1 The initial setup value of EEPROM installed on the service P.C. board

*2 <Model Name: **MMU-AP *** 4HP ***>

For the above models, set CODE No. to “**LE**” and the setting data 0000 (initial) to “0001”.

11. EXPLODED VIEWS AND PARTS LIST

11-1. MMU-AP0094HP1-E, AP0124HP1-E, AP0154HP1-E, AP0184HP1-E, AP0244HP1-E

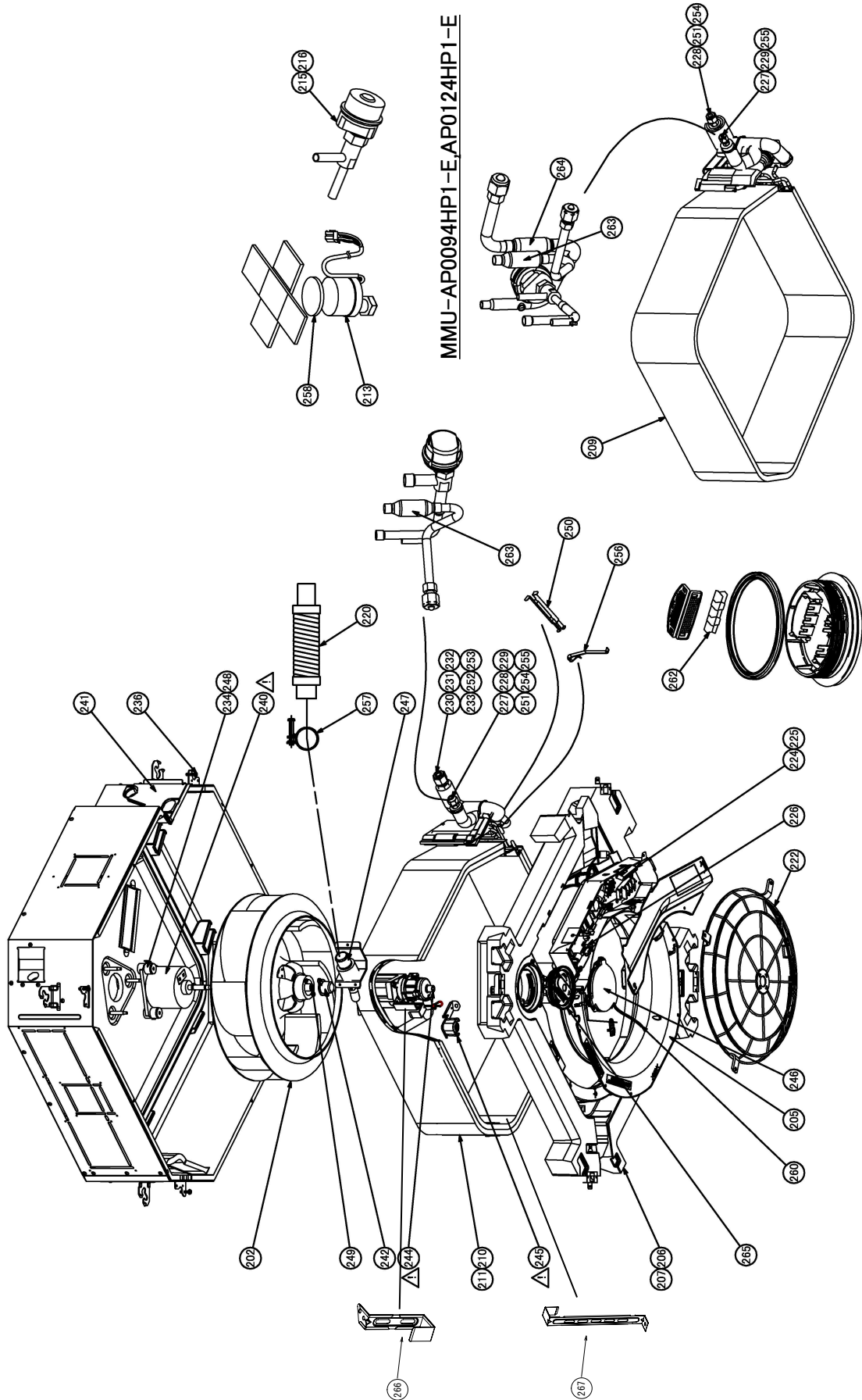

Location No.	Part No.	Description	MMU-AP				
			0094HP1-E	0124HP1-E	0154HP1-E	0184HP1-E	0244HP1-E
202	43T20335	FAN,ASSY TURB	1	1	1	1	1
205	43T22322	BELL MOUTH	1	1	1	1	1
206	43T72320	PAN ASSY, DRAIN	-	-	1	1	1
207	43T72321	PAN ASSY, DRAIN	1	1	-	-	-
209	43T44497	REFRIGERATION CYCLE ASSY	1	1	-	-	-
210	43T44498	REFRIGERATION CYCLE ASSY	-	-	1	1	-
211	43T44499	REFRIGERATION CYCLE ASSY	-	-	-	-	1
213	43T46416	MOTOR, PMV	1	1	1	1	1
215	43T46413	VALVE, PMV	1	1	-	-	-
216	43T46414	PMV	-	-	1	1	1
220	43T70326	HOSE, DRAIN	1	1	1	1	1
222	43T19357	GUARD,FAN	1	1	1	1	1
224	43T63348	CLAMP, DOWN	1	1	1	1	1
225	43T63349	CLAMP, UP	1	1	1	1	1
226	43T63347	CLAMP, WIRE	4	4	4	4	4
227	43T97311	NUT, FLARE, 1/4 IN	1	1	1	1	-
228	43T82318	SOCKET	1	1	-	-	1
229	43T82319	SOCKET	1	1	1	1	-
230	43T97317	NUT, FLARE, 1/2 IN	-	-	1	1	-
231	43T97314	NUT, FLARE, 5/8 IN	-	-	-	-	1
232	43T82320	SOCKET	-	-	1	1	-
233	43T82321	SOCKET	-	-	-	-	1
234	43T11323	RUBBER,CUSHION	3	3	3	3	3
236	43T97315	SCREW, FIX PANEL	4	4	4	4	4
240	43T21441	MOTOR,FAN	1	1	1	1	1
241	43T04318	COVER ASSY	1	1	1	1	1
242	43T39353	CAP,NUT	1	1	1	1	1
244	43T77301	PUMP ASSY	1	1	1	1	1
245	43T51314	SWITCH ASSY, FLOAT	1	1	1	1	1
246	43T79319	LID ASSY, OUTSIDE	1	1	1	1	1
247	43T71303	SOCKET, ASSY DRAIN	1	1	1	1	1
248	43T97310	WASHER	3	3	3	3	3
249	43T97001	NUT	1	1	1	1	1
250	43T19321	FIX-P-SENSOR	1	1	1	1	1
251	43T47332	BONNET, 9.52 DIA	1	1	-	-	1
252	43T47333	BONNET, 12.70 DIA	-	-	1	1	-
253	43T47334	BONNET, 15.88 DIA	-	-	-	-	1
254	43T97312	NUT, FLARE, 3/8 IN	1	1	-	-	1
255	43T47331	BONNET, 6.35 DIA	1	1	1	1	-
256	43T19333	HOLDER, SENSOR	2	2	2	2	2
257	43T83311	BAND, HOSE	1	1	1	1	1
258	43T46417	SHEET, PMV	1	1	1	1	1
260	43T83312	STRING	1	1	1	1	1
262	43T79318	GLASS	1	1	1	1	1
263	43T47386	STRAINER	1	1	1	1	1
264	43T47387	STRAINER	1	1	-	-	-
265	43T79317	LID ASSY, INSIDE	1	1	1	1	1
266	43T39405	BAND-FIX-EVA	2	2	2	2	2
267	43T39407	BAND-FIX-EVA	1	1	1	1	1

11-2. MMU-AP0274HP1-E, AP0304HP1-E, AP0364HP1-E, AP0484HP1-E, AP0564HP1-E

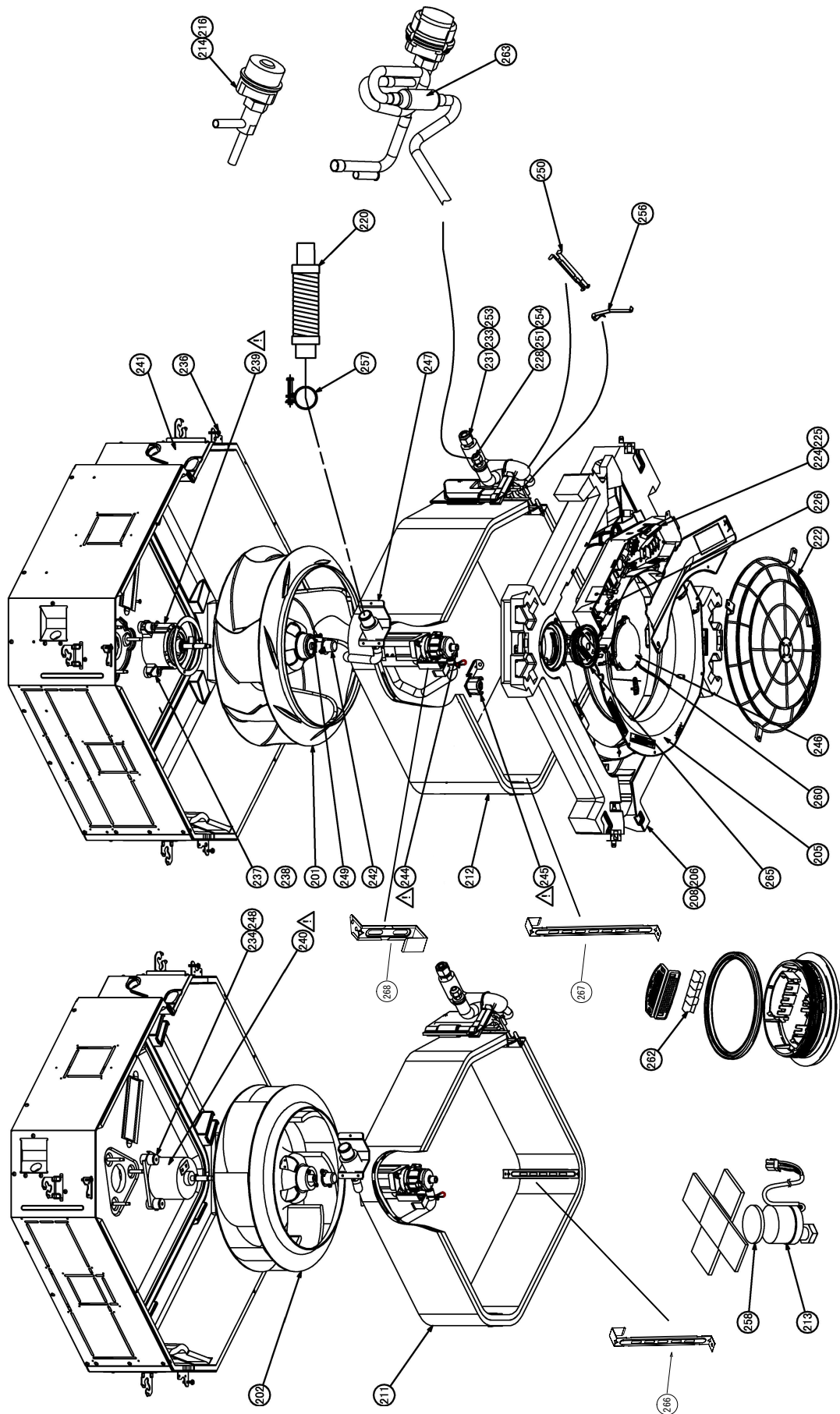

Location No.	Part No.	Description	MMU-AP				
			0274HP1-E	0304HP1-E	0364HP1-E	0484HP1-E	0564HP1-E
201	43T20334	FAN,ASSY TURB	-	-	1	1	1
202	43T20335	FAN,ASSY TURB	1	1	-	-	-
205	43T22322	BELL MOUTH	1	1	1	1	1
206	43T72320	PAN ASSY, DRAIN	1	1	-	-	-
208	43T72322	PAN ASSY, DRAIN	-	-	1	1	1
211	43T44499	REFRIGERATION CYCLE ASSY	1	1	-	-	-
212	43T44500	REFRIGERATION CYCLE ASSY	-	-	1	1	1
213	43T46416	MOTOR, PMV	1	1	1	1	1
214	43T46415	VALVE, PMV	-	-	1	1	1
216	43T46414	PMV	1	1	-	-	-
220	43T70326	HOSE, DRAIN	1	1	1	1	1
222	43T19357	GUARD,FAN	1	1	1	1	1
224	43T63348	CLAMP, DOWN	1	1	1	1	1
225	43T63349	CLAMP, UP	1	1	1	1	1
226	43T63347	CLAMP, WIRE	4	4	4	4	4
228	43T82318	SOCKET	1	1	1	1	1
231	43T97314	NUT, FLARE, 5/8 IN	1	1	1	1	1
233	43T82321	SOCKET	1	1	1	1	1
234	43T11323	RUBBER,CUSHION	3	3	-	-	-
235	43T39352	PLATE, WIND	-	-	4	4	4
236	43T97315	SCREW, FIX PANEL	4	4	4	4	4
234	43T11324	RUBBER,CUSHION	-	-	3	3	3
238	43T97316	WASHER	-	-	1	1	1
239	43T21439	MOTOR, FAN	-	-	1	1	1
240	43T21441	MOTOR,FAN	1	1	-	-	-
241	43T04318	COVER ASSY	1	1	1	1	1
242	43T39353	CAP,NUT	1	1	1	1	1
244	43T77301	PUMP ASSY	1	1	1	1	1
245	43T51314	SWITCH ASSY, FLOAT	1	1	1	1	1
246	43T79319	LID ASSY, OUTSIDE	1	1	1	1	1
247	43T71303	SOCKET, ASSY DRAIN	1	1	1	1	1
248	43T97310	WASHER	3	3	-	-	-
249	43T97001	NUT	1	1	1	1	1
250	43T19321	FIX-P-SENSOR	1	1	1	1	1
251	43T47332	BONNET, 9.52 DIA	1	1	1	1	1
253	43T47334	BONNET; 15.88 DIA	1	1	1	1	1
254	43T97312	NUT, FLARE, 3/8 IN	1	1	1	1	1
256	43T19333	HOLDER, SENSOR	2	2	2	2	2
257	43T83311	BAND, HOSE	1	1	1	1	1
258	43T46417	SHEET, PMV	1	1	1	1	1
260	43T83312	STRING	1	1	1	1	1
262	43T79318	GLASS	1	1	1	1	1
263	43T47386	STRAINER	1	1	1	1	1
265	43T79317	LID ASSY, INSIDE	1	1	1	1	1
266	43T39405	BAND-FIX-EVA	2	2			
267	43T39406	BAND-FIX-EVA			2	2	2
268	43T39407	BAND-FIX-EVA	1	1	1	1	1

Electric parts

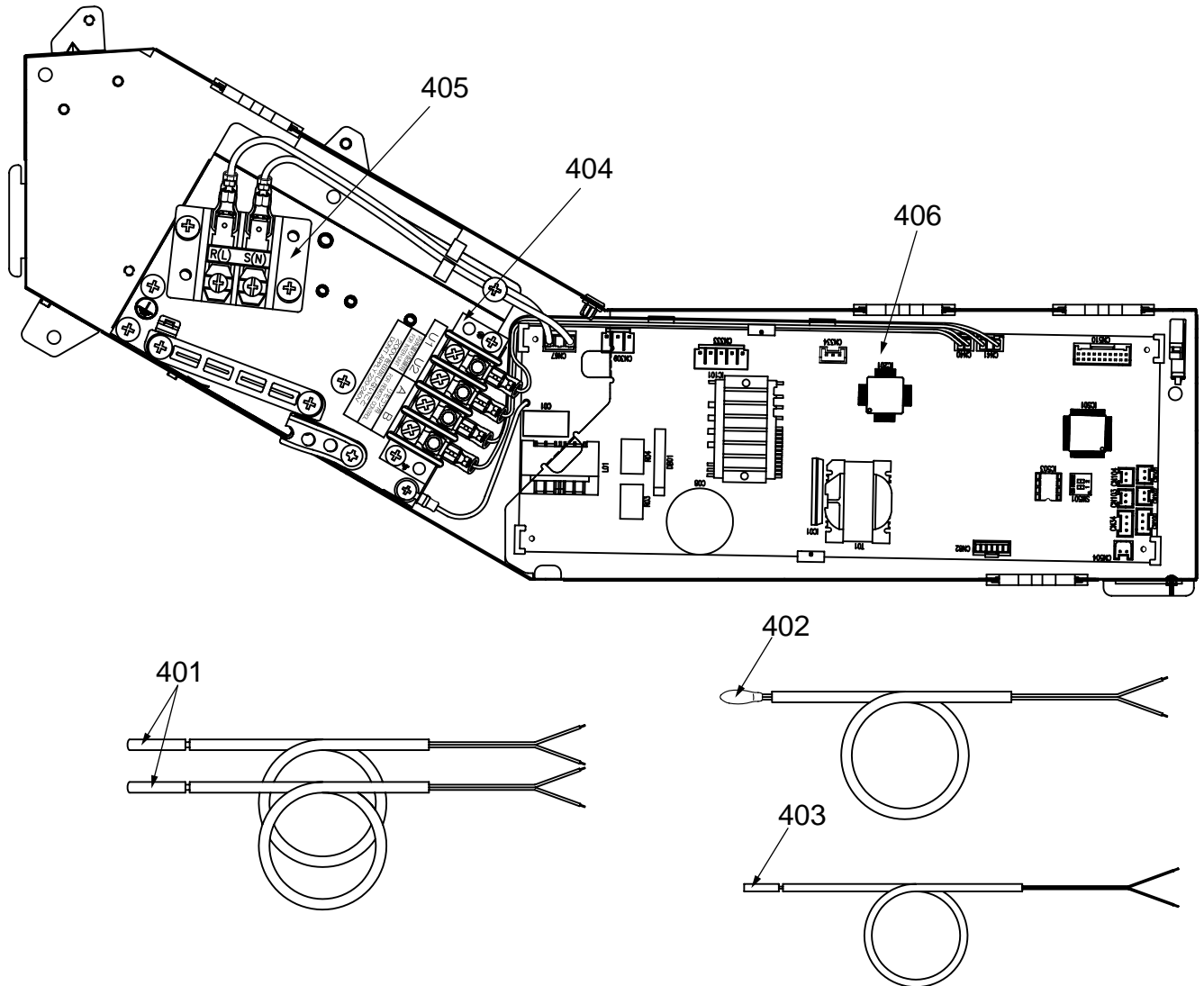

Location No.	Part No.	Description	MMU-AP				
			0094HP1-E	0124HP1-E	0154HP1-E	0184HP1-E	0244HP1-E
401	43T50347	SENSOR ASSY, SERVICE	2	2	2	2	2
402	43T50476	SERVICE-SENSOR	1	1	1	1	1
403	43T50477	SERVICE-SENSOR	1	1	1	1	1
404	43T60362	TERMINAL	1	1	1	1	1
405	43T60435	SERV-TERMINAL	1	1	1	1	1
406	43T6V688	PC BOARD ASSY	1	1	1	1	1

Location No.	Part No.	Description	MMU-AP				
			0274HP1-E	0304HP1-E	0364HP1-E	0484HP1-E	0564HP1-E
401	43T50347	SENSOR ASSY, SERVICE	2	2	2	2	2
402	43T50476	SERVICE-SENSOR	1	1	1	1	1
403	43T50477	SERVICE-SENSOR	1	1	1	1	1
404	43T60362	TERMINAL	1	1	1	1	1
405	43T60435	SERV-TERMINAL	1	1	1	1	1
406	43T6V688	PC BOARD ASSY	1	1	1	1	1

11-3. MMU-AP0094HP1-TR, AP0124HP1-TR, AP0154HP1-TR, AP0184HP1-TR, AP0244HP1-TR

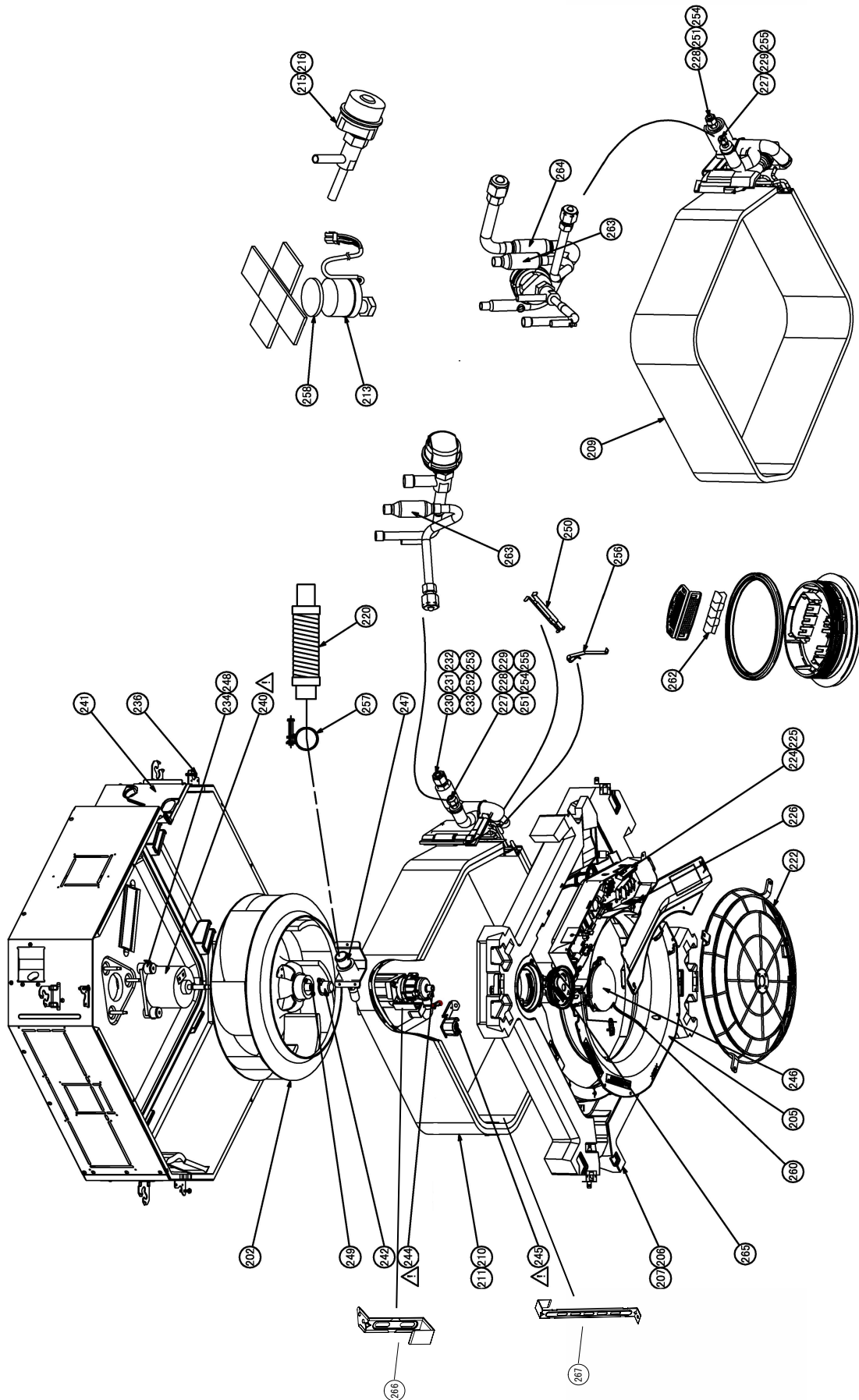

Location No.	Part No.	Description	MMU-AP				
			0094HP1-TR	0124HP1-TR	0154HP1-TR	0184HP1-TR	0244HP1-TR
202	43T20335	FAN,ASSY TURB	1	1	1	1	1
205	43T22322	BELL MOUTH	1	1	1	1	1
206	43T72320	PAN ASSY, DRAIN	-	-	1	1	1
207	43T72321	PAN ASSY, DRAIN	1	1	-	-	-
209	43T44497	REFRIGERATION CYCLE ASSY	1	1	-	-	-
210	43T44498	REFRIGERATION CYCLE ASSY	-	-	1	1	-
211	43T44499	REFRIGERATION CYCLE ASSY	-	-	-	-	1
213	43T46416	MOTOR, PMV	1	1	1	1	1
215	43T46413	VALVE, PMV	1	1	-	-	-
216	43T46414	PMV	-	-	1	1	1
220	43T70326	HOSE, DRAIN	1	1	1	1	1
222	43T19357	GUARD,FAN	1	1	1	1	1
224	43T63348	CLAMP, DOWN	1	1	1	1	1
225	43T63349	CLAMP, UP	1	1	1	1	1
226	43T63347	CLAMP, WIRE	4	4	4	4	4
227	43T97311	NUT, FLARE, 1/4 IN	1	1	1	1	-
228	43T82318	SOCKET	1	1	-	-	1
229	43T82319	SOCKET	1	1	1	1	-
230	43T97317	NUT, FLARE, 1/2 IN	-	-	1	1	-
231	43T97314	NUT, FLARE, 5/8 IN	-	-	-	-	1
232	43T82320	SOCKET	-	-	1	1	-
233	43T82321	SOCKET	-	-	-	-	1
234	43T11323	RUBBER,CUSHION	3	3	3	3	3
236	43T97315	SCREW, FIX PANEL	4	4	4	4	4
240	43T21441	MOTOR,FAN	1	1	1	1	1
241	43T04318	COVER ASSY	1	1	1	1	1
242	43T39353	CAP,NUT	1	1	1	1	1
244	43T77301	PUMP ASSY	1	1	1	1	1
245	43T51314	SWITCH ASSY, FLOAT	1	1	1	1	1
246	43T79319	LID ASSY, OUTSIDE	1	1	1	1	1
247	43T71303	SOCKET, ASSY DRAIN	1	1	1	1	1
248	43T97310	WASHER	3	3	3	3	3
249	43T97001	NUT	1	1	1	1	1
250	43T19321	FIX-P-SENSOR	1	1	1	1	1
251	43T47332	BONNET, 9.52 DIA	1	1	-	-	1
252	43T47333	BONNET, 12.70 DIA	-	-	1	1	-
253	43T47334	BONNET, 15.88 DIA	-	-	-	-	1
254	43T97312	NUT, FLARE, 3/8 IN	1	1	-	-	1
255	43T47331	BONNET, 6.35 DIA	1	1	1	1	-
256	43T19333	HOLDER, SENSOR	2	2	2	2	2
257	43T83311	BAND, HOSE	1	1	1	1	1
258	43T46417	SHEET, PMV	1	1	1	1	1
260	43T83312	STRING	1	1	1	1	1
262	43T79318	GLASS	1	1	1	1	1
263	43T47386	STRAINER	1	1	1	1	1
264	43T47387	STRAINER	1	1	-	-	-
265	43T79317	LID ASSY, INSIDE	1	1	1	1	1
266	43T39405	BAND-FIX-EVA	2	2	2	2	2
267	43T39407	BAND-FIX-EVA	1	1	1	1	1

11-4. MMU-AP0274HP1-TR, AP0304HP1-TR, AP0364HP1-TR, AP0484HP1-TR, AP0564HP1-TR

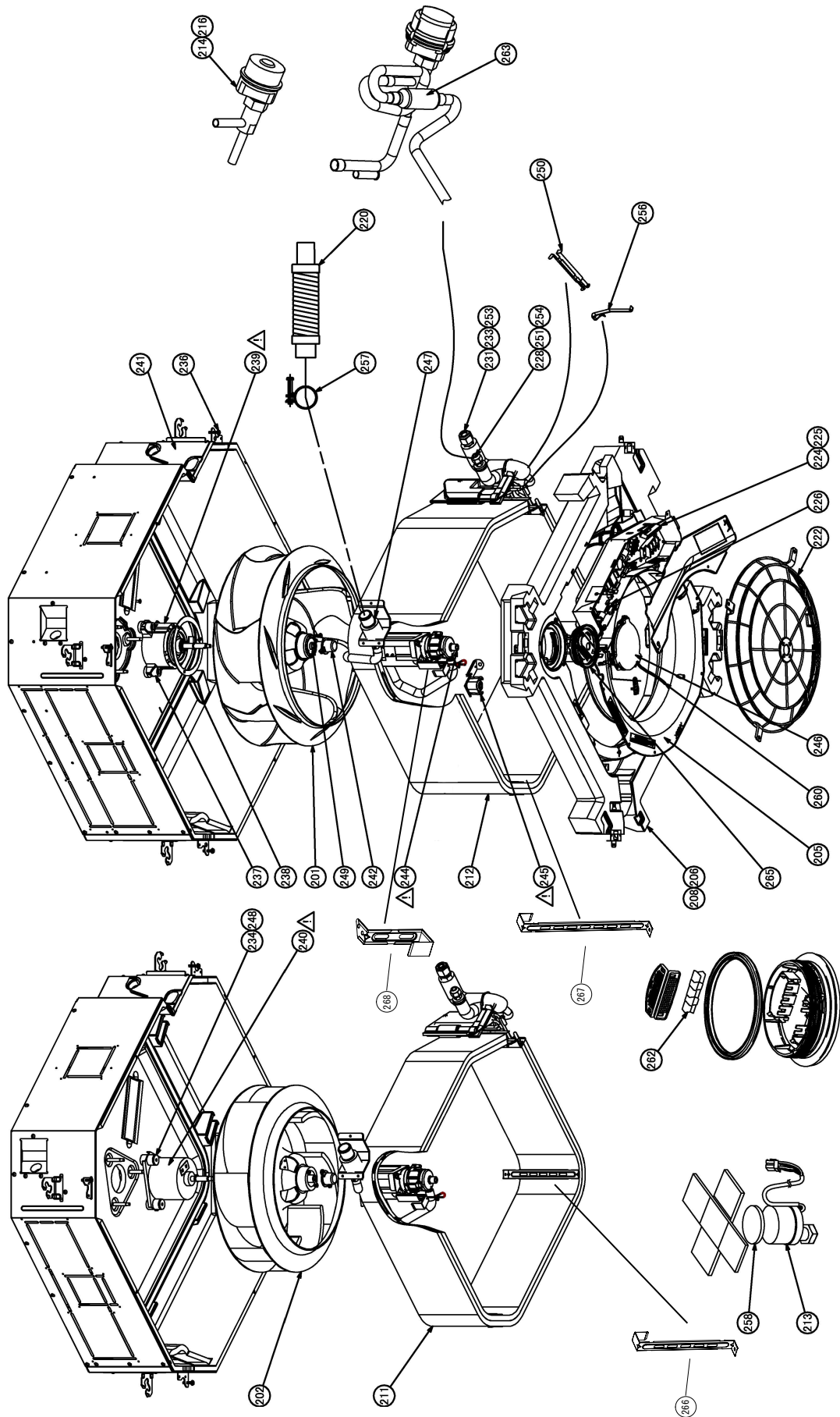

Location No.	Part No.	Description	MMU-AP				
			0274HP1-TR	0304HP1-TR	0364HP1-TR	0484HP1-TR	0564HP1-TR
201	43T20334	FAN,ASSY TURB	-	-	1	1	1
202	43T20335	FAN,ASSY TURB	1	1	-	-	-
205	43T22322	BELL MOUTH	1	1	1	1	1
206	43T72320	PAN ASSY, DRAIN	1	1	-	-	-
208	43T72322	PAN ASSY, DRAIN	-	-	1	1	1
211	43T44499	REFRIGERATION CYCLE ASSY	1	1	-	-	-
212	43T44500	REFRIGERATION CYCLE ASSY	-	-	1	1	1
213	43T46416	MOTOR, PMV	1	1	1	1	1
214	43T46415	VALVE, PMV	-	-	1	1	1
216	43T46414	PMV	1	1	-	-	-
220	43T70326	HOSE, DRAIN	1	1	1	1	1
222	43T19357	GUARD,FAN	1	1	1	1	1
224	43T63348	CLAMP, DOWN	1	1	1	1	1
225	43T63349	CLAMP, UP	1	1	1	1	1
226	43T63347	CLAMP, WIRE	4	4	4	4	4
228	43T82318	SOCKET	1	1	1	1	1
231	43T97314	NUT, FLARE, 5/8 IN	1	1	1	1	1
233	43T82321	SOCKET	1	1	1	1	1
234	43T11323	RUBBER,CUSHION	3	3	-	-	-
235	43T39352	PLATE, WIND	-	-	4	4	4
236	43T97315	SCREW, FIX PANEL	4	4	4	4	4
237	43T11324	RUBBER,CUSHION	-	-	3	3	3
238	43T97316	WASHER	-	-	1	1	1
239	43T21439	MOTOR, FAN	-	-	1	1	1
240	43T21441	MOTOR,FAN	1	1	-	-	-
241	43T04318	COVER ASSY	1	1	1	1	1
242	43T39353	CAP,NUT	1	1	1	1	1
244	43T77301	PUMP ASSY	1	1	1	1	1
245	43T51314	SWITCH ASSY, FLOAT	1	1	1	1	1
246	43T79319	LID ASSY, OUTSIDE	1	1	1	1	1
247	43T71303	SOCKET, ASSY DRAIN	1	1	1	1	1
248	43T97310	WASHER	3	3	-	-	-
249	43T97001	NUT	1	1	1	1	1
250	43T19321	FIX-P-SENSOR	1	1	1	1	1
251	43T47332	BONNET, 9.52 DIA	1	1	1	1	1
253	43T47334	BONNET; 15.88 DIA.	1	1	1	1	1
254	43T97312	NUT, FLARE, 3/8 IN	1	1	1	1	1
256	43T19333	HOLDER, SENSOR	2	2	2	2	2
257	43T83311	BAND, HOSE	1	1	1	1	1
258	43T46417	SHEET, PMV	1	1	1	1	1
260	43T83312	STRING	1	1	1	1	1
262	43T79318	GLASS	1	1	1	1	1
263	43T47386	STRAINER	1	1	1	1	1
265	43T79317	LID ASSY, INSIDE	1	1	1	1	1
266	43T39405	BAND-FIX-EVA	2	2			
267	43T39406	BAND-FIX-EVA			2	2	2
268	43T39407	BAND-FIX-EVA	1	1	1	1	1

Electric parts

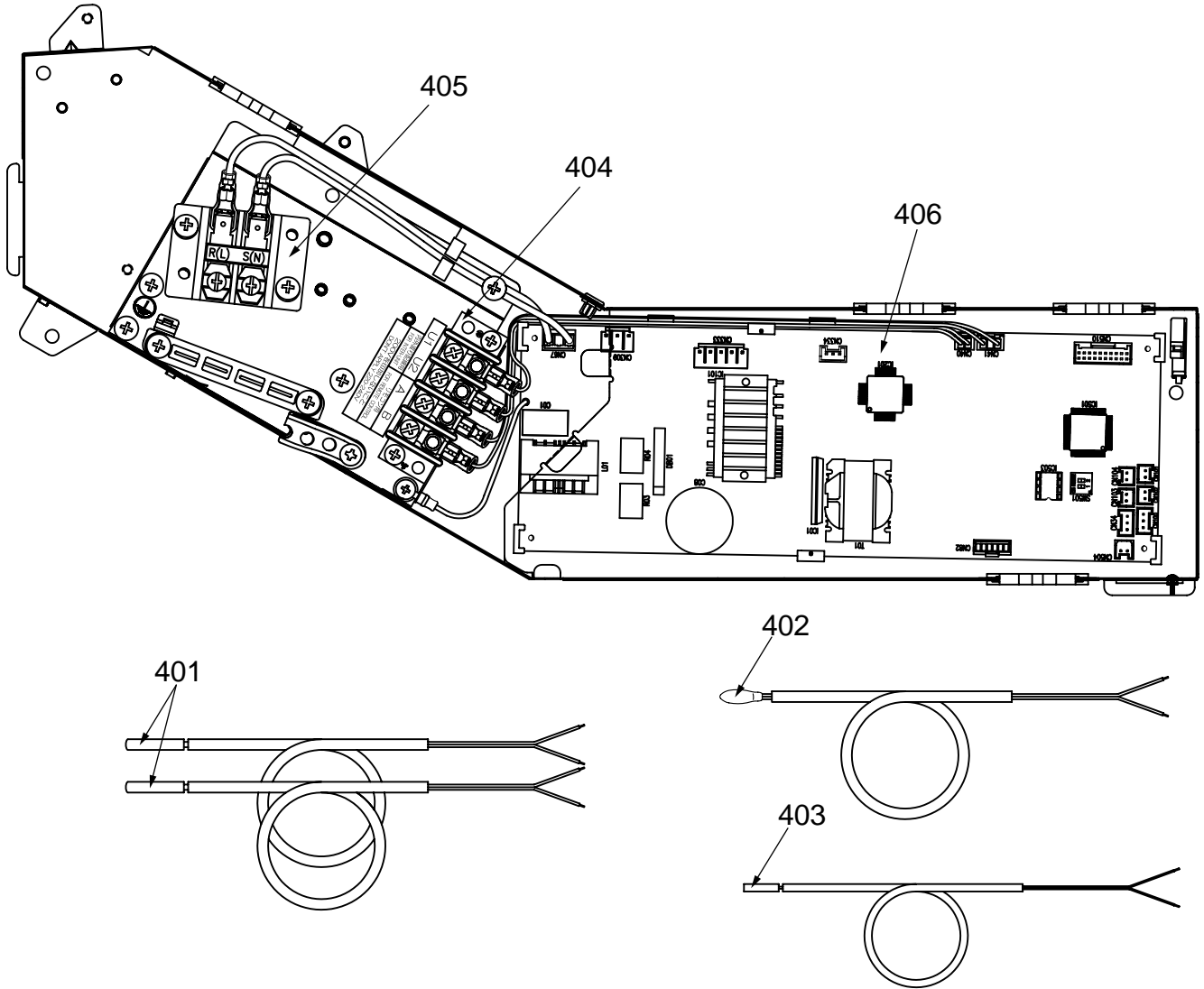

Location No.	Part No.	Description	MMU-AP				
			0094HP1-TR	0124HP1-TR	0154HP1-TR	0184HP1-TR	0244HP1-TR
401	43T50347	SENSOR ASSY, SERVICE	2	2	2	2	2
402	43T50476	SERVICE-SENSOR	1	1	1	1	1
403	43T50477	SERVICE-SENSOR	1	1	1	1	1
404	43T60362	TERMINAL	1	1	1	1	1
405	43T60435	SERV-TERMINAL	1	1	-	1	1
406	43T6V688	PC BOARD ASSY	1	1	1	1	1

Location No.	Part No.	Description	MMU-AP				
			0274HP1-TR	0304HP1-TR	0364HP1-TR	0484HP1-TR	0564HP1-TR
401	43T50347	SENSOR ASSY, SERVICE	2	2	2	2	2
402	43T50476	SERVICE-SENSOR	1	1	1	1	1
403	43T50477	SERVICE-SENSOR	1	1	1	1	1
404	43T60362	TERMINAL	1	1	1	1	1
405	43T60435	SERV-TERMINAL	1	1	1	1	1
406	43T6V688	PC BOARD ASSY	1	1	1	1	1

RBC-U31PG (W, WS)-E, RBC-U31PGS (W, WS)-E

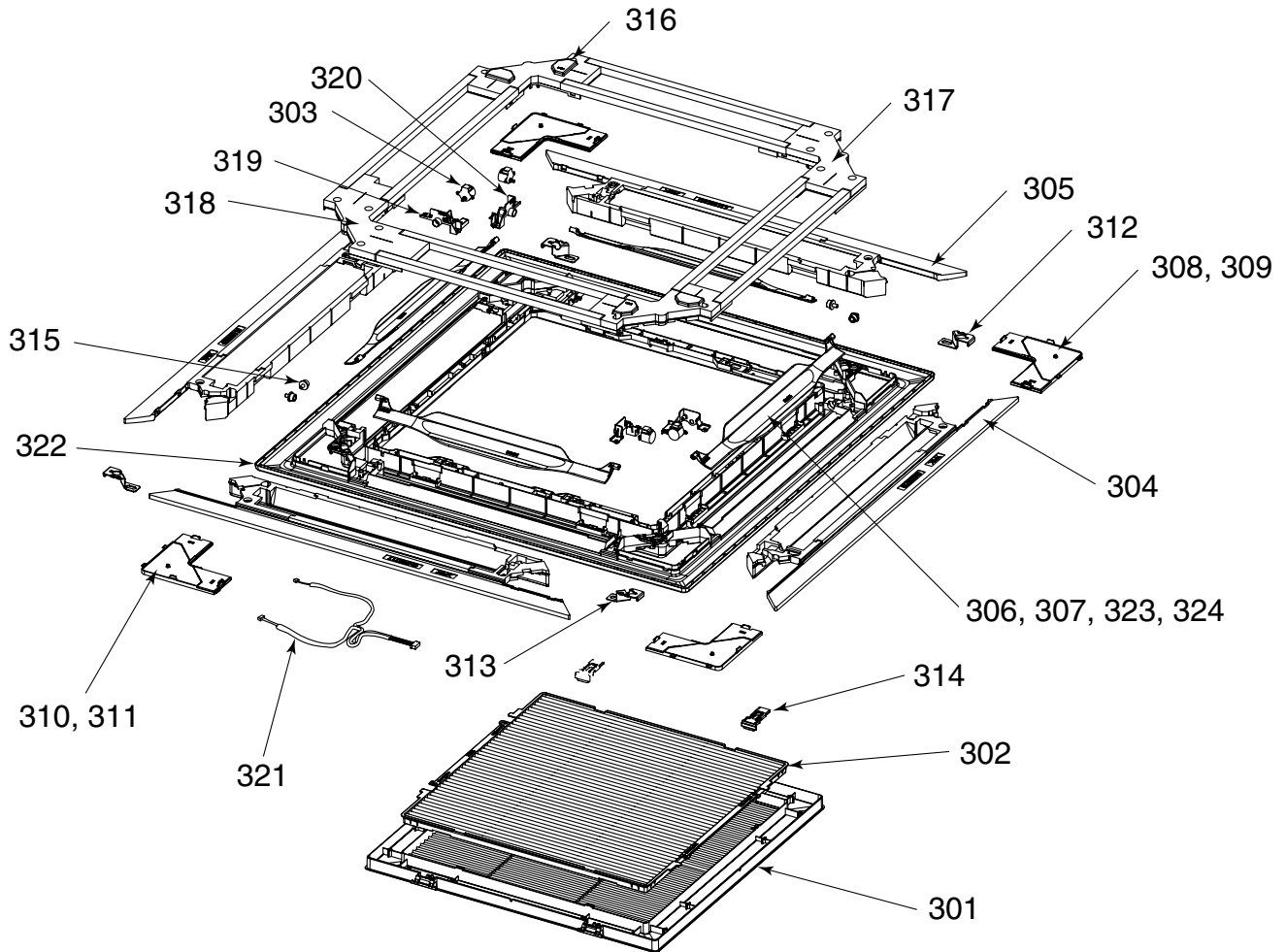

Location No.	Parts No.	Description	Model Name RBC-U31			
			U31PG(W)-E	U31PG(WS)-E	U31PGS(W)-E	U31PGS(WS)-E
301	43409207	Grille, Air Inlet	1	1	1	1
302	43480017	Air Filter, ABS + PPNET	1	1	1	1
303	4302D003	Motor, Louver, MP24Z3N	4	4	4	4
304	43407145	Outlet, Air Form, PS-F	2	2	2	2
305	43407146	Outlet, Air Form, PS-F	2	2	2	2
306	43409212	Louver, ABS	4			
307	43409216	Louver, ABS		4		
308	43401037	Cover, Panel Ass'y	3		3	
309	43401041	Cover, Panel Ass'y		3		3
310	43401043	Cover, Panel Ass'y	1		1	
311	43401047	Cover, Panel Ass'y		1		1
312	43407148	Plate, Fix, Panel	2	2	2	2
313	43407149	Plate, Fix, Panel	2	2	2	2
314	43407150	Hook, ABS	2	2	2	2
315	43407154	Cap, AXIS, POM	4	4	4	4
316	43403010	Cover Ass'y, Motor	2	2	2	2
317	43403011	Cover Ass'y	1	1	1	1
318	43403012	Cover Ass'y	1	1	1	1
319	43407155	Fix, Motor, ABS	2	2	2	2
320	43407156	Fix, Motor, ABS	2	2	2	2
321	43460125	Lead, Motor	1	1	1	1
322	43400077	Panel, Front, PS (W)	1	1	1	1
323	43109423	Louver, ABS			4	
324	43109424	Louver, ABS				4

WARNINGS ON REFRIGERANT LEAKAGE

Check of Concentration Limit

The room in which the air conditioner is to be installed requires a design that in the event of refrigerant gas leaking out, its concentration will not exceed a set limit. The refrigerant R410A which is used in the air conditioner is safe, without the toxicity or combustibility of ammonia, and is not restricted by laws to be imposed which protect the ozone layer. However, since it contains more than air, it poses the risk of suffocation if its concentration should rise excessively. Suffocation from leakage of R410A is almost non-existent. With the recent increase in the number of high concentration buildings, however, the installation of multi air conditioner systems is on the increase because of the need for effective use of floor space, individual control, energy conservation by curtailing heat and carrying power etc. Most importantly, the multi air conditioner system is able to replenish a large amount of refrigerant compared with conventional individual air conditioners. If a single unit of the multi conditioner system is to be installed in a small room, select a suitable model and installation procedure so that if the refrigerant accidentally leaks out, its concentration does not reach the limit (and in the event of an emergency, measures can be made before injury can occur). In a room where the concentration may exceed the limit, create an opening with adjacent rooms, or install mechanical ventilation combined with a gas leak detection device. The concentration is as given below.

$$\frac{\text{Total amount of refrigerant (kg)}}{\text{Min. volume of the indoor unit installed room (m}^3\text{)}} \leq \text{Concentration limit (kg/m}^3\text{)}$$

The concentration limit of R410A which is used in multi air conditioners is 0.3kg/m³.

NOTE 1 :

If there are 2 or more refrigerating systems in a single refrigerating device, the amounts of refrigerant should be as charged in each independent device.

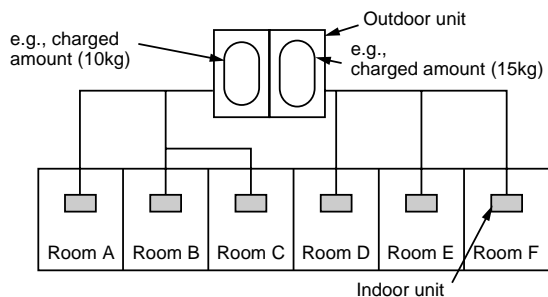

For the amount of charge in this example:
 The possible amount of leaked refrigerant gas in rooms A, B and C is 10kg.
 The possible amount of leaked refrigerant gas in rooms D, E and F is 15kg.

Important

NOTE 2 :

The standards for minimum room volume are as follows.

- (1) No partition (shaded portion)

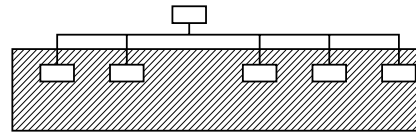

- (2) When there is an effective opening with the adjacent room for ventilation of leaking refrigerant gas (opening without a door, or an opening 0.15% or larger than the respective floor spaces at the top or bottom of the door).

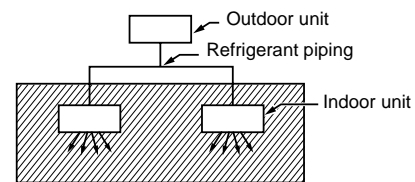

- (3) If an indoor unit is installed in each partitioned room and the refrigerant piping is interconnected, the smallest room of course becomes the object. But when a mechanical ventilation is installed interlocked with a gas leakage detector in the smallest room where the density limit is exceeded, the volume of the next smallest room becomes the object.

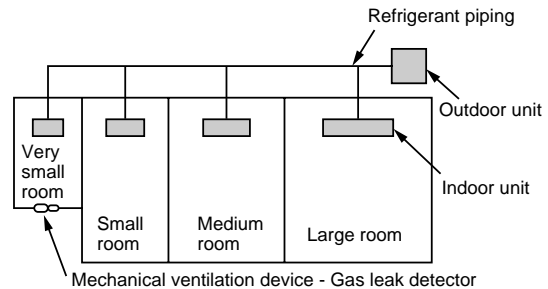

NOTE 3 :

The minimum indoor floor area compared with the amount of refrigerant is roughly as follows:
 (When the ceiling is 2.7m high)

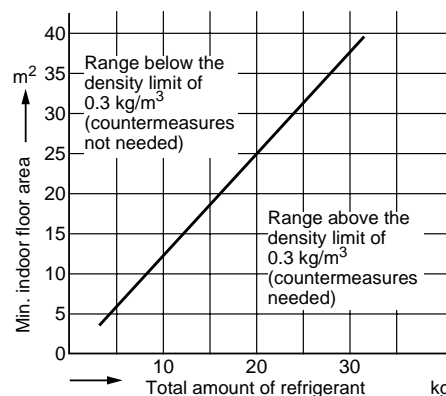

TOSHIBA CARRIER (THAILAND) CO.,LTD.

144/9 MOO 5, BANGKADI INDUSTRIAL PARK, TIVANON ROAD, TAMBOL BANGKADI,
AMPHUR MUANG, PATHUMTHANI 12000, THAILAND.