

# TOSHIBA

FILE NO. SVM-16013-4

## SERVICE MANUAL

# AIR-CONDITIONER MULTI TYPE

### INDOOR UNIT

< Concealed Duct High Static Pressure Type >

*MMD-AP0726HP-E*

*MMD-AP0966HP-E*

*MMD-AP0726HP-TR*

*MMD-AP0966HP-TR*

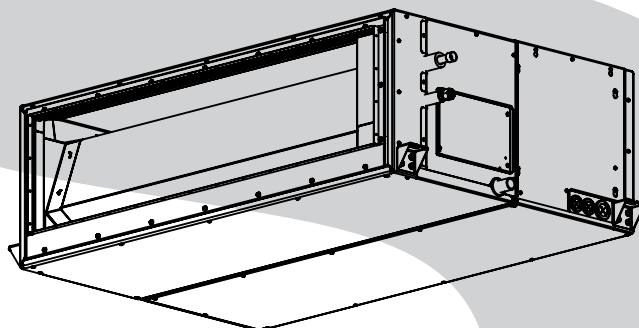

Revised on September, 2019

# CONTENTS

PRECAUTIONS FOR SAFETY .....	6
1. SPECIFICATIONS .....	13
2.FAN CHARACTERISTICS .....	14
3.CONSTRUCTION VIEWS (EXTERNAL VIEWS) .....	15
4. WIRING DIAGRAMS .....	17
5.PARTS RATING .....	18
6.REFRIGERANT CYCLE DIAGRAM .....	19
7.CONTROL OUTLINE .....	20
8. APPLIED CONTROL AND FUNCTIONS (INCLUDING CIRCUIT CONFIGURATION) .....	26
8-1. Indoor controller block diagram .....	26
8-1-1. In Case of Connection of Wired (Simple) Remote Controller .....	26
8-1-2. In Case of Connection of Wireless Remote Controller .....	27
8-1-3. Connection of Both Wired (Simple) Remote Controller and Wireless Remote Controller .....	28
8-2. Indoor Circuit Design Board MCC-1643 .....	29
8-2-1. Optional connector specifications of indoor P.C. board .....	30
8-2-2. Fan IPDU P.C. Board (MCC-1610).....	31
8-2-3. Noise filter (MCC-1551) .....	32
8-3. Test operation of indoor unit .....	33
8-4. Method to set indoor unit function DN code .....	34
8-5. Applied control of indoor unit .....	37
9.TROUBLESHOOTING .....	51
9-1. Overview .....	51
9-2. Troubleshooting method .....	52
9-3. Troubleshooting based on information displayed on remote controller .....	58
9-4. Check codes displayed on remote controller and SMMS outdoor unit (7-segment display on I/F board) and locations to be checked .....	63
9-5. Sensor characteristics .....	79
10. P.C. BOARD EXCHANGE PROCEDURES .....	80
10-1. Replacement of indoor P.C. boards .....	80
10-2. Fan IPDU P.C. Board (MCC-1610).....	85
10-3. N/F P.C. Board (MCC-1551) Replacement Procedure.....	85
11. DETACHMENTS .....	86
12. EXPLODED VIEWS AND PARTS LIST .....	98

## Original instruction

Please read carefully through these instructions that contain important information which complies with the "Machinery Directive" (Directive 2006/42/EC), and ensure that you understand them.

## Generic Denomination: Air Conditioner

### Definition of Qualified Installer or Qualified Service Person

The air conditioner must be installed, maintained, repaired and removed by a qualified installer or qualified service person. When any of these jobs is to be done, ask a qualified installer or qualified service person to do them for you.

A qualified installer or qualified service person is an agent who has the qualifications and knowledge described in the table below.

Agent	Qualifications and knowledge which the agent must have
Qualified installer	<ul style="list-style-type: none"> <li>• The qualified installer is a person who installs, maintains, relocates and removes the air conditioners made by Toshiba Carrier Corporation. He or she has been trained to install, maintain, relocate and remove the air conditioners made by Toshiba Carrier Corporation or, alternatively, he or she has been instructed in such operations by an individual or individuals who have been trained and is thus thoroughly acquainted with the knowledge related to these operations.</li> <li>• The qualified installer who is allowed to do the electrical work involved in installation, relocation and removal has the qualifications pertaining to this electrical work as stipulated by the local laws and regulations, and he or she is a person who has been trained in matters relating to electrical work on the air conditioners made by Toshiba Carrier Corporation or, alternatively, he or she has been instructed in such matters by an individual or individuals who have been trained and is thus thoroughly acquainted with the knowledge related to this work.</li> <li>• The qualified installer who is allowed to do the refrigerant handling and piping work involved in installation, relocation and removal has the qualifications pertaining to this refrigerant handling and piping work as stipulated by the local laws and regulations, and he or she is a person who has been trained in matters relating to refrigerant handling and piping work on the air conditioners made by Toshiba Carrier Corporation or, alternatively, he or she has been instructed in such matters by an individual or individuals who have been trained and is thus thoroughly acquainted with the knowledge related to this work.</li> <li>• The qualified installer who is allowed to work at heights has been trained in matters relating to working at heights with the air conditioners made by Toshiba Carrier Corporation or, alternatively, he or she has been instructed in such matters by an individual or individuals who have been trained and is thus thoroughly acquainted with the knowledge related to this work.</li> </ul>
Qualified service person	<ul style="list-style-type: none"> <li>• The qualified service person is a person who installs, repairs, maintains, relocates and removes the air conditioners made by Toshiba Carrier Corporation. He or she has been trained to install, repair, maintain, relocate and remove the air conditioners made by Toshiba Carrier Corporation or, alternatively, he or she has been instructed in such operations by an individual or individuals who have been trained and is thus thoroughly acquainted with the knowledge related to these operations.</li> <li>• The qualified service person who is allowed to do the electrical work involved in installation, repair, relocation and removal has the qualifications pertaining to this electrical work as stipulated by the local laws and regulations, and he or she is a person who has been trained in matters relating to electrical work on the air conditioners made by Toshiba Carrier Corporation or, alternatively, he or she has been instructed in such matters by an individual or individuals who have been trained and is thus thoroughly acquainted with the knowledge related to this work.</li> <li>• The qualified service person who is allowed to do the refrigerant handling and piping work involved in installation, repair, relocation and removal has the qualifications pertaining to this refrigerant handling and piping work as stipulated by the local laws and regulations, and he or she is a person who has been trained in matters relating to refrigerant handling and piping work on the air conditioners made by Toshiba Carrier Corporation or, alternatively, he or she has been instructed in such matters by an individual or individuals who have been trained and is thus thoroughly acquainted with the knowledge related to this work.</li> <li>• The qualified service person who is allowed to work at heights has been trained in matters relating to working at heights with the air conditioners made by Toshiba Carrier Corporation or, alternatively, he or she has been instructed in such matters by an individual or individuals who have been trained and is thus thoroughly acquainted with the knowledge related to this work.</li> </ul>

## Definition of Protective Gear

When the air conditioner is to be transported, installed, maintained, repaired or removed, wear protective gloves and 'safety' work clothing.

In addition to such normal protective gear, wear the protective gear described below when undertaking the special work detailed in the table below.



Failure to wear the proper protective gear is dangerous because you will be more susceptible to injury, burns, electric shocks and other injuries.

Work undertaken	Protective gear to wear
All types of work	Protective gloves 'Safety' working clothing
Electrical-related work	Gloves to provide protection for electricians Insulating shoes Clothing to provide protection from electric shock
Work at heights (50 cm or more)	Helmets for use in industry
Transportation of heavy objects	Shoes with additional protective toe cap
Repair of outdoor unit	Gloves to provide protection for electricians

The important contents concerned to the safety are described on the product itself and on this Service Manual.



Please read this Service Manual after understanding the described items thoroughly in the following contents (Indications / Illustrated marks), and keep them.

### [Explanation of indications]

Indication	Explanation
 <b>DANGER</b>	Indicates contents assumed that an imminent danger causing a death or serious injury of the repair engineers and the third parties when an incorrect work has been executed.
 <b>WARNING</b>	Indicates possibilities assumed that a danger causing a death or serious injury of the repair engineers, the third parties, and the users due to troubles of the product after work when an incorrect work has been executed.
 <b>CAUTION</b>	Indicates contents assumed that an injury or property damage (*) may be caused on the repair engineers, the third parties, and the users due to troubles of the product after work when an incorrect work has been executed.

\* Property damage: Enlarged damage concerned to property, furniture, and domestic animal / pet

### [Explanation of illustrated marks]

Indication	Explanation
	Indicates prohibited items (Forbidden items to do) The sentences near an illustrated mark describe the concrete prohibited contents.
	Indicates mandatory items (Compulsory items to do) The sentences near an illustrated mark describe the concrete mandatory contents.
	Indicates cautions (Including danger / warning) The sentences or illustration near or in an illustrated mark describe the concrete cautious contents.









## Warning Indications on the Air Conditioner Unit

### [Confirmation of warning label on the main unit]

Confirm that labels are indicated on the specified positions





If removing the label during parts replace, stick it as the original.

Warning indication		Description
	<p><b>WARNING</b></p> <p><b>ELECTRICAL SHOCK HAZARD</b> Disconnect all remote electric power supplies before servicing.</p>	<p><b>WARNING</b></p> <p><b>ELECTRICAL SHOCK HAZARD</b> Disconnect all remote electric power supplies before servicing.</p>
	<p><b>WARNING</b></p> <p>Moving parts. Do not operate unit with grille removed. Stop the unit before the servicing.</p>	<p><b>WARNING</b></p> <p>Moving parts. Do not operate unit with grille removed. Stop the unit before the servicing.</p>
	<p><b>CAUTION</b></p> <p>High temperature parts. You might get burned when removing this panel.</p>	<p><b>CAUTION</b></p> <p>High temperature parts. You might get burned when removing this panel.</p>
	<p><b>CAUTION</b></p> <p>Do not touch the aluminium fins of the unit. Doing so may result in injury.</p>	<p><b>CAUTION</b></p> <p>Do not touch the aluminium fins of the unit. Doing so may result in injury.</p>
	<p><b>CAUTION</b></p> <p><b>BURST HAZARD</b> Open the service valves before the operation, otherwise there might be the burst.</p>	<p><b>CAUTION</b></p> <p><b>BURST HAZARD</b> Open the service valves before the operation, otherwise there might be the burst.</p>
	<p><b>CAUTION</b></p> <p><b>Do not climb onto the fan guard.</b> Doing so may result in injury.</p>	<p><b>CAUTION</b></p> <p><b>Do not climb onto the fan guard.</b> Doing so may result in injury.</p>



# PRECAUTIONS FOR SAFETY







The manufacturer shall not assume any liability for the damage caused by not observing the description of this manual.







## DANGER



 Turn off breaker	<p>Before carrying out the installation, maintenance, repair or removal work, be sure to set the circuit breaker for both the indoor and outdoor units to the OFF position. Otherwise, electric shocks may result.</p>
	<p>Before opening the electrical box cover of the indoor unit or service panel of the outdoor unit, set the circuit breaker to the OFF position. Failure to set the circuit breaker to the OFF position may result in electric shocks through contact with the interior parts. Only a qualified installer (*1) or qualified service person (*1) is allowed to remove the intake grille of the indoor unit or service panel of the outdoor unit and do the work required.</p>
	<p>Place a "Work in progress" sign near the circuit breaker while the installation, maintenance, repair or removal work is being carried out. There is a danger of electric shocks if the circuit breaker is set to ON by mistake.</p>
	<p>Before opening the inspection opening, set the circuit breaker to the OFF position. Failure to set the circuit breaker to the OFF position may result in injury through contact with the rotation parts. Only a qualified installer (*1) or qualified service person(*1) is allowed to remove the inspection opening and do the work required.</p>
	<p>When cleaning the filter (sold separately) or other parts of the indoor unit, set the circuit breaker to OFF without fail, and place a "Work in progress" sign near the circuit breaker before proceeding with the work.</p> <p>When you have noticed that some kind of trouble (such as when check code display has appeared, there is a smell of burning, abnormal sounds are heard, the air conditioner fails to cool or heat or water is leaking) has occurred in the air conditioner, do not touch the air conditioner yourself but set the circuit breaker to the OFF position, and contact a qualified service person. Take steps to ensure that the power will not be turned on (by marking "out of service" near the circuit breaker, for instance) until qualified service person arrives. Continuing to use the air conditioner in the trouble status may cause mechanical problems to escalate or result in electric shocks or other failure.</p>
 Electric shock hazard	<p>When you access inside of the service panel to repair electric parts, wait for about five minutes after turning off the breaker. Do not start repairing immediately. Otherwise you may get electric shock by touching terminals of high-voltage capacitors. Natural discharge of the capacitor takes about five minutes.</p>
	<p>When checking the electric parts, removing the cover of the electric parts box of Indoor Unit and/or service panel of Outdoor Unit inevitably to determine the failure, use gloves to provide protection for electricians, insulating shoes, clothing to provide protection from electric shock and insulating tools. Be careful not to touch the live part. Electric shock may result. Only "Qualified service person" is allowed to do this work.</p>
	<p>Before operating the air conditioner after having completed the work, check that the electrical partw box cover of the indoor unit and service panel of the outdoor unit are closed, and set the circuit breaker to the on position. You may receive on electric shock if the power is turned on without first conducting these checks.</p>
 Prohibition	<p>Place a "Work in progress" sign near the circuit breaker while the installation, maintenance, repair or removal work is being carried out. There is a danger of electric shocks if the circuit breaker is set to ON by mistake.</p>
	<p>When checking the electric parts, removing the cover of the electric parts box of Indoor Unit and/or front panel of Outdoor Unit inevitably to determine the failure, put a sign "Do not enter" around the site before the work. Failure to do this may result in third person getting electric shock.</p> <p>Before operating the air conditioner after having completed the work, check that the electrical parts box cover of the indoor unit and service panel of the outdoor unit are closed, and set the circuit breaker to the ON position. You may receive an electric shock if the power is turned on without first conducting these checks.</p>
 Stay on protection	<p>If, in the course of carrying out repairs, it becomes absolutely necessary to check out the electrical parts with the electrical parts box cover of one or more of the indoor units and the service panel of the outdoor unit removed in order to find out exactly where the trouble lies, wear insulated heat-resistant gloves, insulated boots and insulated work overalls, and take care to avoid touching any live parts. You may receive an electric shock if you fail to heed this warning. Only qualified service person (*1) is allowed to do this kind of work.</p>

 **WARNIG**

 General	<p>Before starting to repair the air conditioner, read carefully through the Service Manual, and repair the air conditioner by following its instructions.</p>
	<p>Only qualified service person (*1) is allowed to repair the air conditioner. Repair of the air conditioner by unqualified person may give rise to a fire, electric shocks, injury, water leaks and / or other problems.</p>
	<p>Inside the air conditioner are high-voltage areas and rotating parts. Due to the danger of electric shocks or of your fingers or physical objects becoming trapped in the rotating part, do not remove the electrical control box cover of the indoor unit or service panel of the outdoor unit. When work involving the removal of these parts is required, contact a qualified installer or a qualified service person.</p>
	<p>Only a qualified installer (*1) or qualified service person (*1) is allowed to carry out the electrical work of the air conditioner. Under no circumstances must this work be done by an unqualified individual since failure to carry out the work properly may result in electric shocks and / or electrical leaks.</p>
	<p>When the air conditioner is to be transported, installed, maintained, repaired or removed, wear protective gloves and 'safety' work clothing.</p>
	<p>To connect the electrical wires, repair the electrical parts or undertake other electrical jobs, wear gloves to provide protection for electricians, insulating shoes and clothing to provide protection from electric shocks. Failure to wear this protective gear may result in electric shocks.</p>
	<p>When checking the electric parts, removing the cover of the electric parts box of Indoor Unit and/or front panel of Outdoor Unit inevitably to determine the failure, put a sign "Do not enter" around the site before the work. Failure to do this may result in third person getting electric shock.</p>
	<p>Electrical wiring work shall be conducted according to law and regulation in the community and installation manual. Failure to do so may result in electrocution or short circuit.</p>
	<p>Use wiring that meets the specifications in the Installation Manual and the stipulations in the local regulations and laws. Use of wiring which does not meet the specifications may give rise to electric shocks, electrical leakage, smoking and/or a fire.</p>
	<p>Only a qualified installer (*1) or qualified service person (*1) is allowed to undertake work at heights using a stand of 50 cm or more or to remove the intake grille of the indoor unit to undertake work.</p>
	<p>When working at heights, use a ladder which complies with the ISO 14122 standard, and follow the procedure in the ladder's instructions. Also wear a helmet for use in industry as protective gear to undertake the work.</p>
	<p>Before working at heights, put a sign in place so that no-one will approach the work location, before proceeding with the work. Parts and other objects may fall from above, possibly injuring a person below. While carrying out the work, wear a helmet for protection from falling objects.</p>
	<p>When executing address setting, test run, or troubleshooting through the checking window on the electric parts box, put on insulated gloves to provide protection from electric shock. Otherwise you may receive an electric shock.</p>
	<p>Do not touch the aluminum fin of the unit. You may injure yourself if you do so. If the fin must be touched for some reason, first put on protective gloves and safety work clothing, and then proceed.</p>
	<p>Use forklift to carry in the air conditioner units and use winch or hoist at installation of them.</p>
<p>When transporting the air conditioner, wear shoes with protective toe caps, protective gloves and other protective clothing.</p>	
<p>When transporting the air conditioner, do not take hold of the bands around the packing carton. You may injure yourself if the bands should break.</p>	
 Check earth wires.	<p>Before troubleshooting or repair work, check the earth wire is connected to the earth terminals of the main unit, otherwise an electric shock is caused when a leak occurs. If the earth wire is not correctly connected, contact an electric engineer for rework.</p>
	<p>After completing the repair or relocation work, check that the earth wires are connected properly.</p>
	<p>Be sure to connect earth wire. Incomplete earthing causes an electric shock. Do not connect earth wires to gas pipes, water pipes, and lightning rods or earth wires for telephone wires.</p>

 Prohibition of modification.	<p>Do not modify the products. Do not also disassemble or modify the parts. It may cause a fire, electric shock or injury.</p>
 Use specified parts.	<p>When any of the electrical parts are to be replaced, ensure that the replacement parts satisfy the specifications given in the Service Manual (or use the parts contained on the parts list in the Service Manual).          Use of any parts which do not satisfy the required specifications may give rise to electric shocks, smoking and / or a fire.</p>
 Do not bring a child close to the equipment.	<p>If, in the course of carrying out repairs, it becomes absolutely necessary to check out the electrical parts with the electrical parts box cover of one or more of the indoor units and the service panel of the outdoor unit removed in order to find out exactly where the trouble lies, put a sign in place so that no one will approach the work location before proceeding with the work. Third-party individuals may enter the work site and receive electric shocks if this warning is not heeded.</p>
 Insulating measures	<p>Connect the cut-off lead wires with crimp contact, etc., put the closed end side upward and then apply a water cut method, otherwise a leak or production of fire is caused at the users' side.</p>
 No fire	<p>When performing repairs using a gas burner, replace the refrigerant with nitrogen gas because the oil that coats the pipes may otherwise burn.          When repairing the refrigerating cycle, take the following measures.</p> <ol style="list-style-type: none"> <li>1) Be attentive to fire around the cycle. When using a gas stove, etc., be sure to put out fire before work; otherwise the oil mixed with refrigerant gas may catch fire.</li> <li>2) Do not use a welder in the closed room. When using it without ventilation, carbon monoxide poisoning may be caused.</li> <li>3) Do not bring inflammables close to the refrigerant cycle, otherwise fire of the welder may catch the inflammables.</li> </ol>
 Refrigerant	<p>The refrigerant used by this air conditioner is the R410A.</p> <p>Check the used refrigerant name and use tools and materials of the parts which match with it. For the products which use R410A refrigerant, the refrigerant name is indicated at a position on the outdoor unit where is easy to see. To prevent miss-charging, the route of the service port is changed from one of the former R22.</p> <p>Do not use any refrigerant different from the one specified for complement or replacement. Otherwise, abnormally high pressure may be generated in the refrigeration cycle, which may result in a failure or explosion of the product or an injury to your body.</p> <p>For an air conditioner which uses R410A, never use other refrigerant than R410A. For an air conditioner which uses other refrigerant (R22, etc.), never use R410A. If different types of refrigerant are mixed, abnormal high pressure generates in the refrigerating cycle and an injury due to breakage may be caused.</p> <p>When the air conditioner has been installed or relocated, follow the instructions in the Installation Manual and purge the air completely so that no gases other than the refrigerant will be mixed in the refrigerating cycle.          Failure to purge the air completely may cause the air conditioner to malfunction.</p> <p>Do not charge refrigerant additionally. If charging refrigerant additionally when refrigerant gas leaks, the refrigerant composition in the refrigerating cycle changes resulted in change of air conditioner characteristics or refrigerant over the specified standard amount is charged and an abnormal high pressure is applied to the inside of the refrigerating cycle resulted in cause of breakage or injury. Therefore if the refrigerant gas leaks, recover the refrigerant in the air conditioner, execute vacuuming, and then newly recharge the specified amount of liquid refrigerant. In this time, never charge the refrigerant over the specified amount.</p> <p>When recharging the refrigerant in the refrigerating cycle, do not mix the refrigerant or air other than R410A into the specified refrigerant. If air or others is mixed with the refrigerant, abnormal high pressure generates in the refrigerating cycle resulted in cause of injury due to breakage.</p> <p>After installation work, check the refrigerant gas does not leak. If the refrigerant gas leaks in the room, poisonous gas generates when gas touches to fire such as fan heater, stove or cooking stove though the refrigerant gas itself is innocuous.</p> <p>Never recover the refrigerant into the outdoor unit. When the equipment is moved or repaired, be sure to recover the refrigerant with recovering device.          The refrigerant cannot be recovered in the outdoor unit; otherwise a serious accident such as breakage or injury is caused.</p>

 Assembly / Wiring	After repair work, surely assemble the disassembled parts, and connect and lead the removed wires as before. Perform the work so that the cabinet or panel does not catch the inner wires. If incorrect assembly or incorrect wire connection was done, a disaster such as a leak or fire is caused at user's side.
 Insulator check	After the work has finished, be sure to use an insulation tester set (500 V Megger) to check the resistance is 1 MΩ or more between the charge section and the non-charge metal section (Earth position). If the resistance value is low, a disaster such as a leak or electric shock is caused at user's side.
 Ventilation	When the refrigerant gas leaks during work, execute ventilation. If the refrigerant gas touches to a fire, poisonous gas generates. A case of leakage of the refrigerant and the closed room full with gas is dangerous because a shortage of oxygen occurs. Be sure to execute ventilation. If refrigerant gas has leaked during the installation work, ventilate the room immediately. If the leaked refrigerant gas comes in contact with fire, noxious gas may generate. After installation work, check the refrigerant gas does not leak. If the refrigerant gas leaks in the room, poisonous gas generates when gas touches to fire such as fan heater, stove or cooking stove though the refrigerant gas itself is innocuous.
 Compulsion	When the refrigerant gas leaks, find up the leaked position and repair it surely. If the leaked position cannot be found up and the repair work is interrupted, pump-down and tighten the service valve, otherwise the refrigerant gas may leak into the room. The poisonous gas generates when gas touches to fire such as fan heater, stove or cooking stove though the refrigerant gas itself is innocuous. When installing equipment which includes a large amount of charged refrigerant such as a multi air conditioner in a sub-room, it is necessary that the density does not the limit even if the refrigerant leaks. If the refrigerant leaks and exceeds the limit density, an accident of shortage of oxygen is caused. Tighten the flare nut with a torque wrench in the specified manner. Excessive tighten of the flare nut may cause a crack in the flare nut after a long period, which may result in refrigerant leakage. Nitrogen gas must be used for the airtight test. The charge hose must be connected in such a way that it is not slack. For the installation / moving / reinstallation work, follow to the Installation Manual. If an incorrect installation is done, a trouble of the refrigerating cycle, water leak, electric shock or fire is caused.
 Check after repair	Once the repair work has been completed, check for refrigerant leaks, and check the insulation resistance and water drainage. Then perform a trial run to check that the air conditioner is running properly. After repair work has finished, check there is no trouble. If check is not executed, a fire, electric shock or injury may be caused. For a check, turn off the power breaker. After repair work (installation of front panel and cabinet) has finished, execute a test run to check there is no generation of smoke or abnormal sound. If check is not executed, a fire or an electric shock is caused. Before test run, install the front panel and cabinet. Be sure to fix the screws back which have been removed for installation or other purposes.
 Do not operate the unit with the valve closed.	Check the following matters before a test run after repairing piping. <ul style="list-style-type: none"> <li>• Connect the pipes surely and there is no leak of refrigerant.</li> <li>• The valve is opened.</li> </ul> Running the compressor under condition that the valve closes causes an abnormal high pressure resulted in damage of the parts of the compressor and etc. and moreover if there is leak of refrigerant at connecting section of pipes, the air is sucked and causes further abnormal high pressure resulted in burst or injury.
 Check after reinstallation	Only a qualified installer (*1) or qualified service person (*1) is allowed to relocate the air conditioner. It is dangerous for the air conditioner to be relocated by an unqualified individual since a fire, electric shocks, injury, water leakage, noise and / or vibration may result. Check the following items after reinstallation. <ol style="list-style-type: none"> <li>1) The earth wire is correctly connected.</li> <li>2) The power cord is not caught in the product.</li> <li>3) There is no inclination or unsteadiness and the installation is stable.</li> </ol> If check is not executed, a fire, an electric shock or an injury is caused. When carrying out the pump-down work shut down the compressor before disconnecting the refrigerant pipe. Disconnecting the refrigerant pipe with the service valve left open and the compressor still operating will cause air, etc. to be sucked in, raising the pressure inside the refrigeration cycle to an abnormally high level, and possibly resulting in reputeing, injury, etc.

 Cooling check	<p>When the service panel of the outdoor unit is to be opened in order for the compressor or the area around this part to be repaired immediately after the air conditioner has been shut down, set the circuit breaker to the OFF position, and then wait at least 10 minutes before opening the service panel. If you fail to heed this warning, you will run the risk of burning yourself because the compressor pipes and other parts will be very hot to the touch. In addition, before proceeding with the repair work, wear the kind of insulated heat-resistant gloves designed to protect electricians.</p>
	<p>Take care not to get burned by compressor pipes or other parts when checking the cooling cycle while running the unit as they get heated while running. Be sure to put on gloves providing protection for heat.</p>
 Installation	<p>When the service panel of the outdoor unit is to be opened in order for the fan motor, reactor, inverter or the areas around these parts to be repaired immediately after the air conditioner has been shut down, set the circuit breaker to the OFF position, and then wait at least 10 minutes before opening the service panel. If you fail to heed this warning, you will run the risk of burning yourself because the fan motor, reactor, inverter heat sink and other parts will be very hot to the touch. In addition, before proceeding with the repair work, wear the kind of insulated heat-resistant gloves designed to protect electricians.</p>
	<p>Only a qualified installer or service person is allowed to do installation work. Inappropriate installation may result in water leakage, electric shock or fire.</p>
	<p>Before starting to install the air conditioner, read carefully through the Installation Manual, and follow its instructions to install the air conditioner.</p>
	<p>Be sure to use the company-specified products for the separately purchased parts. Use of non-specified products may result in fire, electric shock, water leakage or other failure. Have the installation performed by a qualified installer.</p>
	<p>Do not install the air conditioner in a location that may be subject to a risk of exposure to a combustible gas. If a combustible gas leaks and becomes concentrated around the unit, a fire may occur.</p>
	<p>Install the indoor unit at least 2.5 m above the floor level since otherwise the users may injure themselves or receive electric shocks if they poke their fingers or other objects into the indoor unit while the air conditioner is running.</p>
	<p>Install a circuit breaker that meets the specifications in the installation manual and the stipulations in the local regulations and laws.</p>
	<p>Install the circuit breaker where it can be easily accessed by the agent.</p>
<p>If you install the unit in a small room, take appropriate measures to prevent the refrigerant from exceeding the limit concentration even if it leaks. Consult the dealer from whom you purchased the air conditioner when you implement the measures. Accumulation of highly concentrated refrigerant may cause an oxygen deficiency accident.</p>	
<p>Do not place any combustion appliance in a place where it is directly exposed to the wind of air conditioner, otherwise it may cause imperfect combustion.</p>	

### Explanations given to user

If you have discovered that the fan grille is damaged, do not approach the outdoor unit but set the circuit breaker to the OFF position, and contact a qualified service person to have the repairs done. Do not set the circuit breaker to the ON position until the repairs are completed.

### Relocation

- Only a qualified installer (\*1) or qualified service person (\*1) is allowed to relocate the air conditioner. It is dangerous for the air conditioner to be relocated by an unqualified individual since a fire, electric shocks, injury, water leakage, noise and / or vibration may result.
- When carrying out the pump-down work shut down the compressor before disconnecting the refrigerant pipe. Disconnecting the refrigerant pipe with the service valve left open and the compressor still operating will cause air, etc. to be sucked in, raising the pressure inside the refrigeration cycle to an abnormally high level, and possibly resulting in reputing, injury, etc.

(\*1) Refer to the “Definition of Qualified Installer or Qualified Service Person”



## Declaration of Conformity

Manufacturer: TOSHIBA CARRIER (THAILAND) CO., LTD.  
144 / 9 Moo 5, Bangkadi Industrial Park, Tivanon Road, Tambol Bangkadi,  
Amphur Muang, Pathumthani 12000, Thailand

Authorized Representative / Nick Ball

TCF holder: Toshiba EMEA Engineering Director  
Toshiba Carrier UK Ltd.  
Porsham Close, Belliver Industrial Estate,  
PLYMOUTH, Devon, PL6 7DB.  
United Kingdom

Hereby declares that the machinery described below:

Generic Denomination: Air Conditioner

Model / type: Indoor unit  
<Concealed Duct High Static Pressure Type>  
MMD-AP0726HP-E,  
MMD-AP0966HP-E,  
MMD-AP0726HP-TR,  
MMD-AP0966HP-TR

Commercial name: Super Modular Multi System Air Conditioner  
Super Heat Recovery Multi System Air Conditioner

Complies with the provisions of the "Machinery" Directive (Directive 2006/42/EC) and the regulations transposing into national law

### **"Declaration of incorporation of partly completed machinery"**

Must not be put into service until the final machinery into which it is to be incorporated has been declared in conformity with the provisions of this Directive, where appropriate.

### **NOTE**

---

This declaration becomes invalid if technical or operational modifications are introduced without the manufacturer's consent.

---

## Specifications

Model	Sound pressure level (dBA)		Weight (kg) Main unit
	Cooling	Heating	
MMD-AP0726HP-E	44	44	97
MMD-AP0966HP-E	46	46	97
MMD-AP0726HP-TR	44	44	97
MMD-AP0966HP-TR	46	46	97



# 1. SPECIFICATIONS

## Concealed Duct High Static Pressure Type

(50/60Hz)

Model name		MMD-	AP0726HP-E (TR)	AP0966HP-E (TR)	
Cooling capacity ...Note 1		(kW)	22.4	28.0	
Heating capacity ...Note 1		(kW)	25.0	31.5	
Electrical characteristics (factory setting)	Power supply		1 phase 50Hz 230V(220V-240V) / 1 phase 60Hz 220V		
	Running current (50/60Hz)		(A)	2.80 / 2.93	3.75 / 3.92
	Power consumption		(W)	540 / 540	790 / 790
	Starting current (50/60Hz)		(A)	7.80 / 8.15	7.80 / 8.15
Appearance		Zinc hot dipping steel plate			
Dimension	Height		(mm)	448	
	Width		(mm)	1400	
	Depth		(mm)	900	
Total weight		(kg)	97		
Heat exchanger		Finned tube			
Soundproof / Heat-insulating material		Polyethylene foam			
Fan unit	Fan		Centrifugal fan		
	Standard air flow (Med./Low)		(m3/h)	3,800 (3,200/2,500)	4,800 (4,200/3,500)
	Motor output		(kW)	1kW * 1pc	
	External static pressure (factory setting)		(Pa)	150	
	External static pressure range		(Pa)	50-83-117-150-183-217-250 (7 steps)	
Controller		Remote controller			
Air filter		Sold separately (TCB-LK2801DP-E)			
Drain pump		Sold separately (TCB-DP40DPE)			
Connecting pipe	Gas side		(mm)	Φ22.2	
	Liquid side		(mm)	Φ12.7	
	Drain port		(mm)	25 (Polyvinyl chloride tube)	
Sound pressure level (High/Med./Low) ...Note 2 (factory setting)		(dB(A))	44 / 40 / 36	46 / 42 / 38	
Sound power level (High/Med./Low)		(dB(A))	79 / 75 / 71	81 / 77 / 73	

Note 1 : The cooling capacities and electrical characteristics are measured under the conditions specified by JIS B 8615 based on the reference piping.

The reference piping consists of 5m of main piping and 2.5m of branch piping connected with 0 meter height.

Note 2 : The sound level are measured in an anechoic chamber in accordance with JIS B 8616.

Normally, the values measured in the actual operating environment become larger than the indicated values due to the effects of external sound.

Note : Rated conditions Cooling : Indoor air temperature 27°C DB/19°C WB, Outdoor air temperature 35°C DB

Heating : Indoor air temperature 20°C DB, Outdoor air temperature 7°C DB/6°C WB

# 2. FAN CHARACTERISTICS

AP072 type

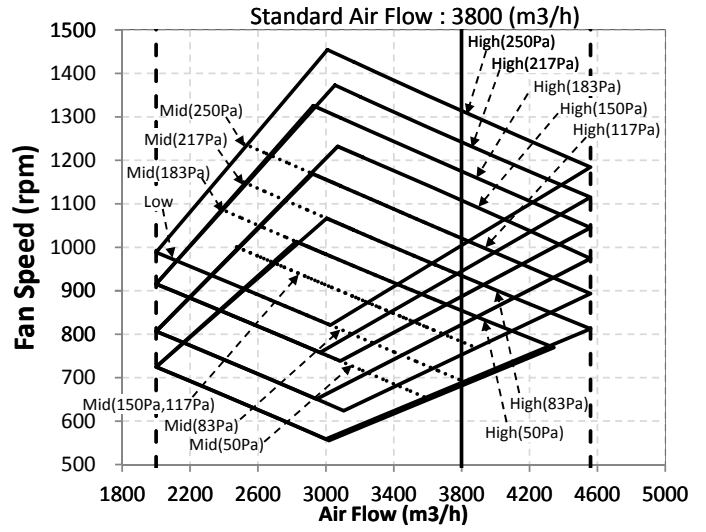
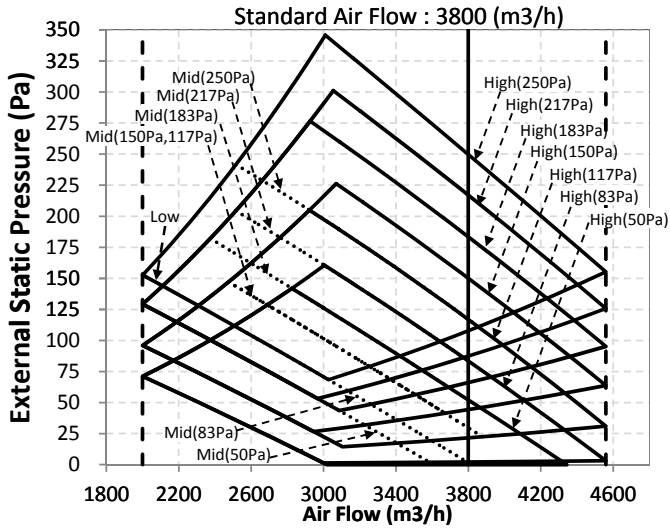

AP096 type

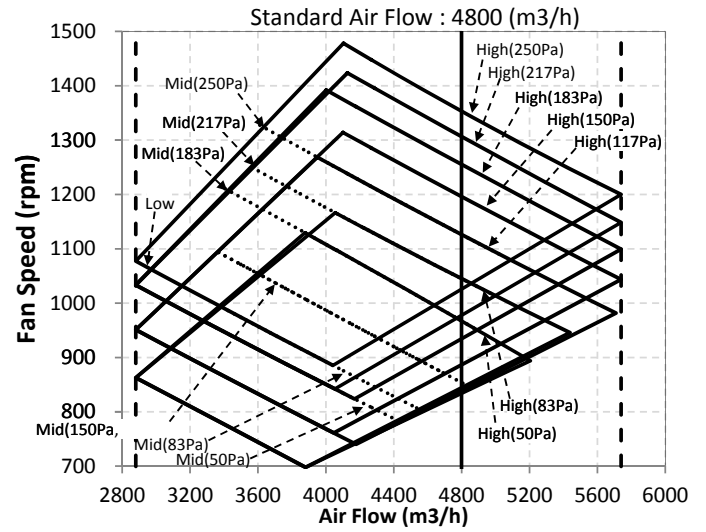
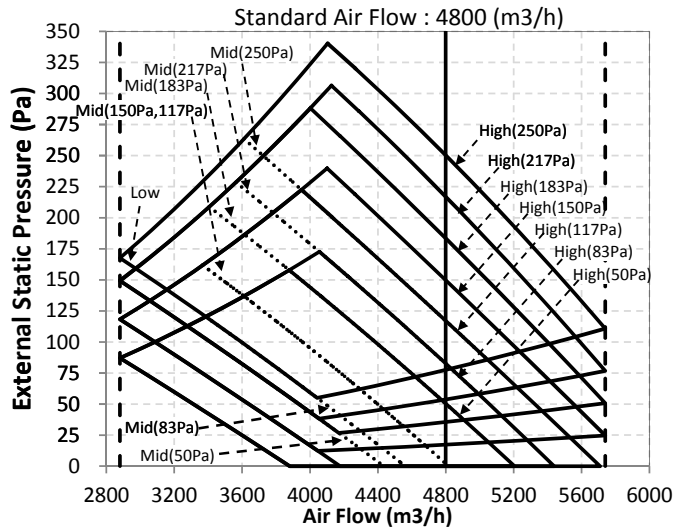

# 3. CONSTRUCTION VIEWS (EXTERNAL VIEWS)

Unit : mm

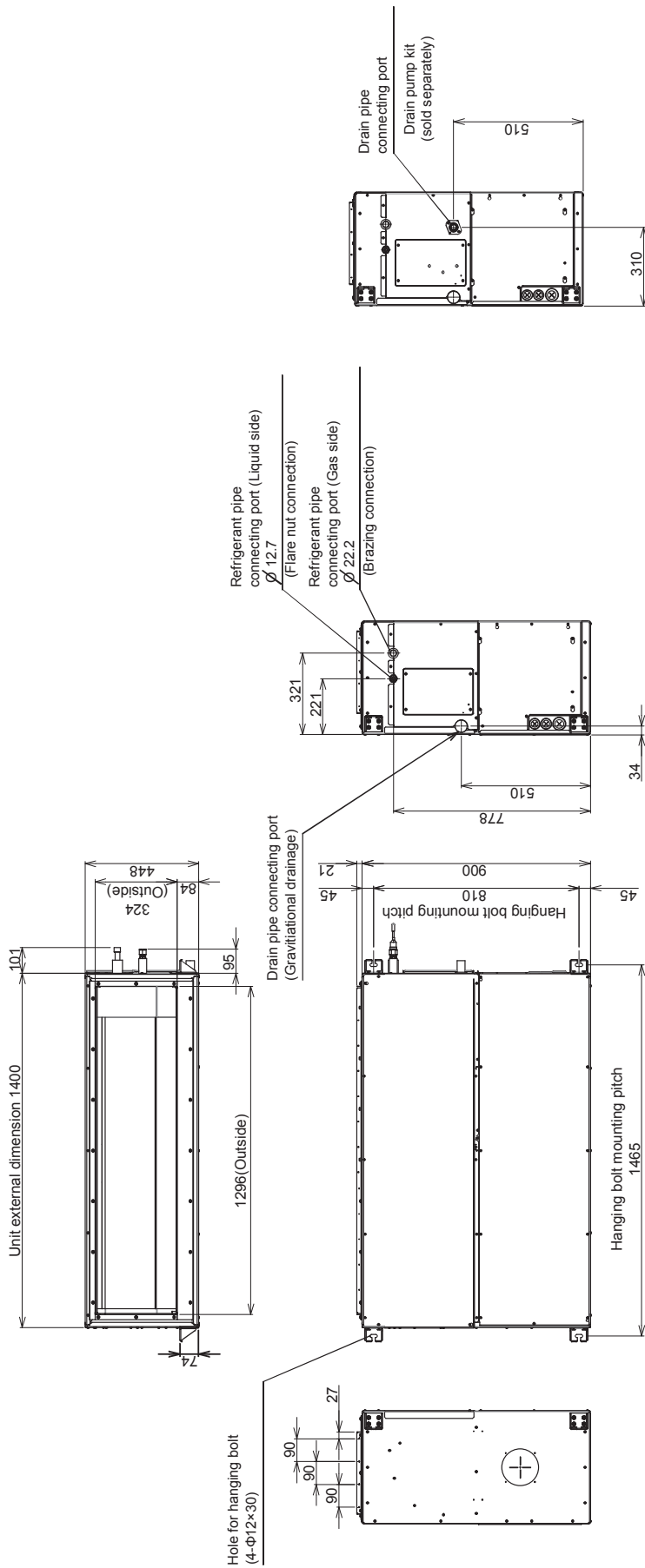

## Space required for installation and servicing

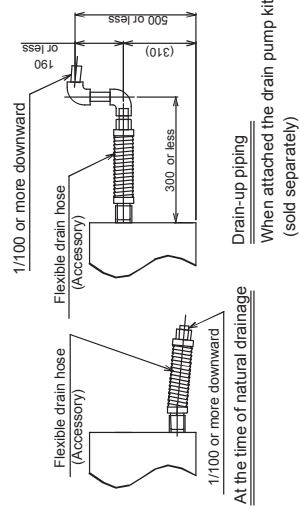
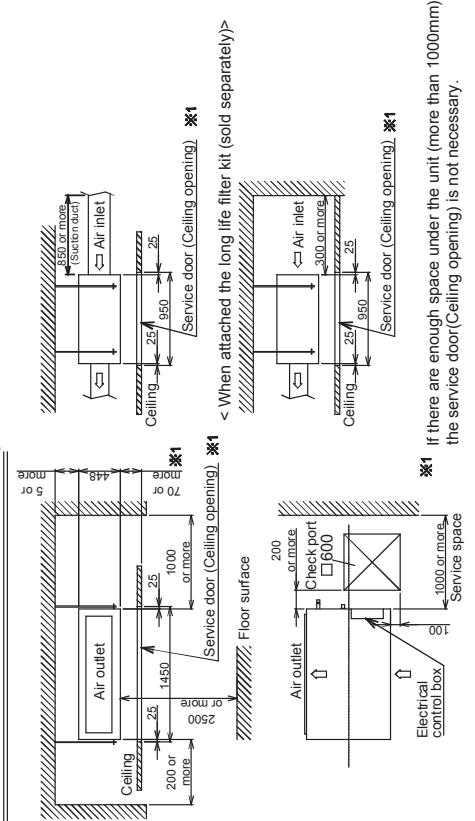

# Duct arrangement

Unit : mm

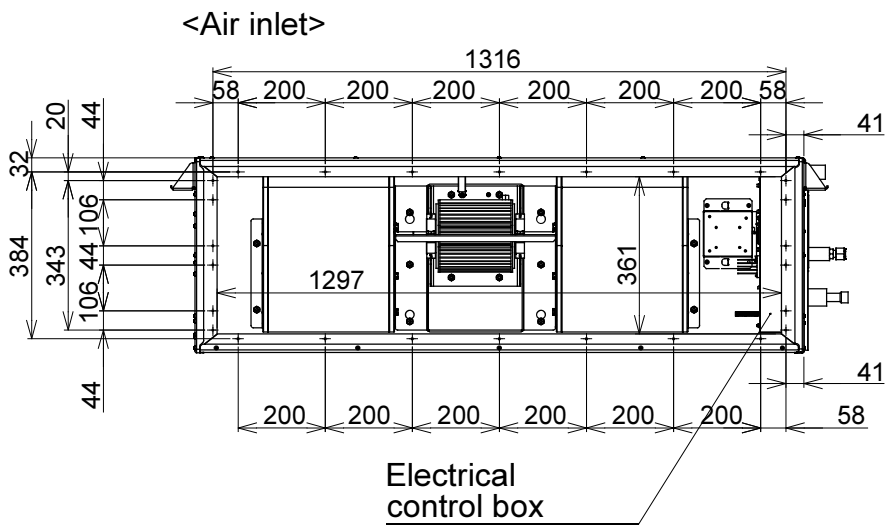
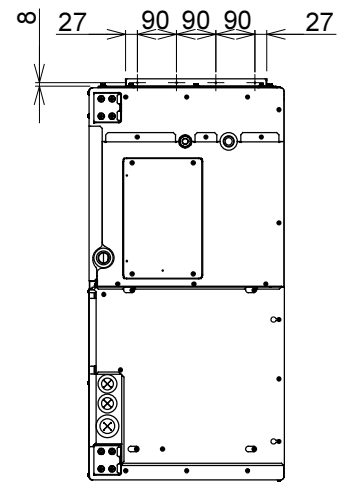
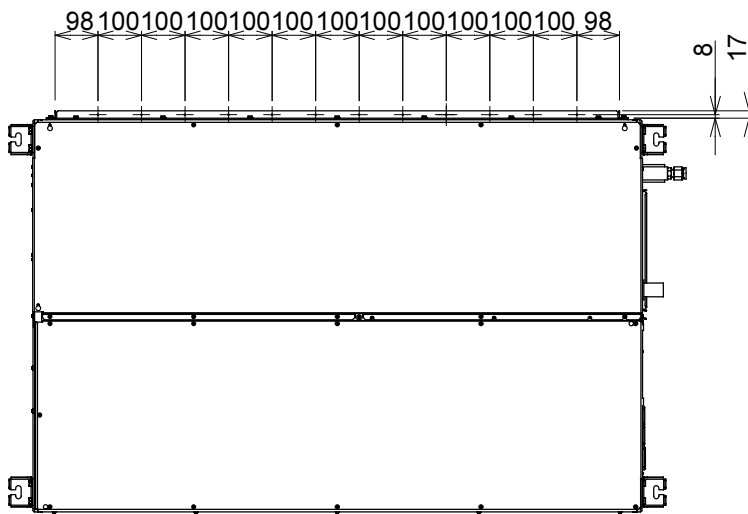
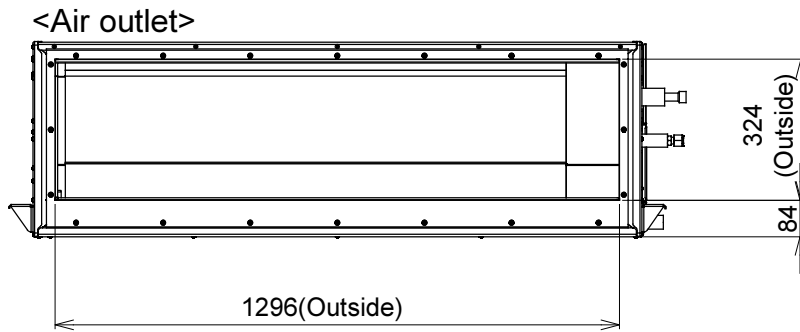

# 4. WIRING DIAGRAMS

## Concealed Duct High Static Pressure Type Wiring Diagram

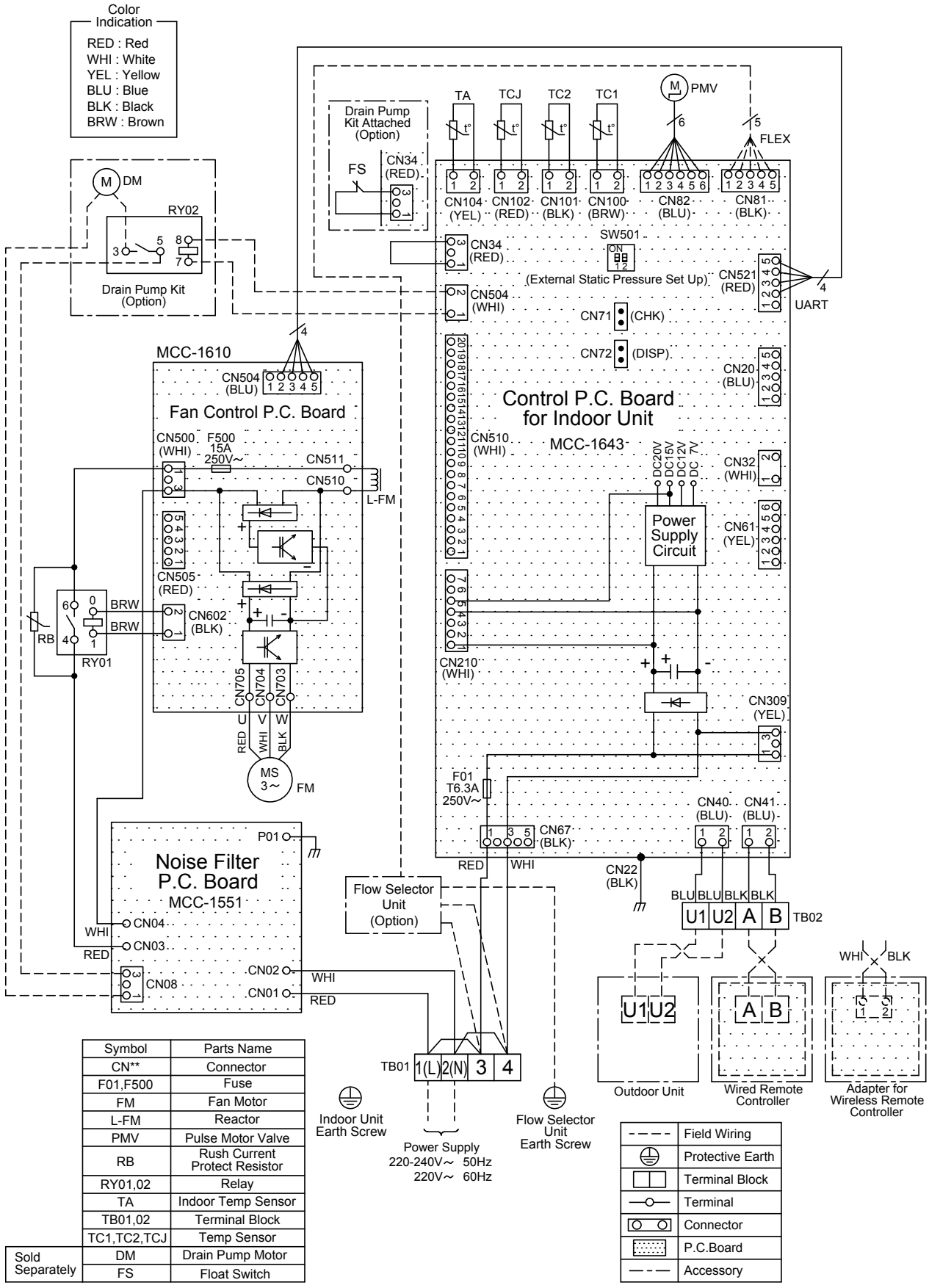

## 5. PARTS RATING

Model	MMD-AP	0726HP*	0966HP*
Fan motor		KF-340W1000-1	
Pulse motor		EFM-MD12TF-3	
Pulse motor valve		EFM-A0YGTF-2	
TA sensor		Lead wire length:218mm	
TC1 sensor		Ø4 size lead wire length:1000mm Vinyl tube (Blue)	
TC2 sensor		Ø6 size lead wire length:1000mm Vinyl tube (Black)	
TCJ sensor		Ø6 size lead wire length:1000mm Vinyl tube (Red)	
Drain pump (option)		PCD-4N230TF-4	
Float switch (option)		FS-1A-31-3	

# 6. REFRIGERANT CYCLE DIAGRAM

## Indoor unit

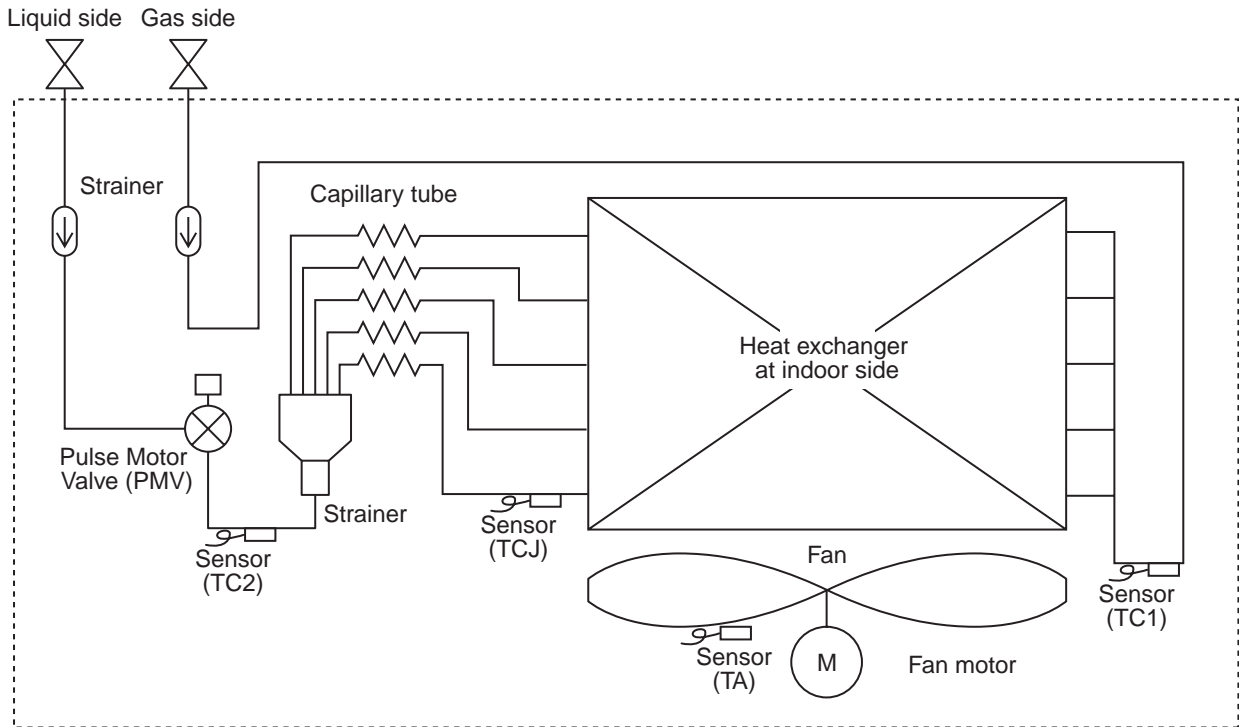

### Explanation of functional parts in indoor unit

Functional part name		Functional outline
Pulse Motor Valve	PMV	(Connector CN082 (6P): Blue) 1) Controls super heat in cooling operation 2) Controls subcool in heating operation 3) Recovers refrigerant oil in cooling operation 4) Recovers refrigerant oil in heating operation
Temp. Sensor	1.TA	(Connector CN104 (2P): Yellow) 1) Detects indoor suction temperature
	2.TC1	(Connector CN100 (3P): Brown) 1) Controls PMV super heat in cooling operation
	3.TC2	(Connector CN101 (2P): Black) 1) Controls PMV subcool in heating operation
	4.TCJ	(Connector CN102 (2P): Red) 1) Controls PMV super heat in cooling operation



# 7. CONTROL OUTLINE

## Indoor unit

### Control specifications



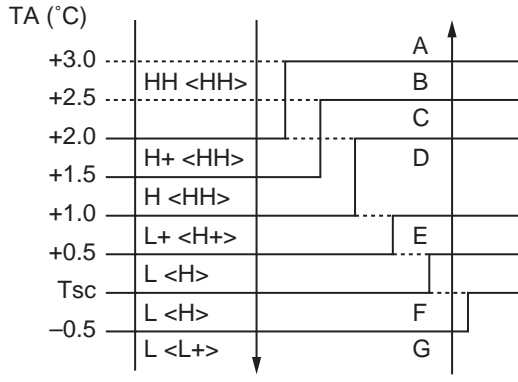
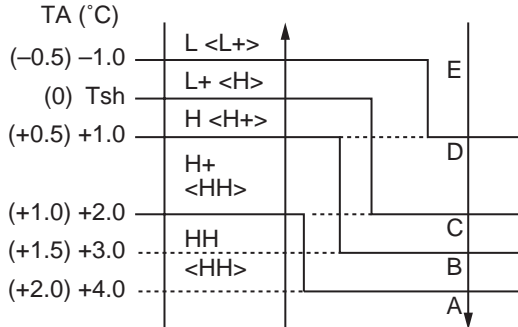



NO.	Item	Specification outline	Remarks																									
1	Upon power supply reset	<ol style="list-style-type: none"> <li>1. Identification of outdoor unit When the power supply is reset, the outdoor unit is identified, and control is redirected according to the identification result.</li> <li>2. Indoor fan speed and air flow direction control availability settings Settings such as indoor fan speed and air flow direction control availability are replaced on the basis of EEPROM data.</li> <li>3. If power supply reset is performed in troubles, the check code is cleared. If the abnormality persists after the Start / Stop button on the remote controller is pressed to resume operation, the check code is redisplayed on the remote controller.</li> </ol>																										
2	Operation selection	<ol style="list-style-type: none"> <li>1. The operation mode changes in response to an operation selection command issued via the remote controller.</li> </ol> <table border="1" style="margin-left: 40px;"> <thead> <tr> <th>Remote controller command</th> <th>Control outline</th> </tr> </thead> <tbody> <tr> <td>STOP</td> <td>Air conditioner shutdown</td> </tr> <tr> <td>FAN</td> <td>Fan operation</td> </tr> <tr> <td>COOL</td> <td>Cooling operation</td> </tr> <tr> <td>HEAT</td> <td>Heating operation</td> </tr> </tbody> </table>	Remote controller command	Control outline	STOP	Air conditioner shutdown	FAN	Fan operation	COOL	Cooling operation	HEAT	Heating operation	TS: Temperature setting TA: Room temperature															
Remote controller command	Control outline																											
STOP	Air conditioner shutdown																											
FAN	Fan operation																											
COOL	Cooling operation																											
HEAT	Heating operation																											
3	Room temp. control	<ol style="list-style-type: none"> <li>1. Adjustment range - remote controller temperature setting (°C)               <table border="1" style="margin-left: 40px;"> <thead> <tr> <th></th> <th>COOL</th> <th>HEAT</th> </tr> </thead> <tbody> <tr> <td>Wired type</td> <td>18~29</td> <td>18~29</td> </tr> <tr> <td>Wireless type</td> <td>18~30</td> <td>16~30</td> </tr> </tbody> </table> </li> <li>2. In heating operation, the temperature setting may be fine-tuned via the DN code "06".               <table border="1" style="margin-left: 40px;"> <thead> <tr> <th>SET DATA</th> <th>0</th> <th>2</th> <th>4</th> <th>6</th> </tr> </thead> <tbody> <tr> <td>Temperature setting adjustment</td> <td>+0 °C</td> <td>+2 °C</td> <td>+4 °C</td> <td>+6 °C</td> </tr> </tbody> </table> <p>Factory default</p> <table border="1" style="margin-left: 40px;"> <thead> <tr> <th>Model type</th> <th>SET DATA</th> </tr> </thead> <tbody> <tr> <td>Floor standing (standard, concealed, cabinet)</td> <td>0</td> </tr> <tr> <td>Other model</td> <td>2</td> </tr> </tbody> </table> </li> </ol>		COOL	HEAT	Wired type	18~29	18~29	Wireless type	18~30	16~30	SET DATA	0	2	4	6	Temperature setting adjustment	+0 °C	+2 °C	+4 °C	+6 °C	Model type	SET DATA	Floor standing (standard, concealed, cabinet)	0	Other model	2	Shift in heating suction temperature (not applicable to remote controller thermostat operation)
	COOL	HEAT																										
Wired type	18~29	18~29																										
Wireless type	18~30	16~30																										
SET DATA	0	2	4	6																								
Temperature setting adjustment	+0 °C	+2 °C	+4 °C	+6 °C																								
Model type	SET DATA																											
Floor standing (standard, concealed, cabinet)	0																											
Other model	2																											
4	Automatic capacity control	<ol style="list-style-type: none"> <li>1. The outdoor unit determines the operational capacities of indoor units according to the difference between TA and TS.</li> </ol> <div style="display: flex; justify-content: space-around; margin-left: 40px;"> <div style="text-align: center;"> <p><b>Cooling</b></p> </div> <div style="text-align: center;"> <p><b>Heating</b></p> </div> </div>	TS: Temperature setting TA: Room temperature																									





NO.	Item	Specification outline	Remarks
5	Fan speed control	<p>1. The fan operates in one of the four speed modes of "HIGH (HH)", "MED (H)", "LOW (L)" and "AUTO" on the basis of a command issued via the remote controller. (Concealed duct high static pressure type: HH only)</p> <p>2. In AUTO fan speed mode, the air speed changes according to the difference between TA and TS.</p> <p><b>&lt;Cooling&gt;</b></p>  <p>The graph shows TA (°C) on the y-axis from -0.5 to +3.0. A vertical line at Tsc separates cooling (left) and heating (right). Fan speed modes are shown in steps: HH &lt;HH&gt; (A), H+ &lt;HH&gt; (B), H &lt;HH&gt; (C), L+ &lt;H+&gt; (D), L &lt;H&gt; (E), and L &lt;L+&gt; (F). A dashed line at Tsc is labeled G.</p> <ul style="list-style-type: none"> <li>• Control is identical in remote controller thermo and body thermo operation. Speed modes shown in &lt; &gt; apply to cooling operation under AUTO air conditioner operation mode.</li> <li>• In AUTO fan speed mode, the fan speed remains the same for 3 minutes each time a speed change occurs. However, a speed change command issued via the remote controller can override this, and the fan speed changes accordingly.</li> <li>• At the beginning of cooling operation, a higher speed (steeper downward temperature gradient) is chosen.</li> <li>• As long as the temperature difference remains on a boundary line, the fan speed stays the same.</li> </ul> <p><b>&lt;Heating&gt;</b></p>  <p>The graph shows TA (°C) on the y-axis from -0.5 to +4.0. A vertical line at Tsh separates cooling (left) and heating (right). Fan speed modes are shown in steps: L &lt;L+&gt; (A), L+ &lt;H&gt; (B), H &lt;H+&gt; (C), H+ &lt;HH&gt; (D), HH &lt;HH&gt; (E), and HH &lt;HH&gt; (F). A dashed line at Tsh is labeled G.</p> <p>Figures inside ( ) applies to remote controller thermostat operation.  Figures outside ( ) applies to body thermostat operation.  Speed modes shown in &lt; &gt; apply to heating operation under AUTO air conditioner operation mode.</p> <ul style="list-style-type: none"> <li>• In AUTO fan speed mode, the fan speed remains the same for 1 minute each time a speed change occurs. However, a speed change command issued via the remote controller can override this, and the fan speed changes accordingly.</li> <li>• At the beginning of heating operation, a higher speed (steeper upward temperature gradient) is chosen.</li> <li>• As long as the temperature difference remains on a boundary line, the fan speed stays the same.</li> <li>• When TC2 ≥ 60 °C, the fan speed is raised by one step.</li> </ul> <p>3. If the air conditioner goes thermostat OFF during heating operation, the fan speed drops down to LL (breeze).</p>	<p>HH &gt; H+ &gt; H &gt; L+ &gt; L &gt; UL or LL</p> <p>DN code "32"  "0000": Body thermostat  "0001": Remote controller thermostat</p> <p>TC2: Indoor heat exchanger sensor temperature</p> <p>"HEATING STANDBY"  displayed</p>

NO.	Item	Specification outline	Remarks															
6	Cold air discharge prevention control	<p>1. In heating operation, the upper limit of the fan tap is set according to the lower of whichever is the higher between TC2 sensor and TCJ sensor temperatures, on the one hand, and TC1 sensor temperature, on the other.</p> <ul style="list-style-type: none"> <li>• If the fan continuously operates in zone B for 6 minutes, it automatically moves into zone C.</li> <li>• During defrosting, the control point is shifted by +6 °C.</li> </ul> <p>A zone: OFF  B zone: 26°C or above and below 28°C breeze  C zone: 28°C or above and below 30°C Low  D zone: 30°C or above and below 32°C Medium  E zone: High</p>	<p>TCJ: Indoor heat exchanger sensor temperature</p> <ul style="list-style-type: none"> <li>• In zones D and E, priority is given to the remote controller fan speed setting.</li> <li>• In zone A, "HEATING STANDBY" is displayed.</li> </ul>															
7	Freeze prevention control (low temp. release)	<p>1. During cooling, the air conditioner is operated in the manner described below according to the temperature readings of the TC1, TC2 and TCJ sensors.</p> <ul style="list-style-type: none"> <li>• If zone J operation is detected for 5 minutes, the air conditioner is forced into thermostat OFF.</li> <li>• In zone K, the timer is put on pause, with the current timer count retained.</li> <li>• If zone I operation is detected, the timer count is cleared, and the air conditioner returns to normal operation.</li> <li>• If continuous zone J operation forces the air conditioner into thermostat OFF, the indoor fan is operated in breeze mode until it moves into zone I. The control is terminated under the following conditions:</li> </ul> <p>Termination conditions</p> <p>1) <math>TC1 \geq 12\text{ °C}</math>, <math>TC2 \geq 12\text{ °C}</math>, and <math>TCJ \geq 12\text{ °C}</math></p> <table border="1" data-bbox="751 1196 1066 1290"> <thead> <tr> <th></th> <th>TC1</th> <th>TC2, TCJ</th> </tr> </thead> <tbody> <tr> <td>P1</td> <td>10°C (5°C)</td> <td>-10°C</td> </tr> <tr> <td>Q1</td> <td>0°C</td> <td>-14°C</td> </tr> </tbody> </table> <p>2) Passage of 20 minutes after stoppage</p> <p>2. During cooling, the air conditioner is operated in the manner described below according to the temperature readings of the TC2 and TCJ sensors.</p> <ul style="list-style-type: none"> <li>• If zone M operation is detected for 45 minutes, the air conditioner is forced into thermo OFF.</li> <li>• In zone N, the timer is put on pause, with the current timer count retained.</li> <li>• When the air conditioner goes back into zone M, timer count is resumed from the retained value.</li> </ul> <table border="1" data-bbox="751 1664 938 1758"> <thead> <tr> <th></th> <th>TC2, TCJ</th> </tr> </thead> <tbody> <tr> <td>P2</td> <td>5</td> </tr> <tr> <td>Q2</td> <td>-2.0</td> </tr> </tbody> </table> <ul style="list-style-type: none"> <li>• If zone L operation is detected, the timer count is cleared, and the air conditioner returns to normal operation.</li> </ul> <p>Reset conditions</p> <p>1) <math>TC1 \geq 12\text{ °C}</math>, <math>TC2 \geq 12\text{ °C}</math> and <math>TCJ \geq 12\text{ °C}</math></p> <p>2) After 20 minutes elapsed from the stop.</p>		TC1	TC2, TCJ	P1	10°C (5°C)	-10°C	Q1	0°C	-14°C		TC2, TCJ	P2	5	Q2	-2.0	<p>TC1: Indoor heat exchanger sensor temperature</p> <p>* With models without TC2, TC2 is not part of the control parameters.</p>
	TC1	TC2, TCJ																
P1	10°C (5°C)	-10°C																
Q1	0°C	-14°C																
	TC2, TCJ																	
P2	5																	
Q2	-2.0																	

NO.	Item	Specification outline	Remarks
8	Cooling oil (refrigerant) recovery control	<p>While the outdoor unit is recovering cooling oil (refrigerant), the indoor units perform the following control tasks: [common for operational (cooling thermostat ON / thermostat OFF / FAN), as well as nonoperational indoor units]</p> <ol style="list-style-type: none"> <li>1) Open the indoor PMV to a certain degree.</li> <li>2) Engage in recovery control for a specified period of time and return to normal cooling operation at the end of this period upon terminating the control.</li> <li>3) Operate the drain pump throughout the recovery control period and for about 1 minute after it.</li> </ol>	<ul style="list-style-type: none"> <li>• Recovery operation normally takes place roughly every 2 hours.</li> <li>• The opening position of the indoor PMV depending on the type and capacity of the indoor unit.</li> </ul>
9	Heating refrigerant (oil) recovery control	<p>While the outdoor unit is recovering heating refrigerant (oil), the indoor units perform the following control tasks:</p> <ol style="list-style-type: none"> <li>1) Open the indoor PMV to a certain degree.</li> <li>2) Control the indoor fan according to the operation mode. [Indoor units operating in heating thermo ON / OFF state] Let the indoor fan continue operating, but turn it off if the temperature of the indoor heat exchanger drops. [Indoor units operating in FAN mode] Turn off the indoor fan and display “HEATING STANDBY  ” on the remote controller. [Non-operational indoor units] Keep the indoor fan turned off.</li> <li>3) Terminate the recovery operation depending on the TC2 temperature reading. The timing of termination is determined by each indoor unit.</li> <li>4) Operate the indoor fan and drain pump for about 1 minute after the termination of the recovery operation. (Applicable to compact 4-way cassette type and 1-way cassette type)</li> </ol>	<ul style="list-style-type: none"> <li>• Recovery operation normally takes place roughly every hour.</li> <li>• The opening position of the indoor PMV depending on the type and capacity of the indoor unit.</li> </ul>
10	Defrosting control	<p>While the outdoor unit is engaged in defrosting control, the indoor units perform the following control tasks:</p> <ol style="list-style-type: none"> <li>1) Open the indoor PMV to a certain degree.</li> <li>2) Control the indoor fan according to the operation mode. [Indoor units operating in heating thermo ON / OFF state] Let the indoor fan continue operating for a while, but turn it off as the temperature of the indoor heat exchanger drops. [Indoor units operating in FAN mode] Let the indoor fan continue operating. [Non-operational indoor units] Keep the indoor fan turned off.</li> <li>3) As defrosting control comes to an end, it gives way to heating refrigerant (oil) recovery control. (For control details, see “9. Heating refrigerant (oil) recovery control” above.)</li> </ol>	<ul style="list-style-type: none"> <li>• For defrosting commencement conditions, see 5 Control Outline “7. Defrosting control (reverse defrosting method)” in SMMS-e Outdoor Unit Service Manual SVM-15067 above.</li> <li>• The opening position of the indoor PMV depending on the type and capacity of the indoor unit.</li> </ul>
11	Short intermittent operation compensation control	<ol style="list-style-type: none"> <li>1. For 5 minutes after startup, the system is forced to continue operating even if it reaches the thermo OFF region.</li> <li>2. However, priority is given to cooling / heating selection, operation standby, and protective control, so that there is no overriding of thermo OFF in these cases.</li> </ol>	
12	Drain pump control	<ol style="list-style-type: none"> <li>1. During cooling (including DRY operation), the drain pump is operated at all times.</li> <li>2. If the float switch is activated while the drain pump is in operation, the drain pump continues operating, with the relevant check code displayed.</li> <li>3. If the float switch is activated while the drain pump is turned off, thermo OFF is forced on the air conditioner, with the drain pump put into operation. If the float switch continues to be activated for about 5 minutes, the drain pump is turned off, with the relevant check code displayed.</li> </ol>	<p>Check code [P10] Drain pump kit TCB-DP40DE (Sold separately)</p>
13	Elimination of residual heat	<ol style="list-style-type: none"> <li>1. When the air conditioner is turned off after engaging in heating operation, the indoor fan is operated for about 30 seconds in “breeze” mode.</li> </ol>	

NO.	Item	Specification outline	Remarks																																																		
14	Filter sign display (not applicable to wireless type)	<p>1. The indoor fan's cumulative hours of operation are counted, and when these exceed the prescribed value (2500H), a filter replacement signal is sent to the remote controller to display a filter sign on it.</p> <p>2. When a filter reset signal is received from the remote controller, the timer measuring cumulative hours is cleared. If the prescribed hours have been exceeded, the hours count is reset, with the sign on the remote controller display erased.</p> <table border="1" data-bbox="422 436 941 474"> <tr> <td>Filter service life</td> <td>2500H</td> </tr> </table>	Filter service life	2500H	"FILTER  " displayed																																																
Filter service life	2500H																																																				
15	Operation standby Heating standby	<p>&lt;Operation standby&gt; ..... Displayed on remote controller</p> <ol style="list-style-type: none"> <li>When any of the DN codes listed below is displayed <ul style="list-style-type: none"> <li>"P05" - Detection of an open phase in the power supply wiring</li> <li>"P10" - Detection of indoor flooding in at least one indoor unit</li> <li>"L30" - Detection of an interlock alarm in at least one indoor unit</li> </ul> </li> <li>Forced thermostat OFF <ul style="list-style-type: none"> <li>"COOL / DRY" operation is unavailable because at least one indoor unit is operating in "HEAT" mode.</li> <li>"HEAT" operation is unavailable because at least one indoor unit is operating in "COOL / DRY" mode under priority cooling setting (bit 1 of SW11 on outdoor I/ F P.C. board ON).</li> </ul> </li> <li>All indoor units not able to engage in any of the above operations stand by in thermostat OFF state.</li> <li>The indoor fan has been turned off because the system is engaged in a heat refrigerant (oil) recovery operation.</li> </ol> <p>&lt;Heating standby&gt; ..... Displayed on remote controller</p> <ol style="list-style-type: none"> <li>Normal thermostat OFF <ul style="list-style-type: none"> <li>During heating, the indoor unit goes thermostat OFF as the heating temperature setting is reached.</li> </ul> </li> <li>During heating, the fan rotates at a breeze speed (UL or lower) or remains stationary to prevent cold air from being discharged (including defrosting operation).</li> <li>Forced thermostat OFF <ul style="list-style-type: none"> <li>"HEAT" operation is unavailable because at least one indoor unit is operating in "COOL / DRY" mode under priority cooling setting (bit 1 of SW11 on outdoor I/ F P.C. board ON).</li> </ul> </li> </ol>	<ul style="list-style-type: none"> <li>"OPERATION STANDBY  " displayed No display provided on wireless remote controller</li> <li>"HEATING STANDBY  " displayed</li> </ul>																																																		
16	Selection of central control mode	<p>1. The range of operations that can be performed via an indoor unit remote controller can be determined through the setting of the central controller.</p> <p>2. Setting details</p> <p>TCC-Link central control</p> <table border="1" data-bbox="406 1456 1177 1720"> <thead> <tr> <th rowspan="2">Operation via TCCLink central control</th> <th colspan="6">Operation on RBC-AMT32E</th> <th rowspan="2">RBC-AMT32E display</th> </tr> <tr> <th>Start / stop selection</th> <th>Operation mode selection</th> <th>Timer setting</th> <th>Temperature setting</th> <th>Fan speed setting</th> <th>Air flow direction setting</th> </tr> </thead> <tbody> <tr> <td>Individual</td> <td>○</td> <td>○</td> <td>○</td> <td>○</td> <td>○</td> <td>○</td> <td rowspan="5">"CENTRAL CONTROL IN PROGRESS" </td> </tr> <tr> <td>Central 1</td> <td>×</td> <td>○</td> <td>×</td> <td>○</td> <td>○</td> <td>○</td> </tr> <tr> <td>Central 2</td> <td>×</td> <td>×</td> <td>×</td> <td>×</td> <td>○</td> <td>○</td> </tr> <tr> <td>Central 3</td> <td>○</td> <td>×</td> <td>○</td> <td>×</td> <td>○</td> <td>○</td> </tr> <tr> <td>Central 4</td> <td>○</td> <td>×</td> <td>○</td> <td>○</td> <td>○</td> <td>○</td> </tr> </tbody> </table> <p>(○ : Accessible    × : Inaccessible)</p>	Operation via TCCLink central control	Operation on RBC-AMT32E						RBC-AMT32E display	Start / stop selection	Operation mode selection	Timer setting	Temperature setting	Fan speed setting	Air flow direction setting	Individual	○	○	○	○	○	○	"CENTRAL CONTROL IN PROGRESS" 	Central 1	×	○	×	○	○	○	Central 2	×	×	×	×	○	○	Central 3	○	×	○	×	○	○	Central 4	○	×	○	○	○	○	<ul style="list-style-type: none"> <li>In the case of a wired remote controller, "CENTRAL CONTROL IN PROGRESS  " is displayed (lit up) while in central control mode.</li> <li>The display blinks when a control function inaccessible to a remote controller is chosen.</li> <li>A wireless remote controller has the same set of control functions, although there is no display. When a control operation is performed via a wireless remote controller while in central control mode, a peep sound alert (5 times) is provided.</li> </ul>
Operation via TCCLink central control	Operation on RBC-AMT32E						RBC-AMT32E display																																														
	Start / stop selection	Operation mode selection	Timer setting	Temperature setting	Fan speed setting	Air flow direction setting																																															
Individual	○	○	○	○	○	○	"CENTRAL CONTROL IN PROGRESS" 																																														
Central 1	×	○	×	○	○	○																																															
Central 2	×	×	×	×	○	○																																															
Central 3	○	×	○	×	○	○																																															
Central 4	○	×	○	○	○	○																																															

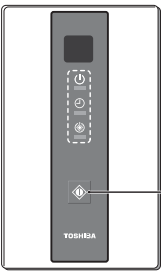
NO.	Item	Specification outline	Remarks
17	DC motor	1) When the fan operation has started, positioning of the stator and the rotor are performed. (Moves slightly with tap sound) 2) The motor operates according to the command from the indoor controller.  <b>Notes)</b> <ul style="list-style-type: none"> <li>• When a fan lock is found, the air conditioner stops, and an check code is displayed.</li> <li>• If static pressure of the used duct does not match with the setup value of static pressure, which was decided in the static pressure setting code No.[5D], the air conditioner may stop or check code may be displayed.</li> </ul>	Check code "P12"
18	Power saving mode	1. Push the  button on the remote controller 2. The "  " segment lights up on the wired remote controller display. 3. The requirement capacity ratio is limited to approximately 75 %. 4. If the power saving operation is enabled, the settings are retained when the operation is stopped, when the mode is changed, or when the power is reset. The power saving operation will be enabled the next time the operation starts.	The power saving operation cannot be set by the wireless remote controller or wired remote controller of AMT31E or older.
19	Frequency fixed operation (Test run)	<p><b>&lt;In case of wired remote controller&gt;</b></p> 1) When pushing [CHK] button for 4 seconds or more, [TEST] is displayed on the display screen and the mode enters in Test run mode. 2) Push [ON/OFF] button. 3) Using [MODE] button, set the mode to [COOL] or [HEAT]. <ul style="list-style-type: none"> <li>• Do not use other mode than [COOL]/[HEAT] mode.</li> <li>• During test run operation, the temperature cannot be adjusted.</li> <li>• Check code is detected as usual.</li> <li>• A frequency fixed operation is performed.</li> </ul> 4) After the test run, push [ON/OFF] button to stop the operation. (Display in the display part is same as the procedure in Item 1.) 5) Push [CHK] button to clear the test run mode. ([TEST] display in the display part disappears and the status returns to the normal stop status.)	Command frequency is approximately [S7]
		<p><b>&lt;In case of wireless remote controller&gt;</b></p> 1) When TEMPORARY button is pushed for 10 seconds or more, "Pi!" sound is heard and the operation changes to test run. After approx. 3 minutes, a cooling operation starts forcedly. Check cool air starts blowing. If the operation does not start, check wiring again. 2) To stop a test operation, push TEMPORARY button once again (Approx. 1 second). Check wiring / piping of the indoor and outdoor units in test run.	
		 <p style="text-align: center;">TEMPORARY button</p>	

# 8. APPLIED CONTROL AND FUNCTIONS (INCLUDING CIRCUIT CONFIGURATION)

## 8-1. Indoor controller block diagram

### 8-1-1. In Case of Connection of Wired (Simple) Remote Controller

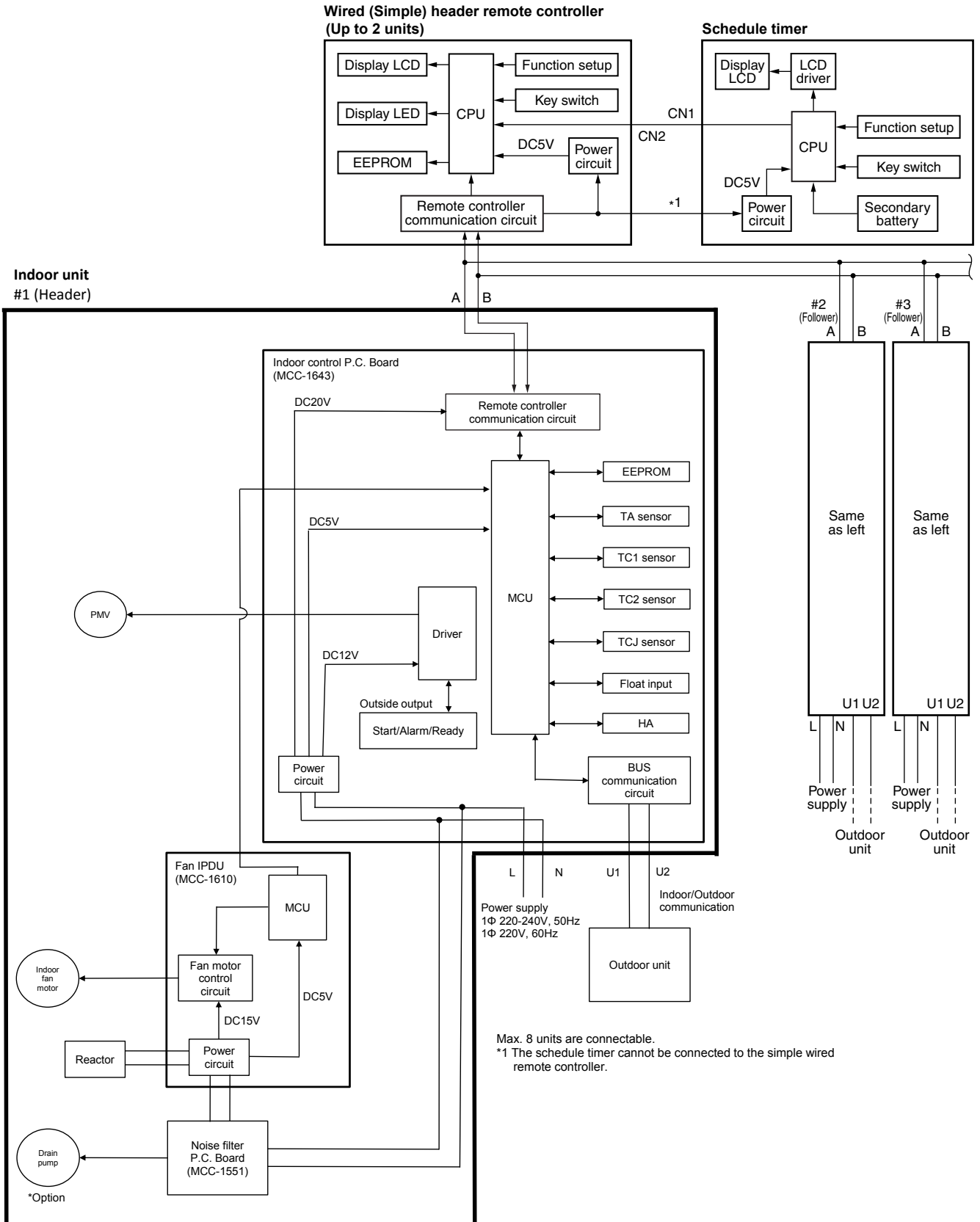

## 8-1-2. In Case of Connection of Wireless Remote Controller

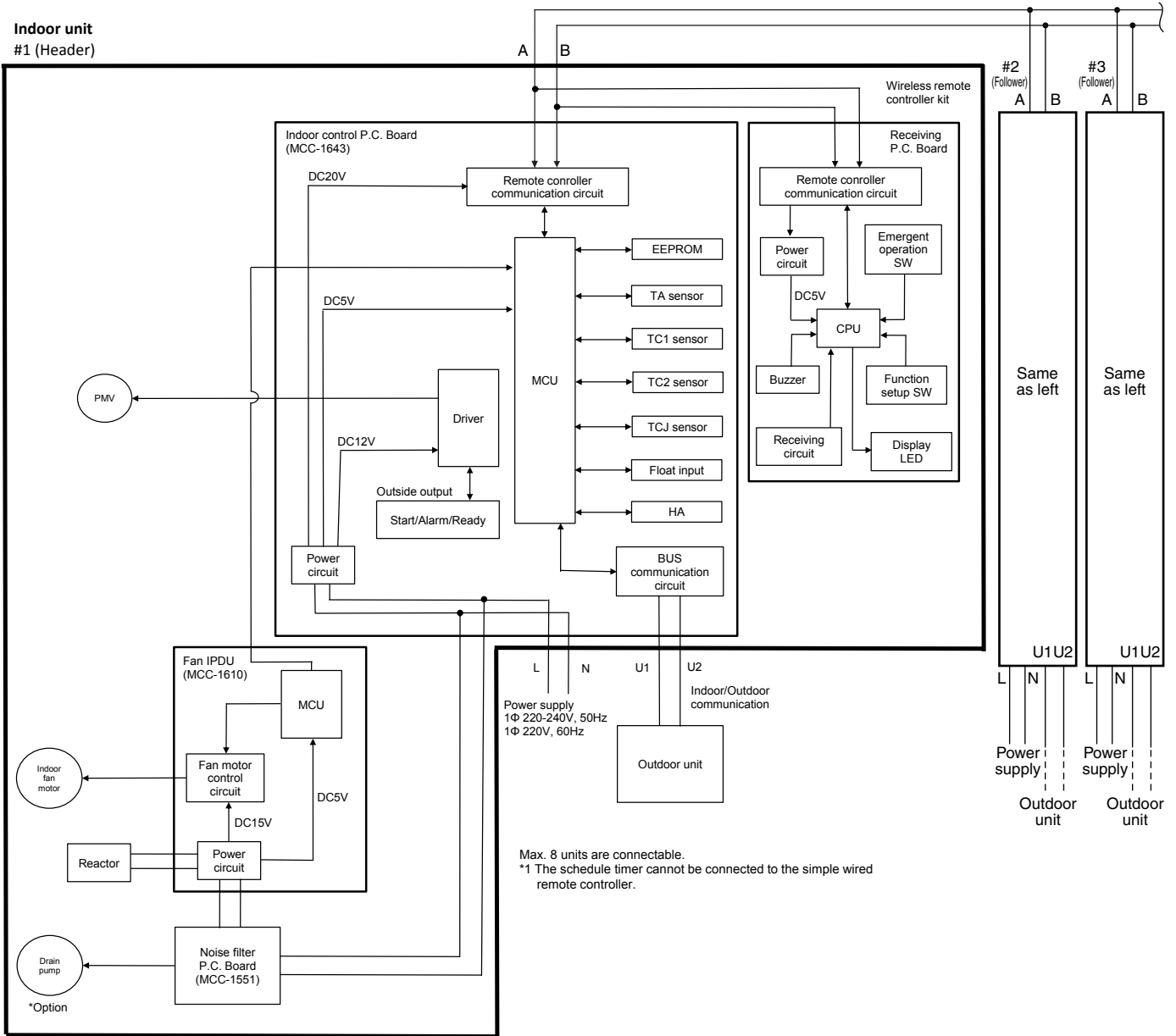

### 8-1-3. Connection of Both Wired (Simple) Remote Controller and Wireless Remote Controller

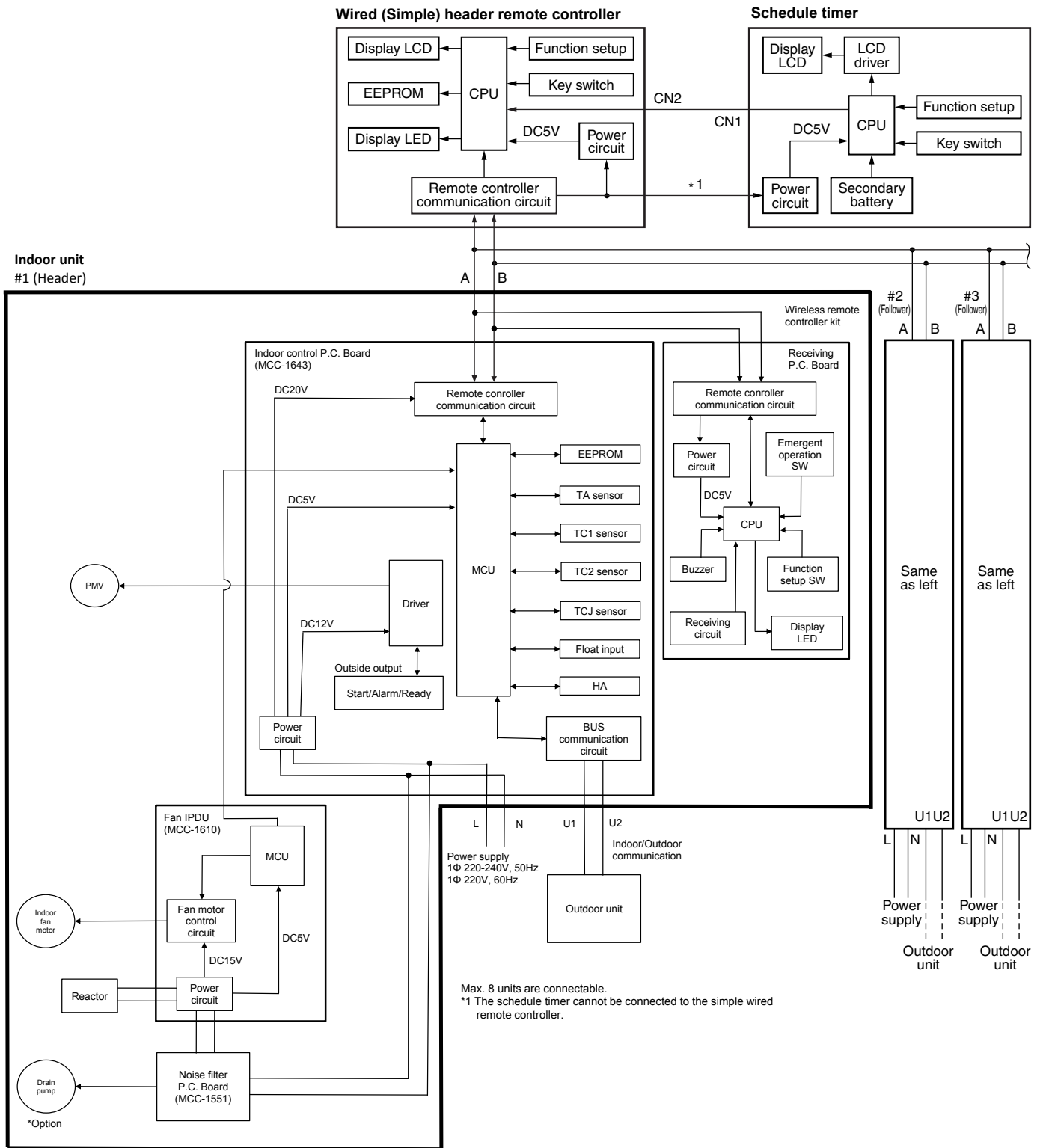

Max. 8 units are connectable.

\*1 The schedule timer cannot be connected to the simple wired remote controller.



**8-2. Indoor Circuit Design Board  
MCC-1643**

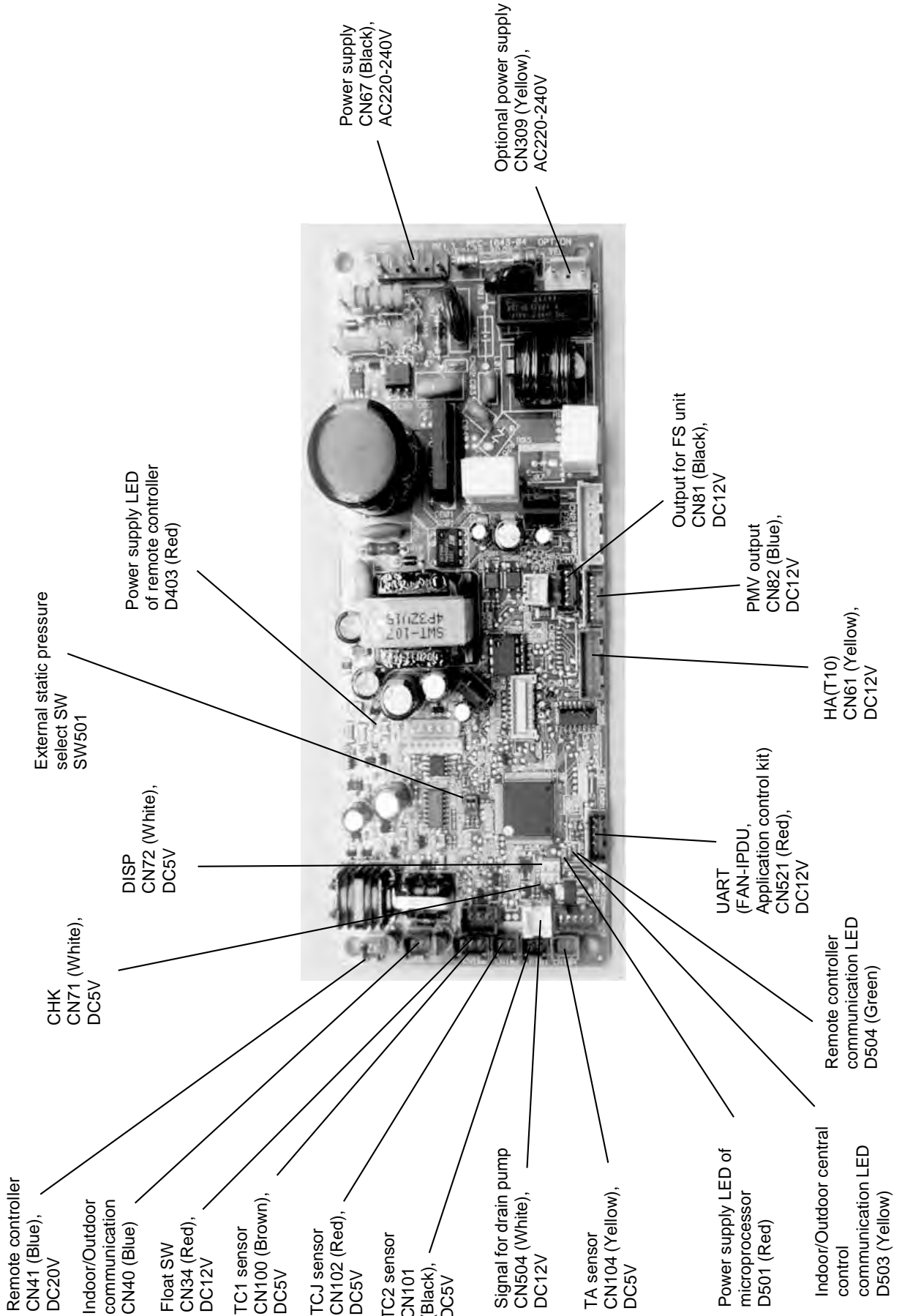

## 8-2-1. Optional connector specifications of Indoor Circuit Design Board

Function	Connector No.	Pin No.	Specification	Remarks
Ventilation output	CN32	1	DC12V	Setting at shipment: Interlock of ON by indoor unit operation, with OFF by stop operation * The single operation setting by FAN button on the remote controller is performed on the remote controller (DN [31] = 0000 → 0001)
		2	Output (Open collector)	
HA	CN61	1	ON/OFF input	HA ON/OFF input (J01: YES/NO=Pulse (At shipment from factory) /Static input selection)
		2	0V	
		3	Remote controller prohibited input	Permission/Prohibition of remote controller operation stop is performed by input.
		4	Operation output (Open collector)	
		5	DC12V	Operation ON (Answer back of HA)
		6	Warning output (Open collector)	Warning output ON
CHK Operation check	CN71	1		This check is used to check indoor operation. (Performs operation of indoor fan "H", Louver horizontal and Drain pump ON without communication with outdoor and remote controller)
		2	0V	
DISP Exhibition mode	CN72	1		Communication is available by indoor unit and remote controller only.
		2	0V	
UART (FAN-IPDU, Option control kit)	CN521	1	12V	Connected FAN-IPDU (MCC-1610) Connected Application control kit (TCB-PCUC1E)
		2	5V	
		3	Transmission	
		4	Receive	
		5	0V	

## 8-2-2. Fan IPDU P.C. Board (MCC-1610)

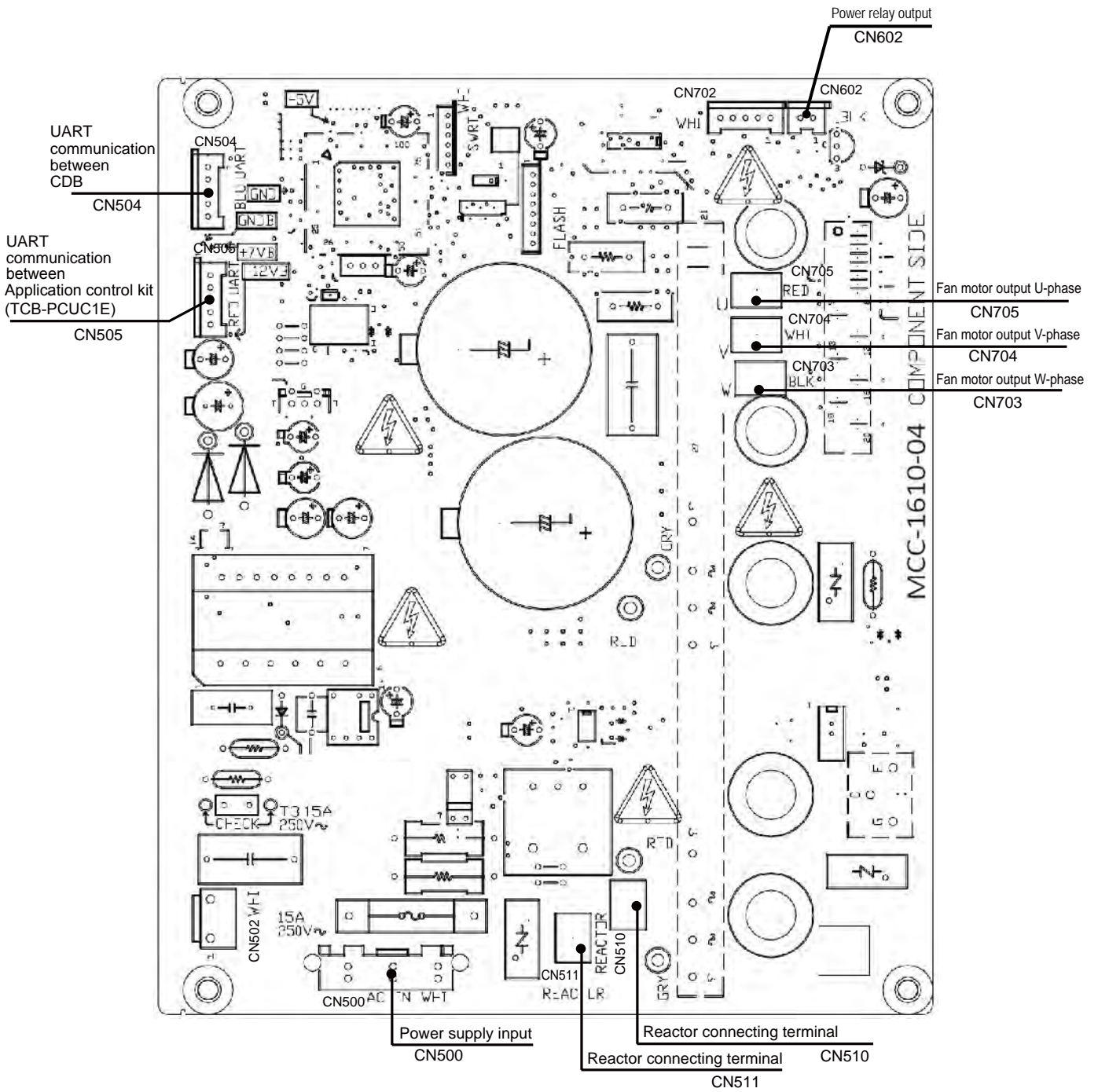

8-2-3. Noise filter (MCC-1551)

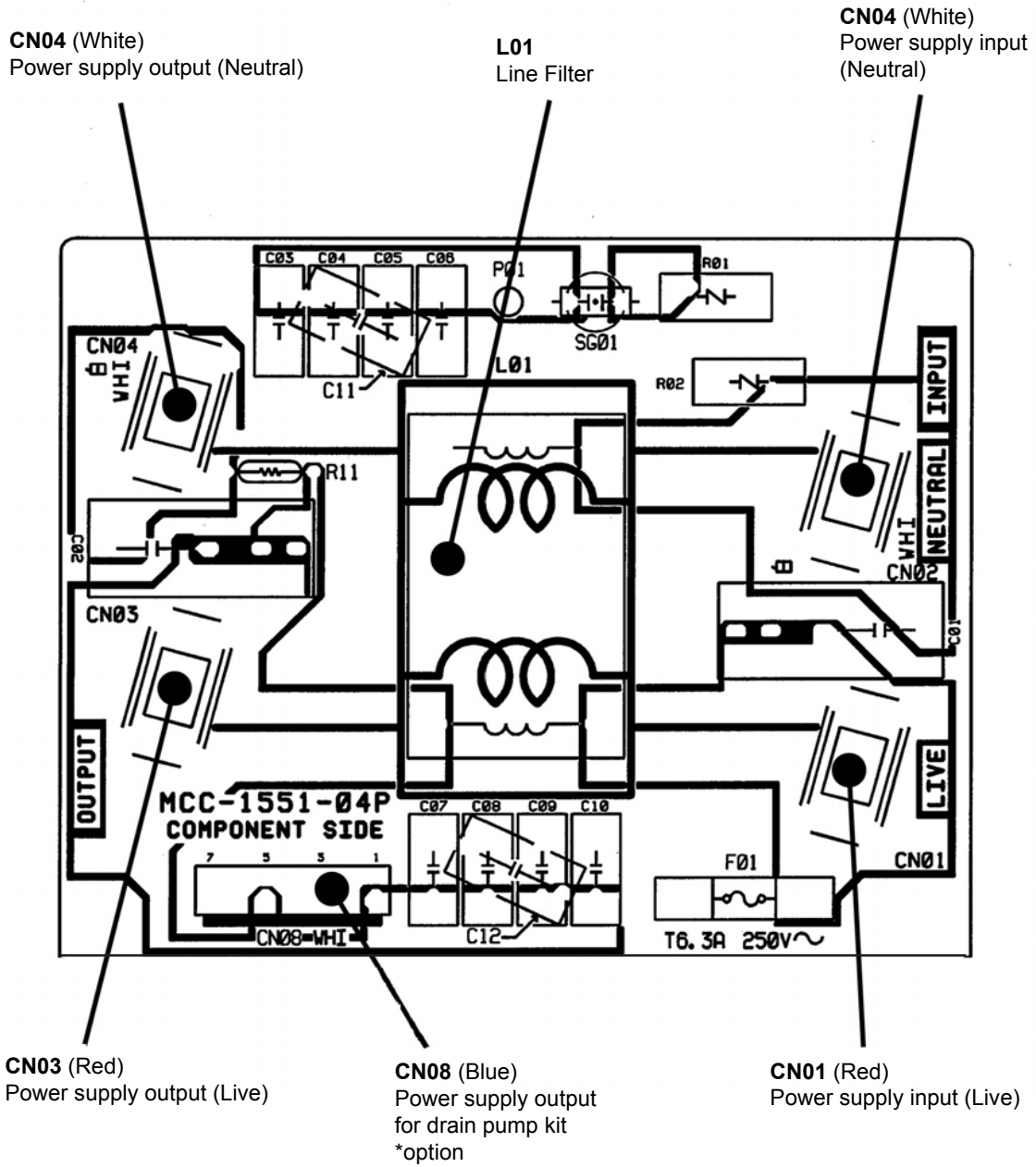

### 8-3. Test operation of indoor unit

#### ▼ Check function for operation of indoor unit (Functions at indoor unit side)

This function is provided to check the operation of the indoor unit singly without communication with the remote controller or the outdoor unit. This function can be used regardless of operation or stop of the system. However, if using this function for a long time, a trouble of the equipment may be caused. Limit using this function within several minutes.

#### [How to operate]

- 1) Short-circuit CHK pin (CN71 on the indoor P.C. board) (MCC-1643).  
The operation mode differs according to the indoor unit status in that time.  
Normal time: Both float SW and fan motor are normal.  
Abnormal time: Either one of float SW or fan motor is abnormal.
- 2) Restricted to the normal time, if short-circuiting DISP pin (CN72 on the indoor P.C. board (MCC-1643)) in addition to short-circuit of CHK pin (CN71 on the indoor P.C. board), the minimum opening degree (30 pls) can be set to the indoor PMV only.  
When open DISP pin, the maximum opening degree (1500 pls) can be obtained again.

#### [How to clear]

Open CHK pin. While the system is operating, it stops once but automatically returns to operation after several minutes.

	Short-circuit of CHK pin		
	Normal time		Abnormal time
	DISP pin open	DISP pin short circuit	
Fan motor	(H)	(H)	Stop
Indoor PMV (*)	Max. opening degree (1500 pls)	Min. opening degree (30 pls)	Min. opening degree (30 pls)
Drain pump	ON	ON	ON
Communication	All ignored	All ignored	All ignored
P.C. board LED (MCC-1643)	Lights	Lights	Flashes

- To exchange the indoor PMV coil, set the indoor PMV to Max. opening degree.
- For the detailed positions of CHK pin (CN71 on indoor P.C. board) and DISP pin (CN72 on indoor P.C. board), refer to the indoor P.C. board (MCC-1643).

## 8-4. Method to set indoor unit function DN code

(When performing this task, be sure to use a wired remote controller.)

<Procedure> To be performed only when system at rest

- 1 Push the  +  +  buttons simultaneously and hold for at least 4 seconds.

The unit No. displayed first is the address of the header indoor unit in group control.

Then the fan of the selected indoor unit move.

- 2 Each time the  button (left side of the button) is pressed, one of the indoor unit Nos. under group control is displayed in turn. Then the fan of the selected indoor unit move.

- 3 Use the  button to select the CODE No. (DN code) of the desired function.

- 4 Use the  button to select the desired SET DATA associated with the selected function.

- 5 Push the  button. (The display changes from flashing to steady.)

- To change the selected indoor unit, go back to step 2.
- To change the selected function, go back to step 3.

- 6 When the  button is pushed, the system returns to normal off state.

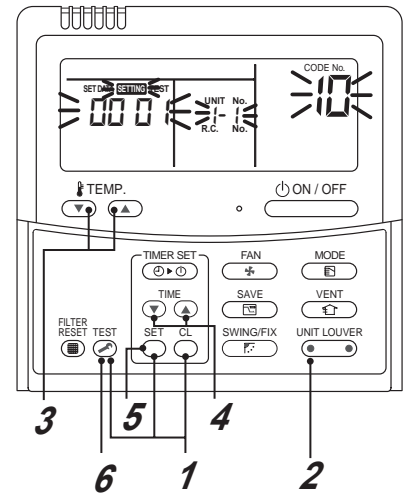

**Function CODE No. (DN Code) table (includes all functions needed to perform applied control on site)**

DN	Item	Description	At shipment						
01	Filter display delay timer	0000: None 0002: 2500H 0004: 10000H 0001: 150H 0003: 5000H	According to type						
02	Dirty state of filter	0000: Standard 0001: High degree of dirt (Half of standard time)	0000: Standard						
03	Central control address	0001: No.1 unit to 0099: Unfixed 0064: No.64 unit	0099: Unfixed						
04	Specific indoor unit priority	0000: No priority 0001: Priority	0000: No priority						
06	Heating temp shift	0000: No shift 0002: +2°C to 0001: +1°C 0010: +10°C (Up to +6 recommended)	0002: +2°C (Floor type 0000: 0 °C)						
0d	Existence of [AUTO] mode	0000: Provided 0001: Not provided (Automatic selection from connected outdoor unit)	0001: Not provided						
0F	Cooling only	0000: Heat pump 0001: Cooling only (No display of [AUTO] [HEAT])	0000: Heat pump						
10	Type	0006: Concealed Duct High Static Pressure Type * refer to next page Type CODE No. [10]	Depending on model type						
11	Indoor unit capacity	0000: Unfixed 0001 to 0034	According to capacity type						
12	Line address	0001: No.1 unit to 0030: No.30 unit	0099: Unfixed						
13	Indoor unit address	0001: No.1 unit to 0064: No.64 unit	0099: Unfixed						
14	Group address	0000: Individual 0002: Follower unit of group 0001: Header unit of group	0099: Unfixed						
1E	Temp difference of [AUTO] mode selection COOL → HEAT, HEAT → COOL	0000: 0 deg to 0010: 10 deg (For setup temperature, reversal of COOL / HEAT by } (Data value) / 2)	0003: 3 deg (Ts ±1.5)						
28	Automatic restart of power failure	0000: None 0001: Restart	0000: None						
2A	Selection of option / error input (CN70)	0000: Filter input 0002: None 0001: Alarm input (Air washer, etc.)	0002: None						
2E	HA terminal (CN61) select	0000: Usual 0002: Fire alarm input 0001: Leaving-ON prevention control	0000: Usual (HA terminal)						
31	Ventilating fan control	0000: Unavailable 0001: Available	0000: Unavailable						
32	TA sensor selection	0000: Body TA sensor 0001: Remote controller sensor	0000: Body TA sensor						
33	Temperature unit select	0000: °C(at factory shipment) 0001: °F	0000: °C						
5d	Static pressure selection	0000: Standard							
		Set data	0000	0001	0002	0003	0004	0005	0006
		External static pressure	150Pa (Factory default)	50Pa	83Pa	217Pa	117Pa	183Pa	250Pa
The list above is when SW501-1 and SW501-2 is OFF.									
60	Timer setting (wired remote controller)	0000: Available (can be performed) 0001: Unavailable (cannot be performed)	0000: Available						
77	Dual set point	0000: Unavailable 0002: Available	0000: Unavailable						
F6	Presence of Application control kit	0000: None 0001: Connect	0000: None						
Fd	Priority operation mode (FS unit)	0000: Heating 0001: Cooling	0000: Heating						
FE	FS unit address	0001: No.1 unit to 0064 : No.64 unit 0099: Unfixed	0099: Unfixed						
92	External interlock release condition	0000: Operation stopped 0001: Release signal received	0000: Operation stopped						
DO	Whether the power saving mode can be set by the remote controller	0000: Invalid 0001: Valid	0001: Valid						



**Type  
DN code “10”**

Value	Type	Model
0006	Concealed Duct High Static Pressure Type	MMD-AP***HP*

**Indoor Unit Capacity  
DN code “11”**

Value	Capacity
0000*	Invalid
0001	007 type
0003	009 type
0005	012 type
0007	015 type
0009	018 type
0011	024 type
0012	027 type
0013	030 type
0015	036 type
0017	048 type
0018	056 type
0021	072 type
0023	096 type

1 Default value stored in EEPROM mounted on service P.C. board

\*



## 8-5. Applied control of indoor unit

### Control system using Remote location ON/OFF control box (TCB-IFCB-4E2)

#### Wiring and setting

- In the case of group control, the control system functions as long as it is connected to one of the indoor units (control P.C. board) in the group. If it is desired to access the operation and error statuses of other units, relevant signals must be brought to it from those units individually.

#### ▼ Control items

- |                               |   |
|-------------------------------|---|
| (1) Start / Stop input signal | Start / stop of unit  |
| (2) In-operation signal       | Output present while unit in normal operation   |
| (3) Alarm signal Output       | present while alarm (e.g. serial communication error or operation of protective device for indoor / outdoor unit) being activated |

#### ▼ Wiring diagram of control system using Remote location ON/OFF control box (TCB-IFCB-4E2)

- Input IFCB4E2: No-voltage ON / OFF serial signal
- Output No-voltage contact (in-operation and alarm indication)  
Contact capacity: Max. AC 240 V, 0.5 A

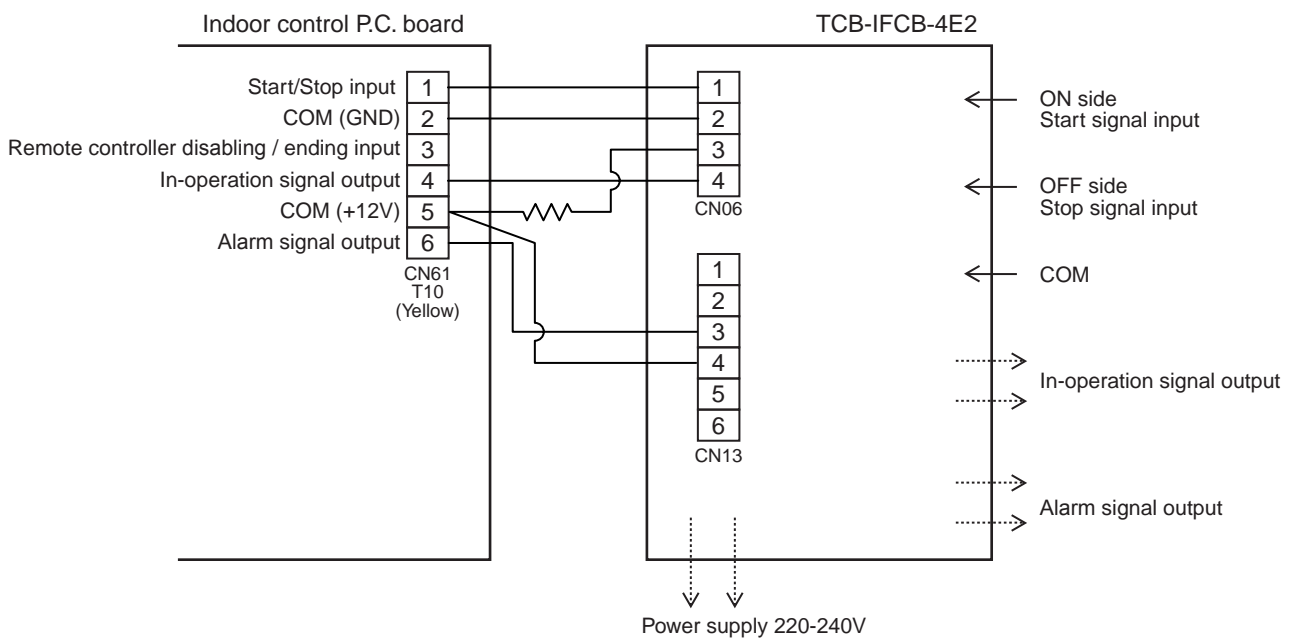

## ▼ Ventilating fan control from remote controller

### [Function]

- The start / stop operation can be operated from the wired remote controller when air to air heat exchanger or ventilating fan is installed in the system.
- The fan can be operated even if the indoor unit is not operating.
- Use a fan which can receive the non-voltage normally open contact as an outside input signal.
- In a group control, the units are collectively operated and they cannot be individually operated.

### 1. Operation

Handle a wired remote controller in the following procedure.

- \* Use the wired remote controller during stop of the system.
- \* Be sure to set up the wired remote controller to the header unit. (Same in group control)
- \* In a group control, if the wired remote controller is set up to the header unit, both header and follower units are simultaneously operable.

### 1 Push concurrently + + buttons for 4 seconds or more.

The unit No. displayed firstly indicates the header indoor unit address in the group control. In this time, the fan of the selected indoor unit turns on.

### 2 Every pushing button (left side of the button), the indoor unit numbers in group control are displayed successively.

In this time, the fan of the selected indoor unit only turns on.

### 3 Using the setup temp or button, specify the CODE No. 31.

### 4 Using the timer time or button, select the SET DATA. (At shipment: 0000)

The setup data are as follows:

SET DATA	Handling of operation of air to air heat exchanger or ventilating fan
0000	Unavailable (At shipment)
0001	Available

### 5 Push button. (OK if display goes on.)

- To change the selected indoor unit, go to the procedure 2).
- To change the item to be set up, go to the procedure 3).

### 6 Pushing returns the status to the usual stop status.

## 2. Wiring

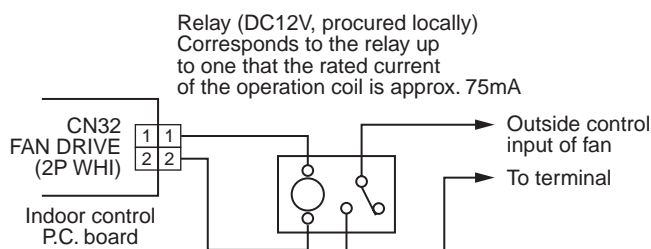

**Note)** Determine the cable length between the indoor control P.C. board and the relay within 2m.

## ▼ Leaving-ON prevention control

### [Function]

- This function controls the indoor units individually. It is connected with cable to the control P.C. board of the indoor unit.
- In a group control, it is connected with cable to the indoor unit (Control P.C. board), and the CODE No. **2E** is set to the connected indoor unit.
- It is used when the start operation from outside is unnecessary but the stop operation is necessary.
- Using a card switch box, card lock, etc, the forgotten-OFF of the indoor unit can be protected.
- When inserting a card, start / stop operation from the remote controller is allowed.
- When taking out a card, the system stops if the indoor unit is operating and start / stop operation from the remote controller is forbidden.

### 1. Control items

- 1) Outside contact ON: The start / stop operation from the remote controller is allowed.  
(Status that card is inserted in the card switch box)
- 2) Outside contact OFF: If the indoor unit is operating, it is stopped forcibly.  
(Start / Stop prohibited to remote controller)  
(Status that card is taken out from the card switch box)

\* When the card switch box does not perform the above contact operation, convert it using a relay with non-voltage normally closed contact.

### 2. Operation

Handle the wired remote controller switch in the following procedure.

\* Use the wired remote controller switch during stop of the system.

- 1 Push concurrently  $\text{SET}$  +  $\text{CL}$  +  $\text{TEST}$  buttons for 4 seconds or more.**
- 2 Using the setup temp  $\text{▼}$  or  $\text{▲}$  button, specify the CODE No. **2E**.**
- 3 Using the timer time  $\text{▼}$  or  $\text{▲}$  button, set **000 l** to the SET DATA.**
- 4 Push  $\text{SET}$  button.**
- 5 Push  $\text{TEST}$  button. (The status returns to the usual stop status.)**

### 3. Wiring

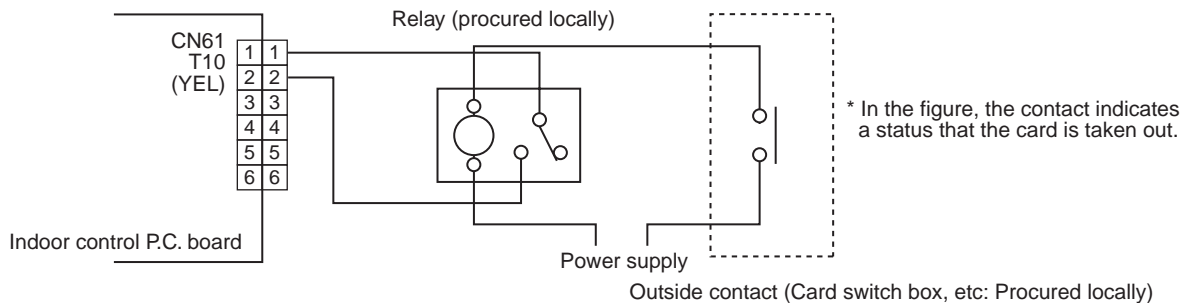

Note) Determine the cable length between the indoor control P.C. board and the relay within 2m.

## ▼ Power peak-cut from indoor unit

When the relay is turned on, a forced thermostat-OFF operation starts.

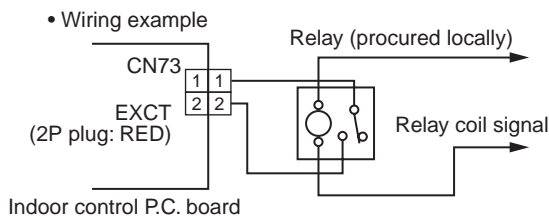

Note) Determine the cable length between the indoor or outdoor control P.C. board and the relay within 2m.

### Manual address setting using the remote controller

Procedure when setting indoor units' addresses first under the condition that indoor wiring has been completed and outdoor wiring has not been started (manual setting using the remote controller)

#### ▼ Wiring example of 2 refrigerant lines

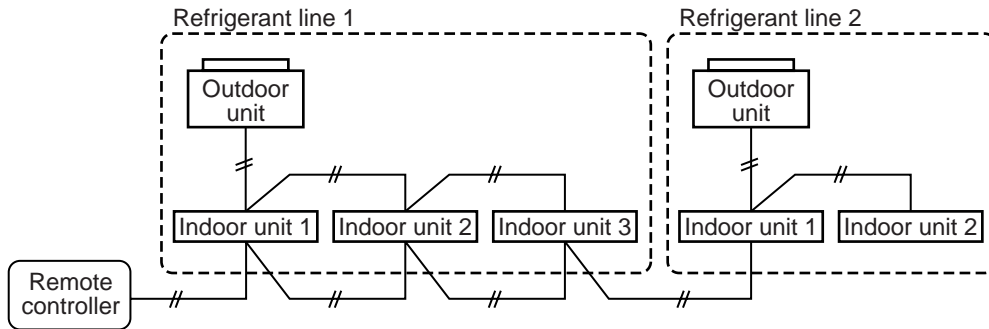

Line (system) address	1	1	1	2	2
Indoor unit address	1	2	3	1	2
Group address	1 Header unit	2 Follower unit	2 Follower unit	2 Follower unit	2 Follower unit

In the example above, disconnect the remote controller connections between the indoor units and connect a wired remote controller to the target unit directly before address setting.

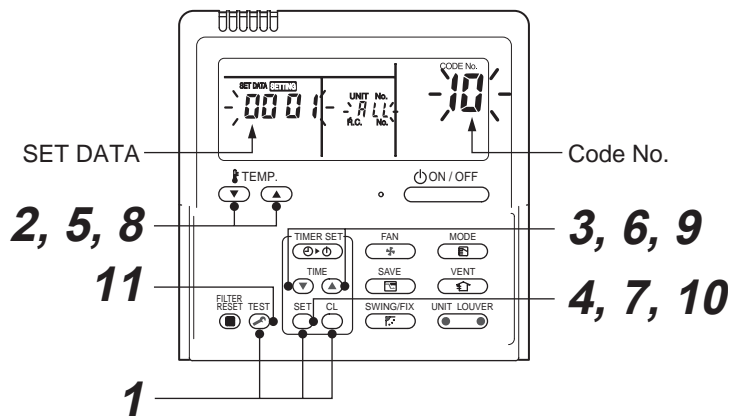

Pair the indoor unit to set and the remote controller one-to-one.

Turn on the power.

- 1 Push and hold the **SET**, **CL** and **TEST** buttons at the same time for more than 4 seconds. LCD starts flashing.

### <Line (system) address>

**2** Push the TEMP.  /  buttons repeatedly to set the CODE No. to **12** .

**3** Push the TIME  /  buttons repeatedly to set a system address.

(Match the address with the address on the interface P.C. board of the header outdoor unit in the same refrigerant line.)

**4** Push  button.

(It is OK if the display turns on.)

### <Indoor unit address>

**5** Push the TEMP.  /  buttons repeatedly to set the CODE No. to **13** .

**6** Push the TIME  /  buttons repeatedly to set an indoor unit address.

**7** Push the  button.

(It is OK if the display turns on.)

### <Group address>

**8** Push the TEMP.  /  buttons repeatedly to set the CODE No. to **14** .

**9** Push the TIME  /  buttons repeatedly to set a group address. If the indoor unit is individual, set the address to **0000** ; header unit, **0001** ; follower unit, **0002** .

Individual	: 0000	} In case of group control
Header unit	: 0001	
Follower unit	: 0002	

**10** Push the  button.

(It is OK if the display turns on.)

**11** Push the  button.

The address setting is complete.

( **SETTING** flashes. You can control the unit after **SETTING** has disappeared.)

### NOTE

**1. Do not use address numbers 29 or 30 when setting system addresses using the remote controller. These 2 address numbers cannot be used on outdoor units and the CODE No. [E04] (Indoor / outdoor communication error) will appear if they are mistakenly used.**

**2. If you set addresses to indoor units in 2 or more refrigerate lines manually using the remote controller and will control them centrally, set the header outdoor unit of each line as below.**

- Set a system address for the header outdoor unit of each line with SW13 and 14 of their interface P.C. boards.
- Turn off dip switch 2 of SW30 on the interface P.C. boards of all the header outdoor units connected to the same central control, except the unit that has the lowest address. (For unifying the termination of the wiring for the central control of indoor and outdoor units)
- Connect the relay connectors between the [U1, U2] and [U3, U4] terminals on the header outdoor unit of each refrigerate line.
- After finishing all the settings above, set the address of the central control devices. (For the setting of the central control address, refer to the installation manuals of the central control devices.)

## Confirming the indoor unit addresses and the position of an indoor unit using the remote controller

### ◆ Confirming the numbers and positions of indoor units

To see the indoor unit address of an indoor unit which you know the position of indoor unit.

- ▼ When the unit is individual (the indoor unit is paired with a wired remote controller one-to-one), or it is a group-controlled one.

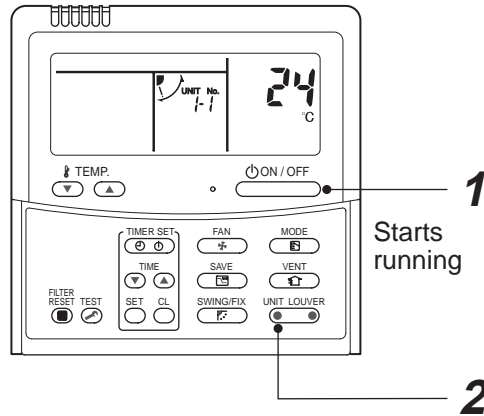

(Execute it while the units are running.)

- 1** Push the  button if the units stop.
- 2** Push the  button (left side of the button).

A unit numbers  is indicated on the LCD (it will disappear after a few seconds). The indicated number shows the system address and indoor unit address of the unit.

When 2 or more indoor units are connected to the remote controller (group-controlled units), a number of other connected units appears each time you push the  button (left side of the button).



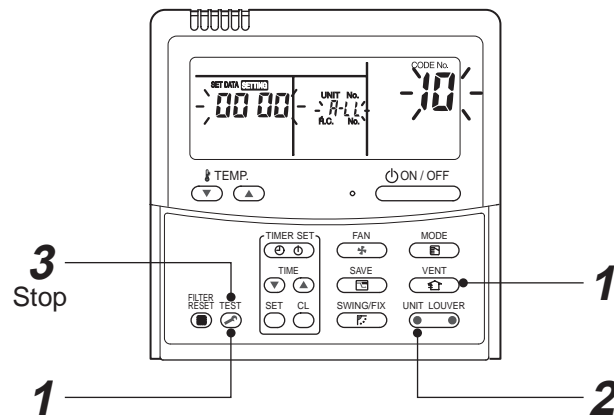

## To find an indoor unit's position from its address

### ▼ When checking unit numbers controlled as a group



#### (Execute it while the units are stopped.)

The indoor unit numbers in a group are indicated one after another. The fan of the indicated units are activated.

- 1 Push and hold the  and  buttons at the same time for more than 4 seconds.**
  - **ALL** appears on UNIT No. on the LCD display.
  - The fans of all the indoor units in the group are activated.
- 2 Push the  button (left side of the button). Each time you push the button, the indoor unit numbers are indicated one after another.**
  - The first-indicated unit number is the address of the header unit.
  - Only the fan of the indicated indoor unit are activated.
- 3 Push the  button to finish the procedure.**

All the indoor units in the group stop.

- ▼ To check all the indoor unit addresses using an arbitrary wired remote controller.  
(When communication wirings of 2 or more refrigerant lines are interconnected for central control)

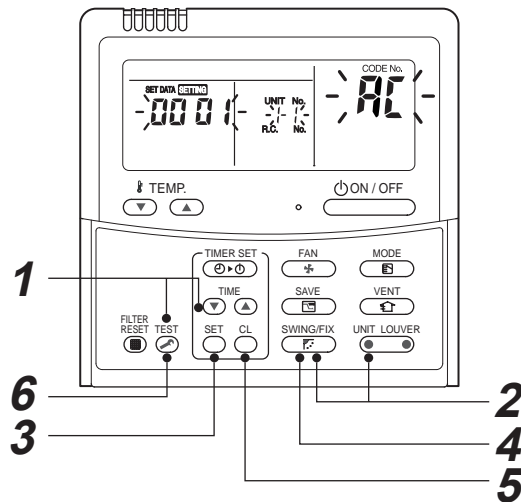

**(Execute it while the units are stopped.)**

You can check indoor unit addresses and positions of the indoor units in a single refrigerant line. When an outdoor unit is selected, the indoor unit numbers of the refrigerant line of the selected unit are indicated one after another and the fan of the indicated indoor units are activated.

- 1** Push and hold the **TIME** (▼) and **TEST** (🔍) buttons at the same time for more than 4 seconds. At first, the line 1 and CODE No. **RL** (Address Change) are indicated on the LCD display. (Select an outdoor unit.)
  - 2** Push the **UNIT LOUVER** (left side of the button) and **SWING/FIX** buttons repeatedly to select a system address.
  - 3** Push the **SET** (○) button to confirm the system address selection.
    - The address of an indoor unit connected to the selected refrigerant line is indicated on the LCD display and its fan is activated.
  - 4** Push the **UNIT LOUVER** (left side of the button). Each time you push the button, the indoor unit numbers of the selected refrigerant line are indicated one after another.
    - Only the fan of the indicated indoor unit are activated.
- ◆ To select another system address
- 5** Push the **CL** (○) button to return to step 2.
    - After returning to step 2, select another system address and check the indoor unit addresses of the line.
  - 6** Push the **TEST** (🔍) button to finish the procedure.



◆ **Changing the indoor unit address using a remote controller**

To change an indoor unit address using a wired remote controller.

- ▼ **The method to change the address of an individual indoor unit (the indoor unit is paired with a wired remote controller one-to-one), or an indoor unit in a group. (The method is available when the addresses have already been set automatically.)**

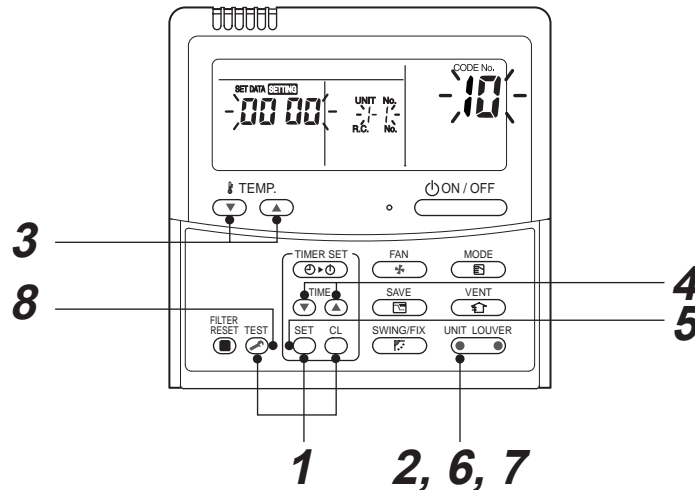

(Execute it while the units are stopped.)

- 1** Push and hold the , , and buttons at the same time for more than 4 seconds.  
(If 2 or more indoor units are controlled in a group, the first indicated UNIT No. is that of the head unit.)
- 2** Push the button (left side of the button) repeatedly to select an indoor unit number to change if 2 or more units are controlled in a group. (The fan of the selected indoor unit are activated.)  
(The fan of the selected indoor unit is turned on.)
- 3** Push the TEMP. / buttons repeatedly to select for CODE No.
- 4** Push the TIME / buttons repeatedly to change the value indicated in the SET DATA section to that you want.
- 5** Push the button.
- 6** Push the button (left side of the button) repeatedly to select another indoor UNIT No. to change.  
Repeat steps **4** to **6** to change the indoor unit addresses so as to make each of them unique.
- 7** Push the button (left side of the button) to check the changed addresses.
- 8** If the addresses have been changed correctly, push the button to finish the procedure.

- ▼ To change all the indoor unit addresses using an arbitrary wired remote controller.  
(The method is available when the addresses have already been set automatically.)

(When communication wirings of 2 or more refrigerant lines are interconnected for central control)

#### NOTE

You can change the addresses of indoor units in each refrigerant line using an arbitrary wired remote controller.

- \* Enter the address check / change mode and change the addresses.

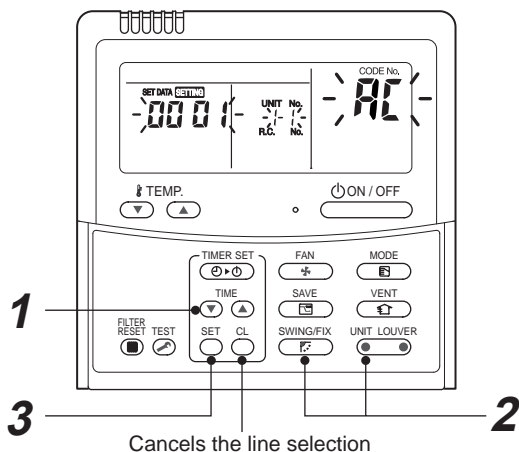

If no number appears on UNIT No., no outdoor unit exists on the line. Push button and select another line following step 2.

(Execute it while the units are stopped.)

- 1 Push and hold the TIME (▼) / (▲) buttons at the same time for more than 4 seconds.  
At first, the line 1 and CODE No. AC (Address Change) are indicated on the LCD display.
- 2 Push the UNIT LOUVER button (left side of the button) and the SWING/FIX buttons repeatedly to select a system address.
- 3 Push the SET button.
  - The address of one of the indoor units connected to the selected refrigerant line is indicated on the LCD display and the fan 4 of the unit are activated.  
At first, the current indoor unit address is displayed in SET DATA.  
(No system address is indicated.)

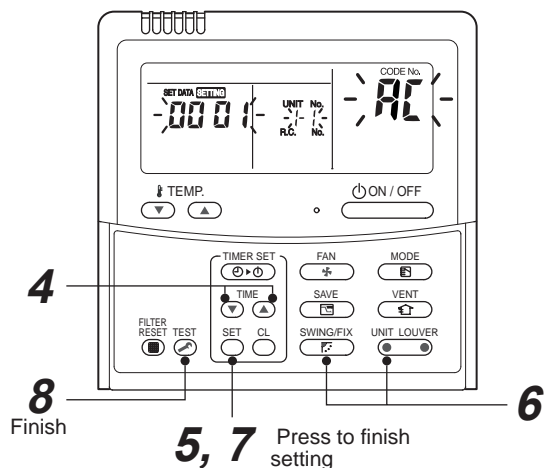

- 4** Push the TIME  $\nabla$  /  $\blacktriangle$  buttons repeatedly to change the value of the indoor unit address in SET DATA.  
Change the value in SET DATA to that of a new address.
- 5** Push the  $\text{SET}$  button to confirm the new address on SET DATA.
- 6** Push the  $\text{UNIT LOUVER}$  button (left side of the button) repeatedly to select another address to change.  
Each time you push the button, the indoor unit numbers in a refrigerant line are indicated one after another. Only the fan of the selected indoor unit are activated. Repeat steps 4 to 6 to change the indoor unit addresses so as to make each of them unique.
- 7** Push the  $\text{SET}$  button.  
(All the segments on the LCD display light up.)
- 8** Push the  $\text{TEST}$  button to finish the procedure.

## ◆ Check code clearing function

### How to clear the check code using the wired remote controller

#### ▼ Clearing an check code of the outdoor unit

Clear the currently detected outdoor unit for each refrigerant line to which the indoor unit controlled by the remote controller is connected. (The indoor unit check code is not cleared.) Use the service monitoring function of the remote controller.

- 1 Push and hold the  $\text{CL}$  , and  $\text{TEST}$  for 4 seconds or longer to enter the service monitoring mode.
- 2 Push the  $\text{TEMP.}$  button to set CODE No. to "FF".
- 3 The display in A of the following figure counts down as follows at 5-second intervals: "0005" → "0004" → "0003" → "0002" → "0001" → "0000".  
The check code is cleared when "0000" appears.  
However, the display counts down from "0005" again.
- 4 Push the  $\text{TEST}$  to return the display to normal.

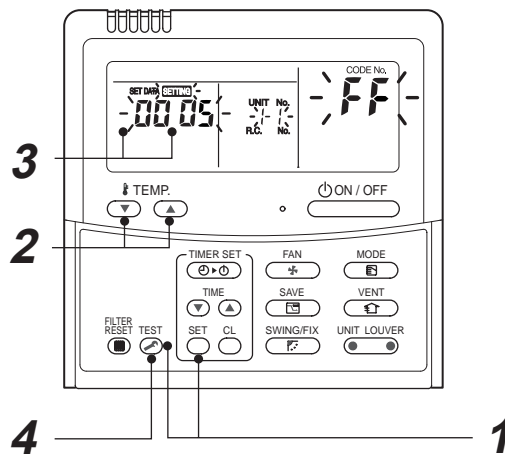

#### ▼ Clearing an check code of the indoor unit

Push the  $\text{ON / OFF}$  button on the remote controller.

(Only the check code of the indoor unit controlled by the remote controller will be cleared.)



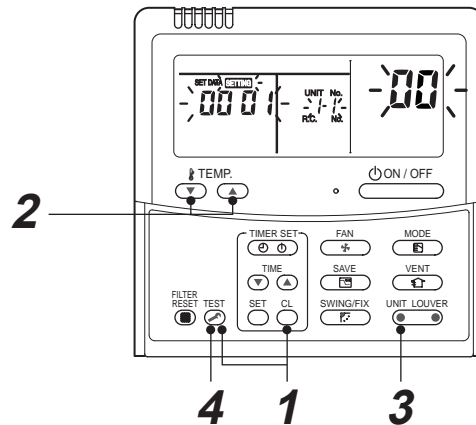

## Monitoring function of wired remote controller

The following monitoring function is available if the remote controller of RBC-AMT32E is used.



### ▼ Content

Enter the service monitoring mode using the remote controller to check the sensor temperature or operation status of the remote controller, indoor unit, and outdoor unit.

- 1** Push and hold the , and  for 4 seconds or longer to enter the service monitoring mode.  
The service monitor lights up. The temperature of CODE No. **00** appears at first.
- 2** Push the  button to change to CODE No. of the item to monitor. Refer to the following table for CODE No.
- 3** Push the left part of the  button (left side of the button) to change to the item to monitor. Monitor the sensor temperature or operation status of the indoor unit and outdoor unit in the refrigerant line
- 4** Push the to  return the display to normal.

	CODE No.	Data name	Display format	Unit	Remote controller display example
Indoor unit data *2	00	Room temperature (Use to control)	×1	°C	[0024]=24°C
	01	Room temperature (Remote controller)	×1	°C	
	02	Indoor suction air temperature (TA)	×1	°C	
	03	Indoor coil temperature (TCJ)	×1	°C	
	04	Indoor coil temperature (TC2)	×1	°C	
	05	Indoor coil temperature (TC1)	×1	°C	
	06	Indoor discharge air temperature (TF) *1	×1	°C	
	08	Indoor PMV opening	×1/10	pls	[0150]=1500pls
	F3	Filter sign time	×1	h	[2500] = 2500h
	F9	Suction temperature of air to air heat exchanger (TSA) **	×1	°C	[0024] = 24°C
	FA	Outside air temperature (TO)**	×1	°C	
System data	0A	No. of connected indoor units	×1	unit	[0048]=48 units
	0B	Total horsepower of connected indoor units	×10	HP	[0415]=41.5HP
	0C	No. of connected outdoor units	×1	unit	[0003]=3 units
	0D	Total horsepower of outdoor units	×10	HP	[0420]=42HP

	CODE No.			Data name	Display format	Unit	Remote controller display example
	U1	U2	U3				
Outdoor unit individual data 1 *3	10	20	30	High-pressure sensor detention pressure (Pd)	×100	MPa	[0123] = 1.23MPa
	11	21	31	Low-pressure sensor detention pressure (Ps)	×100	MPa	
	12	22	32	Compressor 1 discharge temperature (TD1)	×1	°C	[0024] = 24°C
	13	23	33	Compressor 2 discharge temperature (TD2)	×1	°C	
	15	25	35	Outdoor coil temperature (TE1)	×1	°C	
	16	26	36	Outdoor coil temperature (TE2)	×1	°C	
	17	27	37	Outdoor coil temperature (TG1)	×1	°C	
	18	28	38	Outdoor coil temperature (TG2)	×1	°C	
	19	29	39	Outside ambient temperature (TO)	×1	°C	
	1A	2A	3A	Suction temperature (TS1)	×1	°C	
	1C	2C	3C	Suction temperature (TS3)	×1	°C	
	1D	2D	3D	Temperature at liquid side (TL1)	×1	°C	
	1E	2E	3E	Temperature at liquid side (TL2)	×1	°C	
	1F	2F	3F	Temperature at liquid side (TL3)	×1	°C	

	CODE No.			Data name	Display format	Unit	Remote controller display example
	U1	U2	U3				
Outdoor unit individual data 2 *4	50	60	70	PMV1 opening	×1	pls	[0500] = 500pls
	51	61	71	PMV3 opening	×1	pls	
	52	62	72	PMV4 opening	×1	pls	
	53	63	73	1 fan model : Compressor 1 current (I1) 2 fan model : Compressor 1 and Outdoor fan 1 current (I1)	×10	A	[0135] = 13.5A
	54	64	74	1 fan model : Compressor 2 and Outdoor fan 1 current (I2) 2 fan model : Compressor 2 and Outdoor fan 2 current (I2)	×10	A	
	56	66	76	Compressor 1 revolutions	×10	rps	[0642] = 64.2rps
	57	67	77	Compressor 2 revolutions	×10	rps	
	59	69	79	Outdoor fan mode	×1	mode	[0058] = 58 mode
	5A	6A	7A	Compressor IPDU 1 heat sink temperature	×1	°C	[0024] = 24°C
	5B	6B	7B	Compressor IPDU 2 heat sink temperature	×1	°C	
	5D	6D	7D	Outdoor fan IPDU 1 heat sink temperature	×1	°C	
	5E	6E	7E	Outdoor fan IPDU 2 heat sink temperature	×1	°C	
	5F	6F	7F	Outdoor unit horsepower	×1	HP	[0016] = 16HP

	CODE No.			Data name	Display format	Unit	Remote controller display example
	U1	U2	U3				
Outdoor unit individual data 3 *5	90			Heating/cooling recovery controlled	0: Normal 1: Recovery controlled		[0010]=Heating recovery controlled [0001]=Cooling recovery controlled
	91			Pressure release			[0010]=Pressure release controlled
	92			Discharge temperature release			[0001]=Discharge temperature release controlled
	93			Follower unit release (U2/U3 outdoor units)	0: Normal 1: Release controlled		[0100]=U2 outdoor unit release controlled [0010]=U3 outdoor unit release controlled [0001]=U4 outdoor unit release controlled

\*1 Only a part of indoor unit types is installed with the discharge air temperature sensor. This temperature is not displayed for other types.

\*2 When the units are connected to a group, data of the header indoor unit only can be displayed.

\*3 The first digit of an CODE No. indicates the outdoor unit number.

\*4 The upper digit of an CODE No. -4 indicates the outdoor unit number.

1\*, 5\* ... U1 outdoor unit (Header unit)

2\*, 6\* ... U2 outdoor unit (Follower unit 1)

3\*, 7\* ... U3 outdoor unit (Follower unit 2)

\*5 Only the CODE No. 9\* of U1 outdoor unit (Header unit) is displayed.

## ◆ LED display of circuit board

### 1. D501 (Red)

- Lights up when the power is turned on (Microcomputer works)
- Blinks at 1-second intervals (0.5-second): No EEPROM, or writing error
- Blinks at 10-second intervals (5-second): No DISP mode
- Blinks at 2-second intervals (1-second): Function change being set (EEPROM)

### 2. D403 (Red)

- Lights up (on hardware) when the power is supplied to the remote controller

# 9. TROUBLESHOOTING

## 9-1. Overview

(1) Before engaging in troubleshooting

(a) Applicable models

Super Module Multi (SMMS-i, SMMS-e, SHRM-i, SHRM-e) models.

(Indoor units: MM \*-AP \* \* \*, Outdoor units: MMY-MAP \* \* \*)

(b) Tools and measuring devices required

- Screwdrivers (Philips, flat head), spanners, long-nose pliers, nipper, pin to push reset switch, etc.
- Multimeter, thermometer, pressure gauge, etc.

(c) Things to check prior to troubleshooting (behaviors listed below are normal)

NO.	Behavior	Possible cause
1	A compressor would not start	<ul style="list-style-type: none"> <li>• Could it just be the 3-minute delay period (3 minutes after compressor shutdown)?</li> <li>• Could it just be the air conditioner having gone thermostat OFF?</li> <li>• Could it just be the air conditioner operating in fan mode or put on the timer?</li> <li>• Could it just be the system going through initial communication?</li> </ul>
2	An indoor fan would not start	<ul style="list-style-type: none"> <li>• Could it just be cold air discharge prevention control, which is part of heating?</li> </ul>
3	An outdoor fan would not start or would change speed for no reason	<ul style="list-style-type: none"> <li>• Could it just be cooling operation under low outside temperature conditions?</li> <li>• Could it just be defrosting operation?</li> </ul>
4	An indoor fan would not stop	<ul style="list-style-type: none"> <li>• Could it just be the elimination of residual heat being performed as part of the air conditioner shutdown process after heating operation?</li> </ul>
5	The air conditioner would not respond to a start / stop command from a remote controller	<ul style="list-style-type: none"> <li>• Could it just be the air conditioner operation under external or remote controller?</li> </ul>

(2) Troubleshooting procedure

When a trouble occurs, proceed with troubleshooting in accordance with the procedure shown below.

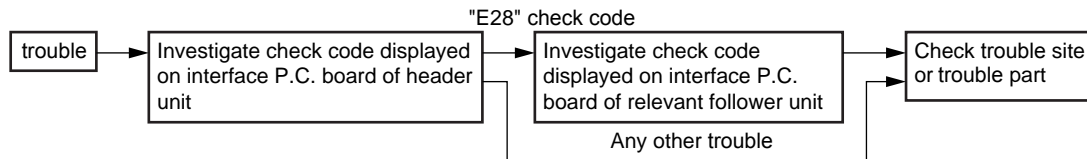

### NOTE

Rather than a genuine trouble (see the List of Check Codes below), the problem could have been caused by a microprocessor malfunction attributable to a poor quality of the power source or an external noise. Check for possible noise sources, and shield the remote controller wiring and signal wires as necessary.

## 9-2. Troubleshooting method

The remote controllers (main remote controller and central control remote controller) and the interface P.C. board of an outdoor unit are provided with an LCD display (remote controller) or a 7-segment display (outdoor interface P.C. board) to display operational status. Using this self-diagnosis feature, the trouble site / trouble part may be identified in the event of a trouble by following the method described below.

The list below summarizes check codes detected by various devices. Analyze the check code according to where it is displayed and work out the nature of the trouble in consultation with the list.

- When investigating a trouble on the basis of a display provided on the indoor remote controller or TCC-LINK central control remote controller - See the "TCC-LINK remote controller or main remote controller display" section of the list.
- When investigating a trouble on the basis of a display provided on an outdoor unit - See the "Outdoor 7-segment display" section of the list.
- When investigating a trouble on the basis of a wireless remote controller-controlled indoor unit - See the "Indicator light block" section of the list.

### List of check codes (indoor unit)

(Check code detected by indoor unit)

IPDU: Intelligent Power Drive Unit (Inverter P.C. board)

○: Lighting, ⊙: Flashing, ●: Goes off

ALT.: Flashing is alternately when there are two flashing LED

SIM: Simultaneous flashing when there are two flashing LED

Check code		Display of receiving unit				Typical trouble on site	Description of check code	
TCC-LINK central control or main remote controller display	Outdoor 7-segment display	Indicator light block						
		Sub-code	Operation ⏻	Timer ⌚	Ready ⊙	Flash		
E03	—	—	⊙	●	●	Indoor-remote controller periodic communication check code	Communication from remote controller or network adaptor has been lost (so has central control communication).	
E04	—	—	●	●	⊙	Indoor-outdoor periodic communication check code	Signals are not being received from outdoor unit.	
E08	E08	Duplicated indoor address	⊙	●	●	Duplicated indoor address	Indoor unit detects address identical to its own.	
E10	—	—	⊙	●	●	UART communication trouble	Communication error between CDB(MCC-1643) and FAN-IPDU(MCC-1610).	
E11	—	—	⊙	●	●	Communication check code between Application control kit and indoor unit	Communication check code between Application control kit and indoor unit P.C. board	
E18	—	—	⊙	●	●	Check cod in periodic communication between indoor header and follower unit	Periodic communication between indoor header and follower units cannot be maintained.	
F01	—	—	⊙	⊙	●	ALT	Indoor heat exchanger temperature sensor (TCJ) check code	Heat exchanger temperature sensor (TCJ) has been open / shortcircuited.
F02	—	—	⊙	⊙	●	ALT	Indoor heat exchanger temperature sensor (TC2) check code	Heat exchanger temperature sensor (TC2) has been open / shortcircuited.
F03	—	—	⊙	⊙	●	ALT	Indoor heat exchanger temperature sensor (TC1) check code	Heat exchanger temperature sensor (TC1) has been open / shortcircuited.
F10	—	—	⊙	⊙	●	ALT	Ambient temperature sensor (TA) check code	Ambient temperature sensor (TA) has been open / short-circuited.
F11	—	—	⊙	⊙	●	ALT	Discharge temperature sensor (TF) check code	Discharge temperature sensor (TF) has been open / shortcircuited.
F29	—	—	⊙	⊙	●	SIM	P.C. board or other indoor check code	Indoor EEPROM is abnormal (some other error may be detected).
L03	—	—	⊙	●	⊙	SIM	Duplicated indoor group header unit	There is more than one header unit in group.
L07	—	—	⊙	●	⊙	SIM	Connection of group control cable to stand-alone indoor unit	There is at least one stand-alone indoor unit to which group control cable is connected.
L08	L08	—	⊙	●	⊙	SIM	Indoor group address not set	Address setting has not been performed for one or more indoor units (also detected at outdoor unit end).
L09	—	—	⊙	●	⊙	SIM	Indoor capacity not set	Capacity setting has not been performed for indoor unit.
L20	—	—	⊙	○	⊙	SIM	Duplicated central control address	There is duplication in central control address setting.
L30	L30	Detected indoor unit No.	⊙	○	⊙	SIM	Indoor external check code input (interlock)	Unit shutdown has been caused by external check code input (CN80).
P01	—	—	●	⊙	⊙	ALT	Indoor AC fan check code	Indoor AC fan check code is detected (activation of fan motor thermal relay).
P10	P10	Detected indoor unit No.	●	⊙	⊙	ALT	Indoor overflow check code	Float switch has been activated.
P12	—	—	●	⊙	⊙	ALT	Indoor DC fan check code	Indoor DC fan check code (e.g. overcurrent or lock-up) is detected.
P31	—	—	⊙	●	⊙	ALT	Other indoor unit check code	Follower unit cannot be operated due to header unit alarm (E03 / L03 / L07 / L08).



(Check code detected by main remote controller)

Check code		Display of receiving unit				Typical trouble on site	Description of check code
Main remote controller	Outdoor 7-segment display	Indicator light block					
	Sub-code	Operation	Timer	Ready	Flash		
E01	—	—	☉ ● ●			No master remote controller, faulty remote controller communication (reception)	Signals cannot be received from indoor unit; master remote controller has not been set (including two remote controller control).
E02	—	—	☉ ● ●			Faulty remote controller communication (transmission)	Signals cannot be transmitted to indoor unit.
E02	—	—	☉ ● ●			Duplicated master remote controller	Both remote controllers have been set as master remote controller in two remote controller control (alarm and shutdown for header unit and continued operation for follower unit)

(Check code detected by central control device)

Check code		Display of receiving unit				Typical trouble on site	Description of check code
TCC-LINK central control	Outdoor 7-segment display	Indicator light block					
	Sub-code	Operation	Timer	Ready	Flash		
C05	—	—	No indication (when main remote controller also in use)			Faulty central control communication (transmission)	Central control device is unable to transmit signal due to duplication of central control device.
C06	—	—				Faulty central control communication (reception)	Central control device is unable to receive signal.
—	—	—				Multiple network adapters	Multiple network adapters are connected to remote controller communication line.
C12	—	—	—			Blanket alarm for general-purpose device control interface	Device connected to general-purpose device control interface for TCC-LINK is in trouble.
P30	—	—	As per alarm unit (see above)			Group control follower unit error	Group follower unit is in trouble (unit No. and above detail [***] displayed on main remote controller)

**Note:** The same trouble, e.g. a communication trouble, may result in the display of different check codes depending on the device that detects it. Moreover, check codes detected by the main remote controller / central control device do not necessarily have a direct impact on air conditioner operation.

## List of Check Codes (Outdoor Unit)

(Check code detected by SMMS-e outdoor interface - typical examples)

If "HELLO" is displayed on the outdoor 7-segment for 1 minute or more, turn off the power supply once and then turn on the power supply again after passage of 30 seconds or more. When the same symptom appears, it is considered there is a possibility of I/F board error.

IPDU: Intelligent Power Drive Unit (Inverter P.C. board)

○ : Lighting, ⊙ : Flashing, ● : Goes off

ALT.: Flashing is alternately when there are two flashing LED

SIM: Simultaneous flashing when there are two flashing LED



Check code		Display of receiving unit				Typical problem site	Description of problem																																																																																	
Outdoor 7-segment display		TCC-LINK central control or main remote controller display	Indicator light block																																																																																					
Sub-code			Operation ⏻	Timer ⌚	Ready ⊙	Flash																																																																																		
E06	Number of indoor units from which signal is received normally	E06	●	●	⊙		Signal lack of indoor unit	Indoor unit initially communicating normally fails to return signal (reduction in number of indoor units connected).																																																																																
E07	—	(E04)	●	●	⊙		Indoor-outdoor communication circuit trouble	Signal cannot be transmitted to indoor units (→ indoor units left without communication from outdoor unit).																																																																																
E08	Duplicated indoor address	(E08)	⊙	●	●		Duplicated indoor address	More than one indoor unit are assigned same address (also detected at indoor unit end).																																																																																
E12	01: Indoor-outdoor communication 02: Outdoor-outdoor communication	E12	⊙	●	●		Automatic address starting trouble	<ul style="list-style-type: none"> <li>Indoor automatic address setting is started while automatic address setting for equipment in other refrigerant line is in progress.</li> <li>Outdoor automatic address setting is started while automatic address setting for indoor units is in progress.</li> </ul>																																																																																
E15	—	E15	●	●	⊙		Indoor unit not found during automatic address setting	Indoor unit fails to communicate while automatic address setting for indoor units is in progress.																																																																																
E16	00: Overloading 01: Number of units connected	E16	●	●	⊙		Too many indoor units connected/overloading	Combined capacity of indoor units is too large (more than 135% of combined capacity of outdoor units).																																																																																
E19	00: No header unit 02: Two or more header units	E19	●	●	⊙		Trouble in number of outdoor header units	There is no or more than one outdoor header unit in one refrigerant line.																																																																																
E20	01: Connection of outdoor unit from other refrigerant line 02: Connection of indoor unit from other refrigerant line	E20	●	●	⊙		Connection to other refrigerant line found during automatic address setting	Indoor unit from other refrigerant line is detected while indoor automatic address setting is in progress.																																																																																
E23	—	E23	●	●	⊙		Outdoor-outdoor communication transmission trouble	Signal cannot be transmitted to other outdoor units.																																																																																
E25	—	E25	●	●	⊙		Duplicated follower outdoor address	There is duplication in outdoor addresses set manually.																																																																																
E26	Address of outdoor unit from which signal is not received normally	E26	●	●	⊙		Signal lack of outdoor unit	Follower outdoor unit initially communicating normally fails to do so (reduction in number of follower outdoor units connected).																																																																																
E28	Detected outdoor unit No.	E28	●	●	⊙		Outdoor follower unit trouble	Outdoor header unit detects fault relating to follower outdoor unit (detail displayed on follower outdoor unit).																																																																																
E31	<table border="1" style="width: 100%; border-collapse: collapse; text-align: center;"> <thead> <tr> <th colspan="2">A3-IPDU</th> <th colspan="2">Fan-IPDU</th> <th colspan="2">A3-IPDU</th> <th colspan="2">Fan-IPDU</th> </tr> <tr> <th>1</th><th>2</th><th>1</th><th>2</th><th>1</th><th>2</th><th>1</th><th>2</th> </tr> </thead> <tbody> <tr> <td>01</td><td>○</td><td></td><td></td><td>10</td><td></td><td></td><td>○</td> </tr> <tr> <td>02</td><td></td><td>○</td><td></td><td>11</td><td>○</td><td></td><td>○</td> </tr> <tr> <td>03</td><td>○</td><td>○</td><td></td><td>12</td><td></td><td>○</td><td>○</td> </tr> <tr> <td>08</td><td></td><td></td><td>○</td><td>13</td><td>○</td><td>○</td><td>○</td> </tr> <tr> <td>09</td><td>○</td><td></td><td>○</td><td>18</td><td></td><td>○</td><td>○</td> </tr> <tr> <td>0A</td><td></td><td>○</td><td>○</td><td>19</td><td></td><td>○</td><td>○</td> </tr> <tr> <td>0B</td><td>○</td><td>○</td><td>○</td><td>1A</td><td>○</td><td>○</td><td>○</td> </tr> <tr> <td></td><td></td><td></td><td></td><td>1B</td><td>○</td><td>○</td><td>○</td> </tr> </tbody> </table> <p>Circle (○): IPDU trouble 80 : Communication error between MCU and Sub MCU</p>	A3-IPDU		Fan-IPDU		A3-IPDU		Fan-IPDU		1	2	1	2	1	2	1	2	01	○			10			○	02		○		11	○		○	03	○	○		12		○	○	08			○	13	○	○	○	09	○		○	18		○	○	0A		○	○	19		○	○	0B	○	○	○	1A	○	○	○					1B	○	○	○	E31	●	●	⊙		IPDU communication trouble Sub MCU communication trouble	There is no communication between IPDUs (P.C. boards) in inverter box.
A3-IPDU		Fan-IPDU		A3-IPDU		Fan-IPDU																																																																																		
1	2	1	2	1	2	1	2																																																																																	
01	○			10			○																																																																																	
02		○		11	○		○																																																																																	
03	○	○		12		○	○																																																																																	
08			○	13	○	○	○																																																																																	
09	○		○	18		○	○																																																																																	
0A		○	○	19		○	○																																																																																	
0B	○	○	○	1A	○	○	○																																																																																	
				1B	○	○	○																																																																																	
F04	—	F04	⊙	⊙	○	ALT	Outdoor discharge temperature sensor (TD1) trouble	Outdoor discharge temperature sensor (TD1) has been open/short-circuited.																																																																																
F05	—	F05	⊙	⊙	○	ALT	Outdoor discharge temperature sensor (TD2) trouble	Outdoor discharge temperature sensor (TD2) has been open/short-circuited.																																																																																
F06	01: TE1 02: TE2	F06	⊙	⊙	○	ALT	Outdoor heat exchanger liquid side temperature sensor (TE1, TE2) trouble	Outdoor heat exchanger liquid side temperature sensors (TE1, TE2) have been open/short-circuited.																																																																																
F07	01: TL1 02: TL2 03: TL3	F07	⊙	⊙	○	ALT	Outdoor liquid temperature sensor (TL1, TL2, TL3) trouble	Outdoor liquid temperature sensor (TL1, TL2, TL3) has been open/short-circuited.																																																																																
F08	—	F08	⊙	⊙	○	ALT	Outdoor outside air temperature sensor (TO) trouble	Outdoor outside air temperature sensor (TO) has been open/short-circuited.																																																																																
F09	01: TG1 02: TG2						Outdoor heat exchanger gas side temperature sensor (TG1, TG2) trouble	Outdoor heat exchanger gas side temperature sensors (TG1, TG2) have been open/short-circuited.																																																																																

Check code		Display of receiving unit				Typical problem site	Description of problem	
Outdoor 7-segment display		TCC-LINK central control or main remote controller display	Indicator light block					Flash
	Sub-code		Operation (I)	Timer (⌚)	Ready (⊙)			
F12	01: TS1 03: TS3	F12	⊙	⊙	○	ALT	Outdoor suction temperature sensor (TS1,TS3) trouble	Outdoor suction temperature sensor (TS1,TS3) has been open/short-circuited.
F15	–	F15	⊙	⊙	○	ALT	Outdoor temperature sensor (TE1,TL1) wiring trouble	Wiring error in outdoor temperature sensors (TE1,TL1) has been detected.
F16	–	F16	⊙	⊙	○	ALT	Outdoor pressure sensor (Pd, Ps) wiring trouble	Wiring error in outdoor pressure sensors (Pd, Ps) has been detected.
F23	–	F23	⊙	⊙	○	ALT	Low pressure sensor (Ps) trouble	Output voltage of low pressure sensor (Ps) is zero.
F24	–	F24	⊙	⊙	○	ALT	High pressure sensor (Pd) trouble	Output voltage of high pressure sensor (Pd) is zero or provides abnormal readings when compressors have been turned off.
F31	–	F31	⊙	⊙	○	SIM	Outdoor EEPROM trouble	Outdoor EEPROM is trouble (alarm and shutdown for header unit and continued operation for follower unit)
H05	–	H05	●	⊙	●		Outdoor discharge temperature sensor (TD1) wiring trouble	Wiring/installation trouble or detachment of outdoor discharge temperature sensor (TD1) has been detected.
H06	–	H06	●	⊙	●		Activation of low-pressure protection	Low pressure (Ps) sensor detects abnormally low operating pressure.
H07	–	H07	●	⊙	●		Low oil level protection	Temperature sensor for oil level detection (TK1,TK2,TK4,TK5) detects abnormally low oil level.
H08	01: TK1 sensor trouble 02: TK2 sensor trouble 04: TK4 sensor trouble 05: TK5 sensor trouble	H08	●	⊙	●		Trouble in temperature sensor for oil level detection (TK1,TK2,TK4,TK5)	Temperature sensor for oil level detection (TK1,TK2,TK4,TK5) has been open/short-circuited.
H15	–	H15	●	⊙	●		Outdoor discharge temperature sensor (TD2) wiring trouble	Wiring/installation trouble or detachment of outdoor discharge temperature sensor (TD2) has been detected.
H16	01: TK1 oil circuit trouble 02: TK2 oil circuit trouble 04: TK4 oil circuit trouble 05: TK5 oil circuit trouble	H16	●	⊙	●		Oil level detection circuit trouble	No temperature change is detected by temperature sensor for oil level detection (TK1,TK2,TK4,TK5) despite compressor having been started.
L04	–	L04	⊙	○	⊙	SIM	Duplicated outdoor refrigerant line address	Identical refrigerant line address has been assigned to outdoor units belonging to different refrigerant piping systems.
L06	Number of priority indoor units (check code L05 or L06 depending on individual unit)	L05	⊙	●	⊙	SIM	Duplicated priority indoor unit (as displayed on priority indoor unit)	More than one indoor unit have been set up as priority indoor unit.
		L06	⊙	●	⊙	SIM	Duplicated priority indoor unit (as displayed on indoor unit other than priority indoor unit)	More than one indoor unit have been set up as priority indoor unit.
L08	–	(L08)	⊙	●	⊙	SIM	Indoor group address not set	Address setting have not been performed for one or more indoor units (also detected at indoor end).
L10	–	L10	⊙	○	⊙	SIM	Outdoor capacity not set	Outdoor unit capacity has not been set (after P.C. board replacement).
L17	–	L17	⊙	○	⊙	SIM	Outdoor model incompatibility trouble	Old model outdoor unit (prior to 6 series) has been connected.
L23	–	L23	⊙	○	⊙	SIM	SW setting mistake	Bit 3 and 4 of SW17 are turning on.
L28	–	L28	⊙	○	⊙	SIM	Too many outdoor units connected	More than three outdoor units have been connected.

Check code				Display of receiving unit				Typical problem site	Description of problem																																																																																										
Outdoor 7-segment display				Indicator light block																																																																																															
Sub-code	TCC-LINK central control or main remote controller display				Operation	Timer	Ready	Flash																																																																																											
					⓪	⓪	⓪																																																																																												
L29	<table border="1"> <thead> <tr> <th colspan="2">A3-IPDU</th> <th colspan="2">Fan-IPDU</th> <th colspan="2">A3-IPDU</th> <th colspan="2">Fan-IPDU</th> </tr> <tr> <th>1</th><th>2</th><th>1</th><th>2</th><th>1</th><th>2</th><th>1</th><th>2</th> </tr> </thead> <tbody> <tr><td>01</td><td>○</td><td></td><td></td><td></td><td>10</td><td></td><td></td><td>○</td></tr> <tr><td>02</td><td></td><td>○</td><td></td><td></td><td>11</td><td>○</td><td></td><td>○</td></tr> <tr><td>03</td><td>○</td><td>○</td><td></td><td></td><td>12</td><td></td><td>○</td><td>○</td></tr> <tr><td>08</td><td></td><td></td><td>○</td><td></td><td>13</td><td>○</td><td>○</td><td>○</td></tr> <tr><td>09</td><td>○</td><td></td><td>○</td><td></td><td>18</td><td></td><td>○</td><td>○</td></tr> <tr><td>0A</td><td></td><td>○</td><td>○</td><td></td><td>19</td><td>○</td><td></td><td>○</td></tr> <tr><td>0B</td><td>○</td><td>○</td><td>○</td><td></td><td>1A</td><td></td><td>○</td><td>○</td></tr> <tr><td></td><td></td><td></td><td></td><td></td><td>1B</td><td>○</td><td>○</td><td>○</td></tr> </tbody> </table> <p>Circle (O): IPDU trouble</p>				A3-IPDU		Fan-IPDU		A3-IPDU		Fan-IPDU		1	2	1	2	1	2	1	2	01	○				10			○	02		○			11	○		○	03	○	○			12		○	○	08			○		13	○	○	○	09	○		○		18		○	○	0A		○	○		19	○		○	0B	○	○	○		1A		○	○						1B	○	○	○	L29	⓪	○	⓪	SIM	Trouble in number of IPDUs	There are insufficient number of IPDUs (P.C. boards) in inverter box.
A3-IPDU		Fan-IPDU		A3-IPDU		Fan-IPDU																																																																																													
1	2	1	2	1	2	1	2																																																																																												
01	○				10			○																																																																																											
02		○			11	○		○																																																																																											
03	○	○			12		○	○																																																																																											
08			○		13	○	○	○																																																																																											
09	○		○		18		○	○																																																																																											
0A		○	○		19	○		○																																																																																											
0B	○	○	○		1A		○	○																																																																																											
					1B	○	○	○																																																																																											
L30	Detected indoor unit No.				(L30)	⓪	○	⓪	SIM	Indoor external trouble input (interlock)	Indoor unit has been shut down for external trouble input in one refrigerant line (detected by indoor unit).																																																																																								
P03	-				P03	⓪	●	⓪	ALT	Outdoor discharge (TD1) temperature trouble	Outdoor discharge temperature sensor (TD1) has detected abnormally high temperature.																																																																																								
P05	00: Open phase detected				P05	⓪	●	⓪	ALT	Open phase/power failure	Open phase is detected when power is turned on. Inverter DC voltage is too high (overvoltage) or too low (undervoltage).																																																																																								
	01: Compressor 1 02: Compressor 2									Inverter DC voltage (Vdc) trouble MG-CTT trouble																																																																																									
P07	01: Compressor 1 02: Compressor 2				P07	⓪	●	⓪	ALT	Heat sink overheating trouble	Temperature sensor built into IPM (TH) detects overheating.																																																																																								
P10	Indoor unit No. detected				(P10)	●	⓪	⓪	ALT	Indoor unit overflow	Indoor unit has been shutdown in one refrigerant line due to detection of overflow (detected by indoor unit).																																																																																								
P13	-				P13	●	⓪	⓪	ALT	Outdoor liquid backflow detection trouble	State of refrigerant cycle circuit indicates liquid backflow operation.																																																																																								
P15	01: TS condition 02: TD condition				P15	⓪	●	⓪	ALT	Gas leak detection	Outdoor suction temperature sensor (TS1) detects sustained and repeated high temperatures that exceed standard value.																																																																																								
P17	-				P17	⓪	●	⓪	ALT	Outdoor discharge (TD2) temperature trouble	Outdoor discharge temperature sensor (TD2) detects abnormally high temperature.																																																																																								
P19	Outdoor unit No. detected				P19	⓪	●	⓪	ALT	4-way valve reversing trouble	Abnormality in refrigerating cycle is detected during heating operation.																																																																																								
P20	-				P20	⓪	●	⓪	ALT	Activation of high-pressure protection	High pressure (Pd) sensor detects high pressure that exceeds standard value.																																																																																								

MG-CTT: Magnet contactor

(Check code detected by IPDU featuring in SMMS-e standard outdoor unit - typical examples)

Check code			Display of receiving unit				Typical problem site	Description of proplem
Outdoor 7-segment display		TCC-LINK central control or main remote controller display	Indicator light block			Flash		
	Sub-code		Operation 	Timer 	Ready 			
F13	01: Compressor 1 02: Compressor 2	F13	⊙	⊙	○	ALT	Trouble in temperature sensor built into indoor IPM (TH)	Temperature sensor built into indoor IPM (TH) has been open/short-circuited.
H01	01: Compressor 1 02: Compressor 2	H01	●	⊙	●		Compressor breakdown	Inverter current (Idc) detection circuit detects overcurrent.
H02	01: Compressor 1 02: Compressor 2	H02	●	⊙	●		Compressor trouble (lockup)	Compressor lockup is detected
H03	01: Compressor 1 02: Compressor 2	H03	●	⊙	●		Current detection circuit trouble	Abnormal current is detected while inverter compressor is turned off.
P04	01: Compressor 1 02: Compressor 2	P04	⊙	●	⊙	ALT	Activation of high-pressure SW	High-pressure SW is activated.
P07	01: Compressor 1 02: Compressor 2	P07	⊙	●	⊙	ALT	Heat sink overheating trouble	Temperature sensor built into IPM (TH) detects overheating or has been short-circuited.
P22	#0:Element short circuit #1:Position detection circuit trouble #3:Motor lock trouble #4:Motor current trouble #C:TH Sensor temperature trouble #D:TH Sensor short circuit/release Trouble #E:Vdc voltage Trouble *Put in Fan IPDU No. in [#] mark	P22	⊙	●	⊙	ALT	Outdoor fan IPDU trouble	Outdoor fan IPDU detects trouble.
P26	01: Compressor 1 02: Compressor 2	P26	⊙	●	⊙	ALT	Activation of IPM short-circuit protection	Short-circuit protection for compressor motor driver circuit components is activated (momentary overcurrent).
P29	01: Compressor 1 02: Compressor 2	P29	⊙	●	⊙	ALT	Compressor position detection circuit trouble	Compressor motor position detection trouble is detected.

Note: The above check codes are examples only, and different check codes may be displayed depending on the outdoor unit configuration

### 9-3. Troubleshooting based on information displayed on remote controller

#### Using main remote controller (RBC-AMT32E)

##### (1) Checking and testing

When a trouble occurs to an air conditioner, a check code and indoor unit No. are displayed on the display window of the remote controller.

Check codes are only displayed while the air conditioner is in operation.

If the display has already disappeared, access check code history by following the procedure described below.

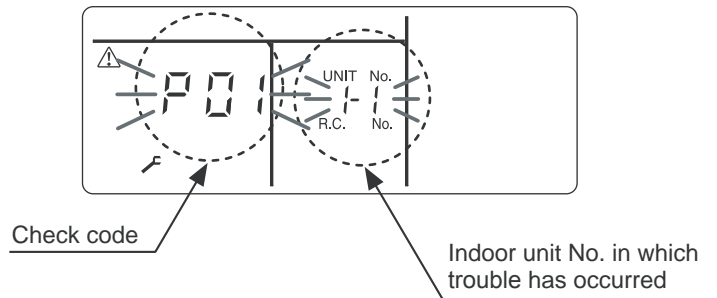

##### (2) Trouble history

The trouble history access procedure is described below (up to four check codes stored in memory). Check code history can be accessed regardless of whether the air conditioner is in operation or shut down.

<Procedure> To be performed when system at rest

- 1 Invoke the **SERVICE CHECK** mode by pressing the **TEST** + **SET** buttons simultaneously and holding for at least **4 seconds**.

The letters "SERVICE CHECK" light up, and the check code "01" is displayed, indicating the trouble history. This is accompanied by the indoor unit No. to which the trouble history is related and a check code.

- 2 To check other trouble history items, press the **TEMP.** button to select another check code.

Check code "01" (latest) → Check code "04" (oldest)  
**Note:** Trouble history contains four items.

- 3 When the **TEST** button is pushed, normal display is restored.

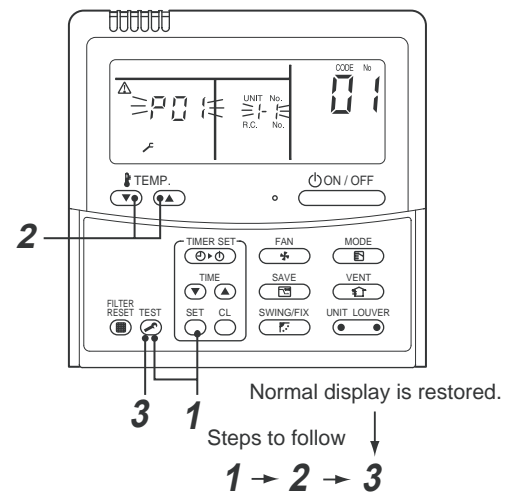

#### REQUIREMENT

Do not push the **CL** button as it would erase the whole trouble history of the indoor unit.

#### How to read displayed information

<7-segment display symbols>



<Corresponding alphanumerical letters>

0 1 2 3 4 5 6 7 8 9 A b C d E F H J L P

## Using TCC-LINK central control remote controller (TCB-SC642TLE2)

### (1) Checking and testing

When a trouble occurs to an air conditioner, a check code and indoor unit No. are displayed on the display window of the remote controller. Check codes are only displayed while the air conditioner is in operation.

If the display has already disappeared, access trouble history by following the procedure described below.

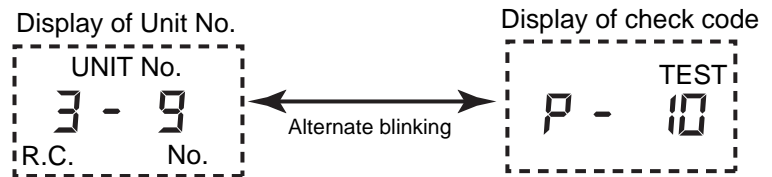

### (2) Trouble history

The trouble history access procedure is described below (up to four trouble stored in memory).

Trouble history can be accessed regardless of whether the air conditioner is in operation or shut down.

- 1** Push the + buttons simultaneously and hold for at least 4 seconds.
- 2** The letters “ SERVICE CHECK” light up, and the check code “01” is displayed.
- 3** When a group No. is selected (blinking), if there is a trouble history, the UNIT No. and the latest trouble history information are displayed alternately.

\* During this procedure, the temperature setting feature is unavailable.

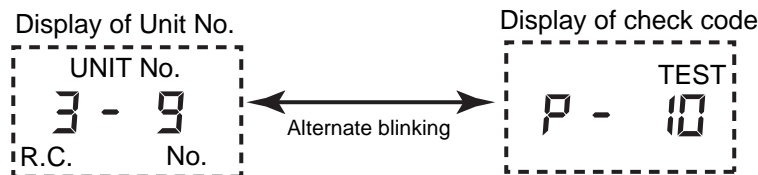

- 4** To check other trouble history items, push the button to select another check code (01-04.).
- 5** To check check code relating to another group, push (ZONE) and (GROUP) buttons to select a group No.  
Do not push the button as it would erase the whole trouble history of the selected group.
- 6** To finish off the service check, push the button.

## Using indoor unit indicators (receiving unit light block) (wireless type)

To identify the check code, check the 7-segment display on the header unit. To check for check codes not displayed on the 7-segment display, consult the “List of Check Codes (Indoor Unit)” in “9-2. Troubleshooting method”.

● : Goes off ○ : Lighting ☀ : Blinking (0.5 seconds)

Light block	Check code	Cause of trouble			
Operation ●    Timer ●    Ready ● All lights out	–	Power turned off or trouble in wiring between receiving and indoor units			
Operation ☀    Timer ●    Ready ● Blinking	E01	Trouble reception	Receiving unit	Trouble or poor contact in wiring between receiving unit and indoor units	
	E02	Trouble transmission			
	E03	Loss of communication			
		E08	Duplicated indoor unit No. (address)	Setting trouble	
		E09	Duplicated master remote controller		
		E10	UART communication trouble		
		E11	Communication trouble between Application control kit and indoor unit P.C. board		
		E12	Automatic address starting trouble		
		E18	Error or poor contact in wiring between indoor units, indoor power turned off		
Operation ●    Timer ●    Ready ☀ Blinking		E04	Error or poor contact in wiring between indoor and outdoor units (loss of indoor-outdoor communication)		
		E06	Trouble reception in indoor-outdoor communication (dropping out of indoor unit)		
	E07	Trouble transmission in indoor-outdoor communication			
	E15	Indoor unit not found during automatic address setting			
	E16	Too many indoor units connected / overloading			
	E19	Trouble in number of outdoor header units			
	E20	Detection of refrigerant piping communication trouble during automatic address setting			
	E23	Trouble transmission in outdoor-outdoor communication			
	E25	Duplicated follower outdoor address			
	E26	Trouble reception in outdoor-outdoor communication, dropping out of outdoor unit			
	E28	Outdoor follower unit trouble			
	E31	IPDU communication trouble			
	Operation ●    Timer ☀    Ready ☀ Alternate blinking	P01	Indoor AC fan trouble		
P10		Indoor overflow trouble			
P12		Indoor DC fan trouble			
P13		Outdoor liquid backflow detection trouble			
Operation ☀    Timer ●    Ready ☀ Alternate blinking	P03	Outdoor discharge (TD1) temperature trouble			
	P04	Activation of outdoor high-pressure SW			
	P05	Open phase / power failure			
		Inverter DC voltage (Vdc) trouble			
		MG-CTT trouble			
	P07	Outdoor heat sink overheating trouble - Poor cooling of electrical component (IGBT) of outdoor unit			
	P15	Gas leak detection - insufficient refrigerant charging			
	P17	Outdoor discharge (TD2) temperature trouble			
	P18	Outdoor discharge (TD3) temperature trouble			
	P19	Outdoor 4-way valve reversing trouble			
	P20	Activation of high-pressure protection			
	P22	Outdoor fan IPDU trouble			
	P26	Outdoor G-Tr short-circuit trouble			
	P29	Compressor position detection circuit trouble			
	P31	Shutdown of other indoor unit in group due to trouble (group follower unit trouble)			



MG-CTT: Magnet contactor

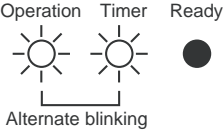
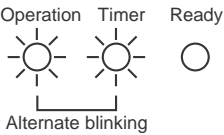
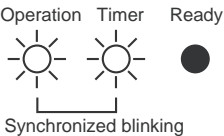
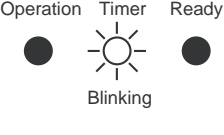
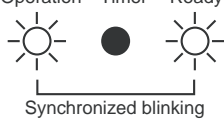
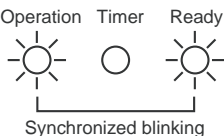

Light block	Check code	Cause of trouble	
Operation Timer Ready  Alternate blinking	F01	Heat exchanger temperature sensor (TCJ) trouble	Indoor unit temperature sensor trouble
	F02	Heat exchanger temperature sensor (TC2) trouble	
	F03	Heat exchanger temperature sensor (TC1) trouble	
	F10	Ambient temperature sensor (TA) trouble	
	F11	Discharge temperature sensor (TF) trouble	
Operation Timer Ready  Alternate blinking	F04	Discharge temperature sensor (TD1) trouble	Outdoor unit temperature sensor trouble
	F05	Discharge temperature sensor (TD2) trouble	
	F06	Heat exchanger temperature sensor (TE1, TE2) trouble	
	F07	Liquid temperature sensor (TL) trouble	
	F08	Outside air temperature sensor (TO) trouble	
	F12	Suction temperature sensor (TS1) trouble	
	F13	Heat sink sensor (TH) trouble	
	F15	Wiring trouble in heat exchanger sensor (TE1) and liquid temperature sensor (TL) Outdoor unit temperature sensor wiring / installation trouble	
	F16	Wiring trouble in outdoor high pressure sensor (Pd) and low pressure sensor (Ps) Outdoor pressure sensor wiring trouble	
	F22	Outdoor discharge temperature sensor (TD3) trouble	
		F23	Low pressure sensor (Ps) trouble
F24		High pressure sensor (Pd) trouble	
Operation Timer Ready  Synchronized blinking	F29	Fault in indoor EEPROM	
Operation Timer Ready  Blinking	H01	Compressor breakdown	Outdoor unit compressor related trouble
	H02	Compressor lockup	
	H03	Current detection circuit trouble	
	H05	Wiring / installation error or detachment of outdoor discharge temperature sensor (TD1)	
	H06	Abnormal drop in low-pressure sensor (Ps) reading	Protective shutdown of outdoor unit
	H07	Abnormal drop in oil level	
	H08	Trouble in temperature sensor for oil level detection circuit (TK1, TK2, TK3, TK4 or TK5)	
	H15	Wiring / installation trouble or detachment of outdoor discharge temperature sensor (TD2)	
	H16	Oil level detection circuit trouble - Trouble in outdoor unit TK1, TK2, TK3, TK4 or TK5 circuit	
	H25	Wiring / installation trouble or detachment of outdoor discharge temperature sensor (TD3)	
Operation Timer Ready  Synchronized blinking	L03	Duplicated indoor group header unit	
	L05	Duplicated priority indoor unit (as displayed on priority indoor unit)	
	L06	Duplicated priority indoor unit (as displayed on indoor unit other than priority indoor unit)	
	L07	Connection of group control cable to stand-alone indoor unit	
	L08	Indoor group address not set	
	L09	Indoor capacity not set	
Operation Timer Ready  Synchronized blinking	L04	Duplicated outdoor refrigerant line address	
	L10	Outdoor capacity not set	
	L17	Outdoor model incompatibility trouble	
	L18	Flow selector units trouble	
	L20	Duplicated central control address	
	L28	Too many outdoor units connected	
	L29	Trouble in number of IPDUs	
	L30	Indoor external interlock trouble	

Light block	Check code	Cause of trouble
<p>Operation    Timer    Ready</p>  <p>Synchronized blinking</p>	F31	Outdoor EEPROM trouble

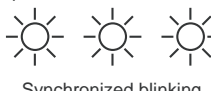
**Other (indications not involving check code)**

Light block	Check code	Cause of trouble
<p>Operation    Timer    Ready</p>  <p>Synchronized blinking</p>	-	Test run in progress
<p>Operation    Timer    Ready</p>  <p>Alternate blinking</p>	-	Setting incompatibility (automatic cooling / heating setting for model incapable of it and heating setting for cooling-only model)

## 9-4. Check Codes Displayed on Remote Controller and SMMS-e Outdoor Unit (7-Segment Display on I/F Board) and Locations to Be Checked

For other types of outdoor units, refer to their own service manuals.

Check code		Location of detection	Description	System status	Trouble detection condition(s)	Check items (locations)	
Main remote controller	Outdoor 7-segment display						
	Check code	Sub-code					
E01	-	-	Remote controller	Indoor-remote controller communication trouble (detected at remote controller end)	Stop of corresponding unit	Communication between indoor P.C. board and remote controller is disrupted.	<ul style="list-style-type: none"> <li>• Check remote controller inter-unit tie cable (A/B).</li> <li>• Check for broken wire or connector bad contact.</li> <li>• Check indoor power supply.</li> <li>• Check for defect in indoor P.C. board.</li> <li>• Check remote controller address settings (when two remote controllers are in use).</li> <li>• Check remote controller P.C. board.</li> </ul>
E02	-	-	Remote controller	Remote controller transmission trouble	Stop of corresponding unit	Signal cannot be transmitted from remote controller to indoor unit.	<ul style="list-style-type: none"> <li>• Check internal transmission circuit of remote controller.</li> <li>--- Replace remote controller as necessary.</li> </ul>
E03	-	-	Indoor unit	Indoor-remote controller communication trouble (detected at indoor end)	Stop of corresponding unit	There is no communication from remote controller (including wireless) or network adaptor.	<ul style="list-style-type: none"> <li>• Check remote controller and network adaptor wiring.</li> </ul>
E04	-	-	Indoor unit	Indoor-outdoor communication circuit trouble (detected at indoor end)	Stop of corresponding unit	Indoor unit is not receiving signal from outdoor unit.	<ul style="list-style-type: none"> <li>• Check order in which power was turned on for indoor and outdoor units.</li> <li>• Check indoor address setting.</li> <li>• Check indoor-outdoor tie cable.</li> <li>• Check outdoor terminator resistor setting (SW30, Bit 2).</li> </ul>
E06	E06	No. of indoor units from which signal is received normally	I/F	Signal lack of indoor unit	All stop	Indoor unit initially communicating normally fails to return signal for specified length of time.	<ul style="list-style-type: none"> <li>• Check power supply to indoor unit. (Is power turned on?)</li> <li>• Check connection of indoor-outdoor communication cable.</li> <li>• Check connection of communication connectors on indoor P.C. board.</li> <li>• Check connection of communication connectors on outdoor P.C. board.</li> <li>• Check for defect in indoor P.C. board.</li> <li>• Check for defect in outdoor P.C. board (I/F).</li> </ul>
-	E07	-	I/F	Indoor-outdoor communication circuit trouble (detected at outdoor end)	All stop	Signal cannot be transmitted from outdoor to indoor units for 30 seconds continuously.	<ul style="list-style-type: none"> <li>• Check outdoor terminator resistor setting (SW30, Bit 2).</li> <li>• Check connection of indoor-outdoor communication circuit.</li> </ul>

Check code			Location of detection	Description	System status	Trouble detection condition(s)	Check items (locations)
Main remote controller	Outdoor 7-segment display						
	Check code	Sub-code					
E08	E08	Duplicated indoor address	Indoor unit I/F	Duplicated indoor address	All stop	More than one indoor unit are assigned same address.	<ul style="list-style-type: none"> <li>• Check indoor addresses.</li> <li>• Check for any change made to remote controller connection (group/individual) since indoor address setting.</li> </ul>
E09	-	-	Remote controller	Duplicated master remote controller	Stop of corresponding unit	In two remote controller configuration (including wireless), both controllers are set up as master. (Header indoor unit is shut down with alarm, while follower indoor units continue operating.)	<ul style="list-style-type: none"> <li>• Check remote controller settings.</li> <li>• Check remote controller P.C. boards.</li> </ul>
E10	-	-	Indoor unit	UART communication trouble	Stop of corresponding unit	Communication cannot be established/maintained upon turning on of power or during communication.	<ul style="list-style-type: none"> <li>• Check for defect in indoor P.C. board (MCC-1643 and MCC-1610)</li> </ul>
E11	-	Communication error between Application control kit and indoor unit	Indoor unit	Indoor Application control kit communication trouble	Stop	Displayed when trouble is detected	<ol style="list-style-type: none"> <li>1. Check connector indoor unit (CN521(red)) Application control kit (CN1 (red))</li> <li>2. Check connection of indoor-Application control kit communication line.</li> <li>3. Check indoor P.C. board.</li> <li>4. Check Application control kit P.C. board.</li> </ol>
E12	E12	01: Indoor-outdoor communication 02: Outdoor-outdoor communication	I/F	Automatic address starting trouble	All stop	<ul style="list-style-type: none"> <li>• Indoor automatic address setting is started while automatic address setting for equipment in other refrigerant line is in progress.</li> <li>• Outdoor automatic address setting is started while automatic address setting for indoor units is in progress.</li> </ul>	<ul style="list-style-type: none"> <li>• Perform automatic address setting again after disconnecting communication cable to that refrigerant line.</li> </ul>
E15	E15	-	I/F	Indoor unit not found during automatic address setting	All stop	Indoor unit cannot be detected after indoor automatic address setting is started.	<ul style="list-style-type: none"> <li>• Check connection of indoor-outdoor communication line.</li> <li>• Check for error in indoor power supply system.</li> <li>• Check for noise from other devices.</li> <li>• Check for power failure.</li> <li>• Check for defect in indoor P.C. board.</li> </ul>
E16	E16	00: Overloading 01 -: No. of units connected	I/F	Too many indoor units connected	All stop	<ul style="list-style-type: none"> <li>• Combined capacity of indoor units exceeds 135% of combined capacity of outdoor units.</li> </ul> <p><b>Note:</b> If this code comes up after backup setting for outdoor unit failure is performed, perform "No overloading detected" setting.</p> <p>&lt;"No overloading detected" setting method&gt; Turn on SW09/Bit 2 on I/F P.C. board of outdoor header unit.</p> <ul style="list-style-type: none"> <li>• More than 64 indoor units are connected.</li> </ul>	<ul style="list-style-type: none"> <li>• Check capacities of indoor units connected.</li> <li>• Check combined HP capacities of indoor units.</li> <li>• Check HP capacity settings of outdoor units.</li> <li>• Check No. of indoor units connected.</li> <li>• Check for defect in outdoor P.C. board (I/F).</li> </ul>

Check code			Location of detection	Description	System status	Trouble detection condition(s)	Check items (locations)
Main remote controller	Outdoor 7-segment display						
	Check code	Sub-code					
E18	-	-	Indoor unit	Trouble in communication between indoor header and follower units	Stop of corresponding unit	Periodic communication between indoor header and follower units cannot be maintained.	<ul style="list-style-type: none"> <li>• Check remote controller wiring.</li> <li>• Check indoor power supply wiring.</li> <li>• Check P.C. boards of indoor units.</li> </ul>
E19	E19	00: No header unit 02: Two or more header units	I/F	Trouble in number of outdoor header units	All stop	<ul style="list-style-type: none"> <li>• There are more than one outdoor header units in one line.</li> <li>• There is no outdoor header unit in one line.</li> </ul>	<ul style="list-style-type: none"> <li>• Outdoor header unit is outdoor unit to which indoor-outdoor tie cable (U1,U2) is connected.</li> <li>• Check connection of indoor-outdoor communication line.</li> <li>• Check for defect in outdoor P.C. board (I/F).</li> </ul>
E20	E20	01: Connection of outdoor unit from other line 02: Connection of indoor unit from other line	I/F	Connection to other line found during automatic address setting	All stop	Equipment from other line is found to have been connected when indoor automatic address setting is in progress.	Disconnect inter-line tie cable in accordance with automatic address setting method explained in "Address setting" section.
E23	E23	-	I/F	Outdoor-outdoor communication transmission error	All stop	Signal cannot be transmitted to other outdoor units for at least 30 seconds continuously.	<ul style="list-style-type: none"> <li>• Check power supply to outdoor units. (Is power turned on?)</li> <li>• Check connection of tie cables between outdoor units for bad contact or broken wire.</li> <li>• Check communication connectors on outdoor P.C. boards.</li> <li>• Check for defect in outdoor P.C. board (I/F).</li> <li>• Check termination resistance setting for communication between outdoor units.</li> </ul>
E25	E25	-	I/F	Duplicated follower outdoor address	All stop	There is duplication in outdoor addresses set manually.	<b>Note: Do not set outdoor addresses manually.</b>
E26	E26	Address of outdoor unit from which signal is not received normally	I/F	Signal lack of outdoor unit	All stop	Outdoor unit initially communicating normally fails to return signal for specified length of time.	<ul style="list-style-type: none"> <li>• Backup setting is being used for outdoor units.</li> <li>• Check power supply to outdoor unit. (Is power turned on?)</li> <li>• Check connection of tie cables between outdoor units for bad contact or broken wire.</li> <li>• Check communication connectors on outdoor P.C. boards.</li> <li>• Check for defect in outdoor P.C. board (I/F).</li> </ul>
E28	E28	Detected outdoor unit No.	I/F	Outdoor follower unit trouble	All stop	Outdoor header unit receives error code from outdoor follower unit.	<ul style="list-style-type: none"> <li>• Check check code displayed on outdoor follower unit.</li> </ul> <p>&lt;Convenient functions&gt; If SW04 is pressed and held for at least 1 second while [E28] is displayed on the 7-segment display of outdoor header unit, the fan of the outdoor unit that has been shut down due to an error comes on. If SW04 and SW05 are pressed simultaneously, the fans of normal outdoor units come on. To stop the fan or fans, press SW05 on its own.</p>

Check code			Location of detection	Description	System status	Trouble detection condition(s)	Check items (locations)																																																																																																		
Main remote controller	Outdoor 7-segment display																																																																																																								
	Check code	Sub-code																																																																																																							
E31	E31	<table border="1"> <thead> <tr> <th rowspan="2"></th> <th colspan="2">A3-IPDU</th> <th colspan="2">Fan-IPDU</th> <th rowspan="2"></th> <th colspan="2">A3-IPDU</th> <th colspan="2">Fan-IPDU</th> </tr> <tr> <th>1</th> <th>2</th> <th>1</th> <th>2</th> <th>1</th> <th>2</th> <th>1</th> <th>2</th> </tr> </thead> <tbody> <tr> <td>01</td> <td>○</td> <td></td> <td></td> <td></td> <td>10</td> <td></td> <td></td> <td></td> <td>○</td> </tr> <tr> <td>02</td> <td></td> <td>○</td> <td></td> <td></td> <td>11</td> <td>○</td> <td></td> <td></td> <td>○</td> </tr> <tr> <td>03</td> <td>○</td> <td>○</td> <td></td> <td></td> <td>12</td> <td></td> <td>○</td> <td></td> <td>○</td> </tr> <tr> <td>08</td> <td></td> <td></td> <td>○</td> <td></td> <td>13</td> <td>○</td> <td></td> <td></td> <td>○</td> </tr> <tr> <td>09</td> <td>○</td> <td></td> <td></td> <td>○</td> <td>18</td> <td></td> <td></td> <td></td> <td>○</td> </tr> <tr> <td>0A</td> <td></td> <td>○</td> <td></td> <td></td> <td>19</td> <td>○</td> <td></td> <td></td> <td>○</td> </tr> <tr> <td>0B</td> <td>○</td> <td>○</td> <td>○</td> <td></td> <td>1A</td> <td></td> <td>○</td> <td>○</td> <td>○</td> </tr> <tr> <td></td> <td></td> <td></td> <td></td> <td></td> <td>1B</td> <td>○</td> <td>○</td> <td>○</td> <td>○</td> </tr> </tbody> </table> <p>Circle (O): IPDU trouble</p>		A3-IPDU		Fan-IPDU			A3-IPDU		Fan-IPDU		1	2	1	2	1	2	1	2	01	○				10				○	02		○			11	○			○	03	○	○			12		○		○	08			○		13	○			○	09	○			○	18				○	0A		○			19	○			○	0B	○	○	○		1A		○	○	○						1B	○	○	○	○	I/F	IPDU communication trouble	All stop	Communication is disrupted between IPDUs (P.C. boards) in inverter box.	<ul style="list-style-type: none"> <li>Check wiring and connectors involved in communication between IPDU-I/F P.C. board for bad contact or broken wire.</li> <li>Check for defect in outdoor P.C. board (I/F, A3-IPDU or Fan IPDU).</li> <li>Check for external noise.</li> </ul>
				A3-IPDU		Fan-IPDU				A3-IPDU		Fan-IPDU																																																																																													
1	2		1	2	1	2	1	2																																																																																																	
01	○				10				○																																																																																																
02		○			11	○			○																																																																																																
03	○	○			12		○		○																																																																																																
08			○		13	○			○																																																																																																
09	○			○	18				○																																																																																																
0A		○			19	○			○																																																																																																
0B	○	○	○		1A		○	○	○																																																																																																
					1B	○	○	○	○																																																																																																
		80		Communication trouble between MCU and Sub MCU	All stop	Communication between MCU and Sub MCU stopped.	<ul style="list-style-type: none"> <li>Operation of power supply reset (OFF for 60 seconds or more)</li> <li>Outdoor I/F PC board error check</li> </ul>																																																																																																		
F01	-	-	Indoor unit	Indoor TCJ sensor trouble	Stop of corresponding unit	Sensor resistance is infinity or zero (open/short circuit).	<ul style="list-style-type: none"> <li>Check connection of TCJ sensor connector and wiring.</li> <li>Check resistance characteristics of TCJ sensor.</li> <li>Check for defect in indoor P.C. board.</li> </ul>																																																																																																		
F02	-	-	Indoor unit	Indoor TC2 sensor trouble	Stop of corresponding unit	Sensor resistance is infinity or zero (open/short circuit).	<ul style="list-style-type: none"> <li>Check connection of TC2 sensor connector and wiring.</li> <li>Check resistance characteristics of TC2 sensor.</li> <li>Check for defect in indoor P.C. board.</li> </ul>																																																																																																		
F03	-	-	Indoor unit	Indoor TC1 sensor trouble	Stop of corresponding unit	Sensor resistance is infinity or zero (open/short circuit).	<ul style="list-style-type: none"> <li>Check connection of TC1 sensor connector and wiring.</li> <li>Check resistance characteristics of TC1 sensor.</li> <li>Check for defect in indoor P.C. board.</li> </ul>																																																																																																		
F04	F04	-	I/F	TD1 sensor trouble	All stop	Sensor resistance is infinity or zero (open/short circuit).	<ul style="list-style-type: none"> <li>Check connection of TD1 sensor connector.</li> <li>Check resistance characteristics of TD1 sensor.</li> <li>Check for defect in outdoor P.C. board (I/F).</li> </ul>																																																																																																		
F05	F05	-	I/F	TD2 sensor trouble	All stop	Sensor resistance is infinity or zero (open/short circuit).	<ul style="list-style-type: none"> <li>Check connection of TD2 sensor connector.</li> <li>Check resistance characteristics of TD2 sensor.</li> <li>Check for defect in outdoor P.C. board (I/F).</li> </ul>																																																																																																		
F06	F06	01: TE1 sensor trouble 02: TE2 sensor trouble	I/F	TE1/TE2 sensor trouble	All stop	Sensor resistance is infinity or zero (open/short circuit).	<ul style="list-style-type: none"> <li>Check connection of TE1/TE2 sensor connectors.</li> <li>Check resistance characteristics of TE1/TE2 sensors.</li> <li>Check for defect in outdoor P.C. board (I/F).</li> </ul>																																																																																																		
F07	F07	01: TL1 sensor trouble 02: TL2 sensor trouble 03: TL3 sensor trouble	I/F	TL1/TL2/TL3 sensor trouble	All stop	Sensor resistance is infinity or zero (open/short circuit).	<ul style="list-style-type: none"> <li>Check connection of TL1/TL2/TL3 sensor connector.</li> <li>Check resistance characteristics of TL1/TL2/TL3 sensor.</li> <li>Check for defect in outdoor P.C. board (I/F).</li> </ul>																																																																																																		

Check code			Location of detection	Description	System status	Trouble detection condition(s)	Check items (locations)
Main remote controller	Outdoor 7-segment display						
	Check code	Sub-code					
F08	F08	–	I/F	TO sensor trouble	All stop	Sensor resistance is infinity or zero (open/short circuit).	<ul style="list-style-type: none"> <li>• Check connection of TO sensor connector.</li> <li>• Check resistance characteristics of TO sensor.</li> <li>• Check for defect in outdoor P.C. board (I/F).</li> </ul>
F09	F09	01: TG1 sensor trouble 02: TG2 sensor trouble	I/F	TG1/TG2 sensor trouble	All stop	Sensor resistance is infinity or zero (open/short circuit).	<ul style="list-style-type: none"> <li>• Check connection of TG1/TG2 sensor connectors.</li> <li>• Check resistance characteristics of TG1/TG2 sensors.</li> <li>• Check for defect in outdoor P.C. board (I/F).</li> </ul>
F10	–	–	Indoor unit	Indoor TA sensor trouble	Stop of corresponding unit	Sensor resistance is infinity or zero (open/short circuit).	<ul style="list-style-type: none"> <li>• Check connection of TA sensor connector and wiring.</li> <li>• Check resistance characteristics of TA sensor.</li> <li>• Check for defect in indoor P.C. board.</li> </ul>
F11	–	–	Indoor unit	Indoor TF sensor trouble	Stop of corresponding unit	Sensor resistance is infinity or zero (open/short circuit).	<ul style="list-style-type: none"> <li>• Check connection of TF sensor connector and wiring.</li> <li>• Check resistance characteristics of TF sensor.</li> <li>• Check for defect in indoor P.C. board.</li> </ul>
F12	F12	01: TS1 sensor trouble 03: TS3 sensor trouble	I/F	TS1/TS3 sensor trouble	All stop	Sensor resistance is infinity or zero (open/short circuit).	<ul style="list-style-type: none"> <li>• Check connection of TS1/TS3 sensor connector</li> <li>• Check resistance characteristics of TS1/TS3 sensor.</li> <li>• Check for defect</li> </ul>
F13	F13	01: Compressor 1 side 02: Compressor 2 side	IPDU	TH sensor trouble	All stop	Sensor resistance is infinity or zero (open/short circuit).	<ul style="list-style-type: none"> <li>• Defect in IPM built-in temperature sensor → Replace A3-IPDU P.C. board.</li> </ul>
F15	F15	–	I/F	Outdoor temperature sensor wiring trouble (TE1, TL1)	All stop	During compressor operation in HEAT mode, TL1 continuously provides temperature reading higher than indicated by TL1 by at least specified margin for 3 minutes or more.	<ul style="list-style-type: none"> <li>• Check installation of TE1 and TL1 sensors.</li> <li>• Check resistance characteristics of TE1 and TL1 sensors.</li> <li>• Check for outdoor P.C. board (I/F) trouble.</li> </ul>
F16	F16	–	I/F	Outdoor pressure sensor wiring trouble (Pd, Ps)	All stop	Readings of high-pressure Pd sensor and low-pressure Ps sensor are switched. Output voltages of both sensors are zero.	<ul style="list-style-type: none"> <li>• Check connection of high-pressure Pd sensor connector.</li> <li>• Check connection of low-pressure Ps sensor connector.</li> <li>• Check for defect in pressure sensors Pd and Ps.</li> <li>• Check for error in outdoor P.C. board (I/F).</li> <li>• Check for deficiency in compressive output of compressor.</li> </ul>
F23	F23	–	I/F	Ps sensor trouble	All stop	Output voltage of Ps sensor is zero.	<ul style="list-style-type: none"> <li>• Check for connection trouble involving Ps sensor and Pd sensor connectors.</li> <li>• Check connection of Ps sensor connector.</li> <li>• Check for defect in Ps sensor.</li> <li>• Check for deficiency in compressive output of compressor.</li> <li>• Check for defect in 4-way valve.</li> <li>• Check for defect in outdoor P.C. board (I/F).</li> <li>• Check for defect in SV4 circuit.</li> </ul>
F24	F24	–	I/F	Pd sensor trouble	All stop	Output voltage of Pd sensor is zero (sensor open-circuited). Pd > 4.15MPa despite compressor having been turned off.	<ul style="list-style-type: none"> <li>• Check connection of Pd sensor connector.</li> <li>• Check for defect in Pd sensor.</li> <li>• Check for defect in outdoor P.C. board (I/F).</li> </ul>

Check code			Location of detection	Description	System status	Trouble detection condition(s)	Check items (locations)
Main remote controller	Outdoor 7-segment display						
	Check code	Sub-code					
F29	–	–	Indoor unit	Other indoor trouble	Stop of corresponding unit	Indoor P.C. board does not operate normally.	<ul style="list-style-type: none"> <li>• Check for defect in indoor P.C. board (faulty EEPROM)</li> </ul>
F31	F31	–	I/F	Outdoor EEPROM trouble	All stop *1	Outdoor P.C. board (I/F) does not operate normally.	<ul style="list-style-type: none"> <li>• Check power supply voltage.</li> <li>• Check power supply noise.</li> <li>• Check for defect in outdoor P.C. board (I/F).</li> </ul>
H01	H01	01: Compressor 1 side 02: Compressor 2 side	IPDU	Compressor breakdown	All stop	Inverter current detection circuit detects overcurrent and shuts system down.	<ul style="list-style-type: none"> <li>• Check power supply voltage. (AC380-415V ± 10%).</li> <li>• Check for defect in compressor.</li> <li>• Check for possible cause of abnormal overloading.</li> <li>• Check for defect in outdoor P.C. board (A3-IPDU).</li> </ul>
H02	H02	01: Compressor 1 side 02: Compressor 2 side	IPDU	Compressor trouble (lockup) MG-CTT trouble	All stop	Overcurrent is detected several seconds after startup of inverter compressor.	<ul style="list-style-type: none"> <li>• Check for defect in compressor.</li> <li>• Check power supply voltage. (AC380-415V ± 10%).</li> <li>• Check compressor system wiring, particularly for open phase.</li> <li>• Check connection of connectors/terminals on A3-IPDU P.C. board.</li> <li>• Check conductivity of case heater. (Check for refrigerant problem inside compressor.)</li> <li>• Check for defect in outdoor P.C. board (A3-IPDU).</li> <li>• Check outdoor MG-CTT.</li> </ul>
H03	H03	01: Compressor 1 side 02: Compressor 2 side	IPDU	Current detection circuit trouble	All stop	Current flow of at least specified magnitude is detected despite inverter compressor having been shut turned off.	<ul style="list-style-type: none"> <li>• Check current detection circuit wiring.</li> <li>• Check defect in outdoor P.C. board (A3-IPDU).</li> </ul>
H05	H05	–	I/F	TD1 sensor miswiring (incomplete insertion)	All stop	Discharge temperature of compressor 1 (TD1) does not increase despite compressor being in operation.	<ul style="list-style-type: none"> <li>• Check installation of TD1 sensor.</li> <li>• Check connection of TD1 sensor connector and wiring.</li> <li>• Check resistance characteristics of TD1 sensor.</li> <li>• Check for defect in outdoor P.C. board (I/F).</li> </ul>
H06	H06	–	I/F	Activation of low-pressure protection	All stop	Low-pressure Ps sensor detects operating pressure lower than 0.02MPa.	<ul style="list-style-type: none"> <li>• Check service valves to confirm full opening (both gas and liquid sides).</li> <li>• Check outdoor PMVs for clogging (PMV1, 3).</li> <li>• Check for defect in SV2 or SV4 circuits.</li> <li>• Check for defect in low-pressure Ps sensor.</li> <li>• Check indoor filter for clogging.</li> <li>• Check valve opening status of indoor PMV.</li> <li>• Check refrigerant piping for clogging.</li> <li>• Check operation of outdoor fan (during heating).</li> <li>• Check for insufficiency in refrigerant quantity.</li> </ul>

MG-CTT: Magnet contactor

\*1 Total shutdown in case of header unit  
Continued operation in case of follower unit



Check code			Location of detection	Description	System status	Trouble detection condition(s)	Check items (locations)
Main remote controller	Outdoor 7-segment display						
	Check code	Sub-code					
H07	H07	–	I/F	Low oil level protection	All stop	Operating compressor detects continuous state of low oil level for about 2 hours.	<p>&lt;All outdoor units in corresponding line to be checked&gt;</p> <ul style="list-style-type: none"> <li>• Check balance pipe service valve to confirm full opening.</li> <li>• Check connection and installation of TK1, TK2, TK4, and TK5 sensors.</li> <li>• Check resistance characteristics of TK1, TK2, TK4, and TK5 sensors.</li> <li>• Check for gas or oil leak in same line.</li> <li>• Check for refrigerant problem inside compressor casing.</li> <li>• Check SV3A, SV3B, SV3C, SV3D valves for defect.</li> <li>• Check oil return circuit of oil separator for clogging.</li> <li>• Check oil equalizing circuit for clogging.</li> </ul>
H08	H08	01: TK1 sensor trouble 02: TK2 sensor trouble 04: TK4 sensor trouble 05: TK5 sensor trouble	I/F	Error in temperature sensor for oil level detection	All stop	Sensor resistance is infinity or zero (open/short circuit).	<ul style="list-style-type: none"> <li>• Check connection of TK1 sensor connector.</li> <li>• Check resistance characteristics of TK1 sensor.</li> <li>• Check for defect in outdoor P.C. board (I/F).</li> </ul>
					All stop	Sensor resistance is infinity or zero (open/short circuit).	<ul style="list-style-type: none"> <li>• Check connection of TK2 sensor connector.</li> <li>• Check resistance characteristics of TK2 sensor.</li> <li>• Check for defect in outdoor P.C. board (I/F).</li> </ul>
					All stop	Sensor resistance is infinity or zero (open/short circuit).	<ul style="list-style-type: none"> <li>• Check connection of TK4 sensor connector.</li> <li>• Check resistance characteristics of TK4 sensor.</li> <li>• Check for defect in outdoor P.C. board (I/F).</li> </ul>
					All stop	Sensor resistance is infinity or zero (open/short circuit).	<ul style="list-style-type: none"> <li>• Check connection of TK5 sensor connector.</li> <li>• Check resistance characteristics of TK5 sensor.</li> <li>• Check for defect in outdoor P.C. board (I/F).</li> </ul>
H15	H15	–	I/F	TD2 sensor miswiring (incomplete insertion)	All stop	Discharge temperature of (TD2) does not increase despite compressor 2 being in operation.	<ul style="list-style-type: none"> <li>• Check installation of TD2 sensor.</li> <li>• Check connection of TD2 sensor connector and wiring.</li> <li>• Check resistance characteristics of TD2 sensor.</li> <li>• Check for defect in outdoor P.C. board (I/F).</li> </ul>

		Check code		Location of detection	Description	System status	Trouble detection condition(s)	Check items (locations)
Main remote controller	Outdoor 7-segment display							
	Check code	Sub-code						
H16	H16	01: TK1 oil circuit trouble 02: TK2 oil circuit trouble 04: TK4 oil circuit trouble 05: TK5 oil circuit trouble	I/F	Oil level detection circuit error	All stop	No temperature change is detected by TK1 despite compressor 1 having been started.	<ul style="list-style-type: none"> <li>• Check for disconnection of TK1 sensor.</li> <li>• Check resistance characteristics of TK1 sensor.</li> <li>• Check for connection error involving TK1, TK2, , TK4, and TK5 sensors</li> <li>• Check for clogging in oil equalizing circuit capillary and faulty operation in check valve.</li> <li>• Check for refrigerant entrapment inside compressor.</li> </ul>	
						No temperature change is detected by TK2 despite compressor 2 having been started.	<ul style="list-style-type: none"> <li>• Check for disconnection of TK2 sensor.</li> <li>• Check resistance characteristics of TK2 sensor.</li> <li>• Check for connection error involving TK1, TK2, , TK4, and TK5 sensors</li> <li>• Check for clogging in oil equalizing circuit capillary and faulty operation in check valve.</li> <li>• Check for refrigerant entrapment inside compressor.</li> </ul>	
						No temperature change is detected by TK4 despite compressor having been started.	<ul style="list-style-type: none"> <li>• Check for disconnection of TK4 sensor.</li> <li>• Check resistance characteristics of TK4 sensor.</li> <li>• Check for connection trouble involving TK1, TK2, , TK4, and TK5 sensors.</li> <li>• Check for clogging in oil equalizing circuit capillary and faulty operation in check valve.</li> <li>• Check for refrigerant entrapment inside compressor.</li> </ul>	
						No temperature change is detected by TK5 despite compressor having been started.	<ul style="list-style-type: none"> <li>• Check for disconnection of TK5 sensor.</li> <li>• Check resistance characteristics of TK5 sensor.</li> <li>• Check for connection trouble involving TK1, TK2, , TK4, and TK5 sensors.</li> <li>• Check for clogging in oil equalizing circuit capillary and faulty operation in check valve.</li> <li>• Check for refrigerant entrapment inside compressor.</li> </ul>	

Check code			Location of detection	Description	System status	Trouble detection condition(s)	Check items (locations)
Main remote controller	Outdoor 7-segment display						
	Check code	Sub-code					
L02	L02	–	Indoor unit	Outdoor units model disagreement trouble	Stop of corresponding unit	In case of different outdoor unit (Not corresponded to Air to Air Heat Exchanger type)	<ul style="list-style-type: none"> <li>Check outdoor unit model. (Check whether the outdoor unit corresponds to Air to Air Heat Exchanger type or not.)</li> </ul>
L03	–	–	Indoor unit	Duplicated indoor header unit	Stop of corresponding unit	There are more than one header units in group.	<ul style="list-style-type: none"> <li>Check indoor addresses.</li> <li>Check for any change made to remote controller connection (group/individual) since indoor address setting.</li> </ul>
L04	L04	–	I/F	Duplicated outdoor line address	All stop	There is duplication in line address setting for outdoor units belonging to different refrigerant piping systems.	<ul style="list-style-type: none"> <li>Check line addresses.</li> </ul>
L05	–	–	I/F	Duplicated priority indoor unit (as displayed on priority indoor unit)	All stop	More than one indoor units have been set up as priority indoor unit.	<ul style="list-style-type: none"> <li>Check display on priority indoor unit.</li> </ul>
L06	L06	No. of priority indoor units	I/F	Duplicated priority indoor unit (as displayed on indoor unit other than priority indoor unit)	All stop	More than one indoor units have been set up as priority indoor unit.	<ul style="list-style-type: none"> <li>Check displays on priority indoor unit and outdoor unit.</li> </ul>
L07	–	–	Indoor unit	Connection of group control cable to stand-alone indoor unit	Stop of corresponding unit	There is at least one stand-alone indoor unit to which group control cable is connected.	<ul style="list-style-type: none"> <li>Check indoor addresses.</li> </ul>
L08	L08	–	Indoor unit	Indoor group / addresses not set	Stop of corresponding unit	Address setting has not been performed for indoor units.	<ul style="list-style-type: none"> <li>Check indoor addresses.</li> </ul> <p><b>Note:</b> This code is displayed when power is turned on for the first time after installation.</p>
L09	–	–	Indoor unit	Indoor capacity not set	Stop of corresponding unit	Capacity setting has not been performed for indoor unit.	Set indoor capacity. (DN = 11)
L10	L10	–	I/F	Outdoor capacity not set	All stop	Jumper wire provided on P.C. board for servicing I/F P.C. board has not been removed as required for given model.	Check model setting of P.C. board for servicing outdoor I/F P.C. board.
L20	–	–	Network adaptor Indoor unit	Duplicated central control address	All stop	There is duplication in central control address setting.	<ul style="list-style-type: none"> <li>Check central control addresses.</li> <li>Check network adaptor P.C. board .</li> </ul>
L23	–	–	I/F	SW setting mistake	All stop	Outdoor P.C. board (I/F) does not operate normally.	<ul style="list-style-type: none"> <li>Check switch setting of Bit 3 and 4 of SW17 in outdoor P.C. board (I/F).</li> </ul>
L28	L28	–	I/F	Too many outdoor units connected	All stop	There are more than three outdoor units.	<ul style="list-style-type: none"> <li>Check No. of outdoor units connected (Only up to 3 units per system allowed).</li> <li>Check communication lines between outdoor units.</li> <li>Check for defect in outdoor P.C. board (I/F).</li> </ul>

Check code		Location of detection	Description	System status	Trouble detection condition(s)	Check items (locations)																																																																																										
Main remote controller	Outdoor 7-segment display																																																																																															
	Check code																																																																																															
L29	L29	<table border="1"> <thead> <tr> <th rowspan="2"></th> <th colspan="2">A3-IPDU</th> <th colspan="2">Fan-IPDU</th> <th colspan="2">A3-IPDU</th> <th colspan="2">Fan-IPDU</th> </tr> <tr> <th>1</th> <th>2</th> <th>1</th> <th>2</th> <th>1</th> <th>2</th> <th>1</th> <th>2</th> </tr> </thead> <tbody> <tr> <td>01</td> <td>○</td> <td></td> <td></td> <td></td> <td>10</td> <td></td> <td></td> <td>○</td> </tr> <tr> <td>02</td> <td></td> <td>○</td> <td></td> <td></td> <td>11</td> <td>○</td> <td></td> <td>○</td> </tr> <tr> <td>03</td> <td>○</td> <td>○</td> <td></td> <td></td> <td>12</td> <td></td> <td>○</td> <td>○</td> </tr> <tr> <td>08</td> <td></td> <td></td> <td>○</td> <td></td> <td>13</td> <td>○</td> <td>○</td> <td>○</td> </tr> <tr> <td>09</td> <td>○</td> <td></td> <td>○</td> <td></td> <td>18</td> <td></td> <td></td> <td>○</td> </tr> <tr> <td>0A</td> <td></td> <td>○</td> <td>○</td> <td></td> <td>19</td> <td>○</td> <td></td> <td>○</td> </tr> <tr> <td>0E</td> <td>○</td> <td>○</td> <td>○</td> <td></td> <td>1A</td> <td></td> <td>○</td> <td>○</td> </tr> <tr> <td></td> <td></td> <td></td> <td></td> <td></td> <td>1B</td> <td>○</td> <td>○</td> <td>○</td> </tr> </tbody> </table> <p>Circle (O): IPDU trouble</p>		A3-IPDU		Fan-IPDU		A3-IPDU		Fan-IPDU		1	2	1	2	1	2	1	2	01	○				10			○	02		○			11	○		○	03	○	○			12		○	○	08			○		13	○	○	○	09	○		○		18			○	0A		○	○		19	○		○	0E	○	○	○		1A		○	○						1B	○	○	○	I/F	Trouble in No. of IPDUs	All stop	Insufficient number of IPDUs are detected when power is turned on.	<ul style="list-style-type: none"> <li>Check model setting of P.C. board for servicing outdoor I/F P.C. board.</li> <li>Check connection of UART communication connector.</li> <li>Check A3-IPDU, fan IPDU, and I/F P.C. board for defect.</li> </ul>
				A3-IPDU		Fan-IPDU		A3-IPDU		Fan-IPDU																																																																																						
1	2		1	2	1	2	1	2																																																																																								
01	○				10			○																																																																																								
02		○			11	○		○																																																																																								
03	○	○			12		○	○																																																																																								
08			○		13	○	○	○																																																																																								
09	○		○		18			○																																																																																								
0A		○	○		19	○		○																																																																																								
0E	○	○	○		1A		○	○																																																																																								
					1B	○	○	○																																																																																								
L30	L30	Detected indoor address	Indoor unit	External interlock of indoor unit	Stop of corresponding unit	<ul style="list-style-type: none"> <li>Signal is present at external trouble input terminal (CN80) for 1 minute.</li> </ul>	<p><b>When external device is connected to CN80 connector:</b></p> <ol style="list-style-type: none"> <li>Check for defect in external device.</li> <li>Check for defect in indoor P.C. board.</li> </ol> <p><b>When external device is not connected to CN80 connector:</b></p> <ol style="list-style-type: none"> <li>Check for defect in indoor P.C. board.</li> </ol>																																																																																									
-	L31	-	I/F	Extended IC trouble	Continued operation	There is part failure in P.C. board (I/F).	Check outdoor P.C. board (I/F).																																																																																									
P01	-	-	Indoor unit	Indoor fan trouble	Stop of corresponding unit		<ul style="list-style-type: none"> <li>Check the lock of fan motor (AC fan).</li> <li>Check wiring.</li> </ul>																																																																																									
P03	P03	-	I/F	Discharge temperature TD1 trouble	All stop	Discharge temperature (TD1) exceeds 115°C.	<ul style="list-style-type: none"> <li>Check outdoor service valves (gas side, liquid side) to confirm full opening.</li> <li>Check outdoor PMVs (PMV1, 3) for clogging.</li> <li>Check resistance characteristics of TD1 sensor.</li> <li>Check for insufficiency in refrigerant quantity.</li> <li>Check for defect in 4-way valve.</li> <li>Check for leakage of SV4 circuit.</li> <li>Check SV4 circuit (wiring or installation error in SV41 or SV42).</li> </ul>																																																																																									

		Check code		Location of detection	Description	System status	Trouble detection condition(s)	Check items (locations)
Main remote controller	Outdoor 7-segment display							
	Check code	Sub-code						
P04	P04	01: Compressor 1 side 02: Compressor 2 side	IPDU	Activation of high-pressure SW	All stop	High-pressure SW is activated.	<ul style="list-style-type: none"> <li>• Check connection of high-pressure SW connector.</li> <li>• Check for defect in Pd pressure sensor.</li> <li>• Check outdoor service valves (gas side, liquid side) to confirm full opening.</li> <li>• Check for defect in outdoor fan.</li> <li>• Check for defect in outdoor fan motor.</li> <li>• Check outdoor PMVs (PMV1, 3) for clogging.</li> <li>• Check indoor/outdoor heat exchangers for clogging.</li> <li>• Check for short-circuiting of outdoor suction/discharge air flows.</li> <li>• Check SV2 circuit for clogging.</li> <li>• Check for defect in outdoor P.C. board (I/F).</li> <li>• Check for error in indoor fan system (possible cause of air flow reduction).</li> <li>• Check opening status of indoor PMV.</li> <li>• Check indoor-outdoor communication line for wiring error.</li> <li>• Check for faulty operation of check valve in discharge pipe convergent section.</li> <li>• Check gas balancing SV4 valve circuit.</li> <li>• Check SV5 valve circuit.</li> <li>• Check for refrigerant overcharging.</li> </ul>	
P05	P05	00: 01: Compressor 1 side 02: Compressor 2 side	I/F	Detection of open phase/phase sequence  Inverter DC voltage (Vdc) trouble (compressor) MG-CTT trouble	All stop	<ul style="list-style-type: none"> <li>• Open phase is detected when power is turned on.</li> <li>• Inverter DC voltage is too high (overvoltage) or too low (undervoltage).</li> </ul>	<ul style="list-style-type: none"> <li>• Check for defect in outdoor P.C. board (I/F).</li> <li>• Check wiring of outdoor power supply.</li> </ul>	
P07	P07	01: Compressor 1 side 02: Compressor 2 side	IPDU I/F	Heat sink overheating trouble	All stop	Temperature sensor built into IPM (TH) is overheated.	<ul style="list-style-type: none"> <li>• Check power supply voltage.</li> <li>• Check outdoor fan system trouble.</li> <li>• Check heat sink cooling duct for clogging.</li> <li>• Check IPM and heat sink for thermal performance for faulty installation. (e.g. mounting screws and thermal conductivity)</li> <li>• Check for defect in A3-IPDU. (faulty IPM built-in temperature sensor (TH))</li> </ul>	
P10	P10	Detected indoor address	Indoor unit	Indoor overflow trouble	All stop	<ul style="list-style-type: none"> <li>• Float switch operates.</li> <li>• Float switch circuit is open-circuited or disconnected at connector.</li> </ul>	<ul style="list-style-type: none"> <li>• Check float switch connector.</li> <li>• Check operation of drain pump.</li> <li>• Check drain pump circuit.</li> <li>• Check drain pipe for clogging.</li> <li>• Check for defect in indoor P.C. board.</li> </ul>	
P12	-	-	Indoor unit	Indoor fan motor trouble	Stop of corresponding unit	<ul style="list-style-type: none"> <li>• Motor speed measurements continuously deviate from target value.</li> <li>• Overcurrent protection is activated.</li> </ul>	<ul style="list-style-type: none"> <li>• Check connection of fan connector and wiring.</li> <li>• Check for defect in fan motor.</li> <li>• Check for defect in indoor P.C. board.</li> <li>• Check impact of outside air treatment (OA).</li> </ul>	

MG-CTT: Magnet contactor

Check code			Location of detection	Description	System status	Trouble detection condition(s)	Check items (locations)
Main remote controller	Outdoor 7-segment display						
	Check code	Sub-code					
P13	P13	-	I/F	Outdoor liquid backflow detection trouble	All stop	<p>&lt;During cooling operation&gt; When system is in cooling operation, high pressure is detected in follower unit that has been turned off.</p> <p>&lt;During heating operation&gt; When system is in heating operation, outdoor PMV 1 or 3 continuously registers opening of 300p or less while under superheat control.</p>	<ul style="list-style-type: none"> <li>• Check full-close operation of outdoor PMV (1, 3, 4).</li> <li>• Check for defect in Pd or Ps sensor.</li> <li>• Check gas balancing circuit (SV2) for clogging.</li> <li>• Check balance pipe.</li> <li>• Check SV3B circuit for clogging.</li> <li>• Check defect in outdoor P.C. board (I/F).</li> <li>• Check capillary of oil separator oil return circuit for clogging.</li> <li>• Check for leakage of check valve in discharge pipe convergent section.</li> </ul>
P15	P15	01: TS condition	I/F	Gas leakdetection (TS1 condition)	All stop	<p>Protective shutdown due to sustained suction temperature at or above judgment criterion for at least 10 minutes is repeated four times or more.</p> <p>&lt;TS error judgment criterion&gt; In cooling operation: 60°C In heating operation: 40°C</p>	<ul style="list-style-type: none"> <li>• Check for insufficiency in refrigerant quantity.</li> <li>• Check outdoor service valves (gas side, liquid side) to confirm full opening.</li> <li>• Check PMVs (PMV1, 3) for clogging.</li> <li>• Check resistance characteristics of TS1 sensor.</li> <li>• Check for defect in 4-way valve.</li> <li>• Check SV4 circuit for leakage</li> </ul>
		02: TD condition	I/F	Gas leak detection (TD condition)	All stop	<p>Protective shutdown due to sustained discharge temperature (TD1 or TD2) at or above 108 °C for at least 10 minutes is repeated four times or more.</p>	<ul style="list-style-type: none"> <li>• Check for insufficiency in refrigerant quantity.</li> <li>• Check PMVs (PMV 1, 3) for clogging.</li> <li>• Check resistance characteristics of TD1 and TD2 sensors.</li> <li>• Check indoor filter for clogging.</li> <li>• Check piping for clogging.</li> <li>• Check SV4 circuit (for leakage or coil installation error).</li> </ul>
P17	P17	-	I/F	Discharge temperature TD2 trouble	All stop	Discharge temperature (TD2) exceeds 115°C.	<ul style="list-style-type: none"> <li>• Check outdoor service valves (gas side, liquid side) to confirm full opening.</li> <li>• Check outdoor PMVs (PMV1, 3, 4) for clogging.</li> <li>• Check resistance characteristics of TD2 sensor.</li> <li>• Check for defect in 4-way valve.</li> <li>• Check SV4 circuit for leakage.</li> <li>• Check SV4 circuit (for wiring or installation error involving SV41 and SV42).</li> </ul>

Check code			Location of detection	Description	System status	Trouble detection condition(s)	Check items (locations)
Main remote controller	Outdoor 7-segment display						
	Check code	Sub-code					
P19	P19	Detected outdoor unit No.	I/F	4-way valve reversing trouble	All stop	Abnormal refrigerating cycle data is collected during heating operation.	<ul style="list-style-type: none"> <li>• Check for defect in main body of 4-way valve.</li> <li>• Check for coil defect in 4-way valve and loose connection of its connector.</li> <li>• Check resistance characteristics of TS1 and TE1, TE2 sensors.</li> <li>• Check output voltage characteristics of Pd and Ps pressure sensors.</li> <li>• Check for wiring trouble involving TE1 and TL1 sensors.</li> </ul>
P20	P20	-	I/F	Activation of high-pressure protection	All stop	<p>&lt;During cooling operation&gt; Pd sensor detects pressure equal to or greater than 3.85 MPa.</p> <p>&lt;During heating operation&gt; Pd sensor detects pressure equal to or greater than 3.6 MPa.</p>	<ul style="list-style-type: none"> <li>• Check for defect in Pd pressure sensor.</li> <li>• Check service valves (gas side, liquid side) to confirm full opening.</li> <li>• Check for defect in outdoor fan.</li> <li>• Check for defect in outdoor fan motor.</li> <li>• Check outdoor PMV (PMV1, 3, 4) for clogging.</li> <li>• Check indoor/outdoor heat exchangers for clogging.</li> <li>• Check for short-circuiting of outdoor suction/discharge air flows.</li> <li>• Check SV2 circuit for clogging.</li> <li>• Check for defect in outdoor P.C. board (I/F).</li> <li>• Check for defect in indoor fan system (possible cause of air flow reduction).</li> <li>• Check opening status of indoor PMV.</li> <li>• Check indoor-outdoor communication line for wiring trouble.</li> <li>• Check for faulty operation of check valve in discharge pipe convergent section.</li> <li>• Check gas balancing SV4 valve circuit.</li> <li>• Check SV5 valve circuit.</li> <li>• Check for refrigerant overcharging.</li> </ul>

Check code		Location of detection	Description	System status	Trouble detection condition(s)	Check items (locations)	
Main remote controller	Outdoor 7-segment display						
	Check code						Sub-code
P22	P22	#0:Element short circuit	IPDU Outdoor fan IPDU trouble *Put in Fan IPDU No. in [#] mark	All stop	(Sub code: #0) Fan IPDU over current protection circuit Flow of current equal to or greater than the specified value is detected during startup of the fan.	<ul style="list-style-type: none"> <li>• Check fan motor.</li> <li>• Check for defect in fan IPDU P.C. board.</li> </ul>	
		#1:Position detection circuit trouble			(Sub code: #1) Fan IPDU position detection circuit Position detection is not going on normally.	<ul style="list-style-type: none"> <li>• Check fan motor.</li> <li>• Check connection of fan motor connector.</li> <li>• Check for defect in fan IPDU P.C. board.</li> </ul>	
		#3:Motor lock trouble			(Sub code: #3) Gusty wind, an obstruction, or another external factor Speed estimation is not going on normally.	<ul style="list-style-type: none"> <li>• Check fan motor.</li> <li>• Check for defect in fan IPDU P.C. board.</li> </ul>	
		#4:Motor current trouble			(Sub code: #4) Fan IPDU over current protection circuit Flow of current equal to or greater than the specified value is detected during operation of the fan.	<ul style="list-style-type: none"> <li>• Check fan motor.</li> <li>• Check connection of fan motor connector.</li> <li>• Check for defect in fan IPDU P.C. board.</li> </ul>	
		#C:TH sensor temperature trouble			(Sub code: #C) Higher temperature than the specified value is detected during operation of the fan.	<ul style="list-style-type: none"> <li>• Check fan motor.</li> <li>• Check for defect in fan IPDU P.C. board.</li> </ul>	
		#D:TH sensor short circuit/release trouble			(Sub code: #D) The resistance value of the sensor is infinite or zero (open or short circuit).	<ul style="list-style-type: none"> <li>• Check for defect in fan IPDU P.C. board.</li> </ul>	
		#E:Vdc voltage trouble			(Sub code: #E) Fan IPDU DC voltage protection circuit The DC voltage higher or lower than the specified value is detected.	<ul style="list-style-type: none"> <li>• Check power voltage of the main power supply.</li> <li>• Check for defect in fan IPDU P.C. board.</li> <li>• Check connection of fan IPDU P.C. board.</li> </ul>	
P26	P26	01: Compressor 1 side 02: Compressor 2 side	IPDU IPM short-circuit protection trouble	All stop	Overcurrent is momentarily detected during startup of compressor.	<ul style="list-style-type: none"> <li>• Check connector connection and wiring on A3-IPDU P.C. board.</li> <li>• Check for defect in compressor (layer short-circuit).</li> <li>• Check for defect in outdoor P.C. board (A3-IPDU).</li> </ul>	
P29	P29	01: Compressor 1 side 02: Compressor 2 side	IPDU Compressor position detection circuit trouble	All stop	Position detection is not going on normally.	<ul style="list-style-type: none"> <li>• Check wiring and connector connection.</li> <li>• Check for compressor layer short-circuit.</li> <li>• Check for defect in A3-IPDU P.C. board.</li> </ul>	
P31	-	-	Indoor unit Other indoor trouble (group follower unit error)	Stop of corresponding unit	There is error in other indoor unit in group, resulting in detection of E07/L07/L03/L08.	<ul style="list-style-type: none"> <li>• Check indoor P.C. board.</li> </ul>	



## Check codes Detected by TCC-LINK Central Control Device

Check code		Location of detection	Description	System status	Trouble detection condition(s)	Check items (locations)	
Main remote controller	Outdoor 7-segment display						
Sub-code							
C05	–	TCC-LINK	TCC-LINK central control device transmission trouble	Continued operation	Central control device is unable to transmit signal.	<ul style="list-style-type: none"> <li>• Check for defect in central control device.</li> <li>• Check for defect in central control communication line.</li> <li>• Check termination resistance setting.</li> </ul>	
C06	–		TCC-LINK central control device reception trouble	Continued operation	Central control device is unable to receive signal.	<ul style="list-style-type: none"> <li>• Check for defect in central control device.</li> <li>• Check for defect in central control communication line.</li> <li>• Check terminator resistor setting.</li> <li>• Check power supply for devices at other end of central control communication line.</li> <li>• Check defect in P.C. boards of devices at other end of central control communication line.</li> </ul>	
C12	–	General-purpose device I/F	Batch alarm for general-purpose device control interface	Continued operation	Error signal is input to control interface for general-purpose devices.	<ul style="list-style-type: none"> <li>• Check trouble input.</li> </ul>	
P30	Differs according to nature of alarm-causing trouble		TCC-LINK	Group control follower unit trouble	Continued operation	Error occurs in follower unit under group control. ([P30] is displayed on central control remote controller.)	<ul style="list-style-type: none"> <li>• Check check code of unit that has generated alarm.</li> </ul>
	(L20 displayed.)			Duplicated central control address	Continued operation	There is duplication in central control addresses.	<ul style="list-style-type: none"> <li>• Check address settings.</li> </ul>

Check code	Check code name	Cause
<b>[P12]</b>	Indoor fan motor trouble	1. Installation environment trouble 2. Electric parts trouble 3. Wiring error of fan motor connector 4. Fan motor trouble 5. Indoor P.C. board trouble

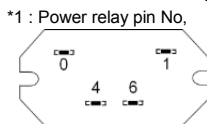
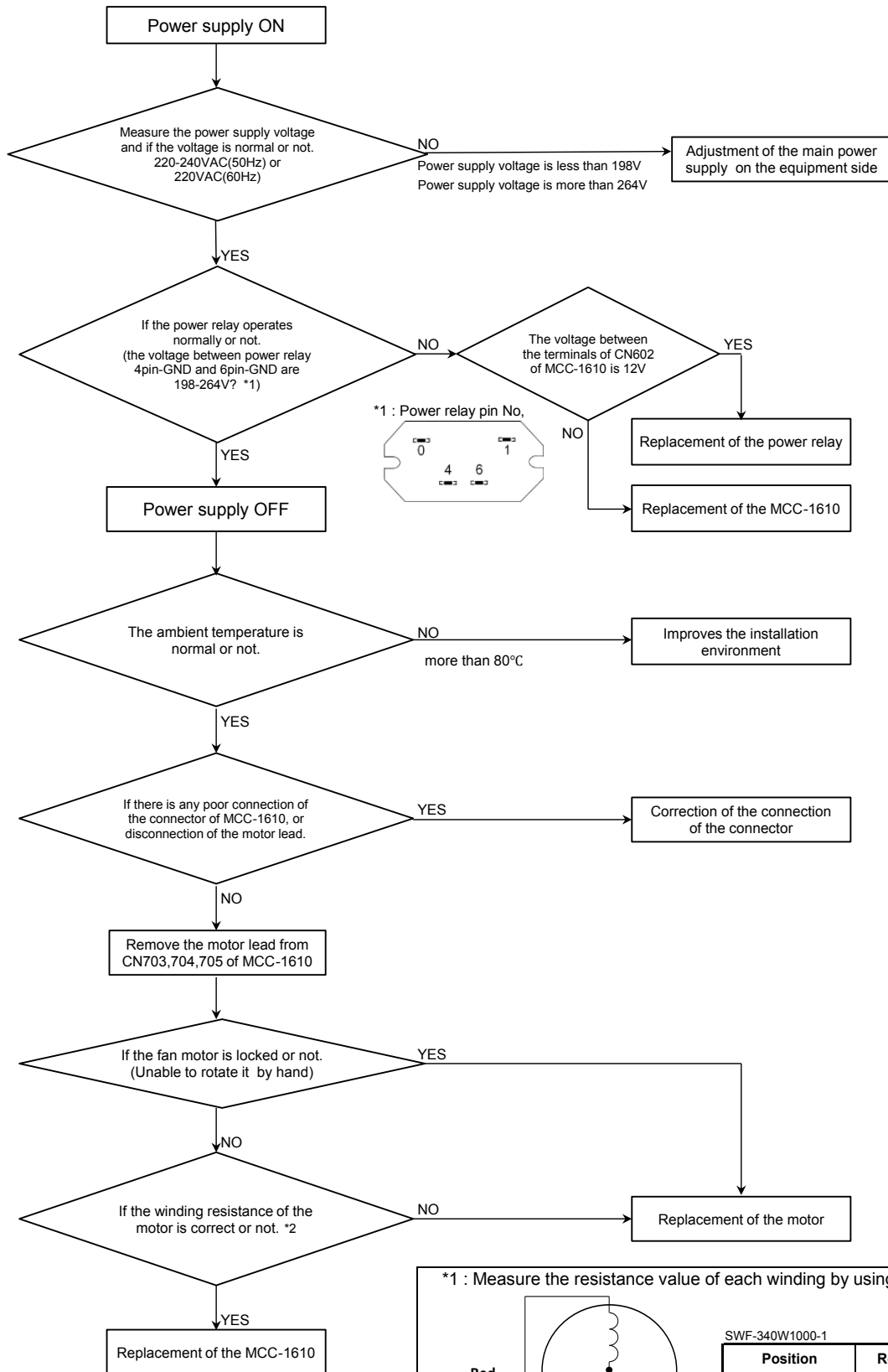

\*1 : Measure the resistance value of each winding by using the tester

Position	Resistance value
Red - White	2.6 ± 0.3 Ω
White - Black	2.6 ± 0.3 Ω
Black - Red	2.6 ± 0.3 Ω

SWF-340W1000-1  
at 20°C

Fan motor inside wiring diagram

## 9-5. Sensor characteristics

### Indoor unit

#### ▼ Temperature sensor characteristics

Indoor TA sensor

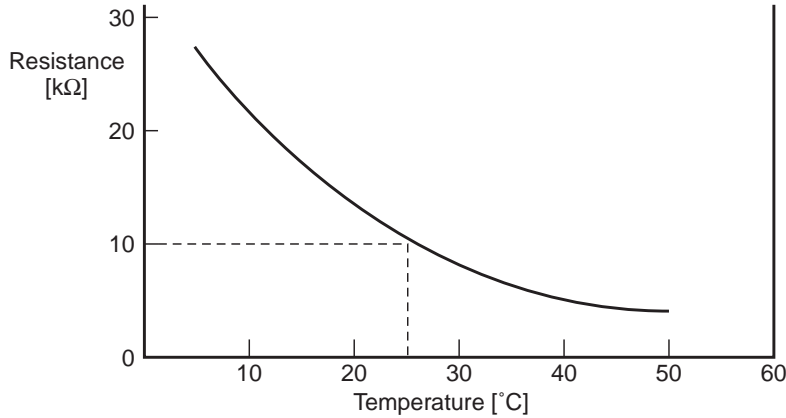

Temperature [°C]	Resistance [kΩ]
0	33.9
5	26.1
10	20.3
15	15.9
20	12.6
25	10.0
30	8.0
35	6.4
40	5.2
45	4.2
50	3.5
55	2.6
60	2.4

Indoor TC1 sensor

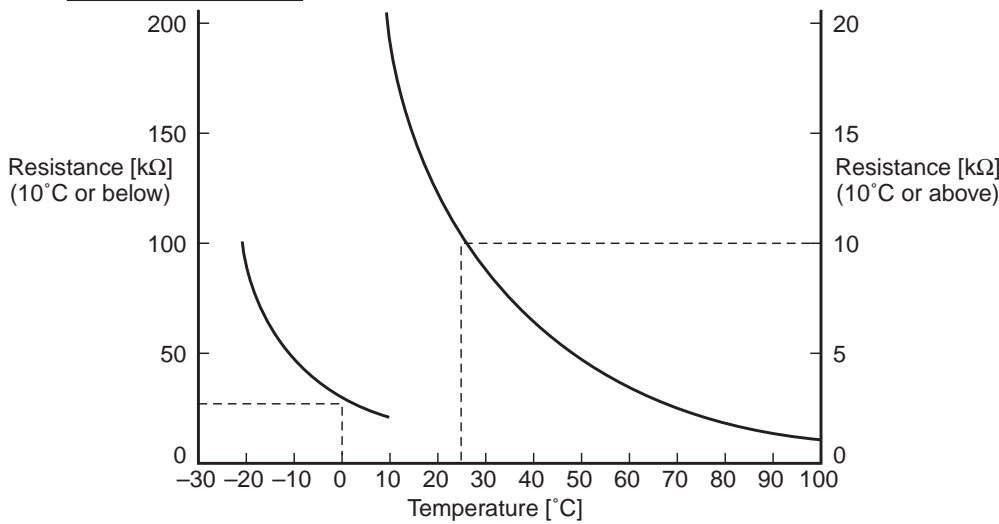

Temperature [°C]	Resistance [kΩ]
-20	99.9
-15	74.1
-10	55.6
-5	42.2
0	32.8
5	25.4
10	19.8
15	15.6
20	12.4
25	10.0
30	8.1
35	6.5
40	5.3
45	4.4
50	3.6
55	3.0
60	2.5
65	2.1
70	1.8
75	1.5
80	1.3
85	1.1
90	1.0
95	0.8
100	0.7

Indoor TC2 and TCJ sensors

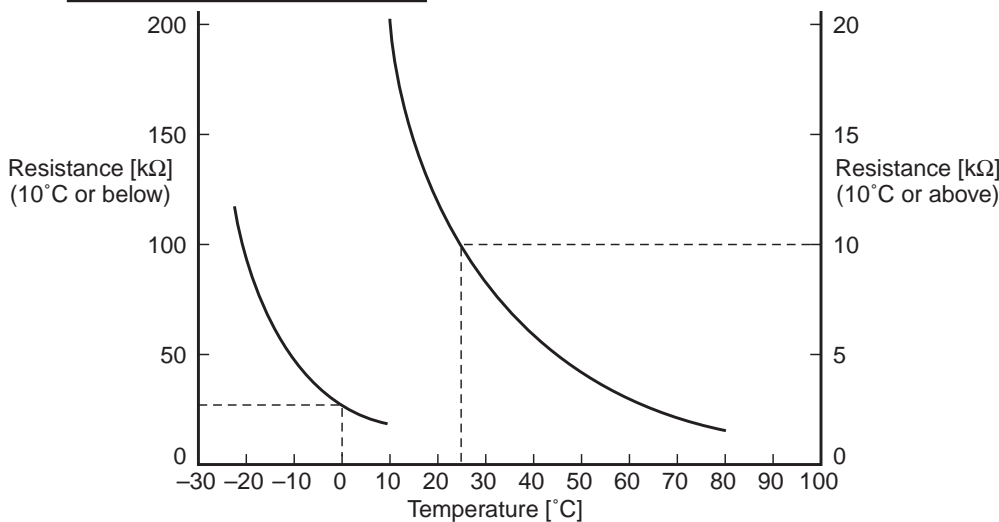

Temperature [°C]	Resistance [kΩ]
-20	115.2
-15	84.2
-10	62.3
-5	46.6
0	35.2
5	26.9
10	20.7
15	16.1
20	12.6
25	10.0
30	8.0
35	6.4
40	5.2
45	4.2
50	3.5
55	2.8
60	2.4
65	2.0
70	1.6
75	1.4
80	1.2

## 10. REPLACEMENT OF SERVICE P.C. BOARD

### 10-1. Indoor Circuit Design Board (MCC-1643)

#### <Note: when replacing the P.C. board for indoor unit servicing>

The nonvolatile memory (hereafter called EEPROM, IC503) on the indoor unit P.C. board before replacement includes the model specific type information and capacity codes as the factory-set value and the important setting data which have been automatically or manually set when the indoor unit is installed, such as system/indoor/group addresses, high ceiling select setting, etc.

When replacing the P.C. board for indoor unit servicing, follow the procedures below.

After replacement completes, confirm whether the settings are correct by checking the indoor unit No., Group header unit/follower unit settings and perform the cooling cycle confirmation through the trial operation.

#### <Replacement procedures>

### CASE 1

**Before replacement, the indoor unit can be turned on and the setting data can be read out by wired remote control operation.**

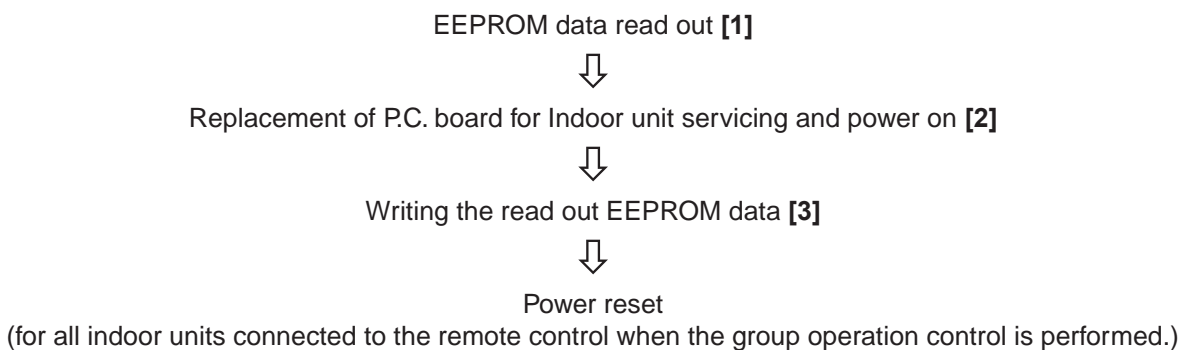

### CASE 2

**The EEPROM before replacement is defective and the setting data cannot be read out.**

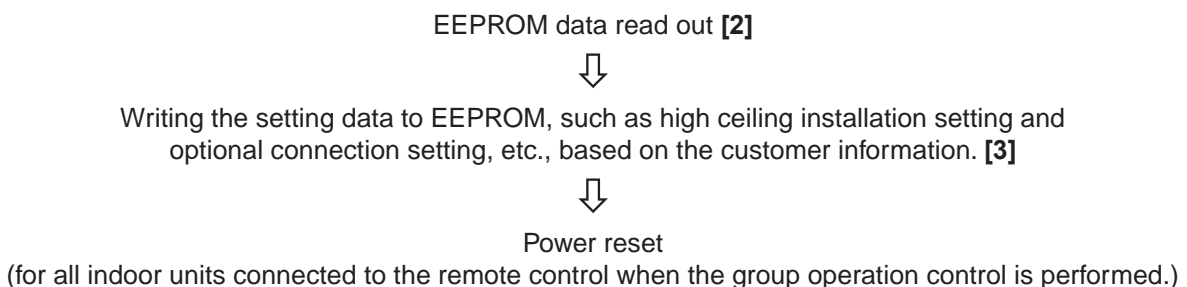

## [1] Setting data read out from EEPROM

The setting data modified on the site, other than factory-set value, stored in the EEPROM shall be read out.

**Step 1** Push **SET**, **CL** and **TEST** button on the remote controller simultaneously for more than 4 seconds.

\* When the group operation control is performed, the unit No. displayed for the first time is the header unit No.

At this time, the CODE No. (DN) shows "10". Also, the fan of the indoor unit selected starts its operation.

**Step 2** Every time when the **UNIT LOUVER** (left side button) button is pushed, the indoor unit No. under the group control is displayed in order. Specify the indoor unit No. to be replaced.

1. **Change the CODE No. (DN) to 01 → 01 by pushing ▼ / ▲ buttons for the temperature setting. (this is the setting for the filter sign lighting time.)**

**At this time, be sure to write down the setting data displayed.**

2. Change the CODE No. (DN) by pushing ▼ / ▲ buttons for the temperature setting.

Similarly, be sure to write down the setting data displayed.

3. Repeat the step 2-2 to set the other settings in the same way and write down the setting data as shown in the table 1 (example).

\* The CODE No. (DN) are ranged from "01" to "FF". The CODE No. (DN) may skip.

**Step 3** After writing down all setting data, push **TEST** button to return to the normal stop status. (It takes approx. 1 min until the remote controller operation is available again.)

### CODE No. required at least

DN	Contents
10	Type
11	Indoor unit capacity
12	System address
13	Indoor unit address
14	Group address

1. The CODE No. for the Indoor unit type and Indoor unit capacity are required to set the rotation number setting of the fan.
2. If the system/indoor/group addresses are different from those before replacement, the auto-address setting mode starts and the manual resetting may be required again. (when the multiple units group operation.)

## [2] P.C. Board for indoor unit servicing replacement procedures

**Step 1** Replace the P.C. board to the P.C. board for indoor unit servicing.

At this time, perform the same setting of the jumper wire (J01, J08, J09) setting (cut), switch SW501, (short-circuit) connector CN34 as the setting of the P.C. board before replacement.

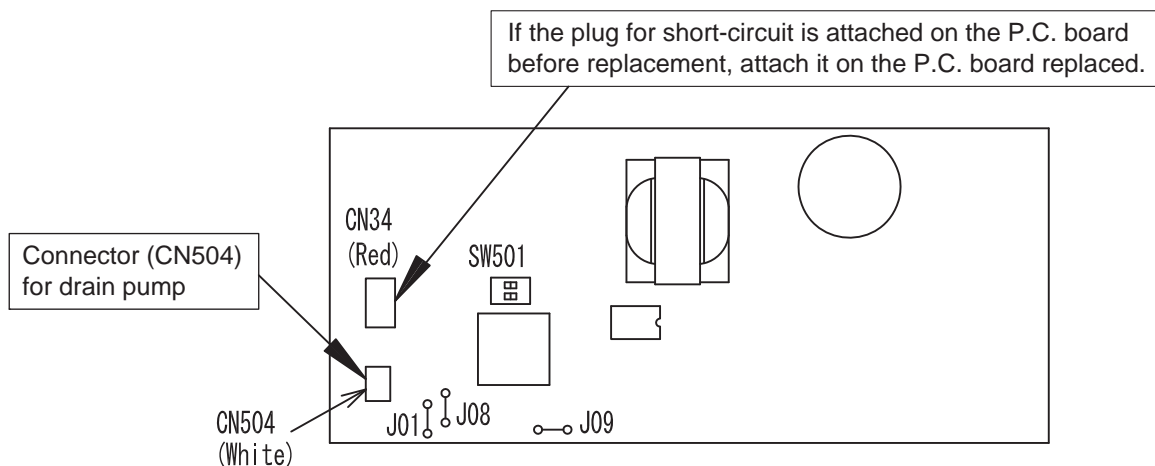

**Step 2** It is necessary to set indoor unit to be exchanged: Remote controller = 1 : 1  
Based upon the system configuration, turn on power of the indoor unit with one of the following items.

- 1) Single (Individual) operation. Turn on power of the indoor units and proceed to [3].
- 2) Group operation

A) In case that power of the exchanged indoor unit only can be turned on  
Turn on power of the exchanger indoor unit only and proceed to [3].

- B) In case that power of the indoor units cannot be turned on individually (**Case 1**)
- Remove temporarily the group wire connected to the terminal blocks A and B of the exchanged indoor unit.
  - After connecting the remote controller wire only to the removed terminal block, turn on power of the indoor units and proceed to [3].
- \* When the above methods cannot be used, follow to the two cases below.
- C) In case that power of the indoor units cannot be turned in individually (**Case 2**)
- Remove all CN41 connectors of the indoor units in the same group except those of the exchanged indoor unit.
  - Turn on power of the indoor units and proceed to [3].
- \* After [3] operation has finished, be sure to return the temporarily removed group wire or CN41 connector to the original connection.

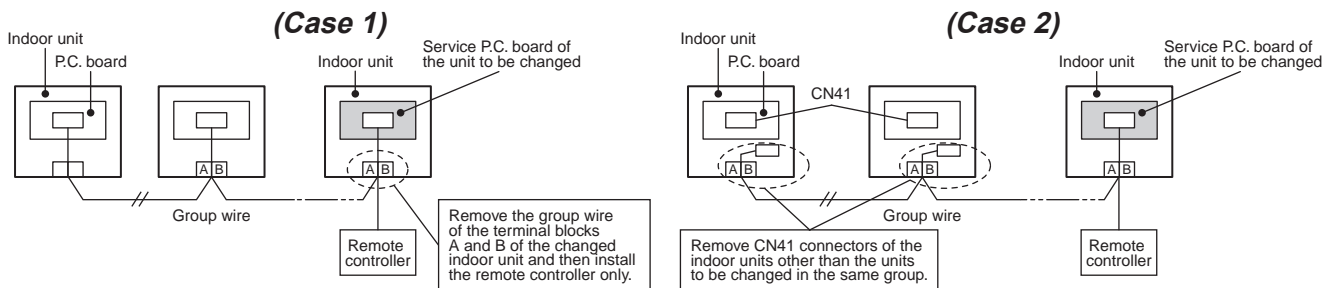





### [3] Writing the setting data to EEPROM

The settings stored in the EEPROM of the P.C. board for indoor unit servicing are the factory-set values.

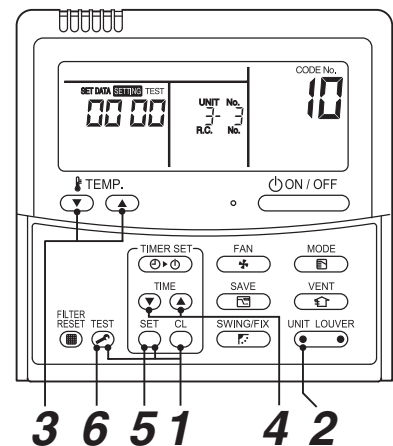
- Step 1** Push **SET**, **CL** and **TEST** buttons on the remote controller simultaneously for more than 4 seconds.
- \* In the group control operation, the unit No. displayed for the first time is the header unit No.
- At this time, the CODE No. (DN) shows "10". Also, the fan of the indoor unit selected starts its operation.
- (The unit No. "ALL" is displayed if the auto-address setting mode is interrupted in [2] step 2 a.)
- Step 2** Every time when **UNIT LOUVER** (left side button) button is pushed, the indoor unit No. in the group control operation are displayed in order.
- (The settings stored in the EEPROM of the P.C. board for indoor unit servicing are the factory-set values.)
- Specify the indoor unit No. with its P.C. board replaced to the P.C. board for indoor unit servicing. (You cannot perform this operation if "ALL" is displayed.)
- Step 3** Select the CODE No. (DN) can be selected by pushing the **▼** / **▲** button for the temperature setting.
- Set the indoor unit type and capacity. The factory-set values shall be written to the EEPROM by changing the type and capacity.
- Set the CODE No. (DN) to "10". (without change)
  - Select the type by pushing **▼** / **▲** buttons for the timer setting. (For example, 4-way Cassette Type is set to "0001". Refer to table 2)
  - Push **SET** button. (The operation completes if the setting data is displayed.)
  - Change the CODE No. (DN) to "11" by pushing **▼** / **▲** buttons for the temperature setting.
  - Select the capacity by pushing **▼** / **▲** buttons for the timer setting. (For example, AP027 Type is set to "0012". Refer to table 3)
  - Push **SET** button. (The setting completes if the setting data are displayed.)

<Fig. 1 RBC-AMT32E>



- Step 4** Write the on-site setting data to the EEPROM, such as address setting, etc. Perform the steps 1 and 2 above again.
- Step 5** Change the CODE No. (DN) to “01” by pushing ▼ / ▲ buttons for the temperature setting. (this is the setting for the filter sign lighting time.)
- Step 6** Check the setting data displayed at this time with the setting data put down in [1].
1. If the setting data is different, modify the setting data by pushing ▼ / ▲ buttons for the timer setting to the data put down in [1].  
The operation completes if the setting data is displayed.
  2. If the data is the same, proceed to next step.
- Step 7** Change the CODE No. (DN) by pushing ▼ / ▲ buttons for the temperature setting. As described above, check the setting data and modify to the data put down in [1].
- Step 8** Repeat the steps 6 and 7.
- Step 9** After the setting completes, push  button to return to the normal stop status. (It takes approx. 1 min until the remote control operation is available again.)
- \* The CODE No. (DN) are ranged from “01” to “FF”. The CODE No. (DN) is not limited to be serial No. Even after modifying the data wrongly and pushing  button, it is possible to return to the data before modification by pushing  button if the CODE No. (DN) is not changed.

### <Fig. 2 EEPROM layout diagram>

The EEPROM (IC503) is attached to the IC socket. When detaching the EEPROM, use a tweezers, etc. Be sure to attach the EEPROM by fitting its direction as shown in the figure.

\* Do not bend the IC lead when replacing.

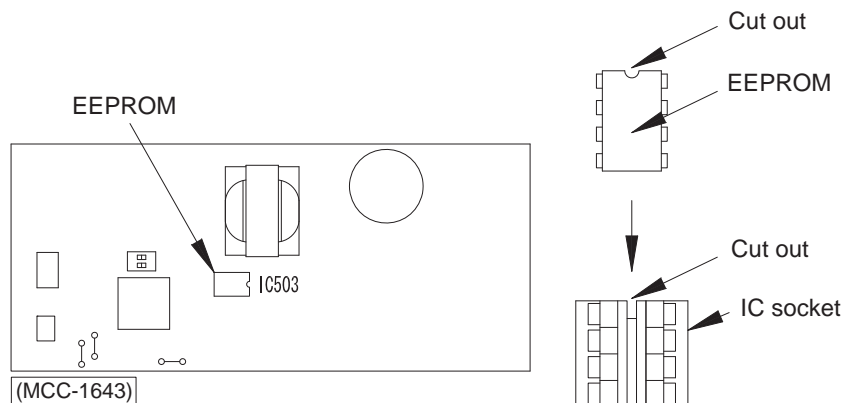

### CODE No. list (Example)

CODE No. (DN)	Item	Setting data	Factory-set value
01	Filter sign lighting time		Depending on Type
02	Filter pollution leve		0000: standard
03	Central control address		0099: Not determined
06	Heating suction temperature shift		0002: +2°C (Floor standing type: 0)
0d	Existence of automatic COOL/HEAT mode		0001: No auto mode cooling / heating
0F	Cooling only		0000: Heat pump
10	Type		Depending on model type
11	Indoor unit capacity		Depending on capacity type
12	System address		0099: Not determined
13	Indoor unit address		0099: Not determined
14	Group address		0099: Not determined
1E	Temperature range of cooling / heating automatic SW control point		0003: 3 deg (TS ± 1.5)
28	Power failure automatic recovery		0000: None
31	Vent Fan (Single operation)		0000: Not possible
32	Sensor SW (Selection of static pressure)		0000: Body sensor
5d	Static pressure selection		0000: Standard
60	Timer setting (wired remote controller)		0000: Available
D0	Power save operation		0001: Standard

\* Automatically selection by connected outdoor unit

### Type Code No. [10]

Setting data	Type	Model abb. name
0006	Concealed Duct High Static Pressure Type	MMD-AP***HP*

### Indoor unit capacity CODE No. [11]

Setting data	Model	Setting data	Model
0000*	Invalid	0016	—
0001	007 type	0017	048 type
0002	—	0018	056 type
0003	009 type	0019	—
0004	—	0020	—
0005	012 type	0021	072 ype
0006	—	0022	—
0007	015 type	0023	096 type
0008	—	0024	—
0009	018 type	0025	—
0010	—	0026	—
0011	024 type	0027	—
0012	027 type	0028	—
0013	030 type	~	—
0014	—	0034	—
0015	036 type		



## 10-2. Fan IPDU P.C. Board (MCC-1610)

Replacement steps:

[Remove PCB]

- (1) Turn off the power supply of the indoor unit and allow at least one minute for the capacitor to discharge.  
Confirm that the light of the LED (D640) fades away.
- (2) Remove all the connectors which are connected to the FAN IPDU. (Remove the connectors by pulling the connector body. Do not pull the wire, because there are some rocks in connector).
- (3) Remove all the five screws (a) which secures the FAN IPDU to the Heat sink. (These screws are to be re-used after procedure.)
- (4) Remove the Fan IPDU from four PCB spacer (b).

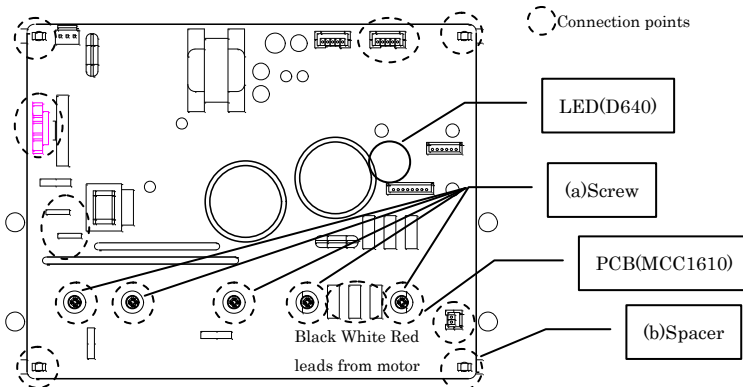

Figure1 PCB outline

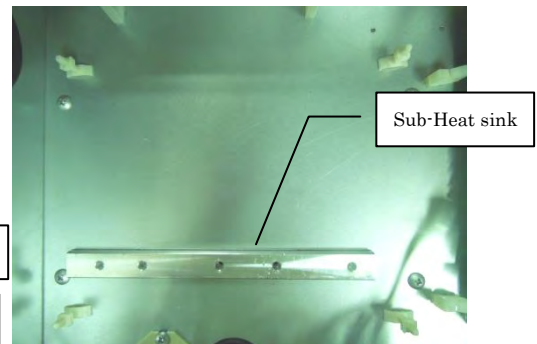

Figure2 After removing PCB

[Set PCB]

- (5) Confirm that no dirt or damage is on the sub heat sink. **And don't forget to set sub heat sink.** As it can reduce the heat transfer efficiency, and cause a breakdown.
- (6) Screw the FAN IPDU to the heat sink using the five screws that were removed in step (3). If the screws are loose, the effected component will generate heat, and cause in to breakdown. Do not use an electric driver or an air driver, as it can cause component damage. The torque of 5 screws (IC701, DB509, DB510 and Q590) is "0.55Nm".
- (7) Re-connect the connectors. Be sure that all the connectors are connected correctly and securely inserted.
- (8) Install the cover, then turn on the supply. Check the operation.

## 10-3. N/F P.C. Board (MCC-1551) Replacement Procedure

- (1) Turn off the power supply of the indoor unit
- (2) Remove all the connectors and remove earth lead from metals. (Remove the connectors by pulling the connector body. Do not pull the wire, because there are some rocks in connector).
- (3) Remove the Fan IPDU from four PCB spacer (a).
- (4) After changing PCB, re-connect the connectors. Be sure that all the connectors are connected correctly and securely inserted. And Screw to earth lead.
- (5) Install the cover, then turn on the supply. Check the operation.

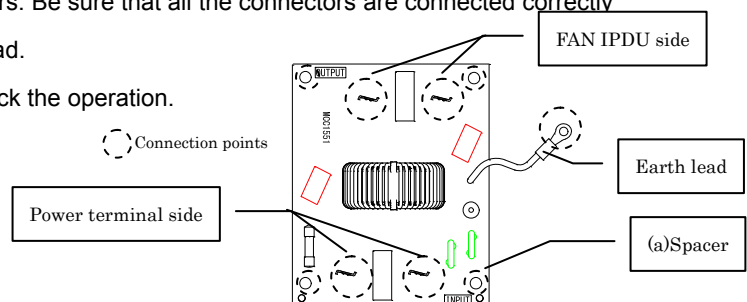



# 11. DETACHMENTS



## ⚠ WARNING

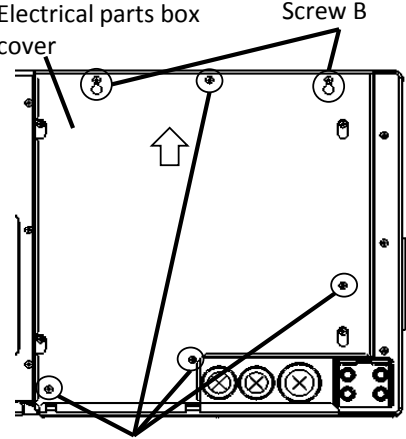
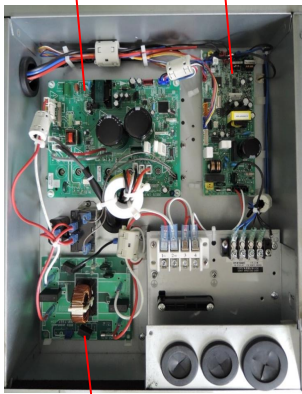

Be sure to stop operation of the air conditioner before work and then turn off switch of the breaker.

## ⚠ CAUTION

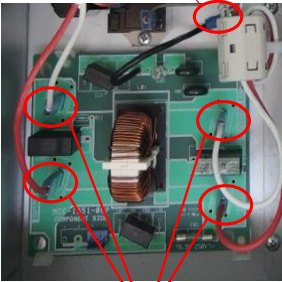

Be sure to put on gloves during working time; otherwise an injury will be caused by a part, etc.

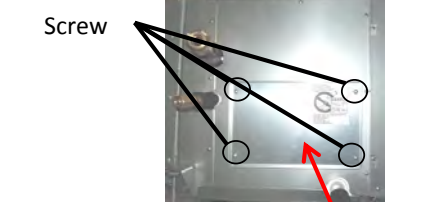
No.	Part name	Procedure	Remarks
①	Electrical parts box cover	<p><b>1. Detachment</b></p> <ol style="list-style-type: none"> <li>Remove the fixing screws A fixing the electrical parts box cover. Loosen the fixing screws B.</li> <li>Slide the electrical parts box cover to the arrow direction and remove the panel.</li> </ol> <p><b>2. Attachment</b></p> <ol style="list-style-type: none"> <li>Hang the electrical parts box cover to the screws B and tighten the screws.</li> <li>Attach the removed screws A to the original positions.</li> </ol>	<p>Electrical parts box cover</p>  <p>Screw B</p> <p>Screw A</p> <p>Fan control P.C. board MCC-1610</p> <p>Control P.C. board MCC-1643</p>  <p>Noise filter P.C. board MCC-1551</p>
②	Control P.C. board MCC-1643	<p><b>1. Detachment</b></p> <ol style="list-style-type: none"> <li>Perform 1 of ①. (In 1 of ①, the removal of the control P.C board is possible even if you do not finish ① ).</li> <li>Unlock the locking card spacers (4 positions) in the electrical parts box to remove the control P.C. board.</li> </ol> <p><b>NOTE</b></p> <p>First unlock the housing and then remove the connectors.</p> <p>CN41 : A,B terminal block (2P, Blue)            CN40 : U1,U2 terminal block (2P, Blue)            CN67 : Power supply terminal block (5P: Black)            CN100 : TC1 sensor (3P: Brown)            CN101 : TC2 sensor (2P: Black)            CN102 : TCJ sensor (2P, Red)            CN104 : Room temperature (2P, Yellow)            CN82 : PMV motor(6P,Blue)            CN521 : UART(5P,Red)            CN22 : Ground (Faston terminal)            CN34 : Float switch (3P, Red) *Option</p>	<p>Room temperature CN104</p> <p>TC2 Sensor CN101</p> <p>TCJ Sensor CN102</p> <p>TC1 Sensor CN100</p> <p>A,B terminal CN41</p> <p>U1,U2 terminal CN40</p> <p>Float switch CN34</p> <p>UART CN521</p> <p>PMV CN82</p> <p>Ground CN22</p> <p>Power supply CN67</p> 

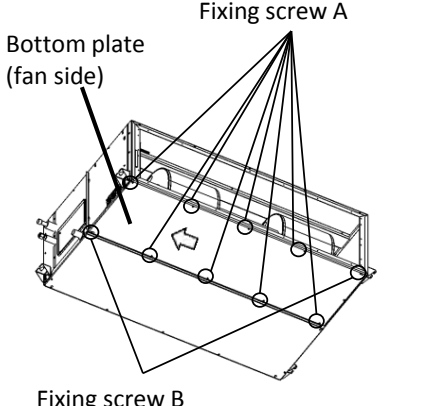
No.	Part name	Procedure	Remarks
②	Control P.C. board MCC-1643	<p><b>2. Attachment</b></p> <ol style="list-style-type: none"> <li>1) Mount the control P.C. board in the electrical parts box as before.</li> <li>2) Attach the electrical parts box as before.</li> <li>3) Be sure to wire in the electric parts box as before.</li> </ol> <p><b>NOTE 1</b></p> <hr/> <p>Check if there is no missing or contact failure of the connectors.</p> <hr/> <p><b>NOTE 2</b></p> <hr/> <p>Be sure to wire as before.</p> <hr/> <ol style="list-style-type: none"> <li>4) Attach the electrical parts box cover as before.</li> </ol>	
③	Fan control P.C. board MCC-1610	<p><b>1. Detachment</b></p> <ol style="list-style-type: none"> <li>1) Perform 1 of ①.</li> <li>2) Unlock the card edge spacers (4 positions) in the electrical parts box to remove the fan control P.C. board.</li> <li>3) Remove the fixing screws A.</li> </ol> <p><b>NOTE</b></p> <hr/> <p>First unlock the housing and then remove the connectors.</p> <hr/> <p>CN504 : Uart (5P, Blue)  CN500 : Power supply terminal block (3P: White)  CN510 : Reactor (Faston terminal)  CN511 : Reactor (Faston terminal)  CN602 : Relay (2P, Black)  CN703 : Fan motor (Black wire) W  CN704 : Fan motor (White wire) V  CN705 : Fan motor (Red wire) U</p> <p><b>2. Attachment</b></p> <ol style="list-style-type: none"> <li>1) Mount the fan control P.C. board in the electrical parts box as before.</li> <li>2) Attach the electrical parts box as before.</li> <li>3) Be sure to wire in the electrical parts box as before.</li> </ol> <p><b>NOTE 1</b></p> <hr/> <p>Check if there is no missing or contact failure of the connectors.</p> <hr/> <p><b>NOTE 2</b></p> <hr/> <p>Be sure to wire as before.</p> <hr/> <ol style="list-style-type: none"> <li>4) Attach the electrical parts box cover as before.</li> </ol>	<p>Power supply CN500</p> <p>Uart CN504</p>  <p>Reactor CN510,511</p> <p>Fan motor CN703,704,705</p> <p>Relay CN602</p>  <p>Fixing screw A</p>
④	Noise filter P.C. board MCC-1551	<p><b>1. Detachment</b></p> <ol style="list-style-type: none"> <li>1) Perform 1 of ①.</li> <li>2) Unlock the card edge spacers (4 positions) in the electrical parts box to remove the noise filter P.C. board.</li> </ol> <p><b>NOTE</b></p> <hr/> <p>First unlock the housing and then remove the connectors.</p> <hr/> <p>CN01 : Power supply (Red wire)  CN02 : Power supply (White wire)  CN03 : Power supply (Red wire)  CN04 : Power supply (White wire)</p>	<p>Earth screws</p>  <p>CN04</p> <p>CN02</p> <p>CN03</p> <p>CN01</p> <p>Power supply</p>

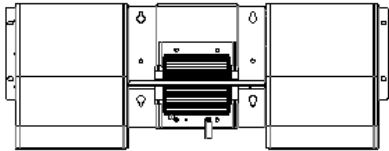
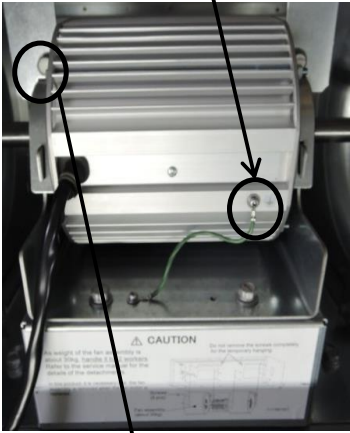
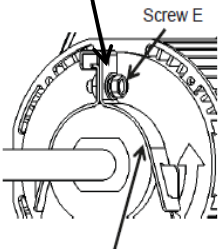
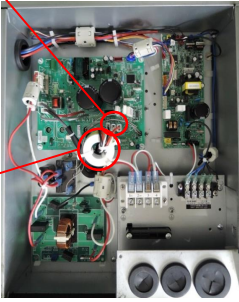
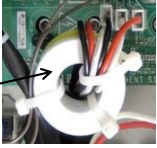
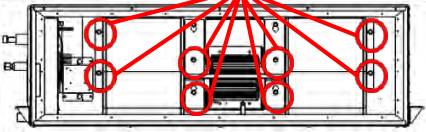
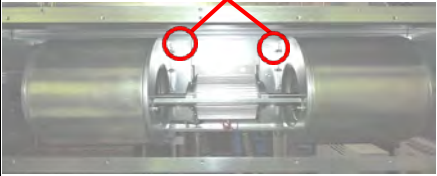
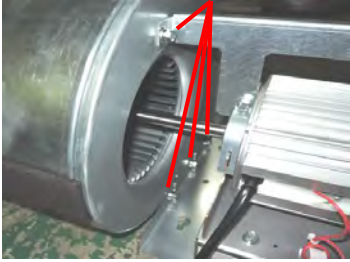
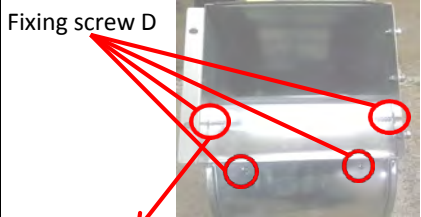

No.	Part name	Procedure	Remarks
④	Noise filter P.C. board MCC-1551	<p><b>2. Attachment</b></p> <ol style="list-style-type: none"> <li>1) Mount the noise filter P.C. board in the electrical parts box as before.</li> <li>2) Attach the electrical parts box as before.</li> <li>3) Be sure to wire in the electric parts box as before.</li> </ol> <p><b>NOTE 1</b></p> <hr/> <p>Check if there is no missing or contact failure of the connectors.</p> <hr/> <p><b>NOTE 2</b></p> <hr/> <p>Be sure to wire as before.</p> <hr/> <p>4) Attach the electrical parts box cover as before.</p>	
⑤	PMV motor	<p><b>1. Detachment</b></p> <ol style="list-style-type: none"> <li>1) Perform 1 of ① to open the electrical parts box cover.</li> <li>2) Loosen the fixing screws of the inspection cover and open the inspection cover.</li> <li>3) Remove the connector of the PMV motor. CN82 : PMV motor (6P,Blue)</li> <li>4) As shown in the right figure, using the two spanners, open the inspection cover of the side face and then remove the PMV motor.</li> </ol> <p><b>2. Attachment</b></p> <ol style="list-style-type: none"> <li>1) Attach the PMV motor as before.</li> <li>2) Connect the connector of the PMV motor as before and close the electrical parts box cover. Be sure to wire in the electrical parts box as before.</li> <li>3) Fix the inspection cover with the fixing screws (4 positions).</li> </ol>	 <p>Relay connector of PMV motor</p>  <p>Screw</p> <p>Inspection cover</p>  <p>PMV motor</p>
⑥	Suction panel	<p><b>1. Detachment</b></p> <ol style="list-style-type: none"> <li>1) Remove the fixing screws A fixing the bottom panel (fan side). Loosen the fixing screws B.</li> <li>2) Slide the bottom plate of the (fan side) to the arrow direction and remove the panel.</li> </ol> <p><b>2. Attachment</b></p> <ol style="list-style-type: none"> <li>1) Hang the bottom plate (fan side) to the screws B.</li> <li>2) Attach the removed screws A to the original positions.</li> </ol>	 <p>Fixing screw A</p> <p>Bottom plate (fan side)</p> <p>Fixing screw B</p>

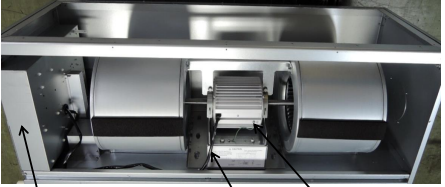
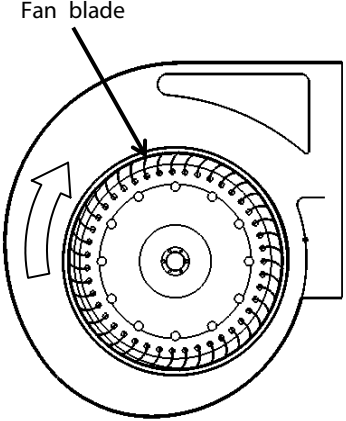
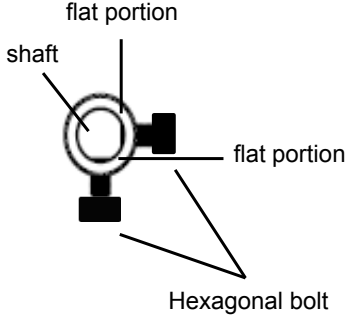
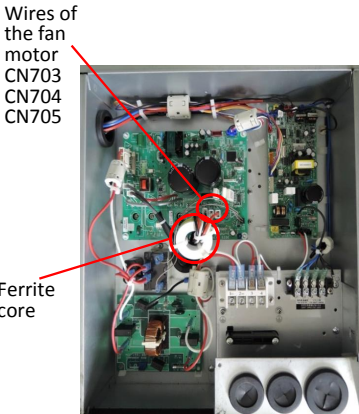
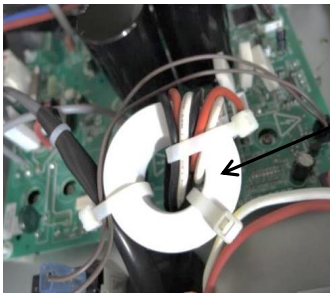

No.	Part name	Procedure	Remarks
⑦	Fan motor, Fan	<p><b>1. Detachment</b></p> <ol style="list-style-type: none"> <li>1) Perform 1 of ① to open the electrical parts box cover.</li> <li>2) Perform 1 of ⑥.</li> <li>3) Remove the connectors of the wires of the fan motor from the fan control P.C. board.            CN703 : Fan motor (Black wire)            CN704 : Fan motor (White wire)            CN705 : Fan motor (Red wire)</li> <li>4) Remove the ferrite core from wire of the fan motor.</li> <li>5) Remove the fixing screws A (M8 x 20, 8 pcs) . and loosen the fixing screws B (M8 x 20, 2 pcs) . (The fan motor is in the temporary hanging state by the fixing plate.)</li> <li>6) Remove the fan assembly.</li> <li>7) Remove the fixing screws C (M8 x 20, 8 pcs) .</li> <li>8) Loosen the hexagonal bolt of the fan and pull out the fan from the shaft.</li> <li>9) Remove the fixing screws D (4 pcs) from the fan case and remove the nose plate and then take out the fan.</li> <li>10) Remove the fixing screw of ferrite core and unscrew the earth.</li> <li>11) Remove the fixing screws E(M8 x 20, 2 pcs) and remove the motor fixing plate.</li> </ol> <div style="text-align: center;">  <p>Fan assembly</p> </div> <p><b>CAUTION</b>  <b>Weight of the fan assembly is about 30kg. Handle it by 2 workers.</b></p> <div style="text-align: center;">  <p>Earth screw</p> </div> <div style="text-align: center;">  <p>Screw E</p> <p>Motor fixing plate</p> </div>	<p>Wires of the fan motor            CN703            CN704            CN705</p>  <p>Ferrite core</p>  <p>Ferrite core</p> <p>Fixing screw A</p>  <p>Fixing screw B</p>  <p>Fixing screw C</p>  <p>Fixing screw D</p>   <p>Nose plate</p>  <p>Screw with hexagonal bolt</p>

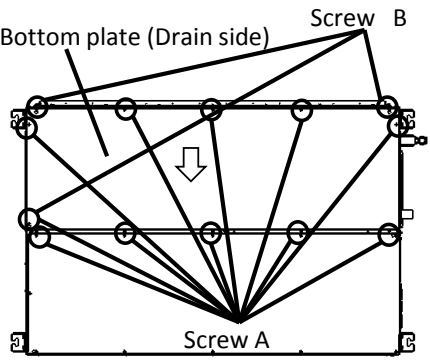
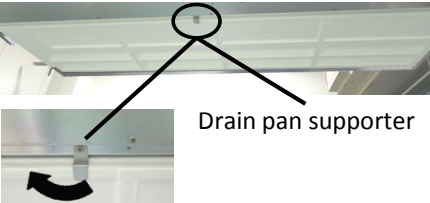
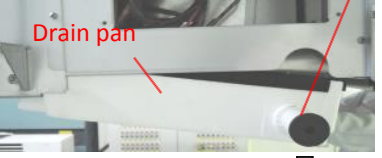
No.	Part name	Procedure	Remarks
⑦	Fan motor, Fan,	<p><b>2. Attachment</b></p> <p>1) Screw the fan motor with the motor fixing plate. (M8 x 20, 2 pcs).</p> <p><b>NOTE</b></p> <hr/> <p>Fix the wiring of the motor on the electrical parts box side as right figure.</p> <hr/> <p>2) Attach the earth screw. 3) Put the fan in the fan case. Attach the nose plate to the original position on the fan case.</p> <p><b>NOTE</b></p> <hr/> <p>Adjust the direction of the fan blade.</p> <hr/> <p>4) Insert the fan to the shaft. 5) Tighten the Screw C. (M8 x 20, 8 pcs) 6) Insert the fan to where the shaft of the fan motor stops, and adjust the flat portion(2 places), then tighten the hexagon head bolt.</p> <p><b>NOTE</b></p> <hr/> <p>Check that if the fan rotate smoothly without touching the fan case.</p> <hr/> <p><b>NOTE</b></p> <hr/> <p>Be sure to use a torque wrench for fixing and tighten with 10.0N•m</p> <hr/> <p>7) Hook the fan assembly on the looser screw B. 8) Tighten the screw A and B.(M8 x 20, 10 pcs) 9) A ferrite core is attached to the wire of a fan motor as before within an electric part box. Connect the wires of the fan motor as before, and close and fix the electrical parts box cover. Be sure to wire in the electrical parts box as before.</p> <p><b>NOTE</b></p> <p>When the ferrite core is attached to the earth wire of a fan motor as below photo, please repairing work indicated to P94 ~ 97.</p>  <p>Ferrite core attached in earth lead of motor</p>	     <p>Ferrite core</p>

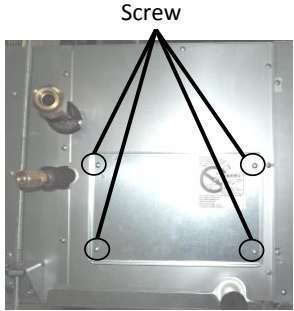
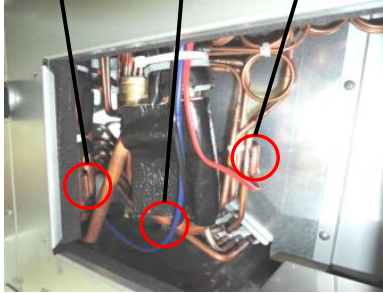
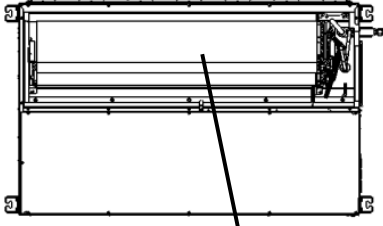
No.	Part name	Procedure	Remarks
⑧	Drain pan	<p><b>1. Detachment</b></p> <p>1) Remove the drain hose or drain cap and then extract the drain water accumulated in the drain pan.</p> <p><b>NOTE</b></p> <hr/> <p>When removing the drain hose or drain cap, be sure to take the drain water with a bucket, etc.</p> <hr/> <p>2) Remove the fixing screws A fixing the bottom plate . (10 positions) Loosen the fixing screws B. (3 positions)</p> <p>3) Slide the bottom plate (drain side) to the arrow direction and then remove the panel.</p> <p>4) Loosen the fixing screw of the drain pan supporter, and turn the drain pan supporter.</p> <p>5) Lower the drain pan of the drain socket side, and remove it to the arrow direction slowly.</p> <p><b>CAUTION</b></p> <hr/> <p>When removing the drain pan, do not hold the drain socket. (Water leakage may occur.)</p> <hr/> <p><b>2. Attachment</b></p> <p>1) Put back the drain pan, and turn back the drain pan supporter and fix it with the screws.</p>	 <p>Bottom plate (Drain side) Screw B</p> <p>Screw A</p>  <p>Drain pan supporter</p> <p>Drain pan pull-out direction.</p>  <p>Drain pan</p> <p>Drain socket</p>

No.	Part name	Procedure	Remarks
⑨	Sensor TC1,TC2,TCJ	<p><b>1. Detachment</b></p> <ol style="list-style-type: none"> <li>1) Perform 1 of ① to open the electrical parts box cover.</li> <li>2) Loosen the fixing screws of the inspection cover and open the inspection cover.</li> <li>3) Remove the connectors of the wires of TC1 sensor , TC2 sensor and TCJ sensor from the control P.C. board.</li> </ol> <p>CN100 : TC1 sensor (3P: Brown)  CN101 : TC2 sensor (2P: Black)  CN102 : TCJ sensor (2P: Red)</p>  <p>Control P.C.board MCC-1643</p> <p><b>2. Attachment</b></p> <ol style="list-style-type: none"> <li>1) Attach the TC1 sensor , TC2 sensor and TCJ sensor to the original position.</li> <li>2) Wire the wires of TC1 sensor, TC2 sensor, and TCJ sensor as before.</li> <li>3) Attach the left side panel as before.</li> </ol>	 <p>Screw</p> <p>Inspection cover</p>  <p>TC1 sensor TC2 sensor TCJ sensor</p>
⑩	Heat exchanger	<p><b>1. Detachment</b></p> <ol style="list-style-type: none"> <li>1) Recover the refrigerant gas and then remove the refrigerant pipe of the indoor unit.</li> <li>2) Perform 1 of ⑧.</li> <li>3) Perform 1 of ⑨.</li> <li>4) Remove the screws (M8 x 20, 5 pcs) and remove the right side panel.</li> <li>5) Remove the screws (M8 x 20, 4 pcs) and remove the evaporator partition (back).</li> <li>6) While holding the heat exchanger, remove the fixing screws (M8 x 20, 5 pcs) of the fixing end plate (UP) and evaporator partition (DOWN) and then take out the heat exchanger slowly.</li> </ol>	 <p>Heat exchanger</p>  <p>Right side panel</p> <p>Fixing screws</p>  <p>Evaporator partition (back)</p> <p>Fixing screws</p>

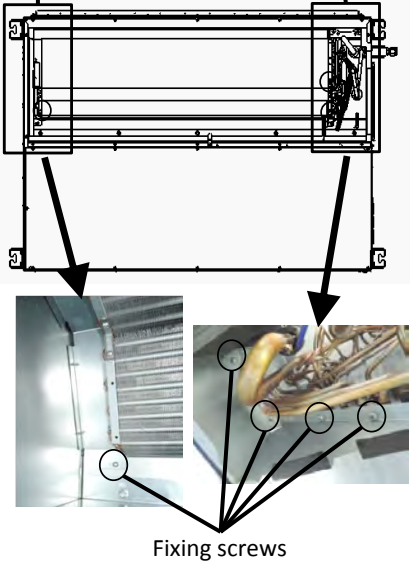
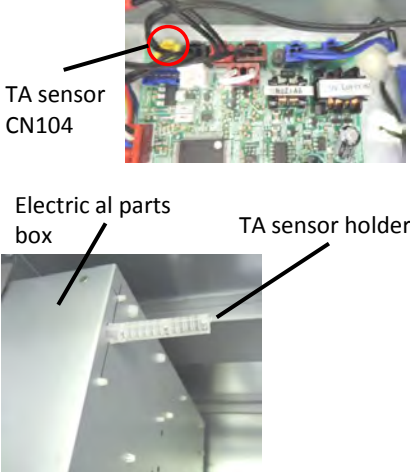
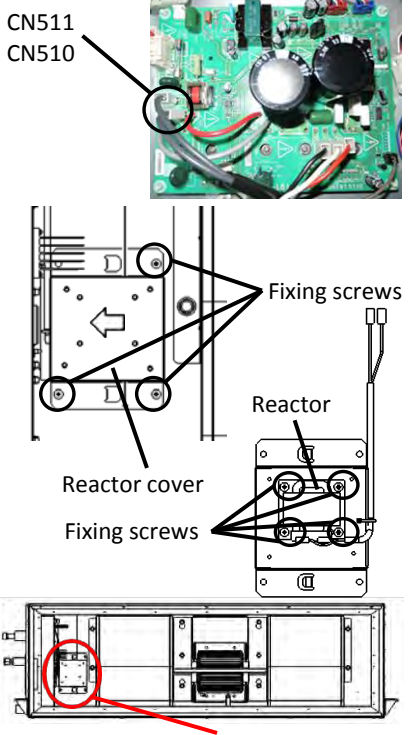

No.	Part name	Procedure	Remarks
⑩	Heat exchanger	<p><b>2. Attachment</b></p> <ol style="list-style-type: none"> <li>1) Attach the heat exchanger to the original position, attach the fixing end plate (UP) and evaporator partition (Down) as before.</li> <li>2) Attach the evaporator partition (back) as before.</li> <li>3) Wire the wires of TC1 sensor, TC2 sensor, and TCJ sensor as before.</li> <li>4) Attach the right side panel and left side panel as before.</li> <li>5) Perform 2 of ⑧.</li> <li>6) Attach the bottom base as before.</li> </ol>	<p>Evaporator partition (DN) Fixing end plate (UP)</p>  <p>Fixing screws</p>
⑪	Sensor TA	<p><b>1. Detachment</b></p> <ol style="list-style-type: none"> <li>1) Perform 1 of ① and 1 of ⑥.</li> <li>2) Remove the connector of the wires of TA sensor from the control P.C. board.</li> <li>3) Pinch the lock of the TA sensor holder from the outside of the electrical parts box and push it into the inside of the electrical parts box.</li> </ol> <p><b>2. Attachment</b></p> <ol style="list-style-type: none"> <li>1) Attach the TA sensor to the original position.</li> <li>2) Wire the wires of TA sensor in the holder as before.</li> <li>3) Attach the electrical parts box as before.</li> </ol>	 <p>TA sensor CN104</p> <p>Electrical parts box</p> <p>TA sensor holder</p>
⑫	Reactor	<p><b>1. Detachment</b></p> <ol style="list-style-type: none"> <li>1) Perform 1 of ① and 1 of ⑥.</li> <li>2) Remove the connector of the wires of the reactor from the fan control P.C. board.</li> <li>3) Remove the fixing screws fixing the reactor cover. Slide the reactor cover to the arrow direction and remove.</li> <li>3) Remove the fixing screws fixing the reactor. Remove the reactor from the reactor cover.</li> </ol> <p><b>2. Attachment</b></p> <ol style="list-style-type: none"> <li>1) Attach the reactor to the reactor cover.</li> <li>2) Attach the reactor cover as before.</li> <li>3) Wire the wires of the reactor in the holder as before.</li> </ol>	 <p>CN511 CN510</p> <p>Fixing screws</p> <p>Reactor</p> <p>Reactor cover</p> <p>Fixing screws</p> <p>Reactor assembly</p>

**NOTE**

After assembling, check if that there is no abnormal sound, vibration, or puncture.  
Check the exchange point when you have a problem.

# [The way of repairing high static duct 8/10HP according to specification change]

## 1. Contents

- (1) Target production
- (2) Replacing noise filter PCB
- (3) Remove ferrite core which is set in earth lead of fan motor
- (4) Add ferrite core to motor lead

## 2. Required part

- (1) New noise filter PCB(MCC1551)
- (2) Tie band

## 3. Target production

3-1 Target model name .

Model name	Type	System	The production year
RAV-SM2244DTP-E/-TR	High static duct 8HP	LC	October, 2017 or before
RAV-SM2804DTP-E/-TR	High static duct 10HP	LC	
MMD-AP0726HP-E/-TR	High static duct 8HP	VRF	
MMD-AP0966HP-E/-TR	High static duct 10HP	VRF	

3-2 Target products .

The target is a product which is installed ferrite core in motor earth lead.



Ferrite core attached in earth lead of motor

## 4. The contents of other repairing except motor exchanging

4-1 Summary of modification points

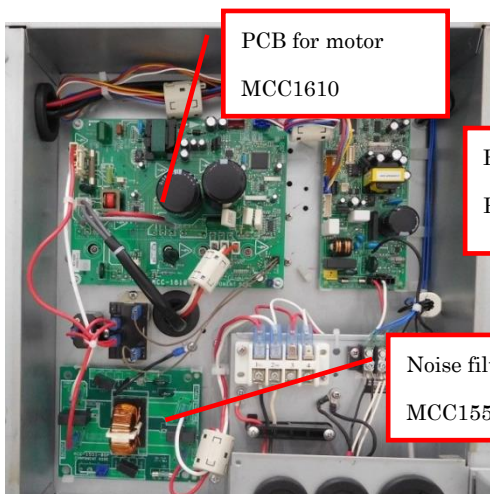

PCB for motor  
MCC1610

Replace noise filter  
PCB to be new one

Noise filter PCB  
MCC1551

Photo of control BOX inside before repairing

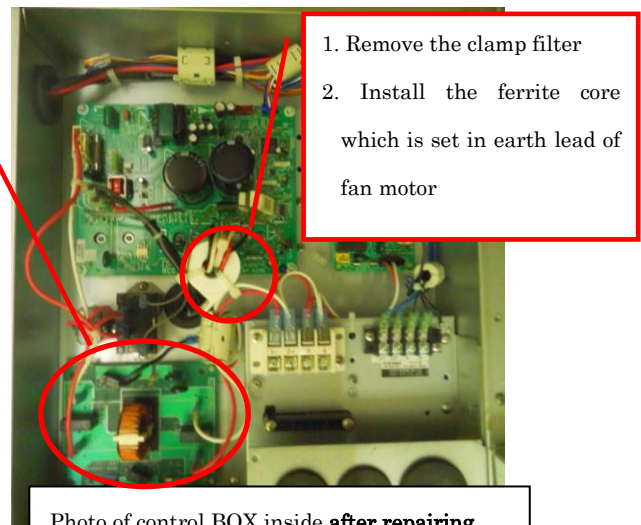

1. Remove the clamp filter  
2. Install the ferrite core which is set in earth lead of fan motor

Photo of control BOX inside after repairing



: Clamp filter



: Ferrite core



1. Remove the ferrite core
2. Tie the extra length of earth lead by tie band

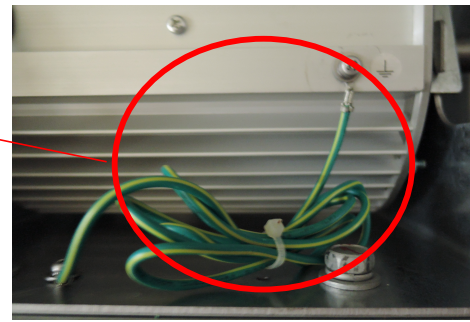

Photo of motor earth lead before repairing

Photo of motor earth lead after repairing

4-2 Replace to new noise filter PCB

[Step1]

Remove the earth screw from metal plate.

[Step2]

Remove four wiring (red and white) which are connected in PCB.

**Notice : These wiring have lock mechanism. So when remove the wiring, it need to push the lock which is set side of connector.**

[Step3]

Unlock the four PCB spacers and remove.

[Step4]

Replace the new noise filter PCB to PCB spacer and connect wiring and tighten screw same as step 1 to 3.

**Notice : Before replace the new noise filter PCB, check the number which is described in label on PCB**

Old PCB : 1117878001

Alternate new PCB: 1117878002

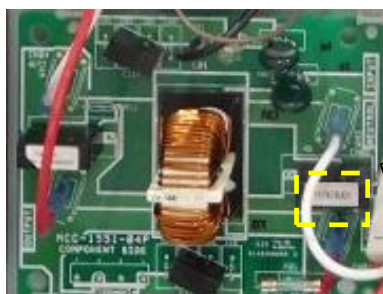
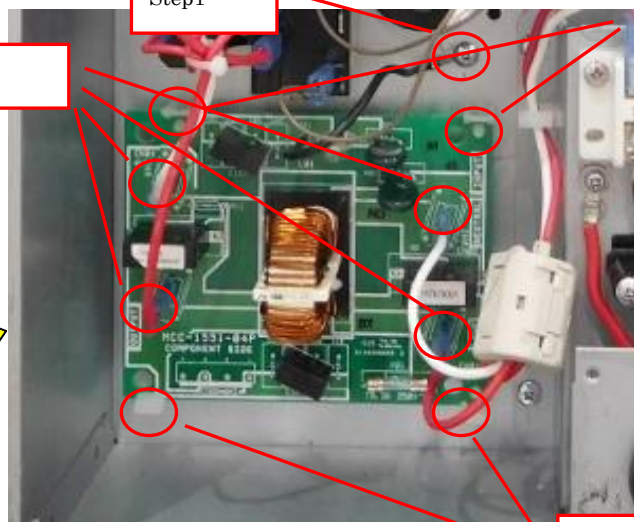
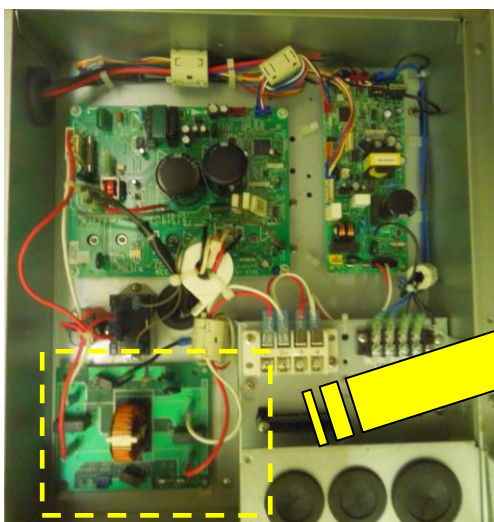

Old PCB	: 111787800 <u>1</u>
Alternate new PCB	: 111787800 <u>2</u>



4-3 Remove ferrite core which is set in earth lead of fan motor and bundle extra length

[Step1]

Remove the earth screw from metal plate.

[Step2]

Cut the tie band attached in ferrite core and remove a screw which is fixed the ferrite core.

[Step3]

Unwind the earth lead from ferrite core and take off ferrite core.

**Notice : Keep the ferrite core. Because the ferrite core is used in motor lead later**

[Step4]

Tighten the earth screw.

[Step5]

Bundle up the extra earth lead by folding in half at four times.

[Step6]

Tie the extra earth lead by tie band.

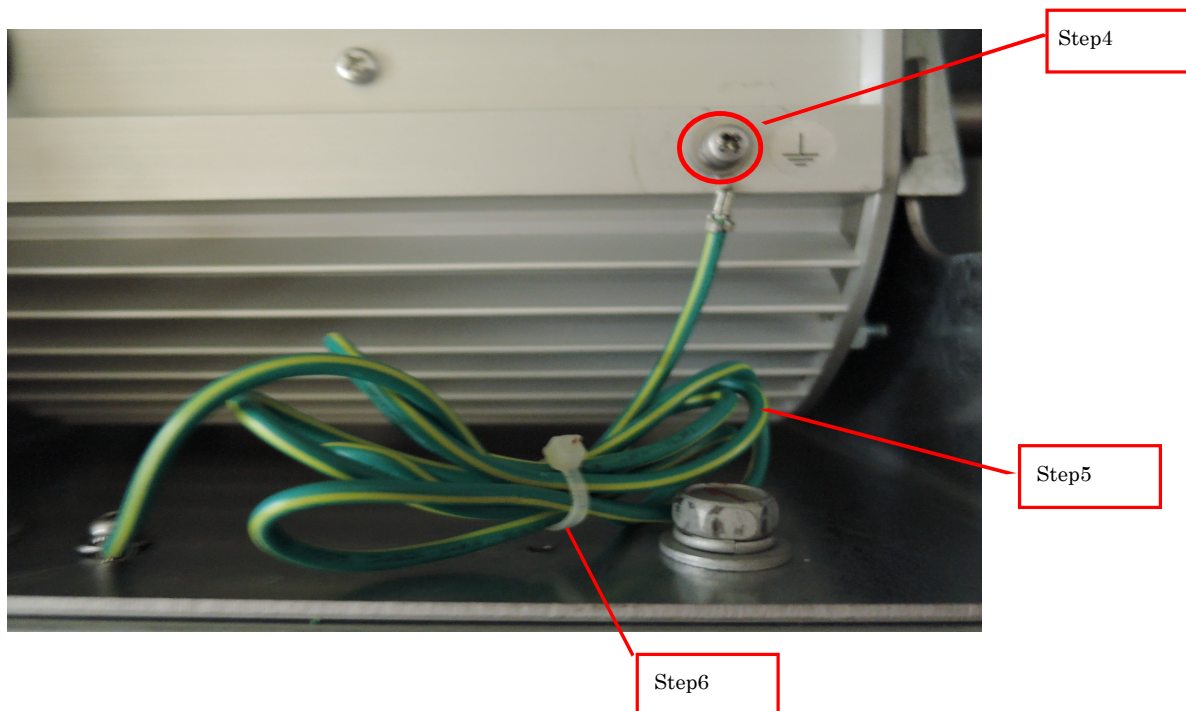
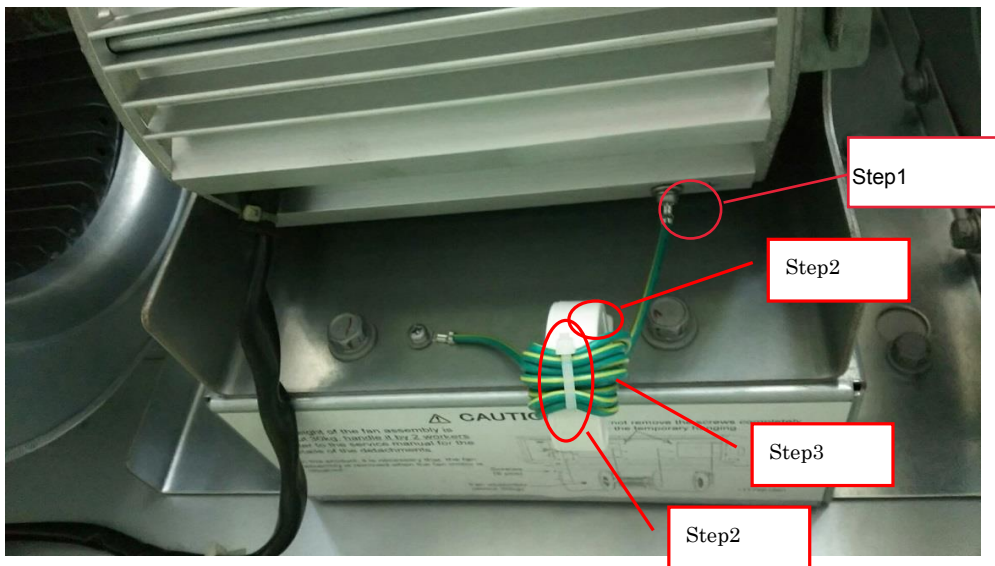

4-4 Install the ferrite core of motor earth lead to motor lead

[Step1]

Remove the clamp filter from motor lead.

[Step2] Only motor lead has connect to PCB(MCC1610)

Remove the motor lead from PCB(MCC1610)

[Step3]

Through the motor lead in a hole of ferrite core at twice.

[Step4]

Connect the motor lead to PCB(MCC1610).

**Notice : Check the connection between motor lead and connector on PCB invariably**

**Red motor lead = CN705(RED) White motor lead = CN704(WHI) Black lead = CN703(BLK)**

[Step5]

Fix the ferrite core to motor lead and reactor lead and white lead of power lead by using tie band.

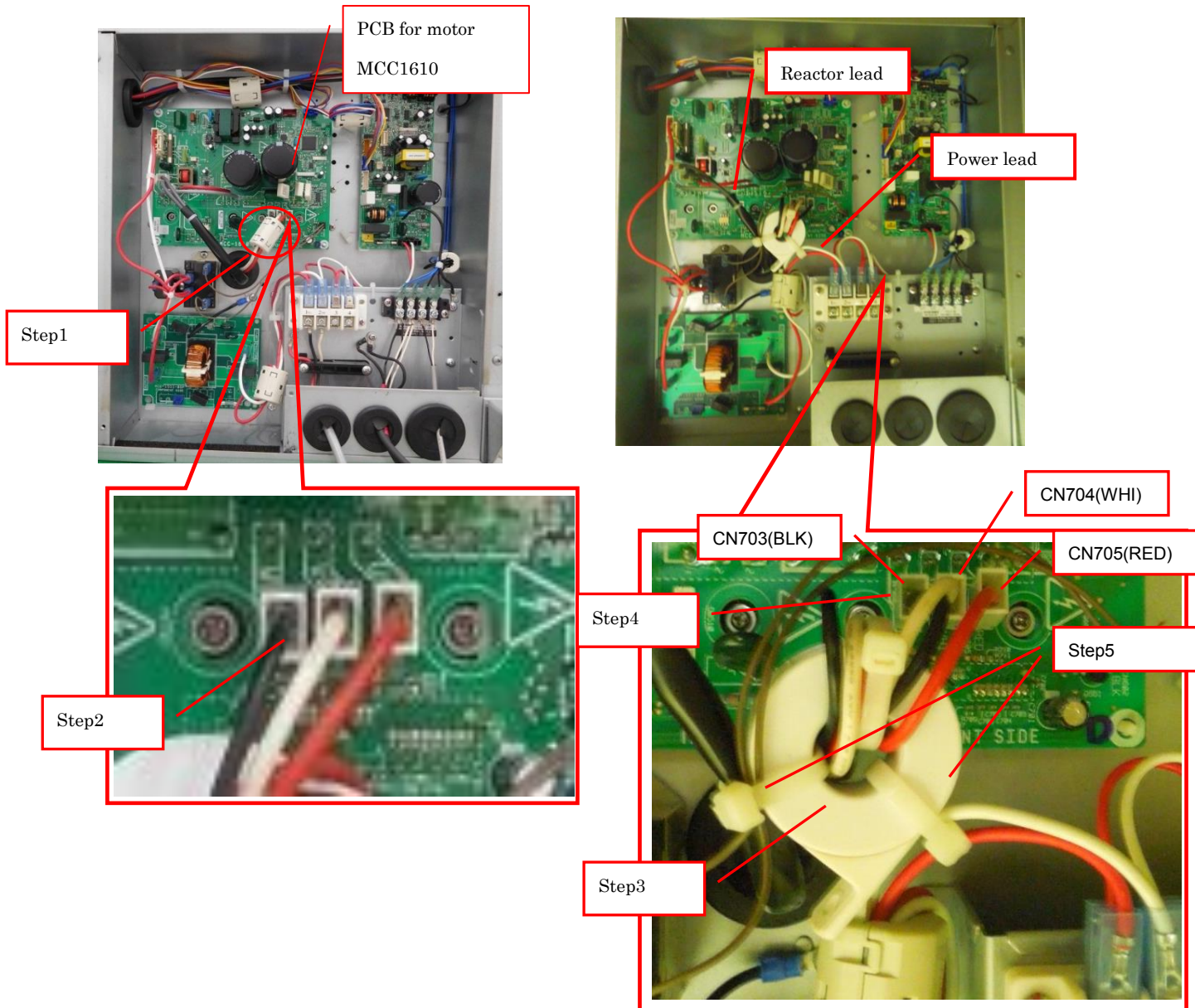

# 12. EXPLODED VIEWS AND PARTS LIST

## 12-1. MMD-AP0726HP-E(TR), MMD-AP0966HP-E(TR)

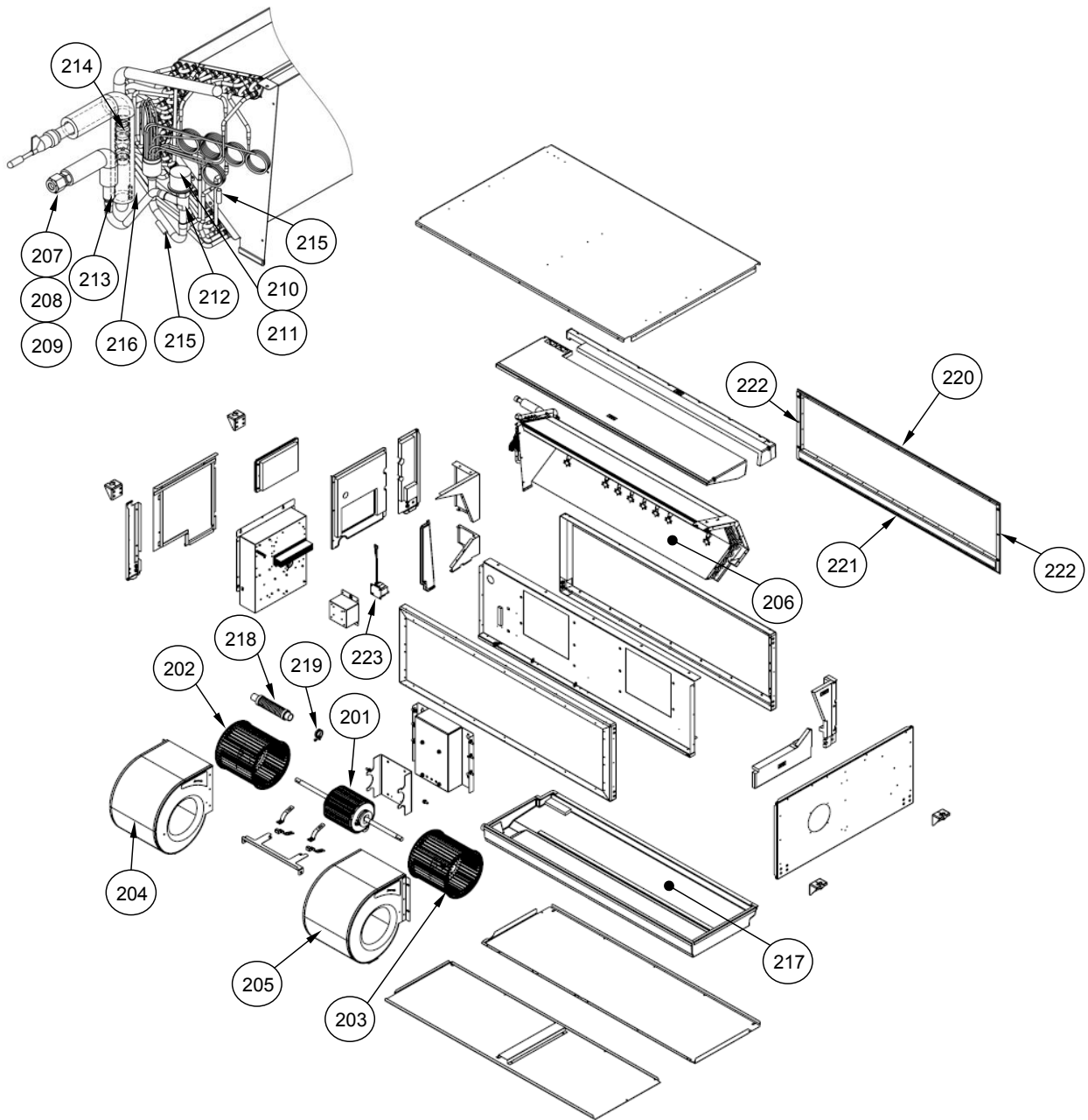

Location No.	Part No.	Description	Q'ty/Set MMD-			
			AP0726 HP-E	AP0966 HP-E	AP0726 HP-TR	AP0966 HP-TR
201	43T21463	MOTOR, FAN	1	1	1	1
202	43T20346	FAN, MULTI BLADE, LEFT	1	1	1	1
203	43T20345	FAN, MULTI BLADE, RIGHT	1	1	1	1
204	43T22347	CASE, FAN, LEFT	1	1	1	1
205	43T22346	CASE, FAN, RIGHT	1	1	1	1
206	43T44562	REFIGERATION CYCLE ASSY	1	1	1	1
207	43T47333	BONNET, 12.7 DIA	1	1	1	1
208	43T82333	SOCKET, LIQUID	1	1	1	1
209	43T97317	NUT, FLARE, 1/2 IN	1	1	1	1
210	43T46473	MOTOR, PMV	1	1	1	1
211	43T46417	SHEET, PMV	1	1	1	1
212	43T46472	PMV	1	1	1	1
213	43T47387	STRAINER, LIQUID	1	1	1	1
214	43T47407	STRAINER, GAS	1	1	1	1
215	43T19333	HOLDER, SENSOR	2	2	2	2
216	43T19321	HOLDER, SENSOR GAS	1	1	1	1
217	43T72326	PAN ASSY, DRAIN	1	1	1	1
218	43T70315	HOSE, DRAIN	1	1	1	1
219	43T83311	BAND, HOSE	1	1	1	1
220	43T39371	FLANGE, UPPER	1	1	1	1
221	43T39372	FLANGE, LOWER	1	1	1	1
222	43T39373	FLANGE ,SIDE	2	2	2	2
223	43T58332	REACTOR	1	1	1	1

12-2. Drain pump kit (TCB-DP40DPE)

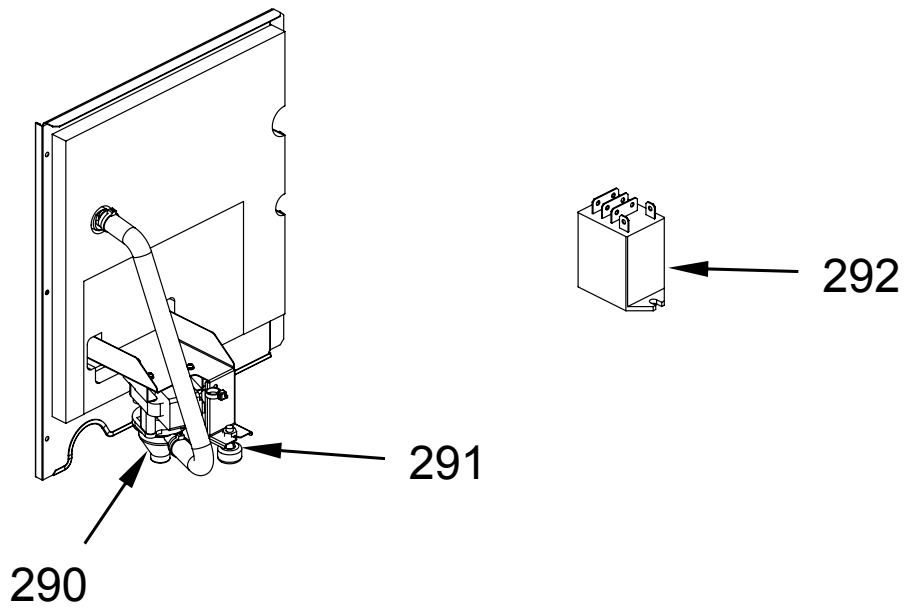

Location No.	Part No.	Description	Q'ty/Set
			TCB-DP40DPE
290	43T77302	PUMP DRAIN	1
291	43T51313	FLOAT SWITCH	1
292	43T54325	RELAY	1



## 12-3. Electric Parts

MMD-AP0726HP-E(TR), MMD-AP0966HP-E(TR)

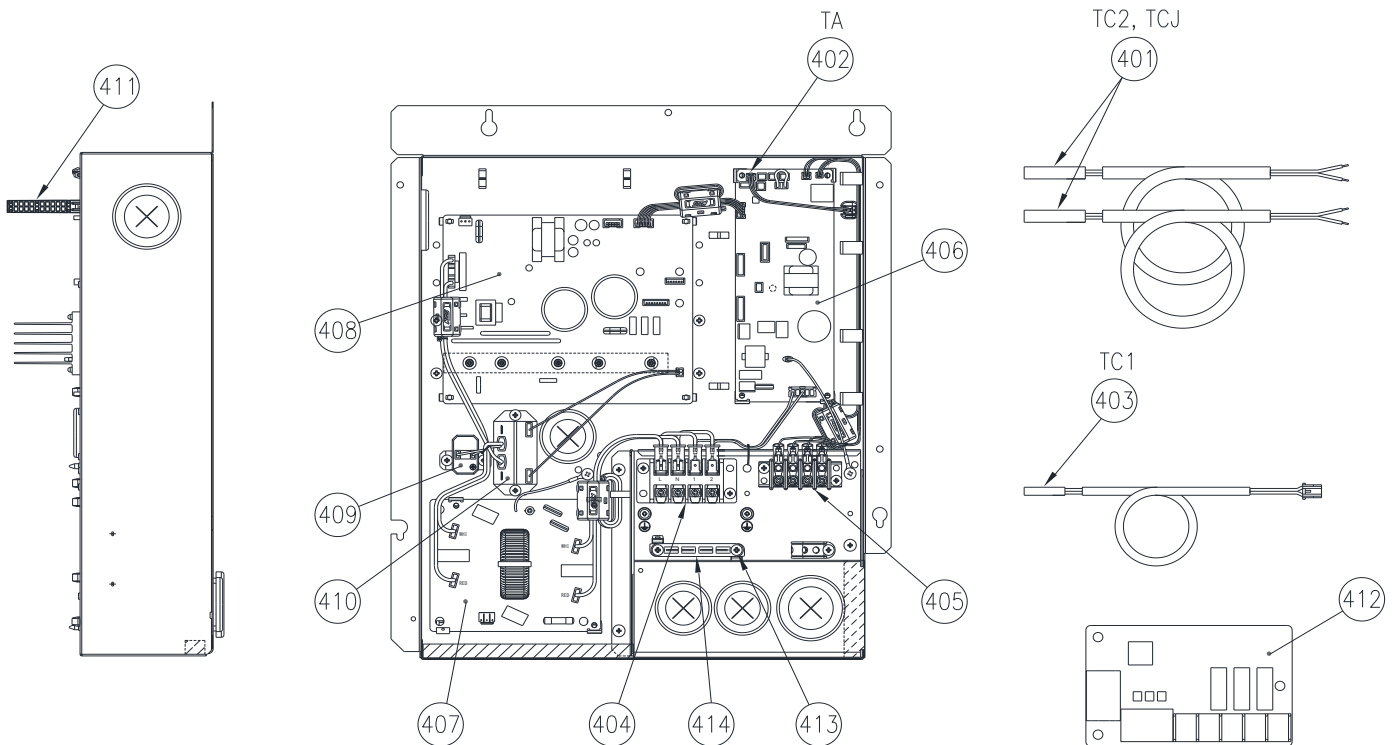

Location No.	Parts No.	Description	Q'ty / SET
401	43T50347	SENSOR ASSY, SERVICE	2
402	43T50476	SERVICE-SENSOR	1
403	43T50477	SERVICE-SENSOR	1
404	43T60458	SERV-TERMINAL	1
405	43T60362	TERMINAL	1
406	43T6V669	ASM-PCB-SERV	1
407	43T6V670	ASM-PCB-SERV	1
408	43T6V671	ASM-PCB-SERV	1
409	43T50345	THERMISTOR, PTC	1
410	43T54324	POWER-RELAY	1
411	43T63356	HOLDER-TA	1
412	43459017	ASM-PCB(OP)	1
413	43T63348	CLAMP, DOWN	1
414	43T63349	CLAMP, UP	1

# WARNINGS ON REFRIGERANT LEAKAGE

## Check of Concentration Limit

The room in which the air conditioner is to be installed requires a design that in the event of refrigerant gas leaking out, its concentration will not exceed a set limit. The refrigerant R410A which is used in the air conditioner is safe, without the toxicity or combustibility of ammonia, and is not restricted by laws to be imposed which protect the ozone layer. However, since it contains more than air, it poses the risk of suffocation if its concentration should rise excessively. Suffocation from leakage of R410A is almost non-existent. With the recent increase in the number of high concentration buildings, however, the installation of multi air conditioner systems is on the increase because of the need for effective use of floor space, individual control, energy conservation by curtailing heat and carrying power etc. Most importantly, the multi air conditioner system is able to replenish a large amount of refrigerant compared with conventional individual air conditioners. If a single unit of the multi conditioner system is to be installed in a small room, select a suitable model and installation procedure so that if the refrigerant accidentally leaks out, its concentration does not reach the limit (and in the event of an emergency, measures can be made before injury can occur). In a room where the concentration may exceed the limit, create an opening with adjacent rooms, or install mechanical ventilation combined with a gas leak detection device. The concentration is as given below.

$$\frac{\text{Total amount of refrigerant (kg)}}{\text{Min. volume of the indoor unit installed room (m}^3\text{)}} \leq \text{Concentration limit (kg/m}^3\text{)}$$

The concentration limit of R410A which is used in multi air conditioners is 0.3kg/m<sup>3</sup>.

### NOTE 1 :

If there are 2 or more refrigerating systems in a single refrigerating device, the amounts of refrigerant should be as charged in each independent device.

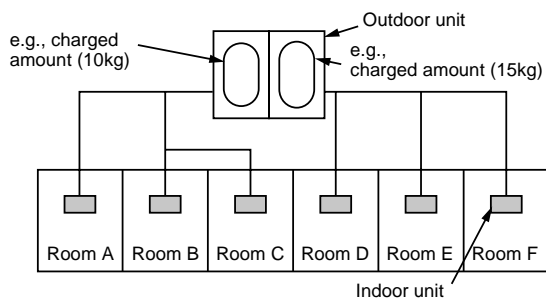

For the amount of charge in this example:  
 The possible amount of leaked refrigerant gas in rooms A, B and C is 10kg.  
 The possible amount of leaked refrigerant gas in rooms D, E and F is 15kg.

## Important

### NOTE 2 :

The standards for minimum room volume are as follows.

- (1) No partition (shaded portion)

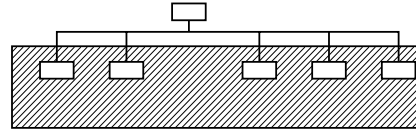

- (2) When there is an effective opening with the adjacent room for ventilation of leaking refrigerant gas (opening without a door, or an opening 0.15% or larger than the respective floor spaces at the top or bottom of the door).

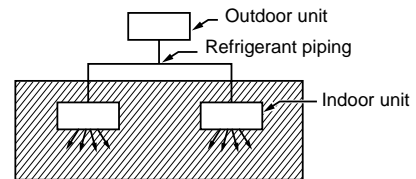

- (3) If an indoor unit is installed in each partitioned room and the refrigerant piping is interconnected, the smallest room of course becomes the object. But when a mechanical ventilation is installed interlocked with a gas leakage detector in the smallest room where the density limit is exceeded, the volume of the next smallest room becomes the object.

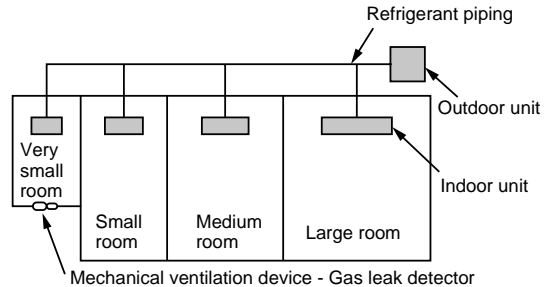

### NOTE 3 :

The minimum indoor floor area compared with the amount of refrigerant is roughly as follows:  
 (When the ceiling is 2.7m high)

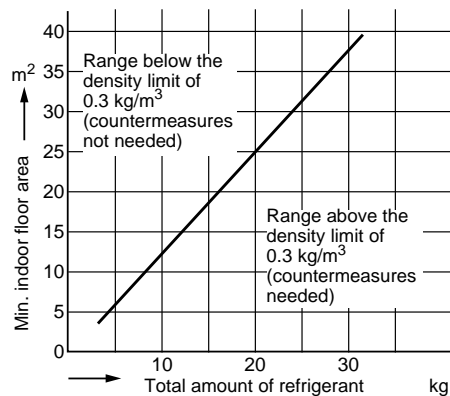

# **TOSHIBA CARRIER (THAILAND) CO.,LTD.**

144/9 MOO 5, BANGKADI INDUSTRIAL PARK, TIVANON ROAD, TAMBOL BANGKADI,  
AMPHUR MUANG, PATHUMTHANI 12000, THAILAND.