

TOSHIBA

FILE No. A10-1809
Revision 1: Sep., 2019

SERVICE MANUAL

AIR-CONDITIONER

SPLIT TYPE

OUTDOOR UNIT

<SUPER DIGITAL INVERTER>

RAV-GP801AT-E

RAV-GP801AT-TR

RAV-GP1101AT-E

RAV-GP1101AT-TR

RAV-GP1401AT-E

RAV-GP1401AT-TR

RAV-GP801ATJ-E

RAV-GP1101ATJ-E

RAV-GP1401ATJ-E

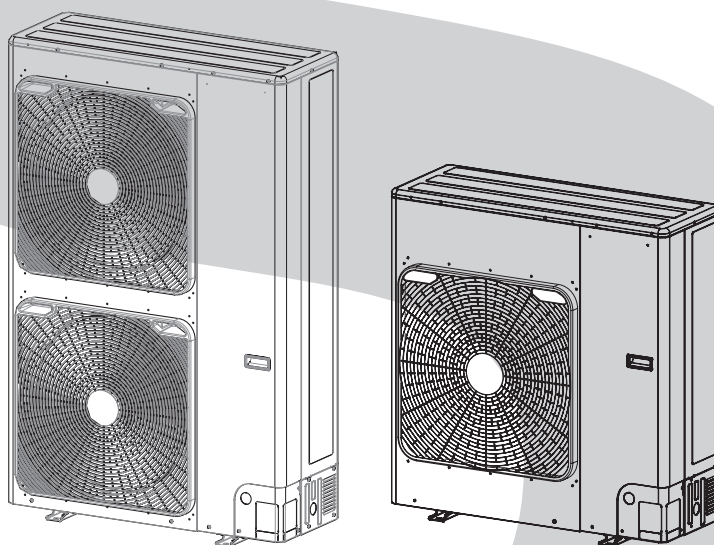

CONTENTS

1. SPECIFICATIONS	17
1-1. Indoor Unit	17
1-1-1. 4-Way Smart Cassette <Single type>	17
1-1-2. 4-Way Smart Cassette <Twin type>	18
1-1-3. 4-Way Cassette <Single type>	19
1-1-4. 4-Way Cassette <Twin type>	20
1-1-5. Compact 4-Way Cassette <Twin type>	21
1-1-6. Slim Duct <Twin type>	22
1-1-7. Duct <Single type>	23
1-1-8. Duct <Twin type>	24
1-1-9. Ceiling <Single type>	25
1-1-10. Ceiling <Twin type>	26
1-2. Outdoor Unit	27
1-3. Operation Characteristic Curve	28
2. CONSTRUCTION VIEWS (EXTERNAL VIEWS)	30
2-1. RAV-GP801AT*	30
2-2. RAV-GP1101AT*, GP1401AT*	31
2-3. Branch pipe	32
3. OUTDOOR UNIT REFRIGERANTING CYCLE DIAGRAM	33
4. WIRING DIAGRAM	36
4-1. RAV-GP801AT*	36
4-2. RAV-GP1101AT*, GP1401AT*	37
5. SPECIFICATIONS OF ELECTRICAL PARTS	38
5-1. Outdoor Unit	38
6. REFRIGERANT R32	39
6-1. Safety During Installation/Serviceing	39
6-2. Refrigerant Piping Installation	39
6-2-1. Piping Materials and Joints Used	39
6-2-2. Processing of Piping Materials	40
6-3. Tools	43
6-3-1. Required Tools	43
6-4. Recharging of Refrigerant	43
6-5. Brazing of Pipes	44
6-5-1. Materials for Brazing	44
6-5-2. Flux	44
6-5-3. Brazing	45
6-6. Instructions for Re-use Piping of R22 or R407C	46
6-6-1. Basic Conditions Needed to Reuse the Existing Pipe	46
6-6-2. Restricted Items to Use the Existing Pipes	46
6-6-3. Branching Pipe for Simultaneous Operation System	46
6-6-4. Curing of Pipes	46
6-6-5. Final Installation Checks	47
6-6-6. Handling of Existing Pipe	48
6-6-7. Recovering Refrigerant	48
6-7. Charging additional refrigerant	48
6-7-1. [Assumed gas leak]	48
6-7-2. [Limiting the additional charge]	48
6-7-3. [Cautions on charging additional refrigerant]	48

6-8. General safety precautions for using R32 refrigerant	49
6-8-1. Recovery	49
6-8-2. Decommissioning	49
6-8-3. Labelling	49
7. CIRCUIT CONFIGURATION AND CONTROL SPECIFICATIONS	50
7-1. Outdoor Unit Control	50
7-1-1. Print Circuit Board, MCC-1705	50
7-2. Outline of Main Controls	51
8. TROUBLESHOOTING	57
8-1. Summary of Troubleshooting	57
8-2. Troubleshooting	59
8-2-1. Outline of judgment	59
8-2-2. Others (Other than Check Code)	61
8-2-3. Monitor Function of Remote Controller Switch	62
8-2-4. Check Code List (Outdoor)	63
8-2-5. Diagnostic Procedure for Each Check Code (Outdoor Unit)	69
9. SETUP AT LOCAL SITE AND OTHERS	80
9-1. Calling of Check code History	80
9-2. Outdoor Unit	82
10. ADDRESS SETUP	91
10-1. Address Setup Procedure	91
10-2. Address Setup & Group Control	92
10-2-1. System Configuration	93
10-2-2. Automatic Address Example from Unset Address (No miswiring)	94
10-3. Remote Controller Wiring	94
10-4. Address Setup (Manual setting from remote controller)	95
10-5. Confirmation of Indoor Unit No. Position	96
11. REPLACEMENT OF THE SERVICE P.C. BOARD	98
12. HOW TO EXCHANGE COMPRESSOR	99
12-1. Exchanging Procedure of Compressor (Outline)	99
13. DETACHMENTS	100
13-1. RAV-GP801AT*	100
13-2. RAV-GP1101AT*, GP1401AT*	110
14. EXPLODED VIEWS AND PARTS LIST	120
14-1. Outdoor Unit	120
14-2. Inverter Assembly	124

Original instruction

Please read carefully through these instructions that contain important information which complies with the “Machinery Directive” (Directive 2006/42/EC), and ensure that you understand them.

Some of the details provided in these instructions differ from the service manual, and the instructions provided here take precedence.

Generic Denomination: Air Conditioner

Definition of Qualified Installer or Qualified Service Person

The air conditioner must be installed, maintained, repaired and removed by a qualified installer or qualified service person.

When any of these jobs is to be done, ask a qualified installer or qualified service person to do them.

A qualified installer or qualified service person is an agent who has the qualifications and knowledge described in the table below.

Agent	Qualifications and knowledge which the agent must have
Qualified installer (*1)	<ul style="list-style-type: none">• The qualified installer is a person who installs, maintains, relocates and removes the air conditioners made by Toshiba Carrier Corporation. He or she has been trained to install, maintain, relocate and remove the air conditioners made by Toshiba Carrier Corporation or, alternatively, he or she has been instructed in such operations by an individual or individuals who have been trained and is thus thoroughly acquainted with the knowledge related to these operations.• The qualified installer who is allowed to do the electrical work involved in installation, relocation and removal has the qualifications pertaining to this electrical work as stipulated by the local laws and regulations, and he or she is a person who has been trained in matters relating to electrical work on the air conditioners made by Toshiba Carrier Corporation or, alternatively, he or she has been instructed in such matters by an individual or individuals who have been trained and is thus thoroughly acquainted with the knowledge related to this work.• The qualified installer who is allowed to do the refrigerant handling and piping work involved in installation, relocation and removal has the qualifications pertaining to this refrigerant handling and piping work as stipulated by the local laws and regulations, and he or she is a person who has been trained in matters relating to refrigerant handling and piping work on the air conditioners made by Toshiba Carrier Corporation or, alternatively, he or she has been instructed in such matters by an individual or individuals who have been trained and is thus thoroughly acquainted with the knowledge related to this work.• The qualified installer who is allowed to work at heights has been trained in matters relating to working at heights with the air conditioners made by Toshiba Carrier Corporation or, alternatively, he or she has been instructed in such matters by an individual or individuals who have been trained and is thus thoroughly acquainted with the knowledge related to this work.
Qualified service person (*1)	<ul style="list-style-type: none">• The qualified service person is a person who installs, repairs, maintains, relocates and removes the air conditioners made by Toshiba Carrier Corporation. He or she has been trained to install, repair, maintain, relocate and remove the air conditioners made by Toshiba Carrier Corporation or, alternatively, he or she has been instructed in such operations by an individual or individuals who have been trained and is thus thoroughly acquainted with the knowledge related to these operations.• The qualified service person who is allowed to do the electrical work involved in installation, repair, relocation and removal has the qualifications pertaining to this electrical work as stipulated by the local laws and regulations, and he or she is a person who has been trained in matters relating to electrical work on the air conditioners made by Toshiba Carrier Corporation or, alternatively, he or she has been instructed in such matters by an individual or individuals who have been trained and is thus thoroughly acquainted with the knowledge related to this work.• The qualified service person who is allowed to do the refrigerant handling and piping work involved in installation, repair, relocation and removal has the qualifications pertaining to this refrigerant handling and piping work as stipulated by the local laws and regulations, and he or she is a person who has been trained in matters relating to refrigerant handling and piping work on the air conditioners made by Toshiba Carrier Corporation or, alternatively, he or she has been instructed in such matters by an individual or individuals who have been trained and is thus thoroughly acquainted with the knowledge related to this work.• The qualified service person who is allowed to work at heights has been trained in matters relating to working at heights with the air conditioners made by Toshiba Carrier Corporation or, alternatively, he or she has been instructed in such matters by an individual or individuals who have been trained and is thus thoroughly acquainted with the knowledge related to this work.

Definition of Protective Gear

When the air conditioner is to be transported, installed, maintained, repaired or removed, wear protective gloves and 'safety' work clothing.



In addition to such normal protective gear, wear the protective gear described below when undertaking the special work detailed in the table below.

Failure to wear the proper protective gear is dangerous because you will be more susceptible to injury, burns, electric shocks and other injuries.

Work undertaken	Protective gear worn
All types of work	Protective gloves "Safety" working clothing
Electrical-related work	Gloves to provide protection for electricians Insulating shoes Clothing to provide protection from electric shock
Work done at heights (50 cm or more)	Helmets for use in industry
Transportation of heavy objects	Shoes with additional protective toecap
Repair of outdoor unit	Gloves to provide protection for electricians



The important contents concerned to the safety are described on the product itself and on this Service Manual. Please read this Service Manual after understanding the described items thoroughly in the following contents (Indications/Illustrated marks), and keep them.

[Explanation of indications]

Indication	Explanation
 DANGER	Indicates contents assumed that an imminent danger causing a death or serious injury of the repair engineers and the third parties when an incorrect work has been executed.
 WARNING	Indicates possibilities assumed that a danger causing a death or serious injury of the repair engineers, the third parties, and the users due to troubles of the product after work when an incorrect work has been executed.
 CAUTION	Indicates contents assumed that an injury or property damage (*) may be caused on the repair engineers, the third parties, and the users due to troubles of the product after work when an incorrect work has been executed.

* Property damage : Enlarged damage concerned to property, furniture, and domestic animal/pet

[Explanation of illustrated marks]





Mark	Explanation
	Indicates prohibited items (Forbidden items to do) The sentences near an illustrated mark describe the concrete prohibited contents.
	Indicates mandatory items (Compulsory items to do) The sentences near an illustrated mark describe the concrete mandatory contents.
	Indicates cautions (Including danger/warning) The sentences or illustration near or in an illustrated mark describe the concrete cautious contents.

Warning Indications on the Air Conditioner Unit

[Confirmation of warning label on the main unit]

Confirm that labels are indicated on the specified positions



If removing the label during parts replace, stick it as the original.

Warning indication	Description				
 <table border="1" data-bbox="172 461 821 701"> <tr> <td data-bbox="172 461 308 551"></td> <td data-bbox="308 461 821 551">WARNING</td> </tr> <tr> <td data-bbox="172 551 308 701"></td> <td data-bbox="308 551 821 701"> ELECTRICAL SHOCK HAZARD Disconnect all remote electric power supplies before servicing. </td> </tr> </table>		WARNING		ELECTRICAL SHOCK HAZARD Disconnect all remote electric power supplies before servicing.	WARNING ELECTRICAL SHOCK HAZARD Disconnect all remote electric power supplies before servicing.
	WARNING				
	ELECTRICAL SHOCK HAZARD Disconnect all remote electric power supplies before servicing.				
 <table border="1" data-bbox="172 819 821 1037"> <tr> <td data-bbox="172 819 308 909"></td> <td data-bbox="308 819 821 909">WARNING</td> </tr> <tr> <td data-bbox="172 909 308 1037"></td> <td data-bbox="308 909 821 1037"> Moving parts. Do not operate unit with grille removed. Stop the unit before the servicing. </td> </tr> </table>		WARNING		Moving parts. Do not operate unit with grille removed. Stop the unit before the servicing.	WARNING Moving parts. Do not operate unit with grille removed. Stop the unit before the servicing.
	WARNING				
	Moving parts. Do not operate unit with grille removed. Stop the unit before the servicing.				
 <table border="1" data-bbox="172 1155 821 1373"> <tr> <td data-bbox="172 1155 308 1245"></td> <td data-bbox="308 1155 821 1245">CAUTION</td> </tr> <tr> <td data-bbox="172 1245 308 1373"></td> <td data-bbox="308 1245 821 1373"> High temperature parts. You might get burned when removing this panel. </td> </tr> </table>		CAUTION		High temperature parts. You might get burned when removing this panel.	CAUTION High temperature parts. You might get burned when removing this panel.
	CAUTION				
	High temperature parts. You might get burned when removing this panel.				
 <table border="1" data-bbox="172 1473 821 1668"> <tr> <td data-bbox="172 1473 308 1563"></td> <td data-bbox="308 1473 821 1563">CAUTION</td> </tr> <tr> <td data-bbox="172 1563 308 1668"></td> <td data-bbox="308 1563 821 1668"> Do not touch the aluminum fins of the unit. Doing so may result in injury. </td> </tr> </table>		CAUTION		Do not touch the aluminum fins of the unit. Doing so may result in injury.	CAUTION Do not touch the aluminum fins of the unit. Doing so may result in injury.
	CAUTION				
	Do not touch the aluminum fins of the unit. Doing so may result in injury.				
 <table border="1" data-bbox="172 1783 821 2040"> <tr> <td data-bbox="172 1783 308 1872"></td> <td data-bbox="308 1783 821 1872">CAUTION</td> </tr> <tr> <td data-bbox="172 1872 308 2040"></td> <td data-bbox="308 1872 821 2040"> BURST HAZARD Open the service valves before the operation, otherwise there might be the burst. </td> </tr> </table>		CAUTION		BURST HAZARD Open the service valves before the operation, otherwise there might be the burst.	CAUTION BURST HAZARD Open the service valves before the operation, otherwise there might be the burst.
	CAUTION				
	BURST HAZARD Open the service valves before the operation, otherwise there might be the burst.				

Precaution for Safety



The appliance shall be installed in accordance with national wiring regulations. Capacity shortages of the power circuit or an incomplete installation may cause an electric shock or fire.

DANGER

 Turn off breaker.	<p>Before carrying out the installation, maintenance, repair or removal work, be sure to set the circuit breaker to the OFF position. Otherwise, electric shocks may result.</p>
	<p>Before opening the intake grille of the indoor unit or service panel of the outdoor unit, set the circuit breaker to the OFF position. Failure to set the circuit breaker to the OFF position may result in electric shocks through contact with the interior parts. Only a qualified installer (*1) or qualified service person (*1) is allowed to remove the intake grille of the indoor unit or service panel of the outdoor unit and do the work required.</p>
	<p>Before starting to repair the outdoor unit fan or fan guard, be absolutely sure to set the circuit breaker to the OFF position, and place a "Work in progress" sign on the circuit breaker.</p>
	<p>When cleaning the filter or other parts of the indoor unit, set the circuit breaker to OFF without fail, and place a "Work in progress" sign near the circuit breaker before proceeding with the work.</p>
 Prohibition	<p>Do not turn ON the circuit breaker under the condition of removing a cabinet, a panel, etc. Otherwise, it leads to an electric shock with a high voltage, resulting in loss of life.</p>







(*1) Refer to the "Definition of Qualified Installer or Qualified Service Person."

 **WARNING**





 General	<p>Before starting to repair the air conditioner, read carefully through the Service Manual, and repair the air conditioner by following its instructions.</p>
	<p>Only qualified service person (*1) is allowed to repair the air conditioner. Repair of the air conditioner by unqualified person may give rise to a fire, electric shocks, injury, water leaks and/or other problems.</p>
	<p>Only a qualified installer (*1) or qualified service person (*1) is allowed to carry out the electrical work of the air conditioner. Under no circumstances must this work be done by an unqualified individual since failure to carry out the work properly may result in electric shocks and/or electrical leaks.</p>
	<p>Wear protective gloves and safety work clothing during installation, servicing and removal.</p>
	<p>When connecting the electrical wires, repairing the electrical parts or undertaking other electrical jobs, wear gloves to provide protection for electricians, insulating shoes and clothing to provide protection from electric shocks. Failure to wear this protective gear may result in electric shocks.</p>
	<p>Use wiring that meets the specifications in the Installation Manual and the stipulations in the local regulations and laws. Use of wiring which does not meet the specifications may give rise to electric shocks, electrical leakage, smoking and/or a fire.</p>
	<p>Only a qualified installer (*1) or qualified service person (*1) is allowed to undertake work at heights using a stand of 50 cm or more.</p>
	<p>When working at heights, use a ladder which complies with the ISO 14122 standard, and follow the procedure in the ladder's instructions. Also wear a helmet for use in industry as protective gear to undertake the work.</p>
	<p>When working at heights, put a sign in place so that no-one will approach the work location, before proceeding with the work. Parts and other objects may fall from above, possibly injuring a person below.</p>
	<p>Do not touch the aluminum fin of the outdoor unit. You may injure yourself if you do so. If the fin must be touched for some reason, first put on protective gloves and safety work clothing, and then proceed.</p>
	<p>Do not climb onto or place objects on top of the outdoor unit. You may fall or the objects may fall of the outdoor unit and result in injury.</p>
	<p>When transporting the air conditioner, wear shoes with additional protective toecap.</p>
	<p>When transporting the air conditioner, do not hold the bands around the packing carton. You may injure yourself if the bands should break.</p>
<p>This air conditioner has passed the pressure test as specified in IEC 60335-2-40 Annex EE.</p>	
 Electric shock hazard	<p>When you access inside of the electric cover to repair electric parts, wait for about five minutes after turning off the breaker. Do not start repairing immediately. Otherwise you may get electric shock by touching terminals of high-voltage capacitors. Natural discharge of the capacitor takes about five minutes.</p>
 Prohibition	<p>Place a "Work in progress" sign near the circuit breaker while the installation, maintenance, repair or removal work is being carried out. There is a danger of electric shocks if the circuit breaker is set to ON by mistake.</p>
	<p>When checking the electric parts, removing the cover of the electric parts box of Indoor Unit and/or front panel of Outdoor Unit inevitably to determine the failure, put a sign "Do not enter" around the site before the work. Failure to do this may result in third person getting electric shock.</p>
	<p>Before operating the air conditioner after having completed the work, check that the electrical parts box cover of the indoor unit and service panel of the outdoor unit are closed, and set the circuit breaker to the ON position. You may receive an electric shock if the power is turned on without first conducting these checks.</p>





(*1) Refer to the "Definition of Qualified Installer or Qualified Service Person."

 **WARNING**



 Stay on protection	<p>If, in the course of carrying out repairs, it becomes absolutely necessary to check out the electrical parts with the electrical parts box cover of one or more of the indoor units and the service panel of the outdoor unit removed in order to find out exactly where the trouble lies, wear insulated heat-resistant gloves, insulated boots and insulated work overalls, and take care to avoid touching any live parts.</p> <p>You may receive an electric shock if you fail to heed this warning. Only qualified service person (*1) is allowed to do this kind of work.</p>
 Check earth wires.	<p>Before troubleshooting or repair work, check the earth wire is connected to the earth terminals of the main unit, otherwise an electric shock is caused when a leak occurs. If the earth wire is not correctly connected, contact an electric engineer for rework.</p> <p>After completing the repair or relocation work, check that the earth wires are connected properly.</p> <p>Be sure to connect earth wire. (Grounding work) Incomplete earthing causes an electric shock. Do not connect earth wires to gas pipes, water pipes, and lightning rods or earth wires for telephone wires.</p>
 Prohibition of modification.	<p>Do not modify the products. Do not also disassemble or modify the parts. It may cause a fire, electric shock or injury.</p>
 Use specified parts.	<p>When any of the electrical parts are to be replaced, ensure that the replacement parts satisfy the specifications given in the Service Manual (or use the parts contained on the parts list in the Service Manual).</p> <p>Use of any parts which do not satisfy the required specifications may give rise to electric shocks, smoking and/or a fire.</p> <p>Replace components only with parts specified by the manufacturer. Other parts may result in the ignition of refrigerant in the atmosphere due to the refrigerant leak..</p>
 Do not bring a child close to the equipment.	<p>If, in the course of carrying out repairs, it becomes absolutely necessary to check out the electrical parts with the electrical parts box cover of one or more of the indoor units and the service panel of the outdoor unit removed in order to find out exactly where the trouble lies, place "Keep out" signs around the work site before proceeding.</p> <p>Third-party individuals may enter the work site and receive electric shocks if this warning is not heeded.</p>
 Insulating measures	<p>Connect the cut-off lead wires with crimp contact, etc, put the closed end side upward and then apply a water-cut method, otherwise a leak or production of fire is caused at the users' side.</p>
 No fire	<p>When performing repairs using a gas burner, replace the refrigerant with nitrogen gas because the oil that coats the pipes may otherwise burn.</p> <p>When repairing the refrigerating cycle, take the following measures.</p> <ol style="list-style-type: none"> 1) Be attentive to fire around the cycle. When using a gas stove, etc, be sure to put out fire before work; otherwise the oil mixed with refrigerant gas may catch fire. 2) Do not use a brazing in the closed room. When using it without ventilation, carbon monoxide poisoning may be caused. 3) Do not bring inflammables close to the refrigerant cycle, otherwise fire of the brazing may catch the inflammables.

(*1) Refer to the "Definition of Qualified Installer or Qualified Service Person."

 Refrigerant	<p>The refrigerant used by this air conditioner is the R32.</p>
	<p>Check the used refrigerant name and use tools and materials of the parts which match with it. For the products which use R32 refrigerant, the refrigerant name is indicated at a position on the outdoor unit where is easy to see. To prevent miss charging, the route of the service port is changed from one of the former R22. Be careful for miss charging since a charging port of R32 is the same diameter as that of R410A.</p>
	<p>Do not use any refrigerant different from the one specified for complement or replacement. Otherwise, abnormally high pressure may be generated in the refrigeration cycle, which may result in a failure or explosion of the product or an injury to your body.</p>
	<p>For an air conditioner which uses R32, never use other refrigerant than R32. For an air conditioner which uses other refrigerant (R22, R410A etc.), never use R32. If different types of refrigerant are mixed, abnormal high pressure generates in the refrigerating cycle and an injury due to breakage may be caused. If the different type of refrigerants are mixed in, be sure to recharge the refrigerant</p>
	<p>Do not charge refrigerant additionally. If charging refrigerant additionally when refrigerant gas leaks, the refrigerant composition in the refrigerating cycle changes resulted in change of air conditioner characteristics or refrigerant over the specified standard amount is charged and an abnormal high pressure is applied to the inside of the refrigerating cycle resulted in cause of breakage or injury. Therefore if the refrigerant gas leaks, recover the refrigerant in the air conditioner, execute vacuuming, and then newly recharge the specified amount of liquid refrigerant. In this time, never charge the refrigerant over the specified amount.</p>
	<p>When recharging the refrigerant in the refrigerating cycle, do not mix the refrigerant or air other than R32 into the specified refrigerant. If air or others is mixed with the refrigerant, abnormal high pressure generates in the refrigerating cycle resulted in cause of injury due to breakage.</p>
	<p>After the installation work, confirm that refrigerant gas does not leak. If refrigerant gas leaks into the room and flows near a fire source, such as a cooking range, it may generate noxious gases, causing a fire.</p>
	<p>Never recover the refrigerant into the outdoor unit. When the equipment is moved or repaired, be sure to recover the refrigerant with recovering device. The refrigerant cannot be recovered in the outdoor unit; otherwise a serious accident such as breakage or injury is caused.</p>
 Assembly/ Cabling	<p>After repair work, surely assemble the disassembled parts, and connect and lead the removed wires as before. Perform the work so that the cabinet or panel does not catch the inner wires. If incorrect assembly or incorrect wire connection was done, a disaster such as a leak or fire is caused at user's side.</p>
 Insulator check	<p>After the work has finished, be sure to use an insulation tester set (500VMΩ) to check the resistance is 1MΩ or more between the charge section and the non-charge metal section (Earth position). If the resistance value is low, a disaster such as a leak or electric shock is caused at user's side.</p>
 Ventilation	<p>When the refrigerant gas leaks during work, execute ventilation. If the refrigerant gas touches to a fire, it may generate noxious gases, causing a fire. A case of leakage of the refrigerant and the closed room full with gas is dangerous because a shortage of oxygen occurs. Be sure to execute ventilation.</p> <p>If refrigerant gas has leaked during the installation work, ventilate the room immediately. If the leaked refrigerant gas comes in contact with fire, it may generate noxious gases, causing a fire.</p>



 Compulsion	<p>When the refrigerant gas leaks, find out the leaked position and repair it surely. If the leaked position cannot be found out and the repair work is interrupted, pump-down and tighten the service valve, otherwise the refrigerant gas may leak into the room. When gas touches to fire such as fan heater, stove or cooking stove, it may generate noxious gases, causing a fire though the refrigerant gas itself is innocuous. When installing equipment which includes a large amount of charged refrigerant in a sub-room, it is necessary that the concentration does not the limit even if the refrigerant leaks. If the refrigerant leaks and exceeds the limit concentration, an accident of shortage of oxygen is caused.</p>
	<p>Tighten the flare nut with a torque wrench in the specified manner. Excessive tighten of the flare nut may cause a crack in the flare nut after a long period, which may result in refrigerant leakage.</p>
	<p>Nitrogen gas must be used for the airtight test.</p>
	<p>The charge hose must be connected in such a way that it is not slack.</p>
	<p>For the installation/moving/reinstallation work, follow to the Installation Manual. If an incorrect installation is done, a trouble of the refrigerating cycle, water leak, electric shock or fire is caused.</p>
	<p>Install the outdoor unit properly in a location that is durable enough to support the weight of the outdoor unit. Insufficient durability may cause the outdoor unit to fall, which may result in injury.</p>
 Check after repair	<p>Once the repair work has been completed, check for refrigerant leaks, and check the insulation resistance and water drainage. Then perform a trial run to check that the air conditioner is running properly.</p>
	<p>After repair work has finished, check there is no trouble. If check is not executed, a fire, electric shock or injury may be caused. For a check, turn off the power breaker.</p>
	<p>After repair work (installation of front panel and cabinet) has finished, execute a test run to check there is no generation of smoke or abnormal sound. If check is not executed, a fire or an electric shock is caused. Before test run, install the front panel and cabinet.</p>
 Do not operate the unit with the valve closed.	<p>Check the following matters before a test run after repairing piping.</p> <ul style="list-style-type: none"> • Connect the pipes surely and there is no leak of refrigerant. • The valve is opened. <p>Running the compressor under condition that the valve closes causes an abnormal high pressure resulted in damage of the parts of the compressor and etc. and moreover if there is leak of refrigerant at connecting section of pipes, the air is suctioned and causes further abnormal high pressure resulted in burst or injury.</p>
 Check after reinstallation	<p>Only a qualified installer (*1) or qualified service person (*1) is allowed to relocate the air conditioner. It is dangerous for the air conditioner to be relocated by an unqualified individual since a fire, electric shocks, injury, water leakage, noise and/or vibration may result.</p>
	<p>Check the following items after reinstallation.</p> <ol style="list-style-type: none"> 1) The earth wire is correctly connected. 2) The power cord is not caught in the product. 3) There is no inclination or unsteadiness and the installation is stable. <p>If check is not executed, a fire, an electric shock or an injury is caused.</p>
 Cooling check	<p>When the service panel of the outdoor unit is to be opened in order for the compressor or the area around this part to be repaired immediately after the air conditioner has been shut down, set the circuit breaker to the OFF position, and then wait at least 10 minutes before opening the service panel. If you fail to heed this warning, you will run the risk of burning yourself because the compressor pipes and other parts will be very hot to the touch. In addition, before proceeding with the repair work, wear the kind of insulated heat-resistant gloves designed to protect electricians.</p>
	<p>When the service panel of the outdoor unit is to be opened in order for the fan motor, reactor, inverter or the areas around these parts to be repaired immediately after the air conditioner has been shut down, set the circuit breaker to the OFF position, and then wait at least 10 minutes before opening the service panel. If you fail to heed this warning, you will run the risk of burning yourself because the fan motor, reactor, inverter heat sink and other parts will be very hot to the touch. In addition, before proceeding with the repair work, wear the kind of insulated heat-resistant gloves designed to protect electricians.</p>

(*1) Refer to the “Definition of Qualified Installer or Qualified Service Person.”

 Installation	<p>Only a qualified installer (*1) or qualified service person (*1) is allowed to install the air conditioner. If the air conditioner is installed by an unqualified individual, a fire, electric shocks, injury, water leakage, noise and/or vibration may result.</p>
	<p>Before starting to install the air conditioner, read carefully through the Installation Manual, and follow its instructions to install the air conditioner.</p>
	<p>Do not install the air conditioner in a location that may be subject to a risk of exposure to a combustible gas. If a combustible gas leaks and becomes concentrated around the unit, a fire may occur.</p>
	<p>When transporting the air conditioner, use a forklift truck and when moving the air conditioner by hand, move the unit with 4 people.</p>
	<p>Install a circuit breaker that meets the specifications in the Installation Manual and the stipulations in the local regulations and laws.</p>
	<p>Install the circuit breaker where it can be easily accessed by the agent.</p>
 Compulsion	<p>When carrying out the pump-down work shut down the compressor before disconnecting the refrigerant pipe. Disconnecting the refrigerant pipe with the service valve left open and the compressor still operating will cause air, etc. to be sucked in, raising the pressure inside the refrigeration cycle to an abnormally high level, and possibly resulting in rupture, injury, etc.</p>
	<p>When removing the brazing parts of suction and discharge pipe for the compressor, remove them at the place ventilated well after recovering the refrigerant. Improper recovering may cause the spurt of the refrigerant and the refrigeration oil, causing an injury.</p>
 Prohibition	<p>Do not vent gases to the atmosphere. Venting gases to the atmosphere is prohibited by the law.</p>

(*1) Refer to the “Definition of Qualified Installer or Qualified Service Person.”

CAUTION

 Wearing of gloves	<p>Ensure wearing of gloves when performing any work in order to avoid injury from parts, etc. Failure to wear the proper protective gloves cause an injury due to the parts, etc.</p>
 Confirm	<p>When performing the brazing work, check whether refrigerant leaks or remains. If the leakage refrigerant gas touches a fire source, it may generate noxious gases, causing a fire.</p>

Explanations given to user

- If you have discovered that the fan grille is damaged, do not approach the outdoor unit but set the circuit breaker to the OFF position, and contact a qualified service person to have the repairs done. Do not set the circuit breaker to the ON position until the repairs are completed.

Relocation

- Only a qualified installer (*1) or qualified service person (*1) is allowed to relocate the air conditioner. It is dangerous for the air conditioner to be relocated by an unqualified individual since a fire, electric shocks, injury, water leakage, noise and/or vibration may result.
- When carrying out the pump-down work shut down the compressor before disconnecting the refrigerant pipe. Disconnecting the refrigerant pipe with the service valve left open and the compressor still operating will cause air, etc. to be sucked in, raising the pressure inside the refrigeration cycle to an abnormally high level, and possibly resulting in rupture, injury, etc.

(*1) Refer to the “Definition of Qualified Installer or Qualified Service Person.”

Declaration of Conformity

Manufacturer: TOSHIBA CARRIER CORPORATION
336 Tadehara, Fuji-shi, Shizuoka-ken 416-8521 JAPAN

TCF holder: TOSHIBA CARRIER EUROPE S.A.S
Route de Thil
01120 Montluel FRANCE

Hereby declares that the machinery described below:

Generic Denomination: Air Conditioner

Model/type: RAV-GP801AT-E, RAV-GP1101AT-E, RAV-GP1401AT-E
RAV-GP801ATJ-E, RAV-GP1101ATJ-E, RAV-GP1401ATJ-E
RAV-GP801AT-TR, RAV-GP1101AT-TR, RAV-GP1401AT-TR

Commercial name: Super Digital Inverter Series Air Conditioner

Complies with the provisions of the “Machinery Directive” (Directive 2006/42/EC) and the regulations transposing into national law

Note: This declaration becomes invalid if technical or operational modifications are introduced without the manufacturer’s consent.

Specifications

Model	Sound pressure level (dB(A))		Weight (kg)
	Cooling	Heating	
RAV-GP801AT-E	*	*	74
RAV-GP1101AT-E	*	*	104
RAV-GP1401AT-E	*	*	104
RAV-GP801ATJ-E	*	*	74
RAV-GP1101ATJ-E	*	*	104
RAV-GP1401ATJ-E	*	*	104
RAV-GP801AT-TR	*	*	74
RAV-GP1101AT-TR	*	*	104
RAV-GP1401AT-TR	*	*	104

* Under 70 dB(A)

Refrigerant R32

This air conditioner adopts a new HFC type refrigerant (R32) which does not deplete the ozone layer.

1. Safety Caution Concerned to Refrigerant R32

Be sure that water, dust, the former refrigerant or the former refrigerating oil is not mixed into the refrigerating cycle of the air conditioner with refrigerant R32 during installation work or service work. If an incorrect work or incorrect service is performed, there is a possibility to cause a serious accident. Use the tools and materials exclusive to R32 to purpose a safe work.

2. Safety and Cautions on Installation/Service

<Safety items>

When gas concentration and ignition energy are happened at the same time, R32 has a slight possibility of burning. Although it will not ignite under normal work environment conditions, be aware that the flame spreads if ignition should occur.

It is necessary to carry out installation/servicing safely while taking the following precautions into consideration.

- 1) Never use refrigerant other than specified refrigerant (R32) in an air conditioner which is designed to operate with the specified refrigerant (R32).
If other refrigerant than R32 is used, it may cause personal injury, etc. by a malfunction, a fire, a rupture.
- 2) Since R32 is heavier than air, it tends to accumulate at the bottom (near the floor).
Ventilate properly for the working environment to prevent its combustion.
Especially in a basement or a closed room where is the high risk of the accumulation, ventilate the room with a local exhaust ventilation.
If refrigerant leakage is confirmed in the room or the place where the ventilation is insufficient, do not work until the proper ventilation is performed and the work environment is improved.
- 3) When performing brazing work, be sure to check for leakage refrigerant or residual refrigerant.
If the leakage refrigerant comes into contact with fire, a poisonous gas may occur or it may cause a fire.
Keep adequate ventilation during the work.
- 4) When refrigerant gas leaks during work, execute ventilation. If the leakage refrigerant comes into contact with a fire, a poisonous gas may occur or it may cause a fire.
- 5) In places where installing / repairing air-conditioning equipment, etc., keep the source of ignition such as gas combustion equipment, petroleum combustion equipment, electric heater etc. away. Do not smoke in the place.
- 6) When installing or removing an air conditioner, do not mix air in the refrigerant cycle.
If air or others is mixed with the refrigerant, abnormal high pressure generates in the refrigerating cycle, causing injury due to the breakage.
- 7) After installation work complete, confirm that refrigerant gas is not leaking on the flare connection part or others. If leaked refrigerant comes to contact with a fire, toxic gas may occur, causing a fire.
- 8) Perform the installation work and re-installation according to the installation manual.
Pay attention especially to the area of application. Improper installation may cause refrigeration trouble, water leakage, electric shock, or fire etc.
- 9) Unauthorized modifications to the air conditioner may be dangerous. If a breakdown occurs please call a qualified air conditioner technician or electrician.
Improper repair may result in water leakage, electric shock and fire, etc.
- 10) Carry out the airtight test with nitrogen at a specified pressure. Do not use oxygen or acetylene gas absolutely as it may cause an explosion.
- 11) Always carry a refrigerant leakage detection sensor during the work and work while checking that no refrigerant leaks around working environment.
- 12) If the leakage refrigerant comes into contact with fire, it may cause a fire.
Have a dry powder or CO₂ fire extinguisher adjacent to the charging area.

<Caution items>

- 1) The opposite side dimension of the air-conditioner’s flared nut using R32 and the shape of the charge port are the same as those of R410A.
- 2) Be careful not to charge refrigerant by mistake. Should the different type of refrigerant mix in, be sure to recharge the refrigerant
- 3) Do not mix the other refrigerant or refrigerating oil with the refrigerant.
- 4) Since the pressure of R32 is 1.6 times higher than that of the former refrigerant (R22), use tools and parts with high pressure resistance specification similar to R410A.
- 5) In the installation time, use clean pipe materials and work with great attention so that water and others do not mix in because pipes are affected by impurities such as water, oxide film, oil, etc. Use the clean pipes. Be sure to braze while flowing nitrogen gas in the pipe. (Never use gas other than nitrogen gas.)
- 6) For the earth protection, use a vacuum pump for air purge.
- 7) R32 refrigerant is Single-component refrigerant that does not change its composition. Although it is possible to charge the refrigerant with either liquid or gas, charge it with liquid.

3. Pipe Materials

For the refrigerant pipes, copper pipe and joints are mainly used.
 It is necessary to select the most appropriate pipes to conform to the standard.
 Use clean pipes or joints to which little impurities adhere.

1) Copper pipe

<Piping>
 The pipe thickness, flare-finishing size, flare nut and others differ according to a refrigerant type. When using a long copper pipe for R32, it is recommended to select “Copper or copper-base pipe without seam” and one with bonded oil amount 40mg/10m or less.
 Also do not use crushed, deformed, discolored (especially inside) pipes. (Impurities cause clogging of expansion valves and capillary tubes.)

<Flare nut>
 Use the flare nuts which are attached to the air conditioner unit.

Be sure to select the pipes with copper thickness in the table below since the pressure of an air conditioner using R32 is higher than that of R22.

Nominal diameter	Outer diameter (mm)	Thickness (mm) R410A or R32
1/2	6.4	0.80
3/8	9.5	0.80
1/2	12.7	0.80
5/8	15.9	1.00

Make sure not to use a thin copper pipe such as 0.7 mm copper thickness in the market.

2) Joint

The flare joint and socket joint are used for joints of the copper pipe. The joints are rarely used for installation of the air conditioner. However clear impurities when using them.

4. Tools

○: R410A tools available

△: Partly unavailable, ×: R410A tools unavailable

No.	Installation/service tools		Use	Applicability to R32 air conditioner or not	Applicability to R22 air conditioner or not
	Tools / Equipment	specification			
1	Flare tool	Clutch type	Pipe flaring	○	○
2	Copper pipe gauge for adjusting projection margin	—	Flaring by conventional flare tool	○	—
3	Torque wrench	—	Tightening of flare nut	○	×
4	Gauge manifold	Port size 1/2"-20UNF (5/16" Flare)	Evacuating, refrigerant charge, run check, etc.	○ Note 2	×
5	Charge hose	High-voltage		○	×
6	Vacuum pump	—	Vacuum drying	○ Note 3 1/2"-20UNF(5/16" Flare)	△ Connection diameter 1/4"
7	Vacuum pump adapter	—	Vacuum drying	○ Note 4 1/2"-20UNF(5/16" Flare)	△ Connection diameter 1/4"
8	Electronic balance for refrigerant charging	For 10 kg or 20 kg cylinder	Refrigerant charge	○	○
9	Leakage detector	—	Gas leakage check	○ Note 5	○ Note 5
10	Refrigerant cylinder	—	Refrigerant charge	× Note 6	×
11	Refrigerant recovery cylinder	Exclusive for R32	Refrigerant recovery container	× Note 7	×
12	Refrigerant recovery device	—	Refrigerant recovery device	○ Note 8	△ Connection diameter 1/4"

Note 1 When flaring is carried out for R410A or R32 using the conventional flare tools, adjustment of projection margin is necessary. For this adjustment, a copper pipe gauge, etc. are necessary.

Note 2 When saturation temperature is described, the gauge manifold differs for R410A and R32. If saturation temperature reading is required, special tools exclusive for R32 are required.

Note 3 Since R32 has a slight possibility of burning, be sure to use the tools corresponding to R32.

Note 4 Like R410, a Vacuum pump adapter needs installing to prevent a Vacuum pump oil (mineral oil) from flowing backward into the Charge hose. Mixing of the Vacuum pump oil into R32 refrigerant may cause a trouble such as generation of sludge, clogging of capillary, etc.

Note 5 Be sure to use those tools after confirming they correspond to each refrigerant.

Note 6 For a refrigerant cylinder exclusive for R32, the paint color (or label color) of the cylinder is set to the specified color (light blue) together with the indication of the refrigerant name.

Note 7 Although the container specification is the same as R410A, use a recovering container exclusive for R32 to avoid mixing with other refrigerants.

Note 8 Be careful for miss charging of the refrigerant during work. Miss-charging of the refrigerant type may cause not only damage of the equipment but also a fire etc.

General tools

In addition to the above exclusive tools, the following equipments is necessary as the general tools.

- | | |
|-----------------------|---------------------------------|
| 1) Pipe cutter | 6) Spanner or Adjustable wrench |
| 2) Reamer | 7) Hole core drill |
| 3) Pipe bender | 8) Tape measure |
| 4) Level vial | 9) Metal saw |
| 5) Screwdriver (+, -) | |

Also prepare the following equipment for other installation method and run check.

- | | |
|----------------|--|
| 1) Clamp meter | 3) Insulation resistance tester (Megger) |
| 2) Thermometer | 4) Electroscop |

1. SPECIFICATIONS

1-1. Indoor Unit

1-1-1. 4-Way Smart Cassette

<Single type>

Model		Indoor unit	RAV-GM	801UT-E	1101UT-E	1401UT-E
		Outdoor unit	RAV-GP	801AT-E	1101AT-E	1401AT-E
Cooling capacity			(kW)	7.1	10.0	12.5
Heating capacity			(kW)	8.0	11.2	14.0
Power supply		1phase 220-240V/50Hz				
Indoor unit						
Electrical characteristics	Cooling	Running current (A)		6.70-6.14	9.09-8.33	13.92-12.76
		Power consumption (kW)		1.37	1.90	2.91
		Power factor (%)		93	95	95
		EER		5.18	5.26	4.30
		SEER		9.40	8.80	8.30
		Energy efficiency class (Lot10)		A++	A++	—
	Heating	Running current (A)		7.01-6.43	10.43-9.56	14.55-13.33
		Power consumption (kW)		1.45	2.18	3.04
		Power factor (%)		94	95	95
		COP		5.52	5.14	4.61
		SCOP		5.51	5.00	4.97
		Energy efficiency class (Lot10)		A++	A++	—
		Maximum current (A)		20.3	20.5	20.5
Fan unit	Fan			turbo fan	turbo fan	turbo fan
	Standard air flow (H/M+/M/L+/L) (m ³ /min)		32.0/23.2/21.5/19.0/13.5	37.5/31.0/27.5/20.0/17.5	37.5/32.0/28.5/20.5/19.5	
	Motor (W)		130	130	130	
Sound pressure level		(H/M+/M/L+/L)	(dB-A)	42/37/35/32/27	48/43/40/37/31	48/44/41/38/33
Sound power level		(H/M+/M/L+/L)	(dB-A)	56/50/49/46/43	61/55/54/52/46	61/56/55/53/48
Outdoor unit						
Outer dimension	Max total length (m)		50	75	75	
	Min length (m)		3	3	3	
	Height difference	Outdoor lower (m)	30	30	30	
		Outdoor high (m)	30	30	30	
Fan unit	Fan			Propeller fan	Propeller fan	Propeller fan
	Standard air flow high (m ³ /min)		53	116	116	
	Motor (W)		60	100+100	100+100	
Connecting pipe	Outdoor unit - Pipe branch	Gas side (mm)	15.9	15.9	15.9	
		Liquid side (mm)	9.5	9.5	9.5	
	Pipe branch-indoor unit	Gas side (mm)	15.9	15.9	15.9	
		Liquid side (mm)	9.5	9.5	9.5	
Sound pressure level		Cooling/Heating	(dB-A)	46/48	49/50	50/51
Sound power level		Cooling/Heating	(dB-A)	63/65	66/67	67/68

1-1-2. 4-Way Smart Cassette

<Twin type>

Model		Indoor unit1	RAV-GM	561UT-E	801UT-E
		Outdoor unit	RAV-GM	561UT-E	801UT-E
		Indoor unit2	RAV-GP	1101AT-E	1401AT-E
Cooling capacity			(kW)	10.0	12.5
Heating capacity			(kW)	11.2	14.0
Power supply			1phase 220-240V/50Hz		
Indoor unit					
Electrical characteristics	Cooling	Running current	(A)	9.09-8.33	13.92-12.76
		Power consumption	(kW)	1.90	2.91
		Power factor	(%)	95	95
		EER		5.26	4.30
		SEER		8.64	8.19
		Energy efficiency class (Lot10)		A++	—
	Heating	Running current	(A)	10.43-9.56	14.55-13.33
		Power consumption	(kW)	2.18	3.04
		Power factor	(%)	95	95
		COP		5.14	4.61
		SCOP		5.00	4.97
		Energy efficiency class (Lot10)		A++	—
		Maximum current	(A)	20.5	20.5
Fan unit	Fan		turbo fan		turbo fan
	Standard air flow (H/M+/M/L+/L)		(m ³ /min)	17.5/16.5/15.0/13.5/12.5	32.0/23.2/21.5/19.0/13.5
	Motor		(W)	60	130
Sound pressure level		(H/M+/M/L+/L)	(dB-A)	32/31/29/28/26	42/37/35/32/27
Sound power level		(H/M+/M/L+/L)	(dB-A)	48/47/45/44/43	56/50/49/46/43
Outdoor unit					
Outer dimension	Max total length		(m)	75	75
	Min length		(m)	3	3
	Height difference	Outdoor lower	(m)	30	30
		Outdoor high	(m)	30	30
Fan unit	Fan		Propeller fan		Propeller fan
	Standard air flow high		(m ³ /min)	116	116
	Motor		(W)	100+100	100+100
Connecting pipe	Outdoor unit - Pipe branch	Gas side	(mm)	15.9	15.9
		Liquid side	(mm)	9.5	9.5
	Pipe branch-indoor unit	Gas side	(mm)	12.7	15.9
		Liquid side	(mm)	6.4	9.5
Sound pressure level		Cooling/Heating	(dB-A)	49/50	50/51
Sound power level		Cooling/Heating	(dB-A)	66/67	67/68

1-1-3. 4-Way Cassette

<Single type>

Model		Indoor unit	RAV-RM	801UTP-E	1101UTP-E	1401UTP-E	
		Outdoor unit	RAV-GP	801AT-E	1101AT-E	1401AT-E	
Cooling capacity			(kW)	7.1	10.0	12.5	
Heating capacity			(kW)	8.0	11.2	14.0	
Power supply		1phase 220-240V/50Hz					
Indoor unit							
Electrical characteristics	Cooling	Running current (A)		7.72-7.08	10.19-9.34	15.12-13.86	
		Power consumption (kW)		1.58	2.13	3.16	
		Power factor (%)		93	95	95	
		EER		4.49	4.69	3.96	
		SEER		8.80	8.65	8.15	
		Energy efficiency class (Lot10)		A++	A++	—	
	Heating	Running current (A)		8.56-7.85	11.20-10.26	15.36-14.08	
		Power consumption (kW)		1.77	2.34	3.21	
		Power factor (%)		94	95	95	
		COP		4.52	4.79	4.36	
		SCOP		5.22	4.73	4.72	
		Energy efficiency class (Lot10)		A++	A++	—	
		Maximum current (A)		20.3	20.5	20.5	
Fan unit	Fan			turbo fan	turbo fan	turbo fan	
	Standard air flow (H/M+/M/L+/L) (m ³ /min)			20.5/-/16.0/-/13.5	33.5/-/24.0/-/19.5	35.0/24.0/20.5	
	Motor (W)			20	68	68	
Sound pressure level		(H/M+/M/L+/L) (dB-A)		35/-/31/-/28	43/-/38/-/33	44/-/38/-/34	
Sound power level		(H/M+/M/L+/L) (dB-A)		50/-/46/-/43	58/-/53/-/48	59/-/53/-/49	
Outdoor unit							
Outer dimension	Max total length (m)			50	75	75	
	Min length (m)			3	3	3	
	Height difference	Outdoor lower (m)			30	30	30
		Outdoor high (m)			30	30	30
Fan unit	Fan			Propeller fan	Propeller fan	Propeller fan	
	Standard air flow high (m ³ /min)			53	116	116	
	Motor (W)			60	100+100	100+100	
Connecting pipe	Outdoor unit - Pipe branch	Gas side (mm)		15.9	15.9	15.9	
		Liquid side (mm)		9.5	9.5	9.5	
	Pipe branch-indoor unit	Gas side (mm)		15.9	15.9	15.9	
		Liquid side (mm)		9.5	9.5	9.5	
Sound pressure level		Cooling/Heating (dB-A)		46/48	49/50	50/51	
Sound power level		Cooling/Heating (dB-A)		63/65	66/67	67/68	

1-1-4. 4-Way Cassette

<Twin type>

Model		Indoor unit1	RAV-RM	561UTP-E	801UTP-E
		Outdoor unit	RAV-RM	561UTP-E	801UTP-E
		Indoor unit2	RAV-GP	1101AT-E	1401AT-E
Cooling capacity			(kW)	10.0	12.5
Heating capacity			(kW)	11.2	14.0
Power supply			1phase 220-240V/50Hz		
Indoor unit					
Electrical characteristics	Cooling	Running current	(A)	10.19-9.34	15.12-13.86
		Power consumption	(kW)	2.13	3.16
		Power factor	(%)	95	95
		EER		4.69	3.96
		SEER		8.57	8.14
		Energy efficiency class (Lot10)		A++	—
	Heating	Running current	(A)	11.20-10.26	15.36-14.08
		Power consumption	(kW)	2.34	3.21
		Power factor	(%)	95	95
		COP		4.79	4.36
		SCOP		4.73	4.72
Energy efficiency class (Lot10)			A++	—	
		Maximum current	(A)	20.5	20.7
Fan unit	Fan			turbo fan	turbo fan
	Standard air flow (H/M+/M/L+/L)		(m ³ /min)	17.5/-/14.5/-/13.0	20.5/-/16.0/-/13.5
	Motor		(W)	14	20
Sound pressure level		(H/M+/M/L+/L)	(dB-A)	32/-/29/-/28	35/-/31/-/28
Sound power level		(H/M+/M/L+/L)	(dB-A)	47/-/44/-/43	50/-/46/-/43
Outdoor unit					
Outer dimension	Max total length		(m)	75	75
	Min length		(m)	3	3
	Height difference	Outdoor lower	(m)	30	30
		Outdoor high	(m)	30	30
Fan unit	Fan			Propeller fan	Propeller fan
	Standard air flow high		(m ³ /min)	116	116
	Motor		(W)	100+100	100+100
Connecting pipe	Outdoor unit - Pipe branch	Gas side	(mm)	15.9	15.9
		Liquid side	(mm)	9.5	9.5
	Pipe branch-indoor unit	Gas side	(mm)	12.7	15.9
		Liquid side	(mm)	6.4	9.5
Sound pressure level		Cooling/Heating	(dB-A)	49/50	50/51
Sound power level		Cooling/Heating	(dB-A)	66/67	67/68

1-1-5. Compact 4-Way Cassette

<Twin type>

Model		Indoor unit1	RAV-RM	401MUT-E	561MUT-E
		Outdoor unit	RAV-RM	401MUT-E	561MUT-E
		Indoor unit2	RAV-GP	801AT-E	1101AT-E
Cooling capacity			(kW)	7.1	10.0
Heating capacity			(kW)	8.0	11.2
Power supply				1phase 220-240V/50Hz	1phase 220-240V/50Hz
Indoor unit					
Electrical characteristics	Cooling	Running current	(A)	8.46-7.75	11.44-10.48
		Power consumption	(kW)	1.73	2.39
		Power factor	(%)	93	95
		EER		4.10	4.18
		SEER		7.80	7.70
		Energy efficiency class (Lot10)		A++	A++
	Heating	Running current	(A)	8.80-8.07	12.78-11.71
		Power consumption	(kW)	1.82	2.67
		Power factor	(%)	94	95
		COP		4.40	4.19
		SCOP		4.88	4.40
		Energy efficiency class (Lot10)		A++	A+
		Maximum current	(A)	20.8	21.1
Fan unit	Fan			turbo fan	turbo fan
	Standard air flow (H/M+/M/L+/L)		(m ³ /min)	11.0/10.2/9.2/8.0/7.8	13.3/12.0/11.2/9.4/9.1
	Motor		(W)	60	72
Sound pressure level		(H/M+/M/L+/L)	(dB-A)	41/38/36/33/32	44/42/39/36/35
Sound power level		(H/M+/M/L+/L)	(dB-A)	56/53/51/48/47	59/57/54/51/50
Outdoor unit					
Outer dimension	Max total length		(m)	50	75
	Min length		(m)	3	3
	Height difference	Outdoor lower	(m)	30	30
		Outdoor high	(m)	30	30
Fan unit	Fan			Propeller fan	Propeller fan
	Standard air flow high		(m ³ /min)	53	116
	Motor		(W)	60	100+100
Connecting pipe	Outdoor unit - Pipe branch	Gas side	(mm)	15.9	15.9
		Liquid side	(mm)	9.5	9.5
	Pipe branch-indoor unit	Gas side	(mm)	15.9	12.7
		Liquid side	(mm)	9.5	6.4
Sound pressure level		Cooling/Heating	(dB-A)	46/48	49/50
Sound power level		Cooling/Heating	(dB-A)	63/65	66/67

1-1-6. Slim Duct

<Twin type>

Model		Indoor unit1	RAV-RM	401SDT-E	561SDT-E
		Outdoor unit	RAV-RM	401SDT-E	561SDT-E
		Indoor unit2	RAV-GP	801AT-E	1101AT-E
Cooling capacity			(kW)	7.1	10.0
Heating capacity			(kW)	8.0	11.2
Power supply				1phase 220-240V/50Hz	1phase 220-240V/50Hz
Indoor unit					
Electrical characteristics	Cooling	Running current	(A)	9.14-8.38	12.25-11.23
		Power consumption	(kW)	1.87	2.56
		Power factor	(%)	93	95
		EER		3.80	3.91
		SEER		6.50	6.65
		Energy efficiency class (Lot10)		A++	A++
	Heating	Running current	(A)	8.80-8.07	12.78-11.71
		Power consumption	(kW)	1.82	2.67
		Power factor	(%)	94	95
		COP		4.40	4.19
		SCOP		4.51	4.00
		Energy efficiency class (Lot10)		A+	A+
		Maximum current	(A)	20.8	20.6
Fan unit	Fan			Centrifugal fan	Centrifugal fan
	Standard air flow (H/M+/M/L+/L)		(m ³ /min)	11.5/10.0/8.7	13.0/11.3/9.7
	Motor		(W)	60	60
Sound pressure level		(H/M+/M/L+/L)	(dB-A)	39/36/33	45/40/36
Sound power level		(H/M+/M/L+/L)	(dB-A)	48/44/30	55/53/48
Outdoor unit					
Outer dimension	Max total length		(m)	50	50
	Min length		(m)	3	3
	Height difference	Outdoor lower	(m)	30	30
		Outdoor high	(m)	30	30
Fan unit	Fan			Propeller fan	Propeller fan
	Standard air flow high		(m ³ /min)	53	53
	Motor		(W)	60	60
Connecting pipe	Outdoor unit - Pipe branch	Gas side	(mm)	15.9	15.9
		Liquid side	(mm)	9.5	9.5
	Pipe branch-indoor unit	Gas side	(mm)	15.9	12.7
		Liquid side	(mm)	9.5	6.4
Sound pressure level		Cooling/Heating	(dB-A)	46/48	46/48
Sound power level		Cooling/Heating	(dB-A)	63/65	63/65

1-1-7. Duct

<Single type>

Model		Indoor unit	RAV-RM	801BTP-E	1101BTP-E	1401BTP-E	
		Outdoor unit	RAV-GP	801AT-E	1101AT-E	1401AT-E	
Cooling capacity			(kW)	7.1	10.0	12.5	
Heating capacity			(kW)	8.0	11.2	14.0	
Power supply		1phase 220-240V/50Hz					
Indoor unit							
Electrical characteristics	Cooling	Running current (A)		7.97-7.30	11.48-10.53	17.08-15.66	
		Power consumption (kW)		1.63	2.40	3.57	
		Power factor (%)		93	95	95	
		EER		4.36	4.17	3.50	
		SEER		7.50	6.60	6.06	
		Energy efficiency class (Lot10)		A++	A++	—	
	Heating	Running current (A)		8.95-8.20	13.06-11.97	17.37-15.92	
		Power consumption (kW)		1.85	2.73	3.63	
		Power factor (%)		94	95	95	
		COP		4.32	4.10	3.86	
		SCOP		4.81	4.24	4.24	
		Energy efficiency class (Lot10)		A++	A+	—	
		Maximum current (A)		20.7	22.8	22.8	
Fan unit	Fan			Centrifugal fan	Centrifugal fan	Centrifugal fan	
	Standard air flow (H/M+/M/L+/L) (m ³ /min)			20.0/-/16.5/-/14.5	35.0/-/29.0/-/25.0	35.0/-/29.0/-/25.0	
	Motor (W)			150	250	250	
Sound pressure level		(H/M+/M/L+/L) (dB-A)		34/-/30/-/26	40/-/36/-/33	40/-/36/-/33	
Sound power level		(H/M+/M/L+/L) (dB-A)		55/-/51/-/46	55/-/51/-/48	63/-/58/-/54	
Outdoor unit							
Outer dimension	Max total length (m)			50	75	75	
	Min length (m)			3	3	3	
	Height difference	Outdoor lower (m)			30	30	30
		Outdoor high (m)			30	30	30
Fan unit	Fan			Propeller fan	Propeller fan	Propeller fan	
	Standard air flow high (m ³ /min)			53	116	116	
	Motor (W)			60	100+100	100+100	
Connecting pipe	Outdoor unit - Pipe branch	Gas side (mm)		15.9	15.9	15.9	
		Liquid side (mm)		9.5	9.5	9.5	
	Pipe branch-indoor unit	Gas side (mm)		15.9	15.9	15.9	
		Liquid side (mm)		9.5	9.5	9.5	
Sound pressure level		Cooling/Heating (dB-A)		46/48	49/50	50/51	
Sound power level		Cooling/Heating (dB-A)		63/65	66/67	67/68	

1-1-8. Duct

<Twin type>

Model		Indoor unit1	RAV-RM	561BTP-E	801BTP-E
		Outdoor unit	RAV-RM	561BTP-E	801BTP-E
		Indoor unit2	RAV-GP	1101AT-E	1401AT-E
Cooling capacity			(kW)	10.0	12.5
Heating capacity			(kW)	11.2	14.0
Power supply			1phase 220-240V/50Hz		
Indoor unit					
Electrical characteristics	Cooling	Running current	(A)	11.48-10.53	17.08-15.66
		Power consumption	(kW)	2.40	3.57
		Power factor	(%)	95	95
		EER		4.17	3.50
		SEER		6.74	6.27
		Energy efficiency class (Lot10)		A++	A++
	Heating	Running current	(A)	13.06-11.97	17.37-15.92
		Power consumption	(kW)	2.73	3.63
		Power factor	(%)	95	95
		COP		4.10	3.86
		SCOP		4.26	4.25
		Energy efficiency class (Lot10)		A++	A+
		Maximum current	(A)	22.8	22.8
Fan unit	Fan			Centrifugal fan	Centrifugal fan
	Standard air flow (H/M+/M/L+/L)		(m ³ /min)	13.3/-/11.0/-/9.0	20.0/-/16.5/-/14.5
	Motor		(W)	150	150
Sound pressure level		(H/M+/M/L+/L)	(dB-A)	33/-/29/-/25	34/-/30/-/26
Sound power level		(H/M+/M/L+/L)	(dB-A)	55/-/51/-/46	55/-/51/-/46
Outdoor unit					
Outer dimension	Max total length		(m)	75	75
	Min length		(m)	3	3
	Height difference	Outdoor lower	(m)	30	30
		Outdoor high	(m)	30	30
Fan unit	Fan			Propeller fan	Propeller fan
	Standard air flow high		(m ³ /min)	116	116
	Motor		(W)	100+100	100+100
Connecting pipe	Outdoor unit - Pipe branch	Gas side	(mm)	15.9	15.9
		Liquid side	(mm)	9.5	9.5
	Pipe branch-indoor unit	Gas side	(mm)	12.7	15.9
		Liquid side	(mm)	6.4	9.5
Sound pressure level		Cooling/Heating	(dB-A)	49/50	50/51
Sound power level		Cooling/Heating	(dB-A)	66/67	67/68

1-1-9. Ceiling
<Single type>

Model		Indoor unit	RAV-RM	801CTP-E	1101CTP-E	1401CTP-E	
		Outdoor unit	RAV-GP	801AT-E	1101AT-E	1401AT-E	
Cooling capacity			(kW)	7.1	10.0	12.5	
Heating capacity			(kW)	8.0	11.2	14.0	
Power supply		1phase 220-240V/50Hz					
Indoor unit							
Electrical characteristics	Cooling	Running current (A)		7.82-7.17	10.67-9.78	17.13-15.70	
		Power consumption (kW)		1.60	2.23	3.58	
		Power factor (%)		93	95	95	
		EER		4.44	4.48	3.49	
		SEER		7.95	8.23	7.58	
		Energy efficiency class (Lot10)		A++	A++	—	
	Heating	Running current (A)		8.70-7.98	11.39-10.44	17.18-15.75	
		Power consumption (kW)		1.80	2.38	3.59	
		Power factor (%)		94	95	95	
		COP		4.44	4.71	3.90	
		SCOP		5.05	4.72	4.71	
		Energy efficiency class (Lot10)		A++	A++	—	
		Maximum current (A)		20.6	21.0	21.6	
Fan unit	Fan			Centrifugal fan	Centrifugal fan	Centrifugal fan	
	Standard air flow (H/M+/M/L+/L) (m ³ /min)			23.5/-/16.7/-/12.5	31.0/22.5/17.0	34.0/-/22.5/-/20.0	
	Motor (W)			94	94	139	
Sound pressure level		(H/M+/M/L+/L) (dB-A)		41/-/36/-/29	44/-/38/-/32	46/-/41/-/35	
Sound power level		(H/M+/M/L+/L) (dB-A)		56/-/51/-/44	59/-/53/-/47	61/-/56/-/50	
Outdoor unit							
Outer dimension	Max total length (m)			50	75	75	
	Min length (m)			3	3	3	
	Height difference	Outdoor lower (m)			30	30	30
		Outdoor high (m)			30	30	30
Fan unit	Fan			Propeller fan	Propeller fan	Propeller fan	
	Standard air flow high (m ³ /min)			53	116	116	
	Motor (W)			60	100+100	100+100	
Connecting pipe	Outdoor unit - Pipe branch	Gas side (mm)		15.9	15.9	15.9	
		Liquid side (mm)		9.5	9.5	9.5	
	Pipe branch-indoor unit	Gas side (mm)		15.9	15.9	15.9	
		Liquid side (mm)		9.5	9.5	9.5	
Sound pressure level		Cooling/Heating (dB-A)		46/48	49/50	50/51	
Sound power level		Cooling/Heating (dB-A)		63/65	66/67	67/68	

1-1-10. Ceiling

<Twin type>

Model	Indoor unit1		RAV-RM	401CTP-E	561CTP-E	801CTP-E	
	Indoor unit2		RAV-RM	401CTP-E	561CTP-E	801CTP-E	
	Outdoor unit		RAV-GP	801AT-E	1101AT-E	1401AT-E	
Cooling capacity			(kW)	7.1	10.0	12.5	
Heating capacity			(kW)	8.0	11.2	14.0	
Power supply			1phase 220-240V/50Hz				
Indoor unit							
Electrical characteristics	Cooling	Running current		(A)	7.82-7.17	10.67-9.78	17.13-15.70
		Power consumption		(kW)	1.60	2.23	3.58
		Power factor		(%)	93	95	95
		EER			4.44	4.48	3.49
		SEER			7.82	7.97	7.34
		Energy efficiency class (Lot10)			A++	A++	—
	Heating	Running current		(A)	8.70-7.98	11.39-10.44	17.18-15.75
		Power consumption		(kW)	1.80	2.38	3.59
		Power factor		(%)	94	95	95
		COP			4.44	4.71	3.90
		SCOP			5.05	4.71	4.70
		Energy efficiency class (Lot10)			A++	A++	—
Maximum current		(A)	20.6	21.1	22.3		
Fan unit	Fan			Centrifugal fan	Centrifugal fan	Centrifugal fan	
	Standard air flow (H/M+/M/L+/L)			(m ³ /min)	16.5/-/12.0/-/9.0	15.0/-/12.0/-/9.0	23.5/-/16.7/-/12.5
	Motor			(W)	94	94	94
Sound pressure level		(H/M+/M/L+/L)	(dB-A)	37/-/35/-/28	37/-/35/-/28	41/-/36/-/29	
Sound power level		(H/M+/M/L+/L)	(dB-A)	52/-/50/-/43	52/-/50/-/43	56/-/51/-/44	
Outdoor unit							
Outer dimension	Max total length		(m)	50	75	75	
	Min length		(m)	3	3	3	
	Height difference	Outdoor lower		(m)	30	30	30
		Outdoor high		(m)	30	30	30
Fan unit	Fan			Propeller fan	Propeller fan	Propeller fan	
	Standard air flow high			(m ³ /min)	53	116	116
	Motor			(W)	60	100+100	100+100
Connecting pipe	Outdoor unit - Pipe branch	Gas side		(mm)	15.9	15.9	15.9
		Liquid side		(mm)	9.5	9.5	9.5
	Pipe branch-indoor unit	Gas side		(mm)	12.7	12.7	15.9
		Liquid side		(mm)	6.4	6.4	9.5
Sound pressure level		Cooling/Heating	(dB-A)	46/48	49/50	50/51	
Sound power level		Cooling/Heating	(dB-A)	63/65	66/67	67/68	

1-2. Outdoor Unit

Model	Outdoor unit	RAV-GP	801AT-E	1101AT-E	1401AT-E	
Power supply			1 phase 220-240 50Hz (Power exclusive to outdoor is required)			
Compressor	Type		Hermetic compressor			
	Motor	(kW)	2.00	3.75	3.75	
	Pole		6	4	4	
Refrigerant charged			(kg)	1.9	3.1	3.1
Refrigerant control			Pulse motor valve			
Pipe	Max		(m)	50	75	75
	Min		(m)	3	3	3
	Height difference	Outdoor lower	(m)	30	30	30
		Outdoor high	(m)	30	30	30
Outer dimension	Height			1050	1550	1550
	Width			1010	1010	1010
	Depth			370	370	370
Appearance			Silky shade (Munsell 1Y8.5/0.5)			
Total weight			(kg)	74	104	104
Heat exchanger			Finned tube			
Fan unit	Fan		Propeller fan			
	Standard air flow		(m ³ /min)	116	116	116
	Motor		(W)	100+100	100+100	100+100
Connecting pipe (Outdoor unit side)	Gas side		(mm)	15.9	15.9	15.9
	Liquid side		(mm)	9.5	9.5	9.5
Sound pressure level	Cooling/Heating		(dB-A)	49/50	49/50	50/51
Sound power level	Cooling/Heating		(dB-A)	66/67	66/67	67/68
Outside air temperature, cooling			(°C)	52 to -15°C		
Outside air temperature, heating			(°C)	15 to -27°C		

1-3. Operation Characteristic Curve

• Operation characteristic curve

GP801

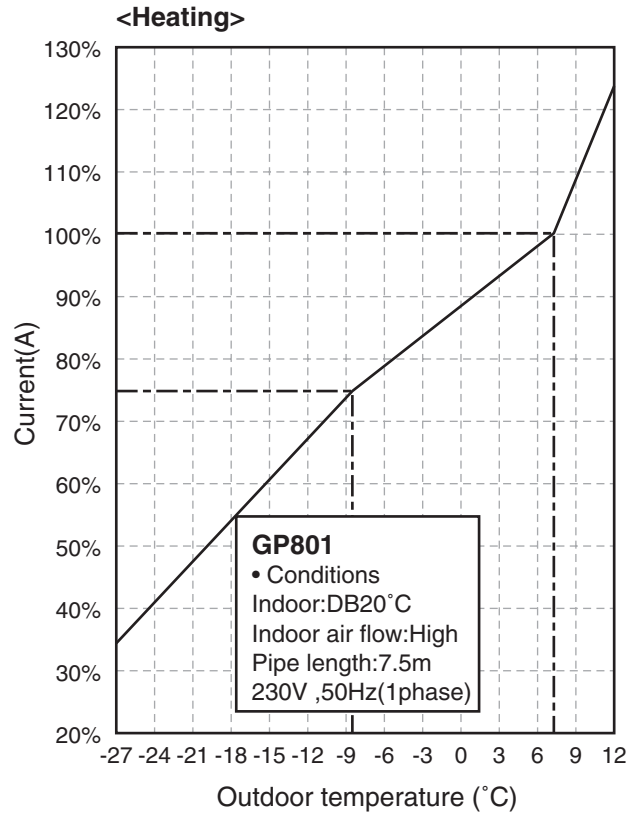
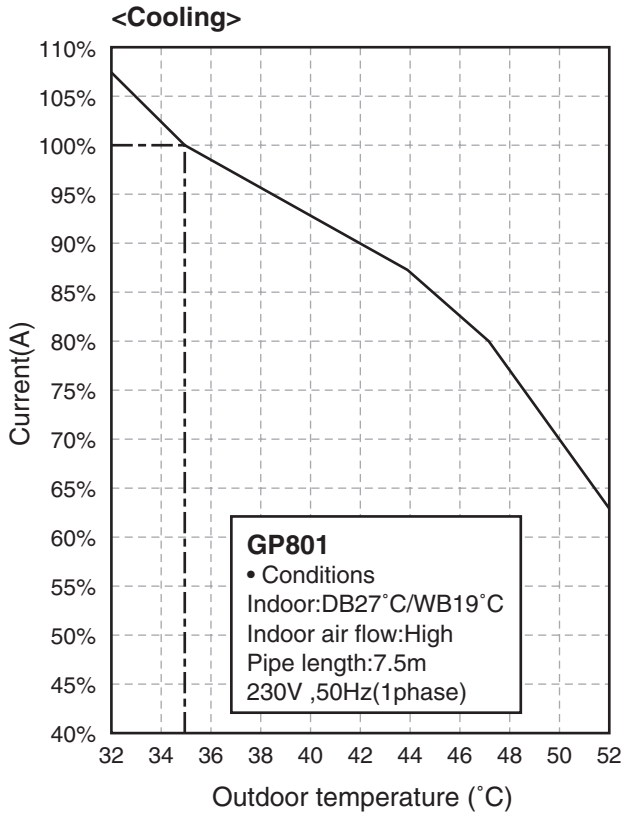

GP1101/1401

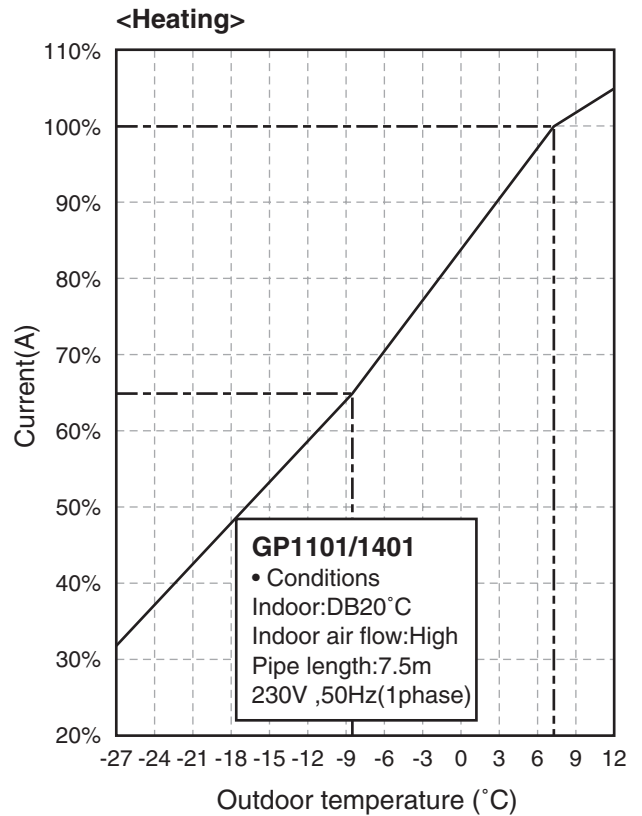
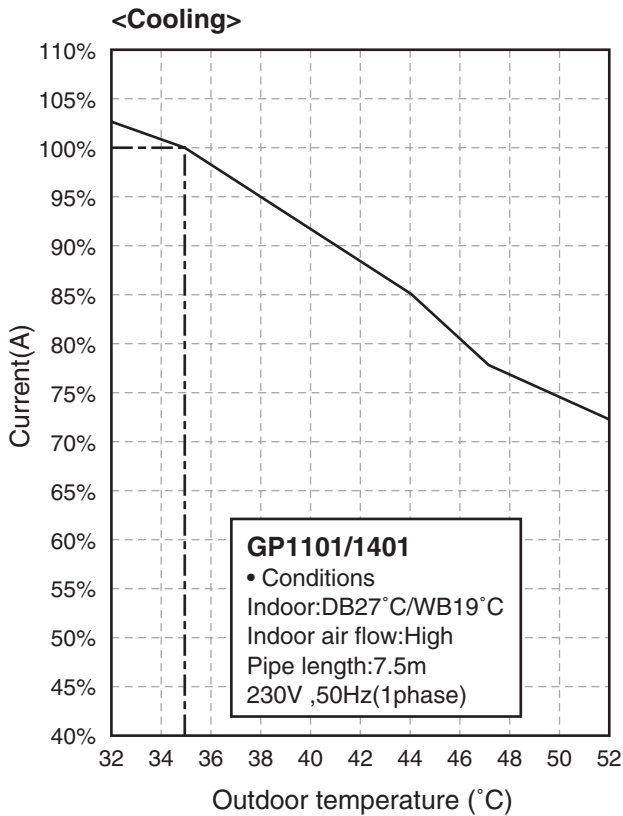

• Capacity variation ratio according to temperature

GP801

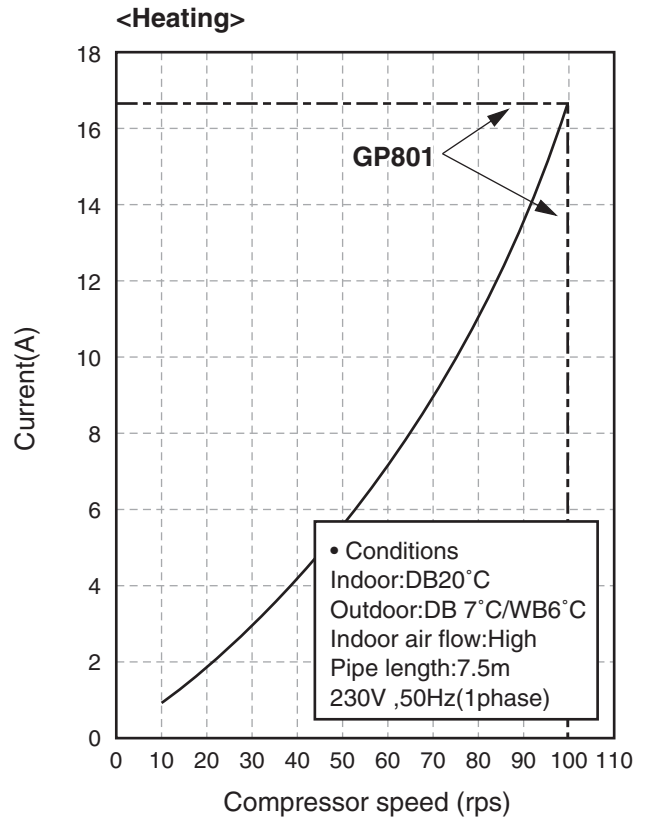
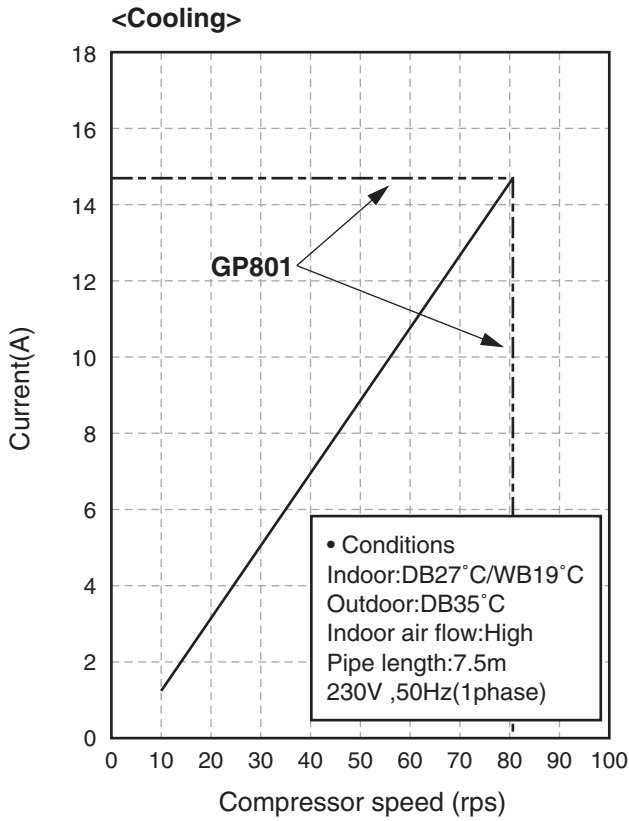

GP1101/1401

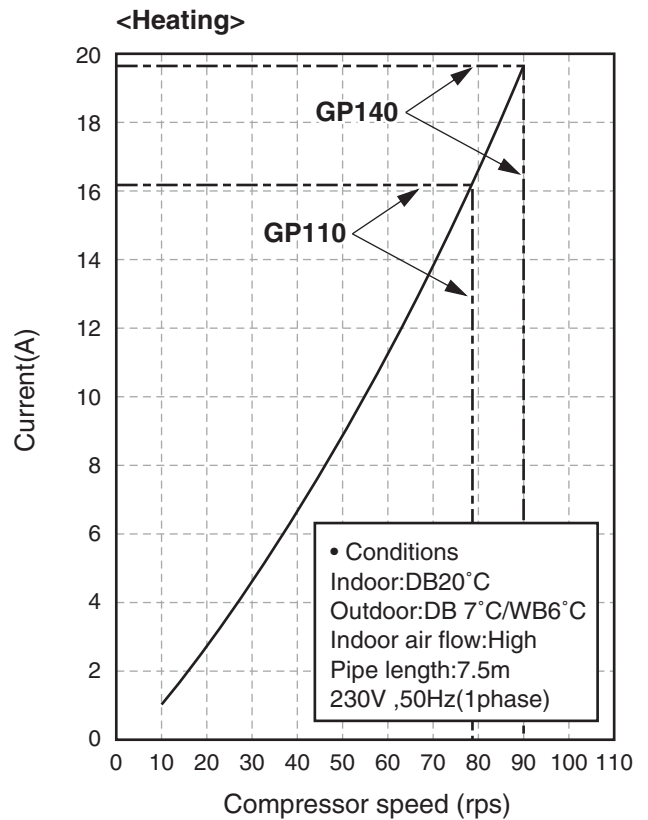
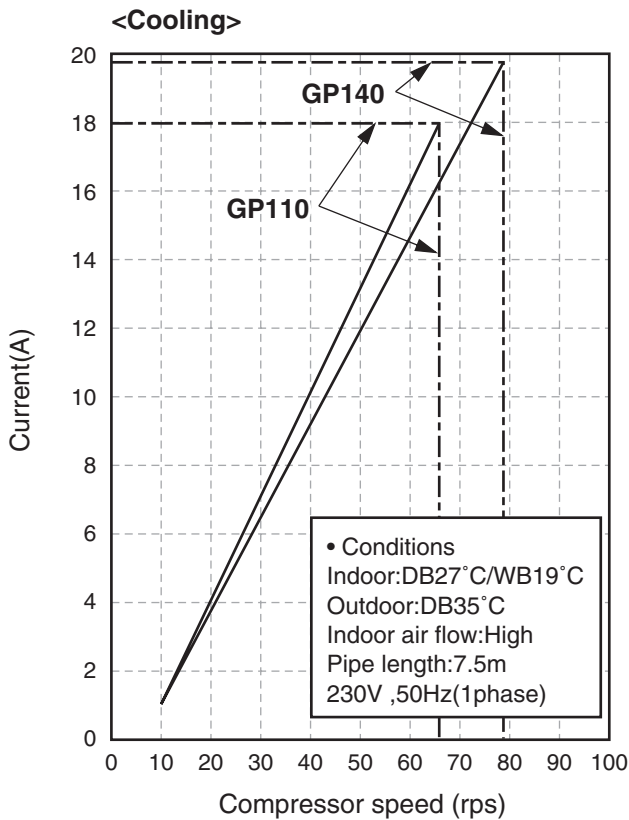

2. CONSTRUCTION VIEWS (EXTERNAL VIEWS)

2-1. RAV-GP801AT*

Name	Note
① Refrigerant piping hole Indoor/Outdoor Unit connecting wire inlet hole	—
② Power supply inlet hole	DIA 38 Knockout hole

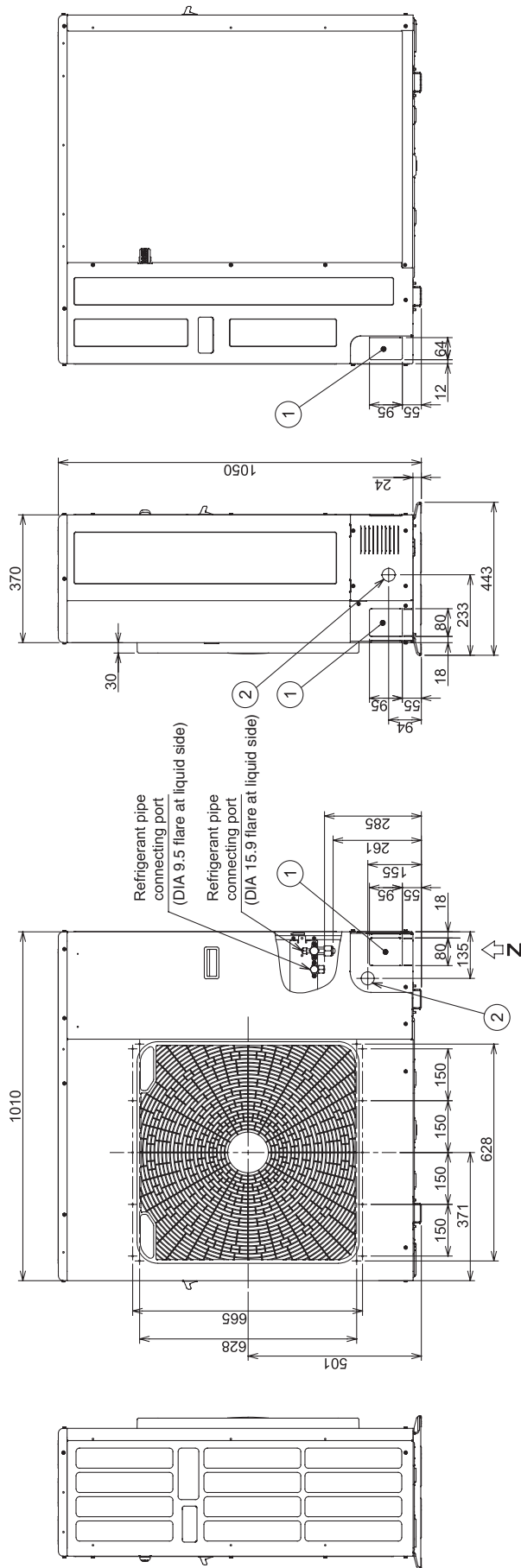
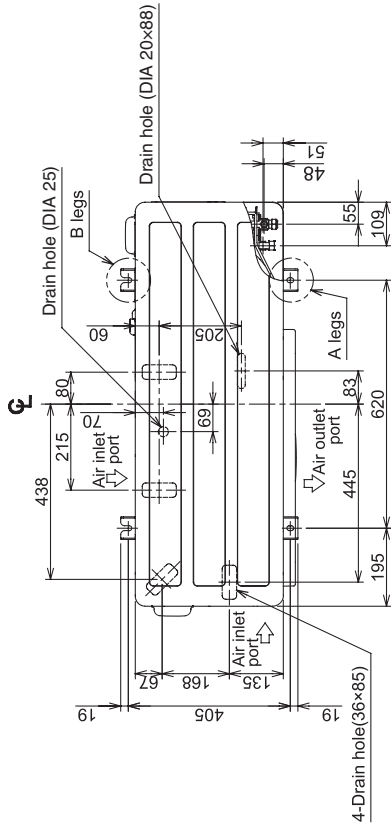
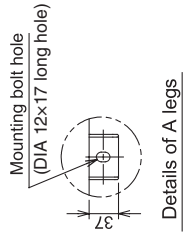
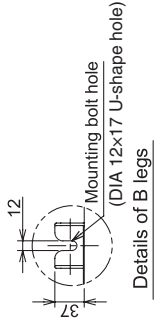

(Unit:mm)

2-2. RAV-GP1101AT*, GP1401AT*

	Name	Note
①	Refrigerant piping hole Indoor/Outdoor Unit connecting wire inlet hole	—
②	Power supply inlet hole	DIA 38 Knockout hole

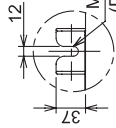

Mounting bolt hole
(DIA 12x17 U-shape hole)

Details of B legs

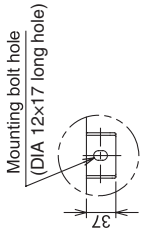

Mounting bolt hole
(DIA 12x17 long hole)

Details of A legs

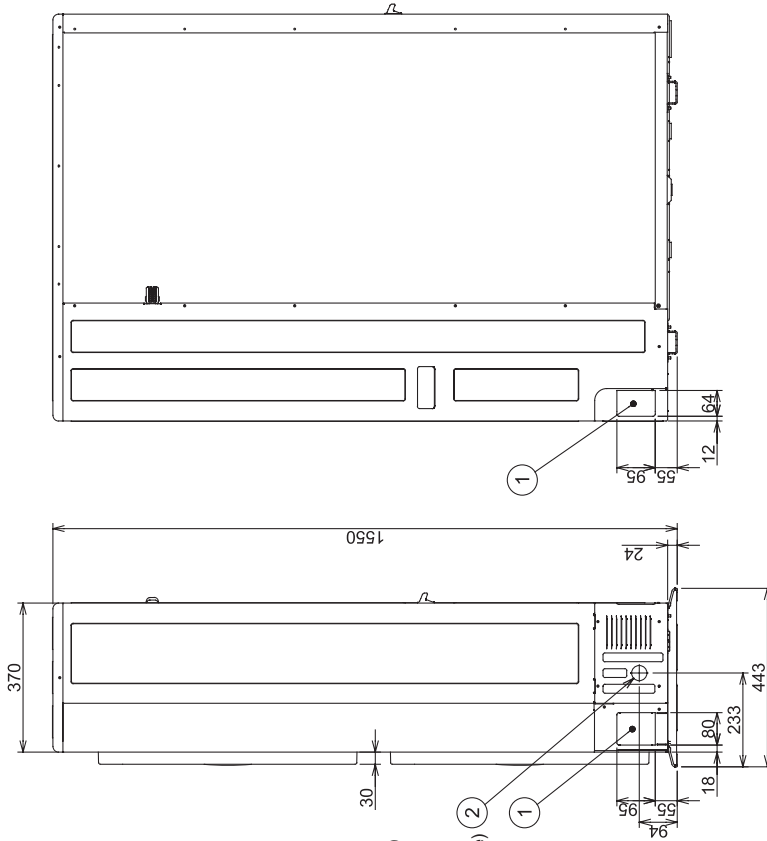

(Unit:mm)

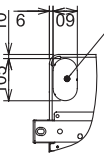
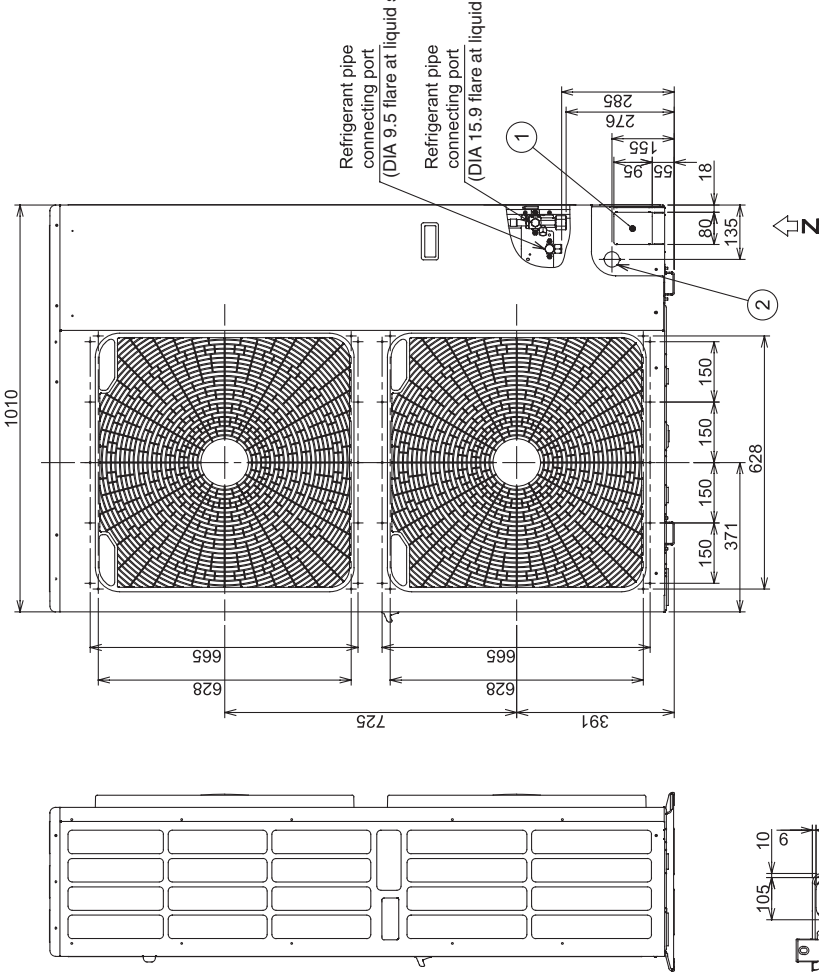
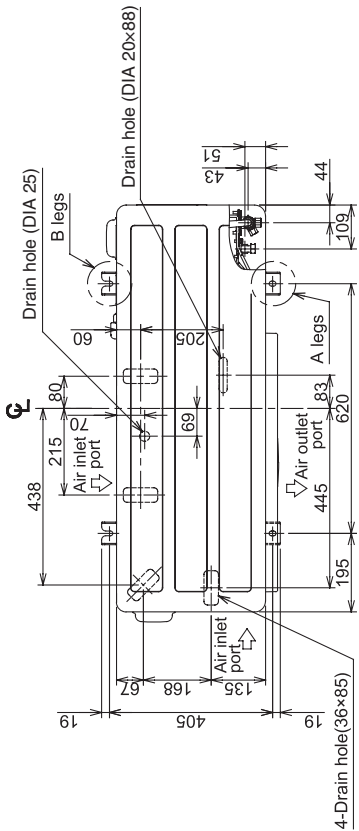

Knockout for downward piping

Z views

2-3. Branch pipe
RBC-DTWP101E (Simultaneous Twin)

<Joint pipe>

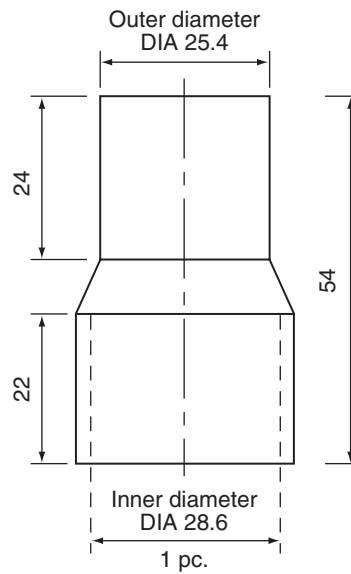
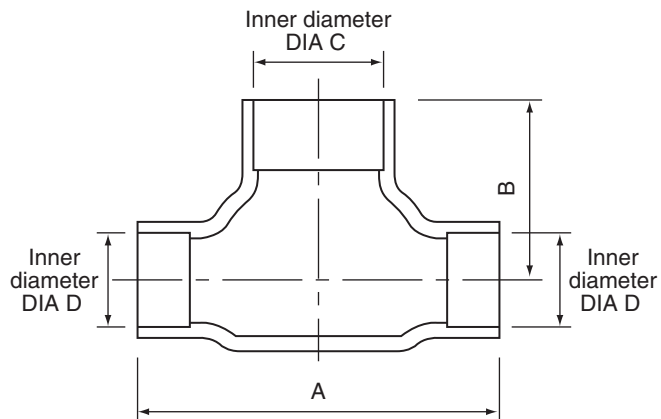

(Unit: mm)

Model		A	B	C	D	Q'ty
RBC-TWP101E	Gas side	74	37	25.4	15.9	1
	Liquid side	35	18	12.7	9.5	1

3. OUTDOOR UNIT REFRIGERANTING CYCLE DIAGRAM

GP801

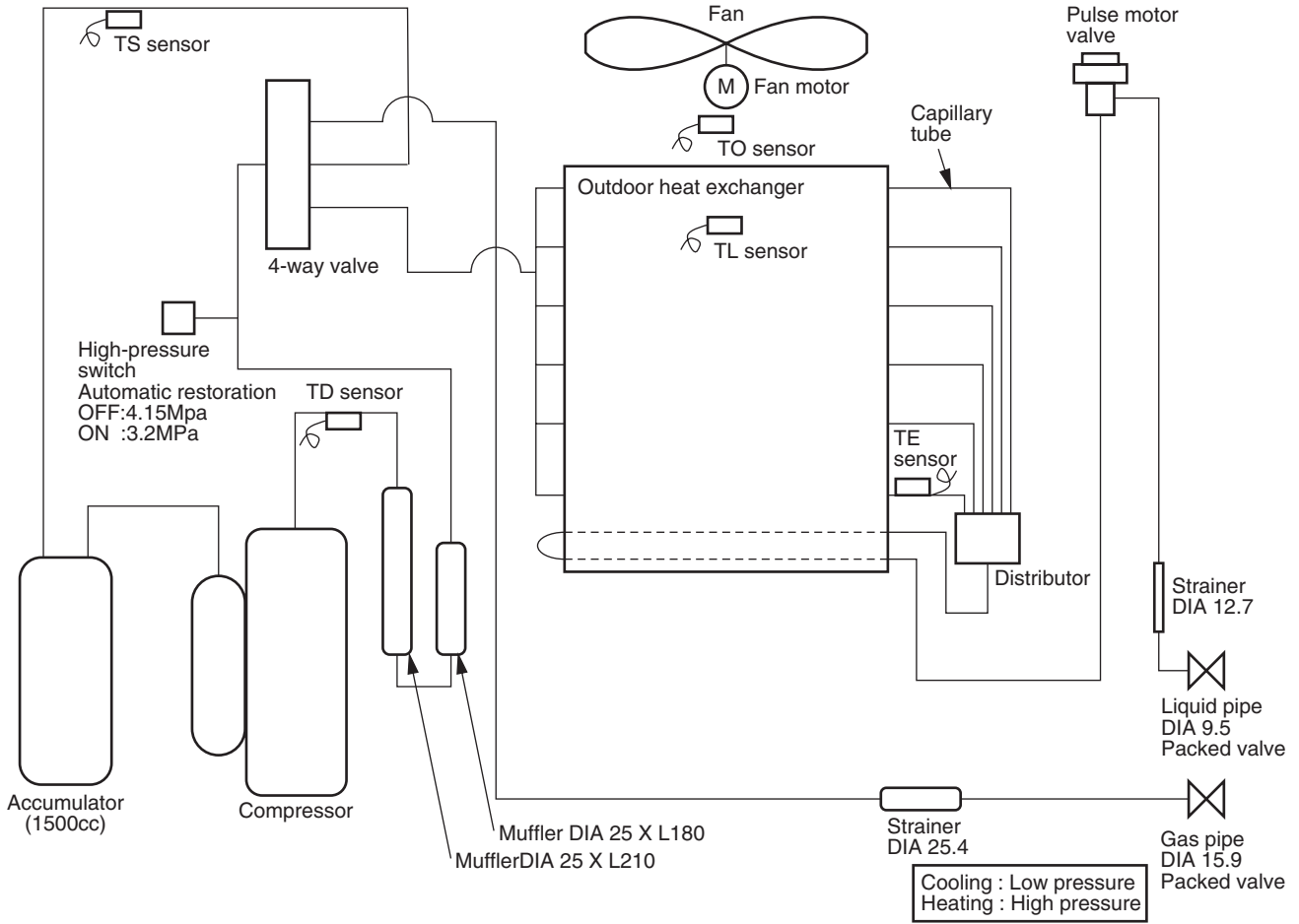

GP1101/1401

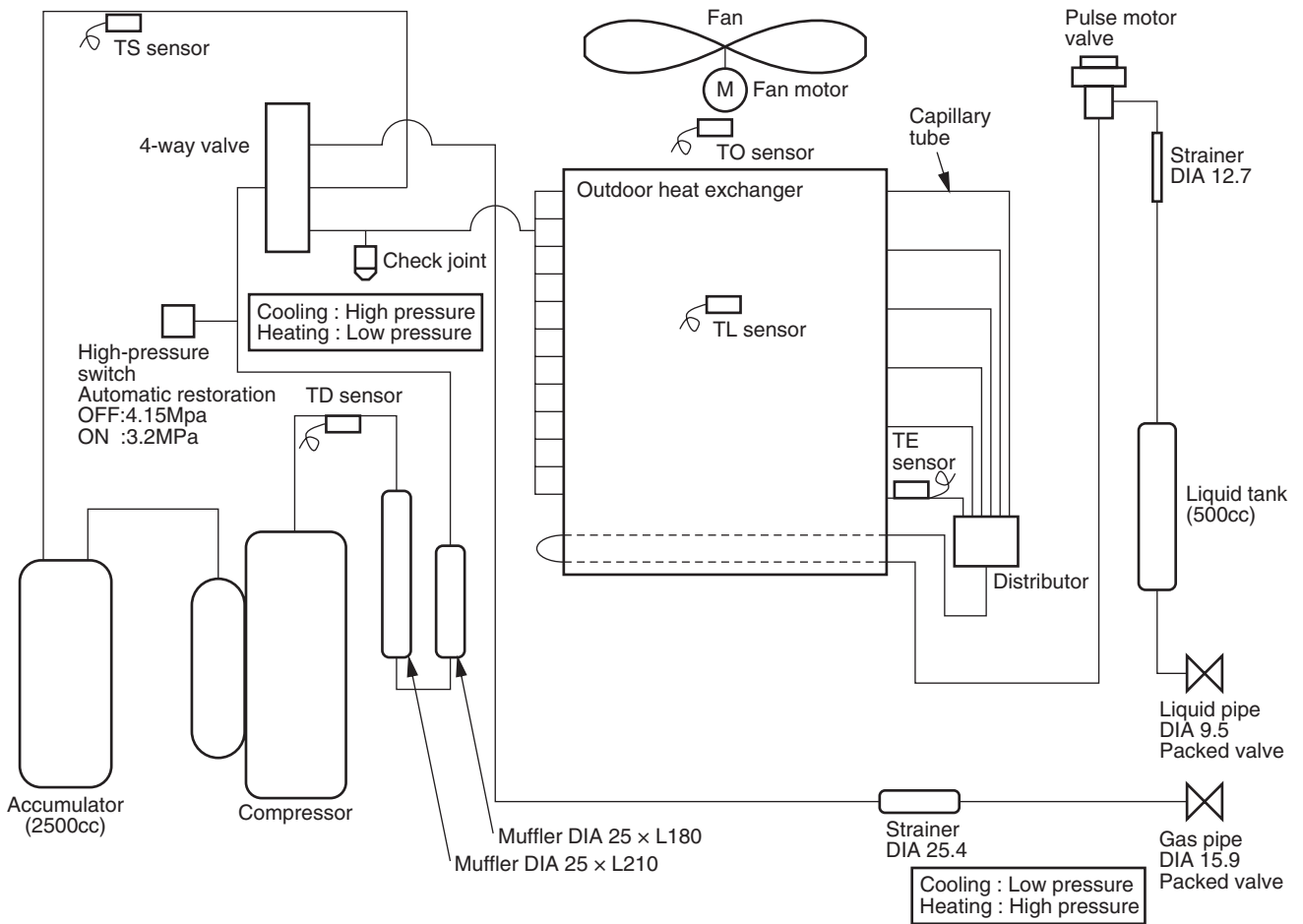

RAV-GP801 series

		Pressure				Pipe surface temperature (°C)					Compressor drive revolution frequency (rps)	Indoor fan	Indoor/outdoor temp.condition	
		(Mpa)		(kg/cm ² g)		Discharge	Suction	Indoor heat exchanger	Outdoor heat exchanger				indoor	outdoor
		Pd	Ps	Pd	Ps	(TD)	(TS)	(TC)	(TL)	(TE)				
cooling	Standard	2.7	1.1	27.9	11.0	71.7	15.6	14.0	46.8	43.0	48.0	HIGH	27/19	35/-
	Overload	3.8	1.2	38.7	12.5	80.2	20.1	19.0	59.5	57.2	44.4	HIGH	32/24	52/-
	Low load	2.5	0.9	25.5	9.3	45.2	7.1	8.0	44.0	37.6	30.0	LOW	18/15.5	-15/-
Heating	Standard	2.1	0.7	21.2	7.3	66.1	4.7	32.0	9.1	3.3	60.0	HIGH	20/-	7/6
	Overload	3.6	1.2	36.9	12.7	88.7	18.2	53.0	20.0	17.4	24.0	LOW	30/-	24/18
	Low load	1.6	0.2	16.6	1.7	53.1	-26.6	22.0	-10.5	-25.7	99.6	HIGH	15/-	-27/-

* This compressor has a 6-pole motor

The value when compressor frequency (Hz) is measured by a clamp meter is 3 times the compressor revolution number (rps)

* This data is cycle data obtained by combining a four-way cassette type.

Data will change depending on the mounted pipe length or combination with the indoor unit.

RAV-GP1101 series

		Pressure				Pipe surface temperature (°C)					Compressor drive revolution frequency (rps)	Indoor fan	Indoor/outdoor temp.condition	
		(Mpa)		(kg/cm ² g)		Discharge	Suction	Indoor heat exchanger	Outdoor heat exchanger				indoor	outdoor
		Pd	Ps	Pd	Ps	(TD)	(TS)	(TC)	(TL)	(TE)				
cooling	Standard	2.5	1.1	25.5	11.3	73.1	15.6	14.0	44.0	36.3	34.2	HIGH	27/19	35/-
	Overload	3.6	1.4	37.0	14.0	77.4	21.4	21.0	58.5	54.5	30.0	HIGH	32/24	52/-
	Low load	1.9	0.7	19.5	6.9	70.3	1.2	3.0	39.9	30.3	33.0	LOW	18/15.5	-15/-
Heating	Standard	2.2	0.8	22.7	7.8	72.6	3.9	35.0	9.1	3.9	44.4	HIGH	20/-	7/6
	Overload	3.6	1.1	36.3	11.3	90.8	23.5	53.0	23.0	18.2	26.4	LOW	30/-	24/18
	Low load	1.5	0.2	15.7	1.8	64.7	-25.7	21.0	-10.5	-24.4	78.6	HIGH	15/-	-27/-

RAV-GP1401 series

		Pressure				Pipe surface temperature (°C)					Compressor drive revolution frequency (rps)	Indoor fan	Indoor/outdoor temp.condition	
		(Mpa)		(kg/cm ² g)		Discharge	Suction	Indoor heat exchanger	Outdoor heat exchanger				indoor	outdoor
		Pd	Ps	Pd	Ps	(TD)	(TS)	(TC)	(TL)	(TE)				
cooling	Standard	2.7	1.0	27.7	10.0	84.6	16.0	11.0	46.3	36.3	47.4	HIGH	27/19	35/-
	Overload	3.6	1.4	37.0	14.0	77.4	21.4	21.0	58.5	54.5	30.0	HIGH	32/24	52/-
	Low load	1.9	0.7	19.5	6.9	70.3	1.2	3.0	39.9	30.3	33.0	LOW	18/15.5	-15/-
Heating	Standard	2.5	0.7	25.2	7.5	83.2	3.9	38.0	7.6	3.6	55.8	HIGH	20/-	7/6
	Overload	3.6	1.1	36.3	11.3	90.8	23.5	53.0	23.0	18.2	26.4	LOW	30/-	24/18
	Low load	1.6	0.2	16.7	1.6	65.6	-27.0	23.0	-10.5	-24.8	99.6	HIGH	15/-	-27/-

* This compressor has a 4-pole motor

The value when compressor frequency (Hz) is measured by a clamp meter is twice the compressor revolution number (rps)

* This data is cycle data obtained by combining a four-way cassette type.

Data will change depending on the mounted pipe length or combination with the indoor unit.

4. WIRING DIAGRAM

4-1. RAV-GP801AT*

For D800 • D805 and SW01 • SW02, refer to the installation manual.

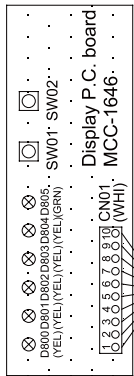

Symbol	Part name
CM	Compressor
FM02	Fan motor
F01	Fuse 25A 250V ~
F03	Fuse 10A 250V ~
PMV	Pulse motor valve
TB1	Terminal (Power supply)
TB2	Terminal (To Indoor unit)
TD	Pipe temperature sensor(Discharge)
TE	Heat exchanger sensor 1
TL	Heat exchanger sensor 2
TO	Outside temperature sensor
TS	Pipe temperature sensor(Suction)
20SF	4-way valve coil
49C	Compressor case thermostat
63H	High-pressure switch

Color Indication
BLK : BLACK
BLU : BLUE
RED : RED
YEL : YELLOW
WHT : WHITE
GRN : GREEN

	Field wiring
	Protective earth
	Terminal block
	Terminal
	Connector
	P.C. board

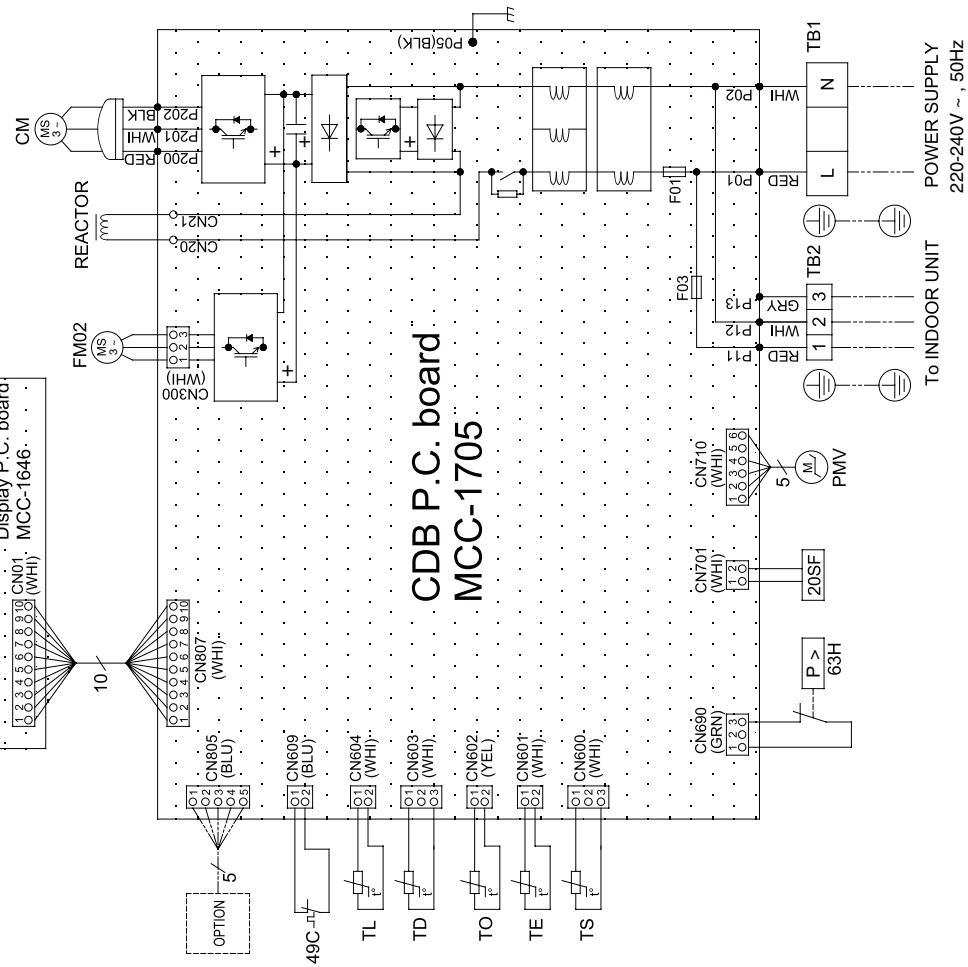

4-2. RAV-GP1101AT*, GP1401AT*

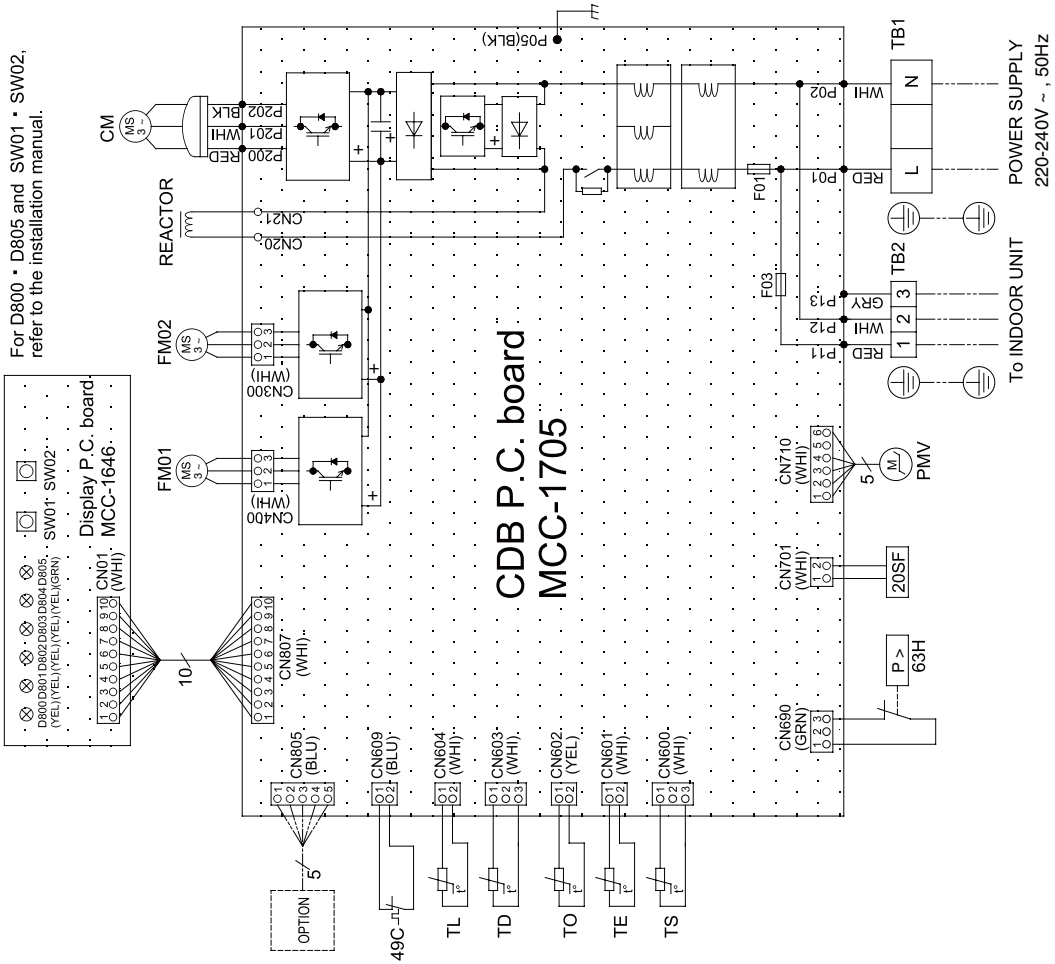

5. SPECIFICATIONS OF ELECTRICAL PARTS

5-1. Outdoor Unit

RAV-GP801AT*

No.	Parts name	Type	Specifications
1	Compressor	NX220A1F-20N	—
2	Outdoor fan motor	ICF-280-A60-1	DC280V, 60W
3	4-way valve coil	STF-H01AZ1724A1	DC12V
4	PMV coil	UKV-A040	DC12V
5	High pressure switch	ACB-4UB83W	OFF:4.15MPa
6	Compressor thermostat	US-622	OFF:125 ± 4°C , ON:90 ± 5°C
7	Reactor	CH-101	10mH, 20A
8	P.C.board	MCC-1705	—
9	P.C.board(LED display)	MCC-1646	—
10	Outdoor temp. sensor (TO sensor)	—	10kΩ at 25°C
11	Discharge temp. sensor (TD sensor)	—	1.905kΩ at 120°C
12	Suction temp. sensor (TS sensor)	—	10kΩ at 25°C
13	Heat exchanger temp. sensor (TE sensor)	—	10kΩ at 25°C
14	Heat exchanger mid. temp. sensor (TL sensor)	—	1.905kΩ at 120°C
15	Fuse (Mounted on P.C.board, MCC-1705)	GDT250V25A-A	25A, 250V
16	Fuse (Mounted on P.C.board, MCC-1705)	SCT3.15A	3.15A, 250V
17	Fuse (Mounted on P.C.board, MCC-1705)	50T100H	10A, 250V
18	Relay	DX12D1-0(M)	20A, 250V

RAV-GP1101AT*,GP1401AT*

No.	Parts name	Type	Specifications
1	Compressor	DX380A2T-20M	—
2	Outdoor fan motor	ICF-280-A100-1	DC280V, 100W
3	4-way valve coil	STF-H01AZ1724A1	DC12V
4	PMV coil	UKV-A040	DC12V
5	High pressure switch	ACB-4UB83W	OFF:4.15MPa
6	Compressor thermostat	US-622	OFF:125 ± 4°C, ON:90 ± 5°C
7	Reactor	CH-101	10mH, 20A
8	P.C.board	MCC-1705	—
9	P.C.board(LED display)	MCC-1646	—
10	Outdoor temp. sensor (TO sensor)	—	10kΩ at 25°C
11	Discharge temp. sensor (TD sensor)	—	1.905kΩ at 120°C
12	Suction temp. sensor (TS sensor)	—	10kΩ at 25°C
13	Heat exchanger temp. sensor (TE sensor)	—	10kΩ at 25°C
14	Heat exchanger mid. temp. sensor (TL sensor)	—	1.905kΩ at 120°C
15	Fuse (Mounted on P.C.board, MCC-1705)	GDT250V25A-A	25A, 250V
16	Fuse (Mounted on P.C.board, MCC-1705)	SCT3.15A	3.15A, 250V
17	Fuse (Mounted on P.C.board, MCC-1705)	50T100H	10A, 250V
18	Relay	DX12D1-0(M)	20A, 250V

6. REFRIGERANT R32

This air conditioner adopts the R32 refrigerant which does not damage the ozone layer.

The working pressure of the new refrigerant R32 is 1.6 times higher than conventional refrigerant (R22).

The refrigerating oil is also changed in accordance with change of refrigerant, so be careful that water, dust, and existing refrigerant or refrigerating oil are not entered in the refrigerant cycle of the air conditioner using the new refrigerant during installation work or servicing time.

The next section describes the precautions for air conditioner using the new refrigerant.

Conforming to contents of the next section together with the general cautions included in this manual, perform the correct and safe work.

6-1. Safety During Installation/Serviceing

As R32's pressure is about 1.6 times higher than that of R22, improper installation/serviceing may cause a serious trouble. By using tools and materials exclusive for R32, it is necessary to carry out installation/serviceing safely while taking the following precautions into consideration.

1. Never use refrigerant other than R32 in an air conditioner which is designed to operate with R32. If other refrigerant than R32 is mixed, pressure in the refrigeration cycle becomes abnormally high, and it may cause personal injury, etc. by a rupture.
2. Confirm the used refrigerant name, and use tools and materials exclusive for the refrigerant R32. The refrigerant name R32 is indicated on the visible place of the outdoor unit of the air conditioner using R32 as refrigerant. A diameter of the charge port for R32 is the same as that for the R410A's. Be careful not to charge the refrigerant by mistake.
3. If a refrigeration gas leakage occurs during installation/serviceing, be sure to ventilate fully. If the refrigerant gas comes into contact with fire, a poisonous gas may occur.
4. When installing or removing an air conditioner, do not allow air or moisture to remain in the refrigeration cycle. Otherwise, pressure in the refrigeration cycle may become abnormally high so that a rupture or personal injury may be caused.
5. After completion of installation work, check to make sure that there is no refrigeration gas leakage. If the refrigerant gas leaks into the room, coming into contact with fire in the fan-driven heater, space heater, etc., a poisonous gas may occur.
6. When an air conditioning system charged with a large volume of refrigerant is installed in a small room, it is necessary to exercise care so that, even when refrigerant leaks, its concentration does not exceed the marginal level. If the refrigerant gas leakage occurs and its concentration exceeds the marginal level, an oxygen starvation accident may result.

7. Be sure to carry out installation or removal according to the installation manual.

Improper installation may cause refrigeration trouble, water leakage, electric shock, fire, etc.

8. Unauthorized modifications to the air conditioner may be dangerous. If a breakdown occurs please call a qualified air conditioner technician or electrician.

Improper repair may result in water leakage, electric shock and fire, etc.

6-2. Refrigerant Piping Installation

6-2-1. Piping Materials and Joints Used

For the refrigerant piping installation, copper pipes and joints are mainly used.

Copper pipes and joints suitable for the refrigerant must be chosen and installed.

Furthermore, it is necessary to use clean copper pipes and joints whose interior surfaces are less affected by contaminants.

1. Copper Pipes

It is necessary to use seamless copper pipes which are made of either copper or copper alloy and it is desirable that the amount of residual oil is less than 40 mg/10 m.

Do not use copper pipes having a collapsed, deformed or discolored portion (especially on the interior surface).

Otherwise, the expansion valve or capillary tube may become blocked with contaminants.

As an air conditioner using R32 incurs pressure higher than when using R22, it is necessary to choose adequate materials.

Thicknesses of copper pipes used with R32 are as shown in Table 6-2-1. Never use copper pipes thinner than 0.8mm even when it is available on the market.

NOTE

Refer to the "6-6. Instructions for Re-use Piping of R22 or R407C".

Table 6-2-1 Thicknesses of annealed copper pipes

		Thickness (mm)	
Nominal diameter	Outer diameter (mm)	R410A or R32	R22
1/4	6.4	0.80	0.80
3/8	9.5	0.80	0.80
1/2	12.7	0.80	0.80
5/8	15.9	1.00	1.00

1. Joints

For copper pipes, flare joints or socket joints are used. Prior to use, be sure to remove all contaminants.

a) Flare Joints

Flare joints used to connect the copper pipes cannot be used for piping whose outer diameter exceeds 20 mm. In such a case, socket joints can be used.

Sizes of flare pipe ends, flare joint ends and flare nuts are as shown in Tables 6-2-3 to 6-2-5 below.

b) Socket Joints

Socket joints are such that they are brazed for connections, and used mainly for thick piping whose diameter is larger than 20 mm. Thicknesses of socket joints are as shown in Table 6-2-2.

Table 6-2-2 Minimum thicknesses of socket joints

Nominal diameter	Reference outer diameter of copper pipe jointed (mm)	Minimum joint thickness (mm)
1/4	6.4	0.50
3/8	9.5	0.60
1/2	12.7	0.70
5/8	15.9	0.80

6-2-2. Processing of Piping Materials

When performing the refrigerant piping installation, care should be taken to ensure that water or dust does not enter the pipe interior, that no other oil other than lubricating oils used in the installed air conditioner is used, and that refrigerant does not leak.

When using lubricating oils in the piping processing, use such lubricating oils whose water content has been removed. When stored, be sure to seal the container with an airtight cap or any other cover.

1. Flare Processing Procedures and Precautions

a) Cutting the Pipe

By means of a pipe cutter, slowly cut the pipe so that it is not deformed.

b) Removing Burrs and Chips

If the flared section has chips or burrs, refrigerant leakage may occur.

Carefully remove all burrs and clean the cut surface before installation.

c) Insertion of Flare Nut

d) Flare Processing

Make certain that a clamp bar and copper pipe have been cleaned.

By means of the clamp bar, perform the flare processing correctly.

Use either a flare tool for R410A / R32 or conventional flare tool.

Flare processing dimensions differ according to the type of flare tool.

When using a conventional flare tool, be sure to secure "dimension A" by using a gauge for size adjustment.

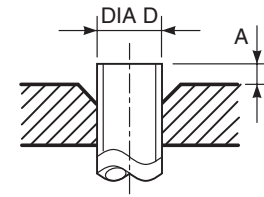

Fig. 6-2-1 Flare processing dimensions

Table 6-2-3 Dimensions related to flare processing for R410A or R32 / R22

Nominal diameter	Outer diameter (mm)	Thickness (mm)	A (mm)				
			Flare tool for R410A, R22 clutch type	Conventional flare tool (R410A or R32)		Conventional flare tool (R22)	
				Clutch type	Wing nut type	Clutch type	Wing nut type
1/4	6.4	0.8	0 to 0.5	1.0 to 1.5	1.5 to 2.0	0.5 to 1.0	1.0 to 1.5
3/8	9.5	0.8	0 to 0.5	1.0 to 1.5	1.5 to 2.0	0.5 to 1.0	1.0 to 1.5
1/2	12.7	0.8	0 to 0.5	1.0 to 1.5	2.0 to 2.5	0.5 to 1.0	1.5 to 2.0
5/8	15.9	1.0	0 to 0.5	1.0 to 1.5	2.0 to 2.5	0.5 to 1.0	1.5 to 2.0
3/4	19.1	1.2	0 to 0.5	1.0 to 1.5	2.0 to 2.5	—	—

Table 6-2-4 Flare and flare nut dimensions for R410A or R32

Nominal diameter	Outer diameter (mm)	Thickness (mm)	Dimension (mm)				Flare nut width (mm)
			A	B	C	D	
1/4	6.4	0.8	9.1	9.2	6.5	13	17
3/8	9.5	0.8	13.2	13.5	9.7	20	22
1/2	12.7	0.8	16.6	16.0	12.9	23	26
5/8	15.9	1.0	19.7	19.0	16.0	25	29
3/4	19.1	1.2	24.0	—	19.2	28	36

Table 6-2-5 Flare and flare nut dimensions for R22

Nominal diameter	Outer diameter (mm)	Thickness (mm)	Dimension (mm)				Flare nut width (mm)
			A	B	C	D	
1/4	6.4	0.8	9.1	9.2	6.5	13	17
3/8	9.5	0.8	13.0	13.5	9.7	20	22
1/2	12.7	0.8	16.2	16.0	12.9	20	24
5/8	15.9	1.0	19.4	19.0	16.0	23	27
3/4	19.1	1.0	23.3	24.0	19.2	34	36

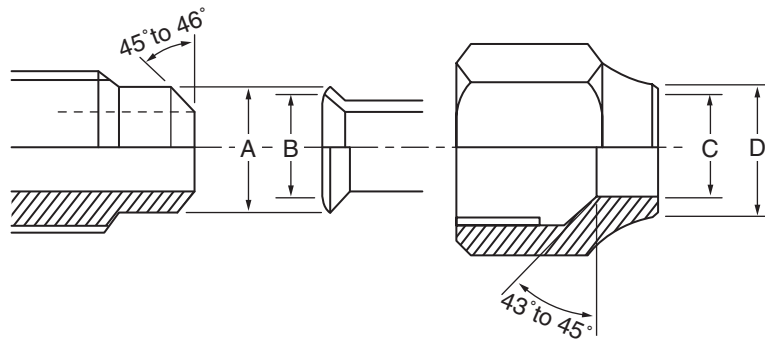

Fig. 6-2-2 Relations between flare nut and flare seal surface

2. Flare Connecting Procedures and Precautions

- Make sure that the flare and union portions do not have any scar or dust, etc.
- Correctly align the processed flare surface with the union axis.
- Tighten the flare with designated torque by means of a torque wrench.
The tightening torque for R410A or R32 is the same as that for conventional R22.
Incidentally, when the torque is weak, the gas leakage may occur.
When it is strong, the flare nut may crack and may be made non-removable.
When choosing the tightening torque, comply with values designated by manufacturers.
Table 6-2-6 shows reference values.

NOTE

When applying oil to the flare surface, be sure to use oil designated by the manufacturer.
If any other oil is used, the lubricating oils may deteriorate and cause the compressor to burn out.

Table 6-2-6 Tightening torque of flare for R410A or R32 [Reference values]

Nominal diameter	Outer diameter (mm)	Tightening torque N•m (kgf m)	Tightening torque of torque wrenches available on the market N m (kgf m)
1/4	6.4	14 to 18 (1.4 to 1.8)	16 (1.6), 18 (1.8)
3/8	9.5	33 to 42 (3.3 to 4.2)	42 (4.2)
1/2	12.7	50 to 62 (5.0 to 6.2)	55 (5.5)
5/8	15.9	68 to 82 (6.8 to 8.2)	65 (6.5)
3/4	19.1	100 to 120 (10.0 to 12.0)	—

6-3. Tools

6-3-1. Required Tools

Refer to the “4. Tools” (Page 14)

6-4. Recharging of Refrigerant

When it is necessary to recharge refrigerant, charge the specified amount of new refrigerant according to the following steps.

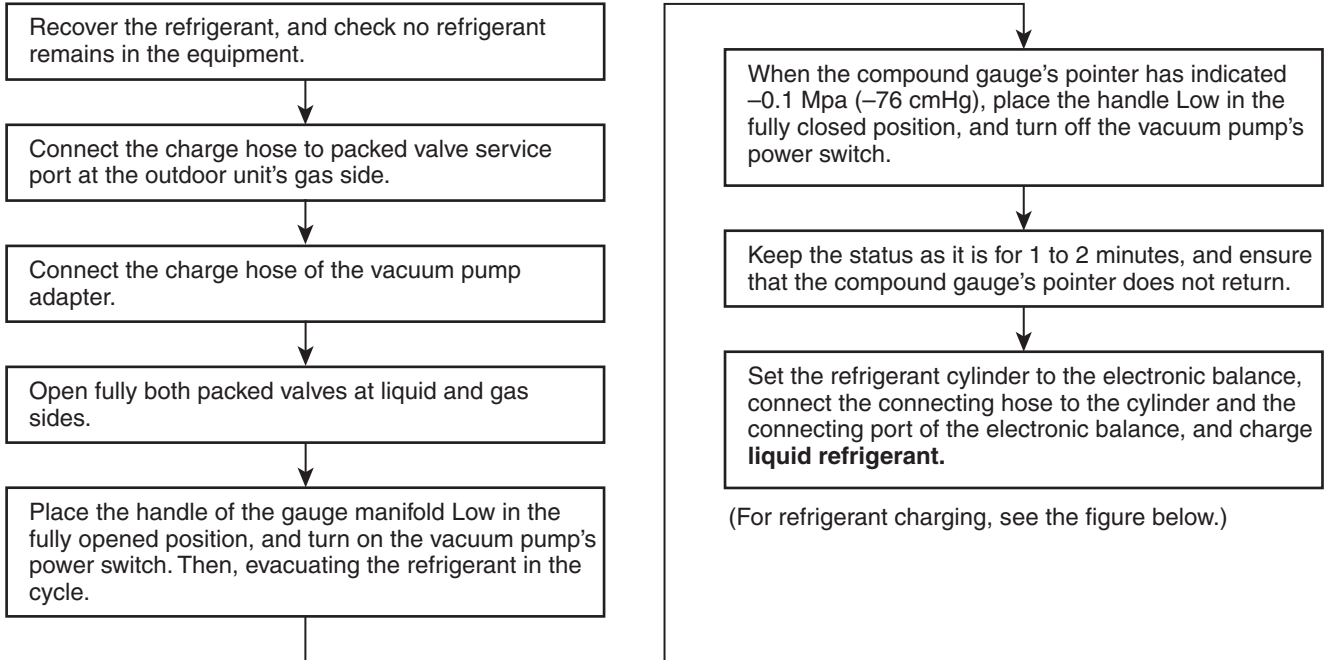

- 1) Never charge refrigerant exceeding the specified amount.
- 2) If the specified amount of refrigerant cannot be charged, charge refrigerant **bit by bit** in COOL mode.
- 3) Do not carry out additional charging.

When additional charging is carried out if refrigerant leaks, the refrigerant composition changes in the refrigeration cycle, which changes characteristics of the air conditioner, refrigerant exceeding the specified amount is charged, and working pressure in the refrigeration cycle becomes abnormally high pressure, and may cause a rupture or personal injury.

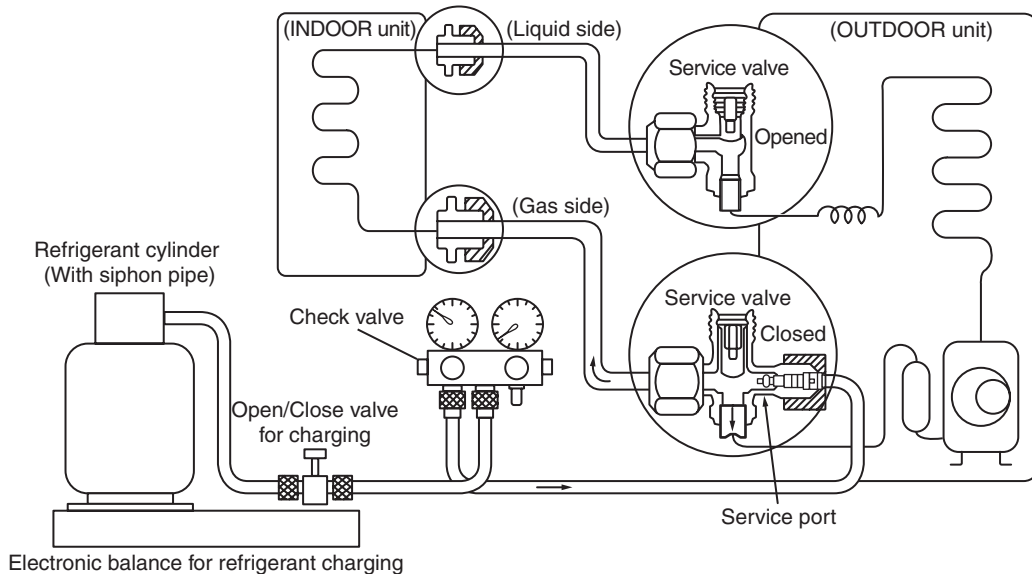

Fig. 6-4-1 Configuration of refrigerant charging

-
- 1) Be sure to make setting so that **liquid** can be charged.
 - 2) When using a cylinder equipped with a siphon, liquid can be charged without turning it upside down.
-

R32 refrigerant is a Single-component refrigerant that does not change its composition. Although it is possible to charge the refrigerant with either liquid or gas, charge it with liquid. (If using gas for charging, composition of the refrigerant changes and then characteristics of the air conditioner change.)

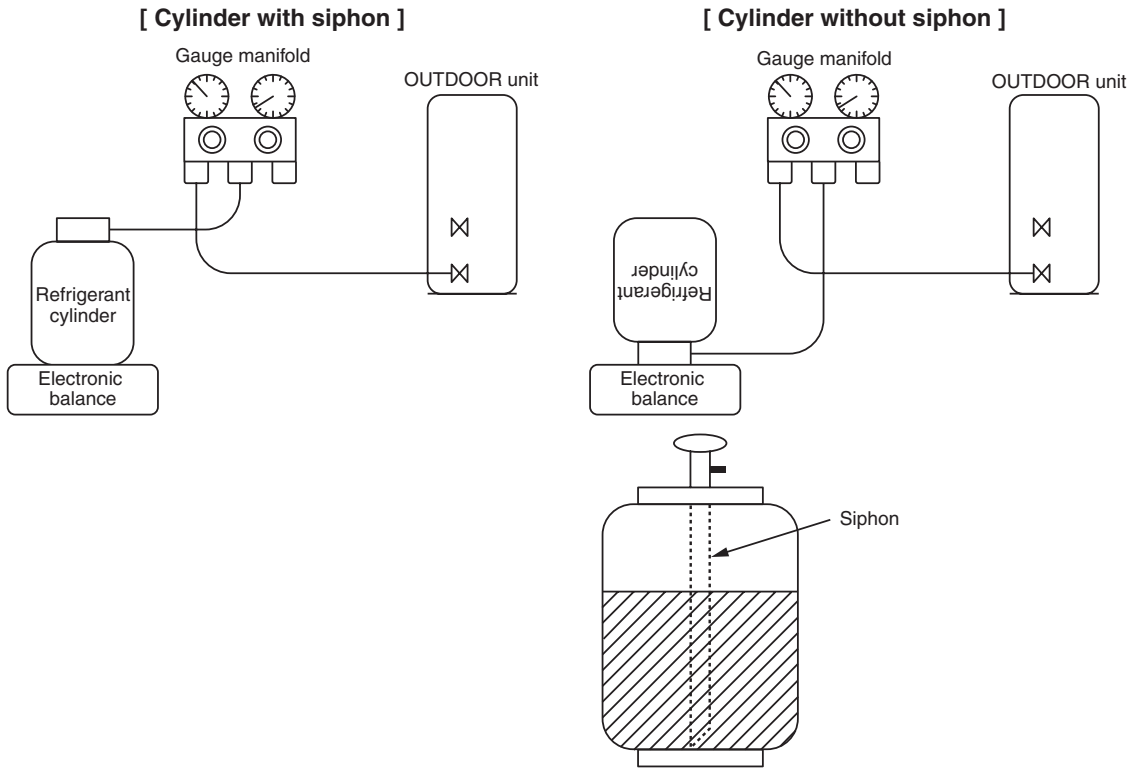

Fig. 6-4-2

6-5. Brazing of Pipes

6-5-1. Materials for Brazing

1. Silver brazing filler

Silver brazing filler is an alloy mainly composed of silver and copper.

It is used to join iron, copper or copper alloy, and is relatively expensive though it excels in solderability.

2. Phosphor bronze brazing filler

Phosphor bronze brazing filler is generally used to join copper or copper alloy.

3. Low temperature brazing filler

Low temperature brazing filler is generally called solder, and is an alloy of tin and lead. Since it is weak in adhesive strength, do not use it for refrigerant pipes.

-
- 1) Phosphor bronze brazing filler tends to react with sulfur and produce a fragile compound water solution, which may cause a gas leakage. Therefore, use any other type of brazing filler at a hot spring resort, etc., and coat the surface with a paint.
 - 2) When performing brazing again at time of servicing, use the same type of brazing filler.
-

6-5-2. Flux

1. Reason why flux is necessary

- By removing the oxide film and any foreign matter on the metal surface, it assists the flow of brazing filler.
- In the brazing process, it prevents the metal surface from being oxidized.
- By reducing the brazing filler's surface tension, the brazing filler adheres better to the treated metal.

2. Characteristics required for flux

- Activated temperature of flux coincides with the brazing temperature.
- Due to a wide effective temperature range, flux is hard to carbonize.
- It is easy to remove slag after brazing.
- The corrosive action to the treated metal and brazing filler is minimum.
- It excels in coating performance and is harmless to the human body.

As the flux works in a complicated manner as described above, it is necessary to select an adequate type of flux according to the type and shape of treated metal, type of brazing filler and brazing method, etc.

3. Types of flux

• Noncorrosive flux

Generally, it is a compound of borax and boric acid.

It is effective in case where the brazing temperature is higher than 800°C.

• Activated flux

Most of fluxes generally used for silver brazing are this type.

It features an increased oxide film removing capability due to the addition of compounds such as potassium fluoride, potassium chloride and sodium fluoride to the borax-boric acid compound.

4. Piping materials for brazing and used brazing filler/flux

Piping material	Used brazing filler	Used flux
Copper - Copper	Phosphor copper	Do not use
Copper - Iron	Silver	Paste flux
Iron - Iron	Silver	Vapor flux

- 1) Do not enter flux into the refrigeration cycle.
- 2) When chlorine contained in the flux remains within the pipe, the lubricating oil deteriorates. Therefore, use a flux which does not contain chlorine.
- 3) When adding water to the flux, use water which does not contain chlorine (e.g. distilled water or ion-exchange water).
- 4) Remove the flux after brazing.

6-5-3. Brazing

As brazing work requires sophisticated techniques, experiences based upon a theoretical knowledge, it must be performed by a person qualified. In order to prevent the oxide film from occurring in the pipe interior during brazing, it is effective to proceed with brazing while letting dry Nitrogen gas flow.

Never use gas other than Nitrogen gas.

1. Brazing method to prevent oxidation

- 1) Attach a reducing valve and a flow-meter to the Nitrogen gas cylinder.
- 2) Use a copper pipe to direct the piping material, and attach a flow-meter to the cylinder.
- 3) Apply a seal onto the clearance between the piping material and inserted copper pipe for Nitrogen in order to prevent backflow of the Nitrogen gas.
- 4) When the Nitrogen gas is flowing, be sure to keep the piping end open.
- 5) Adjust the flow rate of Nitrogen gas so that it is lower than 0.05 m³/Hr or 0.02 MPa (0.2kgf/cm²) by means of the reducing valve.
- 6) After performing the steps above, keep the Nitrogen gas flowing until the pipe cools down to a certain extent (temperature at which pipes are touchable with hands).
- 7) Remove the flux completely after brazing.

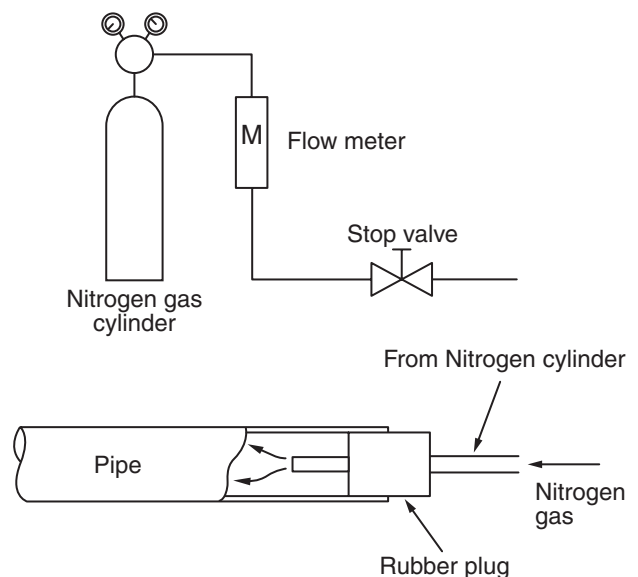

Fig. 6-5-1 Prevention of oxidation during brazing

6-6. Instructions for Re-use Piping of R22 or R407C

Instruction of Works:

The existing R22 and R407C piping can be reused for our digital inverter R32 products installations.

WARNING

Confirming the existence of scratches or dents on the existing pipes and confirming the reliability of the pipe strength are conventionally referred to the local site. If the specified conditions can be cleared, it is possible to update existing R22 and R407C pipes to those for R32 models.

6-6-1. Basic Conditions Needed to Reuse the Existing Pipe

Check and observe three conditions of the refrigerant piping works.

1. Dry (There is no moisture inside of the pipes.)
2. Clean (There is no dust inside of the pipes.)
3. Tight (There is no refrigerant leak.)

6-6-2. Restricted Items to Use the Existing Pipes

In the following cases, the existing pipes cannot be reused as they are. Clean the existing pipes or exchange them with new pipes.

1. When a scratch or dent is heavy, be sure to use the new pipes for the works.
2. When the thickness of the existing pipe is thinner than the specified "Pipe diameter and thickness" be sure to use the new pipes for the works.
 - The operating pressure of R32 is high. If there is a scratch or dent on the pipe or a thinner pipe is used, the pressure strength may be inadequate, which may cause the pipe to break in the worst case.

* Pipe diameter and thickness (mm)

Reference outside diameter (mm)	Wall thickness (mm)	Material
6.4	0.8	—
9.5	0.8	—
12.7	0.8	—
15.9	1.0	—

- In case that the pipe diameter is DIA 12.7 mm or less and the thickness is less than 0.7 mm, be sure to use the new pipes for works.
3. The pipes are left as coming out or gas leaks. (Poor refrigerant)
 - There is possibility that rain water or air including moisture enters in the pipe.
 4. Refrigerant recovery is impossible. (Refrigerant recovery by the pump-down operation on the existing air conditioner)
 - There is possibility that a large quantity of poor oil or moisture remains inside of the pipe.

5. A dryer on the market is attached to the existing pipes.
 - There is possibility that copper green rust generated.
6. Check the oil when the existing air conditioner was removed after refrigerant had been recovered. In this case, if the oil is judged as clearly different compared with normal oil
 - The refrigerator oil is copper rust green : There is possibility that moisture is mixed with the oil and rust generates inside of the pipe.
 - There is discolored oil, a large quantity of the remains, or bad smell.
 - A large quantity of sparkle remained wear-out powder is observed in the refrigerator oil.
7. The air conditioner which compressor was exchanged due to a trouble compressor. When the discolored oil, a large quantity of the remains, mixture of foreign matter, or a large quantity of sparkle remained wear-out powder is observed, the cause of trouble will occur.
8. Installation and removal of the air conditioner are repeated with temporary installation by lease and etc.
9. In case that type of the refrigerator oil of the existing air conditioner is other than the following oil (Mineral oil), Suniso, Freol-S, MS (Synthetic oil), alkyl benzene (HAB, Barrel-freeze), ester series, PVE only of ether series.
 - Winding-insulation of the compressor may become inferior.

NOTE

The above descriptions are results of confirmation by our company and they are views on our air conditioners, but they do not guarantee the use of the existing pipes of the air conditioner that adopted R410A in other companies.

6-6-3. Branching Pipe for Simultaneous Operation System

- In the concurrent twin system, when TOSHIBA-specified branching pipe is used, it can be reused. Branching pipe model name: RBC-TWP30E, RBC-TWP50E
On the existing air conditioner for simultaneous operation system (twin system), there is a case of using branch pipe that has insufficient compressive strength. In this case please change it to the branch pipe for R32 or R410A.

6-6-4. Curing of Pipes

When removing and opening the indoor unit or outdoor unit for a long time, cure the pipes as follows:

- Otherwise rust may generate when moisture or foreign matter due to dewing enters in the pipes.
- The rust cannot be removed by cleaning, and a new piping work is necessary.

Place position	Term	Curing manner
Outdoors	1 month or more	Pinching
	Less than 1 month	Pinching or taping
Indoors	Every time	

6-6-5. Final Installation Checks

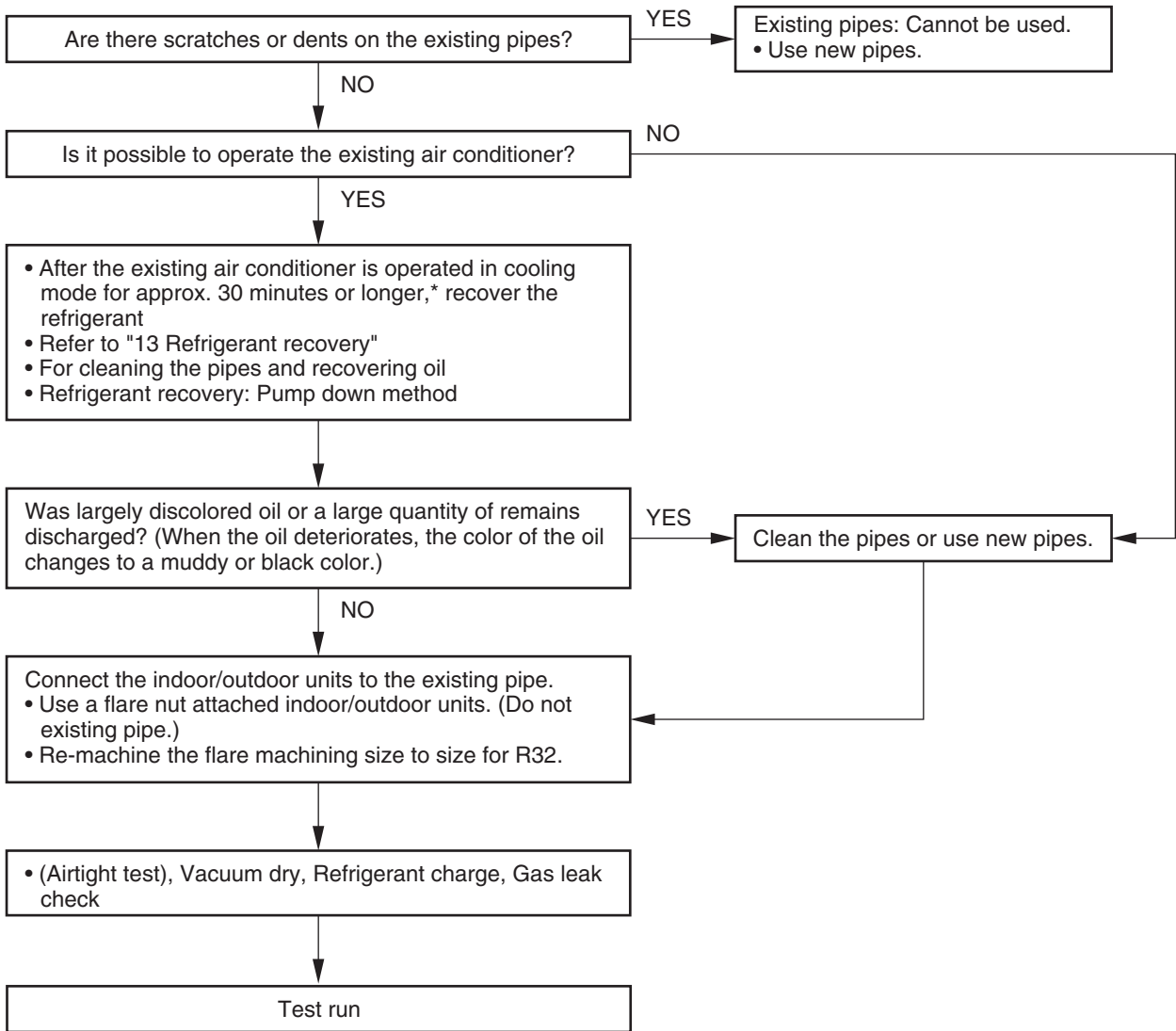

6-6-6. Handling of Existing Pipe

When using the existing pipe, carefully check it for the following:

- Wall thickness (within the specified range)
- Scratches and dents
- Water, oil, dirt, or dust in the pipe
- Flare looseness and leakage from welds
- Deterioration of copper pipe and heat insulator
- Before recovering the refrigerant in the existing system, perform a cooling operation for at least 30 minutes.

Cautions for using existing pipe

- Do not reuse a flare nut to prevent gas leaks. Replace it with the supplied flare nut and then process it to a flare.
- Blow nitrogen gas or use an appropriate means to keep the inside of the pipe clean. If discolored oil or much residue is discharged, wash the pipe.
- Check welds, if any, on the pipe for gas leaks.
- There may be a problem with the pressure resistance of the branching pipes of the existing piping. Replace them with branch pipes (sold separately).

When the pipe corresponds to any of the following, do not use it. Install a new pipe instead.

- The pipe has been opened (disconnected from indoor unit or outdoor unit) for a long period.
- The pipe has been connected to an outdoor unit that does not use refrigerant R22, R410A, R32 R407C.
- The existing pipe must have a wall thickness equal to or larger than the following thicknesses.

Reference outside diameter (mm)	Wall thickness (mm)	Material
6.4	0.8	—
9.5	0.8	—
12.7	0.8	—
15.9	1.0	—
19.1	1.2	—
22.2	1.0	Half hard
28.6	1.0	Half hard

- Do not use any pipe with a wall thickness less than these thicknesses due to insufficient pressure capacity.

6-6-7. Recovering Refrigerant

Use the refrigerant recovery equipment to recover the refrigerant.

6-7. Charging additional refrigerant

Amount of additional refrigerant shall be restricted by the following explanation to ensure the reliability. Miss-charging leads to the abnormal high pressure in the refrigerant cycle, causing a rupture, an injury and a compressor malfunction.

6-7-1. [Assumed gas leak]

The refrigerant can be charged only when the amount of a leak such as a slow-leak found at the installation work can be ensured that it is within the additional limits shown in the following. Recharge the refrigerant if the amount of leakage is unknown when you feel “Cooling is not working well” or “Heating is not working well”.

6-7-2. [Limiting the additional charge]

- The maximum amount of additional refrigerant shall be up to 10 % of the normal amount of the refrigerant. If no improvement in symptoms can be found at the above limitation, recover all gases and recharge the normal amount of refrigerant.
- If the slow leak is found at the installation work and the connection pipe length is 15 m or less, tighten the flare nut at the leak point and do not add the refrigerant.

6-7-3. [Cautions on charging additional refrigerant]

- When charging additional refrigerant, use a balance with an accuracy of more than 10 g scale. Do not use a health-meter etc.
- If the refrigerant gas leaks, find the leakage point and repair it securely. Though the refrigerant gas itself is innocuous, if it touch a fire source such as fan heater, stove or kitchen stove, noxious gas may occur.
- When charging the refrigerant, charge with liquid refrigerant. Work carefully and charge it little by little since it may be rapidly charged due to the liquid state.

6-8. General safety precautions for using R32 refrigerant

6-8-1. Recovery

- When removing refrigerant from a system, either for servicing or decommissioning, it is recommended good practice that all refrigerants are removed safely.
- When transferring refrigerant into cylinders, ensure that only appropriate refrigerant recovery cylinders are employed.
- Ensure that the correct number of cylinders for holding the total system charge are available.
- All cylinders to be used are designated for the recovered refrigerant and labelled for that refrigerant (i.e. special cylinders for the recovery of refrigerant).
- Cylinders shall be complete with pressure relief valve and associated shut-off valves in good working order.
- Empty recovery cylinders are evacuated and, if possible, cooled before recovery occurs.
- The recovery equipment shall be in good working order with a set of instructions concerning the equipment that is at hand and shall be suitable for the recovery of mildly flammable refrigerants.
- In addition, a set of calibrated weighing scales shall be available and in good working order.
- Hoses shall be complete with leak-free disconnect couplings and in good condition.
- Before using recovery machine check that it is satisfactory working order, has been properly maintained and that any associated electrical components are sealed to prevent ignition in the event of a refrigerant release.
- Consult manufacturer if in doubt.
- The recovered refrigerant shall be returned to the refrigerant supplier in the correct recovery cylinder, and the relevant Waste Transfer Note arranged.
- Do not mix refrigerants in recovery units and especially not in cylinders.
- If compressors or compressor oils are to be removed, ensure that they have been evacuated to an acceptable level to make certain that mildly flammable refrigerant does not remain within the lubricant.
- The evacuation process shall be carried out prior to returning the compressor to the suppliers.
- Only electric heating to the compressor body shall be employed to accelerate this process.
- When oil is drained from a system, it shall be

carried out safely.

6-8-2. Decommissioning

- Before carrying out this procedure, it is essential that the technician is completely familiar with the equipment and all its details. Only a qualified installer (*1) or qualified service person (*1) is allowed to do this work.
- It is recommended good practice that all refrigerants are recovered safely.
- Prior to the task being carried out, an oil and refrigerant sample shall be taken in case analysis is required prior to re-use of reclaimed refrigerant.
- It is essential that electrical power is available before the task is commenced.

-
- a) Become familiar with the equipment and its operation.
 - b) Isolate system electrically.
 - c) Before attempting the procedure ensure that :
 - Mechanical handling equipment is available, if required, for handling refrigerant cylinders;
 - All personal protective equipment is available and being used correctly;
 - The recovery process is supervised at all times by a competent person;
 - Recovery equipment and cylinders conform to the appropriate standards.
 - d) Pump down refrigerant system, if possible.
 - e) If a vacuum is not possible, make a manifold so that refrigerant can be removed from the various parts of the system.
 - f) Make sure that cylinder is situated on the scales before recovery takes place.
 - g) Start the recovery machine and operate in accordance with manufacturers instructions.
 - h) Do not overfill cylinders (No more than 80% volume liquid change).
 - i) Do not exceed the maximum working pressure of the cylinder, even temporarily.
 - j) When the cylinders have been filled correctly and the process complete, make sure that the cylinders and the equipment are removed from site promptly and all isolation valves on equipment are closed off.
 - k) Recovered refrigerant shall not be changed into another refrigerant system unless it has been cleaned and checked.
-

(*1) Refer to the "Definition of Qualified Installer or Qualified Service Person."

6-8-3. Labelling

- Equipment shall be labelled stating that it has been de-commissioned and emptied of refrigerant.
- The label shall be dated and signed.
- Ensure that are labels on the equipment stating the equipment contains mildly flammable refrigerant.

7. CIRCUIT CONFIGURATION AND CONTROL SPECIFICATIONS

7-1. Outdoor Unit Control

7-1-1. Print Circuit Board, MCC-1705

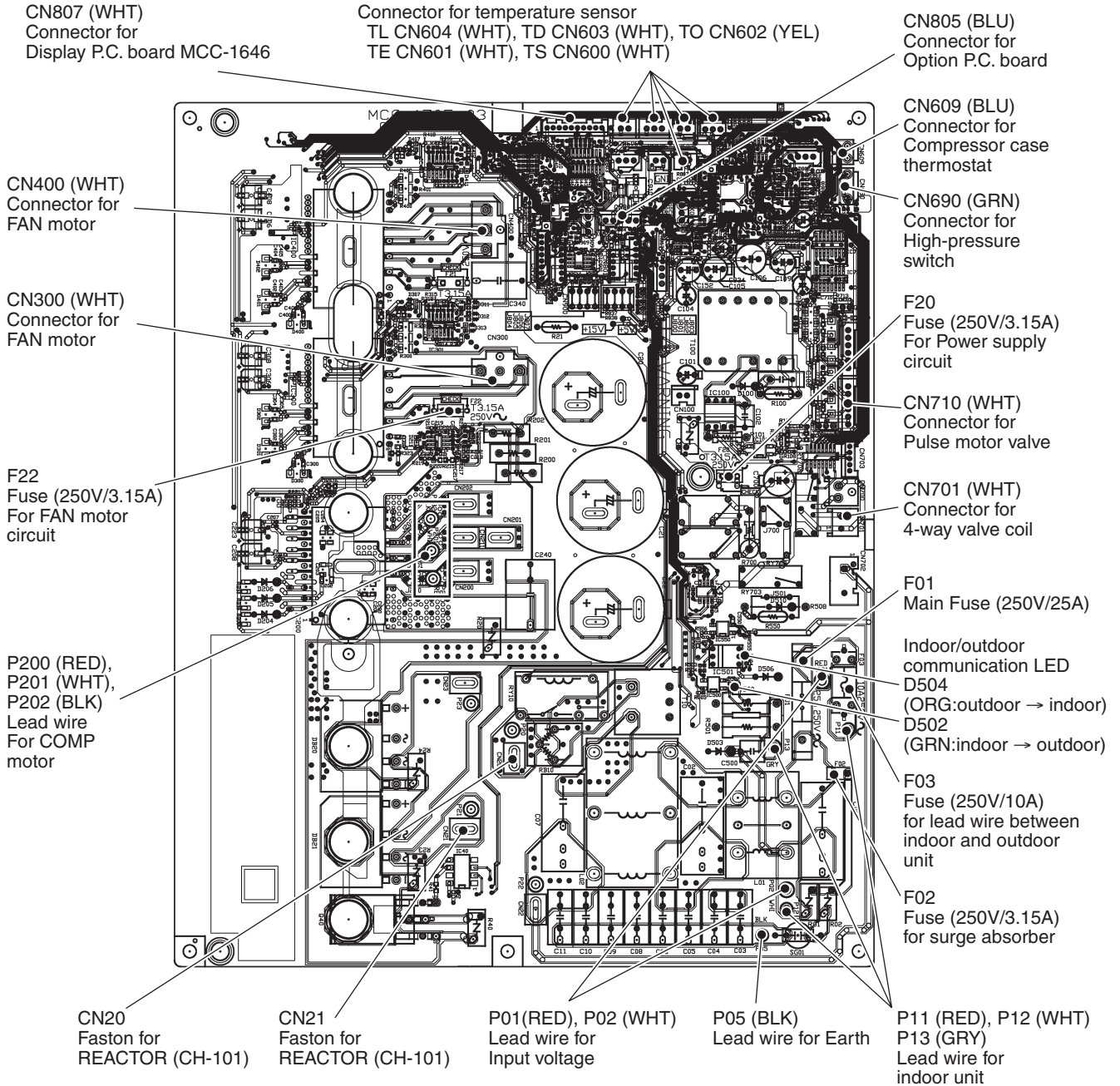

7-2. Outline of Main Controls

1. PMV (Pulse Motor Valve) control

- 1) The aperture of the PMV is controlled between 30 to 500 pulses during operation.
- 2) During cooling operations, the PMV aperture is controlled by the temperature difference between TS sensor and TC sensor, the temperature difference in cooling operations is usually controlled using a 1 to 4K target value.
- 3) During heating operations, the PMV aperture is controlled by the temperature difference between TS sensor and TE sensor, the temperature difference in heating operations is usually controlled using a -1 to 4K target value.
- 4) When the cycle overheats during both cooling and heating operations, the PMV aperture is controlled using a detection value from a TD sensor.
The normal target value is 91°C for cooling operations and 96°C for heating operations.

⚠ CAUTION

Sensor malfunction may cause liquid back-flow or overheating trouble in the compressor resulting in dramatic reduction in the durable life of the compressor.
In the event of malfunction and repair of the compressor, restart operation after checking that there are no trouble in the resistance values or the refrigerating cycle of each sensor.

2. Discharge temperature release control

- 1) This control lowers the revolution number of the compressor in the event that the discharge temperature is not reduced or in the event the discharge temperature increases rapidly during PMV control.
The cycle is stabilized by dividing compressor revolution number control into units up to 0.6 rps.
- 2) When the detected discharge temperature is in a trouble zone, compressor operation is stopped and then restarted after 2 minutes 30 seconds. A trouble count is added on each occasion the trouble zone is detected and when the trouble is detected 4 times, a "P03" trouble is performed. When normal operation continues for a period of 10 minutes, the trouble count is cleared. When the trouble is detected 4 times without the trouble count being cleared, the trouble is recognized so that the operation does not restart.
* An extremely less refrigerant, PMV failure and a cycle clogging etc may cause the malfunction of the operation.
- 3) For the indicated contents of trouble, confirm using the check code lists.

<GP80>

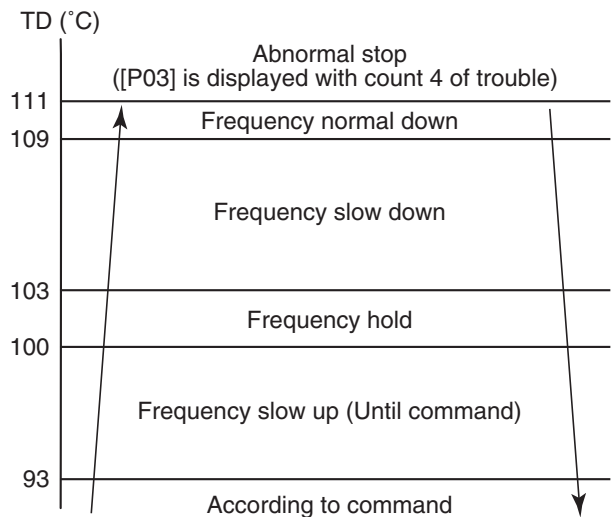

<GP110, 140>

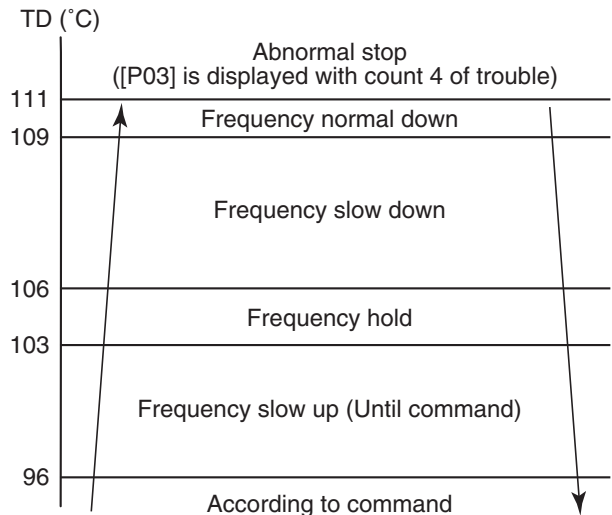

3. Outdoor fan revolution number control

Control of fan revolution number and the fan taps in this unit are shown below.

Fan Taps Revolution number Allocation [rpm]

		W1	W2	W3	W4	W5	W6	W7	W8	W9	WA	WB	WC	WD	WE	WF
GP80		200	200	200	230	260	290	330	360	410	450	480	500	540	570	600
GP110	Upper Fan	200	210	260	290	330	360	400	420	480	520	580	610	650	690	790
GP140	Lower Fan	200	230	280	310	360	390	420	440	500	540	600	630	670	710	810

3-1. Cooling fan control

1) Cooling operations of the outdoor fan are controlled by a TL sensor, TO sensor and the compressor revolution number.

The outdoor fan is controlled by every 1 tap of DC fan control (15 taps).

During startup, operation is fixed for 60 seconds by a maximum fan tap corresponding to the zones shown in the table below. Thereafter fan tap is controlled by a temperature outputted from the TL sensor.

GP80	Less than 20.4rps		20.4rps or more and less than 52 rps		45.0rps or more	
	Min.	Max.	Min.	Max.	Min.	Max.
38°C ≤ TO	W6	WB	W8	WE	WA	WE
29°C ≤ TO < 38°C	W5	WA	W7	WD	W9	WD
15°C ≤ TO < 29°C	W3	W7	W5	W9	W7	WB
5°C ≤ TO < 15°C	W2	W5	W4	W7	W6	W9
0°C ≤ TO < 5°C	W1	W3	W3	W5	W4	W7
-5°C ≤ TO < 0°C	W1	W2	W2	W4	W3	W5
TO < -5°C	OFF	OFF	OFF	W2	OFF	W3
To trouble	OFF	WB	OFF	WE	OFF	WE

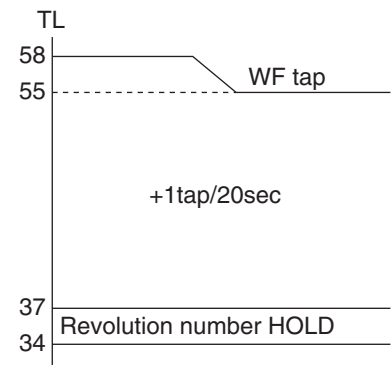

GP110 GP140	Less than 20.4rps		20.4rps or more and less than 52 rps		45.0rps or more	
	Min.	Max.	Min.	Max.	Min.	Max.
38°C ≤ TO	W6	WB	W8	WF	WA	WF
29°C ≤ TO < 38°C	W5	WA	W7	WE	W9	WE
15°C ≤ TO < 29°C	W3	W7	W5	W9	W7	WB
5°C ≤ TO < 15°C	W2	W5	W4	W7	W6	W9
0°C ≤ TO < 5°C	W1	W3	W3	W5	W4	W7
-5°C ≤ TO < 0°C	W1	W2	W2	W4	W3	W5
TO < -5°C	OFF	W1	OFF	W1	W2	W7
To trouble	OFF	WB	OFF	WF	W2	WF

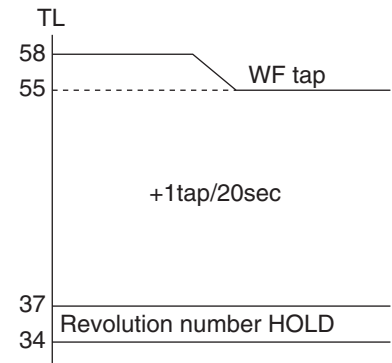

3-2. Heating fan control

- 1) Heating operations of the outdoor fan are controlled by a TE sensor, TO sensor and the compressor revolution number.
(Control from a minimum W1 to a maximum is performed according to the table below).
- 2) Operation is fixed for 3 minutes after start up by a maximum fan tap corresponding to the zones in the table below. Thereafter fan control is performed using the temperature from the TE sensor.
- 3) When $TE \geq 24^{\circ}\text{C}$ continues for 5 minutes, the compressor is stopped. The compressor is placed in the same state as a normal thermostat OFF without a check code display.
The compressor is restarted after approximately 2 minutes 30 seconds and such interrupted operation does not constitute a trouble.
When the operation in 3) above is frequently performed, the filter of the intake section of the indoor unit may require cleaning.
Therefore restart operation after cleaning the filter.

GP80		Less than 38 rps	38rps or more and less than 52rps	52rps or more
Maximum	$10^{\circ}\text{C} \leq \text{TO}$	W7	W8	W9
	$5^{\circ}\text{C} \leq \text{TO} < 10^{\circ}\text{C}$	W9	WB	WD
	$-3^{\circ}\text{C} \leq \text{TO} < 5^{\circ}\text{C}$	WD	WD	WE
	$-10^{\circ}\text{C} \leq \text{TO} < -3^{\circ}\text{C}$	WE	WE	WE
	$\text{TO} < -10^{\circ}\text{C}$	WF	WF	WF
	TO trouble	WF	WF	WF

24	-2 taps/20sec stop timer count (Until W1)
21	-2 taps/20sec (Until W1)
18	-2 taps/20sec (Until W1)
15	Revolution number HOLD
	+1tap /20sec

GP110 GP140		Less than 38 rps	38rps or more and less than 52rps	52rps or more
Maximum	$10^{\circ}\text{C} \leq \text{TO}$	WA	WB	WC
	$5^{\circ}\text{C} \leq \text{TO} < 10^{\circ}\text{C}$	WC	WC	WC
	$-3^{\circ}\text{C} \leq \text{TO} < 5^{\circ}\text{C}$	WC	WC	WE
	$-10^{\circ}\text{C} \leq \text{TO} < -3^{\circ}\text{C}$	WE	WE	WE
	$\text{TO} < -10^{\circ}\text{C}$	WE	WE	WE
	TO trouble	WE	WE	WE

24	-2 taps/20sec stop timer count (Until W1)
21	-2 taps/20sec (Until W1)
18	-2 taps/20sec (Until W1)
15	Revolution number HOLD
	+1tap /20sec

4. Defrost control

- 1) During heating operations, defrost operations are performed when the temperature from the TE sensor satisfies any of the conditions in the A to D zones.
- 2) During defrosting operations, defrost will be terminated if the temperature from the TE sensor continues at 12°C or higher for 3 seconds or if the temperature is 7°C ≤ TE < 12°C for 1 minute. Furthermore the defrost operation will be terminated if defrosting operations have continued for 10 minutes even if TE sensor temperature is less than 7°C.
- 3) After defrost operations have been reset, the compressor restarts heating operations after it stops for 40 seconds.

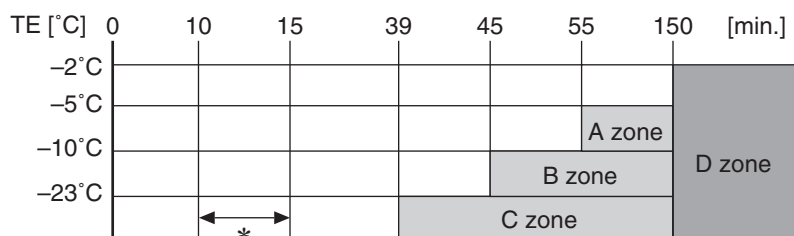

* The minimum TE value during 10 and 15 minutes after starting heating operation is stored as TEO.

	When To is normal	When To is abnormal
A Zone	Status [(TEO-TE) - (ToO-TO) ≥ 3°C] continues for 20 seconds	Status [TEO- TE ≥ 3°C] continues for 20 seconds
B Zone	Status [(TEO-TE) - (ToO-TO) ≥ 2°C] continues for 20 seconds	Status [TEO-TE ≥ 2°C] continues for 20 seconds
C Zone	Status [TE ≥ 23°C] continues for 20 seconds	
D Zone	When compressor operation status TE < 2°C is calculated for 150 minutes	

5. Short interrupted operation preventive control

- 1) Even when a thermostat OFF signal is received from the indoor unit, the compressor may not stop during 3 to 10 minute period after startup in order to protect the compressor. This operation is not a trouble condition. (The continuous operation time for compressor differs depending on the operational status.)
- 2) When operation is terminated by using a remote controller, operation will not continue.

6. Electrical current release control

An AC current detection value from T10 on the control board is used to suppress the revolution number of the compressor so that the input current of the inverter does not exceed a specified value.

A Zone	Normal operation.	
D Zone	Maintain frequency of current operation.	
B Zone	Reduce operating frequency.	
C Zone	Cease reduction of operating frequency and maintain frequency of current operation.	

I1 value (A)	GP80	GP110, 140
Cooling	17.0	20.0
Heating	20.0	20.0

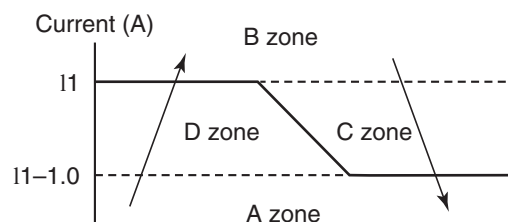

7. Heat sink temperature detection control

- 1) IGBT overheating prevention is protective control performed by a thermistor (TH sensor) in proximity to IGBT.
- 2) When a temperature of TH < 90°C is detected, the fan tap is moved by 1 step up.
Thereafter step-up is performed at a rate of +1 tap/5 seconds until a maximum fan tap is reached.
- 3) After 2) above, operation is returned to normal fan control at a temperature of TH < 85°C.
- 4) Operation of the compressor is terminated at a temperature of TH < 110°C.
- 5) Operation is restarted after 2 minutes and 30 seconds using [1] as the trouble count. However a count of [4] in the same operation confirms a trouble.
The check code display is "P07" (Restart will not be performed).

* When trouble is confirmed, this may be a trouble caused by heat build-up or blower fan failure in the outdoor unit, or a trouble in the IPDU board.

The correction is based on the table below:

8. Electrical current release value shift control

- 1) This control is for the purpose of preventing malfunction of the compressor or electronic components such as the IGBT of the inverter in the compressor drive system during cooling operations.
- 2) Select the current release control value (I1) by TO sensor value from the right table.

Temp. range	GP80	GP110, 140
50°C ≤ TO	8.5	13.6
47°C ≤ TO < 50°C	12.5	13.6
44°C ≤ TO < 47°C	12.5	13.6
39°C ≤ TO < 44°C	16.0	17.1
TO < 39°C	17.0	20.0
TO trouble	8.5	13.6

9. Over-current protective control

- 1) Operation of the compressor is stopped when the over-current protective circuit detects a trouble current.
- 2) The compressor restarts after 2 minutes 30 seconds using [1] as a trouble count.
After restart, the trouble count is cleared when operation continues for 6 minutes or more.
- 3) A trouble is confirmed when the trouble count takes a value of [8], and operation does not restart.
- 4) For the indicated contents of trouble, confirm using the check code table.

10. High-pressure switch/Compressor case thermostat control

- 1) When the high-pressure switch or the compressor case thermostat operates, the operation of the compressor is terminated.
- 2) The compressor restarts after 2 minutes 30 seconds using [1] as a trouble count.
After restart, the trouble count is cleared when operation continues for 10 minutes or more.
- 3) A trouble is confirmed with the trouble count [10].
- 4) For the indicated contents of trouble, confirm on the check code list.

11. High-pressure release control

- 1) The operation frequency is controlled to restrain abnormal rising of high pressure by TL sensor in cooling operation and TC sensor in heating operation.
- 2) When TL sensor in cooling operation or TC sensor in heating operation detects abnormal temperature of the stop zone, the compressor is stopped and the trouble count becomes +1.
- 3) When the compressor stopped with 2), the operation restarts from the point of the normal operation zone (e point or lower) where it returned after 2 minutes 30 seconds.
- 4) The trouble count when the compressor stopped with 2) is cleared after the operation continued for 10 minutes. If the trouble count becomes [10] without being cleared, the trouble is determined and reactivation is not performed.
- 5) For the check code display contents, confirm on the check code list.

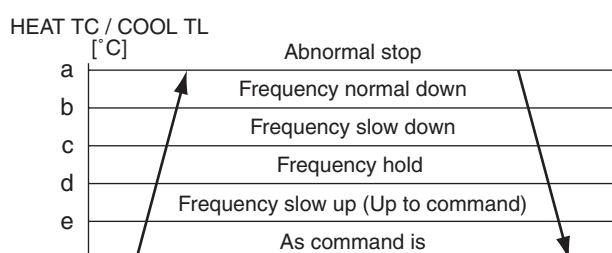

	HEAT	COOL
	TC	TL
a	61°C	62°C
b	56°C	62°C
c	54°C	60°C
d	52°C	58°C
e	48°C	54°C

12. Coil heating control

- 1) This control has the function of heating the compressor by applying a current to the compressor when not operating instead using a case heater.
This control is for the purpose of preventing stagnation of the refrigerant inside the compressor.
- 2) Malfunction in the compressor may result if a current is not applied for a specified time before a test run after installation as was previously the case.
Similarly, starting operation after turning the power OFF and not operating for a long time also requires application of a current before starting operation, in the same manner as the test run.
- 3) Application of current is determined by TD and TO sensors.
When the TO sensor is defective, a backup control is automatically performed by the TE sensor.
When TO sensor is defective, make a determination using the LED display of the outdoor interface board.
- 4) The power is turned off when TD is 30°C or more.

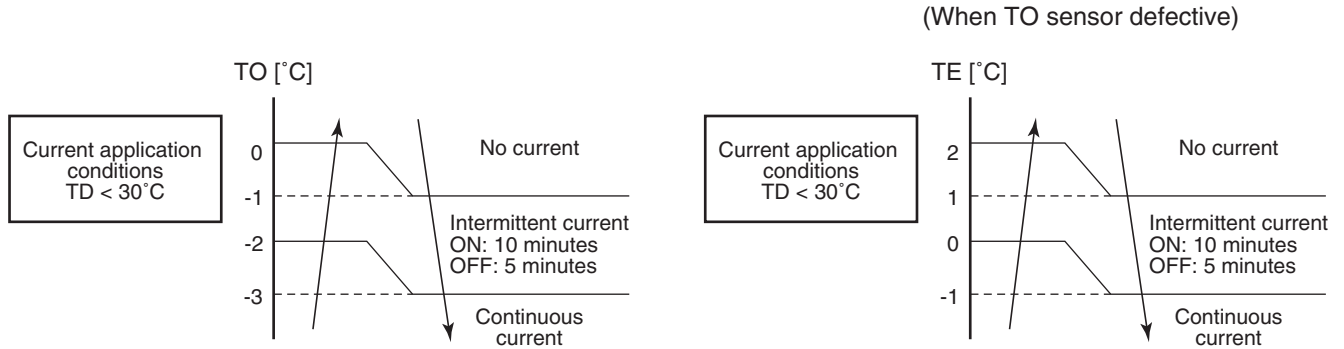

	GP80	GP110, 140
Intermittent current	Corresponding to 40w	Corresponding to 50w
Continuous current	Corresponding to 40w	Corresponding to 50w

(70W : Total power consumption of inverter and compressor)

NOTE

While heating and electrifying the winding wire, electrifying sound may generate. It is no abnormality.

8. TROUBLESHOOTING

8-1. Summary of Troubleshooting

<Wired remote controller type>

1. Before troubleshooting

1) Required tools/instruments

- ⊕ and ⊖ screwdrivers, spanners, long-nose pliers, nippers, push pins for reset switch
- Tester, thermometer, pressure gauge, etc.

2) Confirmation points before check

a) The following operations are normal.

1. Compressor does not operate.

- Is the air conditioner being controlled by the 3-minute protective function?
- Is it in standby status though the room temperature has reached the setup temperature?
- Is it being operated in timer mode or fan mode?
- Is an overflow trouble detected on the indoor unit?
- Is the remote controller set in “heating” under the high outside air temperature?

2. Indoor fan does not operate.

- Is the air conditioner being controlled by the cool air discharge preventive function in “heating”?

3. Outdoor fan does not operate or fan speed changes.

- Does high-temperature release operation control work in heating operation?
- Does outside low-temperature operation control work in cooling operation?
- Is defrost operation performed?

4. ON/OFF operation cannot be performed from remote controller.

- Is it being operated by the central control system?
- Is an automatic address being set up?
(When the power is turned on at the first time or when indoor unit address setting is changed, the operation cannot be performed for maximum approx. 5 minutes after power-ON.)
- Is being carried out a test run by operation of the outdoor unit?

5. LED for the indoor and outdoor communication does not flash.

* service switches (SW01 or SW02) on the outdoor unit allow

- Does standby power saving operation control work?
(LED does flash, when the inside and outside communication is being stopped during the standby power saving control. Operating service switches (SW01 or SW02) on the outdoor unit allow to restart the communication.)

b) Did you return the wiring to the initial positions?

c) Are connecting wiring of indoor unit and remote controller correct?

2. Troubleshooting procedure

When a trouble occurred, check the parts along with the following procedure.



NOTE

For cause of a trouble except the items to be checked, miss diagnosis of microcomputer due to outer noise or power conditions is considered. If there is any noise source, change the wires of the remote controller to shield wires.

<Wireless remote controller type>

1. Before troubleshooting

1) Required tools/instruments

- ⊕ and ⊖ screwdrivers, spanners, long-nose pliers, nippers, etc.
- Tester, thermometer, pressure gauge, etc.

2) Confirmation points before check

a) The following operations are normal.

1. Compressor does not operate.

- Is the air conditioner being controlled by the 3-minute protective function?
- Is it in standby status though the room temperature has reached the setup temperature?
- Is it being operated in timer mode or fan mode?
- Is the remote controller set in “heating” under the high outside air temperature?

2. Indoor fan does not operate.

- Is the air conditioner being controlled by the cool air discharge preventive function in “heating”?

3. Outdoor fan does not operate or fan speed changes.

- Does high-temperature release operation control work in heating operation?
- Does outside low-temperature operation control work in cooling operation?
- Is defrost operation performed?

4. ON/OFF operation cannot be performed from remote controller.

- Is the air conditioner in forced operation?
- Is it being operated by the central control system?
- Is an automatic address being set up?
(When the power is turned on at the first time or when indoor unit address setting is changed, the operation cannot be performed for maximum approx. 5 minutes after power-ON.)
- Is a test run of the air conditioner being carried out?

5. LED for the indoor and outdoor communication does not flash.

- * LED is placed on the outdoor unit control board. (CDB P.C. board)
- Does standby power saving operation control work?

(LED does flash, when the inside and outside communication is being stopped during the standby power saving control. Operating service switches (SW01 or SW02) on the outdoor unit allow to restart the communication.)

b) Did you return the wiring to the initial positions?

c) Are connecting wires between indoor unit and receiving unit correct?

2. Troubleshooting procedure



When a trouble occurred, check the parts along with the following procedure.

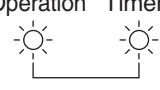
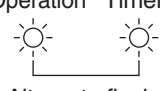
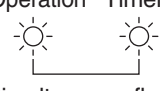
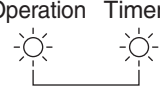
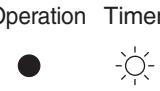
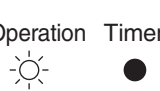
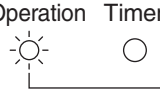

Lamp indication	Check code	Cause of trouble occurrence
Operation Timer Ready  Alternate flash	F01	Heat exchanger sensor (TCJ) trouble Heat exchanger sensor (TC) trouble Room air temperature sensor (TA) trouble } Indoor unit sensor trouble
	F02	
	P10	
Operation Timer Ready  Alternate flash	F04	Discharge temp. sensor (TD) trouble Temp. sensor (TE) trouble Temp. sensor (TL) trouble Temp. sensor (TO) trouble Temp. sensor (TS) trouble Temp. sensor (TH) trouble Temp. sensor miswiring (TE, TS) } Sensor trouble of outdoor unit *1
	F06	
	F07	
	F08	
	F12	
	F13	
	F15	
Operation Timer Ready  Simultaneous flash	F29	Indoor EEPROM trouble
Operation Timer Ready  Simultaneous flash	F31	Outdoor EEPROM trouble
Operation Timer Ready  Flash	H01	Compressor break down Compressor lock Current detection circuit trouble Case thermostat worked. PS pressure sensor trouble low pressure protective operation } Outdoor compressor system trouble *1 } Power supply, outdoor P.C. board trouble } Compressor overheat, outdoor wiring trouble Outdoor unit low pressure system trouble
	H02	
	H03	
	H04	
	H06	
Operation Timer Ready  Simultaneous flash	L03	Duplicated header indoor units There is indoor unit of group connection in individual indoor unit. Unsetting of group address Missed setting (Unset indoor capacity) } → AUTO address * If group construction and address are not normal when power supply turned on, automatically goes to address setup mode.
	L07	
	L08	
	L09	
Operation Timer Ready  Simultaneous flash	L10	Unset model type (Service board)
	L20	Duplicated indoor central addresses
	L29	Outdoor unit and other trouble
	L30	Outside interlock trouble
	L31	Negative phase trouble

*1: These are representative examples and the check code differs according to the outdoor unit to be combined.

8-2-2. Others (Other than Check Code)

Lamp indication	Check code	Cause of trouble occurrence
Operation Timer Ready  Simultaneous flash	—	During test run
Operation Timer Ready  Alternate flash	—	Disagreement of cool/heat (Automatic cool/heat setting to automatic cool/heat prohibited model, or setting of heating to cooling-only model)

8-2-3. Monitor Function of Remote Controller Switch

■ Calling of sensor temperature display

<Contents>

Each data of the remote controller, indoor unit and outdoor unit can be understood by calling the service monitor mode from the remote controller.

<Procedure>

1 Push **TEST** + **CL** buttons simultaneously for 4 seconds to call the service monitor mode.

The service monitor goes on, the header indoor unit No. is displayed at first and then the temperature of CODE No. 00 is displayed.



2 Push temperature set **TEMP.** buttons and then change the CODE No. of data to be monitored.

The CODE No. list is shown below.

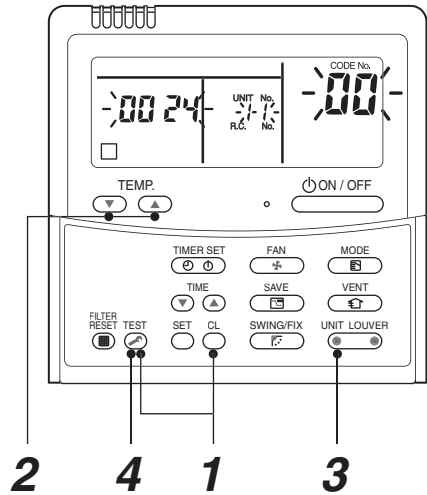

<Operation procedure>

1 → 2 → 3 → 4

Returned to usual display

	CODE No.	Data name	Unit
Indoor unit data	01	Room temperature (Remote controller)	°C
	02	Indoor room air temperature (TA)	°C
	03	Indoor heat exchanger (Coil) temperature (TCJ)	°C
	04	Indoor heat exchanger (Coil) temperature (TC)	°C
	07	Indoor fan revolution frequency	rpm
	F2	Indoor fan calculated operation time	×100h
	F3	Indoor unit fan cumulative operating hours	×1h
	F8	Indoor discharge temperature	°C

	CODE No.	Data name	Unit
Outdoor unit data	60	Outdoor heat exchanger (Coil) temperature (TE)	°C
	61	Outside temperature (TO)	°C
	62	Compressor discharge temperature (TD)	°C
	63	Compressor suction temperature (TS)	°C
	65	Heat sink temperature (THS)	°C
	6A	Operation current (× 1/10)	A
	6D	Outdoor heat exchanger (Coil) temperature (TL)	°C
	70	Compressor operation frequency	rps
	72	Outdoor fan revolution frequency (Lower)	rpm
	73	Outdoor fan revolution frequency (Upper)	rpm
	F1	Compressor calculated operation time	×100h



3 Push **UNIT LOUVER** button to select the indoor unit to be monitored. Each data of the indoor unit and its outdoor units can be monitored.



4 Pushing **TEST** button returns the status to the usual display.

*1 The indoor discharge temperature of CODE No. [F8] is the estimated value from TC or TCJ sensor. Use this value to check discharge temperature at test run. (A discharge temperature sensor is not provided to this model.)

- The data value of each item is not the real time, but value delayed by a few seconds to ten-odd seconds.

8-2-4. Check Code List (Outdoor)

○: Go on, ⊙: Flash, ●: Go off
 ALT (Alternate); Alternate flashing when there are two flashing LED SIM (Simultaneous); Simultaneous flashing when there are two flashing LED

Remote controller indication	Sensor lamp part Block indication		Representative trouble position	Detection	Explanation of trouble contents	Automatic reset	Operation continuation
	Operation	Timer Ready					
F04	⊙	⊙	Outdoor unit Discharge temp. sensor (TD) trouble	Outdoor	Open/Short-circuit of discharge temp. sensor was detected.	—	—
F06	⊙	⊙	Outdoor unit Temp. sensor (TE, TS, TL) trouble	Outdoor	Open/Short-circuit of heat exchanger temp. sensor was detected. Miswiring between TE sensor and TS sensor	—	—
F08	⊙	⊙	Outdoor unit Outside temp. sensor (TO) trouble	Outdoor	Open/Short-circuit of outside temp. sensor was detected.	✓	—
F07	⊙	⊙	Outdoor unit Temp. sensor (TL) trouble	Outdoor	Open/Short-circuit of heat exchanger temp. sensor was detected.	—	—
F12	⊙	⊙	Outdoor unit Temp. sensor (TS) trouble	Outdoor	Open/Short-circuit of suction temp. sensor was detected.	—	—
F13	⊙	⊙	Outdoor unit Temp. sensor (TH) trouble	Outdoor	Open/Short-circuit of heat sink temp. sensor (Board installed) was detected.	—	—
F15	⊙	⊙	Outdoor unit Misconnection of temp. sensor (TE, TS)	Outdoor	Misconnection of outdoor heat exchanger temp. sensor and suction temp. sensor was detected.	—	—
F31	⊙	⊙	Outdoor unit EEPROM trouble	Outdoor	Outdoor P.C. board part (EEPROM) trouble was detected.	—	—
H01	●	●	Outdoor unit Compressor break down	Outdoor	When reached min-Hz by current release control, short-circuited current (I _{dc}) after DC excitation was detected.	—	—
H02	●	●	Outdoor unit Compressor lock	Outdoor	Compressor lock was detected.	—	—
H03	●	●	Outdoor unit Current detection circuit trouble	Outdoor	Current detection circuit trouble	—	—
H04	●	●	Outdoor unit Case thermostat operation	Outdoor	Case thermostat operation was detected.	—	—
L10	⊙	⊙	Outdoor unit Setting trouble of service P.C. board type	Outdoor	When outdoor service P.C. board was used, model type select jumper setting was inappropriate.	—	—
L29	⊙	⊙	Outdoor unit Other outdoor unit trouble	Outdoor	1) Defective parts on outdoor P.C. board (MCU communication, EEPROM, TH sensor trouble) 2) When outdoor service P.C. board was used, model type selection was inappropriate. 3) Other trouble (Heat sink abnormal overheating, gas leak, 4-way valve inverse trouble) was detected.	—	—
P03	⊙	●	Outdoor unit Discharge temp. trouble	Outdoor	Trouble was detected by discharge temp. release control.	—	—
P04	⊙	●	Outdoor unit High pressure system trouble, Power supply voltage trouble	Outdoor	When case thermostat worked, trouble was detected by high release control from indoor/outdoor heat exchanger temp. sensor. Power supply voltage trouble	—	—
P05	⊙	●	Power supply trouble	Outdoor	Power supply voltage trouble	—	—
P07	⊙	●	Outdoor unit Heat sink overheating	Outdoor	Abnormal overheating was detected by outdoor heat sink temp. sensor.	—	—
P15	⊙	●	Gas leak detection	Outdoor	Abnormal overheating of discharge temp. or suction temp. was detected.	—	—
P20	⊙	●	Outdoor unit High pressure system trouble	Outdoor	Trouble was detected by high release control from indoor/outdoor heat exchanger temp. sensor.	—	—
P22	⊙	●	Outdoor unit Outdoor fan trouble	Outdoor	Trouble (Over-current, lock, etc.) was detected on outdoor fan drive circuit.	—	—
P26	⊙	●	Outdoor unit Inverter Idc operation	Outdoor	Short-circuited protective operation of compressor drive circuit element (G-Tr./IGBT) worked.	—	—
P29	⊙	●	Outdoor unit Position detection trouble	Outdoor	Position detection trouble of compressor motor was detected.	—	—
E01	⊙	●	No remote controller header unit Remote controller communication trouble	Remote controller	Signal was not received from indoor unit. Master remote controller was not set. (including 2 remote controllers)	—	—
E02	⊙	●	Remote controller send trouble	Remote controller	Signal cannot be sent to indoor unit.	—	—
E03	⊙	●	Regular communication trouble between indoor and remote controller	Indoor	No communication from remote controller and network adapter	✓	—
E04	●	●	Indoor/Outdoor serial trouble	Indoor	Serial communication trouble between indoor and outdoor	✓	—
E08	⊙	●	Duplicated indoor addresses	Indoor	Same address as yours was detected.	✓	—
E09	⊙	●	Duplicated master remote controllers	Remote controller	In 2-remote controller control, both were set as header (Indoor header unit stops warning and follower unit continues operation.)	—	—
E10	⊙	●	Communication trouble between CPU	Indoor	MCU communication trouble between main motor and micro computer	✓	△
E18	⊙	●	Regular communication trouble between header and follower indoor units	Indoor	Regular communication was impossible between header and follower indoor units. Communication between twin header (Master unit) and follower (sub unit) was impossible.	✓	—
L03	⊙	●	Duplicated indoor header units	Indoor	There are multiple header units in a group.	—	—
L07	⊙	●	There are group cable in individual indoor unit.	Indoor	When even one group connection indoor unit exists in individual indoor unit.	—	—
L08	⊙	●	Unset indoor group address	Indoor	Indoor address group was unset.	—	—
L09	⊙	●	Unset indoor capacity	Indoor	Capacity of indoor unit was unset.	—	—
L30	⊙	●	Outside trouble input to indoor unit (Interlock)	Indoor	Abnormal stop by CN80 outside trouble input	—	—
P19	⊙	●	4-way valve inverse trouble	Indoor Outdoor	In heating operation, trouble was detected by temp. down of indoor heat exchanger or temp. up of TE, TS.	✓	—

✧ When this warning was detected before group construction/address check finish at power supply was turned on, the mode shifts automatically to AUTO address setup mode.
 △: It is based on a situation.

ALT (Alternate): Alternate flashing when there are two flashing LED SIM (Simultaneous): Simultaneous flashing when there are two flashing LED

○: Go on, ⊙: Flash, ●: Go off

Remote controller indication	Sensor lamp part			Representative trouble position	Detection	Explanation of trouble contents	Automatic reset	Operation continuation
	Block indication	Timer	Ready					
F01	⊙	⊙	●	Indoor unit Heat exchanger sensor (TC-U) trouble	Indoor	Open/Short-circuit of heat exchanger (TC-U) was detected.	✓	—
F02	⊙	⊙	●	Indoor unit Heat exchanger sensor (TC) trouble	Indoor	Open/Short-circuit of heat exchanger (TC) was detected.	✓	—
F10	⊙	⊙	●	Indoor unit Room air temp. sensor (TA) trouble	Indoor	Open/Short-circuit of room air temp. (TA) was detected.	✓	—
F29	⊙	⊙	●	Indoor unit Other indoor P.C. board trouble	Indoor	EEPROM trouble (Other trouble may be detected. If no trouble, automatic address is repeated.)	—	—
P01	●	⊙	⊙	Indoor unit indoor fan trouble	Indoor	Indoor AC fan trouble was detected. (Fan thermal relay worked.)	—	—
P10	●	⊙	⊙	Indoor unit Overflow detection	Indoor	Float switch worked.	—	—
P12	●	⊙	⊙	Indoor unit indoor fan trouble	Indoor	Indoor fan trouble (Over-current / Lock, etc.) was detected.	—	—
P31	⊙	●	⊙	Other indoor unit trouble	Indoor	Other indoor under condition of warning in group. E03/L07/L03/L08 warning	✓	—
—	By unit with warning No.			Trouble in indoor group	Network adapter	Sub remote controller trouble in a group (Details of remote controller are displayed with unit No. Only central control side is displayed.)	—	—
—	—	—	—	LAN system communication trouble	Network adapter/ Center	Communication trouble of central control system signal * is not displayed on the remote controller	✓	✓
L20	⊙	○	⊙	LAN system communication trouble	Network adapter/ Center	Duplicated indoor address of central control system communication	✓	—
—	—	—	—	There are multiple communication adapters.	Network adapter	There are multiple communication adapters on remote controller communication line.	✓	✓

Failure mode detected by indoor unit

Operation of diagnostic function				Judgment and measures
Check code	Cause of operation	Status of air conditioner	Condition	
E03	No communication from remote controller (including wireless) and communication adapter	Stop (Automatic reset)	Displayed when trouble is detected	1. Check cables of remote controller and communication adapters. • Remote controller LCD display OFF (Disconnection) • Central remote controller [97] check code
E04	The serial signal is not output from outdoor unit to indoor unit. • Miswiring of inter-unit wire • Serial communication circuit trouble of outdoor P.C. board • Serial communication circuit trouble of indoor P.C. board	Stop (Automatic reset)	Displayed when trouble is detected	1. Outdoor unit does not completely operate. • Inter-unit wire check, correction of miswiring • Check outdoor P.C. board. Correct wiring of P.C. board. 2. When outdoor unit normally operates • Check P.C. board (Indoor receiving / Outdoor sending).
E08	Duplicated indoor unit address	Stop	Displayed when trouble is detected	1. Check whether remote controller connection (Group/Individual) was changed or not after power supply turned on (Finish of group construction/Address check). * If group construction and address are not normal when the power has been turned on, the mode automatically shifts to address setup mode. (Resetting of address)
L03	Duplicated indoor header unit			
L07	There is group wire in individual indoor unit.			
L08	Unset indoor group address			
L09	Unset indoor capacity	Stop	Displayed when trouble is detected	1. Set indoor capacity (DN=11)
L30	Abnormal input of outside interlock	Stop	Displayed when trouble is detected	1. Check outside devices. 2. Check indoor P.C. board.
P10	Float switch operation • Float circuit, Disconnection, Coming-off, Float switch contact trouble	Stop	Displayed when trouble is detected	1. Trouble of drain pump 2. Clogging of drain pump 3. Check float switch. 4. Check indoor P.C. board.
P12	Indoor DC fan trouble	Stop	Displayed when trouble is detected	1. Position detection trouble 2. Over-current protective circuit of indoor fan driving unit operated. 3. Indoor fan locked. 4. Check indoor P.C. board.
P19	4-way valve system trouble • After heating operation has started, indoor heat exchangers temp. is down.	Stop (Automatic reset)	Displayed when trouble is detected	1. Check 4-way valve. 2. Check 2-way valve and check valve. 3. Check indoor heat exchanger (TC/TCJ). 4. Check indoor P.C. board.
P31	Unit automatically stops while warning is output to other indoor units.	Stop (Follower unit) (Automatic reset)	Displayed when trouble is detected	1. Judge follower unit while header unit is [E03], [L03], [L07] or [L08]. 2. Check indoor P.C. board.
F01	Coming-off, disconnection or short-circuit of indoor heat exchanger temp. sensor (TCJ)	Stop (Automatic reset)	Displayed when trouble is detected	1. Check indoor heat exchanger temp. sensor (TCJ). 2. Check indoor P.C. board.
F02	Coming-off, disconnection or short-circuit of indoor heat exchanger temp. sensor (TC)	Stop (Automatic reset)	Displayed when trouble is detected	1. Check indoor heat exchanger temp. sensor (TC). 2. Check indoor P.C. board.
F10	Coming-off, disconnection or short-circuit of indoor room air temp. sensor (TA)	Stop (Automatic reset)	Displayed when trouble is detected	1. Check indoor room air temp. sensor (TA). 2. Check indoor P.C. board.
F29	Indoor EEPROM trouble • EEPROM access trouble	Stop (Automatic reset)	Displayed when trouble is detected	1. Check indoor EEPROM. (including socket insertion) 2. Check indoor P.C. board.
E10	Communication trouble between indoor MCU • Communication trouble between fan driving MCU and main MCU	Stop (Automatic reset)	Displayed when trouble is detected	1. Check indoor P.C. board.
E18	Regular communication trouble between indoor header and follower units and between master and sub units	Stop (Automatic reset)	Displayed when trouble is detected	1. Check remote controller wiring. 2. Check indoor power supply wiring. 3. Check indoor P.C. board.

Failure mode detected by outdoor unit

Operation of diagnostic function				Judgment and measures
Check code Indoor unit	Cause of operation	Status of air conditioner	Condition	
F04	Disconnection, short-circuit of discharge temp. sensor (TD)	Stop	Displayed when trouble is detected	1. Check discharge temp. sensor (TD). 2. Check outdoor P.C. board (MCC-1705).
F06	Disconnection, short-circuit of outdoor temp. sensor (TE)	Stop	Displayed when trouble is detected	1. Check temp. sensor (TE). 2. Check outdoor P.C. board (MCC-1705).
F07	Disconnection, short-circuit of outdoor temp. sensor (TL)	Stop	Displayed when trouble is detected	1. Check temp. sensor (TL). 2. Check outdoor P.C. board (MCC-1705).
F12	Disconnection, short-circuit of suction temp. sensor (TS)	Stop	Displayed when trouble is detected	1. Check suction temp. sensor (TS). 2. Check outdoor P.C. board (MCC-1705).
F15	Miss-mounting of outdoor temp. sensor (TE, TS)	Stop	Displayed when trouble is detected	1. Check temp. sensor (TE, TS). 2. Check outdoor P.C. board (MCC-1705).
F08	Disconnection, short-circuit of outside temp. sensor (TO)	Continue	Displayed when trouble is detected	1. Check outside temp. sensor (TO). 2. Check outdoor P.C. board (MCC-1705).
F13	Disconnection, short-circuit of heat sink temp. sensor (TH)	Stop	Displayed when trouble is detected	1. Check outdoor P.C. board (MCC-1705). (Q201 is incorporated in TH sensor.)
F31	Outdoor P.C. EEPROM trouble	Stop	Displayed when trouble is detected	1. Check outdoor P.C. board (MCC-1705).
L10	Unset jumper of service P.C. board	Stop	Displayed when trouble is detected	1. Outdoor service P.C. board Check model type setting jumper wire.
L29	Communication trouble between outdoor P.C. board MCU	Stop	Displayed when trouble is detected	1. Check outdoor P.C. board (MCC-1705).
P07	Heat sink overheat trouble * Heat sink temp. sensor detected over specified temperature.	Stop	Displayed when trouble is detected	1. Check screw tightening between PC. Board and heat sink and check radiator grease (MCC-1705). 2. Check heat sink blast path.
P15	Detection of gas leak * Discharge temp. sensor (TD), Suction temp. sensor (TS) detected temperature over specified temp.	Stop	Displayed when trouble is detected	1. Check gas leak, recharge 2. Check full open of service valve. 3. Check PMV (Pulse Motor Valve). 4. Check broken pipe. 5. Check discharge temp. sensor (TD), suction temp. sensor (TS).
P19	4-way valve inverse trouble * After heating operation has started, indoor heat exchanger temp. lowers under the specified temp. * After heating operation has started, outdoor heat exchanger / suction temp. rises over the specified temp.	Stop	Displayed when trouble is detected	1. Check operation of 4-way valve. 2. Check outdoor heat exchanger (TE), suction temp. sensor (TS). 3. Check indoor heat exchanger sensor (TC). 4. Check 4-way valve coil. 5. Check PMV (Pulse Motor Valve).
H01	Compressor break down * Although operation has started, operation frequency decreases and operation stops.	Stop	Displayed when trouble is detected	1. Check power supply voltage. (AC198 to 264V) 2. Overload operation of refrigerating cycle
H02	Compressor lock * Over-current detection after compressor start-up	Stop	Displayed when trouble is detected	1. Trouble of compressor (Lock, etc.): Replace compressor. 2. Wiring trouble of compressor (Open phase)
H03	Current detection circuit trouble	Stop	Displayed when trouble is detected	1. Check outdoor P.C. board (MCC-1705). (AC current detection circuit)
F23	Ps sensor trouble	Stop	Displayed when trouble is detected	1. Check connection of Ps sensor connector. 2. Check failure of Ps sensor. 3. Check compressing power trouble of compressor. 4. Check 4-way valve trouble. 5. Check outdoor P.C. board trouble.

Operation of diagnostic function				Judgment and measures
Check code	Cause of operation	Status of air conditioner	Condition	
Indoor unit				
P03	Discharge temp. trouble * Discharge temp. (TD) over specified value was detected.	Stop	Displayed when trouble is detected	1. Check refrigerating cycle (Gas leak) 2. Trouble of electronic expansion valve 3. Check discharge temp. sensor (TD).
H04	Case thermostat operation * Abnormal overheat of compressor	Stop	Displayed when trouble is detected	1. Check case thermostat and connector. 2. Check gas leak, recharge 3. Check full open of service valve. 4. Check PMV (Pulse Motor Valve). 5. Check broken pipe.
P04	High pressure SW system trouble	Stop	Displayed when trouble is detected	1. Check service valves are fully opened. (Gas side, Liquid side) 2. Check of outdoor fan operation. 3. Check motor trouble of outdoor fan. 4. Check clogging of outdoor PMV. 5. Check clogging of heat exchanger in indoor/outdoor units. 6. Short-circuit status of suction/discharge air in outdoor unit. 7. Check outdoor P.C. board trouble. 8. Check fan system trouble (Cause of air volume drop) at indoor side. 9. Check PMV opening status in indoor unit.
P05	Power supply voltage trouble	Stop	Displayed when trouble is detected	1. Check power supply voltage. AC198 to 264V
	High pressure SW system trouble	Stop	Displayed when trouble is detected	1. Check service valves are fully opened. (Gas side, Liquid side) 2. Check of outdoor fan operation. 3. Check motor trouble of outdoor fan. 4. Check clogging of outdoor PMV. 5. Check clogging of heat exchanger in indoor/outdoor units. 6. Short-circuit status of suction/discharge air in outdoor unit. 7. Check outdoor P.C. board trouble. 8. Check fan system trouble (Cause of air volume drop) at indoor side. 9. Check PMV opening status in indoor unit.
P20	High pressure protective operation * During cooling operation, outdoor temp. sensor (TL) detected temperature over specified temp. * During heating operation, indoor temp. sensor (TC, TCJ) detected temperature over specified temp.	Stop	Displayed when trouble is detected	1. Check outdoor heat exchanger sensor (TL). 2. Check indoor heat exchanger sensor (TC, TCJ). 3. Check full open of service valve. 4. Check indoor/outdoor fan. 5. Check PMV (Pulse Motor Valve). 6. Check clogging and short-circuit of indoor/outdoor heat exchanger. 7. Overcharge of refrigerant. Recharge
P22	Outdoor fan system trouble	Stop	Displayed when trouble is detected	1. Check lock of fan motor. 2. Check power supply voltage between L2 and N. AC198 to 264V 3. Check outdoor P.C. board.
P26	Short-circuit trouble of compressor driving element	Stop	Displayed when trouble is detected	1. When performing operation while taking-off compressor wire, P26 trouble occurs. Check control P.C. board (MCC-1705). 2. When performing operation while taking-off compressor wire, an trouble does not occur. (Compressor layer short-circuit)
P29	Position detection circuit trouble	Stop	Displayed when trouble is detected	1. Check control P.C. board (MCC-1705).

Failure mode detected by remote controller or central controller (TCC-LINK)

Operation of diagnostic function				Judgment and measures
Check code	Cause of operation	Status of air conditioner	Condition	
Not displayed at all (Operation on remote controller is impossible.)	No communication with header indoor unit <ul style="list-style-type: none"> Remote controller wiring is not correct. Power of indoor unit is not turned on. Automatic address cannot be completed. 	Stop	—	Power supply trouble of remote controller, Indoor EEPROM trouble <ol style="list-style-type: none"> 1. Check remote controller inter-unit wiring. 2. Check remote controller. 3. Check indoor power wiring. 4. Check indoor P.C. board. 5. Check indoor EEPROM. (including socket insertion) → Automatic address repeating phenomenon generates.
E01 *1	No communication with header indoor unit <ul style="list-style-type: none"> Disconnection of inter-unit wire between remote controller and header indoor unit (Detected by remote controller side) 	Stop (Automatic reset) * If central controller exists, operation continues.	Displayed when trouble is detected	Receiving trouble from remote controller <ol style="list-style-type: none"> 1. Check remote controller inter-unit wiring. 2. Check remote controller. 3. Check indoor power wiring. 4. Check indoor P.C. board.
E02	Signal send trouble to indoor unit (Detected by remote controller side)	Stop (Automatic reset) * If central controller exists, operation continues.	Displayed when trouble is detected	Sending trouble of remote controller <ol style="list-style-type: none"> 1. Check sending circuit inside of remote controller. → Replace remote controller.
E09	There are multiple master remote controllers. (Detected by remote controller side)	Stop (Follower unit continues operation.)	Displayed when trouble is detected	1. In 2-remote controllers (including wireless), there are multiple header units. Check that there are 1 master remote controller and other sub remote controllers.
L20 ----- Central controller L20	Duplicated indoor central addresses on communication of central control system (Detected by indoor/central controller side)	Stop (Automatic reset)	Displayed when trouble is detected	1. Check setting of central control system network address. (Network adapter SW01) 2. Check network adapter P.C. board.
— *2 ----- Central controller (Send) C05 (Receive) C06	Communication circuit trouble of central controller (Detected by central controller side)	Continues (By remote controller)	Displayed when trouble is detected	1. Check communication wire / miswiring 2. Check communication (U3, U4 terminals) 3. Check network adapter P.C. board. 4. Check central controller (such as central control remote controller, etc.) 5. Check terminal resistance. (TCC-LINK)
— ----- Central controller P30	Indoor Gr sub unit trouble (Detected by central controller side)	Continuation/Stop (According to each case)	Displayed when trouble is detected	Check the check code of the corresponding unit from remote controller.

*1 The check code cannot be displayed by the wired remote controller.
(Usual operation of air conditioner becomes unavailable.)

For the wireless models, a trouble is notified with indication lamp.

*2 This trouble is related to communication of remote controller (A, B), central system (TCC-LINK U3, U4), and [E01], [E02], [E03], [E09] or [E18] is displayed or no check display on the remote controller according to the contents.

8-2-5. Diagnostic Procedure for Each Check Code (Outdoor Unit)

- 1) This section describes the diagnostic method for each check code displayed on the wired remote controller.
- 2) In some cases, a check code indicates multiple symptoms.
In this case, confirm LED display on the outdoor P.C. board to narrow the contents to be confirmed.
- 3) The check code on the remote controller is displayed only when the same trouble occurred continuously by multiple times while LED of the outdoor P.C. board displays even an trouble which occurred once.
Therefore the display on the remote controller may differ from that of LED.

How to check LED display on the outdoor P.C. board

[Service switch operation]

Currently occurring trouble indication

Even if only one of D800 to D804 is rapidly flashing then trouble has arisen. If any of D800 to D801 is slowly flashing or D805 is flashing then press and hold down SW01 and SW02 at the same time for at least 5 seconds.

D800 (YEL)	D801 (YEL)	D802 (YEL)	D803 (YEL)	D804 (YEL)	D805 (GRN)	
●	●	●	●	●	○	No trouble
◎	●	●	●	●	○	Trouble detected (Example. Discharge temp. trouble)

● : Go OFF ○ : Go ON ◎ : Flash (5 times/sec)

Latest trouble indication









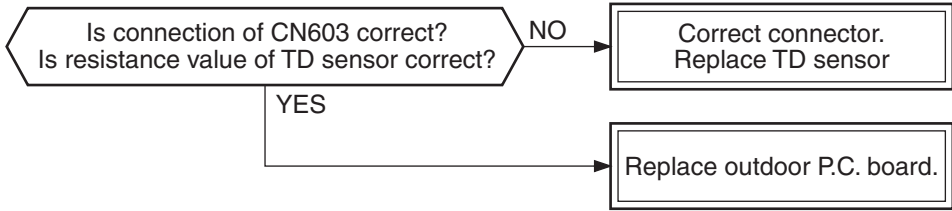

- The following operation results in the latest trouble being indicated. It is retained in the memory and hence can be confirmed even when the power supply has been turned off. (Excluding outside air temperature sensor (TO) trouble)
 - 1) Confirm D800 to D804 are off (or rapidly flashing) and that D805 is lit up. If D800 to D804 are slowly flashing or D805 is flashing then push and hold down SW01 and SW02 at the same time for at least 5 seconds. D800 to D804 will turn off (or be rapidly flashing) and D805 will change to flashing.
 - 2) Push and hold down SW01 for at least 5 seconds. D804 will start slowly flashing.
 - 3) Push SW01 several times until reaching the LED indication (D800 to D804) of 'Latest (including current) trouble indication'.
 - 4) Push SW02. The latest trouble will be indicated.
 - 5) Ensure to carry out step 1) to set the LEDs to the initial state (current occurring trouble) when finished and then exit.

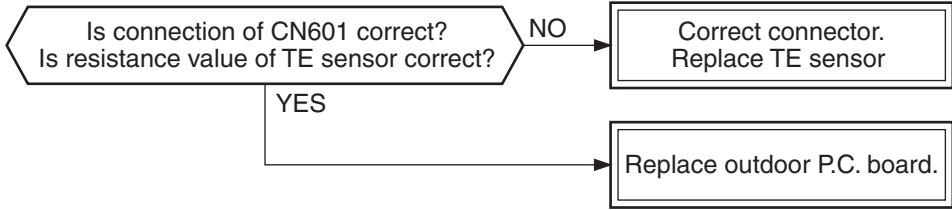
Latest (including current) trouble indication

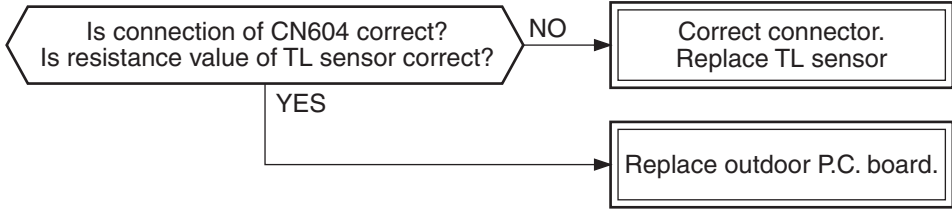
D800 (YEL)	D801 (YEL)	D802 (YEL)	D803 (YEL)	D804 (YEL)	D805 (GRN)
○	●	●	●	●	◎

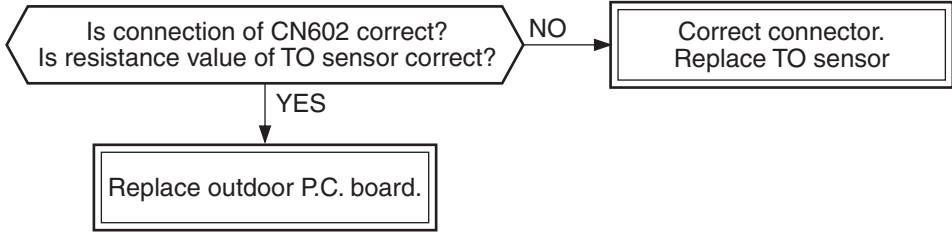
● : Go OFF ○ : Go ON ◎ : Flash (5 times/sec)

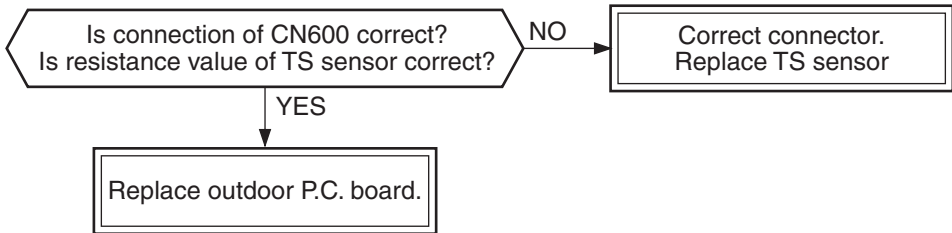
Check code	Outdoor LED display	Check and troubleshooting (Item without special mention indicates part of outdoor unit.)
[E04]	—	<p>[Indoor/Outdoor communication trouble]</p> <pre> graph TD Q1{{Is setting of group address of remote controller correct?}} -- NO --> A1[Check "check code [14]".] Q1 -- YES --> Q2{{Are inner wiring of indoor unit and inter-unit wires (1, 2, 3) correct?}} Q2 -- NO --> A2[Correct wiring and inter-unit wires.] Q2 -- YES --> Q3{{Are connection and wiring of terminal blocks (1, 2, 3) correct?}} Q3 -- NO --> A3[Correct wiring of connectors and terminal blocks.] Q3 -- YES --> A4[Replace control P.C. board.] </pre>

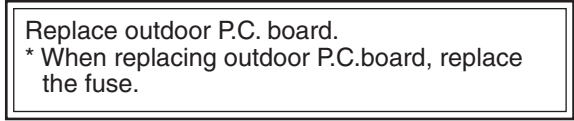
Check code	Outdoor LED display	Check and troubleshooting (Item without special mention indicates part of outdoor unit.)
[F04]		<p data-bbox="448 230 906 264">[Discharge temp. sensor (TD) trouble]</p> <div data-bbox="459 286 1414 495">  <pre> graph TD Q1{Is connection of CN603 correct? Is resistance value of TD sensor correct?} -- NO --> A1[Correct connector. Replace TD sensor] Q1 -- YES --> A2[Replace outdoor P.C. board.] </pre> </div>
[F06]		<p data-bbox="448 533 970 566">[Heat exchanger temp. sensor (TE) trouble]</p> <div data-bbox="459 589 1414 797">  <pre> graph TD Q1{Is connection of CN601 correct? Is resistance value of TE sensor correct?} -- NO --> A1[Correct connector. Replace TE sensor] Q1 -- YES --> A2[Replace outdoor P.C. board.] </pre> </div>
[F07]		<p data-bbox="448 835 970 869">[Heat exchanger temp. sensor (TL) trouble]</p> <div data-bbox="459 891 1414 1099">  <pre> graph TD Q1{Is connection of CN604 correct? Is resistance value of TL sensor correct?} -- NO --> A1[Correct connector. Replace TL sensor] Q1 -- YES --> A2[Replace outdoor P.C. board.] </pre> </div>
[F08]		<p data-bbox="448 1137 879 1171">[Outside temp. sensor (TO) trouble]</p> <div data-bbox="459 1193 1414 1424">  <pre> graph TD Q1{Is connection of CN602 correct? Is resistance value of TO sensor correct?} -- NO --> A1[Correct connector. Replace TO sensor] Q1 -- YES --> A2[Replace outdoor P.C. board.] </pre> </div>
[F12]		<p data-bbox="448 1462 874 1496">[Suction temp. sensor (TS) trouble]</p> <div data-bbox="459 1518 1414 1749">  <pre> graph TD Q1{Is connection of CN600 correct? Is resistance value of TS sensor correct?} -- NO --> A1[Correct connector. Replace TS sensor] Q1 -- YES --> A2[Replace outdoor P.C. board.] </pre> </div>
[F13]		<p data-bbox="448 1798 895 1832">[Heat sink temp. sensor (TH) trouble]</p> <div data-bbox="459 1854 1034 1973">  </div>

Check code	Outdoor LED display	Check and troubleshooting (Item without special mention Indicates part of outdoor unit.)
[F15]	○○○●●○	<p>[Miswiring of heat exchanger sensor (TE, TS)]</p> <pre> graph TD Q1{{Is mounting status of TE and TS sensors correct?}} -- NO --> A1[Correct sensor mounting.] Q1 -- YES --> Q2{{Is connection of CN600 correct? Is resistance value of TS sensor correct?}} Q2 -- NO --> A2[Correct connector. Replace TS sensor] Q2 -- YES --> Q3{{Is connection of CN601 correct? Is resistance value of TE sensor correct?}} Q3 -- NO --> A3[Correct connector. Replace TE sensor] Q3 -- YES --> A4[Replace outdoor P.C. board.] </pre>
[F31]	●○●○●○	<p>[EEPROM trouble]</p> <pre> graph TD A[Replace outdoor P.C. board.] </pre>
[H01]	○○●○○●○	<p>[Compressor break down]</p> <pre> graph TD Q1{{Is power supply voltage normal? AC198 to 264V?}} -- NO --> A1[Correct power supply line.] Q1 -- YES --> Q2{{Is wire connection correct? Compressor lead (P.C. board side, Compressor side), Reactor lead, Power supply lead?}} Q2 -- NO --> A2[Check wire connection and correct it.] Q2 -- YES --> Q3{{Does an abnormal overload happen?}} Q3 -- NO --> A3[Remove and improve the cause of overload.] Q3 -- YES --> A4[Replace outdoor P.C. board. * When replacing outdoor P.C. board, replace the fuse.] </pre>

Check code	Outdoor LED display	Check and troubleshooting (Item without special mention Indicates part of outdoor unit.)
[H02]	●●○○●○	<p>[Compressor lock]</p> <pre> graph TD Q1{{Is power supply voltage normal? AC198 to 264V}} -- NO --> A1[Correct power supply line.] Q1 -- YES --> Q2{{Is wire connection correct? Compressor lead (P.C. board side, Compressor side), Reactor lead, Power supply lead}} Q2 -- NO --> A2[Check wire connection and correct it.] Q2 -- YES --> Q3{{Is compressor under correct conditions?}} Q3 -- YES --> A3[Replace outdoor P.C. board. * When replacing outdoor P.C.board, replace the fuse.] Q3 -- NO --> Q4{{Is there refrigerant stagnation?}} Q4 -- NO --> A4[Compressor lock → Replace] Q4 -- YES --> Q5{{Does PMV correctly operate?}} Q5 -- NO --> A5[Replace TE, TS sensors and PMV. Malfunction → Replace] Q5 -- YES --> A3 </pre>
[H03]	○○●○○●○	<p>[Current detection circuit trouble]</p> <p>Replace outdoor P.C. board (MCC-1705).</p>
[H04]	●○○○○●○	<p>[Case thermostat operation]</p> <pre> graph TD Q1{{Are CN609 connection and case thermostat correct?}} -- NO --> A1[Correct connector. Case thermostat trouble → Replace] Q1 -- YES --> Q2{{When short-circuit the case thermostat, can you perform the cooling/heating operation?}} Q2 -- NO --> A2[Replace outdoor P.C. board. * When replacing outdoor P.C.board, replace the fuse.] Q2 -- YES --> Q3{{Is there gas leak? Is there refrigerant shortage?}} Q3 -- YES --> A3[Malfunction part repair. Recharge refrigerant.] Q3 -- NO --> Q4{{Is service valve fully opened?}} Q4 -- NO --> A4[Open service valve fully.] Q4 -- YES --> Q5{{Is PMV normal?}} Q5 -- NO --> A5[Replace the PMV.] Q5 -- YES --> A6[Check crushed or broken pipe. Malfunction part repair] </pre>



Check code	Outdoor LED display	Check and troubleshooting (Item without special mention Indicates part of outdoor unit.)
[L10]	●●●●○	<p>[Heat sink temp. sensor (TH) trouble]</p> <div style="border: 1px solid black; padding: 5px; width: fit-content; margin: 10px auto;"> Cut jumper line according to the explanation sheet packaged with the service P.C. board. </div>
[L29]	○●●●○	<p>[Communication trouble MCUs]</p> <div style="border: 1px solid black; padding: 5px; width: fit-content; margin: 10px auto;"> Replace outdoor P.C.board </div>
[P03]	○●●●●	<p>[Discharge temp. trouble]</p> <pre> graph TD Q1{Is there gas leak? Is there refrigerant shortage?} -- YES --> A1[Malfunction part repair. Recharge refrigerant.] Q1 -- NO --> Q2{Is PMV normal?} Q2 -- NO --> A2[Replace the PMV.] Q2 -- YES --> Q3{Does an abnormal overload happen?} Q3 -- YES --> A3[Remove and improve the cause of overload.] Q3 -- NO --> Q4{Is connection of CN603 correct? Is resistance value of TD sensor correct?} Q4 -- NO --> A4[Replace TD sensor.] Q4 -- YES --> A5[Replace outdoor P.C. board.] </pre>
[P05]	●●○●○	<p>[Power supply trouble] Voltage failure</p> <pre> graph TD Q1{Check the same items as [P04] trouble.} --> Q2{Is power supply voltage normal? (AC198 to 264V)?} Q2 -- NO --> A1[Confirmation of electrical work etc.] Q2 -- YES --> A2[Replace outdoor P.C.board] </pre>

Check code	Outdoor LED display	Check and troubleshooting (Item without special mention Indicates part of outdoor unit.)
[P07]	●○○●○○○	<p>[Heat sink overheat trouble]</p> <pre> graph TD Q1{{Are radiation grease properly applied? Is the screw stop of the motor drive element IC200 on the outdoor P.C. board, the sub heat sink, and the diode bridge tightened correctly?}} A1[Apply radiation grease to objective, retightening of screw] Q2{{Does something block the ventilation around the heatsink? Does something block air flow from the fan? (Short-circuit etc.)}} A2[Remove blocking matter, Short-circuit improvement] A3[Replace outdoor P.C. board. * When replacing outdoor P.C.board, replace the fuse.] Q1 -- NO --> A1 Q1 -- YES --> Q2 Q2 -- YES --> A2 Q2 -- NO --> A3 </pre>
[P15]	○○○●○○○	<p>[Gas leak detection]</p> <pre> graph TD Q1{{Is there gas leak? Is there refrigerant shortage?}} A1[Malfunction part repair. Recharge refrigerant.] Q2{{Is PMV normal?}} A2[Replace the PMV.] Q3{{Is service valve fully opened?}} A3[Open service valve fully.] Q4{{Is there crushed pipe?}} A4[Correct and replace piping.] Q5{{Check temp. sensor. TD sensor CN603 TS sensor CN600}} A5[Correct connector. Sensor trouble -> Replace] A6[Replace outdoor P.C. board.] Q1 -- YES --> A1 Q1 -- NO --> Q2 Q2 -- NO --> A2 Q2 -- YES --> Q3 Q3 -- NO --> A3 Q3 -- YES --> Q4 Q4 -- YES --> A4 Q4 -- NO --> Q5 Q5 -- Abnormality --> A5 Q5 -- OK --> A6 </pre>

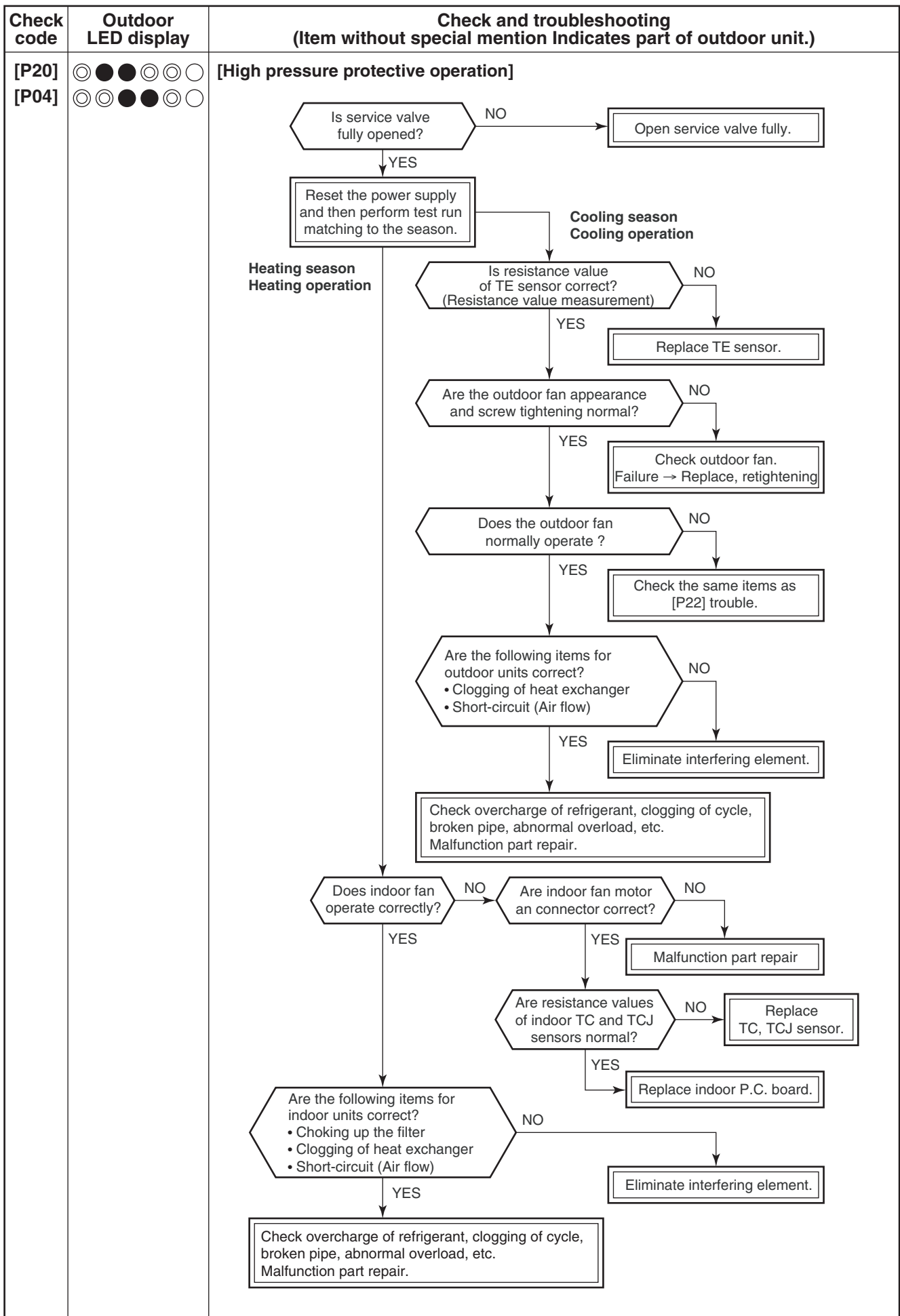
Check code	Outdoor LED display	Check and troubleshooting (Item without special mention indicates part of outdoor unit.)												
[P19]	●●●○○○	<p data-bbox="446 235 798 268">[4-way valve inverse trouble]</p> <pre> graph TD Q1{{Does 4-way valve work correctly? (Check pipe temp. etc. in cooling/heating operation.)}} Q2{{Is the coil resistance value of 4-way valve normal?}} Q3{{Temperature sensor normal? TE sensor CN601 TS sensor CN600}} Q4{{Is the flow of the refrigerant by the PMV normal?}} Q5{{Indoor TC, TCJ sensor normal?}} Q6{{The voltage variation due to the confirmation of 4-way valve relay operation, refer to below?}} Q7{{Check outdoor P.C.board}} A1[Replace 4-way valve coil] A2[Replace TE, TS sensor] A3[Check PMV and replace] A4[Replace TC, TCJ sensor] A5[Check 4-way valve and replace] A6[Replace indoor P.C.board] Q1 -- NO --> Q2 Q1 -- YES --> Q3 Q2 -- NO --> A1 Q2 -- YES --> Q6 Q3 -- NO --> A2 Q3 -- YES --> Q4 Q4 -- NO --> A3 Q4 -- YES --> Q5 Q5 -- NO --> A4 Q5 -- YES --> A6 Q6 -- NO --> A5 Q6 -- YES --> Q7 Q7 -- OK --> A6 </pre> <p data-bbox="446 1052 893 1086">[4-way valve relay operation check]</p> <p data-bbox="478 1086 1404 1142">Service switches SW01 and SW02 can be used to check the operation of the 4-way valve relay.</p> <p data-bbox="478 1142 1388 1198">Use to check whether there are any problems with the 4-way valve or 4-way valve coil.</p> <p data-bbox="446 1198 718 1232">[Method of operation]</p> <ol data-bbox="478 1232 1452 1444" style="list-style-type: none"> 1) Ensure that D800 to D804 are off (or rapidly flashing) and that D805 is lit up. If D800 to D804 are slowly flashing or D805 is flashing then push and hold down SW01 and SW02 at the same time for at least 5 seconds. D800 to D804 will turn off (or rapidly flash) and D805 turn on. 2) Push and hold down SW01 for at least 5 seconds. D804 will start slowly flashing. 3) Push SW01 until reaching the below [4-way valve resistance value relay operation] LED indication. <table border="1" data-bbox="518 1456 1252 1556"> <thead> <tr> <th>4-way valve resistance value relay operation</th> <th>D800</th> <th>D801</th> <th>D802</th> <th>D803</th> <th>D804</th> </tr> </thead> <tbody> <tr> <td></td> <td>●</td> <td>●</td> <td>○</td> <td>○</td> <td>◎</td> </tr> </tbody> </table> <p data-bbox="518 1556 1053 1590">●: Go OFF ○: Go ON ◎: Flash (5 times/sec)</p> <ol data-bbox="478 1601 1452 1780" style="list-style-type: none"> 4) Push SW02 until D805 starts rapidly flashing. 5) Push and hold down SW02 for at least 5 seconds. D804 will start slowly flashing, D805 will turn on, and the 4-way valve resistance value relay operation will turn on. 6) Push and hold down SW01 and SW02 at the same time for at least 5 seconds or wait 2 minutes to return to normal control. 	4-way valve resistance value relay operation	D800	D801	D802	D803	D804		●	●	○	○	◎
4-way valve resistance value relay operation	D800	D801	D802	D803	D804									
	●	●	○	○	◎									

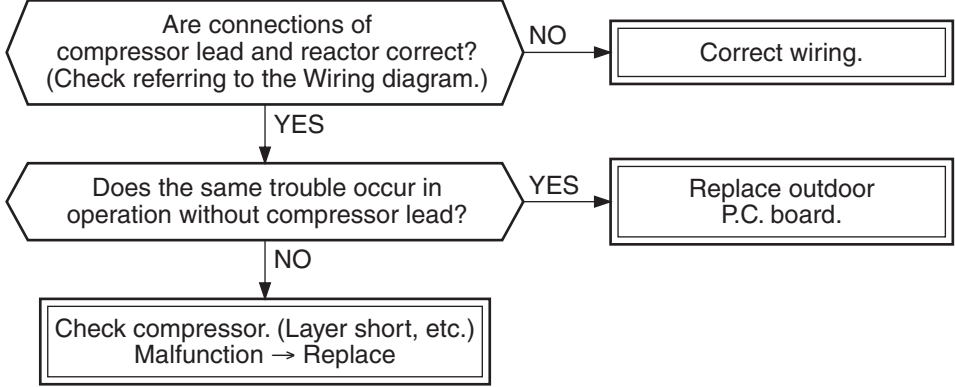

Check code	Outdoor LED display	Check and troubleshooting (Item without special mention Indicates part of outdoor unit.)												
[P22]	●○○●○○○	<p>[Fan system trouble]</p> <pre> graph TD Q1{{Is power supply voltage normal? AC198 to 264V}} -- NO --> A1[Check wiring construction. Ask repair of power supply.] Q1 -- YES --> Q2{{Rotate shaft of the fan motor by hands during power-OFF. Can it rotate smoothly? Is coil resistance of fan motor correct? Between red and white lead wire : 12 to 20Ω Between white and black lead wire : 12 to 20Ω Between black and red lead wire : 12 to 20Ω}} Q2 -- NO --> A2[Replace fan motor.] Q2 -- YES --> Q3{{Is the fuse normal? (Near the terminal block)}} Q3 -- NO --> A3[Replace fuse.] Q3 -- YES --> A4[Replace outdoor P.C.board] </pre> <p>[Confirmation of independent operation of outdoor fan] Service switches SW01 and SW02 can be used to check the operation of the 4-way valve relay. Use to check whether there are any problems with the 4-way valve or 4-way valve coil.</p> <p>[Method of operation]</p> <ol style="list-style-type: none"> 1) Ensure that D800 to D804 are off (or rapidly flashing) and that D805 is lit up. If D800 to D804 are slowly flashing or D805 is flashing then please push and hold down SW01 and SW02 at the same time for at least 5 seconds. D800 to D804 will turn off (or rapidly flash) and D805 turn on. 2) Push and hold down SW01 for at least 5 seconds. D804 will start slowly flashing. 3) Push SW01 until reaching the below [Confirmation of independent operation of outdoor fan] LED indication. <table border="1" data-bbox="520 1267 1294 1357"> <thead> <tr> <th>Confirmation of independent operation of outdoor fan</th> <th>D800</th> <th>D801</th> <th>D802</th> <th>D803</th> <th>D804</th> </tr> </thead> <tbody> <tr> <td></td> <td>○</td> <td>○</td> <td>●</td> <td>○</td> <td>◎</td> </tr> </tbody> </table> <p>●: Go OFF ○: Go ON ◎: Flash (5 times/sec)</p> <ol style="list-style-type: none"> 4) Push SW02 until D805 starts rapidly flashing. 5) Push and hold down SW02 for at least 5 seconds. D804 will start slowly flashing, D805 will turn on, and fan will start operation. 6) Push and hold down SW01 and SW02 at the same time for at least 5 seconds or wait 2 minutes until fan operation stops. <p>* If any unclear point arises during an operation then can return to step 1 by pressing and holding down SW01 and SW02 at the same time for at least 5 seconds.</p>	Confirmation of independent operation of outdoor fan	D800	D801	D802	D803	D804		○	○	●	○	◎
Confirmation of independent operation of outdoor fan	D800	D801	D802	D803	D804									
	○	○	●	○	◎									

Check code	Outdoor LED display	Check and troubleshooting (Item without special mention Indicates part of outdoor unit.)
[P26]		<p>[Short-circuit of compressor drive element]</p>  <pre> graph TD Q1{Are connections of compressor lead and reactor correct? (Check referring to the Wiring diagram.)} -- NO --> A1[Correct wiring.] Q1 -- YES --> Q2{Does the same trouble occur in operation without compressor lead?} Q2 -- YES --> A2[Replace outdoor P.C. board.] Q2 -- NO --> A3[Check compressor. (Layer short, etc.) Malfunction -> Replace] </pre>
[P29]		<p>[Position detection circuit trouble]</p> <div style="border: 1px solid black; padding: 5px; width: fit-content;"> <p>Replace outdoor P.C. board. * When replacing outdoor P.C.board, replace the fuse.</p> </div>
— No code		<p>[Other trouble] --- Compressor step-out from sudden changes in load etc. * Outdoor LED indication occurs but it automatically restarts and does not confirm any trouble. * May occur also when the compressor is open phase and wiring disconnected.</p>

Temperature sensor

Temperature – Resistance value characteristic table

TA, TC, TCJ, TE, TS, TO sensors

TD, TL sensors

Representative value

Representative value

Temperature (°C)	Resistance value (kΩ)		
	(Minimum value)	(Standard value)	(Maximum value)
0	32.33	33.80	35.30
10	19.63	20.35	21.09
20	12.23	12.59	12.95
25	9.75	10.00	10.25
30	7.764	7.990	8.218
40	5.013	5.192	5.375
50	3.312	3.451	3.594
60	2.236	2.343	2.454
70	1.540	1.623	1.709
80	1.082	1.146	1.213
90	0.7740	0.8237	0.8761
100	0.5634	0.6023	0.6434

Temperature (°C)	Resistance value (kΩ)		
	(Minimum value)	(Standard value)	(Maximum value)
0	150.5	161.3	172.7
10	92.76	99.05	105.6
20	58.61	62.36	66.26
25	47.01	49.93	52.97
30	37.93	40.22	42.59
40	25.12	26.55	28.03
50	17.00	17.92	18.86
60	11.74	12.34	12.95
70	8.269	8.668	9.074
80	5.925	6.195	6.470
90	4.321	4.507	4.696
100	3.205	3.336	3.468

TA, TC, TCJ, TE, TS, TO sensors

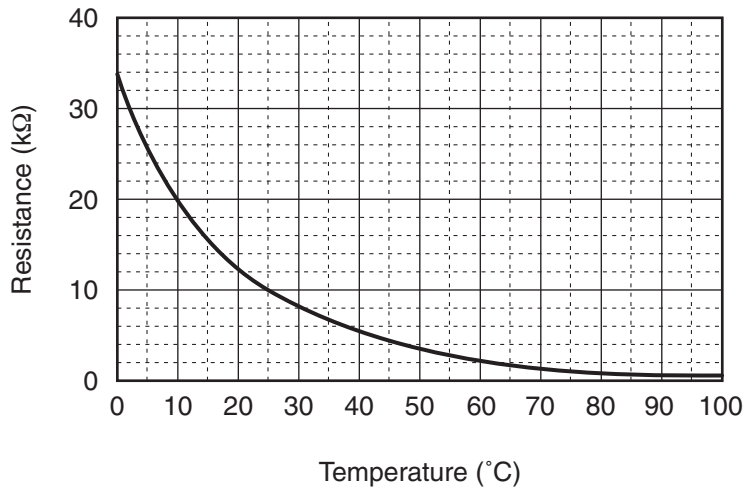

TD, TL sensors

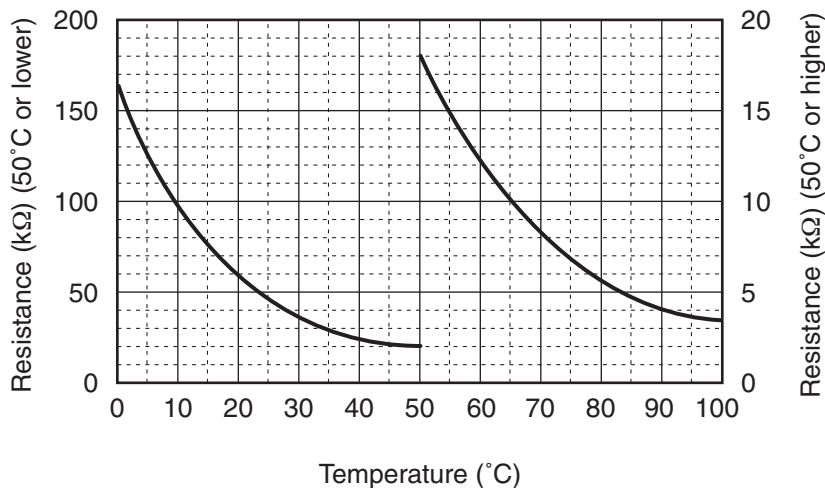

Pressure sensor I/O wire connecting table

Pin No.	Input/output name	Lead wire
1	—	—
2	OUTPUT	White
3	GND	Black
4	DC5V	Red

* As TH sensor (Outdoor unit heat sink temp. sensor) is incorporated in the outdoor control P.C. board, the resistance value cannot be measured.

9. SETUP AT LOCAL SITE AND OTHERS

9-1. Calling of Check code History

<Contents>

The trouble contents in the past can be called.

<Procedure>

- 1** Push **SET** + **TEST** buttons simultaneously for 4 seconds or more to call the service check mode.

Service check goes on, the CODE No. **01** is displayed, and then the content of the latest alarm is displayed.

The number and trouble contents of the indoor unit in which a trouble occurred are displayed.

- 2** In order to monitor another check code history, push the set temperature **▼** / **▲** buttons to change the check code history No. (CODE No.).

CODE No. **01** (Latest) → CODE No. **04** (Old)

NOTE : 4 check code histories are stored in memory.

- 3** Pushing **TEST** button returns the display to usual display.

REQUIREMENT

Do not push **CL** button, otherwise all the check code histories of the indoor unit are deleted.

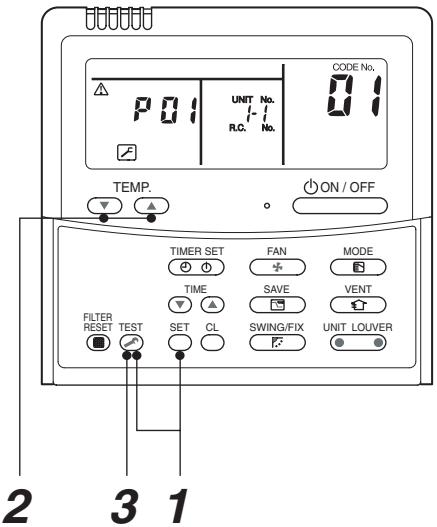

<Operation procedure>

1 → 2 → 3

Returned to usual display

Indoor unit power-ON sequence

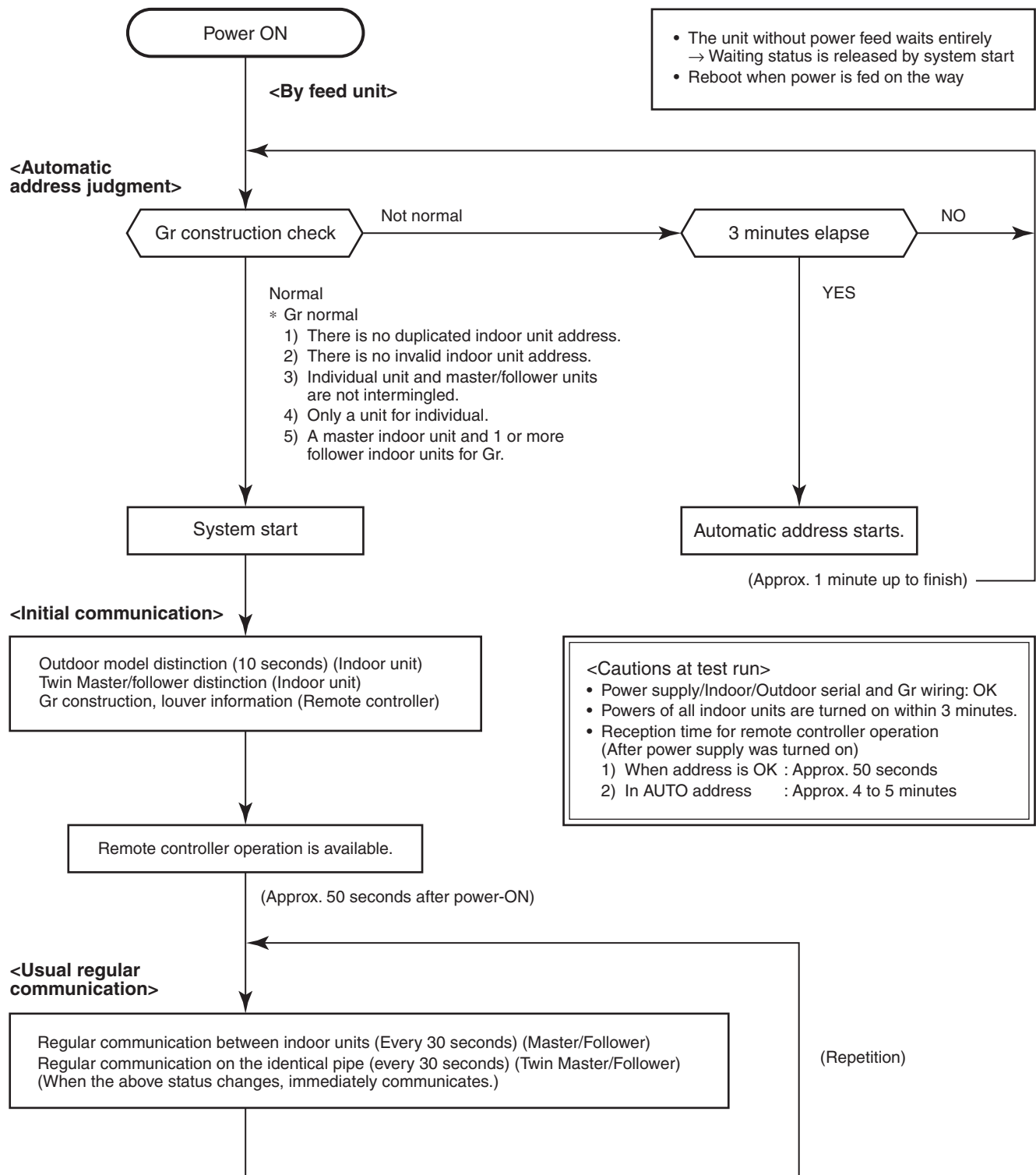

9-2. Outdoor Unit

Various status displays and operations can be accessed using the push buttons (service switches) on the outdoor Control P.C. board and LED display.

Service switch (SW01 and SW02) operation

<GP110, GP140>

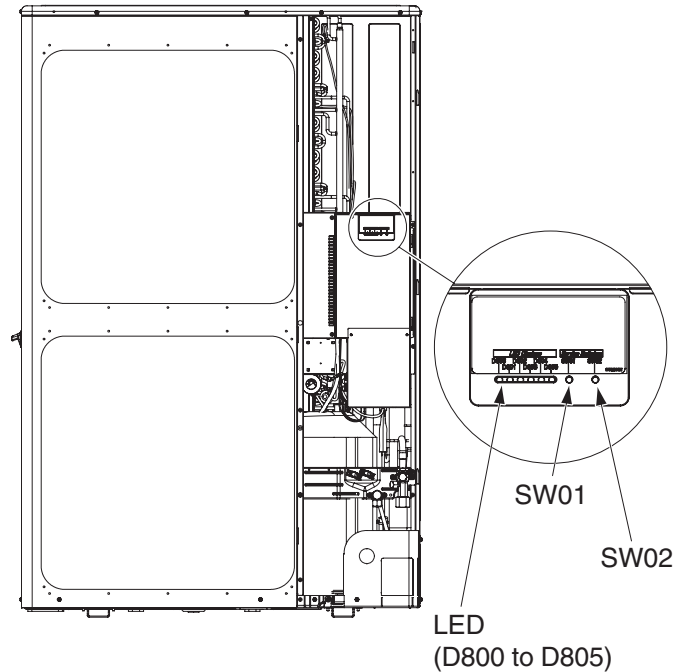

<GP80>

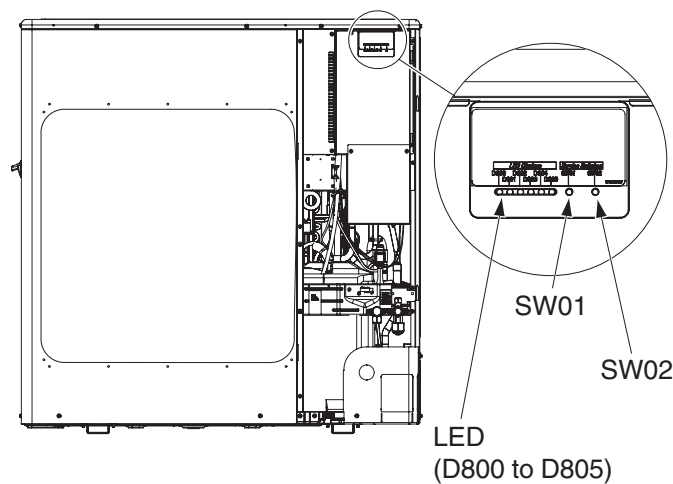

Concerning the LED display

- The LED display has 4 patterns.
○ : Go ON ● : Go OFF ⊙ : flash (5 times/sec) ◇ : flashing (1 time/sec)
- The initial state of the LED display is as shown on the right with D805 lit up.
If not in the initial state (D805 flashing) then it can be returned to the initial state by pushing and holding down SW01 and SW02 at the same time for 5 seconds.

LED display: Initial state

D800 to D804 : Go Off and flash (5 times/sec)
D805 : Go ON

	D800	D801	D802	D803	D804	D805
LED	○ (Yellow)	○ (Yellow)	○ (Yellow)	○ (Yellow)	○ (Yellow)	○ (Green)

1. Various settings available via the outdoor unit (Existing pipe, Maximum frequency change, Snow guard fan control, Cooling only setup, etc.)

(1) Service switch setting

Various settings can be made using the service switches

[Method of operation]

- 1) Ensure the LED display shows the initial status. If not then ensure to restore the initial status.
- 2) Press SW01 for at least 5 seconds. D804 will start slowly flashing.
- 3) Push SW01 several times until reaching the required LED display function.

Functions	LED display					Control content																																	
Existing pipe setting	D800	D801	D802	D803	D804	Activate when existing DIA 19.1 piping is used. Note that in this case, depending on the outdoor and indoor air temperature, the heating capacity may drop.																																	
	●	●	○	●	◎																																		
Cooling only setting	D800	D801	D802	D803	D804	Cooling only setting. (Can also be changed using the DN code [0F] on the wired remote control).																																	
	○	○	●	●	◎																																		
Snow guard fan control	D800	D801	D802	D803	D804	The snow guard fan control enables snow to be diverted from the path of the fan and heat exchanger, thereby protecting the fan motor. And even when the compressor is not in use but the external temperature is less than 7°C ensure the outdoor fan is going using W3.																																	
	●	○	●	●	◎																																		
Maximum frequency change	D800	D801	D802	D803	D804	Enable this if you wish to lower the maximum compressor frequency. It will lower the maximum frequency during both cooling and heating. Note however it does reduce the maximum capacity. Maximum compressor frequency (rps)																																	
	●	●	●	○	◎																																		
						<table border="1"> <thead> <tr> <th rowspan="2">Model</th> <th colspan="2">GP80</th> <th colspan="2">GP110</th> <th colspan="2">GP140</th> </tr> <tr> <th>Cooling</th><th>Heating</th><th>Cooling</th><th>Heating</th><th>Cooling</th><th>Heating</th> </tr> </thead> <tbody> <tr> <td>Standard status</td> <td>80.4</td><td>99.6</td><td>64.2</td><td>78.6</td><td>77.4</td><td>99.6</td> </tr> <tr> <td>When setting is valid</td> <td>74.4</td><td>74.4</td><td>58.8</td><td>58.8</td><td>74.4</td><td>74.4</td> </tr> </tbody> </table>							Model	GP80		GP110		GP140		Cooling	Heating	Cooling	Heating	Cooling	Heating	Standard status	80.4	99.6	64.2	78.6	77.4	99.6	When setting is valid	74.4	74.4	58.8	58.8	74.4	74.4
Model	GP80		GP110		GP140																																		
	Cooling	Heating	Cooling	Heating	Cooling	Heating																																	
Standard status	80.4	99.6	64.2	78.6	77.4	99.6																																	
When setting is valid	74.4	74.4	58.8	58.8	74.4	74.4																																	

○: Go ON ●: Go OFF ◎: Flash (5 times/sec)

- 4) Push SW01 until D805 starts rapidly flashing.
 - 5) Press and hold down SW02 for at least 5 seconds. D804 will start slowly flashing and D805 will light up, and the various settings will take effect.
 - 6) To make more settings repeat steps 3) to 5).
 - 7) To invalidate any settings made in steps 1 to 3 press SW01 to turn off D805.
 - 8) Press and hold down SW02 for at least 5 seconds. D804 will start to slowly flash and D805 will turn off and the various settings will be invalidated.
- * If any unclear point arises during an operation then can return to step 1 by pressing and holding down SW01 and SW02 at the same time for at least 5 seconds.

Various settings confirmation method

Whether the various settings are in effect or not can be confirmed.

- 1) Ensure the LED display shows the initial status. If not then ensure to restore the initial status.
- 2) Push SW01 for at least 5 seconds. D804 will start slowly flashing.
- 3) Push SW01 several times until reaching the desired function on the LED display. If the setting is valid D804 and D805 will rapidly flash. (If the setting is invalid then D804 will rapidly flash but D805 will turn off.)
- 4) Push and hold down SW01 and SW02 at the same time for at least 5 seconds to return the LED display to the initial state.

Returning to the factory default settings

The factory default settings can be restored using the following procedure.

- 1) Ensure the LED display shows the initial state. If not then ensure to return it to the initial state.
- 2) Push and hold down SW01 for at least 5 seconds and confirm that D804 is slowly flashing.
- 3) Push SW01 several times until reaching the LED display (D800 to D805) shown on the right or 'Returning to the default factory setting LED display'.
- 4) Push and hold down SW02 for at least 5 seconds and confirm that D804 is slowly flashing.
- 5) Push and hold down SW01 and SW02 at the same time for at least 5 seconds to return to the initial state LED display.

Return to default factory setting LED display					
D800	D801	D802	D803	D804	D805
●	●	●	●	◎	●
○: Go ON ●: Go OFF ◎: Flash (5 times/sec)					

Sub-P.C. board switch and LED arrangement diagram

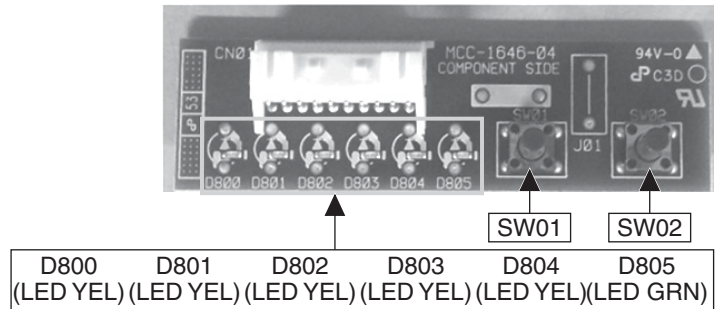

2. Service support functions (LED display and switch operation)

(1) LED display switching (SW01 and SW02 operation)

(1)-1. Display switch list

Service switches SW01 and SW02 can be used to change the display content of LEDs D800 to D805 on the outdoor unit.

[Method of Operation]

- 1) Ensure the LED display shows the initial state. If not then ensure to return it to the initial state.
- 2) Push SW01 several times until reaching the desired display item.

LED display						Control content
D800	D801	D802	D803	D804	D805	Trouble indication (Current trouble) Displays the current trouble. Will not appear if no trouble has occurred. (Refer to (1)-2-1)
●	●	●	●	●	◎	
D800	D801	D802	D803	D804	D805	Trouble indication (Latest trouble: latest and including current trouble) Previous trouble can be checked using this setting, for example, after previous trouble has been resolved (and even after the power has been turned off). * If trouble is currently occurring then the same content will be displayed. * TO sensor trouble only and thus this setting does not display. (Check using the current trouble setting). (Refer to (1)-2-2)
○	●	●	●	●	◎	
D800	D801	D802	D803	D804	D805	Discharge temperature sensor (TD) indication Displays the discharge temperature sensor (TD) value. (Refer to (1)-3)
●	○	●	●	●	◎	
D800	D801	D802	D803	D804	D805	Outdoor heat exchanger temperature sensor (TE) indication Displays the outdoor heat exchanger temperature sensor (TE) value. (Refer to (1)-3)
○	○	●	●	●	◎	
D800	D801	D802	D803	D804	D805	Outdoor heat exchanger temperature sensor (TL) indication Displays the outdoor heat exchanger sensor (TL) value. (Refer to (1)-3)
●	○	○	●	●	◎	
D800	D801	D802	D803	D804	D805	Inlet temperature sensor (TS) indication. Displays the inlet temperature sensor (TS) value. (Refer to (1)-3)
●	●	○	●	●	◎	
D800	D801	D802	D803	D804	D805	Outdoor external temperature sensor (TO) indication. Displays the outdoor external temperature sensor (TO) value. (Refer to (1)-3)
○	●	○	●	●	◎	
D800	D801	D802	D803	D804	D805	Heat sink temperature sensor (TH) indication. Displays the heat sink temperature sensor (TH) value. (Refer to (1)-3)
○	○	○	●	●	◎	
D800	D801	D802	D803	D804	D805	Current indication. Displays the outdoor unit current value. (Refer to (1)-3)
○	●	●	○	●	◎	
D800	D801	D802	D803	D804	D805	Compressor operation frequency indication. Displays the operating frequency of the compressor. (Refer to (1)-3)
●	○	●	○	●	◎	
D800	D801	D802	D803	D804	D805	PMV opening indication. Displays the degree to which the PMV is open. (Refer to (1)-3)
○	○	●	○	●	◎	
D800	D801	D802	D803	D804	D805	Indoor room air temperature sensor (TA) indication. Displays the indoor room air temperature sensor (TA) value. (Refer to (1)-3)
●	●	○	○	●	◎	
D800	D801	D802	D803	D804	D805	Indoor heat exchange temperature sensor (TC) indication. Displays the indoor heat exchange temperature sensor (TC) value. (Refer to (1)-3)
○	●	○	○	●	◎	
D800	D801	D802	D803	D804	D805	Indoor heat exchanger sensor (TCJ) indication. Displays the indoor heat exchanger sensor (TCJ) value. (Refer to (1)-3)
●	○	○	○	●	◎	
D800	D801	D802	D803	D804	D805	Refrigerant leak indication. Displays if a certain amount of refrigerant has leaked. (Refer to (1)-4)
●	●	●	○	●	◎	

○: Go ON ●: Go OFF ◎: Flash (5 times/sec)

- 3) Push SW02 to switch to the desired display item.
- 4) To access the other display items repeat steps 1) to 3).
- 5) Before exiting ensure to perform step 1) and set the LED to the initial state (current abnormality indication).

(1)-2. Trouble display

Current and the latest trouble (latest and including the present trouble) can be checked using the lighting status of the LEDs D800 to D805 on the outdoor unit.

(1)-2-1. Current trouble indication

LED indication						Name of trouble	Wired remote control trouble code
D800	D801	D802	D803	D804	D805		
●	●	●	●	●	○	Normal	—
◎	●	●	●	●	○	Discharge temp. sensor (TD) trouble	F04
●	◎	●	●	●	○	Heat exchanger temp. sensor (TE) trouble	F06
◎	◎	●	●	●	○	Heat exchanger temp. sensor (TL) trouble	F07
●	●	◎	●	●	○	Outside temp. sensor (TO) trouble	F08
◎	●	◎	●	●	○	Suction temp. sensor (TS) trouble	F12
●	◎	◎	●	●	○	Heat sink temp. sensor (TH) trouble	F13
◎	◎	◎	●	●	○	Miss-mounting of sensor (TE, TS)	F15
●	◎	●	◎	●	○	EEPROM trouble	F31
◎	◎	●	◎	●	○	Compressor break down	H01
●	●	◎	◎	●	○	Compressor lock	H02
◎	●	◎	◎	●	○	Current detection circuit trouble	H03
●	◎	◎	◎	●	○	Case thermostat operation	H04
●	●	●	●	◎	○	Unset model type	L10
◎	●	●	●	◎	○	Communication trouble between MCUs	L29
●	◎	●	●	◎	○	Discharge temp. sensor trouble	P03
◎	◎	●	●	◎	○	High pressure SW operation	P04
●	●	◎	●	◎	○	Power supply trouble	P05
●	◎	◎	●	◎	○	Heat sink overheat trouble	P07
◎	◎	◎	●	◎	○	Gas leak detection	P15
●	●	●	◎	◎	○	4-way valve reversal trouble	P19
◎	●	●	◎	◎	○	High pressure protective operation	P20
●	◎	●	◎	◎	○	Fan system trouble	P22
◎	◎	●	◎	◎	○	Short-circuit of compressor drive element	P26
●	●	◎	◎	◎	○	Position detection circuit trouble	P29

○: Go ON ●: Go OFF ◎: Flash (5 times/sec)

(1)-2-2. Latest (including current) trouble indication

LED indication						Name of trouble
D800	D801	D802	D803	D804	D805	
●	●	●	●	●	◇	Normal
◎	●	●	●	●	◇	Discharge temp. sensor (TD) trouble
●	◎	●	●	●	◇	Heat exchanger temp. sensor (TE) trouble
◎	◎	●	●	●	◇	Heat exchanger temp. sensor (TL) trouble
●	●	◎	●	●	◇	Outside temp. sensor (TO) trouble
◎	●	◎	●	●	◇	Suction temp. sensor (TS) trouble
●	◎	◎	●	●	◇	Heat sink temp. sensor (TH) trouble
◎	◎	◎	●	●	◇	Miswiring of heat exchanger temp. sensor (TE, TS)
●	◎	●	◎	●	◇	EEPROM trouble
◎	◎	●	◎	●	◇	Compressor break down
●	●	◎	◎	●	◇	Compressor lock
◎	●	◎	◎	●	◇	Current detection circuit trouble
●	◎	◎	◎	●	◇	Case thermostat operation
●	●	●	●	◎	◇	Unset model type
◎	●	●	●	◎	◇	Communication trouble between MCUs
●	◎	●	●	◎	◇	Discharge temp. sensor trouble
◎	◎	●	●	◎	◇	High pressure SW operation
●	●	◎	●	◎	◇	Power supply trouble
●	◎	◎	●	◎	◇	Heat sink overheat trouble
◎	◎	◎	●	◎	◇	Gas leak detection
●	●	●	◎	◎	◇	4-way valve reversal trouble
◎	●	●	◎	◎	◇	High pressure protective operation
●	◎	●	◎	◎	◇	Fan system trouble
◎	◎	●	◎	◎	◇	Short-circuit of compressor drive element
●	●	◎	◎	◎	◇	Position detection circuit trouble

○: Go ON ●: Go OFF ◎: Flash (5 times/sec) ◇: flashing (1 time/sec)

(1)-3. Sensor, current, compressor operation frequency, PMV opening indication

Interface (CDB) P.C. board detected values (for example temperature and current sensor values) can be easily checked.

* Temperature sensors ... TD, TE, TL, TS, TO, TH, TA, TC, TCJ

* Current Current sensor (CT) value detected

LED indication						Temperature sensor (°C)	Current (A)	Compressor frequency (rps)	Degree of PMV opening (pls)
D800 (YEL)	D801 (YEL)	D802 (YEL)	D803 (YEL)	D804 (YEL)	D805 (GRN)				
●	●	●	●	●	◇	Less than -25	0 ~	0 ~	0 ~ 19
○	●	●	●	●	◇	-25 ~	1 ~	5 ~	20 ~ 39
●	○	●	●	●	◇	-20 ~	2 ~	10 ~	40 ~ 59
○	○	●	●	●	◇	-15 ~	3 ~	15 ~	60 ~ 79
●	●	○	●	●	◇	-10 ~	4 ~	20 ~	80 ~ 99
○	●	○	●	●	◇	-5 ~	5 ~	25 ~	100 ~ 119
●	○	○	●	●	◇	0 ~	6 ~	30 ~	120 ~ 139
○	○	○	●	●	◇	5 ~	7 ~	35 ~	140 ~ 159
●	●	●	○	●	◇	10 ~	8 ~	40 ~	160 ~ 179
○	●	●	○	●	◇	15 ~	9 ~	45 ~	180 ~ 199
●	○	●	○	●	◇	20 ~	10 ~	50 ~	200 ~ 219
○	○	●	○	●	◇	25 ~	11 ~	55 ~	220 ~ 239
●	●	○	○	●	◇	30 ~	12 ~	60 ~	240 ~ 259
○	●	○	○	●	◇	35 ~	13 ~	65 ~	260 ~ 279
●	○	○	○	●	◇	40 ~	14 ~	70 ~	280 ~ 299
○	○	○	○	●	◇	45 ~	15 ~	75 ~	300 ~ 319
●	●	●	●	○	◇	50 ~	16 ~	80 ~	320 ~ 339
○	●	●	●	○	◇	55 ~	17 ~	85 ~	340 ~ 359
●	○	●	●	○	◇	60 ~	18 ~	90 ~	360 ~ 379
○	○	●	●	○	◇	65 ~	19 ~	95 ~	380 ~ 399
●	●	○	●	○	◇	70 ~	20 ~	100 ~	400 ~ 419
○	●	○	●	○	◇	75 ~	21 ~	105 ~	420 ~ 439
●	○	○	●	○	◇	80 ~	22 ~	110 ~	440 ~ 459
○	○	○	●	○	◇	85 ~	23 ~	115 ~	460 ~ 479
●	●	●	○	○	◇	90 ~	24 ~	120 ~	480 ~ 499
○	●	●	○	○	◇	95 ~	25 ~	125 ~	500
●	○	●	○	○	◇	100 ~	26 ~	130 ~	—
○	○	●	○	○	◇	105 ~	27 ~	135 ~	—
●	●	○	○	○	◇	110 ~	28 ~	140 ~	—
○	●	○	○	○	◇	115 ~	29 ~	145 ~	—
●	○	○	○	○	◇	120 ~	30 ~	150 ~	—
○	○	○	○	○	◇	Sensor trouble	31 or more	155 or more	—

○: Go ON ●: Go OFF ◇: flashing (1 time/sec)

(1)-4. Refrigerant leak detection function

Monitors the amount of refrigerant being circulated based on the temperature sensors, compressor rotation speed, PMV opening during operation, and detects any refrigerant leaks during operation and indicates it using the LEDs on the outdoor unit.

CAUTION

- * Detects any slow leaks at the stages of not cool not heat and trouble stoppages' during operation but may not detect fast leaks sometimes.
- * Refrigerant leaks may even be detected because of refrigerant circulation failures due to PMV (Pulse Motor Valve) blockages, operation failures, capillary blockages, strainer blockages, etc.
- * Refrigerant leak detection may not be possible depending on the external air temperature conditions during operation.

If any refrigerant leaks are detected ensure to identify where the leak is, recover the remaining refrigerant, and then recharge with the correct amount using the appropriate methods.

[Confirmation method]

- 1) Ensure the LED display shows the initial state. If not then it can be returned to the initial state by pushing and holding down SW01 and SW02 at the same time for at least 5 seconds.
- 2) Push SW01 several times until reaching the 'refrigerant leak indication' LED display.

D800	D801	D802	D803	D804	D805	Refrigerant leak indication
●	●	●	○	●	◎	Displays if a certain amount of refrigerant has leaked.

○: Go ON ●: Go OFF ◎: Flash (5 times/sec)

- 3) Briefly pushing SW02 enables the presence of a leak to be detected using the LED display.

D800	D801	D802	D803	D804	D805	Judgment
●	●	●	●	●	◇	No refrigeration leak detected
○	●	●	●	●	◇	Refrigeration leak detected

○: Go ON ●: Go OFF ◇: Flash (1 time/sec)

- 4) Before exiting, push and hold down SW01 and SW02 at the same time for at least 5 seconds and set the LED to the initial state.

(2) Maintenance inspections Special operations (SW01 and SW02 operations)

The following special maintenance and inspection operations can be carried out using the service switches SW01 and SW02.

[Method of operation]

- 1) Ensure the LED display shows the initial state. If not then please ensure to return it to the initial state.
- 2) Push and hold down SW01 for at least 5 seconds. D804 will start slowly flashing.
- 3) Push SW01 until reaching the LED display function you wish to set.

Special operations	LED display	Control content										
Refrigerant recovery operation	<table border="1"> <tr> <td>D800</td><td>D801</td><td>D802</td><td>D803</td><td>D804</td> </tr> <tr> <td>○</td><td>●</td><td>●</td><td>●</td><td>◎</td> </tr> </table>	D800	D801	D802	D803	D804	○	●	●	●	◎	The outdoor unit performs cooling operations. Indoor units do not operate with just this operation and hence do any fan only operations in advance. (Refer to 1.)
D800	D801	D802	D803	D804								
○	●	●	●	◎								
PMV fully open operation	<table border="1"> <tr> <td>D800</td><td>D801</td><td>D802</td><td>D803</td><td>D804</td> </tr> <tr> <td>○</td><td>●</td><td>○</td><td>●</td><td>◎</td> </tr> </table>	D800	D801	D802	D803	D804	○	●	○	●	◎	PMV (Pulse Motor Valve) fully opens. Perform step 6) below or returns to normal control after 2 minutes. (⇒ Note 1)
D800	D801	D802	D803	D804								
○	●	○	●	◎								
PMV fully closed operation	<table border="1"> <tr> <td>D800</td><td>D801</td><td>D802</td><td>D803</td><td>D804</td> </tr> <tr> <td>●</td><td>○</td><td>○</td><td>●</td><td>◎</td> </tr> </table>	D800	D801	D802	D803	D804	●	○	○	●	◎	PMV (Pulse Motor Valve) fully closed. Perform step 6) below or returns to normal control after 2 minutes. (⇒ Note 1)
D800	D801	D802	D803	D804								
●	○	○	●	◎								
PMV intermediate open operation	<table border="1"> <tr> <td>D800</td><td>D801</td><td>D802</td><td>D803</td><td>D804</td> </tr> <tr> <td>○</td><td>○</td><td>○</td><td>●</td><td>◎</td> </tr> </table>	D800	D801	D802	D803	D804	○	○	○	●	◎	Sets the PMV (Pulse Motor Valve) to intermediate open (500 pulses). Perform step 6) below or returns to normal control after 2 minutes. (⇒ Note 1)
D800	D801	D802	D803	D804								
○	○	○	●	◎								
Indoor heating test command	<table border="1"> <tr> <td>D800</td><td>D801</td><td>D802</td><td>D803</td><td>D804</td> </tr> <tr> <td>○</td><td>●</td><td>●</td><td>○</td><td>◎</td> </tr> </table>	D800	D801	D802	D803	D804	○	●	●	○	◎	Performs a heating test run. Carrying out step 6) below returns to normal control. (⇒ Note 2)
D800	D801	D802	D803	D804								
○	●	●	○	◎								
Indoor cooling test run command	<table border="1"> <tr> <td>D800</td><td>D801</td><td>D802</td><td>D803</td><td>D804</td> </tr> <tr> <td>●</td><td>○</td><td>●</td><td>○</td><td>◎</td> </tr> </table>	D800	D801	D802	D803	D804	●	○	●	○	◎	Performs a cooling test run. Carrying out step 6) below returns to normal control. (⇒ Note 2)
D800	D801	D802	D803	D804								
●	○	●	○	◎								
Forced fan motor operation	<table border="1"> <tr> <td>D800</td><td>D801</td><td>D802</td><td>D803</td><td>D804</td> </tr> <tr> <td>○</td><td>○</td><td>●</td><td>○</td><td>◎</td> </tr> </table>	D800	D801	D802	D803	D804	○	○	●	○	◎	Forcibly operates the fan motor. Perform step 6) below or returns to normal control after 2 minutes. (⇒ Note 1)
D800	D801	D802	D803	D804								
○	○	●	○	◎								
4 way valve relay operation	<table border="1"> <tr> <td>D800</td><td>D801</td><td>D802</td><td>D803</td><td>D804</td> </tr> <tr> <td>●</td><td>●</td><td>○</td><td>○</td><td>◎</td> </tr> </table>	D800	D801	D802	D803	D804	●	●	○	○	◎	Turns on the 4 way valve relay. Perform step 6) below or returns to normal control after 2 minutes. (⇒ Note 1)
D800	D801	D802	D803	D804								
●	●	○	○	◎								

○: Go ON ●: Go OFF ◎: Flash (5 times/sec)

Note 1 : The operations can take place while the equipment is on but it is better if it has been turned off first. A sudden change in pressure could occur while the operations are taking place, which can be dangerous.

Note 2 : Trial indoor cooling operation request/trial indoor heating operation request

Cooling/Heating test operations can only take place from the outdoor unit when combined with the following indoor units. ensure to utilize the outdoor unit.
 Test runs supported : 5 series or later indoor units
 Not supported : Indoor units other than above. In addition, any when twin connections include any other indoor units than above.

Caution) Forced test operations using this setting cannot be cancelled using the indoor remote control. Refer to (6) below.

- 4) Push SW02 until D805 starts rapidly flashing.
 - 5) Push and hold down SW02 for at least 5 seconds. D804 will start slowly flashing and D805 will turn on and the special operation will take effect.
 - 6) To invalidate any of the various settings push and hold down SW01 and SW02 at the same time for at least 5 seconds. D800 to D804 will be off (or rapidly flashing) and D805 lit up (initial state: current trouble indication) and the special operation will have been disabled (normal control).
- * If any uncertainty arises then push and hold down SW01 and SW02 at the same time for at least 5 seconds. You will return to step 1).

3. Outdoor application operation

Optional connector kit (TCB-PCOS1E2)

(1) Peak-cut control

- Saves the power of the outdoor unit by the external peak-cut signal to suppress temporary peak power dissipation.
- The power saving can be switched to three levels: 75%, 50%, and operation stop.

(2) Night operation

- Reduces the capacity of the air conditioner by the input signal from a commercially available timer (procured locally) regardless of the outside air temperature or load to reduce operating noise.

(3) Compressor output

- Turns on the no-voltage contact output while the compressor is operating.

10. ADDRESS SETUP

10-1. Address Setup Procedure

When an outdoor unit and an indoor unit are connected, or when an outdoor unit is connected to each indoor unit respectively in the group operation even if multiple refrigerant lines are provided, the automatic address setup completes with power-ON of the outdoor unit. The operation of the remote controller is not accepted while automatic address works. (Approx. 4 to 5 minutes)

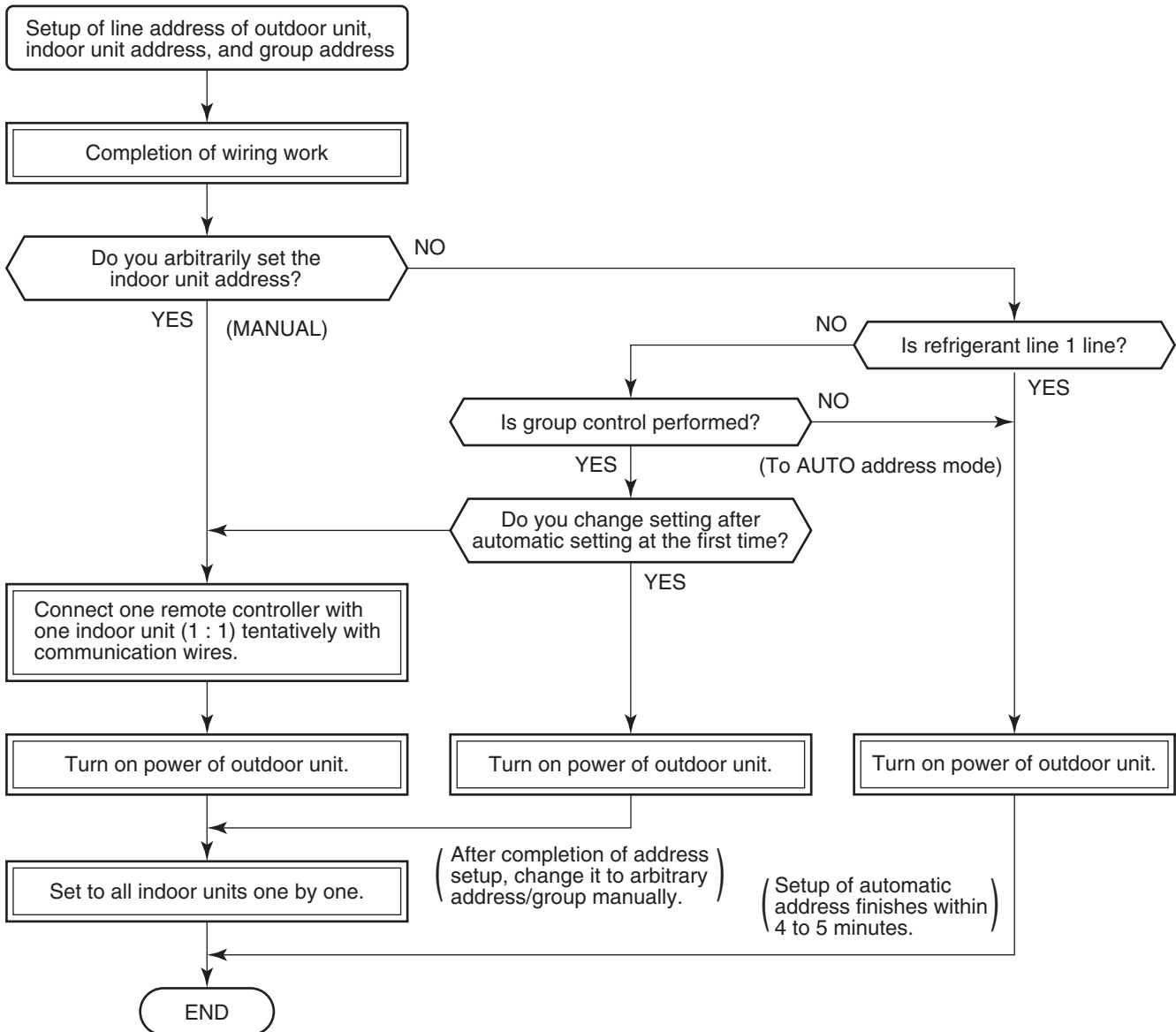

- When the following addresses are not stored in the EEPROM on the indoor P.C. board, a test run operation cannot be performed. (Unfixed data at shipment from factory)

	Item code	Data at shipment	Setup data range
Line address	12	0099	0001 (No. 1 unit) to 0064 (No. 64 unit)
Indoor unit address	13	0099	0001 (No. 1 unit) to 0064 (No. 64 unit) Max. value of indoor units in the identical refrigerant line
Group address	14	0099	0000 : Individual (Indoor units which are not controlled in a group) 0001 : Master unit (1 indoor unit in group control) 0002 : Sub unit (Indoor units other than master unit in group control)

10-2. Address Setup & Group Control

<Definitions of terms>

Indoor unit No. : $N - n =$ Outdoor unit line address N (Max. 30) - Indoor unit address n (Max. 64)

Group address : 0 = Single (Not group control)
1 = Master unit in group control
2 = Sub unit in group control

Master unit (= 1) : The representative of multiple indoor units in group operation sends/receives signals to/from the remote controllers and sub indoor units.
(* It has no relation with an indoor unit which communicates serially with the outdoor units.)
The operation mode and setup temperature range are displayed on the remote controller LCD.
(Except air direction adjustment of louver)

Sub unit (= 2) : Indoor units other than master unit in group operation
Basically, sub units do not send/receive signals to/from the remote controllers.
(Except alarm and response to demand of service data)

Header unit (Representative unit) (Master Twin)

: This unit communicates with the indoor unit (follower) which serial-communicates with the outdoor units and sends/receives signal (Command from compressor) to/from the outdoor units as the representative of the cycle control in the indoor units of the identical line address within the minimum unit which configures one of the refrigerating cycles of Twin.

Follower unit (Subordinate unit) (Sub Twin)

: Indoor units excluding the header unit in Twin
This unit communicates with (Header) indoor unit in the identical line address and performs control synchronized with (Header) indoor unit.
This unit does not perform the signal send/receive operation with the outdoor units. :
No judgment for serial signal trouble.

10-2-1. System Configuration

1. Single

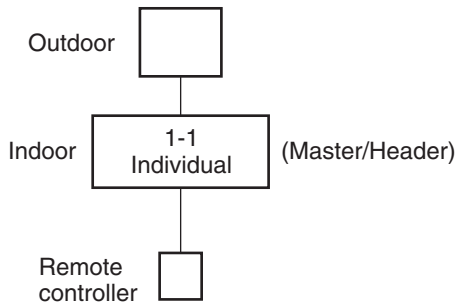

2. Twin

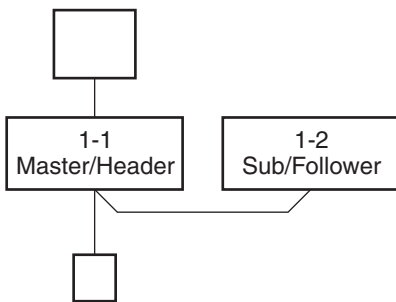

3. Single group operation

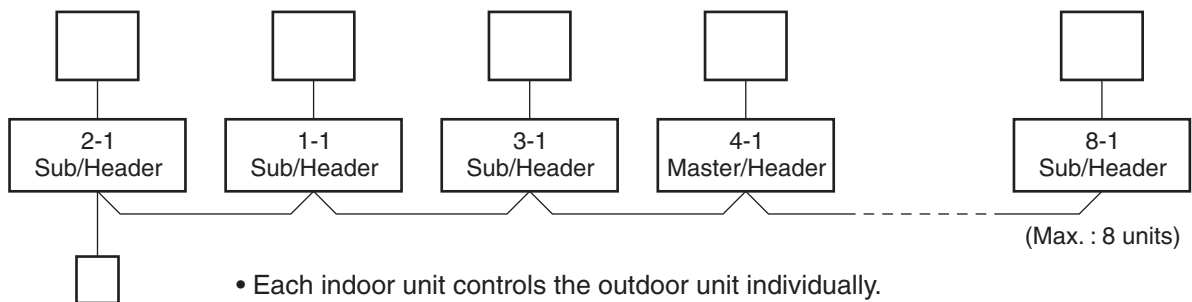

4. Multiple groups operation (Single, Twin operation)

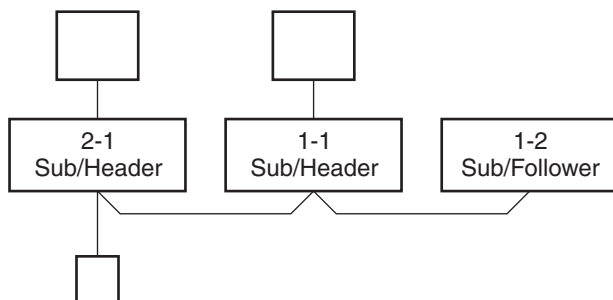

- Header unit: The header unit receives the indoor unit data (thermostat status) of the follower (Without identical line address & indoor/outdoor serial) and then finally controls the outdoor compressor matching with its own thermostat status. The header unit sends this command information to the follower unit.
- Follower unit: The follower unit receives the indoor unit data from the header (With identical line address & indoor/outdoor serial) and then performs the thermostat operation synchronized with the header unit. The follower unit sends own thermostat ON/OFF demand to the header unit. (Example)
No. 1-1 header unit sends/receives signal to/from No. 1-2 follower units. (It is not influenced by the refrigerating line 1 or 2 address indoor unit.)

10-2-2. Automatic Address Example from Unset Address (No miswiring)

1. Standard (One outdoor unit)

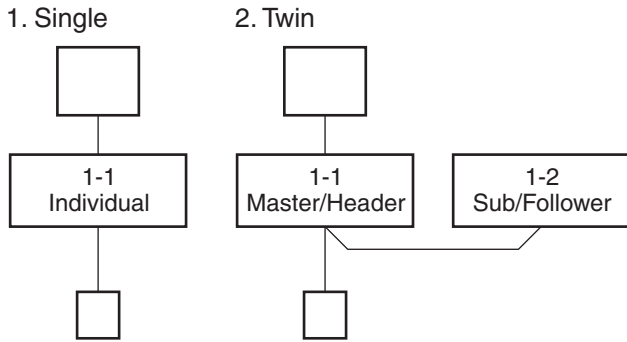

Only turning on source power supply (Automatic completion)

2. Single group operation (Multiple outdoor units = Multiple indoor units only with serial communication)

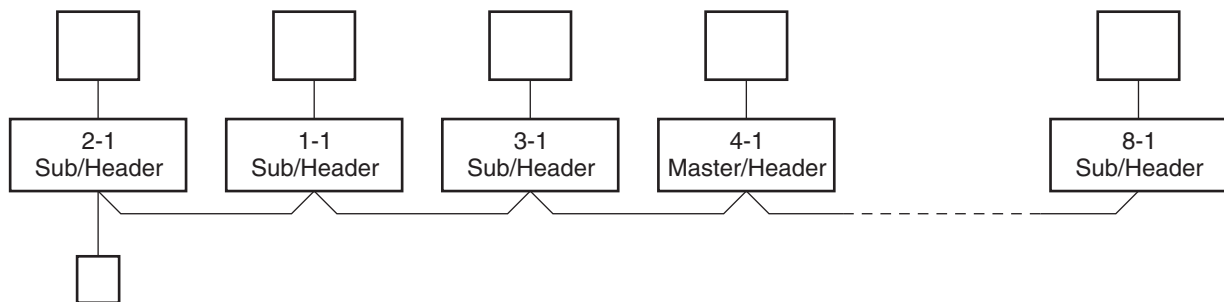

Only turning on source power supply (Automatic completion)

10-3. Remote Controller Wiring

- Strip off approx. 9 mm the wire to be connected.
- For single system, use non polarity, 2 core wire is used for wiring of the remote controller. (0.5 mm² to 2.0 mm² wires)
- For the synchronous twin system, use 2-core shield wire (Vinyl cord for microphone 0.5 to 2.0 mm²) to conform to the EMC standard.

Wiring diagram

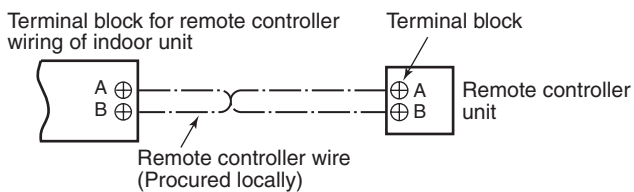

- * For details of wiring/installation of the remote controller, refer to the Installation Manual enclosed with the remote controller.

Simultaneous twin system

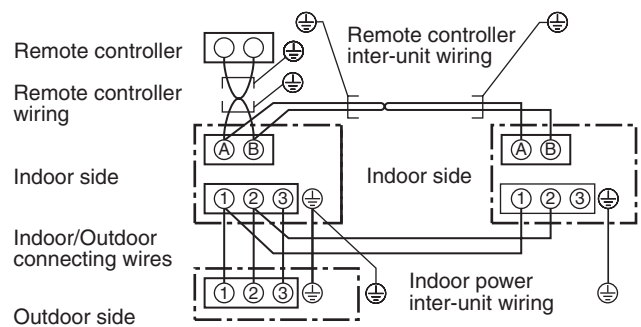

- * Use 2-core shield wire (MVVS 0.5 to 2.0 mm² or more) for the remote controller wiring in the simultaneous twin simultaneous triple and simultaneous double twin systems to prevent noise problems. Be sure to connect both ends of the shield wire to earth leads.
- * Connect earth wires for each indoor unit in the simultaneous twin simultaneous triple and simultaneous double twin system.

10-4. Address Setup (Manual setting from remote controller)

In case that addresses of the indoor units will be determined prior to piping work after wiring work

- Set an indoor unit per a remote controller.
- Turn on power supply.

(Example of 2-lines wiring)
(Solid line: Wiring, Broken line: Refrigerant pipe)

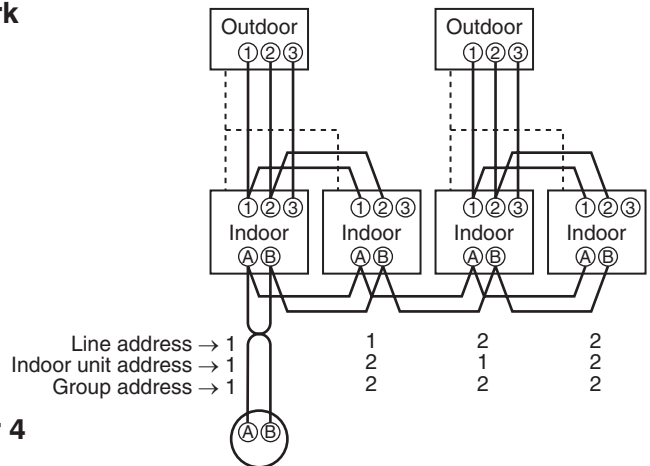

Remote controller

For the above example, perform setting by connecting singly the wired remote controller without remote controller group wiring.

Group address
 Individual : 0000
 Master unit : 0001
 Sub unit : 0002 } In case of group control

- 1 Push **SET** + **CL** + **TEST** buttons simultaneously for 4 seconds or more.
- 2 (**←** Line address)
Using the temperature setup **▼** / **▲** buttons, set **12** to the CODE No.
- 3 Using timer time **▼** / **▲** buttons, set the line address.
- 4 Push **SET** button. (OK when display goes on.)
- 5 (**←** Indoor unit address)
Using the temperature setup **▼** / **▲** buttons, set **13** to the CODE No.
- 6 Using timer time **▼** / **▲** buttons, set 1 to the line address.
- 7 Push **SET** button. (OK when display goes on.)
- 8 (**←** Group address)
Using the temperature setup **▼** / **▲** buttons, set **14** to the CODE No.
- 9 Using timer time **▼** / **▲** buttons, set **0000** to Individual, **0001** to Header unit, and **0002** to Follower unit.
- 10 Push **SET** button. (OK when display goes on.)
- 11 Push **TEST** button.
Setup completes. (The status returns to the usual stop status.)

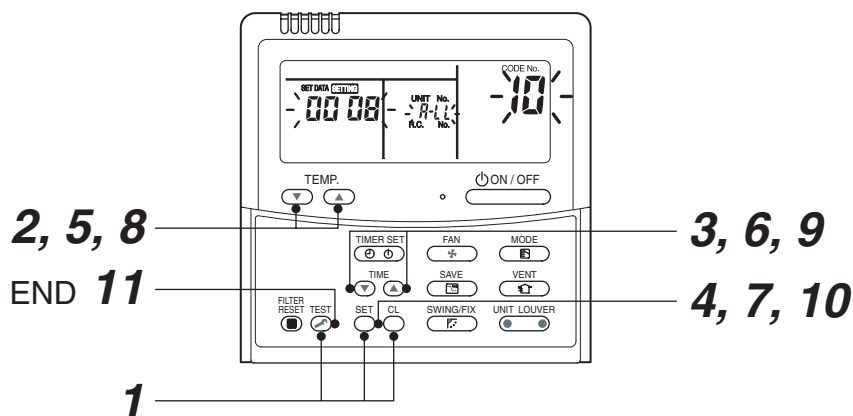

<Operation procedure>

1 → 2 → 3 → 4 → 5 → 6 → 7 → 8 → 9 → 10 → 11 END

10-5. Confirmation of Indoor Unit No. Position

1. To know the indoor unit addresses though position of the indoor unit body is recognized

- In case of individual operation (Wired remote controller : indoor unit = 1 : 1)
(Follow to the procedure during operation)

<Procedure>

1 Push  button if the unit stops.

2 Push  button (button of left side).

Unit No. 1-1 is displayed on LCD.

(It disappears after several seconds.)

The displayed unit No. indicate line address and indoor unit address.

(When other indoor units are connected to the identical remote controller (Group control unit), other unit numbers are also displayed every pushing  button (button of left side).

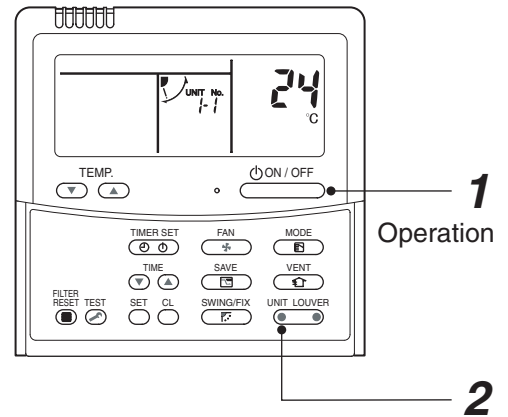

<Operation procedure>

1 → 2 END

2. To know the position of indoor unit body by address

- To confirm the unit No. in the group control
(Follow to the procedure during operation) (in this procedure, the indoor units in group control stop.)

<Procedure>

The indoor unit numbers in the group control are successively displayed, and fan, louver, and drain pump of the corresponding indoor unit are turned on.
(Follow to the procedure during operation)

1 Push  and  buttons simultaneously for 4 seconds or more.

- Unit No. ALL is displayed.
- Fans and louvers of all the indoor units in the group control operate.

2 Every pushing  button (button of left side), the unit numbers in the group control are successively displayed.

- The unit No. displayed at the first time indicates the master unit address.
- Fan and louver of the selected indoor unit only operate.

3 Push  button to finish the procedure.
All the indoor units in the group control stop.

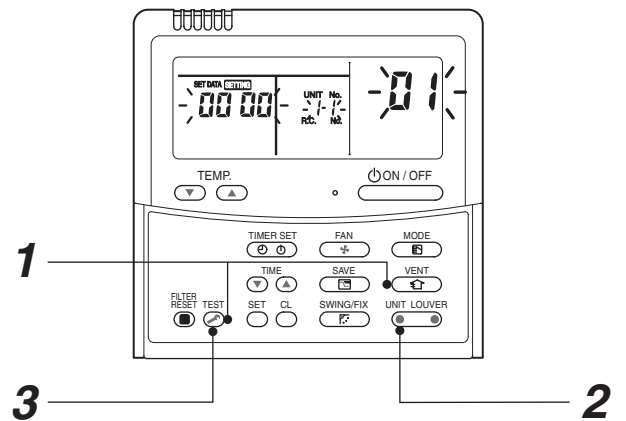

<Operation procedure>

1 → 2 → 3 END

<Maintenance/Check list>

Aiming in environmental preservation, it is strictly recommended to clean and maintain the indoor/outdoor units of the operating air conditioning system regularly to secure effective operation of the air conditioner.

It is also recommended to maintain the units once a year regularly when operating the air conditioner for a long time.

Check periodically signs of rust or scratches, etc. on coating of the outdoor units.

Repair the trouble position or apply the rust resisting paint if necessary.

If an indoor unit operates for approx. 8 hours or more per day, usually it is necessary to clean the indoor/outdoor units once three months at least.

These cleaning and maintenance should be carried out by a qualified dealer.

Although the customer has to pay the charge for the maintenance, the life of the unit can be prolonged.

Failure to clean the indoor/outdoor units regularly will cause shortage of capacity, freezing, water leakage or trouble on the compressor.

Part name	Object		Contents of check	Contents of maintenance
	Indoor	Outdoor		
Heat exchanger	✓	✓	• Blocking with dust, damage check	• Clean it when blocking is found.
Fan motor	✓	✓	• Audibility for sound	• When abnormal sound is heard
Filter	✓	—	• Visual check for dirt and breakage	• Clean with water if dirty • Replace if any breakage
Fan	✓	✓	• Visual check for swing and balance • Check adhesion of dust and external appearance.	• Replace fan when swinging or balance is remarkably poor. • If a large dust adheres, clean it with brush or water.
Suction/ Discharge grille	✓	—	• Visual check for dirt and scratch	• Repair or replace it if deformation or damage is found.
Drain pan	✓	—	• Check blocking by dust and dirt of drain water.	• Clean drain pan, Inclination check
Face panel, Louver	✓	—	• Check dirt and scratch.	• Cleaning/Coating with repair painting
External appearance	—	✓	• Check rust and peeling of insulator • Check peeling and floating of coating film	• Coating with repair painting

11. REPLACEMENT OF THE SERVICE P.C. BOARD

1. DN setting the jumper wires and DIP switches

Part name		Function	Setting
Jumper wire	J800 ~ J804	Model switching	Cut these jumper wires according to the following table.
	J805 ~ J807	Settings	Set these jumper wires same as the settings of the P.C. board before replacement.

Model switching (J800 to J804)

Since this service P.C. board is available for several models, cut the jumper wires according to the following table. If they are not cut correctly, a check code "L10" or "L29" appears on the remote controller and the operation of the air conditioner is disabled.

No.	Model name	J 800	J 801	J 802	J 803	J 804
00	Factory setting (default)	○	○	○	○	○
01	RAV-GP80*AT*	×	○	○	○	○
02	RAV-GP110*AT*	○	×	○	○	○
03	RAV-GP140*AT*	×	×	○	○	○
■ : Characters indicate the series number. * : Characters indicate the salt-affected model code (J), the country code (-E), and etc.		○:Connected, ×:Cut				

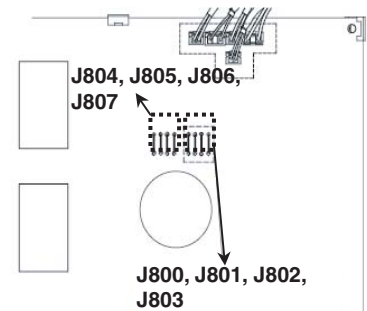

2. Installing the P.C. Board

- Please remove below parts in the following order.
① screw A(4p), ② COVER, ③ screw B(3p), ④ HEATSINK
- Please remove the following parts from the P.C. Board, and attach them to a Service P.C. Board.
⑤ ZCAT2132-1130(1p), ⑥ ZCAT2032-0930(2p), ⑦ TUBE, ⑧ FUSE-COVER, ⑨ SPACER
- Apply thermal grease to SUB-HEATSINK of Service P.C. Board.
- After installing Service P.C. Board and HEATSINK, Attach the removed parts and tighten by screws.
- Connect the lead wires according to the wiring diagram stuck on the backside of the panel.
- About the model of No.01, Insert the connector of fan motor into CN300. (Don't use CN400).
About the model of No.02-03, insert the connector of the upper fan motor into CN400, Insert the connector of the lower fan motor into CN300.

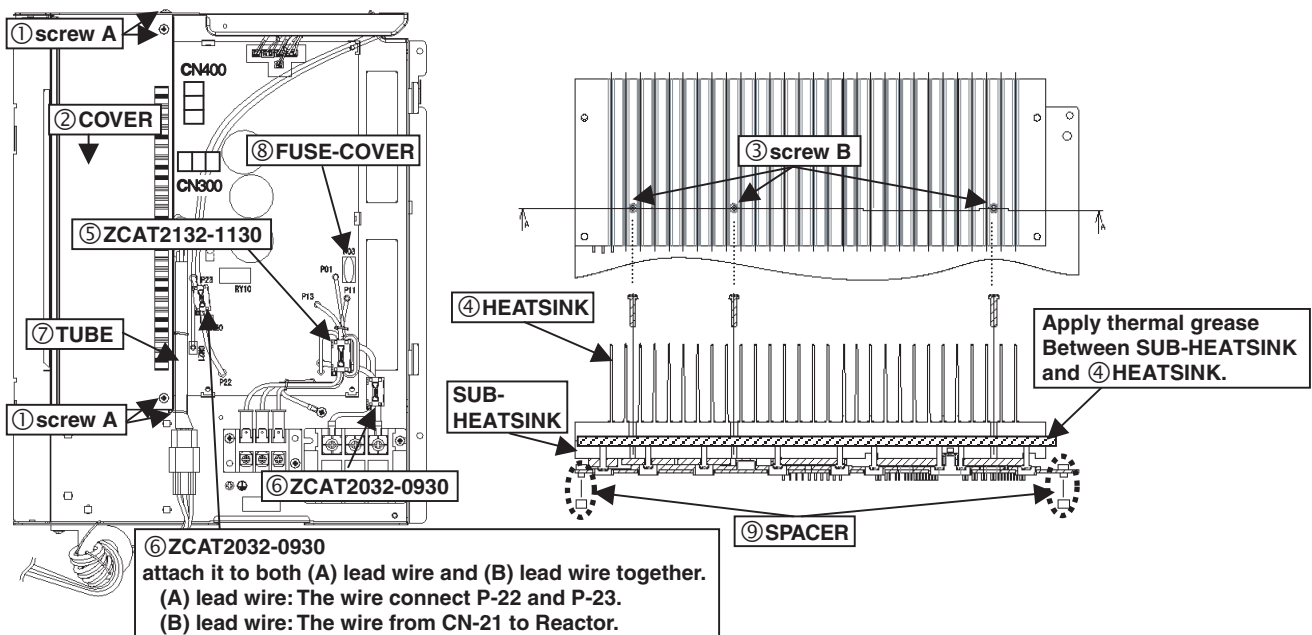

12. HOW TO EXCHANGE COMPRESSOR

12-1. Exchanging Procedure of Compressor (Outline)

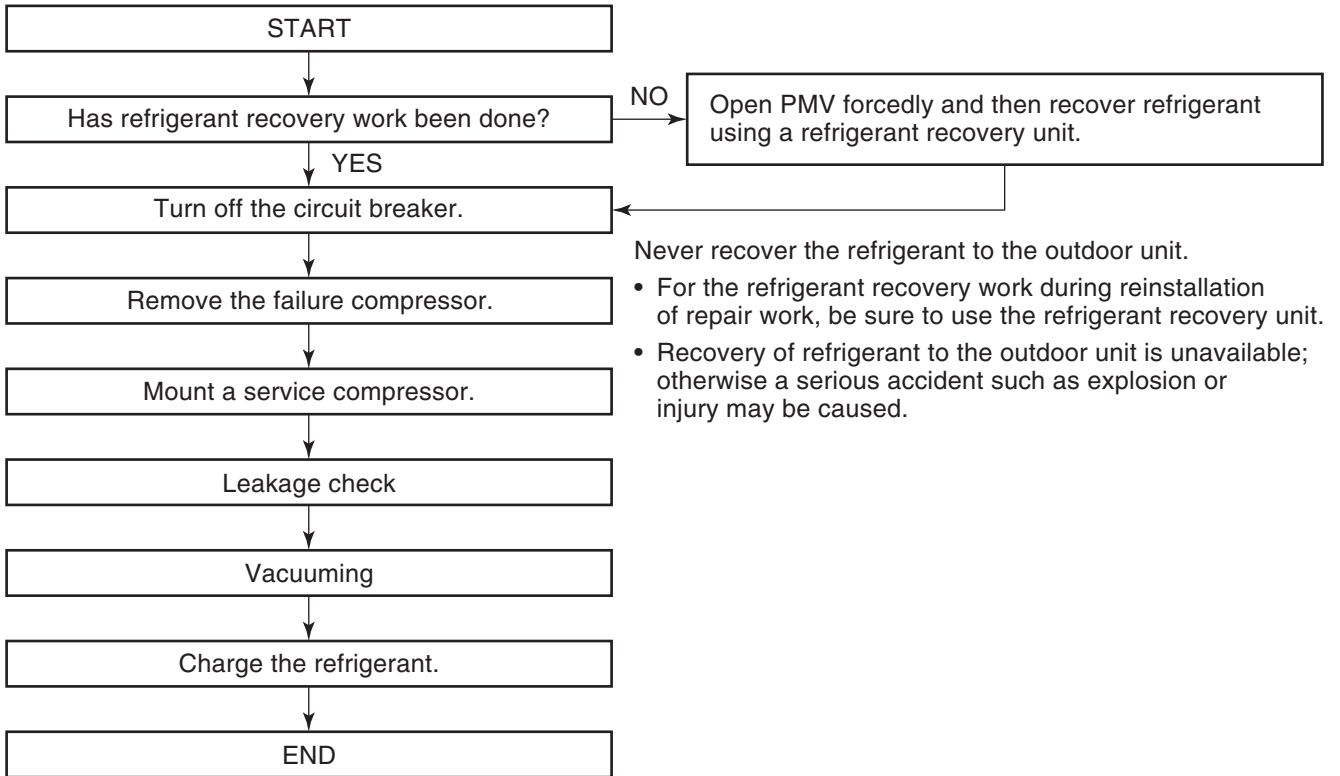





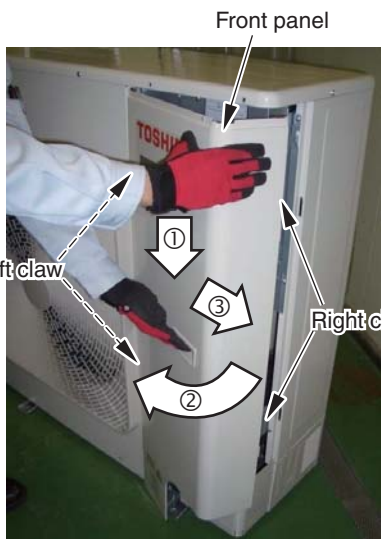

12-2. Exchange of Compressor

For exchange of compressors, refer to (11) Compressor in Section 13. **Attachments.**

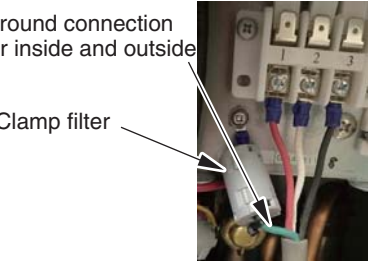
13. DETACHMENTS

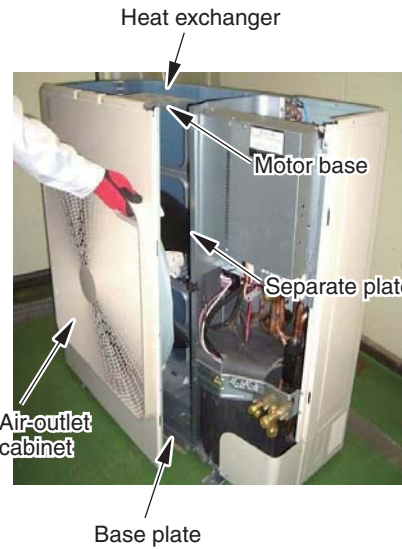

13-1. RAV-GP801AT*

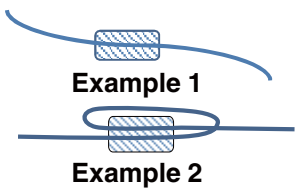
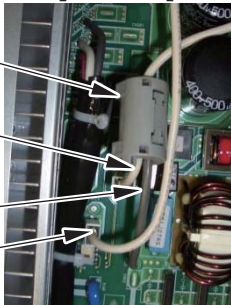
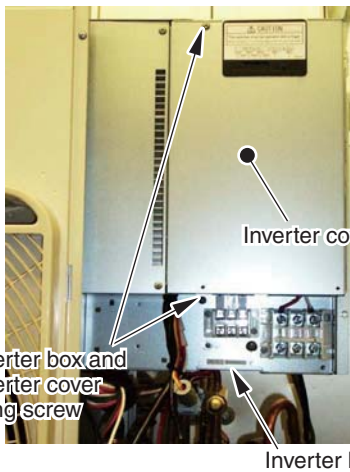
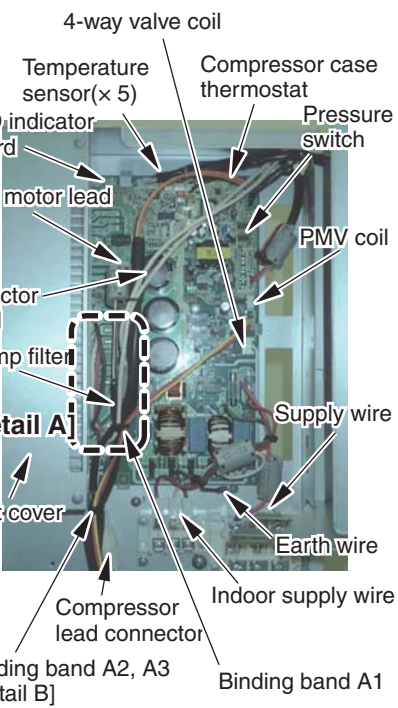
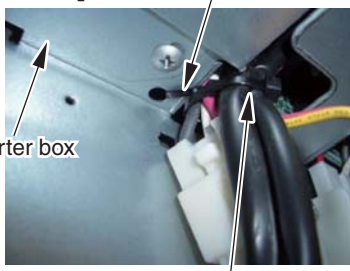

No.	Part name	Procedure	Remarks
①	Common procedures Front panel Top cover	<p style="text-align: center;">⚠ WARNING</p> <hr/> <p>Stop operation of the air conditioner and turn off breaker switch.</p> <hr/>	
		<p style="text-align: center;">⚠ CAUTION</p> <hr/> <p>Ensure wearing of gloves when performing any work in order to avoid injury from parts, etc.</p> <hr/>	
		<p>1. Detachment</p> <ol style="list-style-type: none"> 1) Stop operation of the air conditioner, and turn off the main switch of the breaker for air conditioner. 2) Remove the front panel. (3 pcs, DIA 4 ×10 hexagonal screws) <ol style="list-style-type: none"> (1) After removing the screws slide the front panel downwards. (2) Pull the front panel forwards and then loosen the right claw. (3) Pull the front panel to the right, loosen the left claw, and then remove the front panel. 3) Remove the terminal cover. (2 pcs, DIA 4 ×8 and claw) 4) Remove the power and indoor/outdoor connection wires from the wire clamps and terminals. 5) Remove the top cover. (6 pcs, DIA 4 ×10 hexagon screws) <p>2. Attachment</p> <ol style="list-style-type: none"> 1) Attach the top cover. (6 pcs, DIA 4 ×10 hexagon screws) 2) Connect the power and indoor/outdoor connection wires to the terminal and fix in place using the code clamps. <ul style="list-style-type: none"> * Check that the clamp filter is attached to the ground of the inside-outside connection wiring. <p>NOTE</p> <hr/> <p>The power and indoor/outdoor connection wires should be fixed in place along the crossing pipes using commercially available code clamps so as to avoid any contact with the compressor, gas side valve, gas side piping, and discharge pipe.</p> <hr/>	  
		<ol style="list-style-type: none"> 3) Attach the terminal cover. (2 pcs, DIA 4 ×8 and claw) 4) Attach the front panel. (3 pcs, DIA 4 ×10 hexagon screws) 	

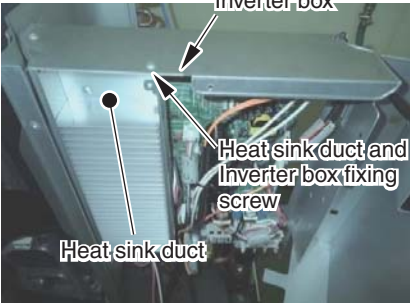
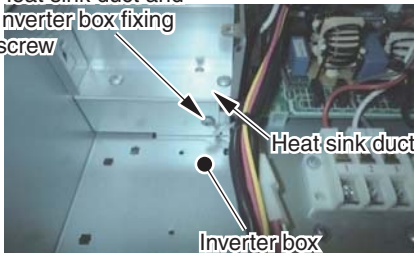
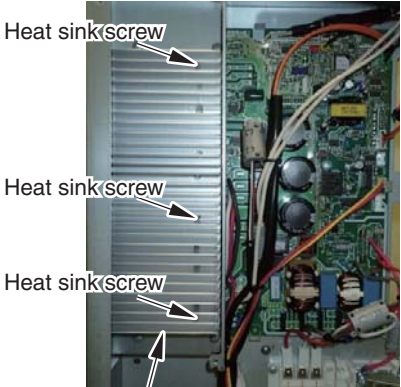
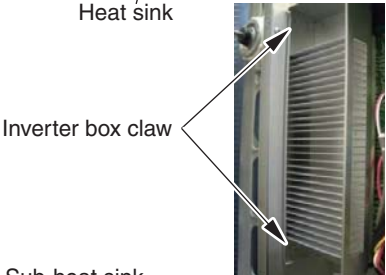
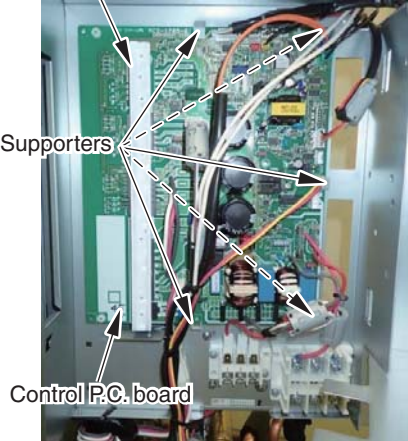
No.	Part name	Procedure	Remarks
②	Side cabinet (left)	<p>1. Detachment</p> <ol style="list-style-type: none"> 1) Following to work of Detachment of ①. 2) Remove the side cabinet (left) and base plate screws. (2 pcs, DIA 4 ×10 hexagon screws) 3) Slide the side cabinet (left) downwards and remove it. <p>2. Attachment</p> <p>Attach the side cabinet (left) in the reverse process of “1. Detachment”.</p>	
③	Air-outlet cabinet	<p>1. Detachment</p> <ol style="list-style-type: none"> 1) Following to work of Detachment of ① and ②. 2) Remove the screws from the Air-outlet cabinet and separate plate. (3 pcs, DIA 4 × 8) 3) Remove the screws from the Air-outlet cabinet and base plate. (2 pcs, DIA 4 × 10 hexagon screws) 4) Remove the screws from the Air-outlet cabinet and motor base. (2 pcs, DIA 4 × 8) 5) Remove the screws from the Air-outlet cabinet and heat exchanger. (3 pcs, DIA 4 × 8) <p>2. Attachment</p> <p>Attach the Air-outlet cabinet in the reverse process of “1. Detachment”.</p>	
④	Side cabinet (right)	<p>1. Detachment</p> <ol style="list-style-type: none"> 1) Following to work of Detachment of ①. 2) Remove the screws securing the inverter assembly and side cabinet (right). (2 pcs, DIA 4 × 8) 3) Remove the screws from the side cabinet (right) and valve fixing plate. (2 pcs, DIA 4 × 8) 4) Remove the screws from the side cabinet (right) and piping panel (rear). (2 pcs, DIA 4 ×10 hexagon screws) 5) Remove the screws from the side cabinet (right) and base plate. (1pcs, DIA 4 ×10 hexagon screw) 6) Remove the screws from the side cabinet (right) and heat exchanger. (3pcs, DIA 4 × 10 hexagon screws) <p>2. Attachment</p> <p>Attach the side cabinet (right) in the reverse process of “1. Detachment”.</p>	

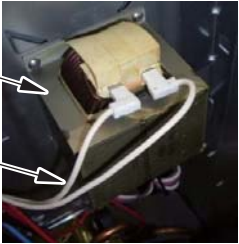
No.	Part name	Procedure	Remarks
⑤	Electrical part (Control P.C. board)	<p>1. Detachment (Control P.C. board)</p> <p>1) Following to work of Detachment of ①.</p> <p style="text-align: center;">WARNING</p> <hr/> <p>Do not disassemble the inverter for a minute after the power is turned off since there is a risk of electric shock.</p> <hr/> <p>*1.Ensure to bundle again with a commercially available code clamp</p> <p>*2.Ensure to fix the clamp filter where it was removed when reassembling the inverter.</p> <div style="text-align: center;">  <p>Example 1</p> <p>Example 2</p> </div> <ol style="list-style-type: none"> 2) Remove a screw fixing inverter box and inverter cover (Upper side). 3) Loosen a screw fixing inverter box and inverter cover (Lower side). 4) Cut the binding band A1 bundling the fan motor lead, compressor case thermostat lead, 4-way valve coil lead and reactor lead. (one position) 5) Cut the binding band A2 bundling the compressor lead, compressor case thermostat lead, 4-way valve coil lead and fan motor. (one position) 6) Remove the clamp filter from the reactor lead A1 and P.C. board lead. <div style="text-align: center;"> <p>[Detail.A]</p>  <p>Clamp filter (Example 1)</p> <p>Reactor lead B1</p> <p>Board lead wire</p> <p>Reactor lead B2</p> </div> <ol style="list-style-type: none"> 7) Remove the reactor lead B1 and the reactor lead B2 from control P.C. board. 8) Cut the binding band A3 fixing compressor lead and inverter box. 9) Remove the connector connecting to the control P.C. board. (Temperature sensor, PMV coil, 4-way valve coil, Compressor case thermostat, Pressure switch, Fan motor, LED indicator board) 10) Remove the connector of the compressor lead. * Release the lock on the housing part to remove the connector 11) Remove the earth wire connecting to the control board. (ST3T DIA 4×8 :1 pcs) 12) Remove supply wire (Red (L), White (N)) or indoor supply wire from each P.C. board 13) Remove the duct cover. (ST3T DIA 4×8 2 pcs) 	<div style="text-align: center;">  <p>Inverter cover</p> <p>Inverter box and Inverter cover fixing screw</p> <p>Inverter box</p> </div> <div style="text-align: center;">  <p>4-way valve coil</p> <p>Temperature sensor(x 5)</p> <p>Compressor case thermostat</p> <p>Pressure switch</p> <p>LED indicator board</p> <p>Fan motor lead</p> <p>Reactor lead</p> <p>Clamp filter</p> <p>PMV coil</p> <p>Supply wire</p> <p>Earth wire</p> <p>Indoor supply wire</p> <p>Compressor lead connector</p> <p>Binding band A2, A3 [Detail B]</p> <p>Binding band A1</p> <p>Duct cover</p> </div> <div style="text-align: center;"> <p>[Detail. B]</p>  <p>Binding band A3</p> <p>Inverter box</p> <p>Binding band A2</p> </div>

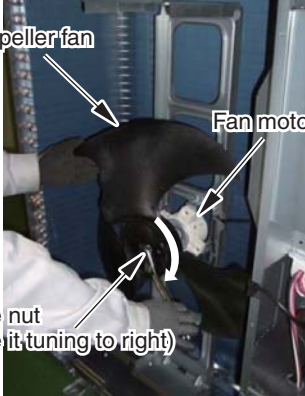
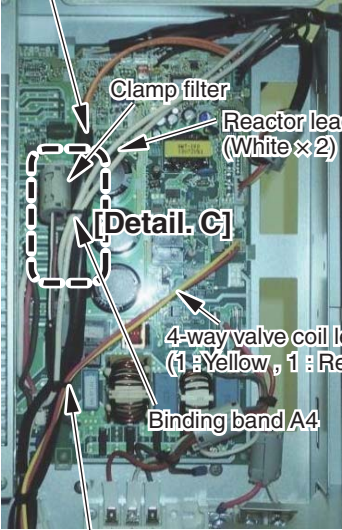
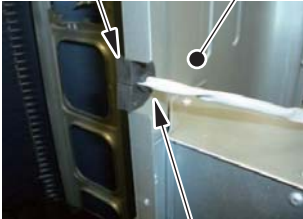

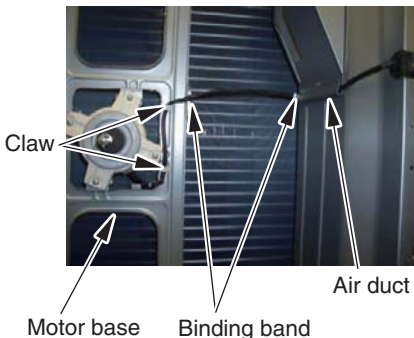
No.	Part name	Procedure	Remarks
⑤	Electrical part (Continued)	<p>14) Remove a screw fixing heat sink duct and inverter box. (ST3T DIA 4×8, 2 pcs)</p> <p>15) Remove the heat sink screw. (DIA 3×14, 3 PCS)</p> <p>16) Remove the inverter box claw being hooking the heat sink duct to remove the heat sink from control board assembly. (The heat sink can be removed with the heat sink duct attached.) It may not be easily to remove the heat sink because the heat sink silicon is coated between the heat sink and sub-heat sink.</p> <p style="text-align: center;">⚠ CAUTION</p> <hr/> <p>If dusts or scratches on the surface of the sub-heat sink or heat sink on the removed P.C. board occur, be careful to work as heat dissipation occur, causing the malfunction.</p> <hr/> <p>17) Remove the control board assembly. (Supporter 5 positions)</p> <p>2. Attachment (Control board)</p> <p>Attach the control board in the reverse process of "1. Detachment".</p> <p>*3.Coat the heat sink on the control board assembly with the heat sink silicon uniformly before installing the heat sink.</p>	    

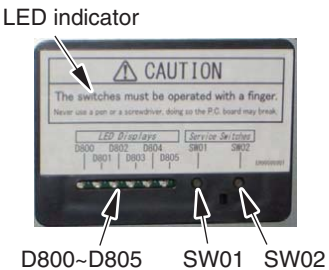

No.	Part name	Procedure	Remarks
⑤	Electric part (Reactor)	<p>3. Detachment (Reactor)</p> <ol style="list-style-type: none"> Following to work of Detachment of ④ Remove the connector of the reactor lead wire connected to the reactor. (2 positions) Remove the connector. (DIA 4 ST3T, 2 pcs.) <p>4. Attachment (Reactor)</p> <p>Attach the reactor in the reverse process of the "3. Detachment (Reactor)".</p>	
⑥	Fan motor	<p>1. Detachment</p> <ol style="list-style-type: none"> Following to work of Detachment of ①, ② and ③. Make sure that the fan motor and the propeller fan stop. Remove the flange nut from the fan motor and propeller fan. <ul style="list-style-type: none"> Loosen the flange nut by turning clock wise. (To tighten the flange nut, turn it counter clockwise) Remove the propeller fan. Following to work of Detachment of ⑤, 1) to 5). Cut the binding band A4 (Thickness :1.1 mm, Width :2.5 mm) bundling the case thermostat lead and the reactor lead x 2 <p>[Detail.C]</p>  <p>[Detail.C]</p> <ol style="list-style-type: none"> Remove the connector for the fan motor lead. (The clamp filter is removed and used when installing) Remove the fan motor lead from the fixing rubber for separate plate. 	 <p>Compressor case thermostat lead (Black tube)</p>  <p>[Detail.C]</p> 

No.	Part name	Procedure	Remarks
⑥	Fan motor (continued)	<p>8) Cut the binding band for the air duct fixing fan motor and the motor base (2 position).</p> <p>9) Loosen the two claws on the motor base.</p> <p>10) Remove the fixing screws (4 positions) while holding the fan motor so as not to fall it. (Shoulder screw with captive washer DIA 4 × 20 4 Psc each)</p> <p>2. Attachment</p> <p>Attach the Fan motor in the reverse process of “1. Detachment”.</p> <p>* Precautions when assembling the fan motor</p> <ul style="list-style-type: none"> • Tighten the flange nut to 4.95 N•m (50 kgf-cm). • To prevent the fan motor leads from coming in contact with the propeller fan ensure to adjust the length of the fan motor lead fixing rubber so that the fan motor lead has no slack. Attach the fan motor lead fixing rubber to the separate plate so that the projection is on the refrigeration cycle side. • Ensure to bundle in the part where a binding band was removed with a commercially available binding band. • Fix the clamp filter again in the place where it has been removed. 	 <p>Claw</p> <p>Motor base</p> <p>Binding band</p> <p>Air duct</p>  <p>Motor base</p> <p>Fan motor</p>

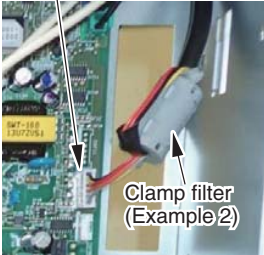

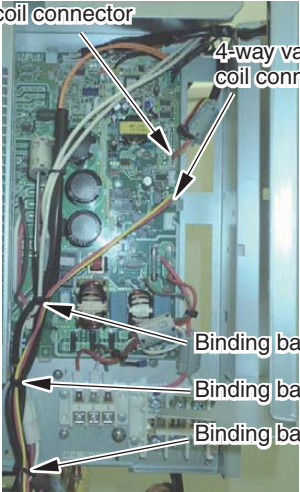
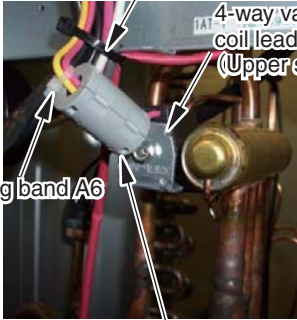
No.	Part name	Procedure	Remarks
⑦	Compressor and compressor lead	<p>1. Detachment</p> <p style="text-align: center;">⚠ WARNING</p> <hr/> <p>When removing the brazing part of the suction / discharge pipe of the compressor, remove the brazing part in a well-ventilated place after recovering the refrigerant. If recovery is insufficient, the refrigerant and refrigerating machine oil may blow, causing injury.</p> <hr/> <ol style="list-style-type: none"> 1) Recover refrigerant gas. 2) Following to work of Detachment of ① and ④. 3) Remove the piping panel (front). Remove the screws from piping panel (front) and base plate. (2 pcs, DIA 4 × 10 hexagon screws) Remove the screws from the piping panel (front) and piping panel (rear). (1 pcs, DIA 4 × 10 hexagon screw) 4) Remove the piping panel (rear). Remove the screws on the piping panel (rear) and the bottom plate. (2 pcs, DIA 4×10 hexagon screws) 5) Remove the valve fixing plate Remove the screws for the valve fixing plate and partition plate. (1 pcs, ST3T DIA 4 × 8) Remove two bolts at liquid valve side and valve fixing plate. (DELTITE screw M6 × 15 : 2 pcs) Remove two bolts at gas valve side and valve fixing plate. (DELTITE screw M6 × 15 : 2 pcs) 6) Remove the pipe cover and TD sensor fixed with the discharge pipe 7) Remove the sound insulation board (upper, inner, and outer). 8) Remove the compressor' terminal cover (two claws) and compressor lead and compressor case thermostat (one claw). 9) Cut the binding band fixing the inverter box (two positions) and the other binding band rolled around the compressor lead. 10) Remove the connector for the compressor lead to remove the compressor lead. (Keep the ferrite core attached to the electric parts box.) 11) Remove the discharge and suction pipes connected to the compressor using a burner. <p style="text-align: center;">⚠ WARNING</p> <hr/> <p>Ensure extreme caution when removing piping by melting the weld with a burner as fire may result if there is any oil within the piping.</p> <hr/> <p>NOTE</p> <hr/> <p>Carefully avoid contact with the 4-way valve and PMV with the flame (could result in a malfunction).</p> <hr/> <ol style="list-style-type: none"> 12) Remove the refrigeration cycle discharge and suction pipes by pulling them upwards. 13) Remove the compressor nuts securing the compressor to the base plate. (H13 × 3 nuts) 14) Pull the compressor forwards. <p>NOTE</p> <hr/> <p>The compressor weighs at least 15kg. Ensure two people carry out the work.</p>	<p>Pipe panel (front) Pipe panel (rear)</p> <p>DIA 4 screws Valve fixing screws</p> <p>Liquid valve Gas valve</p> <p>The sound proof board (top) The sound proof board (inner ring)</p> <p>Screw Screw</p> <p>Compressor lead binding band Terminal cover Compressor lead connector</p> <p>Binding band fixing inverter box (2 positions)</p> <p>Discharge pipe Pipe cover TD sensor</p> <p>The soundproof board (Upper) The soundproof board (Outer ring)</p> <p>Screw</p> <p>Compressor lead (Red • White • Black) Compressor case thermostat</p> <p>Discharge pipe (Remove here) Suction pipe (Remove here)</p> <p>Compressor bolts (H13 × 3 positions)</p>

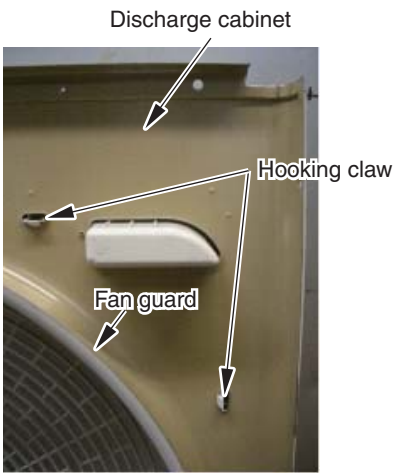
No.	Part name	Procedure	Remarks										
⑦	Compressor and compressor lead (continued)	<p>2. Attachment</p> <p>1) Attach the compressor in the reverse process of "1. Detachment".</p> <div style="border: 1px solid black; padding: 5px; margin: 10px 0;"> <ul style="list-style-type: none"> Also ensure to replace the compressor lead after replacing the compressor. (Compressor lead replacement code: 43160654) At this time please ensure to wind the compressor lead 4 times around the ferrite core. Install the sound insulation board (inner and outer) through the space between the compressor and the piping, and between the pipes and separate plate as shown on the right. </div> <p>3. Vacuum</p> <p>1) Connect the vacuum pump to the charge port of the liquid and gas pipe valves and the check joint on the high pressure side, and then operate the vacuum pump.</p> <p>2) Vacuum until the vacuum low pressure gauge reaches 1 (mmHg).</p> <p>NOTE</p> <p>Fully open the electronic control valve before the vacuum process. If closed the vacuum pipe between the liquid pipe valve and electronic control valve of the outdoor unit may not be able to be drawn through.</p> <hr/> <p>Method for forcibly fully opening the electronic control valve</p> <ul style="list-style-type: none"> Turn on the power supply breaker. Ensure that D805 of the LED indication of the outdoor is lit up. If D805 is not lit up (off or flashing) then push and hold down SW01 and SW02 at the same time for at least 5 seconds and check that D805 lights up. Push and hold SW01 down for at least 5 seconds or to confirm that D804 is slowly flashing (once/second). Push SW01 several times until the LED indications(D800 to D804) become the following. <table border="1" style="width: 100%; text-align: center; border-collapse: collapse;"> <tr> <td>D800</td> <td>D801</td> <td>D802</td> <td>D803</td> <td>D804</td> </tr> <tr> <td>○</td> <td>●</td> <td>○</td> <td>●</td> <td>◎</td> </tr> </table> <p>○: Go ON, ●: Go OFF, ◎: flash (5 times/sec.)</p> <ul style="list-style-type: none"> Push SW02 and D805 will start rapidly flashing. Push and hold SW02 down for at least 5 seconds and D804 will start slowly flashing. Once D805 lights up the PMV will start to open. After 30 seconds turn off the power breaker. <div style="text-align: center; margin: 10px 0;">  <p>LED indicator</p> <p>D800-D805 SW01 SW02</p> </div> <p>4. Refrigerant encapsulation</p> <p>1) Add the amount of refrigerant determined by the pipe length using the charge port of the valve.</p>	D800	D801	D802	D803	D804	○	●	○	●	◎	<p>Compressor lead connector</p> <p>Ferrite core Roll the compressor lead 4 times on the ferrite core.</p> <p>Compressor lead (Red • White • Black)</p> <p>Bundle Four-way valve lead, TD sensor lead, Compressor lead, Compressor case thermostat lead, and Fan motor lead to fix them into sheet metal hole on inverter box by binding band.</p> <p>Pull out the compressor lead and compressor case thermostat lead from this gap.</p> <p>Match the gap on the soundproof board (inner) to the compressor leg.</p> <p>Wrap the seam of the soundproof (inner) and soundproof (outer) about this position.</p> <p>Push redundant compressor lead, compressor case thermostat lead into a clearance between soundproof board (inner) and soundproof board (outer).</p> <p>Suction pipe</p> <p>Match the gap on sound proof board (outer) to the suction pipe.</p> <p>Pull out the compressor lead, the compressor case thermostat lead from the gap of the soundproof</p> <p>Push the sound proof plate (inner and upper) into the inside of the soundproof (outer) securely so that there is no clearance between sound proof (upper) and sound proof (outer)</p>
D800	D801	D802	D803	D804									
○	●	○	●	◎									

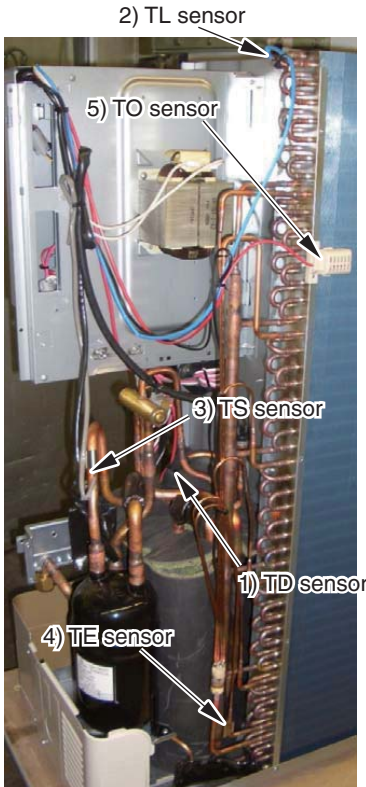
No.	Part name	Procedure	Remarks
⑧	PMV coil	<p>1. Detachment</p> <ol style="list-style-type: none"> Following to work of Detachment of ④. Cut the binding band (two positions) on the back surface Pull the connector for PMV coil out of control P.C. board. (Remove the clamp filter installed to near the connector to attach it to the coil lead replaced.) Remove the coil from the PMV body by rotating the coil (about 45°) while drawing the coil upward. <p>2. Attachment</p> <p>Attach the PMV coil in the reverse process of "1. Detachment"</p> <ol style="list-style-type: none"> Fix the coil positioning protrusions securely in the concavities of the PMV body. (Fix the coil in the direction where lead wire comes out at the body's left diagonally behind.) Attach the PMV coil connector to the control P.C. board. (Wind the connector wire to the clamp filter once and attach the clamp filter to near the connector.) <div style="display: flex; justify-content: space-around; margin-top: 10px;"> <div style="text-align: center;"> <p>PMV coil</p>  </div> <div style="text-align: center;"> <p>PMV coil connector</p>  <p>Clamp filter (Example 2)</p> </div> </div>	<p>Bundle the all lead wires on the back face and then cut the binding band fixing inverter box.</p>  <p>Cut the binding band bundling up TE sensor Black, TL sensor Blue, TS sensor Gray, Pressure switch (Black tube), Reactor lead White, PMV coil lead.</p>  <p>PMV coil connector</p> <p>4-way valve coil connector</p> <p>Binding band A1</p> <p>Binding band A2</p> <p>Binding band A5</p>
⑨	4-way valve coil	<p>1. Detachment</p> <ol style="list-style-type: none"> Following to work of Detachment of ⑤, 1) to 5). Cut the binding band A5 bundling up 4-way valve coil lead, TD sensor lead, Compressor lead, Compressor case thermostat lead and Fan motor lead. Cut the binding band A6 fixing the clamp filter. Remove the 4-way valve coil. (M5 screw) <p>2. Attachment</p> <p>Attach the 4-way valve coil in the reverse process of "1 Detachment".</p> <p>*1 Fix the 4-way coil with its lead wire upward.</p> <p>*2 Fix the clamp filter around the 4-way valve coil through a commercially available binding band into the hole for fixing binding band of clamp filter. (1 time pass)</p>	 <p>Binding band A5</p> <p>4-way valve coil lead wire (Upper side)</p> <p>Binding band A6</p> <p>Clamp filter one time pass</p>

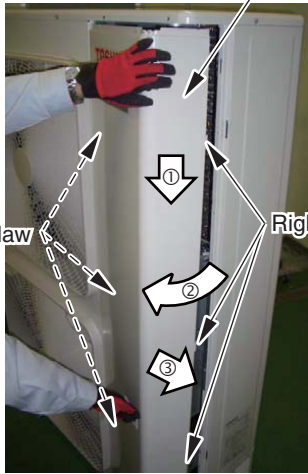
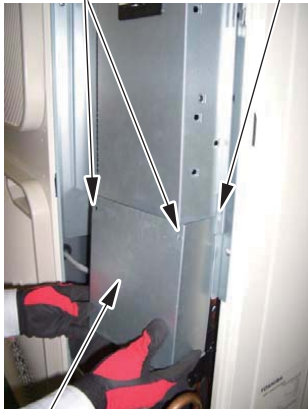

No.	Part name	Procedure	Remarks
⑩	Fan guard	<p>1. Detachment</p> <p>1) Following to work of Detachment of ③</p> <p>NOTE</p> <hr/> <p>Do the work on a cardboard or a cloth to prevent the product from being scratched.</p> <hr/> <p>2) Remove the outlet cabinet and place the fan guard side facing down.</p> <p>3) Remove the claws (8 places) of the fan guard.</p> <p>2. Attachment</p> <p>1) Hook the hooking claws from the front side and press the claws (8 places) by hand to fix them in place.</p> <p>NOTE</p> <hr/> <p>Ensure that all the claws are fixed in their specified position.</p> <hr/>	
⑪	[Reference] Sensor mount positions	<p>1) TD sensor: discharge pipe 2) TL sensor: heat exchanger upside 3) TS sensor: 4-way valve - between accumulator 4) TE sensor: lowest capillary joint 5) TO sensor: Heat exchange surface</p> 	

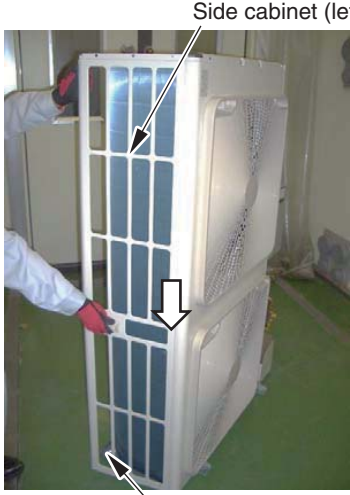
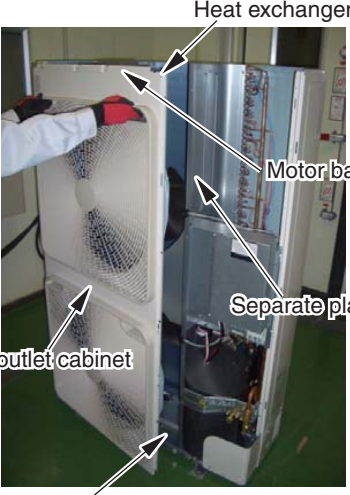
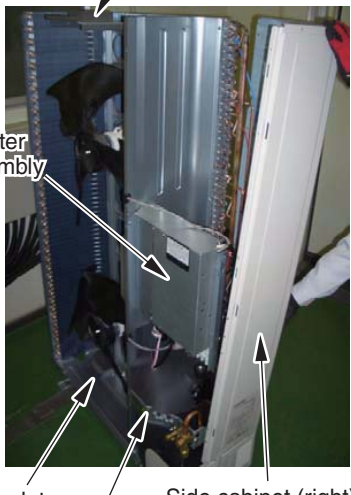

13-2. RAV-GP1101AT*, GP1401AT*

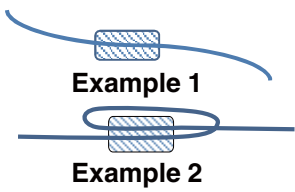
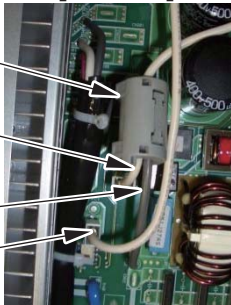
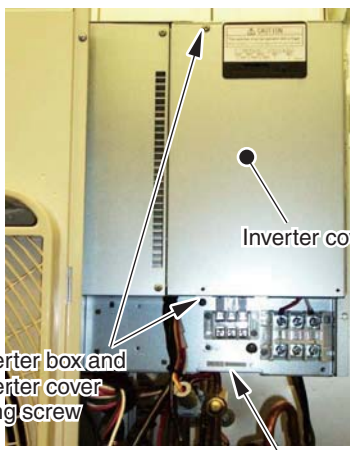
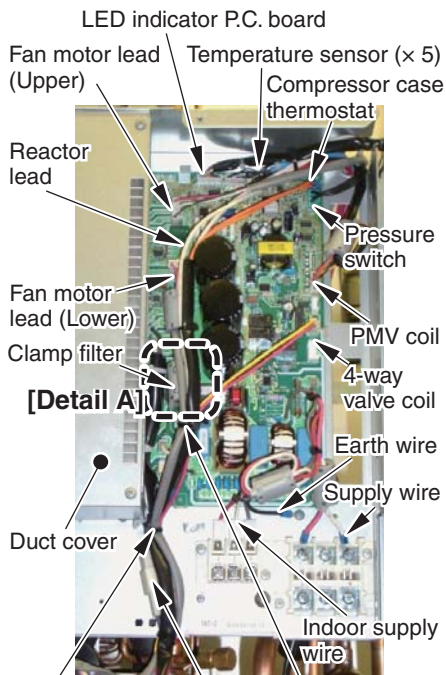
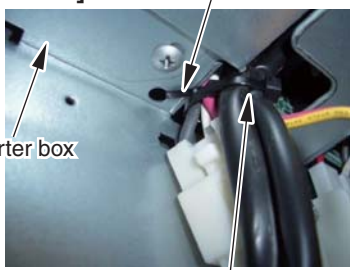
No.	Part name	Procedure	Remarks
①	Common procedures Front panel Top cover	<p style="text-align: center;">⚠ WARNING</p> <hr/> <p>Stop operation of the air conditioner and turn off breaker switch.</p> <hr/> <p style="text-align: center;">⚠ CAUTION</p> <hr/> <p>Ensure wearing of gloves when performing any work in order to avoid injury from parts, etc.</p> <hr/> <p>1. Detachment</p> <ol style="list-style-type: none"> 1) Stop operation of the air conditioner, and turn off the main switch of the breaker for air conditioner. 2) Remove the front panel. (3 pcs, DIA 4 ×10 hexagonal screws) <ol style="list-style-type: none"> (1) After removing the screws slide the front panel downwards. (2) Pull the front panel forwards and then loosen the right claw. (3) Pull the front panel to the right, loosen the left claw, and then remove the front panel. 3) Remove the terminal cover. (2 pcs, DIA 4 ×8 and claw) 4) Remove the power and indoor/outdoor connection wires from the wire clamps and terminals. 5) Remove the top cover. (6 pcs, DIA 4 ×10 hexagon screws) <p>2. Attachment</p> <ol style="list-style-type: none"> 1) Attach the top cover. (6 pcs, DIA 4 ×10 hexagon screws) 2) Connect the power and indoor/outdoor connection wires to the terminal and fix in place using the code clamps. <ul style="list-style-type: none"> * Check that the clamp filter is attached to the ground of the inside-outside connection wiring. <p>NOTE</p> <hr/> <p>The power and indoor/outdoor connection wires should be fixed in place along the crossing pipes using commercially available binding bands so as to avoid any contact with the compressor, gas side valve, gas side piping, and discharge pipe.</p> <hr/> <ol style="list-style-type: none"> 3) Attach the terminal cover. (2 pcs, DIA 4 × 8 and claw) 4) Attach the front panel. (3 pcs, DIA 4 ×10 hexagon screws) 	<p style="text-align: right;">Front panel</p>  <p style="text-align: left;">Left claw</p> <p style="text-align: right;">Right claw</p> <p style="text-align: center;">Screws</p> <p style="text-align: right;">Right claw</p>  <p style="text-align: left;">Terminal cover</p> <p style="text-align: right;">Top cover</p> 

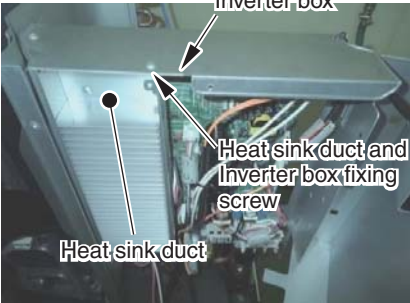
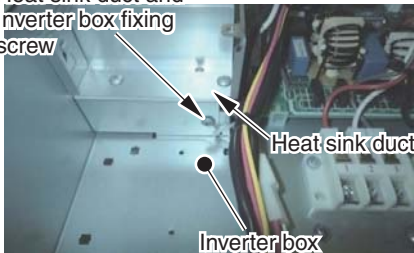
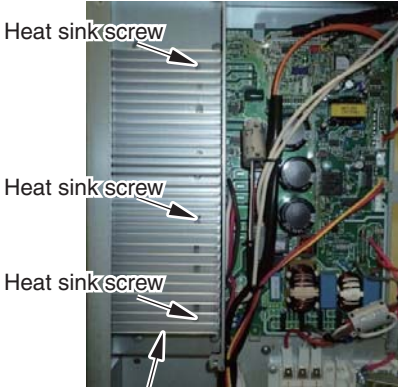

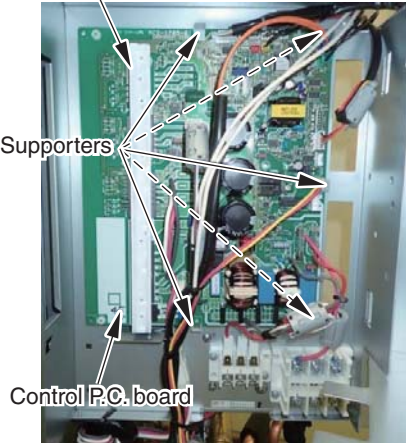
No.	Part name	Procedure	Remarks
②	Side cabinet (left)	<p>1. Detachment</p> <ol style="list-style-type: none"> 1) Following to work of Detachment of ①. 2) Remove the side cabinet (left) and base plate screws. (2 pcs, DIA 4 × 10 hexagon screws) 3) Slide the side cabinet (left) downwards and remove it. <p>2. Attachment</p> <p>Attach the side cabinet (left) in the reverse process of “1. Detachment”.</p>	 <p>Side cabinet (left)</p> <p>Base plate</p>
③	Air-outlet cabinet	<p>1. Detachment</p> <ol style="list-style-type: none"> 1) Following to work of Detachment of ① and ②. 2) Remove the screws from the Air-outlet cabinet and separate plate. (4 pcs, DIA 4 × 8) 3) Remove the screws from the Air-outlet cabinet and base plate. (2 pcs, DIA 4 × 10 hexagon screws) 4) Remove the screws from the Air-outlet cabinet and motor base. (2 pcs, DIA 4 × 8) 5) Remove the screws from the Air-outlet cabinet and heat exchanger. (3 pcs, DIA 4 × 8) <p>2. Attachment</p> <p>Attach the Air-outlet cabinet in the reverse process of “1. Detachment”.</p>	 <p>Heat exchanger</p> <p>Motor base</p> <p>Separate plate</p> <p>Air-outlet cabinet</p> <p>Base plate</p>
④	Side cabinet (right)	<p>1. Detachment</p> <ol style="list-style-type: none"> 1) Following to work of Detachment of ①. 2) Remove the screws securing the inverter assembly and side cabinet (right). (2 pcs, DIA 4 × 8) 3) Remove the screws from the side cabinet (right) and valve fixing plate. (2 pcs, DIA 4 × 8) 4) Remove the screws from the side cabinet (right) and piping panel (rear). (2 pcs, DIA 4 × 10 hexagon screws) 5) Remove the screws from the side cabinet (right) and base plate. (1 pcs, DIA 4 × 10 hexagon screw) 6) Remove the screws from the side cabinet (right) and heat exchanger. (3 pcs, DIA 4 × 10 hexagon screws) <p>2. Attachment</p> <p>Attach the side cabinet (right) in the reverse process of “1. Detachment”.</p>	 <p>Heat exchanger</p> <p>Inverter assembly</p> <p>Base plate</p> <p>Valve fixing plate</p> <p>Side cabinet (right)</p>

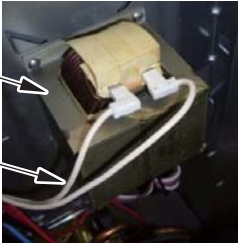

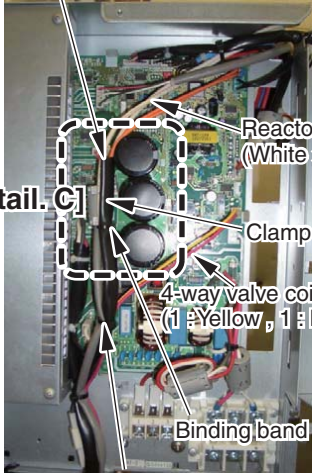
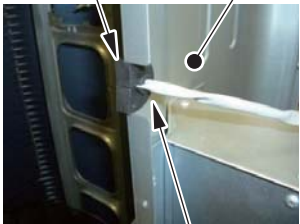

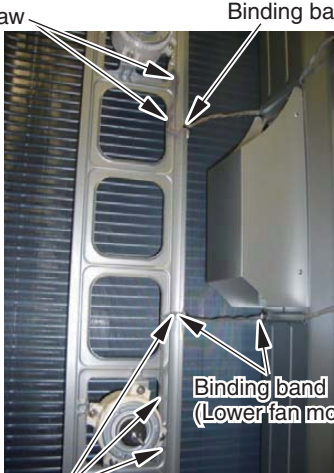
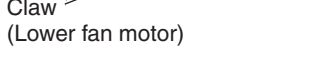
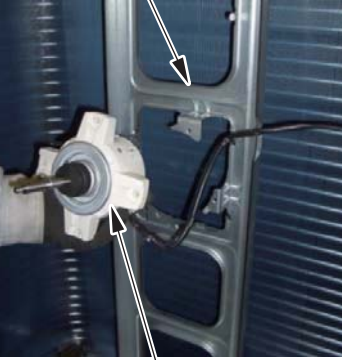
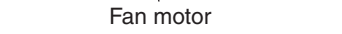
No.	Part name	Procedure	Remarks
⑤	Electrical part (Control P.C. board)	<p>1. Detachment (Control P.C. board)</p> <p>1) Following to work of Detachment of ①.</p> <p style="text-align: center;">WARNING</p> <hr/> <p>Do not disassemble the inverter for a minute after the power is turned off since there is a risk of electric shock.</p> <hr/> <p>*1.Ensure to bundle again with a commercially available code clamp</p> <p>*2.Ensure to fix the place where it was removed using the clamp filter when reassembling the inverter.</p> <div style="text-align: center;">  <p>Example 1</p> <p>Example 2</p> </div> <p>2) Remove a screw fixing inverter box and inverter cover (Upper side).</p> <p>3) Loose a screw fixing inverter box and inverter cover (Lower side).</p> <p>4) Cut the binding band A1 bundling the fan motor lead, compressor case thermostat lead, 4-way valve coil lead and reactor lead. (one position)</p> <p>5) Cut the binding band A2 bundling the compressor lead, compressor case thermostat lead, 4-way valve coil lead and fan motor. (one position)</p> <p>6) Remove the clamp filter from the reactor lead B1 and P.C. board lead.</p> <div style="text-align: center;"> <p>[Detail.A]</p>  </div> <p>7) Remove the reactor lead B1 and the reactor lead B2 from control P.C. board.</p> <p>8) Cut the binding band A3 fixing compressor lead and inverter box.</p> <p>9) Remove the connector connecting to the control P.C. board. (Temperature sensor, PMV coil, 4-way valve coil, Compressor case thermostat, Pressure switch, Fan motor, LED indicator board)</p> <p>10) Remove the connector of the compressor lead. * Release the lock on the housing part to remove the connector</p> <p>11) Remove the earth wire connecting to the control board. (ST3T DIA 4×8 :1 pcs)</p> <p>12) Remove supply wire (Red (L), White (N)) or indoor supply wire from each P.C. board</p> <p>13) Remove the duct cover. (ST3T DIA4×8 2 pcs)</p>	<div style="text-align: center;">  </div> <div style="text-align: center;">  </div> <div style="text-align: center;"> <p>[Detail. B]</p>  </div>

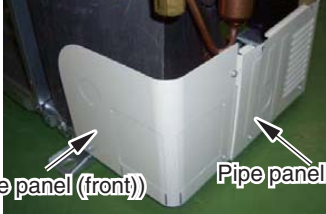
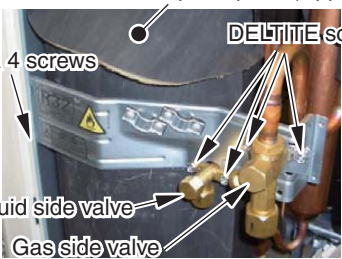
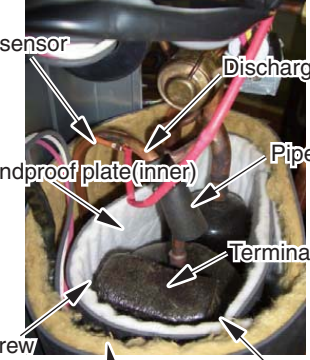
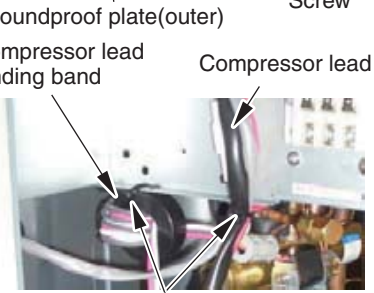
No.	Part name	Procedure	Remarks
⑤	Electrical part (Continued)	<p>14) Remove screws fixing the heat sink duct and inverter box. (ST3T DIA 4×8, 2 pcs)</p> <p>15) Remove the heat sink screw. (DIA 3×14, 3 PCS)</p> <p>16) Remove the inverter box claw being hooking the heat sink duct to remove the heat sink from control board assembly. (The heat sink can be removed with the heat sink duct attached.) It may not be easily to remove the heat sink because the heat sink silicon is coated between the heat sink and sub-heat sink.</p> <p style="text-align: center;">⚠ CAUTION</p> <hr/> <p>If dusts or scratches on the surface of the sub-heat sink or heat sink on the removed P.C. board occur, be careful to work as heat dissipation occur, cause the malfunction.</p> <hr/> <p>17) Remove the control board assembly. (Supporter 5 positions)</p> <p>2. Attachment (Control board)</p> <p>Attach the control board in the reverse process of "1. Detachment".</p> <p>*3.Coat the heat sink on the control board assembly with the heat sink silicon uniformly before installing the heat sink.</p>	     

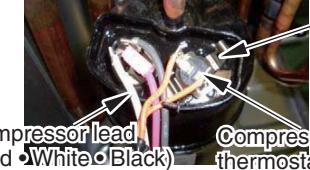
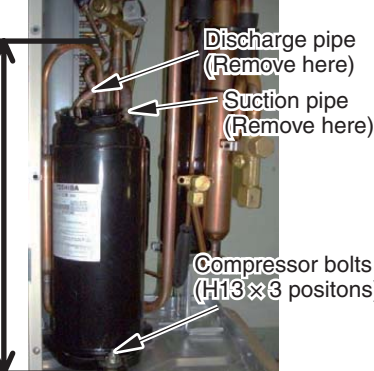

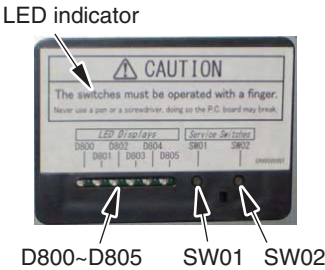
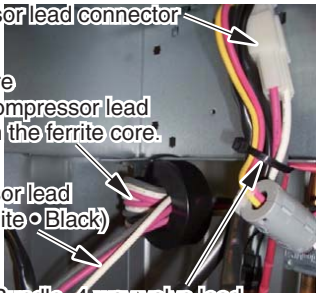
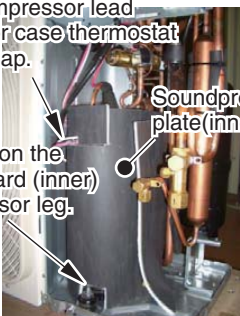

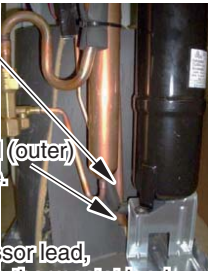
No.	Part name	Procedure	Remarks
⑤	Electric part (Reactor)	<p>3. Detachment (Reactor)</p> <ol style="list-style-type: none"> Following to work of Detachment of ④. Remove the connector of the reactor lead wire connected to the reactor. (2 positions) Remove the connector. (DIA 4 ST3T, 2 pcs.) <p>4. Attachment (Reactor)</p> <p>Attach the reactor in the reverse process of the "3. Detachment (Reactor)".</p>	
⑥	Fan motor	<p>1. Detachment</p> <ol style="list-style-type: none"> Following to work of Detachment of ①, ② and ③. Make sure that the fan motor and the propeller fan stop. Remove the flange nut from the fan motor and propeller fan. <ul style="list-style-type: none"> Loosen the flange nut by turning clock wise. (To tighten the flange nut, turn it counter clockwise) Remove the propeller fan. Following to work of Detachment of ⑤, 1) to 5). Cut the binding band A4 (Thickness :1.1 mm, Width :2.5 mm) bundling the case thermostat lead and the reactor lead x 2 <p>[Detail.C]</p>  <p>Pass the binding band A4 through the hole on the clamp filter, and then bundle two reactor leads.</p> <ol style="list-style-type: none"> Remove the connector for the fan motor lead. Remove the clamp filter from the fan motor lead. (It is used after replacement.) Remove the fan motor lead from the fixing rubber for separate plate. 	 <p>Compressor case thermostat lead (Black tube)</p>  <p>[Detail.C]</p> <p>Binding band A1</p> 

No.	Part name	Procedure	Remarks
⑥	Fan motor (Continued)	<p>8) Cut the binding band for the air duct fixing fan motor and the motor base (2 position). For upper fan motor: one at the motor base For lower fan motor: one at the motor base one at the air duct</p> <p>Loose the claw on the fan motor base (2 positions) For upper fan motor: 2 positions For lower fan motor: 3 positions</p> <p>9) Loosen two claws on the motor base.</p> <p>10) Remove the fixing screws (4 positions) while holding the fan motor so as not to fall it. (Shoulder screw with captive washer DIA 4 × 20 4 Each 4Pcs)</p> <p>2. Attachment</p> <p>Attach the Fan motor in the reverse process of "1. Detachment".</p> <p>* Precautions when assembling the fan motor</p> <ul style="list-style-type: none"> • Tighten the flange nut to 4.95 N•m (50 kgf•cm). • To prevent the fan motor leads from coming in contact with the propeller fan ensure to adjust the length of the fan motor lead fixing rubber so that the fan motor lead has no slack. Attach the fan motor lead fixing rubber to the separate plate so that the projection is on the refrigeration cycle side. • Ensure to bundle the place where the binding band was removed with a commercially available binding band again. • Fix the place where binding band has been removed using binding band again. 	 <p>Claw</p> <p>Binding band</p>  <p>Claw (Lower fan motor)</p> <p>Binding band (Lower fan motor)</p>  <p>Motor base</p>  <p>Fan motor</p>

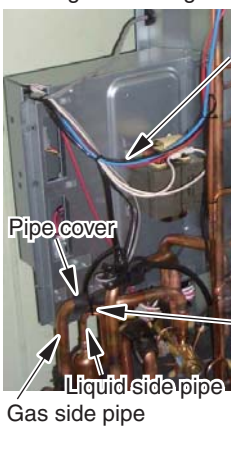
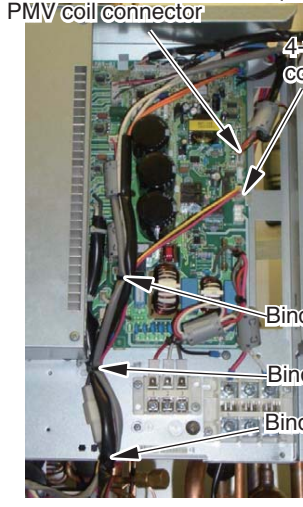
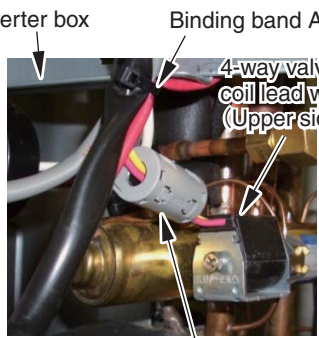
No.	Part name	Procedure	Remarks
⑦	Compressor and compressor lead	<p>1. Detachment</p> <p style="text-align: center;">⚠ WARNING</p> <p>When removing the brazing part of the suction / discharge pipe of the compressor, remove the brazing part in a well-ventilated place after recovering the refrigerant. If recovery is insufficient, the refrigerant and refrigerating machine oil may blow, causing injury.</p> <ol style="list-style-type: none"> 1) Recover refrigerant gas. 2) Following to work of Detachment of ① and ④. 3) Remove the piping panel (front). Remove the screws from piping panel (front) and base plate. (2 pcs, DIA 4 × 10 hexagon screws) Remove the screws from the piping panel (front) and piping panel (rear). (1 pcs, DIA 4 × 10 hexagon screw) 4) Remove the piping panel (rear). Remove the screws on the piping panel (rear) and the bottom plate. (2 pcs, DIA 4×10 hexagon screws) 5) Remove the valve fixing plate Remove the screws for the valve fixing plate Remove 2 bolts at liquid valve side and valve fixing plate. (2 pcs DELTITE screw M6 ×15) Remove 2 bolts at gas valve side and valve fixing plate. (2 pcs DELTITE screw M6 ×15) 6) Remove the pipe cover and TD sensor fixed with the discharge pipe 7) Remove the sound insulation board (upper, inner, and outer). 8) Remove the compressor's terminal cover (2 claws) and compressor lead and compressor case thermostat (one claw). 9) Cut the binding band fixing the inverter box (2 positions) and the other binding band rolled around the compressor lead. 10) Remove the connector for the compressor lead to remove the compressor lead. (Keep the ferrite core attached to the electric parts box.) 11) Remove the discharge and suction pipes connected to the compressor using a burner. <p style="text-align: center;">⚠ WARNING</p> <p>Ensure extreme caution when removing piping by melting the weld with a burner as fire may result if there is any oil within the piping.</p> <p>NOTE</p> <p>Carefully avoid contact with the 4-way valve and PMV with the flame (could result in a malfunction).</p> <ol style="list-style-type: none"> 12) Remove the refrigeration cycle discharge and suction pipes by pulling them upwards. 13) Remove the compressor nuts securing the compressor to the base plate. (H13 × 3 nuts) 14) Pull the compressor forwards. <p>NOTE</p> <p>The compressor weighs at least 15kg. Ensure two people carry out the work.</p>	 <p>Pipe panel (front) Pipe panel (rear)</p>  <p>Sound proof panel(Upper) DELTITE screw DIA 4 screws Liquid side valve Gas side valve</p>  <p>TD sensor Discharge pipe Soundproof plate(inner) Pipe cover Terminal cover Screw</p>  <p>Soundproof plate(outer) Compressor lead binding band Compressor lead</p>  <p>Binding band fixing inverter box (2 positions)</p>  <p>Screw Compressor lead (Red • White • Black) Compressor case thermostat</p>  <p>Discharge pipe (Remove here) Suction pipe (Remove here) 468 Compressor bolts (H13 × 3 positions)</p>

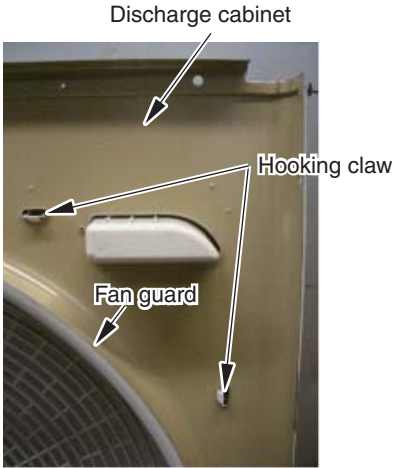
No.	Part name	Procedure	Remarks										
⑦	Compressor and compressor lead (Continued)	<p>2. Attachment</p> <p>1) Attach the compressor in the reverse process of “1. Detachment”.</p> <div style="border: 1px solid black; padding: 5px; margin: 10px 0;"> <ul style="list-style-type: none"> Also ensure to replace the compressor lead after replacing the compressor. (Compressor lead replacement code: 43160654) At this time please ensure to wind the compressor lead 4 times around the ferrite core. Install the sound insulation board (inner and outer) through the space between the compressor and the piping, and between the pipes and separate plate as shown on the right. </div> <p>3. Vacuum</p> <p>1) Connect the vacuum pump to the charge port of the liquid and gas pipe valves and the check joint on the high pressure side, and then operate the vacuum pump.</p> <p>2) Vacuum until the vacuum low pressure gauge reaches 1 (mmHg).</p> <p>NOTE</p> <p>Fully open the electronic control valve before the vacuum process. If closed the vacuum pipe between the liquid pipe valve and electronic control valve of the outdoor unit may not be able to be drawn through.</p> <p>Method for forcibly fully opening the electronic control valve</p> <ul style="list-style-type: none"> Turn on the power supply breaker. Ensure that D805 of the LED indication of the outdoor is lit up. If D805 is not lit up (off or flashing) then push and hold down SW01 and SW02 at the same time for at least 5 seconds and check that D805 lights up. Push and hold SW01 down for at least 5 seconds or to confirm that D804 is slowly flashing (once/second). Push SW01 several times until the LED indications(D800 to D804) become the following. <table border="1" style="width: 100%; text-align: center; border-collapse: collapse;"> <tr> <td>D800</td> <td>D801</td> <td>D802</td> <td>D803</td> <td>D804</td> </tr> <tr> <td>○</td> <td>●</td> <td>○</td> <td>●</td> <td>◎</td> </tr> </table> <p>○: Go ON, ●: Go OFF, ◎: flash (5 times/sec.)</p> <ul style="list-style-type: none"> Push SW02 and D805 will start rapidly flashing. Push and hold SW02 down for at least 5 seconds and D804 will start slowly flashing. Once D805 lights up the PMV will start to open. After 30 seconds turn off the power breaker. <div style="text-align: center; margin: 10px 0;">  <p>LED indicator</p> <p>D800-D805 SW01 SW02</p> </div> <p>4. Refrigerant encapsulation</p> <p>1) Add the amount of refrigerant determined by the pipe length using the charge port of the valve.</p>	D800	D801	D802	D803	D804	○	●	○	●	◎	<p>Compressor lead connector</p>  <p>Ferrite core Roll the compressor lead 4 times on the ferrite core.</p> <p>Compressor lead (Red • White • Black)</p> <p>Bundle 4-way valve lead, TD sensor lead, Compressor lead, Compressor case thermostat lead, and Fan motor lead to fix them into sheet metal hole on inverter box by binding band.</p> <p>Pull out the compressor lead and compressor case thermostat lead from this gap.</p>  <p>Soundproof plate(inner)</p> <p>Match the gap on the soundproof board (inner) to the compressor leg.</p> <p>Wrap the seam of the soundproof (inner) and soundproof (outer) about this position.</p>  <p>Push redundant compressor lead, compressor case thermostat lead into a clearance between soundproof board (inner) and soundproof board (outer).</p> <p>Suction pipe</p>  <p>Match the gap on sound proof board (outer) to the suction pipe.</p> <p>Pull out the compressor lead, the compressor case thermostat lead from the gap of the soundproof</p>  <p>Push the sound proof plate (inner and upper) into the inside of the soundproof (outer) securely so that there is no clearance between sound proof (upper) and sound proof (outer)</p>
D800	D801	D802	D803	D804									
○	●	○	●	◎									

No.	Part name	Procedure	Remarks
⑧	PMV coil	<p>1. Detachment</p> <ol style="list-style-type: none"> Following to work of Detachment of ④. Cut the binding band (2 positions) on the back surface Pull the connector for PMV coil out of control P.C. board. (Remove the clamp filter installed to near the connector to attach it to the coil lead replaced.) Remove the coil from the PMV body by rotating the coil (about 45°) while drawing the coil upward. <p>2. Attachment</p> <p>Attach the PMV coil in the reverse process of "1. Detachment"</p> <ol style="list-style-type: none"> Fix the coil positioning protrusions securely in the concavities of the PMV body. (Fix the coil in the direction where lead wire comes out at the body's left diagonally behind.) Attach the PMV coil connector to the control P.C. board. (Wind the connector wire to the clamp filter once and attach the clamp filter to near the connector.) 	<p>Bundle the all lead wires on the back face and then cut the binding band fixing inverter box.</p>  <p>Cut the binding band bundling up TO sensor Red, TE sensor Black, TL sensor Blue, TS sensor Gray, Pressure switch (Black tube), Reactor lead White, PMV coil lead.</p> <p>Cut the binding band bundling up PMV coil lead, pipe cover, gas side pipe and liquid side pipe.</p> 
⑨	4-way valve coil	<p>1. Detachment</p> <ol style="list-style-type: none"> Following to work of Detachment of ①, 1) to 5). Cut the binding band A5 bundling up 4-way valve coil lead, TD sensor lead, Compressor lead, Compressor case thermostat lead and Fan motor lead. Remove the 4-way valve coil. (M5 screw) <p>2. Attachment</p> <p>Attach the 4-way valve coil in the reverse process of "1 Detachment".</p> <p>*1 Fix the 4-way coil with its lead wire upward.</p> <p>*2 Fix the clamp filter around the 4-way valve coil through a commercially available binding band into the hole for fixing binding band of clamp filter. (1 time pass)</p>	

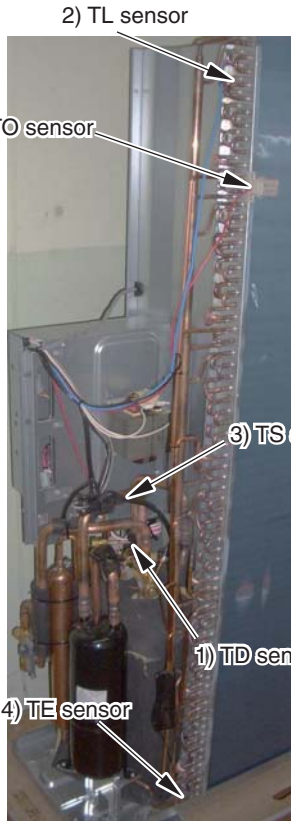
No.	Part name	Procedure	Remarks
⑩	Fan guard	<p>1. Detachment</p> <p>1) Following to work of Detachment of ③.</p> <p>NOTE</p> <hr/> <p>Do the work on a cardboard or a cloth to prevent the product from being scratched.</p> <hr/> <p>2) Remove the outlet cabinet and place the fan guard side facing down.</p> <p>3) Remove the claws (8 places) of the fan guard.</p> <p>2. Attachment</p> <p>1) Hook the hooking claws from the front side and press the claws (8 places) by hand to fix them in place.</p> <p>NOTE</p> <hr/> <p>Ensure that all the claws are fixed in their specified position.</p> <hr/>	
⑪	[Reference] Sensor mount positions	<p>1) TD sensor: discharge pipe 2) TL sensor: heat exchanger upside 3) TS sensor: 4-way valve - between accumulator 4) TE sensor: lowest capillary joint 5) TO sensor: Heat exchange surface</p> <p>1) TD sensor</p>  <p>2) TL sensor</p>  <p>3) TS sensor</p>  <p>4) TE sensor</p> 	

14. EXPLODED VIEWS AND PARTS LIST

14-1. Outdoor Unit

RAV-GP801AT(J)-E, RAV-GP801AT-TR

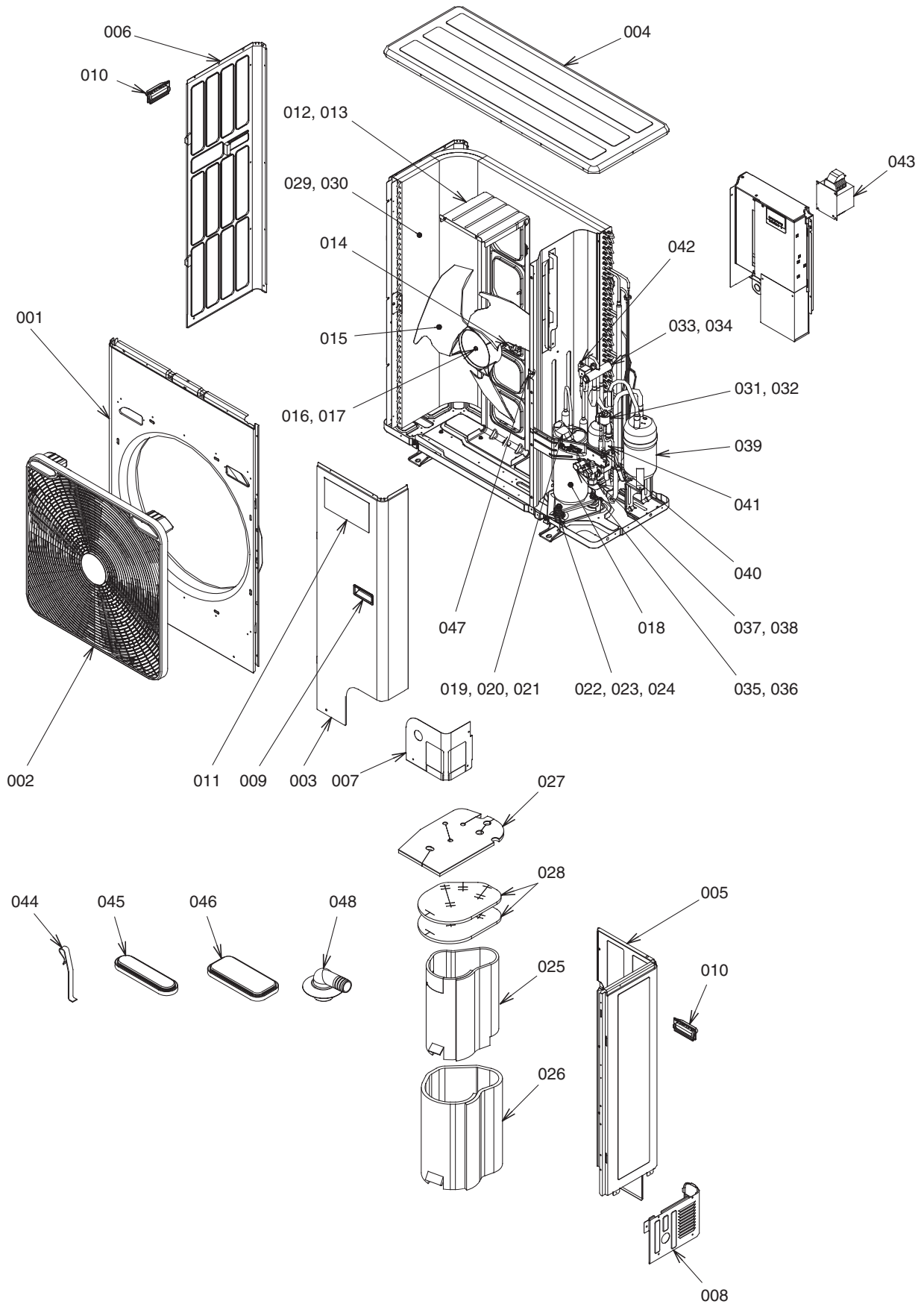

Location No.	Part No.	Description	Q'ty/Set RAV-GP		
			801AT-E	801AT-TR	801ATJ-E
001	4310A122	PANEL, AIR OUTLET	1	1	1
002	43109437	GUARD, FAN	1	1	1
003	4310A123	PANEL, FRONT	1	1	1
004	4310A117	PANEL, ROOF	1	1	1
005	4310A124	PANEL, SIDE	1	1	1
006	4310A165	PANEL, SIDE, LEFT	1	1	1
007	43100437	PANEL, FRONT, PIPING	1	1	1
008	4310A115	PANEL, BACK, PIPING	1	1	1
009	43107276	HANGER	1	1	1
010	43107295	HADLE, HANGER	2	2	2
011	4311M659	MARK, TOSHIBA	1	1	1
012	43122153	SUPPORTER, MOTOR	1	1	
013	43122154	SUPPORTER, MOTOR			1
014	4312C042	MOTOR, FAN, ICF-280-A60-1	1	1	1
015	43120270	FAN, PROPELLER, PS561	1	1	1
016	43F47669	NUT, FLANGE	1	1	
017	43197164	NUT, FLANGE			1
018	43141322	COMPRESSOR, NX220A1F-20N	1	1	1
019	43160654	LEAD ASSY, COMPRESSOR	1	1	1
020	43F50407	THERMOSTAT,BIMETAL	1	1	1
021	43F63317	HOLDER,THERMOSTAT	1	1	1
022	43197183	BOLT, COMPRESSOR	3	3	
023	43197184	BOLT, COMPRESSOR			3
024	43F49625	CUSHION, RUBBER	3	3	3
025	43111366	INSULATOR, SOUND, IN	1	1	1
026	43111367	INSULATOR, SOUND, OUT	1	1	1
027	43111379	INSULATOR, SOUND, UP	1	1	1
028	43111380	INSULATOR, SOUND, UP	2	2	2
029	4314G322	CONDENSER ASSY	1	1	
030	4314G324	CONDENSER ASSY			1
031	4314N111	VALVE, PULSE, MODULATING	1	1	1
032	4314N030	COIL, PMV, UKV-A040	1	1	1
033	43F46500	VALVE, 4WAY, STF-H0218	1	1	1
034	4314N108	COIL, VALVE, 4WAY, STF-H01AZ1724A1	1	1	1
035	4314N092	VALVE, PACKED, 3/8 IN	1	1	1
036	43F47401	BONNET, 3/8 IN	1	1	1
037	4314N107	VALVE, PACKED, 5/8 IN	1	1	1
038	43147194	BONNET, 5/8 IN	1	1	1
039	43148293	ACCUMULATOR	1	1	1
040	4314Q031	STRAINER, 3/8 IN	1	1	1
041	4314Q032	STRAINER	1	1	1
042	43151301	SWITCH, PRESSURE	1	1	1
043	43158243	REACTOR, CH-101	1	1	1
044	43F19904	HOLDER, SENSOR (TS)	1	1	1
045	43F89160	CAP, WATERPROOF	1	1	1
046	43179165	CAP, WATERPROOF	4	4	4
047	43196113	BUSHING	1	1	1
048	43F32441	NIPPLE, DRAIN	1	1	1

**RAV-GP1101AT(J)-E, RAV-GP1401AT(J)-E
RAV-GP1101AT-TR, RAV-GP1401AT-TR**

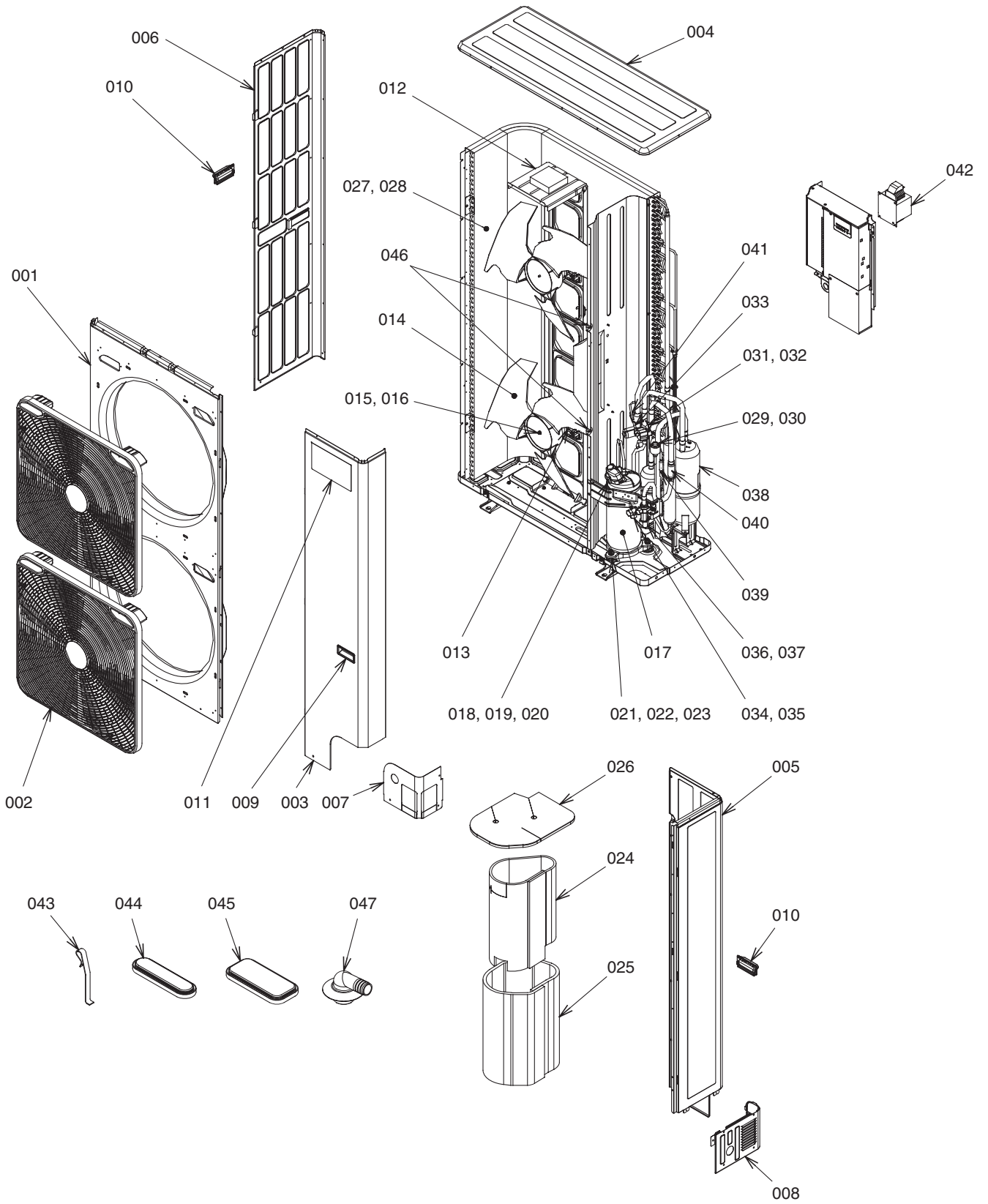

Location No.	Part No.	Description	Q'ty/Set RAV-GP					
			1101 AT-E	1401 AT-E	1101 AT-TR	1401 AT-TR	1101 ATJ-E	1401 ATJ-E
001	4310A114	PANEL, AIR OUTLET	1	1	1	1	1	1
002	43109437	GUARD, FAN	2	2	2	2	2	2
003	4310A116	PANEL, FRONT	1	1	1	1	1	1
004	4310A117	PANEL, ROOF	1	1	1	1	1	1
005	4310A126	PANEL, SIDE	1	1	1	1	1	1
006	4310A127	PANEL, SIDE, LEFT	1	1	1	1	1	1
007	43100437	PANEL, FRONT, PIPING	1	1	1	1	1	1
008	4310A115	PANEL, BACK, PIPING	1	1	1	1	1	1
009	43107276	HANGER	1	1	1	1	1	1
010	43107295	HADLE, HANGER	2	2	2	2	2	2
011	4311M659	MARK, TOSHIBA	1	1	1	1	1	1
012	43122177	SUPPORTER, MOTOR	1	1	1	1	1	1
013	4312C100	MOTOR, FAN, ICF-280-A100-1(A)	2	2	2	2	2	2
014	43120270	FAN, PROPELLER, PS561	2	2	2	2	2	2
015	43F47669	NUT, FLANGE	2	2	2	2		
016	43197164	NUT, FLANGE					2	2
017	43141529	COMPRESSOR, DX380A2T-20M	1	1	1	1	1	1
018	43160654	LEAD ASSY, COMPRESSOR	1	1	1	1	1	1
019	43F50407	THERMOSTAT,BIMETAL	1	1	1	1	1	1
020	43F63317	HOLDER,THERMOSTAT	1	1	1	1	1	1
021	43F97212	NUT	3	3	3	3		
022	43197174	NUT, COMP					3	3
023	43049739	CUSHION, RUBBER	3	3	3	3	3	3
024	43111363	INSULATOR, SOUND, IN	1	1	1	1	1	1
025	43111364	INSULATOR, SOUND, OUT	1	1	1	1	1	1
026	43111365	INSULATOR, SOUND, UP	1	1	1	1	1	1
027	4314G319	CONDENSER ASSY	1	1	1	1		
028	4314G321	CONDENSER ASSY					1	1
029	4314N112	VALVE, PULSE, MODULATING	1	1	1	1	1	1
030	4314N030	COIL, PMV, UKV-A040	1	1	1	1	1	1
031	37546878	VALVE, 4-WAY, STF-H0404	1	1	1	1	1	1
032	4314N108	COIL, VALVE, 4WAY, STF-H01AZ1724A1	1	1	1	1	1	1
033	4314N077	JOINT, CHECK	1	1	1	1	1	1
034	4314N092	VALVE, PACKED, 3/8 IN	1	1	1	1	1	1
035	43F47401	BONNET, 3/8 IN	1	1	1	1	1	1
036	43146724	VALVE, BALL, SBV-JA5GTC-1	1	1	1	1	1	1
037	43147194	BONNET, 5/8 IN	1	1	1	1	1	1
038	43148294	ACCUMULATOR	1	1	1	1	1	1
039	4314Q031	STRAINER, 3/8 IN	1	1	1	1	1	1
040	4314Q032	STRAINER	1	1	1	1	1	1
041	43151301	SWITCH, PRESSURE	1	1	1	1	1	1
042	43158243	REACTOR, CH-101	1	1	1	1	1	1
043	43F19904	HOLDER, SENSOR (TS)	3	3	3	3	3	3
044	43F89160	CAP, WATERPROOF	1	1	1	1	1	1
045	43179165	CAP, WATERPROOF	4	4	4	4	4	4
046	43196113	BUSHING	2	2	2	2	2	2
047	43F32441	NIPPLE, DRAIN	1	1	1	1	1	1

14-2. Inverter Assembly

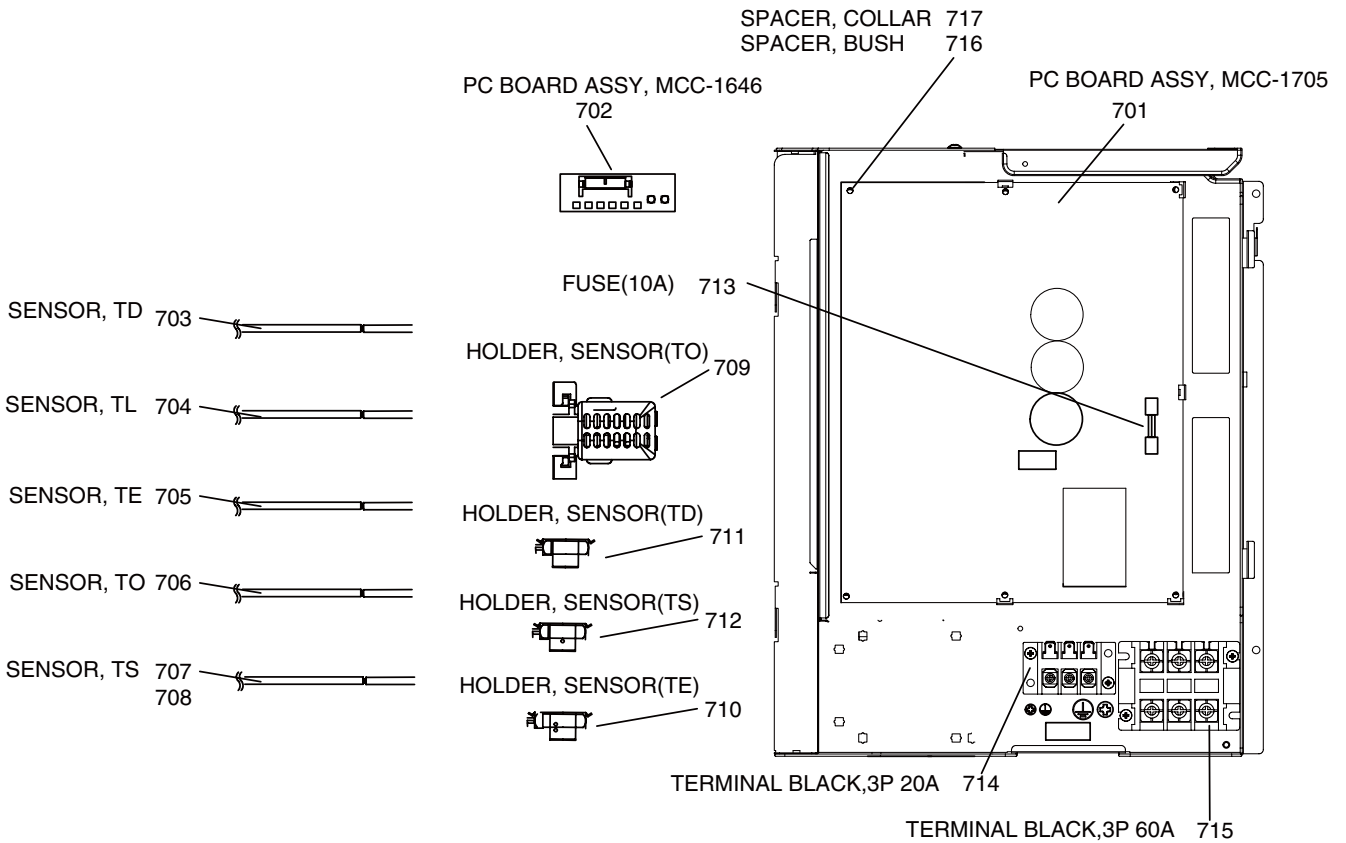

Location No.	Part No.	Description	Q'ty/Set RAV-GP			
			801AT-E 801AT-TR	801ATJ-E	1101AT-E 1401AT-E 1101AT-TR 1401AT-TR	1101ATJ-E 1401ATJ-E
701	4316V659	PC BOARD ASSY, MCC-1705	1	1	1	1
702	4316V550	PC BOARD ASSY, MCC-1646, DS	1	1	1	1
703	43150351	SENSOR, TD	1	1	1	1
704	43150355	SENSOR, TL	1	1	1	1
705	43150359	SENSOR, TE	1	1	1	1
706	43150369	SENSOR, TO	1	1	1	1
707	43150370	SENSOR, TS	1	1		
708	43150353	SENSOR, TS			1	1
709	43163055	HOLDER, SENSOR (TO)	1	1	1	1
710	43F63325	HOLDER, SENSOR (TE)	1	1	1	1
711	43F63321	HOLDER, SENSOR (TD)	1	1		
712	43F63322	HOLDER, SENSOR (TS)	1	1		
713	43160589	FUSE, 10A	1	1	1	1
714	43160607	TERMINAL BLOCK, 3P, 20A	1	1	1	1
715	43160609	TERMINAL BLOCK, 3P, 60A	1	1	1	1
716	43163059	SPACER, BUSH	1	1	1	1
717	43163066	SPACER, COLLAR	1	1	1	1

Toshiba Carrier Corporation

72-34 Horikawa-cho, Saiwai-ku, Kawasaki-shi, Kanagawa 212-8585, JAPAN

Copyright © 2019 TOSHIBA CARRIER CORPORATION, ALL Rights Reserved.

Revision record

First issue	—	—	Feb., 2018
Revision 1	Words were corrected.	All the pages	Sep., 2019