

SERVICE MANUAL

AIR-CONDITIONER (SPLIT TYPE)

INDOOR UNIT

<Floor Standing Type>

RAV-RM561FT-EN/ES

RAV-RM801FT-EN/ES

RAV-RM1101FT-EN/ES

RAV-RM1401FT-EN/ES

RAV-RM1601FT-EN/ES

RAV-RM561FT-TR

RAV-RM801FT-TR

RAV-RM1101FT-TR

RAV-RM1401FT-TR

RAV-RM1601FT-TR



CONTENTS

PRECAUTION FOR SAFETY	6
ABOUT REFRIGERANT R32	16
ABOUT REFRIGERANT R410A	19
1. CONSTRUCTION VIEWS (EXTERNAL VIEWS)	21
1-1. RAV-RM561FT*	21
1-2. RAV-RM801FT*	22
1-3. RAV-RM1101FT*, RM1401FT*, RM1601FT*	23
2. WIRING DIAGRAMS	24
3. PARTS RATING	25
4. SYSTEMATIC REFRIGERATING CYCLE DIAGRAM	26
4-1. Indoor Unit	26
5. INDOOR CONTROL CIRCUIT	29
5-1. Indoor Controller Block Diagram	29
5-1-1. Connection of Wired Remote Controller	29
5-1-2. Connection of Wireless Remote Controller Kit	30
5-1-3. Connection of Both Wired Remote Controller and Wireless Remote Controller Kit	31
5-2. Control Specifications	32
5-3. Indoor Print Circuit Board	43
5-4. Optional connector specifications of indoor P.C. board	44
6. TROUBLESHOOTING	45
6-1. Summary of Troubleshooting	45
6-2. Troubleshooting	47
6-2-1. Outline of judgment	47
6-2-2. Others (Other than Check Code)	49
6-2-3. Check Code List (Indoor)	51
6-2-4. Diagnostic Procedure for Each Check Code (Indoor Unit)	54
7. REPLACEMENT OF SERVICE P.C. BOARD	67
7-1. Indoor Unit	67
8. SETUP AT LOCAL SITE AND OTHERS	73
8-1. Indoor Unit	73
8-1-1. Test Run Setup on Remote Controller	73
8-1-2. Forced Defrost Setup of Remote Controller (For wired remote controller only)	76
8-1-3. LED Display on P.C. Board	76
8-1-4. Function Selection Setup	77
8-1-5. Wiring and Setting of Remote Controller Control	79
8-1-6. Monitor Function of Remote Controller Switch	82
8-2. Setup at Local Site / Others	85
8-2-1. 1:1 Model Connection Interface (TCC-LINK adapter)	85
9. ADDRESS SETUP	88
9-1. Address Setup	88
9-2. Address Setup & Group Control	89
9-2-1. System configuration	89
9-2-2. Automatic Address Example from Unset Address (No miswiring)	91
9-3. Address Setup (Manual Setting from Remote Controller)	92
9-4. Confirmation of Indoor Unit No. Position	93
10. MAINTENANCE/CHECK LIST	94
11. DETACHMENTS	95
12. EXPLODED VIEWS AND PARTS LIST	104

Original instruction

Please read carefully through these instructions including important information which complies with the “Machinery Directive” (Directive 2006/42/EC), and ensure that you understand them.

Generic Denomination: Air Conditioner

Definition of Qualified Installer or Qualified Service Person

The air conditioner must be installed, maintained, repaired and removed by a qualified installer or qualified service person. When any of these jobs is to be done, ask a qualified installer or qualified service person to do them.

A qualified installer or qualified service person is an agent who has the qualifications and knowledge described in the table below.

Agent	Qualifications and knowledge which the agent must have
Qualified installer	<ul style="list-style-type: none"> • The qualified installer is a person who installs, maintains, relocates and removes the air conditioners made by Toshiba Carrier Corporation. He or she has been trained to install, maintain, relocate and remove the air conditioners made by Toshiba Carrier Corporation or, alternatively, he or she has been instructed in such operations by an individual or individuals who have been trained and is thus thoroughly acquainted with the knowledge related to these operations. • The qualified installer who is allowed to do the electrical work involved in installation, relocation and removal has the qualifications pertaining to this electrical work as stipulated by the local laws and regulations, and he or she is a person who has been trained in matters relating to electrical work on the air conditioners made by Toshiba Carrier Corporation or, alternatively, he or she has been instructed in such matters by an individual or individuals who have been trained and is thus thoroughly acquainted with the knowledge related to this work. • The qualified installer who is allowed to do the refrigerant handling and piping work involved in installation, relocation and removal has the qualifications pertaining to this refrigerant handling and piping work as stipulated by the local laws and regulations, and he or she is a person who has been trained in matters relating to refrigerant handling and piping work on the air conditioners made by Toshiba Carrier Corporation or, alternatively, he or she has been instructed in such matters by an individual or individuals who have been trained and is thus thoroughly acquainted with the knowledge related to this work. • The qualified installer that is allowed to work at heights has been trained in matters relating to working at heights with the air conditioners made by Toshiba Carrier Corporation or, alternatively, he or she has been instructed in such matters by an individual or individuals who have been trained and is thus thoroughly acquainted with the knowledge related to this work.
Qualified service person	<ul style="list-style-type: none"> • The qualified service person is a person who installs, repairs, maintains, relocates and removes the air conditioners made by Toshiba Carrier Corporation. He or she has been trained to install, repair, maintain, relocate and remove the air conditioners made by Toshiba Carrier Corporation or, alternatively, he or she has been instructed in such operations by an individual or individuals who have been trained and is thus thoroughly acquainted with the knowledge related to these operations. • The qualified service person who is allowed to do the electrical work involved in installation, repair, relocation and removal has the qualifications pertaining to this electrical work as stipulated by the local laws and regulations, and he or she is a person who has been trained in matters relating to electrical work on the air conditioners made by Toshiba Carrier Corporation or, alternatively, he or she has been instructed in such matters by an individual or individuals who have been trained and is thus thoroughly acquainted with the knowledge related to this work. • The qualified service person who is allowed to do the refrigerant handling and piping work involved in installation, repair, relocation and removal has the qualifications pertaining to this refrigerant handling and piping work as stipulated by the local laws and regulations, and he or she is a person who has been trained in matters relating to refrigerant handling and piping work on the air conditioners made by Toshiba Carrier Corporation or, alternatively, he or she has been instructed in such matters by an individual or individuals who have been trained and is thus thoroughly acquainted with the knowledge related to this work. • The qualified service person who is allowed to work at heights has been trained in matters relating to working at heights with the air conditioners made by Toshiba Carrier Corporation or, alternatively, he or she has been instructed in such matters by an individual or individuals who have been trained and is thus thoroughly acquainted with the knowledge related to this work.

Definition of Protective Gear

When the air conditioner is to be transported, installed, maintained, repaired or removed, wear protective gloves and 'safety' work clothing.

In addition to such normal protective gear, wear the protective gear described below when undertaking the special work detailed in the table below.



Failure to wear the proper protective gear is dangerous because you will be more susceptible to injury, burns, electric shocks and other injuries.

Work undertaken	Protective gear worn
All types of work	Protective gloves 'Safety' working clothing
Electrical-related work	Gloves to provide protection for electricians Insulating shoes Clothing to provide protection from electric shock
Work done at heights (50 cm or more)	Helmets for use in industry
Transportation of heavy objects	Shoes with additional protective toecap
Repair of outdoor unit	Gloves to provide protection for electricians

The important contents concerned to the safety are described on the product itself and on this Service Manual.



Please read this Service Manual after understanding the described items thoroughly in the following contents (Indications / Illustrated marks), and keep them.

[Explanation of indications]

Indication	Explanation
 DANGER	Indicates contents assumed that an imminent danger causing a death or serious injury of the repair engineers and the third parties when an incorrect work has been executed.
 WARNING	Indicates possibilities assumed that a danger causing a death or serious injury of the repair engineers, the third parties, and the users due to troubles of the product after work when an incorrect work has been executed.
 CAUTION	Indicates contents assumed that an injury or property damage (*) may be caused on the repair engineers, the third parties, and the users due to troubles of the product after work when an incorrect work has been executed.

* Property damage: Enlarged damage concerned to property, furniture, and domestic animal / pet

[Explanation of illustrated marks]





Indication	Explanation
	Indicates prohibited items (Forbidden items to do) The sentences near an illustrated mark describe the concrete prohibited contents.
	Indicates mandatory items (Compulsory items to do) The sentences near an illustrated mark describe the concrete mandatory contents.
	Indicates cautions (Including danger / warning) The sentences or illustration near or in an illustrated mark describe the concrete cautious contents.

Warning Indications on the Air Conditioner Unit

[Confirmation of warning label on the main unit]

Confirm that labels are indicated on the specified positions.



If removing the label during parts replace, stick it as the original.

Warning indication	Description		
 <table border="1" data-bbox="311 421 662 645"> <tr> <td data-bbox="311 421 662 504">WARNING</td> </tr> <tr> <td data-bbox="311 504 662 645"> ELECTRICAL SHOCK HAZARD Disconnect all remote electric power supplies before servicing. </td> </tr> </table>	WARNING	ELECTRICAL SHOCK HAZARD Disconnect all remote electric power supplies before servicing.	<p>WARNING</p> <p>ELECTRICAL SHOCK HAZARD Disconnect all remote electric power supplies before servicing.</p>
WARNING			
ELECTRICAL SHOCK HAZARD Disconnect all remote electric power supplies before servicing.			
 <table border="1" data-bbox="311 701 662 925"> <tr> <td data-bbox="311 701 662 784">WARNING</td> </tr> <tr> <td data-bbox="311 784 662 925"> Moving parts. Do not operate unit with grille removed. Stop the unit before the servicing. </td> </tr> </table>	WARNING	Moving parts. Do not operate unit with grille removed. Stop the unit before the servicing.	<p>WARNING</p> <p>Moving parts. Do not operate unit with grille removed. Stop the unit before the servicing.</p>
WARNING			
Moving parts. Do not operate unit with grille removed. Stop the unit before the servicing.			
 <table border="1" data-bbox="311 981 662 1205"> <tr> <td data-bbox="311 981 662 1064">CAUTION</td> </tr> <tr> <td data-bbox="311 1064 662 1205"> High temperature parts. You might get burned when removing this panel. </td> </tr> </table>	CAUTION	High temperature parts. You might get burned when removing this panel.	<p>CAUTION</p> <p>High temperature parts. You might get burned when removing this panel.</p>
CAUTION			
High temperature parts. You might get burned when removing this panel.			
 <table border="1" data-bbox="311 1261 662 1485"> <tr> <td data-bbox="311 1261 662 1344">CAUTION</td> </tr> <tr> <td data-bbox="311 1344 662 1485"> Do not touch the aluminum fins of the unit. Doing so may result in injury. </td> </tr> </table>	CAUTION	Do not touch the aluminum fins of the unit. Doing so may result in injury.	<p>CAUTION</p> <p>Do not touch the aluminium fins of the unit. Doing so may result in injury.</p>
CAUTION			
Do not touch the aluminum fins of the unit. Doing so may result in injury.			
 <table border="1" data-bbox="311 1541 662 1765"> <tr> <td data-bbox="311 1541 662 1624">CAUTION</td> </tr> <tr> <td data-bbox="311 1624 662 1765"> BURST HAZARD Open the service valves before the operation, otherwise there might be the burst. </td> </tr> </table>	CAUTION	BURST HAZARD Open the service valves before the operation, otherwise there might be the burst.	<p>CAUTION</p> <p>BURST HAZARD Open the service valves before the operation, otherwise there might be the burst.</p>
CAUTION			
BURST HAZARD Open the service valves before the operation, otherwise there might be the burst.			

Precaution for Safety



The appliance shall be installed in accordance with national wiring regulations. Capacity shortages of the power circuit or an incomplete installation may cause an electric shock or fire.

DANGER









 Check earth wires.	<p>Before carrying out the installation, maintenance, repair or removal work, be sure to set the circuit breaker to the OFF position. Otherwise, electric shocks may result.</p>
	<p>Before opening the intake grille of the indoor unit or service panel of the outdoor unit, set the circuit breaker to the OFF position. Failure to set the circuit breaker to the OFF position may result in electric shocks through contact with the interior parts. Only a qualified installer (*1) or qualified service person (*1) is allowed to remove the intake grille of the indoor unit or service panel of the outdoor unit and do the work required.</p>
	<p>Before opening the electric cover set the circuit breaker to the OFF position. Failure to set the circuit breaker to the OFF position may result in injury through contact with the rotation parts.</p>
	<p>When cleaning the filter or other parts of the indoor unit, set the circuit breaker to OFF without fail, and place a "Work in progress" sign near the circuit breaker before proceeding with the work.</p>
	<p>When you have noticed that some kind of trouble (such as when a check code display has appeared, there is a smell of burning, abnormal sounds are heard, the air conditioner fails to cool or heat or water is leaking) has occurred in the air conditioner, do not touch the air conditioner yourself but set the circuit breaker to the OFF position, and contact a qualified service person. Take steps to ensure that the power will not be turned on (by marking "out of service" near the circuit breaker, for instance) until qualified service person arrives. Continuing to use the air conditioner in the trouble status may cause mechanical problems to escalate or result in electric shocks or other failure.</p>
 Electric shock hazard.	<p>When checking the electric parts, removing the cover of the electric parts box of Indoor Unit and/or service panel of Outdoor Unit inevitably to determine the failure, use gloves to provide protection for electricians, insulating shoes, clothing to provide protection from electric shock and insulating tools. Be careful not to touch the live part. Electric shock may result. Only "Qualified service person" is allowed to do this work.</p>
 Prohibition	<p>Do not turn ON the circuit breaker under the condition of removing a cabinet, a panel, etc. Otherwise, it leads to an electric shock with a high voltage, resulting in loss of life.</p>

(*1) Refer to the "Definition of Qualified Installer or Qualified Service Person."

 **WARNING**

 General	<p>Before starting to repair the air conditioner, read carefully through the Service Manual, and repair the air conditioner by following its instructions.</p>
	<p>Only qualified service person (*1) is allowed to repair the air conditioner. Repair of the air conditioner by unqualified person may give rise to a fire, electric shocks, injury, water leaks and/or other problems.</p>
	<p>Only a qualified installer (*1) or qualified service person (*1) is allowed to carry out the electrical work of the air conditioner. Under no circumstances must this work be done by an unqualified individual since failure to carry out the work properly may result in electric shocks and/or electrical leaks.</p>
	<p>Wear protective gloves and safety work clothing during installation, servicing and removal.</p>
	<p>Do not use any refrigerant different from the one specified for complement or replacement. Otherwise, abnormally high pressure may be generated in the refrigeration cycle, which may result in a failure or explosion of the product or an injury to your body.</p>
	<p>When connecting the electrical wires, repairing the electrical parts or undertaking other electrical jobs, wear gloves to provide protection for electricians, insulating shoes and clothing to provide protection from electric shocks. Failure to wear this protective gear may result in electric shocks.</p>
	<p>When the air conditioner is to be transported, installed, maintained, repaired or removed, wear protective gloves and safety work clothing.</p>
	<p>To connect the electrical wires, repair the electrical parts or undertake other electrical jobs, wear gloves to provide protection for electricians, insulating shoes and clothing to provide protection from electric shocks. Failure to wear this protective gear may result in electric shocks.</p>
	<p>Electrical wiring work shall be conducted according to law and regulation in the community and installation manual. Failure to do so may result in electrocution or short circuit.</p>
	<p>Use wiring that meets the specifications in the Installation Manual and the stipulations in the local regulations and laws. Use of wiring which does not meet the specifications may give rise to electric shocks, electrical leakage, smoking and/or a fire.</p>
	<p>Only a qualified installer (*1) or qualified service person (*1) is allowed to undertake work at heights using a stand of 50 cm or more.</p>
	<p>When working at heights, use a ladder which complies with the ISO 14122 standard, and follow the procedure in the ladder's instructions. Also wear a helmet for use in industry as protective gear to undertake the work.</p>
	<p>When executing address setting, test run, or troubleshooting through the checking window on the electric parts box, put on insulated gloves to provide protection from electric shock. Otherwise you may receive an electric shock.</p>
	<p>Do not touch the aluminum fin of the outdoor unit. You may injure yourself if you do so. If the fin must be touched for some reason, first put on protective gloves and safety work clothing, and then proceed.</p>
	<p>Do not climb onto or place objects on top of the outdoor unit. You may fall or the objects may fall off the outdoor unit and result in injury.</p>
<p>When transporting the air conditioner, wear shoes with additional protective toecaps.</p>	
<p>When transporting the air conditioner, do not hold of the bands around the packing carton. You may injure yourself if the bands should break.</p>	
<p>Be sure that a heavy unit (10 kg or heavier) such as a compressor is carried by four persons.</p>	
<p>This air conditioner has passed the pressure test as specified in IEC 60335-2-40 Annex EE.</p>	
 Electric shock hazard	<p>When you access inside of the electric cover to repair electric parts, wait for about five minutes after turning off the breaker. Do not start repairing immediately. Otherwise you may get electric shock by touching terminals of high-voltage capacitors. Natural discharge of the capacitor takes about five minutes.</p>
 Prohibition	<p>Place a "Work in progress" sign near the circuit breaker while the installation, maintenance, repair, or removal work is being carried out. There is a danger of electric shocks if the circuit breaker is set to ON by mistake.</p> <p>When checking the electric parts, removing the cover of the electric parts box of Indoor Unit and/ or front panel of Outdoor Unit inevitably to determine the failure, put a sign "Do not enter" around the site before the work. Failure to do this may result in third person getting electric shock.</p> <p>Before operating the air conditioner after having completed the work, check that the electrical parts box cover of the indoor unit and service panel of the outdoor unit are closed, and set the circuit breaker to the ON position. You may receive an electric shock if the power is turned on without first conducting these checks.</p>

(*1) Refer to the "Definition of Qualified Installer or Qualified Service Person."

 Stay on protection	If, in the course of carrying out repairs, it becomes absolutely necessary to check out the electrical parts with the electrical parts box cover of one or more of the indoor units and the service panel of the outdoor unit removed in order to find out exactly where the trouble lies, wear insulated heat-resistant gloves, insulated boots and insulated work overalls, and take care to avoid touching any live parts. You may receive an electric shock if you fail to heed this warning. Only qualified service person (*1) is allowed to do this kind of work.
 Check earth wires.	Before troubleshooting or repair work, check the earth wire is connected to the earth terminals of the main unit, otherwise an electric shock is caused when a leak occurs. If the earth wire is not correctly connected, contact an electric engineer for rework. After completing the repair or relocation work, check that the earth wires are connected properly. Be sure to connect earth wire. (Grounding work) Incomplete earth causes an electric shock. Do not connect earth wires to gas pipes, water pipes, and lightning rods or earth wires for telephone wires.
 Prohibition of modification.	Do not modify the products. Do not also disassemble or modify the parts. It may cause a fire, electric shock or injury.
 Use specified parts.	When any of the electrical parts are to be replaced, ensure that the replacement parts satisfy the specifications given in the Service Manual (or use the parts contained on the parts list in the Service Manual). Use of any parts that do not satisfy the required specifications may give rise to electric shocks, smoking and/or a fire. Replace components only with parts specified by the manufacturer. Other parts may result in the ignition of refrigerant in the atmosphere due to the refrigerant leak.
 Do not bring a child close to the equipment.	If, in the course of carrying out repairs, it becomes absolutely necessary to check out the electrical parts with the electrical parts box cover of one or more of the indoor units and the service panel of the outdoor unit removed in order to find out exactly place where the trouble lies, put "Keep out" signs around the work site before proceeding. Third-party individuals may enter the work site and receive electric shocks if this warning is not heeded.
 Insulating measures	Connect the cut-off lead wires with crimp contact, etc., put the closed end side upward and then apply a water-cut method, otherwise a leak or production of fire is caused at the users' side. Under no circumstances, the power supply wire or the indoor and outdoor connecting wire must not be connected in the middle (Connection using a solder less terminal etc.) Connection trouble in the places where the wire is connected in the middle may give rise to smoking and/or a fire.
 No fire	When performing repairs using a gas burner, replace the refrigerant with nitrogen gas because the oil that coats the pipes may otherwise burn. When repairing the refrigerating cycle, take the following measures. 1) Be attentive to fire around the cycle. When using a gas stove, etc., be sure to put out fire before work; otherwise the oil mixed with refrigerant gas may catch fire. 2) Do not use a brazing in the closed room. When using it without ventilation, carbon monoxide poisoning may be caused. 3) Do not bring inflammable material around to the refrigerant cycle; otherwise fire of the brazing may catch the inflammable material.
 Prohibition	This unit is equipped with a R32 refrigerant leak detection sensor for safety, to be effective, the unit must be electrically powered at all times after installation, other than when servicing. Turning off the circuit breaker cause refrigerant leak detection sensor not to operate and not to enable to detect refrigerant leaks, causing a fire.







(*1) Refer to the "Definition of Qualified Installer or Qualified Service Person."







Refrigerant

<p>This Air Conditioner has adopted a refrigerant HFC R32 or R410A. Be sure to check the refrigerant type for outdoor unit to be combined. In case that refrigerant type is R32, this unit uses a mildly flammable refrigerant. If refrigerant leaks and comes in contact with fire or heating part, it will create harmful gas and there is risk of fire.</p>	
<p>Check the used refrigerant name and use tools and materials of the parts, which match with used refrigerant. For the products, which use R32 refrigerant, the refrigerant name is indicated at a position on the outdoor unit where is easy to see. To prevent miss charging, the route of the service port is changed from one of the former R22. Be careful for miss charging since a charging port of R32 is the same diameter as that of R410A.</p>	
<p>Do not use any refrigerant different from the one specified for complement or replacement. Otherwise, abnormally high pressure may be generated in the refrigeration cycle, which may result in a failure or explosion of the product or an injury to your body.</p>	
<p>Be sure to use the refrigerant (R32 or R410A) specified on the combined outdoor unit. If different types of refrigerant are mixed, abnormal high pressure generates in the refrigerating cycle and an injury due to breakage may be caused. If the different type of refrigerants are mixed in, be sure to recharge the refrigerant</p>	
<p>When the air conditioner has been installed or relocated, follow the instructions in the Installation Manual and purge the air completely so that no gases other than the refrigerant will be mixed in the refrigerating cycle. Failure to purge the air completely may cause the air conditioner to malfunction.</p>	
<p>Do not charge refrigerant additionally. If charging refrigerant additionally when refrigerant gas leaks, the refrigerant composition in the refrigerating cycle changes resulted in change of air conditioner characteristics or refrigerant over the specified standard amount is charged and an abnormal high pressure is applied to the inside of the refrigerating cycle resulted in cause of breakage or injury. Therefore if the refrigerant gas leaks, recover the refrigerant in the air conditioner, execute vacuuming, and then newly recharge the specified amount of liquid refrigerant. In this time, never charge the refrigerant over the specified amount.</p>	
<p>When recharging the refrigerant in the refrigerating cycle, do not mix the other refrigerant into the specified refrigerant. If air or others is mixed with the refrigerant, abnormal high pressure occurs in the refrigerating cycle resulted in cause of injury due to breakage.</p>	
<p>After the installation work, confirm that refrigerant gas does not leak. If refrigerant gas leaks into the room and flows near a fire source, such as a cooking range, noxious gas may be generated.</p>	
<p>Never recover the refrigerant into the outdoor unit. When the equipment is moved or repaired, be sure to recover the refrigerant with recovering device. The refrigerant cannot be recovered in the outdoor unit; otherwise a serious accident such as breakage or injury is caused.</p>	
<p>When the air conditioner has been installed or relocated, follow the instructions in the Installation Manual and purge the air completely so that no gases other than the refrigerant will be mixed in the refrigerating cycle. Failure to purge the air completely may cause the air conditioner to malfunction.</p>	
<p>The appliance shall be stored in a room without continuously operating ignition sources (for example: open flames, an operating gas appliance or an operating electric heater).</p>	
<p>Do not pierce or burn refrigerant cycle parts.</p>	
<p>Do not use means to accelerate the defrosting process or to clean, other than those recommended by the manufacturer.</p>	
<p>Be aware that refrigerants may not contain an odor.</p>	
<p>Pipe-work shall be protected from physical damage.</p>	
<p>Compliance with national gas regulations shall be observed.</p>	
<p>If refrigerant leak detection sensor detects R32 refrigerant leak, a fan on indoor unit automatically operates to stir an air in the room. Stirring air flow volume of each model is as shown below.</p>	
Model name	Stirring air flow (m ³ /h)
RAV-RM561FT*	820
RAV-RM801FT*	930
RAV-RM1101FT*	1,660
RAV-RM1401FT*	1,760
RAV-RM1601FT*	1,760
<p>The installation of pipe work shall be kept to a minimum piping length.</p>	
<p>When an outdoor unit using R32 refrigerant is combined with indoor unit, be attention to the floor area in the room to be installed. The unit cannot be installed in the room with floor area less than minimum floor area described in Appendix of this Manual. For refrigerant charge amount, refer to the Installation Manual attached to the outdoor unit or Fluorinated Greenhouse Gases label.</p>	
<p>A brazed or mechanical connection shall be made before opening the valves to permit refrigerant to flow between the refrigerating system parts.</p>	
<p>Refrigerant tubing shall be protected or enclosed to avoid damage.</p>	

(*1) Refer to the "Definition of Qualified Installer or Qualified Service Person."



 Assembly/ Wiring	<p>After repair work, surely assemble the disassembled parts, and connect and lead the removed wires as before. Perform the work so that the cabinet or panel does not catch the inner wires. If incorrect assembly or incorrect wire connection was done, a disaster such as a leak or fire is caused at user's side.</p> <p>Check that wiring will not be subject to wear, corrosion, excessive pressure, vibration, sharp edges or any other adverse environmental effects. The check shall also take into account the effects of aging or continual vibration from sources such as compressors or fans.</p>
 Insulator check	<p>After the work has finished, be sure to use an insulation tester set (500VΩ) to check the resistance is 1MΩ or more between the charge section and the non-charge metal section (Earth position). If the resistance value is low, a disaster such as a leak or electric shock is caused at user's side.</p>
 Ventilation	<p>When the refrigerant gas leaks during work, execute ventilation. If the refrigerant gas comes in contact with a fire, it may generate noxious gases, causing a fire. A closed room filled with leaked refrigerant gas is dangerous due to a shortage of oxygen. Be sure to execute ventilation.</p> <p>If refrigerant gas has leaked during the installation work, ventilate the room immediately. If the leaked refrigerant gas comes in contact with fire, it may generate noxious gases, causing a fire.</p>
 Compulsion	<p>When the refrigerant gas leaks, find out the leaked position and repair it surely. If the leaked position cannot be found out and the repair work is interrupted, pump-down and tighten the service valve, otherwise the refrigerant gas may leak into the room. When gas touches to fire such as fan heater, stove or cooking stove, it may generate noxious gases, causing a fire though the refrigerant gas itself is innocuous. When installing equipment, which includes a large amount of charged refrigerant in a sub-room, it is necessary that the concentration does not the limit even if the refrigerant leaks. If the refrigerant leaks and exceeds the limit concentration, an accident of shortage of oxygen is caused.</p> <p>Tighten the flare nut with a torque wrench in the specified manner. Excessive tighten of the flare nut may cause a crack in the flare nut after a long period, which may result in refrigerant leakage.</p> <p>Nitrogen gas must be used for the airtight test.</p> <p>The charge hose must be connected in such a way that it is not slack.</p> <p>For the installation/moving/reinstallation work, follow to the Installation Manual. If an incorrect installation is done, a trouble of the refrigerating cycle, water leak, electric shock or fire is caused.</p> <p>Install the outdoor unit properly in a location that is durable enough to support the weight of the outdoor unit. Insufficient durability may cause the outdoor unit to fall, which may result in injury.</p>
 Check after repair	<p>Once the repair work has been completed, check for refrigerant leaks, and check the insulation resistance and water drainage. Then perform a trial run to check that the air conditioner is running properly.</p> <p>After repair work has finished, check there is no trouble. If check is not executed, a fire, electric shock or injury may be caused. For a check, turn off the power breaker.</p> <p>After repair work (installation of front panel and cabinet) has finished, execute a test run to check there is no generation of smoke or abnormal sound. If check is not executed, a fire or an electric shock is caused. Before test run, install the front panel and cabinet.</p> <p>Be sure to fix the screws back which have been removed for installation or other purposes.</p>
 Do not operate the unit with the valve closed.	<p>Check the following matters before a test run after repairing piping.</p> <ul style="list-style-type: none"> • Connect the pipes surely and there is no leak of refrigerant. • The valve is opened. <p>Running the compressor under condition that the valve closes causes an abnormal high pressure resulted in damage of the parts of the compressor and etc. and moreover if there is leak of refrigerant at connecting section of pipes, the air is suctioned and causes further abnormal high pressure resulted in burst or injury.</p>
 Check after reinstallation	<p>Only a qualified installer (*1) or qualified service person (*1) is allowed to relocate the air conditioner. It is dangerous for the air conditioner to be relocated by an unqualified individual since a fire, electric shocks, injury, water leakage, noise and/or vibration may result.</p> <p>Check the following items after reinstallation.</p> <ol style="list-style-type: none"> 1) The earth wire is correctly connected. 2) The power cord is not caught in the product. 3) There is no inclination or unsteadiness and the installation is stable. <p>If check is not executed, a fire, an electric shock or an injury is caused.</p>

(*1) Refer to the "Definition of Qualified Installer or Qualified Service Person."

 Cooling check	When the service panel of the outdoor unit is to be opened in order for the compressor or the area around this part to be repaired immediately after the air conditioner has been shut down, set the circuit breaker to the OFF position, and then wait at least 10 minutes before opening the service panel. If you fail to heed this warning, you will run the risk of burning yourself because the compressor pipes and other parts will be very hot to the touch. In addition, before proceeding with the repair work, wear the kind of insulated heat-resistant gloves designed to protect electricians.
 Cooling	When the service panel of the outdoor unit is to be opened in order for the fan motor, reactor, inverter or the areas around these parts to be repaired immediately after the air conditioner has been shut down, set the circuit breaker to the OFF position, and then wait at least 10 minutes before opening the service panel. If you fail to heed this warning, you will run the risk of burning yourself because the fan motor, reactor, inverter heat sink and other parts will be very hot to the touch. In addition, before proceeding with the repair work, wear the kind of insulated heat-resistant gloves designed to protect electricians.
 Installation	<p>Only a qualified installer (*1) or qualified service person (*1) is allowed to install the air conditioner. If the air conditioner is installed by an unqualified individual, a fire, electric shocks, injury, water leakage, noise and/or vibration may result.</p> <p>Before starting to install the air conditioner, read carefully through the Installation Manual, and follow its instructions to install the air conditioner.</p> <p>Be sure to use the company-specified products for the separately purchased parts. Use of no specified products may result in fire, electric shock, water leakage or other failure. Have the installation performed by a qualified installer.</p> <p>Do not supply power from the power terminal block equipped on the outdoor unit to another outdoor unit. Capacity overflow may occur on the terminal block and may result in fire.</p> <p>Do not install the air conditioner in a location that may be subject to a risk of exposing to a combustible gas. If a combustible gas leaks and becomes concentrated around the unit, a fire may occur.</p> <p>Install a circuit breaker that meets the specifications in the Installation Manual and the stipulations in the local regulations and laws.</p> <p>When transporting the air conditioner, use a forklift truck and when moving the air conditioner by hand, move the unit with 4 people.</p> <p>Install a circuit breaker that meets the specifications in the Installation Manual and the stipulations in the local regulations and laws.</p> <p>Install the circuit breaker where it can be easily accessed by the agent.</p> <p>If you install the unit in a small room, take appropriate measures to prevent the refrigerant from exceeding the limit concentration even if it leaks. Consult the dealer from whom you purchased the air conditioner when you implement the measures. Accumulation of highly concentrated refrigerant may cause an oxygen deficiency accident.</p> <p>Do not place any combustion appliance in a place where it is directly exposed to the wind of air conditioner, otherwise it may cause imperfect combustion.</p>
 Compulsion	<p>When carrying out the pump-down work shut down the compressor before disconnecting the refrigerant pipe. Disconnecting the refrigerant pipe with the service valve left open and the compressor still operating will cause air, etc. to be sucked in, raising the pressure inside the refrigeration cycle to an abnormally high level, and possibly resulting in rupture, injury, etc.</p> <p>When removing the brazing parts of suction and discharge pipe for the compressor, remove them at the place ventilated well after recovering the refrigerant. Improper recovering may cause the spurt of the refrigerant and the refrigeration oil, causing an injury.</p>
 Prohibition	<p>Do not vent gases to the atmosphere. Venting gases to the atmosphere is prohibited by the law.</p>

(*1) Refer to the “Definition of Qualified Installer or Qualified Service Person.”

CAUTION

 Wearing of gloves	Ensure wearing of gloves when performing any work in order to avoid injury from parts, etc. Failure to wear the proper protective gloves cause an injury due to the parts, etc.
 Confirm	When performing the brazing work, check whether refrigerant leaks or remains. If the leakage refrigerant gas touches a fire source, it may generate noxious gases, causing a fire. Be careful of fan operation when the circuit breaker is turned on. If the refrigerant leak detection sensor detects the refrigerant leak, a fan automatically rotates even while an air conditioner is stopped. Be careful not to be injured by the fan. When an outdoor unit using R32 refrigerant is combined with indoor unit, pay attention to the floor area in the room to be installed. The unit cannot be installed in the room with floor area smaller than minimum floor area described in Appendix of this Installation Manual.
 Prohibition	Do not install the air conditioner in place where steam is generated, or in place near the humidifier etc. Dew may form in the parts built in the unit, causing trouble of the unit.

Explanations given to user

If you have discovered that the fan grille is damaged, do not approach the outdoor unit but set the circuit breaker to the OFF position, and contact a qualified service person to have the repairs done.
Do not set the circuit breaker to the ON position until the repairs are completed.

Relocation

- Only a qualified installer (*1) or qualified service person (*1) is allowed to relocate the air conditioner. It is dangerous for the air conditioner to be relocated by an unqualified individual since a fire, electric shocks, injury, water leakage, noise and / or vibration may result.
- When carrying out the pump-down work shut down the compressor before disconnecting the refrigerant pipe. Disconnecting the refrigerant pipe with the service valve left open and the compressor still operating will cause air, etc. to be sucked in, raising the pressure inside the refrigeration cycle to an abnormally high level, and possibly resulting in rupture, injury, etc.

(*1) Refer to the "Definition of Qualified Installer or Qualified Service Person"

APPENDIX

■ Minimum floor area: Amin (m²)

When an outdoor unit using R32 refrigerant is combined with this indoor unit, do not install the indoor unit in a poorly ventilated space that is smaller than the minimum floor area (**Amin**).

For refrigerant quantity, refer to Fluorinated Greenhouse Gases label on the outdoor unit.
For the minimum floor area (**Amin**) of this indoor unit, refer to table below.

Total refrigerant quantity M (kg)	Floor standing unit Amin (m²)	Total refrigerant quantity M (kg)	Floor standing unit Amin (m²)
0.90	No requirements	5.10	12.85
1.00		5.20	13.10
1.10		5.30	13.35
1.20		5.40	13.60
1.30		5.50	13.85
1.40		5.60	14.10
1.50		5.70	14.36
1.60		5.80	14.61
1.70		5.90	14.86
1.80		6.00	15.11
1.84	4.64	6.10	15.36
1.90	4.79	6.20	15.62
2.00	5.04	6.30	15.87
2.10	5.29	6.40	16.12
2.20	5.54	6.50	16.37
2.30	5.80	6.60	16.62
2.40	6.05	6.70	16.87
2.50	6.30	6.80	17.13
2.60	6.55	6.90	17.38
2.70	6.80	7.00	17.63
2.80	7.05	7.10	17.88
2.90	7.31	7.20	18.13
3.00	7.56	7.30	18.38
3.10	7.81	7.40	18.64
3.20	8.06	7.50	18.89
3.30	8.31	7.60	19.14
3.40	8.57	7.70	19.39
3.50	8.82	7.80	19.64
3.60	9.07	7.90	19.90
3.70	9.32	8.00	20.15
3.80	9.57	8.10	20.40
3.90	9.82	8.20	20.65
4.00	10.08	8.30	20.90
4.10	10.33	8.40	21.15
4.20	10.58	8.50	21.41
4.30	10.83	8.60	21.66
4.40	11.08	8.70	21.91
4.50	11.33	8.80	22.16
4.60	11.59	8.90	22.41
4.70	11.84	9.00	22.66
4.80	12.09	-	-
4.90	12.34	-	-
5.00	12.59	-	-

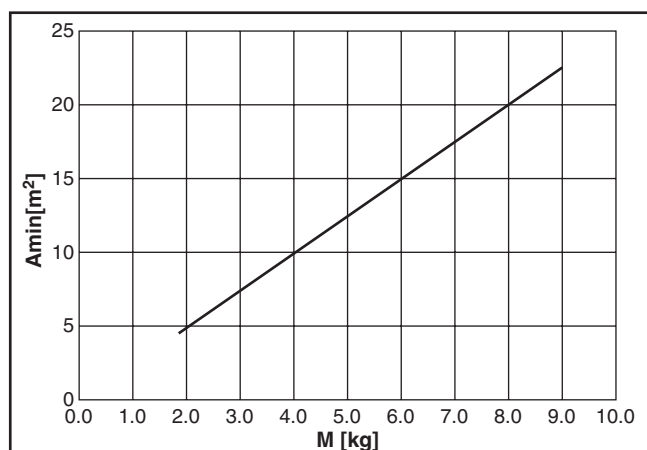

Declaration of Conformity

Manufacturer: TOSHIBA CARRIER CORPORATION
336 Tadehara, Fuji-shi, Shizuoka-ken 416-8521 JAPAN

TCF holder: TOSHIBA CARRIER EUROPE S.A.S
Route de Thil
01120 Montluel FRANCE

Hereby declares that the machinery described below:

Generic Denomination: Air Conditioner

Model / type: Indoor unit
Floor Standing Type
RAV-RM561FT-EN, RAV-RM801FT-EN, RAV-RM1101FT-EN,
RAV-RM1401FT-EN, RAV-RM1601FT-EN
RAV-RM561FT-ES, RAV-RM801FT-ES, RAV-RM1101FT-ES,
RAV-RM1401FT-ES, RAV-RM1601FT-ES
RAV-RM561FT-TR, RAV-RM801FT-TR, RAV-RM1101FT-TR,
RAV-RM1401FT-TR, RAV-RM1601FT-TR

Commercial name: Digital Inverter Series, Super Digital Inverter Series Air Conditioner

Complies with the provisions of the "Machinery Directive" (Directive 2006/42/EC) and the regulations transposing into national law

NOTE

This declaration becomes invalid if technical or operational modifications are introduced without the manufacturer's consent.

Specifications

Model	Sound pressure level (dB(A))		Weight (kg)
	Cooling	Heating	
RAV-RM561FT-EN/ES	*	*	44
RAV-RM801FT-EN/ES	*	*	45
RAV-RM1101FT-EN/ES	*	*	59
RAV-RM1401FT-EN/ES	*	*	59
RAV-RM1601FT-EN/ES	*	*	59
RAV-RM561FT-TR	*	*	44
RAV-RM801FT-TR	*	*	45
RAV-RM1101FT-TR	*	*	59
RAV-RM1401FT-TR	*	*	59
RAV-RM1601FT-TR	*	*	59

※: Under 70 (dB(A))

◆ Information of the refrigerant leak detection sensor

If a refrigerant leak detection sensor detects R32 refrigerant leaks, a fan automatically operates to stir the gases in the room.

When the sensor has been used for about 7 years (Life of the product), a check code "J30" appears on the remote controller screen during operation. If "J29" or "J31" appears on the screen, replace the refrigerant leak detection sensor.

About refrigerant R32

This air conditioner adopts a new HFC type refrigerant (R32) which does not deplete the ozone layer.

1. Safety Caution Concerned to Refrigerant R32

Be sure that water, dust, the former refrigerant or the former refrigerating oil is not mixed into the refrigerating cycle of the air conditioner with refrigerant R32 during installation work or service work. If an incorrect work or incorrect service is performed, there is a possibility to cause a serious accident. Use the tools and materials exclusive to R32 to purpose a safe work.

2. Safety and Cautions on Installation/Service

<Safety items>

When gas concentration and ignition energy are happened at the same time, R32 has a slight possibility of burning. Although it will not ignite under normal work environment conditions, be aware that the flame spreads if ignition should occur.

It is necessary to carry out installation/servicing safely while taking the following precautions into consideration.

- 1) Never use refrigerant other than specified refrigerant (R32) in an air conditioner which is designed to operate with the specified refrigerant (R32).
If other refrigerant than R32 is used, it may cause personal injury, etc. due to a malfunction, a fire, or rupture.
- 2) Since R32 is heavier than air, it tends to accumulate on the bottom (near the floor).
Ventilate properly for the working environment to prevent its combustion.
Especially in a basement or a closed room where there is a high risk of the accumulation, ventilate the room with a local exhaust ventilator.
If refrigerant leakage is confirmed in the room or the place where the ventilation is insufficient, do not work until the proper ventilation is performed and the work environment is improved.
- 3) When performing brazing work, be sure to check for leakage refrigerant or residual refrigerant.
If the leakage refrigerant comes into contact with fire, a poisonous gas may occur, causing a fire. Keep adequate ventilation during the work.
- 4) When refrigerant gas leaks during work, execute ventilation. If the leakage refrigerant comes into contact with a fire, a poisonous gas may occur, causing a fire.
- 5) In places where installing / repairing air-conditioning equipment, etc., keep the source of ignition such as gas combustion equipment, petroleum combustion equipment, electric heater etc. away. Do not smoke in the place.
- 6) When installing or removing an air conditioner, do not mix air in the refrigerant cycle.
If air or others is mixed with the refrigerant, abnormal high pressure occurs in the refrigerating cycle, causing injury due to the breakage.
- 7) After installation work has been completed, confirm that refrigerant gas is not leaking on the flare connection part or others. If leaked refrigerant comes to contact with a fire, toxic gas may occur, causing a fire.
- 8) Perform the installation work and re-installation according to the installation manual.
Pay attention especially to the area of application. Improper installation may cause refrigeration trouble, water leakage, electric shock, or fire etc.
- 9) Unauthorized modifications to the air conditioner may be dangerous. If a breakdown occurs, please call a qualified air conditioner technician or electrician.
Improper repair may result in water leakage, electric shock and fire, etc.
- 10) Carry out the airtight test with nitrogen at a specified pressure. Do not use oxygen or acetylene gas absolutely as it may cause an explosion.
- 11) Always carry a refrigerant leakage detection sensor during the work and work while checking that no refrigerant leaks around working environment.
- 12) If the leakage refrigerant comes into contact with fire, it may cause a fire.
Have a dry powder or CO₂ fire extinguisher adjacent to the charging area.

<Caution items>

- 1) The opposite side dimension of the air-conditioner's flared nut using R32 and the shape of the charge port are the same as those of R410A.
- 2) Be careful not to charge refrigerant by mistake. Should the different type of refrigerant be mixed, be sure to recharge the refrigerant.
- 3) Do not mix the other refrigerant or refrigerating oil with the refrigerant.
- 4) Since the pressure of R32 is 1.6 times higher than that of the former refrigerant (R22), use tools and parts for high pressure resistance specification similar to R410A.
- 5) In the installation time, use clean pipe materials and work with great attention so that water and others do not mix in because pipes are affected by impurities such as water, oxide film, oil, etc. Use the clean pipes. Be sure to braze while flowing nitrogen gas in the pipe. (Never use gas other than nitrogen gas.)
- 6) For the earth protection, use a vacuum pump for air purge.
- 7) R32 refrigerant is Single-component refrigerant that does not change its composition. Although it is possible to charge the refrigerant with either liquid or gas, charge it with liquid.

3. Pipe Materials

For the refrigerant pipes, copper pipe and joints are mainly used.
It is necessary to select the most appropriate pipes to conform to the standard.
Use clean pipes or joints to which little impurities adhere.

1) Copper pipe

<Piping>

The pipe thickness, flare-finishing size, flare nut and others differ according to a refrigerant type. When using a long copper pipe for R32, it is recommended to select "Copper or copper-base pipe without seam" and one with bonded oil amount 40mg/10m or less. Also do not use crushed, deformed, discolored (especially inside) pipes. (Impurities cause clogging of expansion valves and capillary tubes.)

<Flare nut>

Use the flare nuts which are attached to the air conditioner unit.

Be sure to select the pipes with copper thickness in the table below since the pressure of an air conditioner using R32 is higher than that of R22.

Nominal diameter	Outer diameter (mm)	Thickness (mm) R410A or R32
1/2	6.4	0.80
3/8	9.5	0.80
1/2	12.7	0.80
5/8	15.9	1.00

Make sure not to use a thin copper pipe such as 0.7 mm copper thickness in the market.

2) Joint

The flare joint and socket joint are used for joints of the copper pipe. The joints are rarely used for installation of the air conditioner. However clear impurities when using them.

4. Tools

○: R410A tools available
 △: Partly unavailable, ×: R410A tools unavailable

No.	Installation/service tools		Use	Applicability to R32 air conditioner or not	Applicability to R22 air conditioner or not
	Tools / Equipment	specification			
1	Flare tool	Clutch type	Pipe flaring	○	○
2	Copper pipe gauge for adjusting projection margin	—	Flaring by conventional flare tool	○	—
3	Torque wrench	—	Tightening of flare nut	○	×
4	Gauge manifold	Port size 1/2"-20UNF (5/16" Flare)	Evacuating, refrigerant charge, run check, etc.	○ Note 2	×
5	Charge hose	High-voltage		○	×
6	Vacuum pump	—	Vacuum drying	○ Note 3 1/2"-20UNF(5/16" Flare)	△ Connection diameter 1/4"
7	Vacuum pump adapter	—	Vacuum drying	○ Note 4 1/2"-20UNF(5/16" Flare)	△ Connection diameter 1/4"
8	Electronic balance for refrigerant charging	For 10 kg or 20 kg cylinder	Refrigerant charge	○	○
9	Leakage detector	—	Gas leakage check	○ Note 5	○ Note 5
10	Refrigerant cylinder	—	Refrigerant charge	× Note 6	×
11	Refrigerant recovery cylinder	Exclusive for R32	Refrigerant recovery container	× Note 7	×
12	Refrigerant recovery device	—	Refrigerant recovery device	○ Note 8	△ Connection diameter 1/4"

Note 1 When flaring is carried out for R410A or R32 using the conventional flare tools, adjustment of projection margin is necessary. For this adjustment, a copper pipe gauge, etc. is necessary.

Note 2 When saturation temperature is described, the gauge manifold differs for R410A and R32. If saturation temperature reading is required, special tools exclusive for R32 are required.

Note 3 Since R32 has a slight possibility of burning, be sure to use the tools corresponding to R32.

Note 4 Like R410, a Vacuum pump adapter needs installing to prevent a Vacuum pump oil (mineral oil) from flowing backward into the Charge hose. Mixing of the Vacuum pump oil into R32 refrigerant may cause a trouble such as generation of sludge, clogging of capillary, etc.

Note 5 Be sure to use those tools after confirming they correspond to each refrigerant.

Note 6 For a refrigerant cylinder exclusive for R32, the paint color (or label color) of the cylinder is set to the specified color (light blue) together with the indication of the refrigerant name.

Note 7 Although the container specification is the same as that of R410A, use a recovering container exclusive for R32 to avoid mixing with other refrigerants.

Note 8 Be careful for miss charging of the refrigerant during work. Miss charging of the refrigerant type may cause not only damage of the equipment but also a fire etc.

General tools

In addition to the above exclusive tools, the following equipment is necessary as the general tools.

- | | |
|-----------------------|---------------------------------|
| 1) Pipe cutter | 6) Spanner or Adjustable wrench |
| 2) Reamer | 7) Hole core drill |
| 3) Pipe bender | 8) Tape measure |
| 4) Level vial | 9) Metal saw |
| 5) Screwdriver (+, -) | |

Also prepare the following equipment for other installation method and run check.

- | | |
|----------------|--|
| 1) Clamp meter | 3) Insulation resistance tester (Megger) |
| 2) Thermometer | 4) Electroscopes |

About refrigerant R410A

This air conditioner adopts a HFC type refrigerant (R410A) which does not deplete the ozone layer.

1. Safety Caution Concerned to R410A Refrigerant

The pressure of R410A is 1.6 times higher than that of the former refrigerant (R22).

Accompanied with change of refrigerant, the refrigerating oil has been also changed.

Therefore, be sure that water, dust, the former refrigerant or the former refrigerating oil is not mixed into the refrigerating cycle of the air conditioner with R410A refrigerant during installation work or service work.

If an incorrect work or incorrect service is performed, there is a possibility to cause a serious accident.

Use the tools and materials exclusive to R410A to purpose a safe work.

2. Cautions on Installation/Service

1) Do not mix the other refrigerant or refrigerating oil.

For the tools exclusive to R410A, shapes of all the joints including the service port differ from those of the former refrigerant in order to prevent mixture of them.

2) As the use pressure of the R410A refrigerant is high, use material thickness of the pipe and tools which are specified for R410A.

3) In the installation time, use clean pipe materials and work with great attention so that water and others do not mix in because pipes are affected by impurities such as water, oxide scales, oil, etc.

Use the clean pipes.

Be sure to braze while flowing nitrogen gas. (Never use gas other than nitrogen gas.)

4) For the earth protection, use a vacuum pump for air purge.

5) R410A refrigerant is azeotropic mixture type refrigerant.

Therefore use liquid type to charge the refrigerant. (If using gas for charging, composition of the refrigerant changes and then characteristics of the air conditioner change.)

3. Pipe Materials

For the refrigerant pipes, copper pipe and joints are mainly used.

It is necessary to select the most appropriate pipes to conform to the standard.

Use clean pipes or joints to which little impurities adhere.

1) Copper pipe

<Piping>

The pipe thickness, flare-finishing size, flare nut and others differ according to a refrigerant type.

When using a long copper pipe for R410A, it is recommended to select "Copper or copper-base pipe without seam" and one with bonded oil amount 40mg/10m or less.

Also do not use crushed, deformed, discolored (especially inside) pipes.

(Impurities cause clogging of expansion valves and capillary tubes.)

<Flare nut>

Use the flare nuts which are attached to the air conditioner unit.

2) Joint

The flare joint and socket joint are used for joints of the copper pipe.

The joints are rarely used for installation of the air conditioner. However clear impurities when using them.

4. Tools

1. Required Tools for R410A

Mixing of different types of oil may cause a trouble such as generation of sludge, clogging of capillary, etc. Accordingly, the tools to be used are classified into the following three types.

- 1) Tools exclusive for R410A (Those which cannot be used for conventional refrigerant (R22))
- 2) Tools exclusive for R410A, but can be also used for conventional refrigerant (R22)
- 3) Tools commonly used for R410A and for conventional refrigerant (R22)

The table below shows the tools exclusive for R410A and their interchangeability.

Tools exclusive for R410A (The following tools for R410A are required.)

Tools whose specifications are changed for R410A and their interchangeability

No.	Used tool	Usage	R410A air conditioner installation		Conventional air conditioner installation
			Existence of new equipment for R410A	Whether conventional equipment can be used	Whether conventional equipment can be used
①	Flare tool	Pipe flaring	Yes	* (Note)	Yes
②	Copper pipe gauge for adjusting projection margin	Flaring by conventional flare tool	Yes	* (Note)	* (Note)
③	Torque wrench	Tightening of flare nut	Yes	No	No
④	Gauge manifold	Evacuating, refrigerant charge, run check, etc.	Yes	No	No
⑤	Charge hose				
⑥	Vacuum pump adapter	Vacuum evacuating	Yes	No	Yes
⑦	Electronic balance for refrigerant charging	Refrigerant charge	Yes	Yes	Yes
⑧	Refrigerant cylinder	Refrigerant charge	Yes	No	No
⑨	Leakage detector	Gas leakage check	Yes	No	Yes

(Note) When flaring is carried out for R410A using the conventional flare tools, adjustment of projection margin is necessary. For this adjustment, a copper pipe gauge, etc. are necessary.

General tools (Conventional tools can be used.)

In addition to the above exclusive tools, the following equipment which serve also for R22 are necessary as the general tools.

- | | |
|---|--|
| 1) Vacuum pump. Use vacuum pump by attaching vacuum pump adapter. | |
| 2) Torque wrench | 8) Spanner or Adjustable wrench |
| 3) Pipe cutter | 9) Hole core drill |
| 4) Reamer | 10) Hexagon wrench (Opposite side 4mm) |
| 5) Pipe bender | 11) Tape measure |
| 6) Level vial | 12) Metal saw |
| 7) Screwdriver (+, -) | |

Also prepare the following equipment for other installation method and run check.

- | | |
|----------------|--|
| 1) Clamp meter | 3) Insulation resistance tester (Megger) |
| 2) Thermometer | 4) Electroscop |

1. CONSTRUCTION VIEWS (EXTERNAL VIEWS)

1-1. RAV-RM561FT*

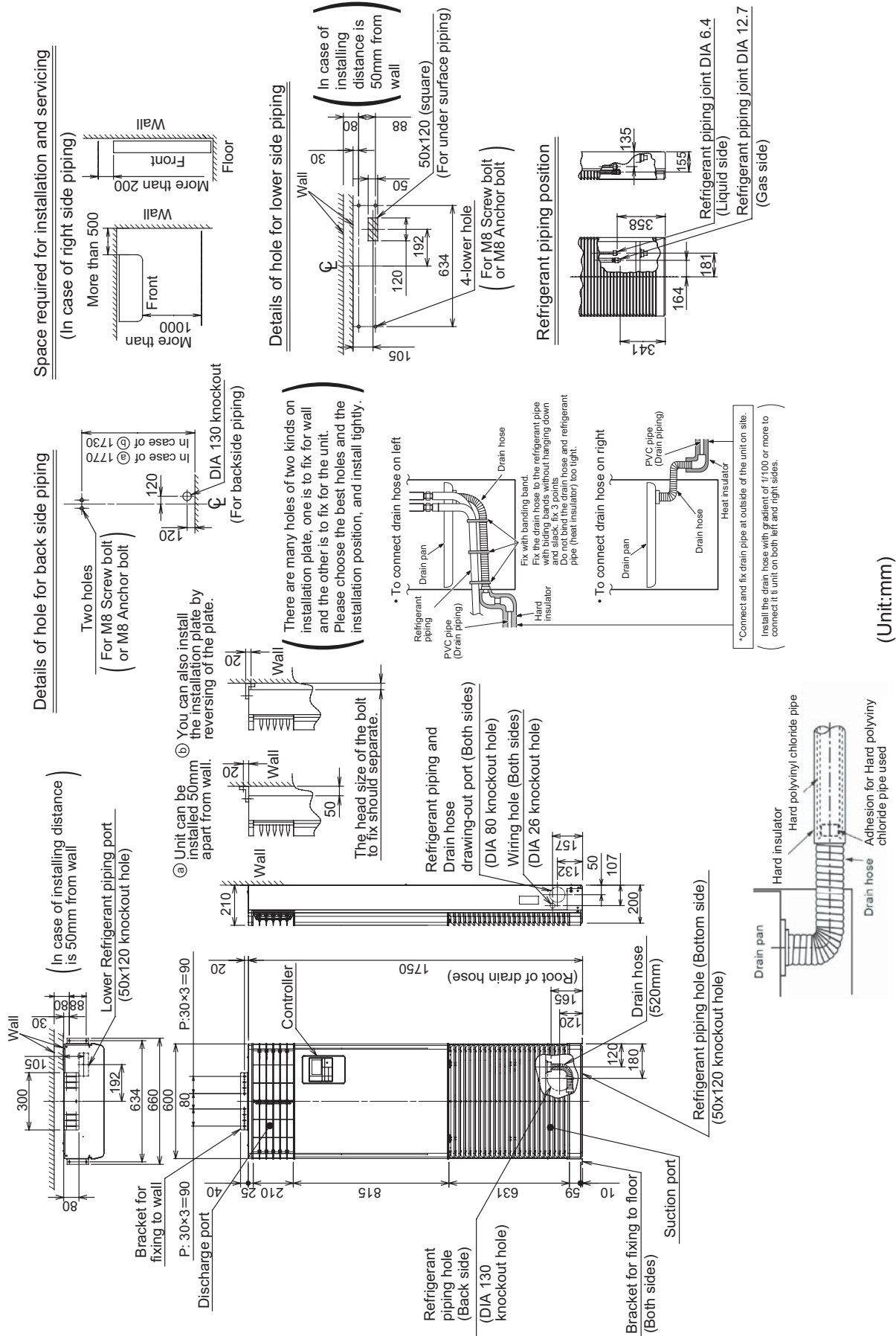

(Unit:mm)

1-2. RAV-RM801FT*

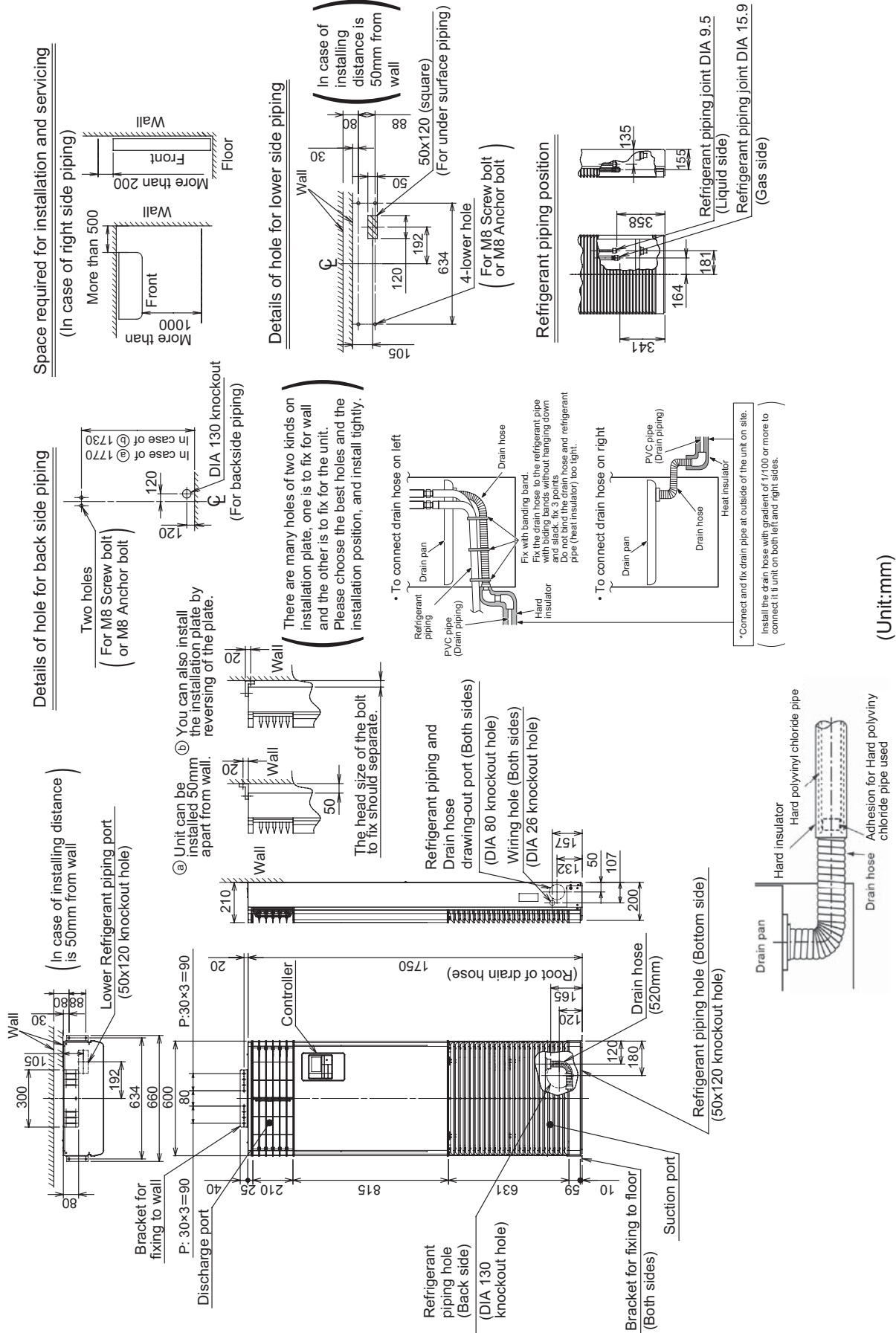

(Unit:mm)

2. WIRING DIAGRAMS

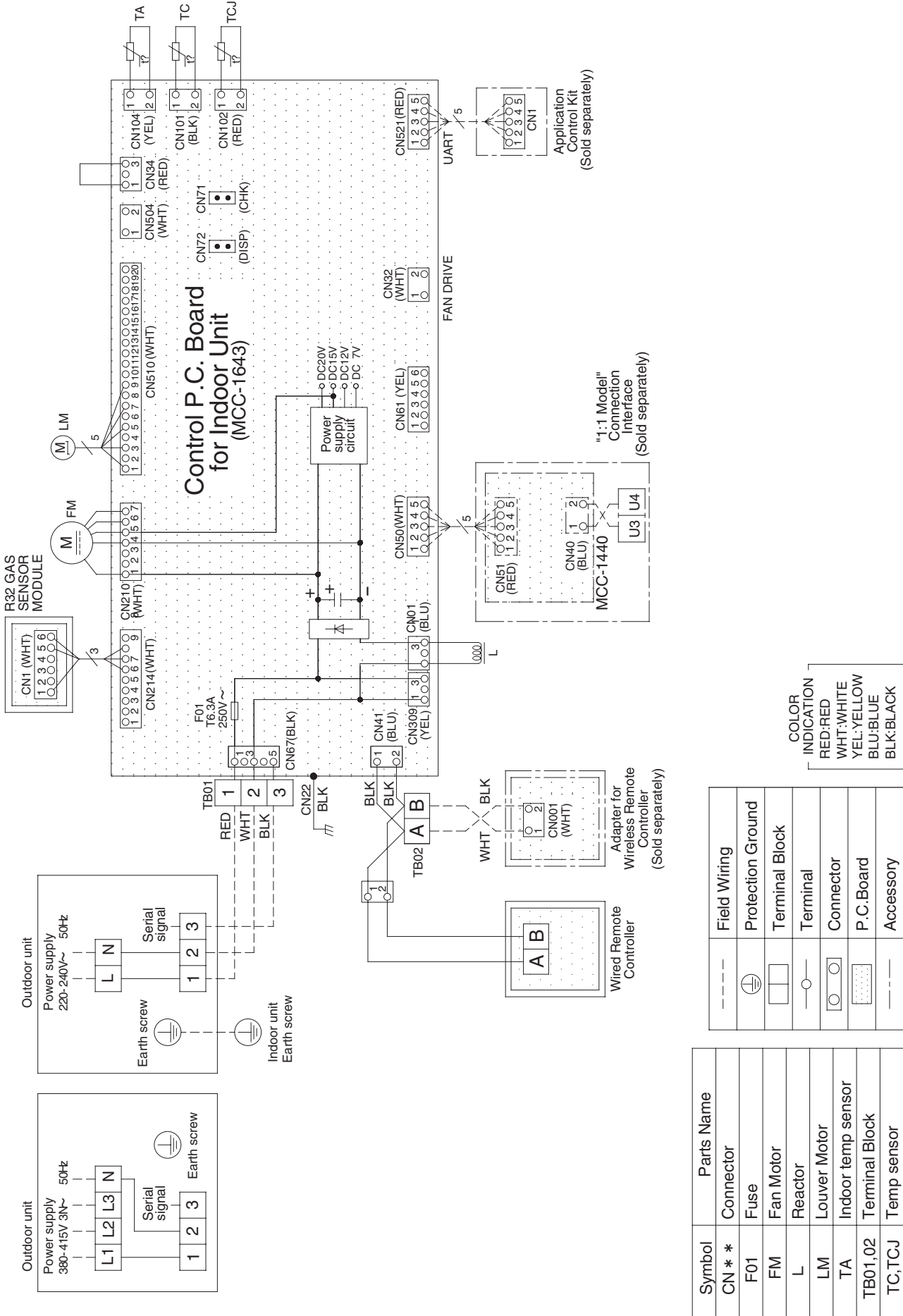

Symbol	Parts Name
CN * *	Connector
F01	Fuse
FM	Fan Motor
L	Reactor
LM	Louver Motor
TA	Indoor temp sensor
TB01,02	Terminal Block
TC, TCJ	Temp sensor

---	Field Wiring
⊕	Protection Ground
□	Terminal Block
○	Terminal
□	Connector
□	P.C.Board
---	Accessory

3. PARTS RATING

Indoor unit

Model	RAV-	RM56*	RM80*	RM110*	RM140*	RM160*
Fan motor		ICF-340D62-1		ICF-340WD109-1		
Louver motor		MP24Z4N				
TA sensor		Lead wire length: 1200 mm				
TC sensor		Lead wire length: 1200 mm Vinyl tube (Black)				
TCJ sensor		Lead wire length: 1200 mm Vinyl tube (Red)				
Refrigerant leak detection sensor		FIS5084-T1C1				

4. SYSTEMATIC REFRIGERATING CYCLE DIAGRAM

4-1. Indoor Unit

- Single type (Combination of 1 indoor unit and 1 outdoor unit)

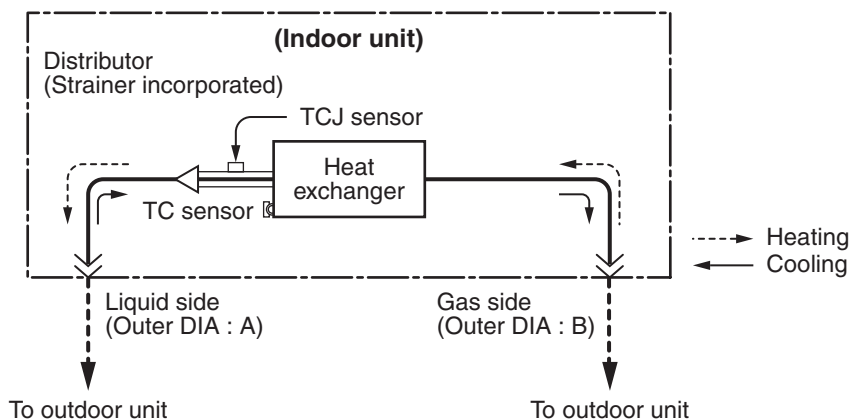

Dimension table

(Unit: mm)

Indoor unit	Outer diameter of refrigerant pipe	
	Liquid side DIA A	Gas side DIA B
RM56 type	6.4	12.7
RM80 ~ 160 type	9.5	15.9

- Twin type (Combination of 2 indoor units and 1 outdoor unit)

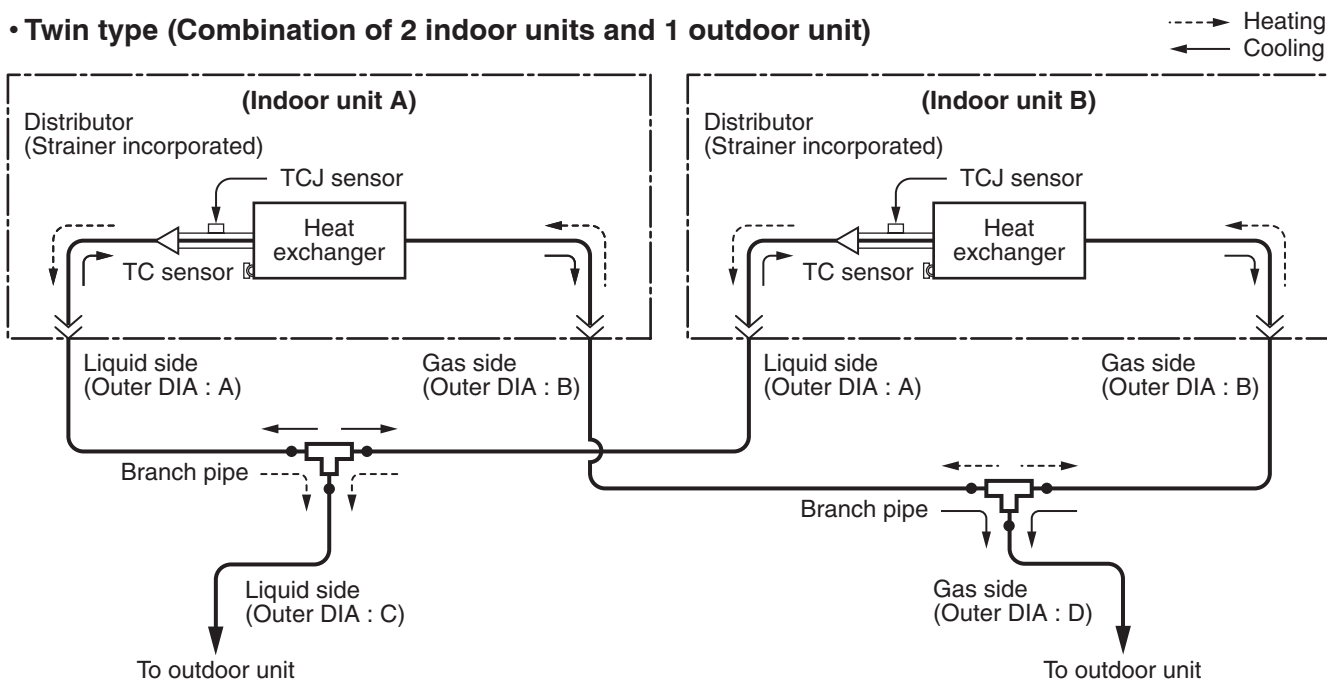

(Unit: mm)

Indoor unit	Branch pipe	A	B	C	D
RM56 × 2	RBC-TWP30E2	6.4	12.7	9.5	15.9
RM80 × 2	RBC-TWP50E2	9.5	15.9	9.5	15.9
RM110 × 2 RM140 × 2	RBC-TWP101E	9.5	15.9	12.7	28.6

● Triple type (3 indoor units and 1 outdoor unit)

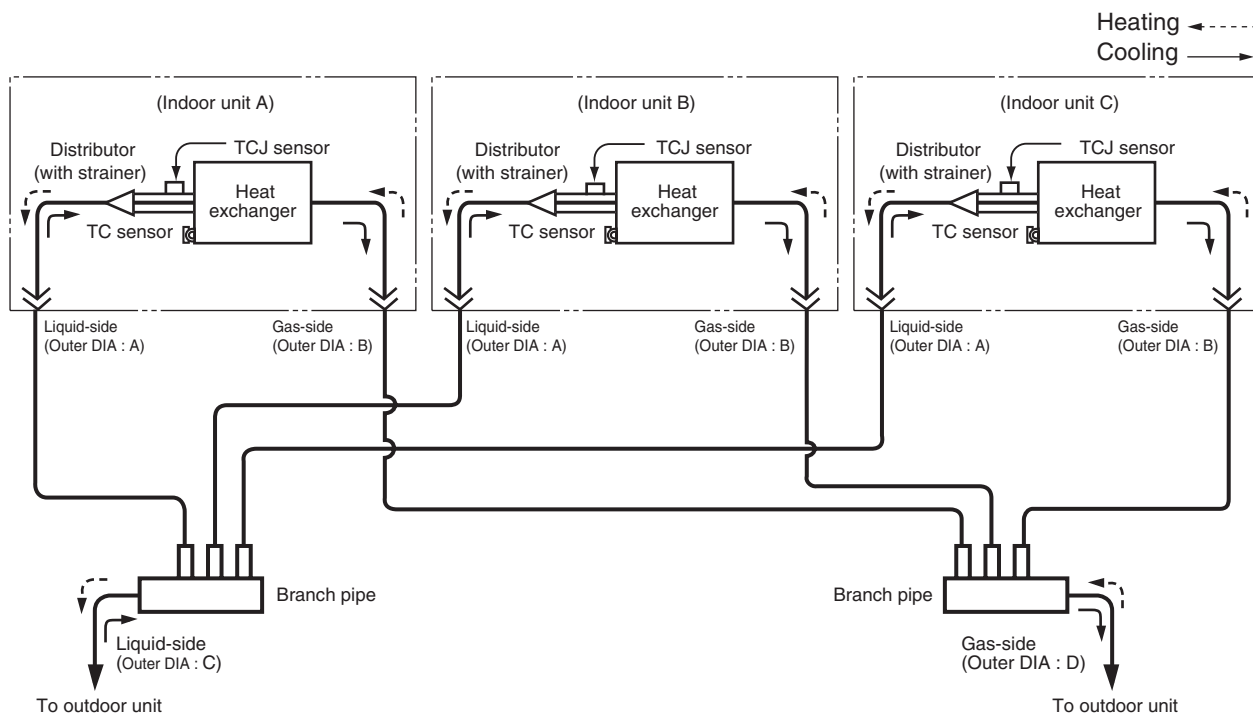

Dimension table

(Unit: mm)

Indoor unit	Branch pipe	A	B	C	D
RM56 × 3	RBC-TRP100E	6.4	12.7	9.5	15.9
RM80 × 3	RBC-TRP100E	9.5	15.9	12.7	28.6

● Double-twin type (4 indoor units and 1 outdoor unit)

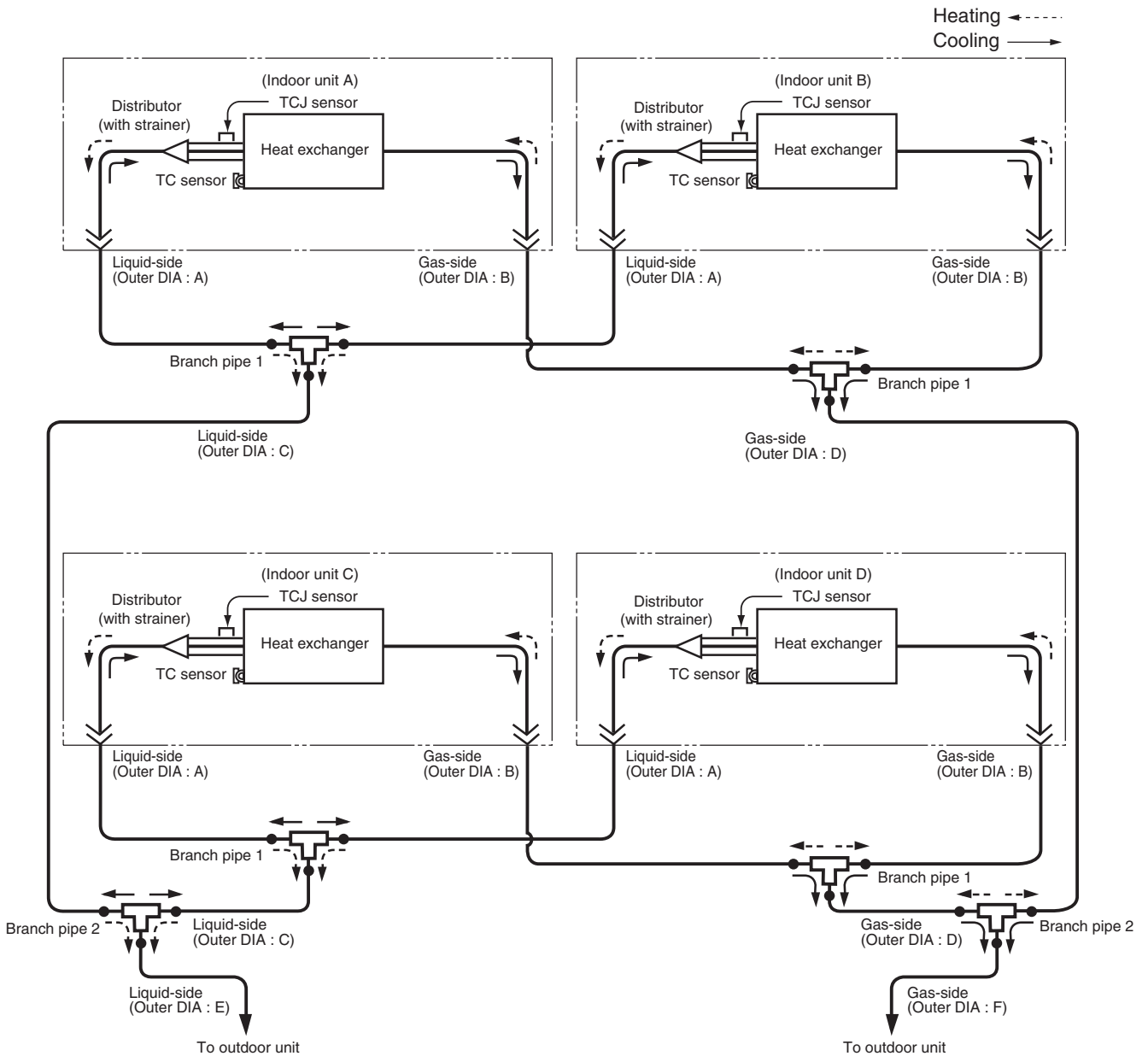

Dimension table

(Unit: mm)

Indoor unit	Branch pipe 1	Branch pipe 2	A	B	C	D	E	F
RM56 × 4	RBC-TWP30E2 x2	RBC-TWP101E	6.4	12.7	9.5	15.9	12.7	28.6
RM80 × 4	RBC-TWP50E2 x2	RBC-TWP101E	9.5	15.9	9.5	15.9	12.7	28.6

5. INDOOR CONTROL CIRCUIT

5-1. Indoor Controller Block Diagram

5-1-1. Connection of Wired Remote Controller

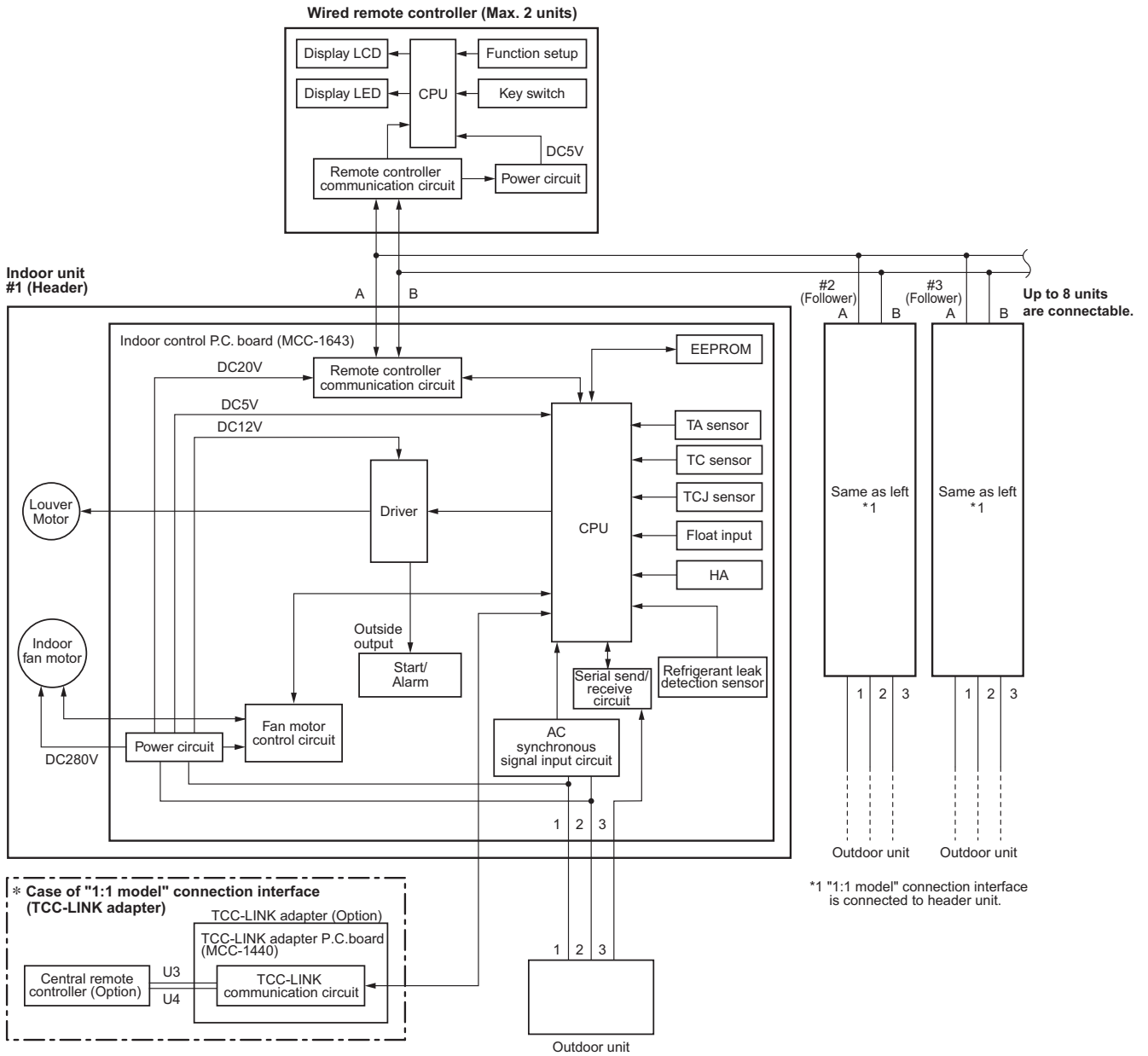

5-1-2. Connection of Wireless Remote Controller Kit

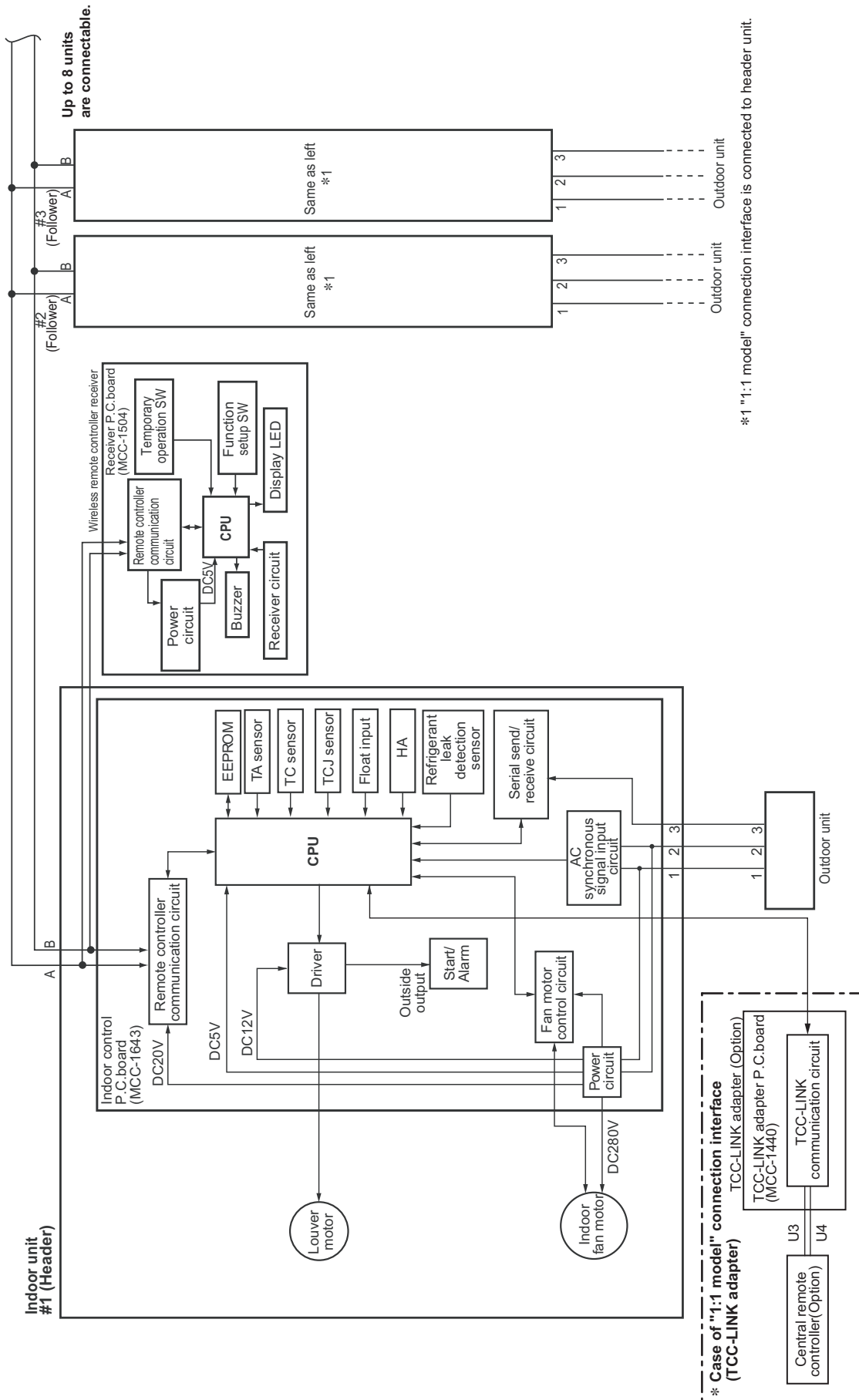



5-2. Control Specifications



No.	Item	Outline of specifications	Remarks																										
1	When power supply is reset	<p>1) Distinction of outdoor unit When the power supply is reset, the outdoors are distinguished and the control is selected according to the distinguished result.</p> <p>2) Resetting of indoor fan speed and louver control Based on EEPROM data, select setting of the indoor fan speed and the louver control.</p>	Fan speed (rpm)/ Air direction adjustment																										
2	Operation mode selection	<p>1) Based on the operation mode selecting command from the remote controller, the operation mode is selected.</p> <table border="1" style="width: 100%; border-collapse: collapse;"> <thead> <tr> <th style="text-align: center;">Remote controller command</th> <th style="text-align: center;">Control outline</th> </tr> </thead> <tbody> <tr> <td style="text-align: center;">STOP</td> <td>Air conditioner stops.</td> </tr> <tr> <td style="text-align: center;">FAN</td> <td>Fan operation</td> </tr> <tr> <td style="text-align: center;">COOL</td> <td>Cooling operation</td> </tr> <tr> <td style="text-align: center;">DRY</td> <td>Dry operation</td> </tr> <tr> <td style="text-align: center;">HEAT</td> <td>Heating operation</td> </tr> <tr> <td style="text-align: center;">AUTO</td> <td> <ul style="list-style-type: none"> • COOL/HEAT operation mode is automatically selected by TA, Ts and TO for operation. • The operation is performed as shown in the following figure according to TA value at the first time only. (In the range of $T_s + \alpha - 1 < TA < T_s + \alpha + 1$, Cooling thermostat OFF (Fan)/Setup fan speed operation continues.) <div style="text-align: center;"> </div> <ul style="list-style-type: none"> • α is corrected according to the outside temperature. <table border="1" style="width: 100%; border-collapse: collapse; margin-top: 10px;"> <thead> <tr> <th style="text-align: center;">Outside temp.</th> <th style="text-align: center;">Correction value (α)</th> </tr> </thead> <tbody> <tr> <td>TO Nothing</td> <td style="text-align: center;">0°C</td> </tr> <tr> <td>TO $\geq 24^\circ\text{C}$</td> <td style="text-align: center;">-1°C</td> </tr> <tr> <td>24 > TO $\geq 18^\circ\text{C}$</td> <td style="text-align: center;">0°C</td> </tr> <tr> <td>TO < 18°C</td> <td style="text-align: center;">+1°C</td> </tr> <tr> <td>TO Trouble</td> <td style="text-align: center;">0°C</td> </tr> </tbody> </table> </td> </tr> </tbody> </table>	Remote controller command	Control outline	STOP	Air conditioner stops.	FAN	Fan operation	COOL	Cooling operation	DRY	Dry operation	HEAT	Heating operation	AUTO	<ul style="list-style-type: none"> • COOL/HEAT operation mode is automatically selected by TA, Ts and TO for operation. • The operation is performed as shown in the following figure according to TA value at the first time only. (In the range of $T_s + \alpha - 1 < TA < T_s + \alpha + 1$, Cooling thermostat OFF (Fan)/Setup fan speed operation continues.) <div style="text-align: center;"> </div> <ul style="list-style-type: none"> • α is corrected according to the outside temperature. <table border="1" style="width: 100%; border-collapse: collapse; margin-top: 10px;"> <thead> <tr> <th style="text-align: center;">Outside temp.</th> <th style="text-align: center;">Correction value (α)</th> </tr> </thead> <tbody> <tr> <td>TO Nothing</td> <td style="text-align: center;">0°C</td> </tr> <tr> <td>TO $\geq 24^\circ\text{C}$</td> <td style="text-align: center;">-1°C</td> </tr> <tr> <td>24 > TO $\geq 18^\circ\text{C}$</td> <td style="text-align: center;">0°C</td> </tr> <tr> <td>TO < 18°C</td> <td style="text-align: center;">+1°C</td> </tr> <tr> <td>TO Trouble</td> <td style="text-align: center;">0°C</td> </tr> </tbody> </table>	Outside temp.	Correction value (α)	TO Nothing	0°C	TO $\geq 24^\circ\text{C}$	-1°C	24 > TO $\geq 18^\circ\text{C}$	0°C	TO < 18°C	+1°C	TO Trouble	0°C	TA: Room temp. Ts: Setup temp. TO: Outside temp.
Remote controller command	Control outline																												
STOP	Air conditioner stops.																												
FAN	Fan operation																												
COOL	Cooling operation																												
DRY	Dry operation																												
HEAT	Heating operation																												
AUTO	<ul style="list-style-type: none"> • COOL/HEAT operation mode is automatically selected by TA, Ts and TO for operation. • The operation is performed as shown in the following figure according to TA value at the first time only. (In the range of $T_s + \alpha - 1 < TA < T_s + \alpha + 1$, Cooling thermostat OFF (Fan)/Setup fan speed operation continues.) <div style="text-align: center;"> </div> <ul style="list-style-type: none"> • α is corrected according to the outside temperature. <table border="1" style="width: 100%; border-collapse: collapse; margin-top: 10px;"> <thead> <tr> <th style="text-align: center;">Outside temp.</th> <th style="text-align: center;">Correction value (α)</th> </tr> </thead> <tbody> <tr> <td>TO Nothing</td> <td style="text-align: center;">0°C</td> </tr> <tr> <td>TO $\geq 24^\circ\text{C}$</td> <td style="text-align: center;">-1°C</td> </tr> <tr> <td>24 > TO $\geq 18^\circ\text{C}$</td> <td style="text-align: center;">0°C</td> </tr> <tr> <td>TO < 18°C</td> <td style="text-align: center;">+1°C</td> </tr> <tr> <td>TO Trouble</td> <td style="text-align: center;">0°C</td> </tr> </tbody> </table>	Outside temp.	Correction value (α)	TO Nothing	0°C	TO $\geq 24^\circ\text{C}$	-1°C	24 > TO $\geq 18^\circ\text{C}$	0°C	TO < 18°C	+1°C	TO Trouble	0°C																
Outside temp.	Correction value (α)																												
TO Nothing	0°C																												
TO $\geq 24^\circ\text{C}$	-1°C																												
24 > TO $\geq 18^\circ\text{C}$	0°C																												
TO < 18°C	+1°C																												
TO Trouble	0°C																												
3	Room temp. control	<p>1) Adjustment range: Remote controller setup temperature (°C)</p> <table border="1" style="width: 100%; border-collapse: collapse; margin-top: 10px;"> <thead> <tr> <th></th> <th style="text-align: center;">COOL/DRY</th> <th style="text-align: center;">HEAT</th> <th style="text-align: center;">AUTO</th> </tr> </thead> <tbody> <tr> <td>Wired type (Built-in unit)</td> <td style="text-align: center;">18 to 29</td> <td style="text-align: center;">18 to 29</td> <td style="text-align: center;">18 to 29</td> </tr> <tr> <td>Wireless type</td> <td style="text-align: center;">17 to 30</td> <td style="text-align: center;">17 to 30</td> <td style="text-align: center;">17 to 30</td> </tr> </tbody> </table>		COOL/DRY	HEAT	AUTO	Wired type (Built-in unit)	18 to 29	18 to 29	18 to 29	Wireless type	17 to 30	17 to 30	17 to 30															
	COOL/DRY	HEAT	AUTO																										
Wired type (Built-in unit)	18 to 29	18 to 29	18 to 29																										
Wireless type	17 to 30	17 to 30	17 to 30																										



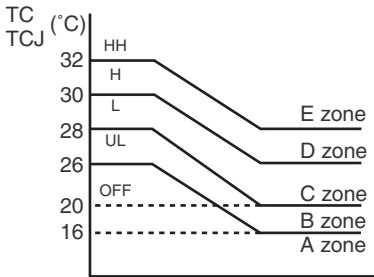

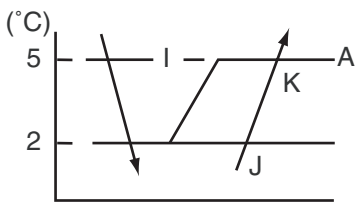
No.	Item	Outline of specifications	Remarks												
3	Room temp. control (Continued)	<p>2) Using the "Code(DN)" [0006], the setup temperature in heating operation can be corrected.</p> <table border="1" data-bbox="443 286 1096 369"> <tr> <td>Setup "Data"</td> <td>0000</td> <td>0002</td> <td>0004</td> <td>0006</td> </tr> <tr> <td>Setup temp. correction</td> <td>+0°C</td> <td>+2°C</td> <td>+4°C</td> <td>+6°C</td> </tr> </table> <p>Setting at shipment</p> <table border="1" data-bbox="443 427 732 470"> <tr> <td>Setup "Data"</td> <td>0000</td> </tr> </table>	Setup "Data"	0000	0002	0004	0006	Setup temp. correction	+0°C	+2°C	+4°C	+6°C	Setup "Data"	0000	Shift of suction temperature in heating operation
Setup "Data"	0000	0002	0004	0006											
Setup temp. correction	+0°C	+2°C	+4°C	+6°C											
Setup "Data"	0000														
4	Automatic capacity control (GA control)	<p>1) Based on the difference between TA and Ts, the operation frequency is instructed to the outdoor unit.</p> <p>2) Cooling operation Every 90 seconds, the room temperature difference between temperature detected by TA and Ts and the varied room temperature value are calculated to obtain the correction value of the frequency command and then the present frequency command is corrected.</p> <p>TA (n) – Ts (n) : Room temp. difference n : Counts of detection TA (n-1) – Ts (n) : Varied room temp. value n – 1 : Counts of detection of 90 seconds before</p> <p>3) Heating operation Every 1 minute (60 sec.), the room temperature difference between temperature detected by TA and Ts and the varied room temperature value are calculated to obtain the correction value of the frequency command and then the present frequency command is corrected.</p> <p>Ts (n) – TA (n) : Room temp. difference n : Counts of detection TA (n) – TA (n – 1) : Varied room temp. value n – 1 : Counts of detection of 1 minute before</p> <p>4) Dry operation The frequency correction control is same as those of the cooling operation. However, the maximum frequency is limited to approximately 40%.</p> <p>Note) When LOW is set up, the maximum frequency is limited to approximately 80%.</p>													
5	Automatic cooling/heating control	<p>1) The judgment of selecting COOL/HEAT is carried out as shown below. When +1.5 exceeds against Tsh 10 minutes and after thermostat OFF, heating operation (Thermostat OFF) exchanges to cooling operation. Description in the parentheses shows an example of cooling ON/OFF.</p> <div data-bbox="478 1612 1117 1825"> </div> <p>When –1.5 lowers against Tsc 10 minutes and after thermostat OFF, cooling operation (Thermostat OFF) exchanges to heating operation.</p> <p>2) For the automatic capacity control after judgment of cooling/heating, see Item 4.</p> <p>3) For temperature correction of room temp. control in automatic heating, see Item 3.</p>	<p>Tsc: Setup temp. in cooling operation</p> <p>Tsh: Setup temp. in heating operation + temp. correction of room temp. control</p>												

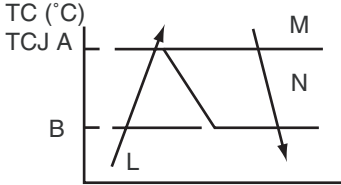
No.	Item	Outline of specifications	Remarks
6	Fan speed selection	<p>1) Operation with (HH), (H+), (H), (L+) (L) or [AUTO] mode is carried out by the command from the remote controller.</p> <p>2) When the fan speed mode [AUTO] is selected, the fan speed varies by the difference between TA and Ts.</p> <p><COOL></p> <p>The graph for COOL mode shows fan speed levels (A-G) on the y-axis and TA - Tsc (°C) on the x-axis. The levels are: A (+3.0), B (+2.5), C (+2.0), D (+1.5), E (+1.0), F (+0.5), and G (0). Modes in parentheses indicate automatic cooling operation.</p> <ul style="list-style-type: none"> Controlling operation in case when thermostat of remote controller works is same as a case when thermostat of the body works. If the fan speed has been changed once, it is not changed for 3 minutes. However when the fan speed is exchanged, the fan speed changes. When cooling operation has started, select a downward slope for the fan speed, that is, the high position. If the temperature is just on the difference boundary, the fan speed does not change. Mode in the parentheses indicates one in automatic cooling operation. <p><HEAT></p> <p>The graph for HEAT mode shows fan speed levels (A-E) on the y-axis and Tsh - TA (°C) on the x-axis. The levels are: A (-0.5), E (0), D (+0.5), C (+1.0), B (+1.5), and A (+2.0). Modes in parentheses indicate automatic heating operation.</p> <p>The value with [] indicates the temperature at using remote controller sensor (separately sold) thermostat. The value without [] indicates the temperature at using body sensor thermostat.</p> <ul style="list-style-type: none"> If the fan speed has been changed once, it is not changed for 1 minute. However when the fan speed is exchanged, the fan speed changes. When heating operation has started, select an upward slope for the fan speed, that is, the high position. If the temperature is just on the difference boundary, the fan speed does not change. Mode in the parentheses indicates one in automatic heating operation. In TC ≥ 60°C, the fan speed increases by 1 step. 	<p>HH > H+ > H > L+ > L > UL</p> <p>TC: Indoor heat exchanger sensor temperature</p>









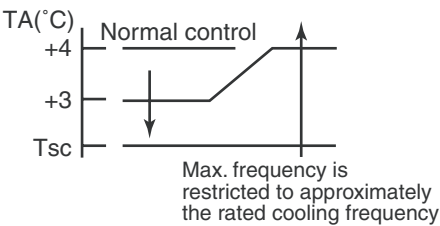
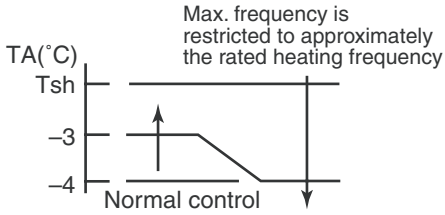







No.	Item	Outline of specifications	Remarks																																																															
6	Fan speed selection (Continued):	<p style="text-align: right;">Number of rotations (rpm)</p> <table border="1" data-bbox="427 253 1160 689"> <thead> <tr> <th colspan="2"></th> <th>RM56</th> <th>RM80</th> <th>RM110</th> <th>RM140 RM160</th> </tr> </thead> <tbody> <tr> <td rowspan="5">COOL</td> <td>HH</td> <td>430</td> <td>500</td> <td>700</td> <td>740</td> </tr> <tr> <td>H+</td> <td>400</td> <td>450</td> <td>660</td> <td>690</td> </tr> <tr> <td>H</td> <td>370</td> <td>420</td> <td>610</td> <td>630</td> </tr> <tr> <td>L+</td> <td>320</td> <td>360</td> <td>520</td> <td>590</td> </tr> <tr> <td>L</td> <td>310</td> <td>350</td> <td>510</td> <td>580</td> </tr> <tr> <td rowspan="7">HEAT</td> <td>HH</td> <td>430</td> <td>500</td> <td>700</td> <td>740</td> </tr> <tr> <td>H+</td> <td>400</td> <td>450</td> <td>660</td> <td>690</td> </tr> <tr> <td>H</td> <td>370</td> <td>420</td> <td>610</td> <td>630</td> </tr> <tr> <td>L+</td> <td>340</td> <td>380</td> <td>560</td> <td>600</td> </tr> <tr> <td>L</td> <td>320</td> <td>360</td> <td>520</td> <td>590</td> </tr> <tr> <td>UL</td> <td>280</td> <td>280</td> <td>450</td> <td>520</td> </tr> </tbody> </table> <p>3) In heating operation, the mode changes to [UL] if thermostat is turned off.</p> <p>4) If $TA \geq 25^{\circ}\text{C}$ when heating operation has started and when defrost operation has been cleared, the air conditioner operates with [H] mode or higher mode for 1 minute after TC entered in E zone of cool air discharge preventive control (Item 7).</p>			RM56	RM80	RM110	RM140 RM160	COOL	HH	430	500	700	740	H+	400	450	660	690	H	370	420	610	630	L+	320	360	520	590	L	310	350	510	580	HEAT	HH	430	500	700	740	H+	400	450	660	690	H	370	420	610	630	L+	340	380	560	600	L	320	360	520	590	UL	280	280	450	520	
		RM56	RM80	RM110	RM140 RM160																																																													
COOL	HH	430	500	700	740																																																													
	H+	400	450	660	690																																																													
	H	370	420	610	630																																																													
	L+	320	360	520	590																																																													
	L	310	350	510	580																																																													
HEAT	HH	430	500	700	740																																																													
	H+	400	450	660	690																																																													
	H	370	420	610	630																																																													
	L+	340	380	560	600																																																													
	L	320	360	520	590																																																													
	UL	280	280	450	520																																																													

No.	Item	Outline of specifications	Remarks
7	Cool air discharge preventive control	<p>1) In heating operation, the indoor fan is controlled based on the detected temperature of TC sensor or TCJ sensor. As shown below, the upper limit of the revolution frequency is restricted.</p> <p>However B zone is assumed as C zone for 6 minutes and after when the compressor activated. In defrost operation, the control value of TC is shifted by +6°C.</p> 	<p>In D and E zones, the priority is given to fan speed selection setup of remote controller.</p> <p>In A zone while thermostat is ON, [ (Heating ready)] is displayed.</p> <p>TCJ: Indoor heat exchanger sensor temperature</p>
8	Freeze preventive control (Low temperature release)	<p>1) The cooling operation (including Dry operation) is performed as follows based on the detected temperature of TC sensor or TCJ sensor.</p> <p>When [J] zone is detected for 6 minutes (Following figure), the commanded frequency is decreased from the real operation frequency.</p> <p>After then the commanded frequency changes every 30 seconds while operation is performed in [J] zone.</p> <p>In [K] zone, time counting is interrupted and the operation is held.</p> <p>When [I] zone is detected, the timer is cleared and the operation returns to the normal operation.</p> <p>If the commanded frequency becomes S0 because the operation continues in [J] zone, the return temperature A is raised from 5°C to 12°C until [I] zone is detected and the indoor fan operates with Low mode</p>  <p>In heating operation, the freeze-preventive control works if 4-way valve is not changed and the following conditions are satisfied. (However the temperature for [J] zone dashing control is changed from 2°C to -5°C.)</p> <p><Conditions></p> <ul style="list-style-type: none"> • When ① or ② is established 5 minutes after activation. <ul style="list-style-type: none"> ① $TCn \leq TC(n-1) - 5$ ② $TCn < TC(n-1) - 1$ and $TCn \leq TA < 5^\circ C$ 	<p>TCn: TC temperature when 5 minutes elapsed after activation</p> <p>TC (n - 1): TC temperature at start time</p>















No.	Item	Outline of specifications	Remarks											
9	High-temp. release control	<p>1) The heating operation is performed as follows based on the detected temperature of TC sensor or TCJ sensor.</p> <ul style="list-style-type: none"> • When [M] zone is detected, the commanded frequency is decreased from the real operation frequency. After then the commanded frequency changes every 30 seconds while operation is performed in [M] zone. • In [N] zone, the commanded frequency is held. • When [L] zone is detected, the commanded frequency is returned to the original value by approx. 6Hz every 60 seconds. <p>Setup at shipment</p> <table border="1" data-bbox="432 600 762 757"> <thead> <tr> <th rowspan="2">Refrigerant</th> <th colspan="2">Control temp. (°C)</th> </tr> <tr> <th>A</th> <th>B</th> </tr> </thead> <tbody> <tr> <td>R410A</td> <td>56 (54)</td> <td>52 (52)</td> </tr> <tr> <td>R32</td> <td>55 (53)</td> <td>51 (51)</td> </tr> </tbody> </table>  <p>NOTE: When the operation has started or when TC or TCJ < 30°C at start of the operation or after operation start, temperature is controlled between values in parentheses of A and B.</p>	Refrigerant	Control temp. (°C)		A	B	R410A	56 (54)	52 (52)	R32	55 (53)	51 (51)	<p>However this control is ignored in case of the follower unit of the twin.</p> <p>Same status as that when “thermostat-OFF” (status that the air conditioner enters in the room temp. monitor mode when the temperature reached the setup temperature on the remote controller)</p>
Refrigerant	Control temp. (°C)													
	A	B												
R410A	56 (54)	52 (52)												
R32	55 (53)	51 (51)												
10	Residual heat elimination	When heating operation stops, in some cases, the indoor fan operates with Low mode for approx. 30 seconds.												
11	Louver control	<p>Setting a swing operation on remote controller enables a vertical louver to start swing operation to the left and right, and its indicator to be displayed as shown in figure below.</p>  <ul style="list-style-type: none"> • In group twin, triple, or double twin operation, the louver positions can be set up collectively or individually. • Adjust air blow direction up and down manually. 												
12	HA control	<ol style="list-style-type: none"> 1) This control is connected to telecontrol system or remote start/stop I/F, etc, and start/stop are available by HA signal input from the remote position. 2) This control outputs start/stop status to HA output terminal. 3) I/O specifications conform to JEMA regulations. 	<p>HA control is used for remote start/stop. For using HA terminal (CN61), connector separately sold is required.</p> <p>In the group operation, use this control by connecting to either header or follower indoor unit.</p>											

No.	Item	Outline of specifications	Remarks
13	Test run	Refer to "8-1-1. Test Run Setup on Remote Controller"	Frequency in operation depends on connected outdoor units.
14	Filter sign display (Except wireless type)	<p>1) The indoor fan's cumulative hours of operation are counted, and when these exceed the specified hours (150H), a check icon is displayed on LCD of remote controller built in the unit. (it is not displayed on a simple display screen.) Also, a message to encourage filter cleaning is displayed on the screen when operation starts.</p> <p>2) If "7. Filter sign reset" is selected on menu screen of remote controller built in the unit while a filter check icon is displayed on it, reset function becomes available, allowing measuring cumulative hours to be cleared and the filter check icon to be erased.</p> <p>3) If "7. Filter sign reset" is selected while a filter check icon is not displayed on the screen, remaining hours to clean the filter next (Time until the specified hours) is displayed. Performing "reset" allows the elapsed time to be cleared.</p>	
15	Central control mode selection	<p>1) The range of operations that can be performed via an indoor unit remote controller can be determined through the setting of the central controller.</p> <p>2) Setting details</p> <p>[Individual] : Selection of central control mode is accessible on the built-in remote controller. ([Most recent input is given priority])</p> <p>[Central 1] : Start/stop selection is inaccessible on the built-in remote controller.</p> <p>[Central 2] : Start/stop selection, Operation mode selection, and Temperature setting are inaccessible on the built-in remote controller.</p> <p>[Central 3] : Operation mode selection and Temperature setting are inaccessible on the built-in remote controller.</p> <p>[Central 4] : Operation mode selection is inaccessible on the built-in remote controller.</p> <p>* In case of the wireless type, the display lamp does not change but the contents are same. If operating an item which is prohibited by the central control mode from the remote controller, it is notified with the receive sound, Pi, Pi, Pi, Pi, Pi (5 times).</p>	<p>No display on a remote controller</p> <p> lights</p> <p> lights</p> <p> lights</p> <p> lights</p>

No.	Item	Outline of specifications	Remarks
16	Saving operation	1) When the "Saving operation" is selected during AUTO mode or Cooling or Heating operation, "Saving operation" will be carried out. 2) The setup temperature is shifted (corrected) in the range not to lose the comfort ability according to input values of various sensors. 3) Data (Input value room temp. TA, Outside temp. TO, Fan speed, Indoor heat exchanger sensor temp. TC) for 20 minutes are taken the average to calculate correction value of the setup temperature. 4) The setup temperature is shifted every 20 minutes, and the shifted range is as follows. In cooling time: +1.5 to -1.0°C In heating time: -1.5 to +1.0°C	
17	Max. frequency cut control	1) This control is operated by selecting [AUTO] operation mode. 2) COOL operation mode: It is controlled according to the following figure if TO < 28°C.  3) HEAT operation mode: It is controlled according to the following figure if TO > 15°C. 	
18	DC motor	1) The motor operates according to the command from the indoor control. Notes) • When a fan lock is found, the air conditioner stops, and a trouble is displayed.	Check code [P12]

No.	Item	Outline of specifications	Remarks
19	Energy saving operation	<p>Perform the power saving operation of the air conditioner. Cooling / heating performance may be reduced a little because its power is saved during the Energy saving operation.</p> <ol style="list-style-type: none"> 1) Push the [ MENU] button. 2) Push the [ ^] / [ v] button to select "9. Energy saving" on the menu screen, then push the "Set" [ F2] button. 3) Push the [ ^] / [ v] button to select "1. Energy saving operation" on the "Energy saving" screen, then push the "Set" [ F2] button. 4) Push the [ ^] / [ v] button to select "2. Energy saving ratio" on the "Energy saving operation" screen, then push the "Set" [ F2] button. 5) Push the "  %+" [ F1] / "  %-" [ F2] button to set the value. <ul style="list-style-type: none"> • The Energy saving ratio can be set within the range from 50% to 100% by 1 %. The lower the value is set, the higher the power saving effect becomes. 6) Push the [ MENU] button. <ul style="list-style-type: none"> • "  Setting" appears on the screen, then the screen returns to the "Energy saving operation" screen. • "  " appears on the display when the Energy saving operation is activated. <p>* For Energy saving schedule operation, refer to the separate Owner's Manual for remote controller.</p>	

No.	Item	Outline of specifications	Remarks
20	Refrigerant detection sensor control	<p>Refrigerant detection sensor control</p> <p>1) The R32 refrigerant leak detection control functions according to refrigerant leak detection sensor mounted in the indoor unit when outdoor unit using R32 refrigerant is connected to indoor unit.</p> <p>2) If the sensor detects refrigerant leaks during operation, operation of an outdoor unit is stopped and the fan of an indoor unit operates automatically. A check code "J30" appears on the remote controller screen. Check code "J30" : Refrigerant leak detection * Do not use gas equipment or sprays such as an insecticide containing combustion gas (LPG etc.) or siloxane near the indoor unit. Doing so may cause the refrigerant leak detection sensor to mistakenly operate.</p> <p>3) Also, if the sensor detects refrigerant leak during stop, a fan of indoor unit automatically operates. " ⚠ Check" indicator flashes on the remote controller screen and if ON/OFF button is pushed, check code "J30" appears on the screen.</p> <p>4) A fan does not stop even if ON/OFF button is pushed while the fan operates due to the refrigerant leak detection (about 4 hours).</p> <p>5) Ventilation output turns to ON while the fan operates.</p> <p>6) Resetting the circuit breaker allow status of a fan operation/check code "J30" to be released and air conditioner to operate as usual. However, if highly concentrated refrigerant is detected, the fan automatically restarts (about 4 hours). Replace the refrigerant leak detection sensor to allow air conditioner to operate as usual.</p> <p>A sensor maintenance control (Operation is possible while followings are displayed.)</p> <p>1) When output of refrigerant leak detection sensor is in trouble or in open/short circuit, a check code "J29" appears on the remote controller screen during operation. A check code "J29" : The refrigerant leak detection sensor trouble (" ⚠ Check" indicator flashes during stop.)</p> <p>2) If refrigerant leak detection sensor has been used for about 7 years (life of the product), a check code "J31" appears on the remote controller screen during operation to inform users that the sensor needs replacing. Check code "J31" : Come to end of the refrigerant leak detection sensor (" ⚠ Check" indicator flashes during stop.) * If the circuit breaker is reset while the check code "J31" appears on the screen, the "J31" may turn to "J29".</p>	This refrigerant leak detection sensor control does not function when an outdoor unit using R410A is connected with indoor unit.

No.	Item	Outline of specifications	Remarks
21	8°C heating/ Frost protective operation	<p>1) Pre-heating operation can be set for cold regions where room temperature drops to below zero.</p> <p>2) This function is valid only for combination with the outdoor units.</p> <p>1 Push the [ MENU] button to display the menu screen.</p> <p>2 Push and hold the [ MENU] button and the [ V] button at the same time to display the "Field setting menu".</p> <ul style="list-style-type: none"> • Push and hold the buttons for more than 4 seconds. <p>3 Push the [ ^] / [ V] button to select "7. DN setting" on the "Field setting menu" screen, then push the "  Set" [F2] button.</p> <ul style="list-style-type: none"> • The fan and louver of the indoor unit operate. When the group control is used, the fan and louver of the selected indoor unit operate. • Move the cursor to select "Code(DN)" with the "  <" [F1] button, then set "[00D1]" with the [ ^] / [ V] button. • Move the cursor to select "Data" with the "  >" [F2] button, then set "[0001]" with the [ ^] / [ V] button. <p>4 Push the [ MENU] button to set the other Code(DN) and Data. After "Continue?" is displayed on the screen, push the "  No" [F2] button to finish the setting operation. "  Setting" appears on the screen for a while, then the screen returns to the "Field setting menu" screen.</p> <p>5 As the setup temperature is 8°C and the human heating is not targeted, the "7 Cold air discharge preventive control" is made invalid to suppress the intermittent operation.</p> <p>6 The settings of the air direction and fan speed are changeable during this operation.</p> <p>7 The indoor fan stops to protect the compressor for 2 minutes after start of heating operation (Thermostat-ON) by this function.</p>	<p>In a group connection, if there is even one combination with other unit, "No function" is displayed.</p> <p>The setup temperature jumps from [18] to [8].</p>

5-3. Indoor Print Circuit Board

<MCC-1643>

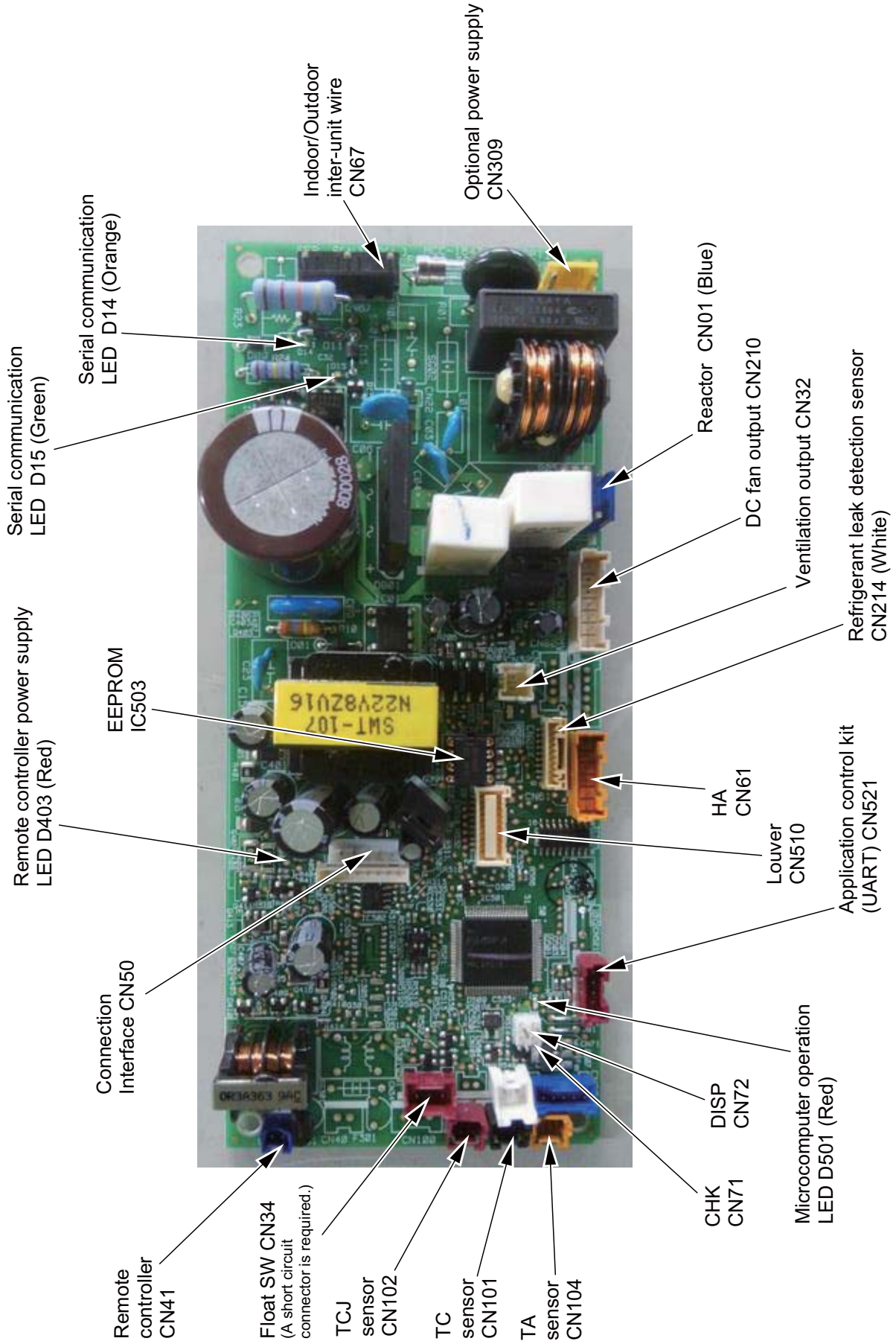

5-4. Optional connector specifications of indoor P.C. board

Function	Connector No.	Pin No.	Specifications	Remarks
Ventilation output	CN32	1	DC12V	Setting at shipment: Interlock of ON by indoor unit operation, with OFF by stop operation * The single operation setting by FAN button on the remote controller is performed on the remote controller (DN [31] = 0000 0001)
		2	Output (Open collector)	
HA	CN61	1	ON/OFF input	HA ON/OFF input (J01: YES/NO=Pulse (At shipment from factory) /Static input selection)
		2	0V	
		3	Remote controller prohibited input	Permission/Prohibition of remote controller operation stop is performed by input.
		4	Operation output (Open collector)	
		5	DC12V	Operation ON (Answer back of HA)
		6	Warning output (Open collector)	
CHK Operation check	CN71	1	0V	This check is used to check indoor operation. (Performs operation of indoor fan "H" without communication with outdoor and remote controller)
		2		
DISP Exhibition mode	CN72	1	0V	Communication is available by indoor unit and remote controller only.
		2		
Application control kit input	CN521	1	12V	Connected Application control kit (TCB-PCUC2E)
		2	5V	
		3	Transmission	
		4	Receive	
		5	0V	

* To use the functions operated by CN60, CN80, CN70 and CN73, which are provided for other models, use the Application control kit (TCB-PCUC2E) sold separately.

6. TROUBLESHOOTING

6-1. Summary of Troubleshooting

<Wired controller type>

1. Before troubleshooting

- 1) Required tools/instruments
 - ⊕ and ⊖ screwdrivers, spanners, long-nose pliers, nippers, push pins for reset switch
 - Tester, thermometer, pressure gauge, etc.
- 2) Confirmation points before check
 - a) The following operations are normal.
 1. Compressor does not operate.
 - Is the air conditioner being controlled by the 3-minute protective function?
 - Is it in standby status though the room temperature has reached the setup temperature?
 - Is it being operated in timer mode or fan mode?
 - Is the remote controller set in “heating” under the high outside air temperature?
 2. Indoor fan does not operate.
 - Is the air conditioner being controlled by the cool air discharge preventive function in “heating”?
 3. Indoor fan does not operate or fan speed changes.
 - Is the air conditioner being controlled by high-temperature release function in “heating”?
 - Is the remote controller set in “cooling” under the low outside air temperature?
 - Is the air conditioner being operated in defrost operation?
 4. ON/OFF operation cannot be performed from remote controller.
 - Is the air conditioner being operated by the central control system?
 - Is an automatic address being set up?
(When the power is turned on at the first time or when indoor unit address setting is changed, the operation cannot be performed for maximum approx. 5 minutes after power-ON.)
 - Is a test run of the air conditioner being carried out?
 - b) Did you return the cabling to the initial positions?
 - c) Are connecting wires of indoor unit and remote controller correct?

2. Troubleshooting procedure

When a trouble occurred, check the parts along with the following procedure.



NOTE :

For cause of a trouble except the items to be checked, miss diagnosis of microcomputer due to outer noise or power conditions is considered. If there is any noise source, change the wires of the remote controller to shield wires.

<Wireless remote controller type>

1. Before troubleshooting

- 1) Required tools/instruments
 - ⊕ and ⊖ screwdrivers, spanners, long-nose pliers, nippers, etc.
 - Tester, thermometer, pressure gauge, etc.
- 2) Confirmation points before check
 - a) The following operations are normal.
 1. Compressor does not operate.
 - Is the air conditioner being controlled by the 3-minute protective function?
 - Is it in standby status though the room temperature has reached the setup temperature?
 - Is it being operated in timer mode or fan mode?
 - Is the remote controller set in “heating” under the high outside air temperature?
 2. Indoor fan does not operate.
 - Is the air conditioner being controlled by the cool air discharge preventive function in “heating”?
 3. Indoor fan does not operate or fan speed changes.
 - Is the air conditioner being controlled by high-temperature release function in “heating”?
 - Is the remote controller set in “cooling” under the low outside air temperature?
 - Is the air conditioner being operated in defrost operation?
 4. ON/OFF operation cannot be performed from remote controller.
 - Is the air conditioner being operated by the central control system?
 - Is it being in forced operation?
 - Is an automatic address being set up?
(When the power is turned on at the first time or when indoor unit address setting is changed, the operation cannot be performed for maximum approx. 5 minutes after power-ON.)
 - Is a test run of the air conditioner being carried out?
 - b) Did you return the cabling to the initial positions?
 - c) Are connecting wires between indoor unit and receiving unit correct?

2. Troubleshooting procedure

When a trouble occurred, check the parts along with the following procedure.



6-2. Troubleshooting







6-2-1. Outline of judgment

The primary judgment to check whether a trouble occurred in the indoor unit or outdoor unit is carried out with the following method.



Method to judge the troubled position by flashing indication on the display part of the indoor unit (sensors of the receiving part)

The indoor unit monitors the operating status of the air conditioner, and the blocked contents of self-diagnosis are displayed restricted to the following cases if a protective circuit works.

● : Go off, ○ : Go on,  : Flash (0.5 sec.)

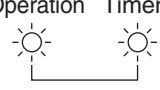
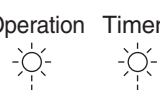
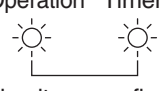
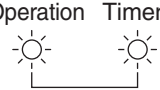
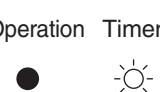
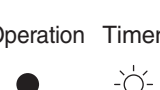

Lamp indication	Check code	Cause of trouble occurrence
Operation Timer Ready ● ● ● No indication at all	—	Power supply OFF or miswiring between receiving unit and indoor unit
Operation Timer Ready  ● ● Flash	E01	Receiving unit trouble
	E03	Communication stop
	E08	Duplicated indoor unit No.
	E09	Duplicated header units of remote controller
	E11	Communication trouble between Application control kit and indoor unit P.C. board
	E18	Wire connection trouble between indoor units, Indoor power OFF (Communication stop between indoor header and follower or between main and sub indoor twin)
Operation Timer Ready ● ●  Flash	E04	Miswiring between indoor unit and outdoor unit or connection trouble (Communication stop between indoor and outdoor units)
Operation Timer Ready ●   Alternate flash	P10	Short-circuit connector not connected
	P12	Indoor DC fan trouble
Operation Timer Ready  ●  Alternate flash	P03	Outdoor unit discharge temp. trouble
	P04	Outdoor high pressure system trouble
	P05	Negative phase detection trouble
	P07	Heat sink overheat trouble
	P15	Gas leak detection trouble
	P19	4-way valve system trouble (Indoor or outdoor unit judged.)
	P20	Outdoor unit high pressure protection
	P22	Outdoor unit: Outdoor unit trouble
	P26	Outdoor unit: Inverter Idc operation
	P29	Outdoor unit: Position detection trouble
	P31	Stopped because of trouble of other indoor unit in a group (Check codes of E03/L03/L07/L08)

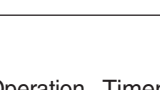
*1: These are representative examples and the check code differs according to the outdoor unit to be combined.

Lamp indication	Check code	Cause of trouble occurrence
Operation Timer Ready  Alternate flash	F01	Heat exchanger sensor (TCJ) trouble Heat exchanger sensor (TC) trouble Room temperature sensor (TA) trouble } Indoor unit sensor trouble
	F02	
	F10	
Operation Timer Ready  Alternate flash	F04	Discharge temp. sensor (TD) trouble Temp. sensor (TE) trouble Temp. sensor (TL) trouble Temp. sensor (TO) trouble Temp. sensor (TS) trouble Temp. sensor (TH) trouble Temp. Sensor miswiring (TE, TS) } Sensor trouble of outdoor unit *1
	F06	
	F07	
	F08	
	F12	
	F13	
	F15	
Operation Timer Ready  Simultaneous flash	F29	Indoor EEPROM trouble
Operation Timer Ready  Simultaneous flash	F31	Outdoor EEPROM trouble
Operation Timer Ready  Flash	H01	Compressor break down Compressor lock Current detection circuit trouble Case thermostat worked. Outdoor unit low pressure system trouble } Outdoor compressor system trouble *1
	H02	
	H03	
	H04	
	H06	
Operation Timer Ready  Flash	J29	The refrigerant leak detection sensor trouble
	J30	Refrigerant leak detection
	J31	Come to the end of refrigerant leak detection sensor life
Operation Timer Ready  Simultaneous flash	L03	Duplicated header indoor units There is indoor unit of group connection in individual indoor unit. Unsetting of group address Missed setting (Unset indoor capacity) } → AUTO address * If group construction and address are not normal when power supply turned on, automatically goes to address setup mode.
	L07	
	L08	
	L09	
Operation Timer Ready  Simultaneous flash	L10	Unset model type (Service board) Duplicated indoor central addresses Outdoor unit and other trouble Outside interlock trouble Negative phase trouble } Others
	L20	
	L29	
	L30	
	L31	

*1: These are representative examples and the check code differs according to the outdoor unit to be combined.

6-2-2. Others (Other than Check Code)

Lamp indication	Check code	Cause of trouble occurrence
Operation Timer Ready  Simultaneous flash	—	During test run
Operation Timer Ready  Alternate flash	—	Disagreement of cool/heat (Automatic cool/heat setting to automatic cool/heat prohibited model, or setting of heating to cooling-only model)

2. Troubleshooting procedure on the check display of remote controller

Confirmation and check

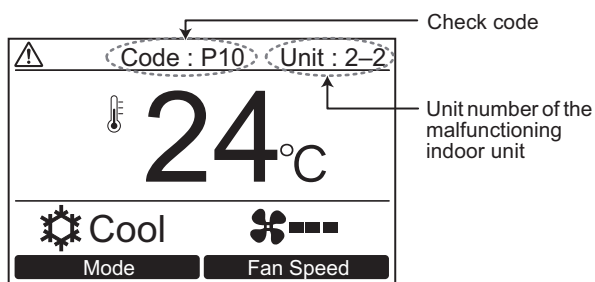

When a trouble has occurred in the air conditioner, the check code and the unit number of the indoor unit appear on the display of the remote controller.

* The check code appears only while the unit is running.

Push the [MONITOR] button or [CANCEL] button to display the check information screen.

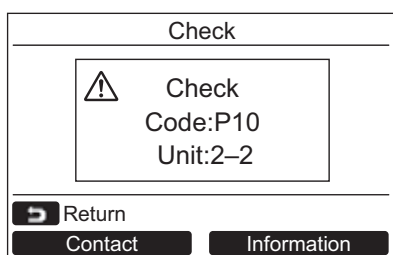

While the check information screen appears:

Push the " Contact" [F1] button to display the contact number for service.

Push the " Information" [F2] button to display the model name and serial number of the unit.

Confirming an alarm history

Ten check codes in the past, troubled unit, and date when trouble occurred are displayed on "Alarm history" screen.

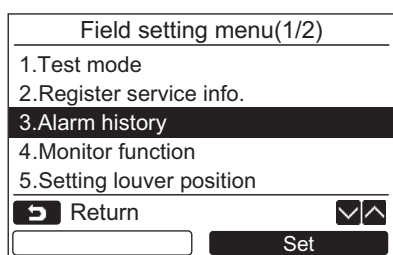

1 Push the [^] / [v] button to select "3. Alarm history" on the "Field setting menu" screen, then push the " Set" [F2] button.

List of latest 10 alarm data is displayed.

* The oldest data are deleted in order to record the new ones.

→ The date and time when the check code occurred for the first time is displayed for the repeated alarm.

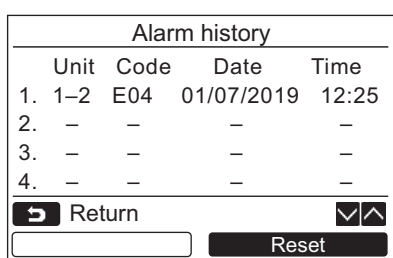

Deleting the alarm history

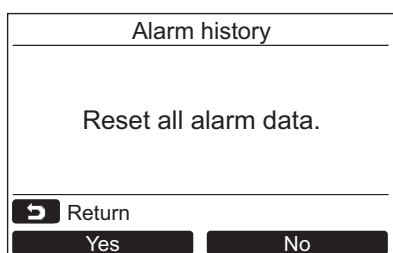

1 Push the " Reset" [F2] button while the list of Alarm history is displayed.

2 Push the " Yes" [F1] button after the confirmation screen is displayed.

→ Delete the Alarm history in each remote controller when the dual remote controller system is used.

6-2-3. Check Code List (Indoor)

(Indoor unit detected) ○ : Go on, ◎ : Flash, ● : Go off ALT (Alternate): Alternate flashing when there are two flashing LED SIM (Simultaneous): Simultaneous flashing when there are two flashing LED

Check code indication TCC-LINK central & Wired remote controller	Lamp indication			Representative trouble position	Explanation of trouble contents	Air conditioner operation	
	Block indication Operation	Timer	Ready			Automatic reset	Operation continuation
E03	◎	●	●	Regular communication trouble between indoor and remote controller	No communication from remote controller and network adapter (Also no communication from central control system)	✓	—
E04	◎	●	◎	Indoor/outdoor serial trouble	There is trouble on serial communication between indoor and outdoor units	✓	—
E08	◎	●	●	Duplicated indoor addresses	Same address as yours was detected.	✓	—
E11	◎	●	●	Communication trouble between Application control kit and indoor unit	Communication trouble between indoor and outdoor units	✓	—
E18	◎	●	●	Regular communication trouble between indoor header and follower units	Regular communication between indoor header and follower units is impossible. Communication between twin header (main) and follower (sub) units is impossible.	✓	—
F01	◎	◎	●	Indoor unit, Heat exchanger (TC _J) trouble	Open/short-circuit was detected on heat exchanger (TC _J).	✓	—
F02	◎	◎	●	Indoor unit, Heat exchanger (TC) trouble	Open/short-circuit was detected on heat exchanger (TC).	✓	—
F10	◎	◎	●	Indoor unit, Room temp. sensor (TA) trouble	Open/short-circuit was detected on room temp. sensor (TA).	✓	—
F29	◎	◎	●	Indoor unit, other indoor P.C. board trouble	EEPROM trouble (Other trouble may be detected. If no trouble, automatic address is repeated.)	—	—
J29	◎	◎	◎	Refrigerant leak detection sensor trouble	A trouble or open-short circuit was detected by output of refrigerant leak detection sensor.	—	✓
J30	◎	◎	◎	Refrigerant leak detection	Refrigerant leak was detected by refrigerant leak detection sensor.	—	—
J31	◎	◎	◎	Come to the end of refrigerant leak detection sensor life	In case of refrigerant leak detection sensor exceeding its life of the product.	—	✓
L03	◎	◎	◎	Duplicated setting of indoor group header unit	There are multiple header units in a group.	—	—
L07	◎	◎	◎	There are group wires in individual indoor unit.	When even one group connection indoor unit exists in individual indoor unit.	—	—
L08	◎	◎	◎	Unset indoor group address	Indoor group address is unset.	—	—
L09	◎	◎	◎	Unset indoor capacity	Capacity of indoor unit is unset.	—	—
L30	◎	◎	◎	Outside trouble input to indoor unit (Interlock)	Abnormal stop by outside trouble (CN80) input	—	—
P10	◎	◎	◎	Indoor unit, short-circuit connector trouble	Short-circuit connector not connected.	—	—
P12	◎	◎	◎	Indoor unit, DC fan trouble	Indoor DC fan trouble (Over-current/Lock, etc.) was detected.	—	—
P19	◎	◎	◎	4-way valve system trouble	In heating operation, a trouble was detected by temp. down of indoor heat exchanger sensor.	✓	—
P31	◎	◎	◎	Other indoor unit trouble	Follower unit in group cannot operate by warning from [E03/L03/L07/L08] of header unit.	✓	—

◇ When this warning was detected before group construction/address check finish at power supply was turned on, the mode shifts automatically to AUTO address setup mode.

(Remote controller detected)

Check code indication Wired remote controller	Lamp indication			Representative trouble position	Explanation of trouble contents	Air conditioner operation	
	Block indication Operation	Timer	Ready			Automatic reset	Operation continuation
E01	◎	●	●	No master remote controller. Remote controller communication (Receive) trouble	Signal cannot be received from indoor unit. Master remote controller was not set. (Including 2 remote controllers)	—	—
E09	◎	●	●	Duplicated master remote controller	In 2-remote controller control, both were set as master. (Indoor master unit stops warning and follower unit continues operation.)	—	△

△ : It is based on a situation.

(Central control devices detected)

Check code indication TCC-LINK central	Lamp indication			Representative trouble position	Explanation of trouble contents	Air conditioner operation	
	Block indication Operation	Timer	Ready			Automatic reset	Operation continuation
C05	—	—	—	Central control system communication (send) trouble	Signal sending operation of central control system is impossible.	—	—
C06	—	—	—	Central control system communication (receive) trouble	Signal receiving operation of central control system is impossible.	—	—
C12	—	—	—	General-purpose device control interface batched warning	An trouble on device connected to general-purpose device control interface of exclusive to TCC-LINK	—	—
L20	◎	○	◎	Duplicated central control system address	Duplicated setting of central control system address	✓	—
P30	◎	○	◎	Group follower unit is trouble. (Above-mentioned)	Group follower unit is trouble. (For remote controller, above-mentioned [***] details are displayed with unit No.)	—	—

NOTE: Even for the same contents of trouble such as communication trouble, the display of check code may differ according to detection device. When wired remote controller or central controller detects a trouble, it is not necessarily related to operation of the air conditioner. In this list, the check codes that outdoor unit detects are not described.

Trouble mode detected by indoor unit

Operation of diagnostic function				Judgment and measures
Check code	Cause of operation	Status of air conditioner	Condition	
E03	No communication from remote controller (including wireless) and communication adapter	Stop (Automatic reset)	Displayed when trouble is detected	1. Check wires of remote controller and communication adapters. • Remote controller LCD display OFF (Disconnection) • Central remote controller [97] check code
E04	The serial signal is not output from outdoor unit to indoor unit. • Miswiring of inter-unit wire • Serial communication circuit trouble of outdoor P.C. board. • Serial communication circuit trouble of indoor P.C. board.	Stop (Automatic reset)	Displayed when trouble is detected	1. Outdoor unit does not completely operate. • Inter-unit wire check, correction of miswiring • Check outdoor P.C. board. Correct wiring of P.C. board. 2. When outdoor unit normally operates • Check P.C. board (Indoor receiving / Outdoor sending).
E11	Communication trouble between indoor unit and option P.C. board	Stop (Automatic reset)	Displayed when trouble is detected	1. Check wire harness for power supply/communication. 2. Check P.C. board in indoor unit.
E18	Regular communication trouble between header and follower units, or master and sub remote controllers	Stop (Automatic reset)	Displayed when trouble is detected	1. Check remote controller wiring. 2. Check indoor power supply wiring. 3. Check indoor P.C. board.
J29	Refrigerant leak detection sensor trouble	Operation continued	Displayed when trouble is detected	1. Check connector part and appearance on the refrigerant leak detection sensor and replace the sensor if there is no trouble. 2. Check P.C. board in indoor unit.
J30	Refrigerant leak detection	Entire stop	Displayed when trouble is detected	1. Reset the circuit breaker after repairing the leak part when refrigerant gas leaks. 2. Stop using the gas equipment or the sprays near the units and ventilate the room before resetting the circuit breaker. * After treating 1, 2 above, replace the refrigerant leak detection sensor if the unit does not return to normal state. 3. Check P.C. board in indoor unit.
J31	Come to the end of refrigerant leak detection sensor life	Operation continued	Displayed when trouble is detected	1. Replace refrigerant leak detection sensor. 2. Check P.C. board in indoor unit.
E08	Duplicated indoor unit address	Stop	Displayed when trouble is detected	1. Check whether remote controller connection (Group/Individual) was changed or not after power supply turned on (Finish of group construction/Address check). * If group construction and address are not normal when the power has been turned on, the mode automatically shifts to address setup mode. (Resetting of address)
L03	Duplicated indoor header unit			
L07	There is group wire in individual indoor unit.			
L08	Unset indoor group address			
L09	Unset indoor capacity	Stop	Displayed when trouble is detected	1. Set indoor capacity (DN=11)
L30	Abnormal input of outside interlock	Stop	Displayed when trouble is detected	1. Check outside devices. 2. Check indoor P.C. board.
P10	Short-circuit connector trouble	Stop	Displayed when trouble is detected	1. Check connection of CN34 short-circuit connector. 2. Check indoor P.C. board.
P12	Indoor DC fan trouble	Stop	Displayed when trouble is detected	1. Position detection trouble 2. Check fan motor (Protective circuit operation). 3. Indoor fan locked. 4. Check indoor P.C. board.
P19	4-way valve system trouble • After heating operation has started, indoor heat exchangers temp. is down.	Stop (Automatic reset)	Displayed when trouble is detected	1. Check 4-way valve. 2. Check 2-way valve and check valve. 3. Check indoor heat exchanger (TC/TCJ). 4. Check indoor P.C. board.
P31	Own unit stops while warning is output to other indoor units.	Stop (Follower unit) (Automatic reset)	Displayed when trouble is detected	1. Judge follower unit while header unit is [E03], [L03], [L07] or [L08]. 2. Check indoor P.C. board.
F01	Coming-off, disconnection or short-circuit of indoor heat exchanger temp. sensor (TCJ)	Stop (Automatic reset)	Displayed when trouble is detected	1. Check indoor heat exchanger temp. sensor (TCJ). 2. Check indoor P.C. board.
F02	Coming-off, disconnection or short-circuit of indoor heat exchanger temp. sensor (TC)	Stop (Automatic reset)	Displayed when trouble is detected	1. Check indoor heat exchanger temp. sensor (TC). 2. Check indoor P.C. board.
F10	Coming-off, disconnection or short-circuit of indoor room temperature sensor (TA)	Stop (Automatic reset)	Displayed when trouble is detected	1. Check indoor room temperature sensor (TA). 2. Check indoor P.C. board.
F29	Indoor EEPROM trouble • EEPROM access trouble	Stop (Automatic reset)	Displayed when trouble is detected	1. Check indoor EEPROM. (including socket insertion) 2. Check indoor P.C. board.

Trouble mode detected by remote controller or central controller (TCC-LINK)

Operation of diagnostic function				Judgment and measures
Check code	Cause of operation	Status of air conditioner	Condition	
Not displayed at all (Operation on remote controller is impossible.)	No communication with header indoor unit <ul style="list-style-type: none"> Remote controller wiring is not correct. Power of indoor unit is not turned on. Automatic address cannot be completed. 	Stop	—	Power supply trouble of remote controller, Indoor EEPROM trouble <ol style="list-style-type: none"> Check remote controller inter-unit wiring. Check remote controller. Check indoor power wiring. Check indoor P.C. board. Check indoor EEPROM. (including socket insertion) → Automatic address repeating phenomenon generates.
E01 *1	No communication with header indoor unit <ul style="list-style-type: none"> Disconnection of inter-unit wire between remote controller and header indoor unit (Detected by remote controller side) 	Stop (Automatic reset) * If central controller exists, operation continues.	Displayed when trouble is detected	Receiving trouble from remote controller <ol style="list-style-type: none"> Check remote controller inter-unit wiring. Check remote controller. Check indoor power wiring. Check indoor P.C. board.
E09	There are multiple main remote controllers. (Detected by remote controller side)	Stop (Follower unit continues operation.)	Displayed when trouble is detected	<ol style="list-style-type: none"> In 2-remote controllers (including wireless), there are multiple header units. Check that there are 1 main remote controller and other sub remote controllers.
L20 Central controller L20	Duplicated indoor central addresses on communication of central control system (Detected by indoor/central controller side)	Stop (Automatic reset)	Displayed when trouble is detected	<ol style="list-style-type: none"> Check setting of central control system network address. (Network adapter) Check network adapter P.C. board.
— *2 Central controller (Send) C05 (Receive) C06	Communication circuit trouble of central controller (Detected by central controller side)	Continues (By remote controller)	Displayed when trouble is detected	<ol style="list-style-type: none"> Check communication wire / miswiring Check communication (U3, U4 terminals) Check network adapter P.C. board. Check central controller (such as central control remote controller, etc.) Check terminal resistance. (TCC-LINK)
— Central controller P30	Indoor Gr sub unit trouble (Detected by central controller side)	Continuation/Stop (According to each case)	Displayed when trouble is detected	Check the check code of the corresponding unit from remote controller.

Network adapter : "1 : 1 Model" Connection Interface (TCB-PCNT30TLE2)

*1 The check code cannot be displayed by the wired remote controller.

(Usual operation of air conditioner becomes unavailable.)

For the wireless models, a trouble is notified with indication lamp.

*2 This trouble is related to communication of remote controller (A, B), central system (TCC-LINK U3, U4), and [E01], [E03], [E09] or [E18] is displayed or no check display on the wired remote controller according to the contents.

6-2-4. Diagnostic Procedure for Each Check Code (Indoor Unit)

Check code

[E01 trouble]

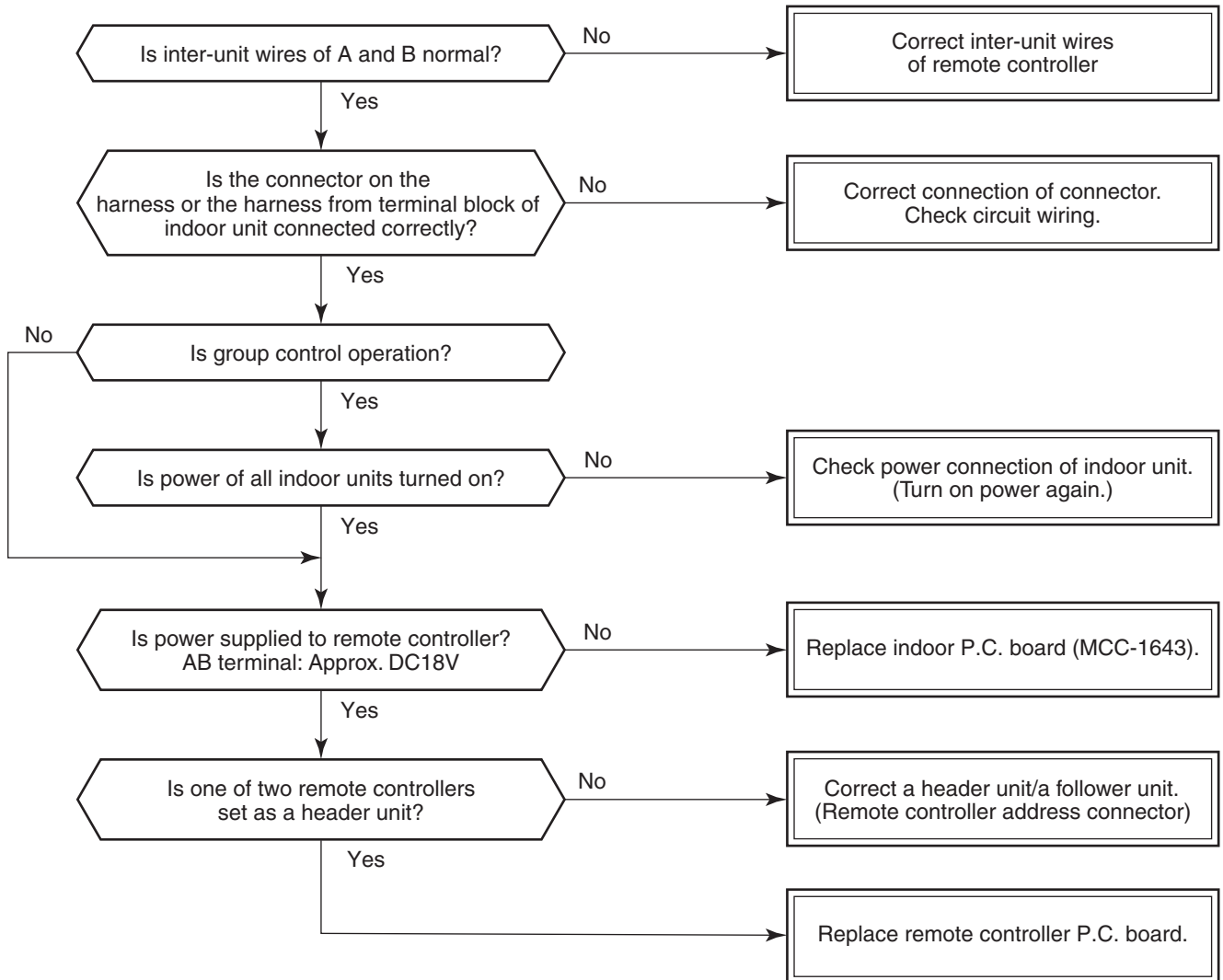

[E09 trouble]

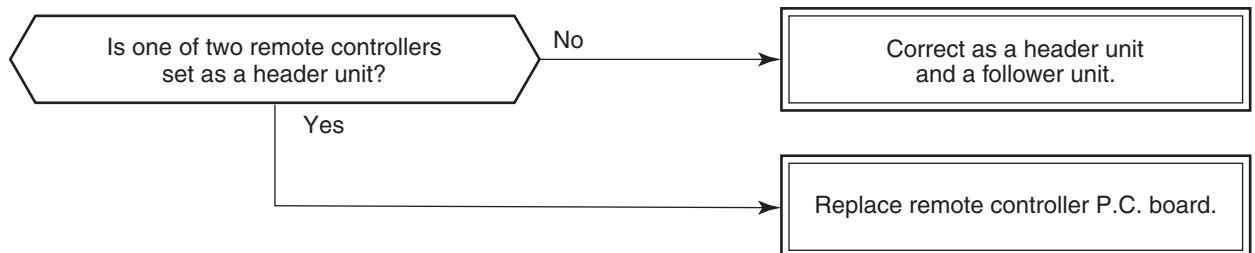

[E04 trouble]

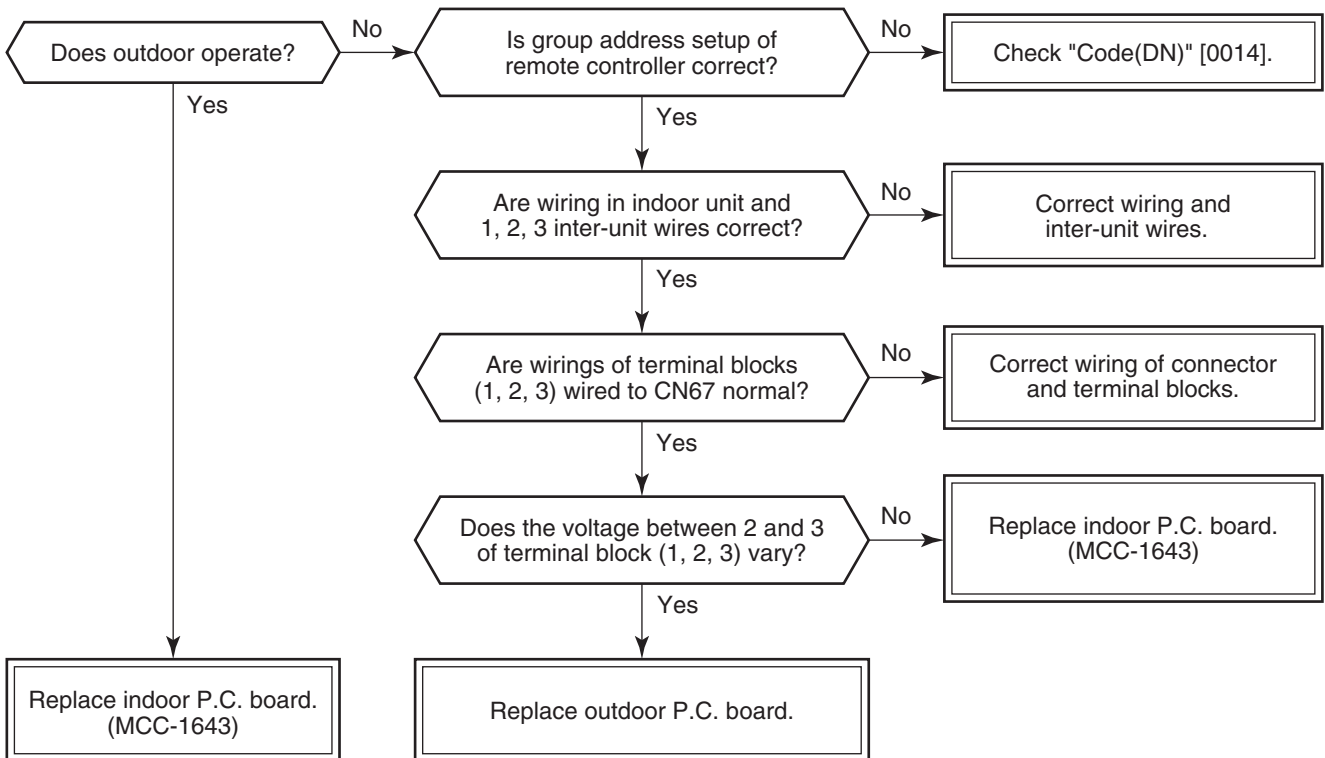

As shown in the following figure, carry out measurement within 20 seconds after the power was turned on.

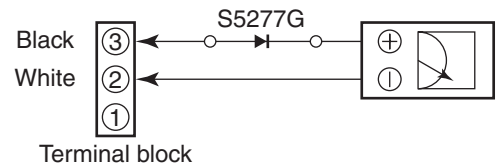

[E11 trouble]

Option parts : Application control kit (TCB-PCUC2E)

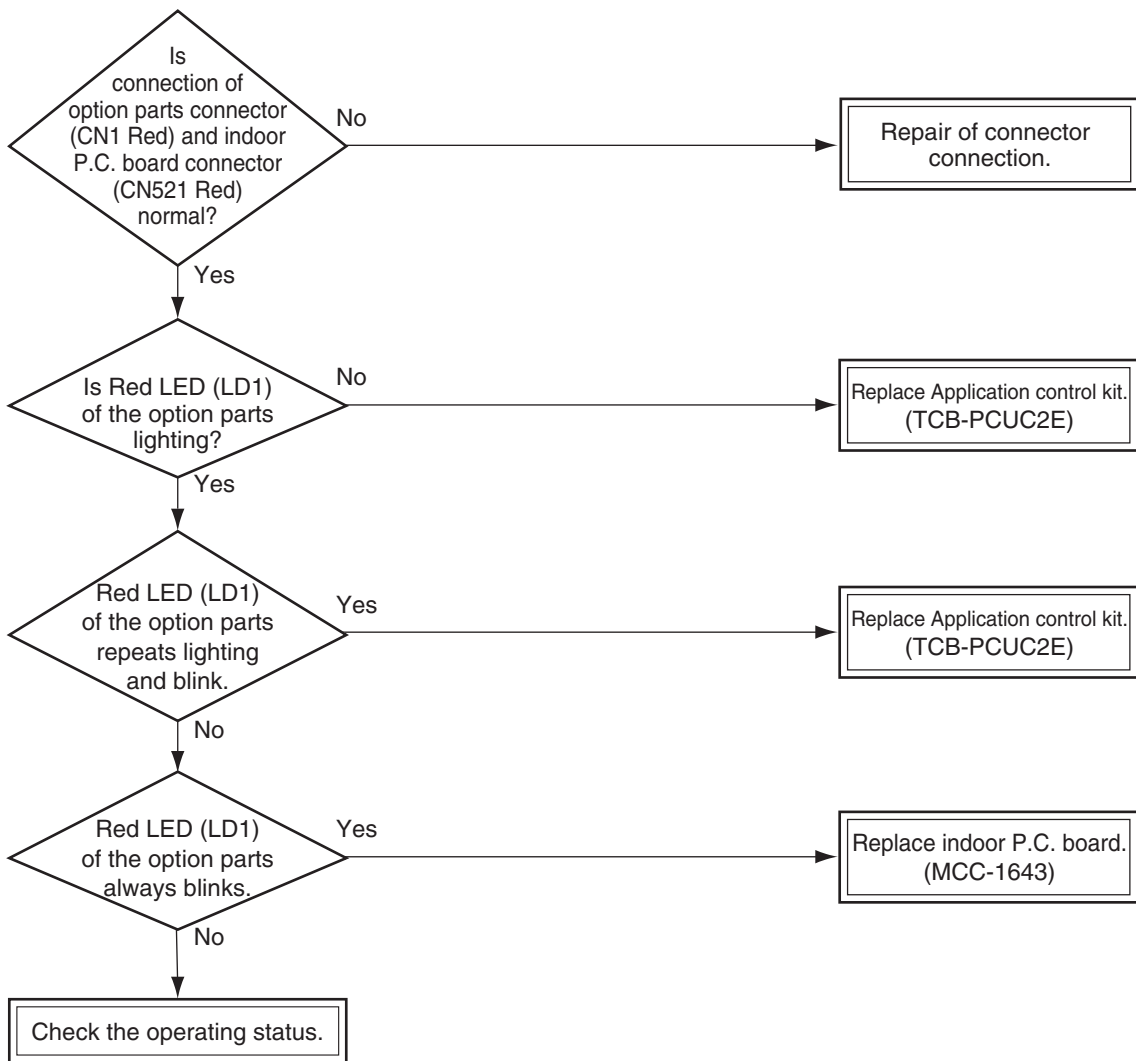

[E18 trouble]

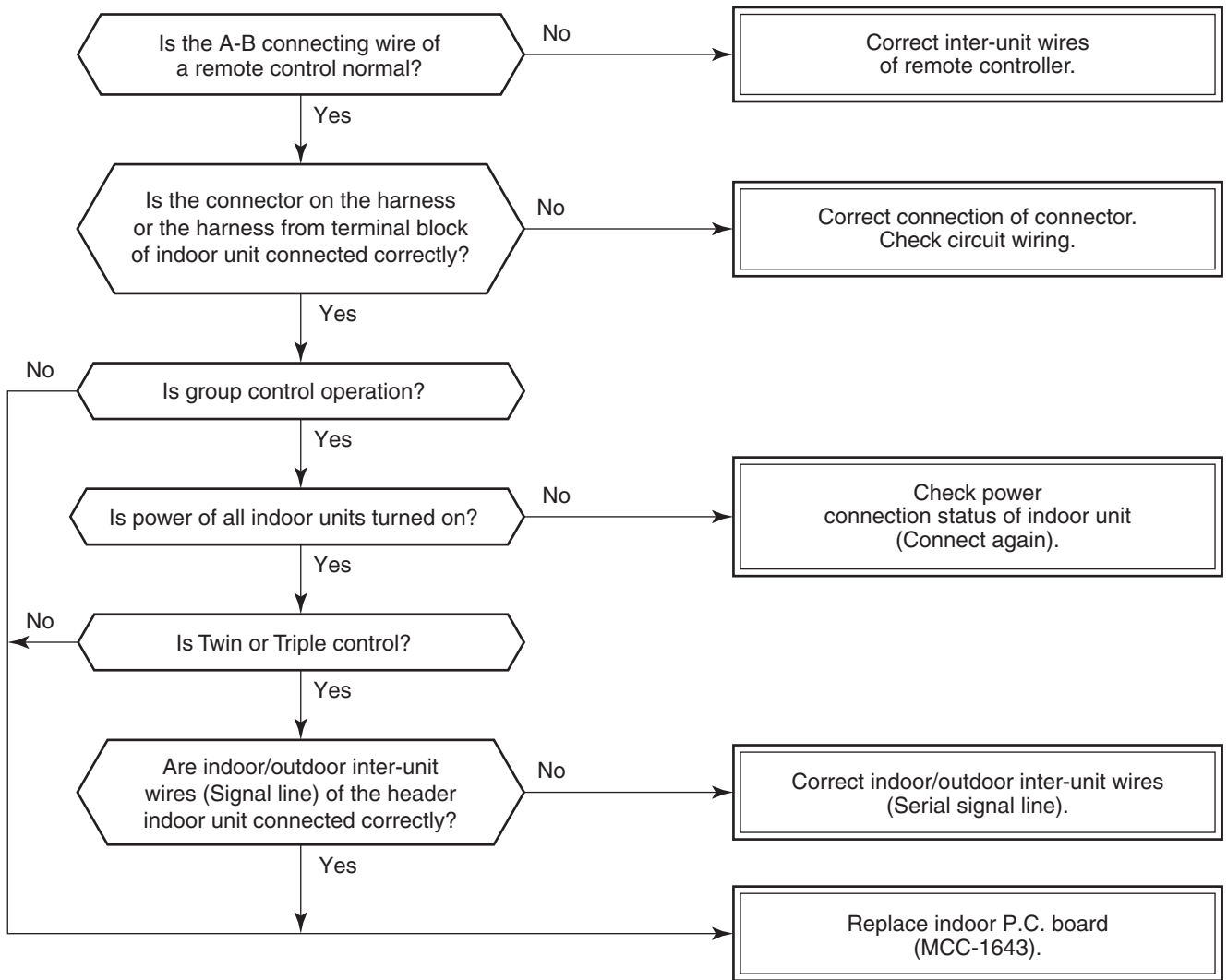

[E08, L03, L07, L08 trouble]

E08: Duplicated indoor unit No.

L03: There are 2 or more header units in a group control.

L07: There is 1 or more group address [Individual] in a group control.

L08: The indoor group address is unset. (In case "Code (DN)" [0014] is "Data" [0099])

If the above trouble is detected when power supply turned on, the mode enters automatically in the automatic address set mode. (Check code is not output.)

However, if the above trouble is detected during the automatic address set mode, a check code may be output.

[L09 trouble]

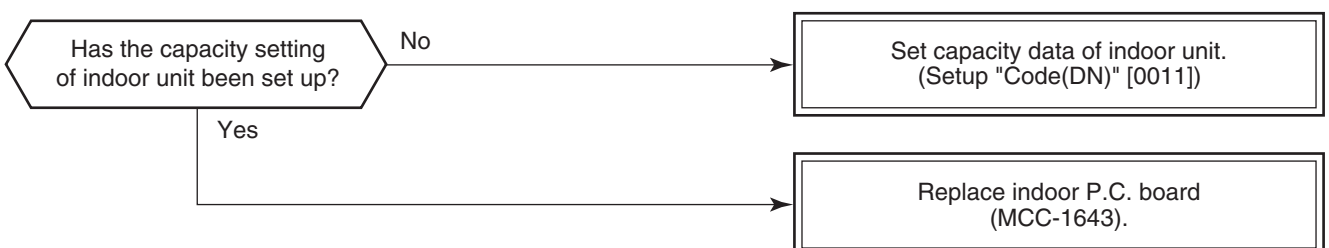

[J29 trouble]

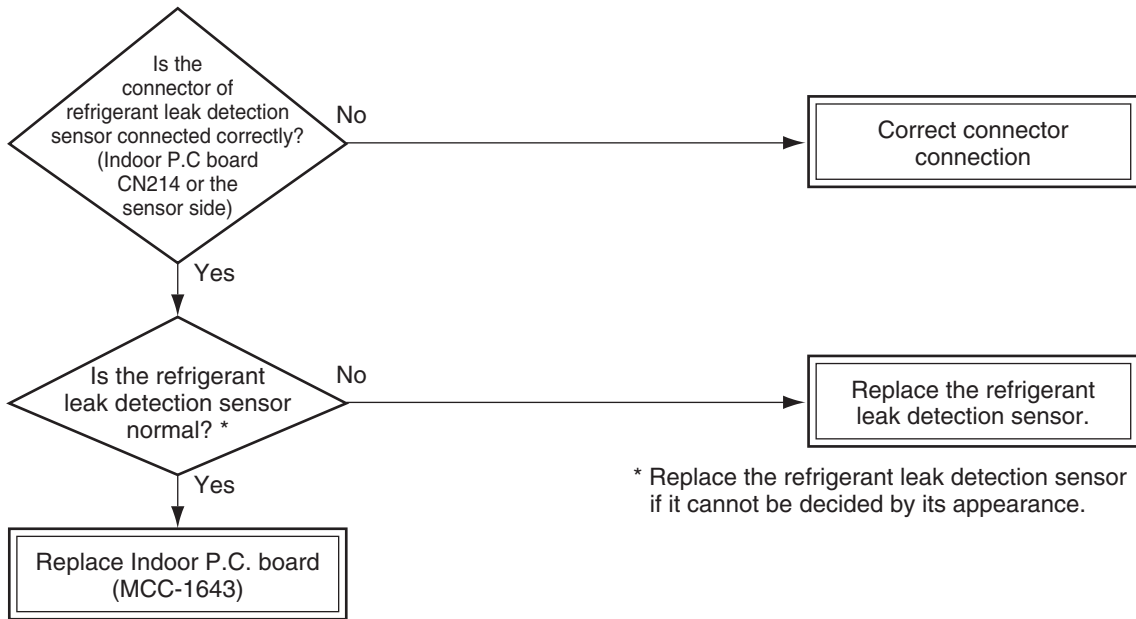

[J31 trouble]

Replace the refrigerant leak detection sensor due to exceeding its life of the product.

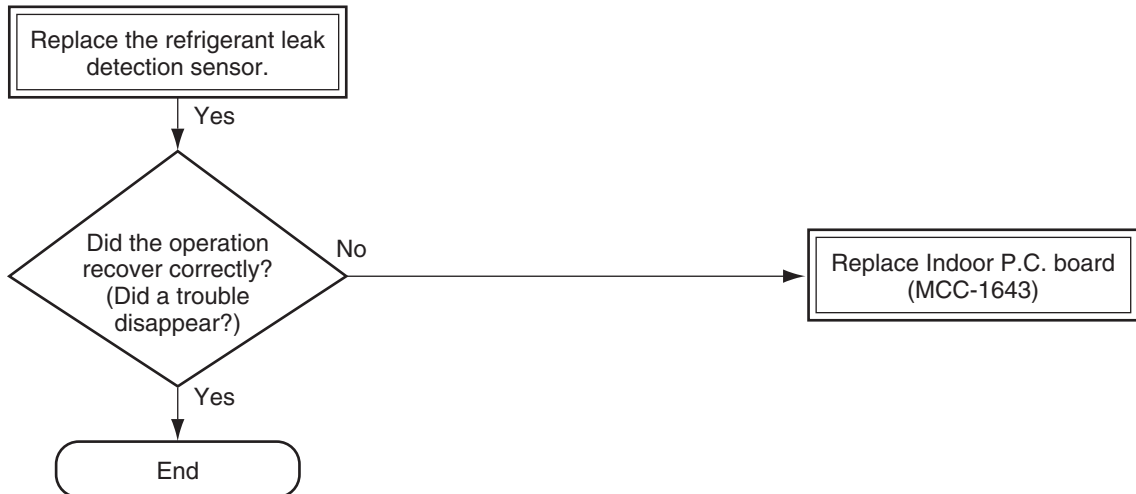

[J30 trouble]

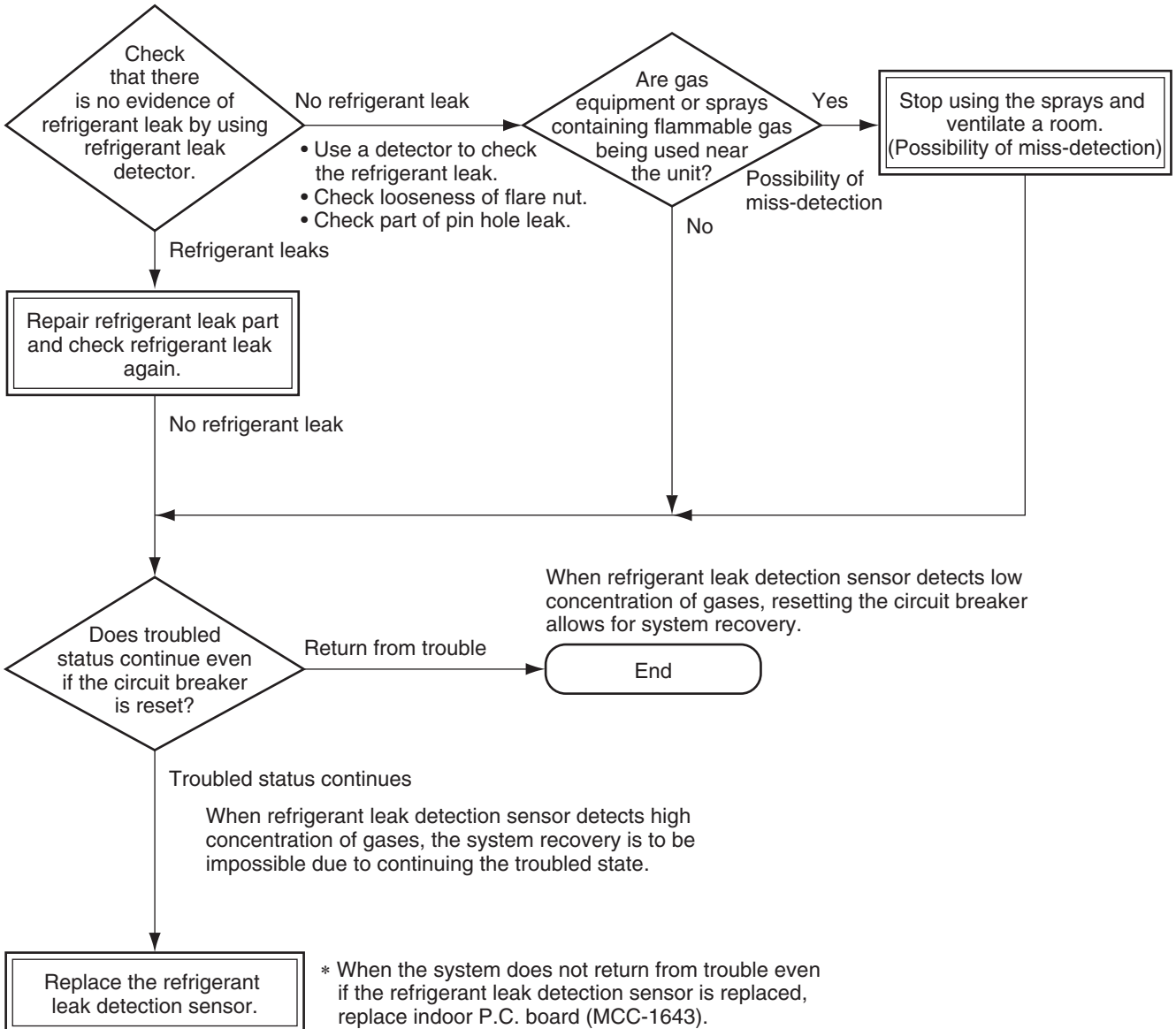

[L20 trouble]

Network adapter : "1 : 1 Model" Connection Interface (TCB-PCNT30TLE2)

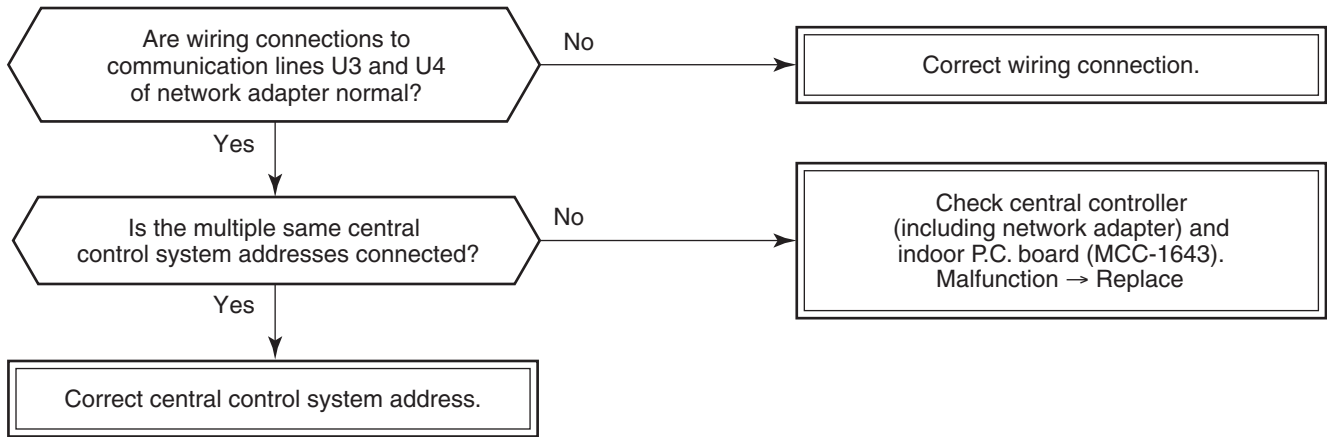

[L30 trouble]

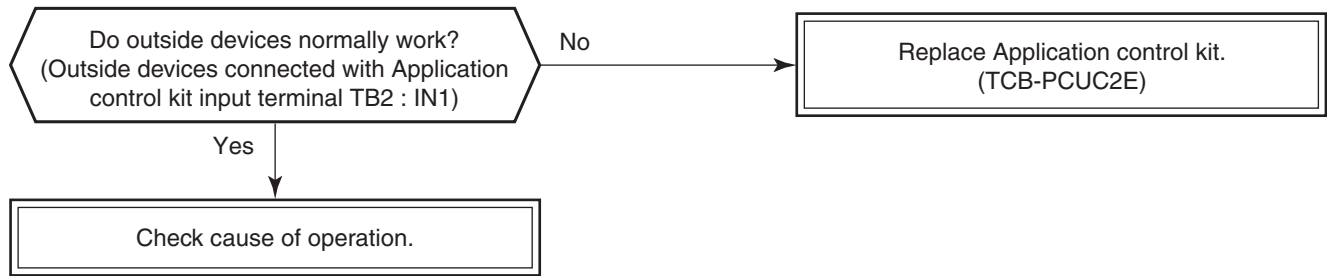

[P30 trouble] (Central controller)

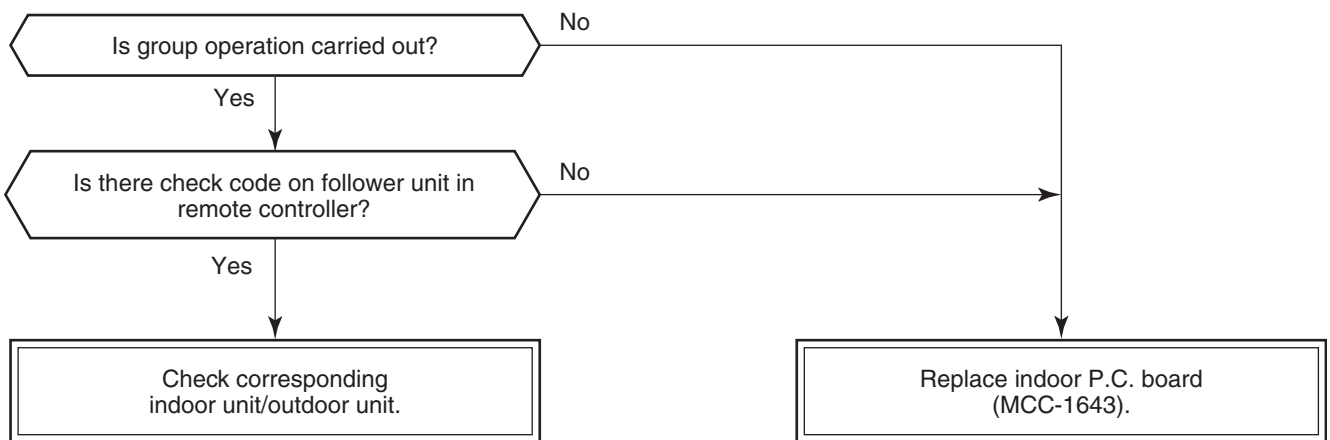

[P10 trouble]



[F10 trouble]

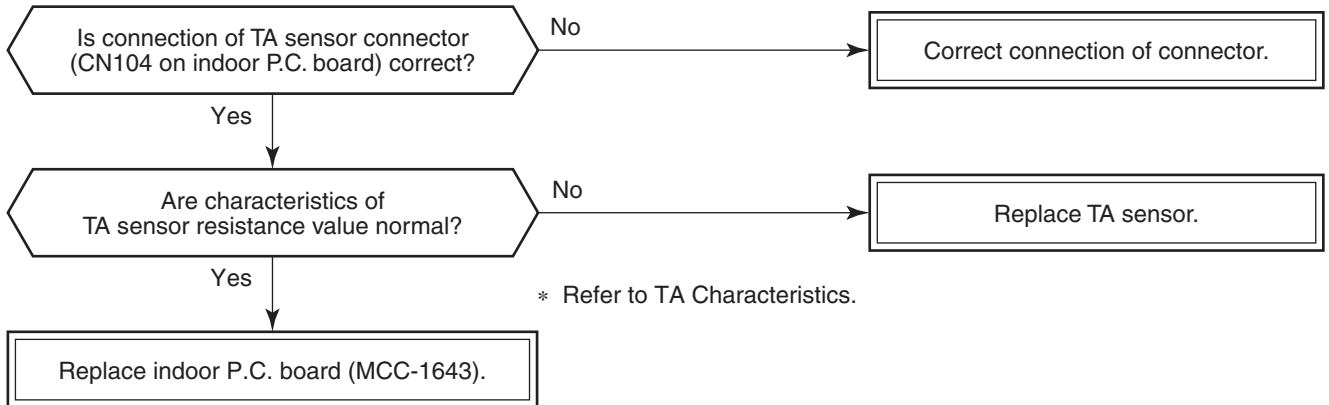

[P12 trouble]

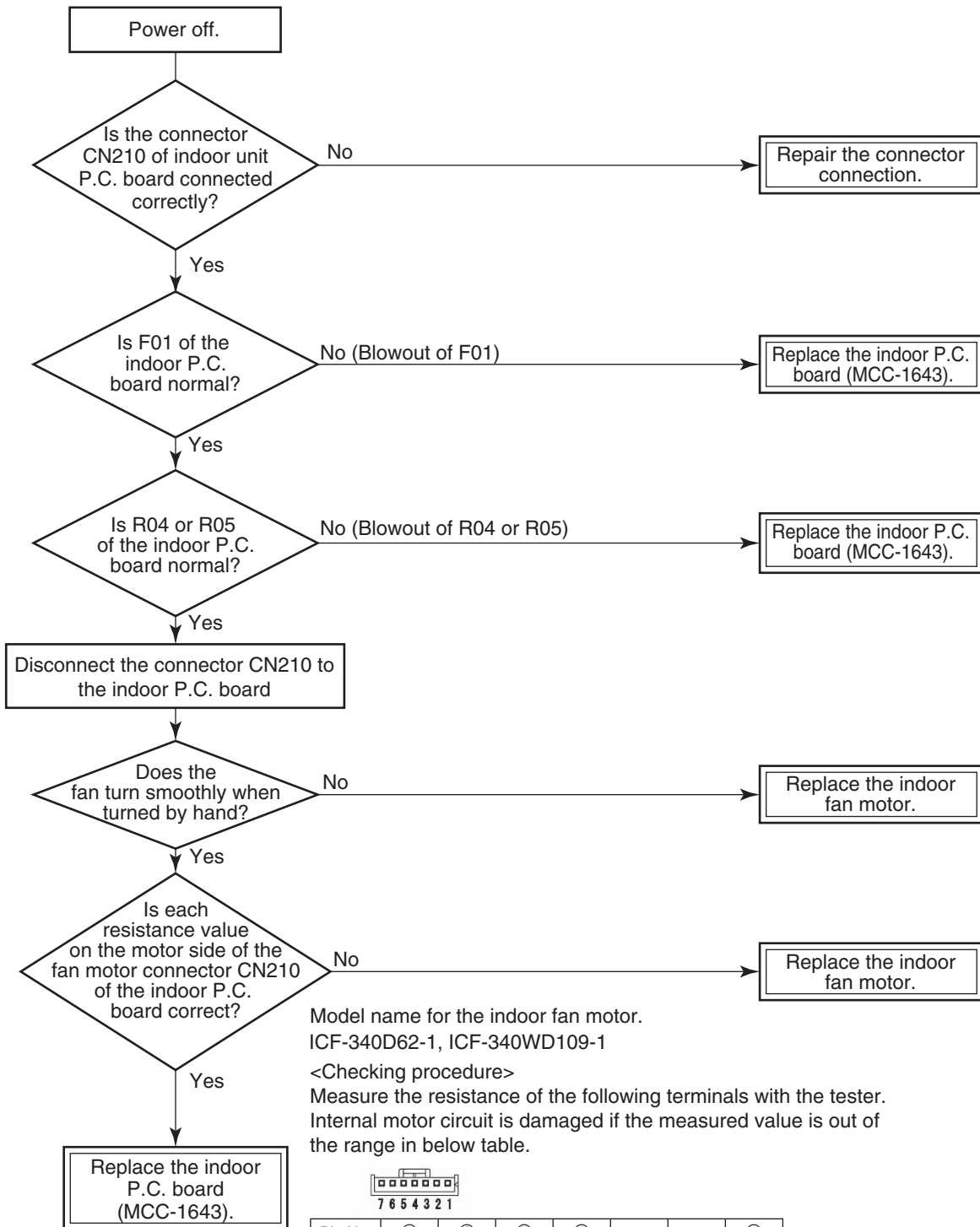

Model name for the indoor fan motor.
ICF-340D62-1, ICF-340WD109-1

<Checking procedure>

Measure the resistance of the following terminals with the tester.
Internal motor circuit is damaged if the measured value is out of the range in below table.

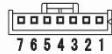

Pin No.	⑦	⑥	⑤	④	3	2	①
Color	Blue	Yellow	White	Black	-	-	Red

* Measure by connecting the common side to ④ (Black) while measuring.
The measurement may vary.

	Measurement place	Resistance value
I.	Between ④ (Black) - ① (Red)	∞ (M Ω)
II.	Between ④ (Black) - ⑤ (White)	35k – 65k Ω
III.	Between ④ (Black) - ⑥ (Yellow)	130k – 170k Ω
IV.	Between ④ (Black) - ⑦ (Blue)	∞ (M Ω)

[Action if the measurement is out of the range]

If any measurement in the above table is between 0 to several 100 Ω , replace the indoor P.C. board together with the motor since the indoor P.C. board is damaged.

[P19 trouble]

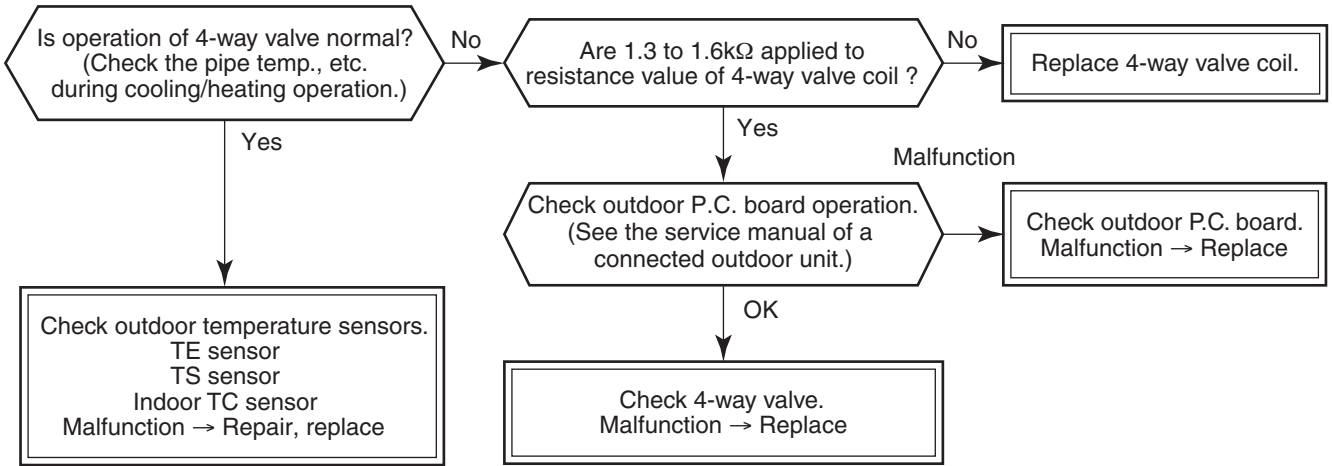

[F02 trouble]

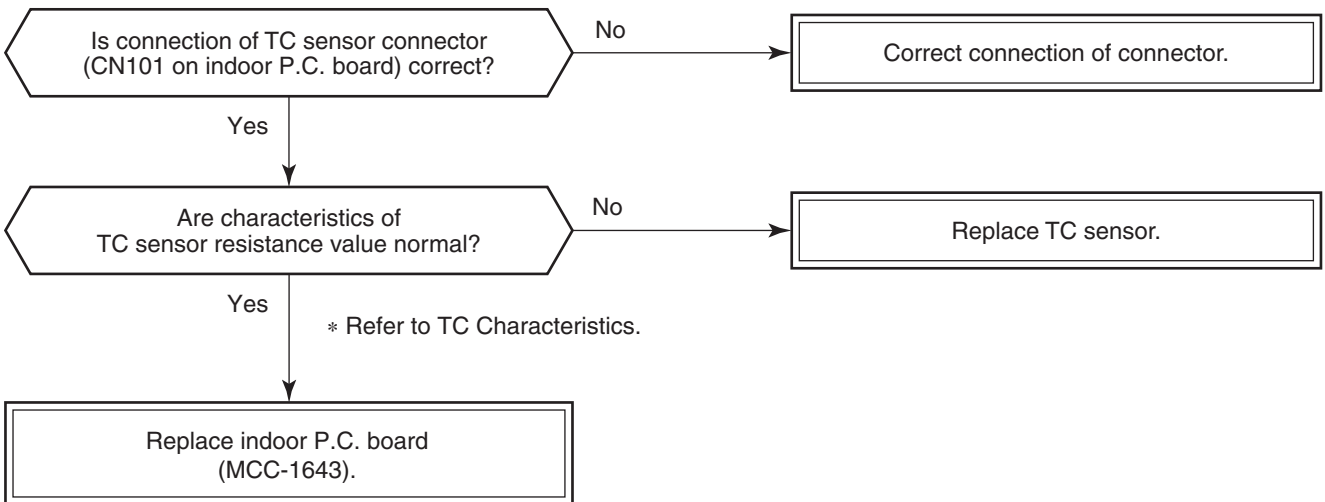

[F01 trouble]

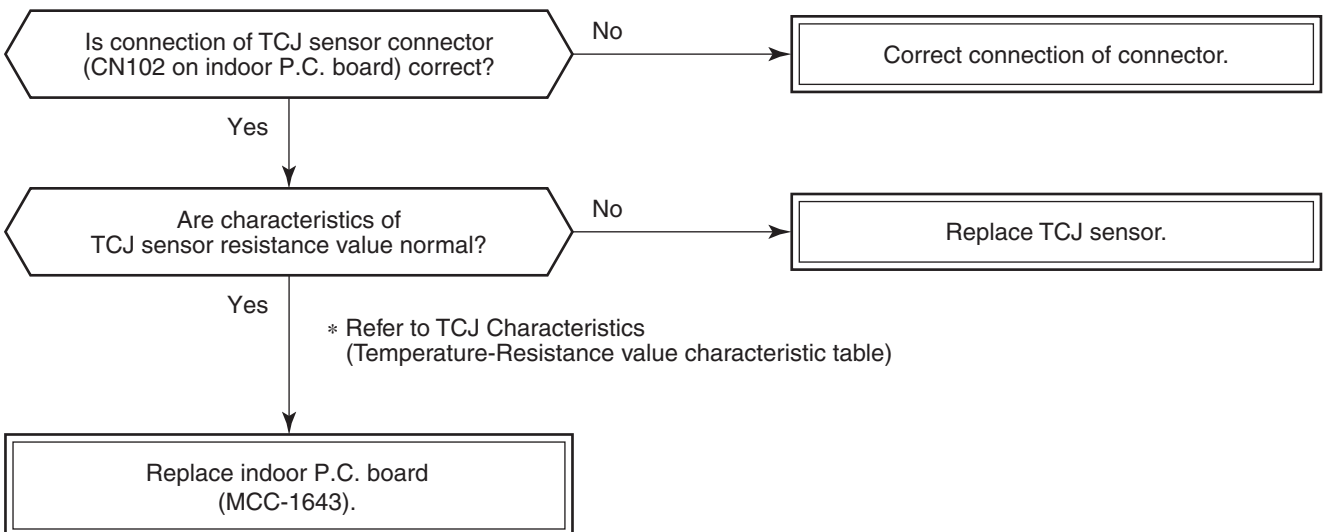

[C06 trouble] (“1:1 model” connection interface (TCB-PCNT30TLE2))

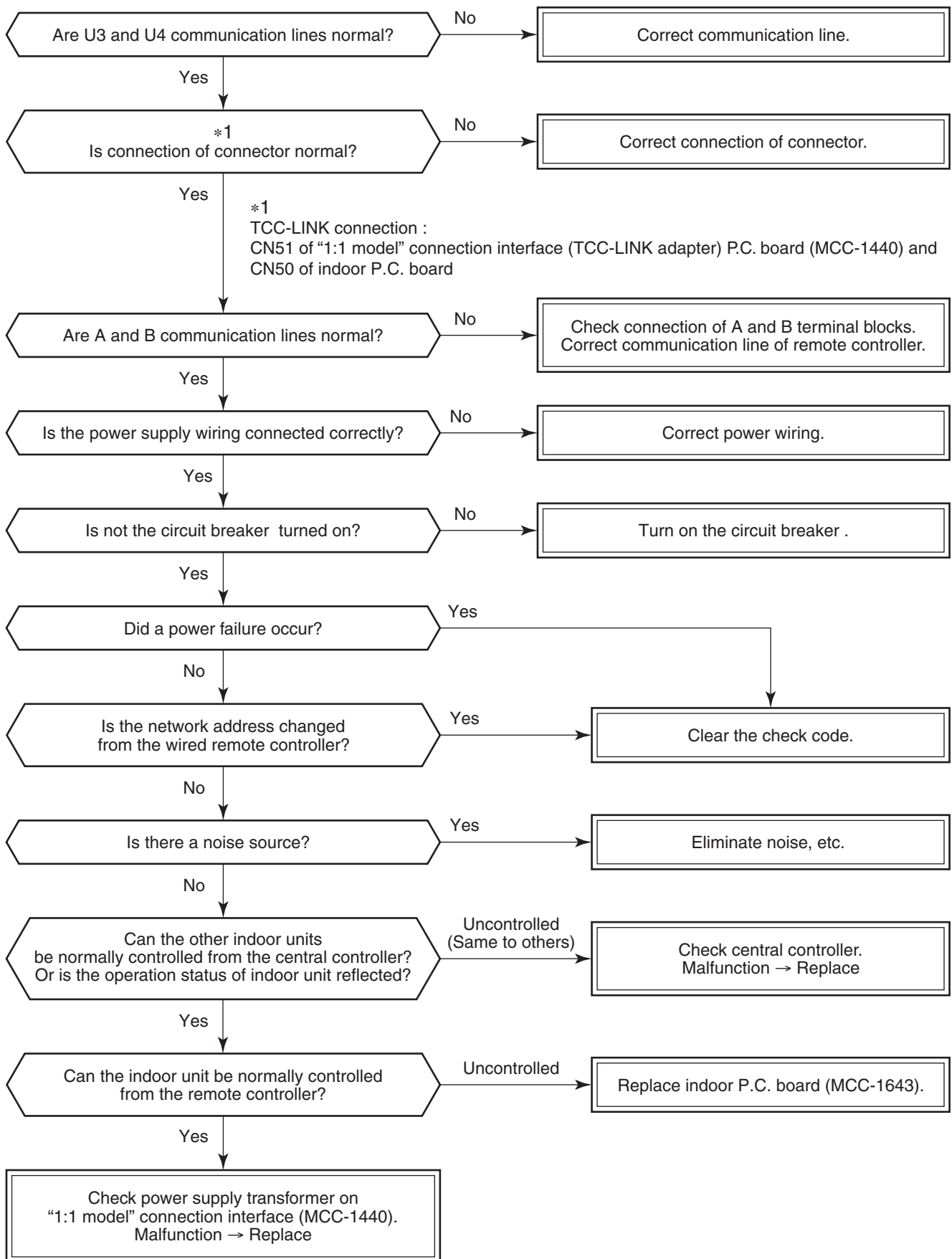

[E03 trouble] (Header indoor unit)

[E03 trouble] is detected when the indoor unit cannot receive a signal from the remote controller (also central controller).

Check A and B remote controllers and communication lines of the central control system U3 and U4.

As communication is impossible, this check code [E03] is not displayed on the remote controller and the central controller. [E01] is displayed on the remote controller and [C06 trouble] is displayed on the central controller.

If these check codes generate during operation, the air conditioner stops.

[F29 trouble]

This check code indicates a detection trouble of IC503 non-volatile memory (EEPROM) on the indoor unit P.C. board, which generated during operation of the air conditioner. Replace the service P.C. board.

* When EEPROM was not inserted when power supply turned on or when the EEPROM data read/write operation is impossible at all, the automatic address mode is repeated. In this time, [C06 trouble] is displayed on the central controller.

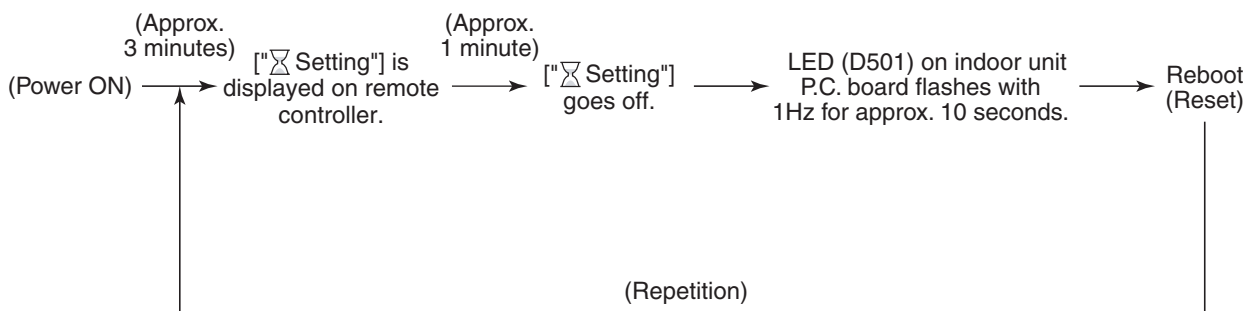

[P31 trouble] (Follower indoor unit)

When the header unit of a group operation detected [E03], [L03], [L07] or [L08] trouble, the follower unit of the group operation detects [P31 trouble] and then the unit stops.

There is no display of the check code or alarm history of the wired remote controller. (In this model, the mode enters in automatic address set mode when the header unit detected [L03], [L07] or [L08] trouble.)

Temperature sensor Temperature – Resistance value characteristic table

TA, TC, TCJ, TE, TS, TO sensors

TD, TL sensors

Representative value

Representative value

Temperature (°C)	Resistance value (kΩ)		
	(Minimum value)	(Standard value)	(Maximum value)
0	32.33	33.80	35.30
10	19.63	20.35	21.09
20	12.23	12.59	12.95
25	9.75	10.00	10.25
30	7.764	7.990	8.218
40	5.013	5.192	5.375
50	3.312	3.451	3.594
60	2.236	2.343	2.454
70	1.540	1.623	1.709
80	1.082	1.146	1.213
90	0.7740	0.8237	0.8761
100	0.5634	0.6023	0.6434

Temperature (°C)	Resistance value (kΩ)		
	(Minimum value)	(Standard value)	(Maximum value)
0	150.5	161.3	172.7
10	92.76	99.05	105.6
20	58.61	62.36	66.26
25	47.01	49.93	52.97
30	37.93	40.22	42.59
40	25.12	26.55	28.03
50	17.00	17.92	18.86
60	11.74	12.34	12.95
70	8.269	8.668	9.074
80	5.925	6.195	6.470
90	4.321	4.507	4.696
100	3.205	3.336	3.468

TA, TC, TCJ, TE, TS, TO sensors

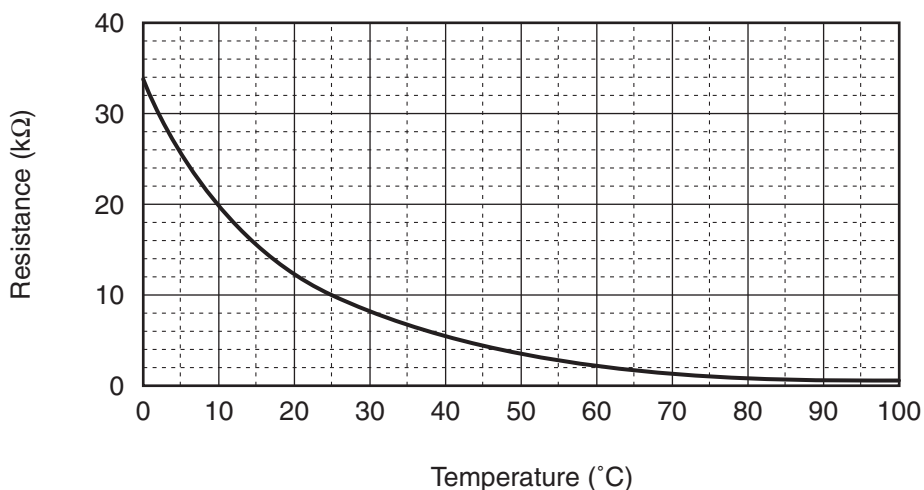

TD, TL sensors

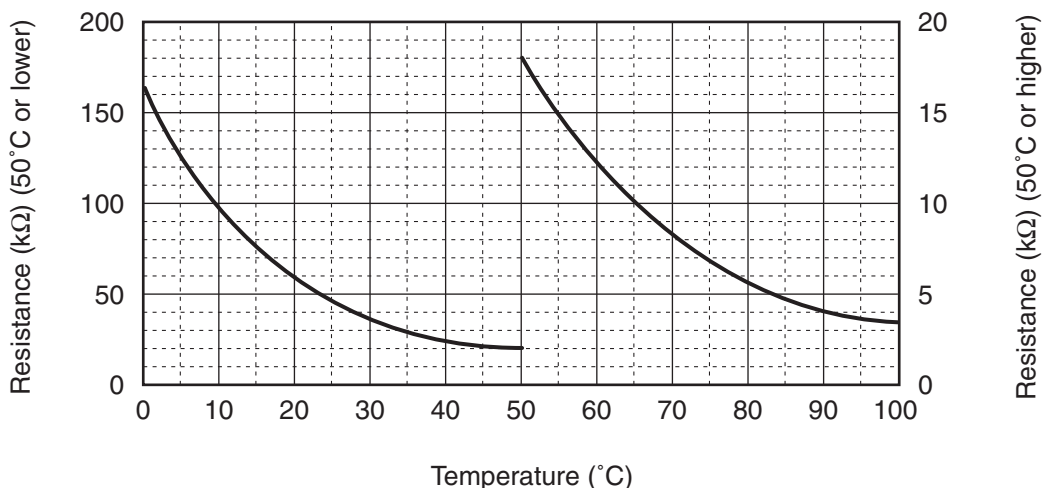

* As TH sensor (Outdoor unit heat sink temp. sensor) is incorporated in the outdoor control P.C. board, the resistance value cannot be measured.

7. REPLACEMENT OF SERVICE P.C. BOARD

7-1. Indoor Unit

CAUTION

<Model name: RAV-RM***FT*>

For the above models, set the CODE No. "00CE" and the setting data "0000" (initial) to "0001".

<Note: when replacing the P.C. board for indoor unit servicing>

The nonvolatile memory (hereafter called EEPROM, IC503) on the indoor unit P.C. board before replacement includes the model specific type information and capacity codes as the factory-set value and the important setting data which have been automatically or manually set when the indoor unit is installed, such as system/indoor/group addresses, high ceiling select setting, etc.

When replacing the P.C. board for indoor unit servicing, follow the procedures below.

After replacement completes, confirm whether the settings are correct by checking the indoor unit No., Group header unit/follower unit settings and perform the cooling cycle confirmation through the trial operation.

<Replacement procedures>

CASE 1

Before replacement, the indoor unit can be turned on and the setting data can be read out by wired remote control operation.

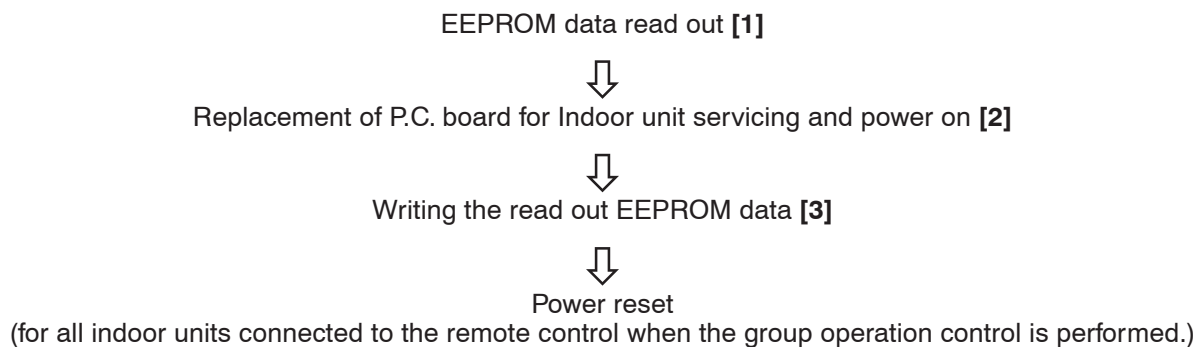

CASE 2

The EEPROM before replacement is trouble and the setting data cannot be read out.

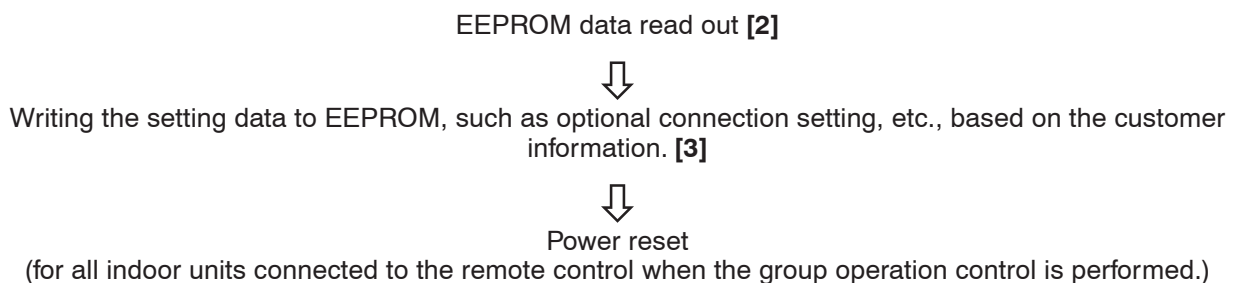

[1] Setting data read out from EEPROM

(Stop the operation of the unit.)

- 1** Push the [MENU] button to display the menu screen.
- 2** Push and hold the [MENU] button and the [V] button at the same time to display the “Field setting menu”.
 - Push and hold the buttons for more than 4 seconds.
- 3** Push the [^] / [V] button to select “7. DN setting” on the “Field setting menu” screen, then push the “ Set ” [F2] button.
 - When the group control is used, all the indoor units connected into the system are displayed on the screen.
- 4** Push the “ Unit ” [F1] button to select indoor unit in which you want to read out setting data in the EEPROM.
 - The selected unit changes as follows each time the button is pushed:

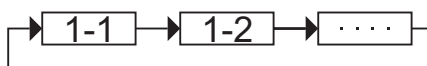

- 5** Push the “ Set ” [F2] button.
 - The setting display for the selected unit is displayed.
 - The fan and louver of the indoor unit operate.
- 6** Push the [^] / [V] to set “DN code” to [0001], then write down the setting data to be displayed.
(Filter sign lighting time)
- 7** Repeat the operation of **1** to **6**, then write down the setting data like **Table 1. Setting data** (CODE No. table (example)).
 - * The Code No.(DN) are ranged in order of No., which may be sometimes skipped.

- 8** After writing down all the setting data, push the “ Set ” [F2] button.
 - The setting display for the selected unit is displayed.
 - When the group control is used, the fan and louver of the selected indoor unit operate.

- 9** Push the [MENU] button to set the other “Code(DN)” and “Data”. After “Continue?” is displayed on the screen, push the “ No ” [F2] button to finish the setting operation. “ ⏸ Setting ” appears on the screen for a while, then the screen returns to the “Field setting menu” screen.

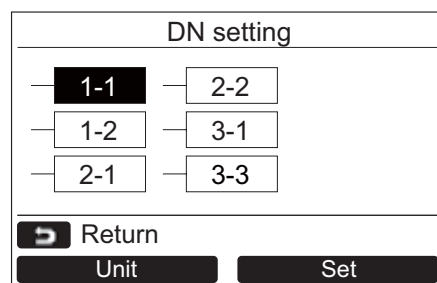
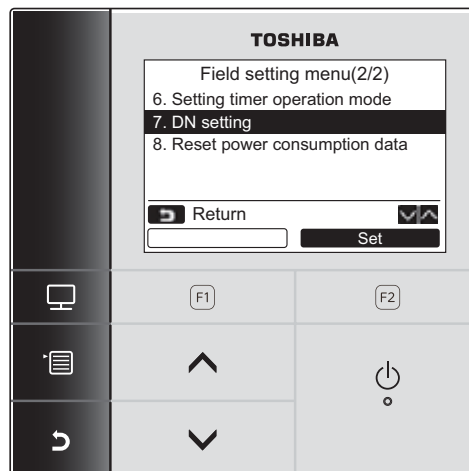

Address is displayed here.

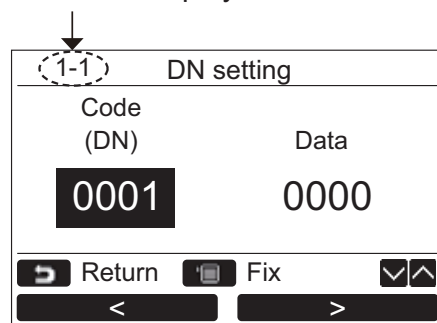

CODE No. required at least

DN	Contents
0010	Type
0011	Indoor unit capacity
0012	System address
0013	Indoor unit address
0014	Group address

1. The CODE No. for the Indoor unit type and Indoor unit capacity are required to set the rotation number setting of the fan.
2. If the system/indoor/group addresses are different from those before replacement, the auto-address setting mode starts and the manual resetting may be required again.
(when the multiple units group operation including twin system.)

[2] P.C. Board for indoor unit servicing replacement procedures

Step 1 Replace the P.C. board to the P.C. board for indoor unit servicing.

At this time, perform the same setting of the jumper wire (J01, J08, J09) setting (cut), switch SW501, (short-circuit) connector CN34 as the setting of the P.C. board before replacement.

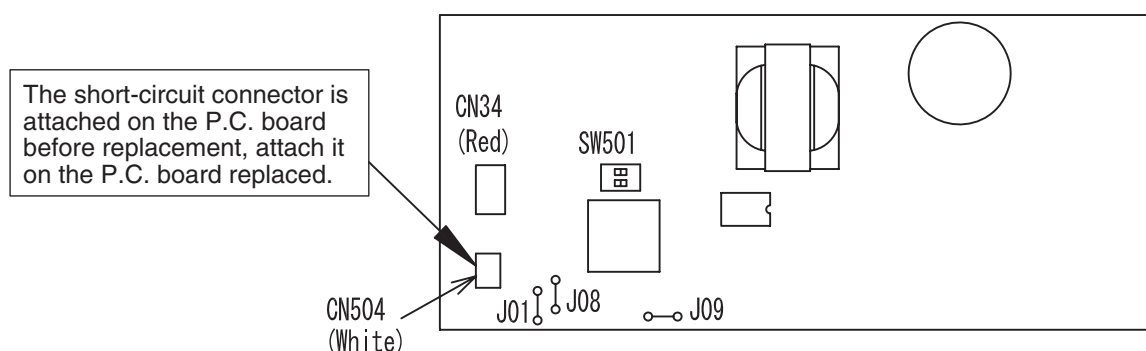

Step 2 According to the system configuration, turn on the indoor unit following to the either methods shown below.

a) Single operation (Indoor unit is used as standalone.)

Turn on the indoor unit.

1. After completion of the auto-address setting mode (required time: approx. 5 min.), proceed to [3].
(System address = 1, Indoor unit address = 1, Group address = 0 (standalone) are automatically set.)
2. Interrupt the auto-address setting mode, and proceed to [3].

b) Group operation (including twin triple and double twin system)

Turn on the indoor unit(s) with its P.C. board replaced to the P.C. board for indoor unit servicing, according to either methods 1 or 2 shown below.

1. Turn on only the indoor unit with its P.C. board replaced. (Be sure to confirm the remote controller is surely connected. If not, the operation [3] cannot be performed.)
Perform either methods 1 or 2 described in item a) above.
2. Turn on the multiple indoor units including the indoor unit with its P.C. board replaced.
 - Twin or triple or double twin 1 system only
 - All group connections

After completion of the auto-address setting mode (required time: approx. 5 min.), proceed to [3].













































* The header unit of the group may be changed by performing the auto-address setting.







Also, the system address/Indoor unit address of the indoor unit with its P.C. board replaced may be assigned to the addresses (not used) other than those of the indoor units without its P.C. board replaced.

It is recommended to keep the information in advance, which refrigerant system the indoor unit belongs to or whether the indoor unit works as the header unit or the follower unit in the group control operation.

[3] Writing the setting data to EEPROM

(Stop the operation of the unit.)

- 1** Push the [ MENU] button to display the menu screen.
- 2** Push and hold the [ MENU] button and the [ V] button at the same time to display the “Field setting menu”.
 - Push and hold the buttons for more than 4 seconds.
- 3** Push the [ ^] / [ V] button to select “7. DN setting” on the “Field setting menu” screen, then push the “  Set” [ F2] button.
 - When the group control is used, all the indoor units connected into the system are displayed on the screen.
- 4** Push the “  Unit” [ F1] button to select indoor unit in which you want to write the setting data to EEPROM, then push the “  Set” [ F2] button.
 - The setting display for the selected unit is displayed.
 - The fan and louver of the indoor unit operate.
- 5** Move the cursor to select “Code (DN)” with the “  <” [ F1] button, then set “[0010]” with the [ ^] / [ V] button.
- 6** Move the cursor to select “Data” with the “  >” [ F2] button, then push the [ ^] / [ V] button to set the “Data” to each Type name of indoor unit. For Floor standing type, set “Data” to [0013].
- 7** Push the [ MENU] button to set the other “Code(DN)” and “Data”. After “Continue?” is displayed on the screen, push the “  Yes” [ F1] button.
- 8** Move the cursor to select “Code(DN)” with the “  <” [ F1] button, then set [0011] with the [ ^] / [ V] button.
- 9** Move the cursor to select “Data” with the “  >” [ F2] button then push the [ ^] / [ V] button to set the “Data” to each capacity of indoor unit.
For RM56 model, set “Data” to [0009].
- 10** Push the [ MENU] button to set the other “Code(DN)” and “Data”. After “Continue?” is displayed on the screen, push the “  No” [ F2] button to finish the setting operation. “Setting” is displayed on the screen for a while, then the screen returns to the “Field setting menu” screen.
- 11** Pushing the [ CANCEL] button on the unit selection screen displays “ ⌘ Setting” on the screen for a while when the single operation is used, then the screen returns to the “Field setting menu” screen.
(It takes approx. 1 min until the remote controller operation is available again.)
- 12** Write the on-site setting data, such as an address setting, after installation to the EEPROM.
Perform the operation of **1** to **4** again.
- 13** Push the “  <” [ F1] button to select “Code(DN)”, then set it to [0001] with the [ ^] / [ V] button.
(Filter sign lighting time)
- 14** Check the setting data displayed at this time with the setting data written down in [1] Setting data read out from EEPROM.
If the setting data is different, set “Code(DN)” with the [ ^] / [ V] button, push the “  >” [ F2] button to select “Data” and change it to the setting data written down in [1] Setting data read out from EEPROM with the [ ^] / [ V] button, then push the [ MENU] button.
If the setting data is the same, proceed to next operation.

- 15** Change “Code (DN)” to [0002] with the [ / [] button. (Filter pollution level)
- 16** Perform the operation of **14**. Check the other “Code (DN)” also, change “Data” into the setting data written down in [1] **Setting data read out from EEPROM** if the setting data is different.
- 17** After writing down all the data, push the [ **CANCEL**] button.
 At the time, “ ⏰ **Setting** ” is displayed on the screen for a while when the single operation is used, then the screen returns to the “**Field setting menu**” screen.
 Pushing the [ **CANCEL**] button on the unit selection screen again displays “ ⏰ **Setting** ” on the screen for a while when the group control is used, then the screen returns to the “**Field setting menu**” screen.
 (It takes approx. 1 min until the remote controller operation is available again.)
- * The **Code No.(DN)** are ranged in order of No., which may be sometimes skipped.
 Even after changing the data wrongly and pushing the [ **MENU**] button, it is possible to return to the data before change by pushing the [ **CANCEL**] button if the CODE No (DN) is not changed.

<Fig. 2 EEPROM layout diagram>

The EEPROM (IC503) is attached to the IC socket. When detaching the EEPROM, use a tweezers, etc. Be sure to attach the EEPROM by fitting its direction as shown in the figure.
 * Do not bend the IC lead when replacing.

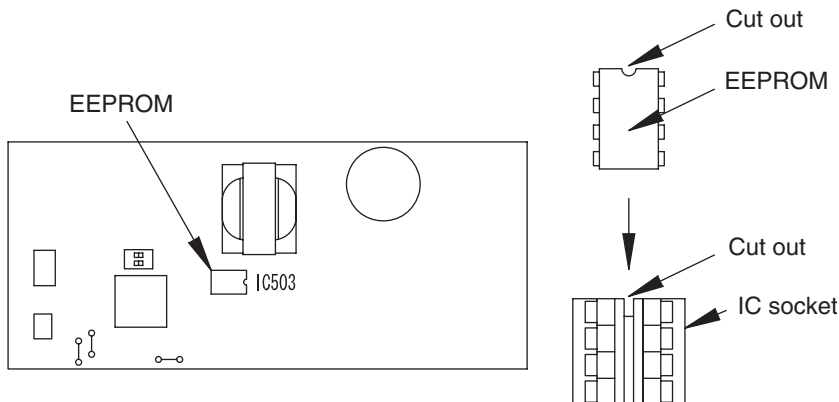

Table 1. Setting data (CODE No. table (example))

CODE No. (DN)	Item	Setting data	Factory-set value
0001	Filter sign lighting time		Depending on Type
0002	Filter pollution level		0000: standard
0003	Central control address		0099: Not determined
0006	Heating suction temperature shift		Depending on Type
000F	Cooling only		0000: Heat pump
0010	Type		Depending on model type
0011	Indoor unit capacity		Depending on capacity type
0012	System address		0099: Not determined
0013	Indoor unit address		0099: Not determined
0014	Group address		0099: Not determined
0019	Louver type (wind direction adjustment)		Depending on Type.
001E	Temperature range of cooling/heating automatic SW control point		0003: 3 °C (Ts ±1.5)
0028	Power failure automatic recovery		0000: None
002A	Selection of option / trouble input		0002: Humidifier
002B	Thermostat output SW		0000: Thermostat ON
002E	Selection of HA terminal		0000: Normal (HA terminal)
0031	Ventilation fan (standalone)		0000: Not available
0032	Sensor SW		0000: Body sensor
005D	High ceiling SW		0000: Standard
0060	Timer setting (wired remote controller)		0000: Available
0077	Dual set point		0000: Unavailable
008B	Correction of high heat feeling		0000: None
00B3	Soft cooling		0001: Available
00C2	Demand setting (outdoor unit current demand)		0075: 75 %
00D0	Remote controller operation save function		0001: Enable
00D1	8 °C operation		0000: None
00F6	Presence of Application control kit		0000: None

Table 2. Type: CODE No. 10

Setting data	Type	Type name abb.
0001*1	4-way Cassette Type	RAV-GM***UT*
0013*2	Floor Standing Type	RAV-RM***FT*

*1 EEPROM initial value on the P.C. board for indoor unit servicing.

*2 ⚠ CAUTION

<Model name: RAV-RM***FT*>

For above models, set the CODE No. to "00CE" and the setting data "0000" (initial) to "0001".

Table 3. Indoor unit capacity: CODE No. 11

Setting data	Type
0000*	Disable
0009	56
0012	80
0015	110
0017	140
0018	160

* EEPROM initial value on the P.C. board for indoor unit servicing.





8. SETUP AT LOCAL SITE AND OTHERS



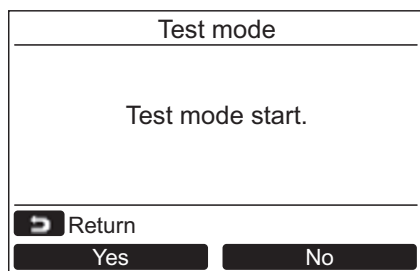
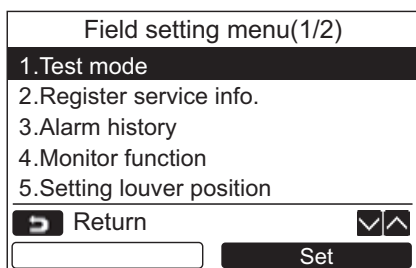





8-1. Indoor Unit

8-1-1. Test Run Setup on Remote Controller

<Wired remote controller>



- 1** Push the [ MENU] button to display the menu screen.
- 2** Push and hold the [ MENU] button and the [ ] button at the same time to display the “Field setting menu”.
→ Push and hold the buttons for more than 4 seconds.

- 3** Push the [ ] / [ ] button to select “1. Test mode” on the “Field setting menu” screen, then push the “  Set” [ F2] button.
→ Pushing the “Yes” [ F1] button sets the test mode and the screen returns to the “Field setting menu” screen.
Push [ CANCEL] twice, the screen (2) appears.

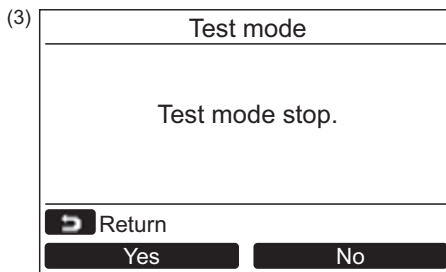
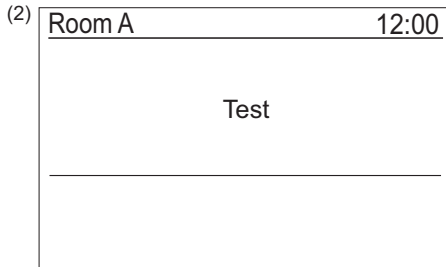
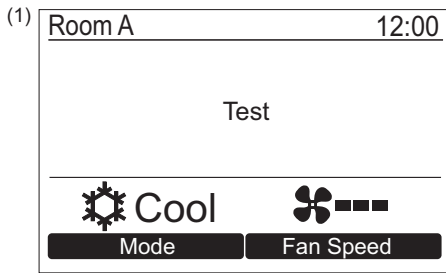

4 Push the [ON / OFF] button to start the test mode. The screen (1) shown in the left appears. (The screen (2) appears when the operation is stopped.)

- Perform the test mode in the “Cool” or “Heat” mode.
- Temperature setting cannot be adjusted during the test mode.
- Check codes are displayed as usual.

5 When the test mode is finished, push the [] / [] button to select “1. Test mode” on the “Field setting menu” screen, then push the “ Set” [F2] button.

The screen (3) appears.

- Pushing the “ Yes” [F1] button stops the test mode screen and continues the normal operation.

NOTE



The test mode stops after 60 minutes and the screen returns to the normal / detailed display.

<Wireless remote controller>

◆ In case of wireless remote controller

1 Turn on the power of the air conditioner.
When power is turned on for the first time after installation, it takes approx. 5 minutes until the remote controller becomes available. In the case of subsequent power-on, it takes approx. 1 minute until the remote controller becomes available.

Execute a test run after the predetermined time has passed.

2 Push “ON/OFF” button on the remote controller, select [ Cool] or [ Heat] with “MODE” button, and then select [ HIGH] with “FAN” button.

3

Cooling test run	Heating test run
Set the temperature to 17 °C with the temp. setup buttons.	Set the temperature to 30 °C with the temp. setup buttons.

4

Cooling test run	Heating test run
After confirming a signal receiving sound “beep” immediately set the temperature to 18 °C with the temp. setup buttons.	After confirming a signal receiving sound “beep” immediately set the temperature to 29 °C with the temp. setup buttons.

5

Cooling test run	Heating test run
After confirming a signal receiving sound “beep” Immediately set the temperature to 17 °C with the temp. setup buttons.	After confirming a signal receiving sound “beep” immediately set the temperature to 30 °C with the temp. setup buttons.

6 Repeat procedures **4 → 5 → 4 → 5**.
Indicators “Operation” (green), “Timer” (green), and “Ready” (orange) in the wireless receiver section flash in approx. 10 seconds, and the air conditioner starts operation. If any of these indicators does not flash, repeat procedures 2 to 5.

7 Upon completion of the test run, push “ON/OFF” button to stop operation.

<Overview of test run operations using the wireless remote controller>

▼ Cooling test run:

ON/OFF → 18 °C → 17 °C → 18 °C → 17 °C → 18 °C → 17 °C → 18 °C → (test run) → ON/OFF

























▼ Heating test run:

ON/OFF → 29 °C → 30 °C → 29 °C → 30 °C → 29 °C → 30 °C → 29 °C → (test run) → ON/OFF

8-1-2. Forced Defrost Setup of Remote Controller (For wired remote controller only)

(Preparation in advance)

Forced Defrost Setup

- 1** Push the [ MENU] button to display the menu screen.
- 2** Push and hold the [ MENU] button and the [ V] button at the same time to display the “Field setting menu”.
→ Push and hold the buttons for more than 4 seconds.
- 3** Push the [ ^] / [ V] button to select “7. DN setting” on the “Field setting menu” screen, then push the “  Set” [ F2] button.
→ The fan and louver of the indoor unit operate.
When the group control is used, the fan and louver of the selected indoor unit operate.
→ Move the cursor to select “Code(DN)” with the “  < ” [ F1] button, then set “008C” with the [ ^] / [ V] button.
→ Move the cursor to select “Data” with the “  > ” [ F2] button, then set “0001” with the [ ^] / [ V] button.
- 4** Push the [ MENU] button to set the other Code(DN) and Data. After “Continue?” is displayed on the screen, push the “  Yes” [ F1] button.
- 5** Push the “  No” [ F2] button to finish the setting operation. “  Setting” appears on the screen for a while, then the screen returns to the “Field setting menu” screen.
→ Pushing the “  No” [ F2] button displays the unit selection screen when the group control is used. Push the [ CANCEL] button on the unit selection screen to finish the setting operation. “  Setting” appears on the screen for a while, then the screen returns to the “Field setting menu” screen.

(Practical operation)

- Push [ ON/OFF] button.
- Select the HEAT mode.
- After a while, the forced defrost signal is sent to the outdoor unit and then the outdoor unit starts defrost operation. (The forced defrost operation is performed for Max. 12 minutes.)
- After defrost operation finished, the operation returns to the heating operation.

To execute the defrost operation again, start procedure from above item **1** .

(If the forced defrost operation was executed once, setting of the above forced defrost operation is cleared.)

8-1-3. LED Display on P.C. Board

1. D501 (Red)

- It goes on (Goes on by operation of the main microcomputer) at the same time when the power supply is turned on.
- It flashes with 1-second interval (every 0.5 second): When there is no EEPROM or writing-in operation fails.
- It flashes with 10-seconds interval (every 5 second): During DISP mode
- It flashes with 2-seconds interval (every 1 second): While setting of function select (EEPROM)

2. D403 (Red)

- It goes on when power supply of the remote controller is turned on. (Lights on hardware)

3. D14 (Orange)

- It flashes while receiving the serial signal from the outdoor unit. (Hardware)



















4. D15 (Green)

- It flashes while sending the serial signal to the outdoor unit. (Hardware)

8-1-4. Function Selection Setup

<Procedure> Perform setting while the air conditioner stops.

Set up Central Control Address Number

- 1** Push the [ MENU] button to display the menu screen.
- 2** Push and hold the [ MENU] button and the [ V] button at the same time to display the “Field setting menu”.
 - Push and hold the buttons for more than 4 seconds.
- 3** Push the [ ^] / [ V] button to select “7. DN setting” on the “Field setting menu” screen, then push the “  Set ” [ F2] button.
 - The fan and louver of the indoor unit operate.
When the group control is used, the fan and louver of the selected indoor unit operate.
 - Move the cursor to select “Code(DN)” with the “  < ” [ F1] button, then set “Code(DN)” with the [ ^] / [ V] button.
 - Move the cursor to select “Data” with the “  > ” [ F2] button, then set “Data” with the [ ^] / [ V] button.
- 4** Push the [ MENU] button to set the other Code(DN) and Data. After “Continue?” is displayed on the screen, push the “  No ” [ F2] button to finish the setting operation. “ ⏸ Setting ” appears on the screen for a while, then the screen returns to the “Field setting menu” screen.

Function CODE No. (DN Code) table (includes all functions needed to perform applied control on site)

DN	Item	Description		At shipment
0001	Filter display delay timer	0000: None 0002: 2500H 0004: 10000H	0001: 150H 0003: 5000H	0001: 150H
0002	Dirty state of filter	0000: Standard 0001: High degree of dirt (Half of standard time)		0000: Standard
0003	Central control address	0001: No.1 unit 0099: Unfixed	to 0064: No.64 unit	0099: Unfixed
0006	Heating temp shift	0000: 0 °C 0002: +2 °C	to 0001: +1 °C 0010: +10 °C (Up to +6 recommended)	0000 : 0°C
000F	Cooling only	0000: Heat pump 0001: Cooling only (No display of [AUTO] [HEAT])		0000: Heat pump
0010	Type	0013: (Floor Standing Type)		0013: (Floor Standing Type)
0011	Indoor unit capacity	0000: Unfixed	0001 to 0034	According to capacity type
0012	Line address	0001: No.1 unit	to 0030: No.30 unit	0099: Unfixed
0013	Indoor unit address	0001: No.1 unit	to 0064: No.64 unit	0099: Unfixed
0014	Group address	0000: Individual 0002: Follower unit of group	0001: Header unit of group	0099: Unfixed
0019	Louver type (Air direction adjustment)	0000: No louver 0004: (4-way Air Discharge Cassette type)	0001: Swing only	0001: Swing only
001E	Temp difference of [AUTO] mode selection COOL → HEAT, HEAT → COOL	0000: 0 deg (For setup temperature, reversal of COOL / HEAT by } (Data value) / 2)	to 0010: 10 deg	0003: 3 deg (Ts ±1.5)
0028	Automatic restart of power failure	0000: None	0001: Restart	0000: None
002A	Selection of option/Trouble input (TCB-PCUC2E: CN3)	0000: Filter input 0002: None	0001: Alarm input (Air washer, etc.)	0002: None
002B	Thermostat ON output (TCB-PCUC2E)	0000: Indoor unit thermostat ON	to 0001: Output of compressor ON signal reception	0000: Indoor unit thermostat ON
002E	HA terminal (CN61) select	0000: Usual 0002: Fire alarm input	0001: Leaving-ON prevention control	0000: Usual (HA terminal)
0031	Ventilating fan control	0000: Unavailable	0001: Available	0000: Unavailable
0032	TA sensor selection	0000: Body TA sensor	0001: Remote controller sensor	0000: Body TA sensor
0033	Temperature unit select	0000: °C	0001: °F	0000: °C
0060	Timer setting (wired remote controller)	0000: Available (can be performed)	0001: Unavailable (cannot be performed)	0000: Available
0077	Dual set point	0000: Unavailable	0002: Available	0000: Unavailable
00B3	Soft cooling	0000: Unavailable	0001: Available	0001: Available
00C2	Current demand X% to outdoor unit	0050 : 50%	to 0100 : 100%	0075 : 75%
00D0	Whether the power saving mode can be set by the remote controller	0000: Invalid	0001: Valid	0001: Valid
00D1	Existence of 8°C heating operation function	0000 : Invalid (Impossible)	0001 : Valid (Possible)	0000 : Invalid (Impossible)
00F6	Presence of Application control kit (TCB-PCUC2E)	0000: None 0001: Exist		0000: None

8-1-5. Wiring and Setting of Remote Controller Control

2-remote controller control (Controlled by 2 remote controllers)

This control is to operate 1 or multiple indoor units are operated by 2 remote controllers.
(Max. 2 remote controllers are connectable.)

• When connected 2 remote controllers operate an indoor unit

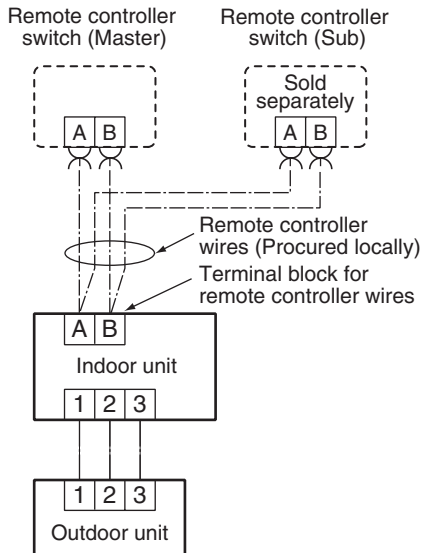

<Wired remote controller (RBC-AMT32E)> How to set wired remote controller as sub remote controller

Change DIP switch inside of the rear side of the remote controller switch from remote controller master to sub.

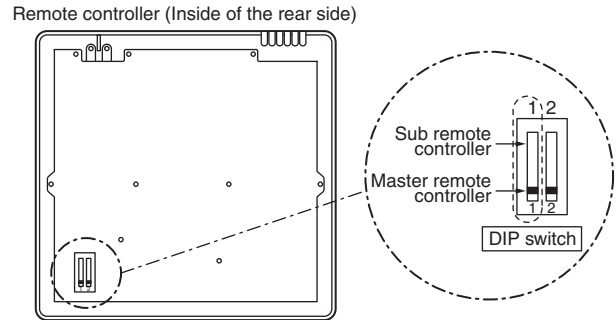

• When connected 2 remote controllers operate the twin

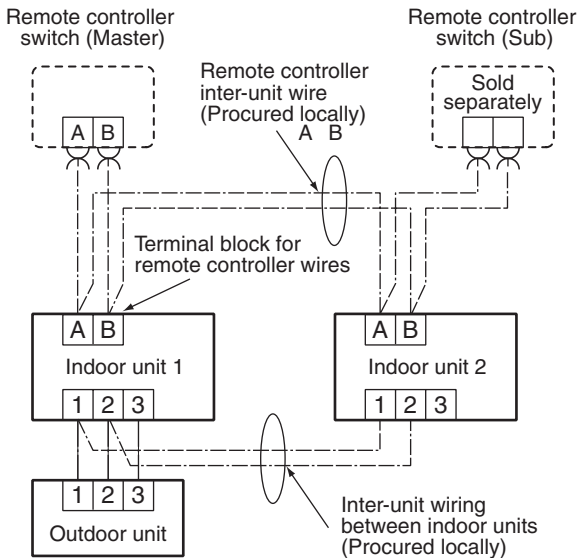

(Setup method)

One or multiple indoor units are controlled by 2 remote controllers.
(Max. 2 remote controllers are connectable.)

[Operation]

1. The operation contents can be changed by Last-push-priority.
2. Use a timer on either Master remote controller or Sub remote controller.

Set the remote controller as "Header remote controller (Master)" or "Follower remote controller (Sub)" when the dual remote controller system is used.

Carry out the setting operation while the indoor unit is stopped. (Turn off the air conditioning unit before starting the setting operation.)

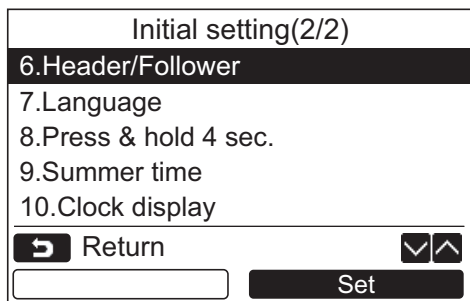

1 Push the [] / [] button to select "6. Header/Follower" on the "Initial setting" screen, then push the " Set" [F2] button.

2 Push the [] / [] button to select the setting.

3 Push the [MENU] button.

→ " ⏸ Setting" appears on the screen, then the screen returns to the "Initial setting" screen.

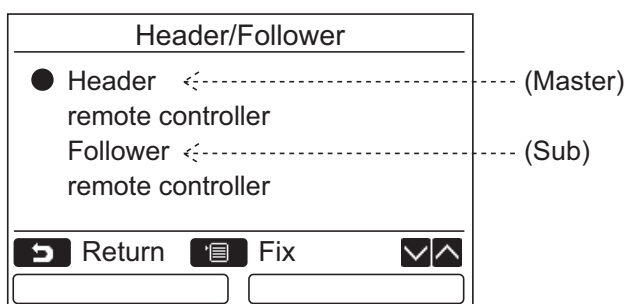

Note for the Header/Follower setting

- Set the RBC-AMS55E-ES, RBC-AMS55E-EN remote controller as the Header remote controller when the dual remote controller system is used.
- The RBC-AMS55E-ES, RBC-AMS55E-EN remote controller can be used as the Follower remote controller when the dual remote controller system is used that consists of two RBC-AMS55E-ES, RBC-AMS55E-EN remote controllers.
- The following functions are not available when the remote controller is set as the Follower remote controller: Schedule timer / Off reminder timer / Night operation / Energy saving operation / Return back / Saving operation / Power consumption / Reset power consumption data.

NOTE

- Some functions are not available when the remote controller is set as the Follower remote controller.
- In the dual remote controller system, the latter operation overrides the former.
- The remote controller is set as "Header remote controller" as factory default.
- If the Header (Master) / Follower (Sub) remote controller settings are not set correctly, the "E01," "E03," or "E09" check code is displayed.

<Wireless remote controller>

How to set wireless remote controller as sub remote controller

Turn on the bit 4 of DIP switch SW30 on the signal receiving unit and change P.C. board.

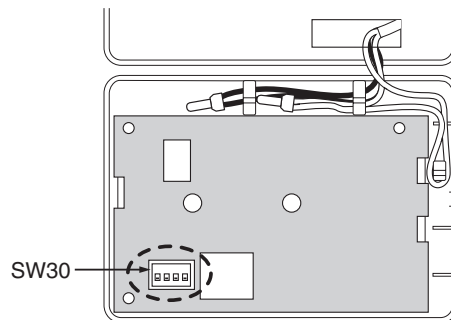

DIP switch [SW30]

4	ON=Sub	OFF=Master
3	ON=B	OFF=A
2	Not used	
1	Not used	

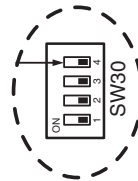

Wireless remote controller A-B selection

Using 2 wireless remote controllers for the respective air conditioners, when the 2 air conditioners are closely installed.

Wireless remote controller B setup

1. Push the START/STOP button to operate the air conditioner. Push it again to stop the air conditioner.
2. Push [Temporary] button on the signal receiving unit to operate the air conditioner.
3. Point the wireless remote controller at the indoor unit.
4. Push and hold **CHK** ● button on the wireless remote controller by the tip of the pencil. "00" will be shown on the display.
5. Push the **MODE** ^{MODE} ● button during pushing **CHK** ● .
"B" will be shown on the display and "00" will be disappear and the air conditioner will turn OFF. The wireless remote controller B is memorized.

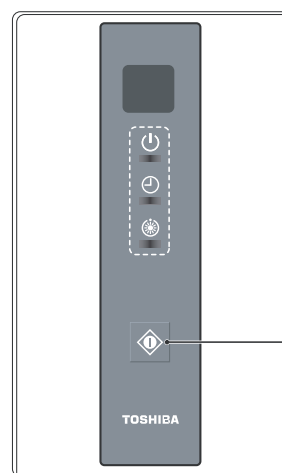
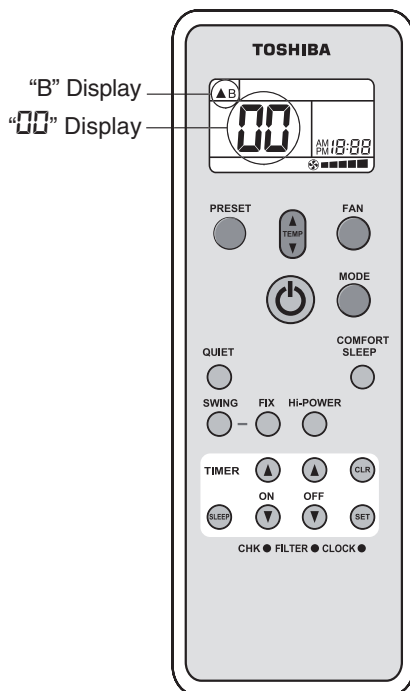

TEMPORARY button

Note:

- Repeat above step to reset wireless remote controller to be A.
- The wireless remote controllers do not display "A".
- The factory default of the wireless remote controllers is "A".











8-1-6. Monitor Function of Remote Controller Switch

■ Calling of sensor temperature display

The sensor temperature or operational status of indoor unit, outdoor unit, or remote controller can be monitored.

Monitor function	
Code	Data
00	0024
<input type="button" value="Return"/> <input type="button" value="↙"/> <input type="button" value="↘"/>	
<input type="text"/>	<input type="text"/>

Procedure

- 1** Push the [ MENU] button to display the menu screen.
- 2** Push and hold the [ MENU] button and the [ ↓] button at the same time to display the “Field setting menu”.
→ Push and hold the buttons for more than 4 seconds.
- 3** Push the [ ↑] / [ ↓] button to select “4. Monitor function” on the “Field setting menu” screen, then push the “  Set ” [ F2] button.
→ Push the [ ↑] / [ ↓] button to select the code to check data.
- 4** Push the [ CANCEL] button to return to the “Field setting menu” screen.

Indoor unit data	
Code	Data name
01	Room temperature (remote controller)
02	Indoor unit intake air temperature (TA)
03	Indoor unit heat exchanger (coil) temperature (TCJ)
04	Indoor unit heat exchanger (coil) temperature (TC)
F3	Indoor unit fan cumulative operating hours (x1 h)
E2	Indoor unit refrigerant leak detection sensor output*

* Display and the contents

- - - - : Sensor function is not available.

0000 : Normal

0001 : Sensor has been used for 5 years.

0002 : Sensor trouble or exceeding the life of the product for sensor

0003 : Sensor is detecting refrigerant leak

Outdoor unit data	
Code	Data name
60	Outdoor unit heat exchanger (coil) temperature (TE)
61	Outside air temperature (TO)
62	Compressor discharge temperature (TD)
63	Compressor suction temperature (TS)
65	Heatsink temperature (THS)
6A	Operating current (x1/10)
6D	Outdoor heat exchange (coil) temperature (TL)
F1	Compressor cumulative operating hours (x100 h)

(Group control operation)

In a group control, operation of maximum 8 indoor units can be controlled by a remote controller.

Twin, triple or double twin of an outdoor unit is one of the group controls.

The indoor unit connected with outdoor unit (Individual/Header of twin) controls room temperature according to setting on the remote controller.

<System example>

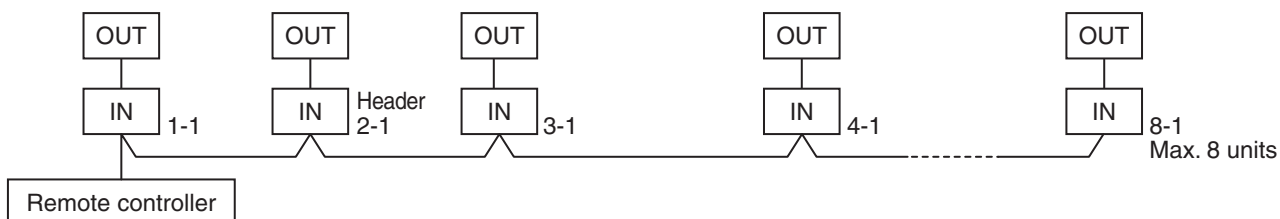

1. Display range on remote controller

The setup range (Operation mode/Fan speed select/Setup temp) of the indoor unit which was set to the header unit is reflected on the remote controller.

2. Address setup

If there is no serial communication between indoor and outdoor when the power is turned on, it is judged as follower unit of the twin. (Every time when the power is turned on)

- The judgment of header (wired) / follower (simple) of twin is carried out every time. It is not stored in nonvolatile memory.

Turn on power of the indoor unit to be controlled in a group within 3 minutes after setting of automatic address.

If power of the indoor unit is not turned on within 3 minutes (completion of automatic address setting), the system is rebooted and the automatic address setting will be judged again.

1) Connect indoor/outdoor connecting wire surely.

2) Check line address/indoor address/group address of the unit one by one.

Especially in case of twin, triple, double twin, check whether they are identical system address or not.

3) The unit No. (line/indoor group address) which have been set once keep the present status as a rule if the unit No. is not duplicated with one of another unit.

Indoor unit power-ON sequence

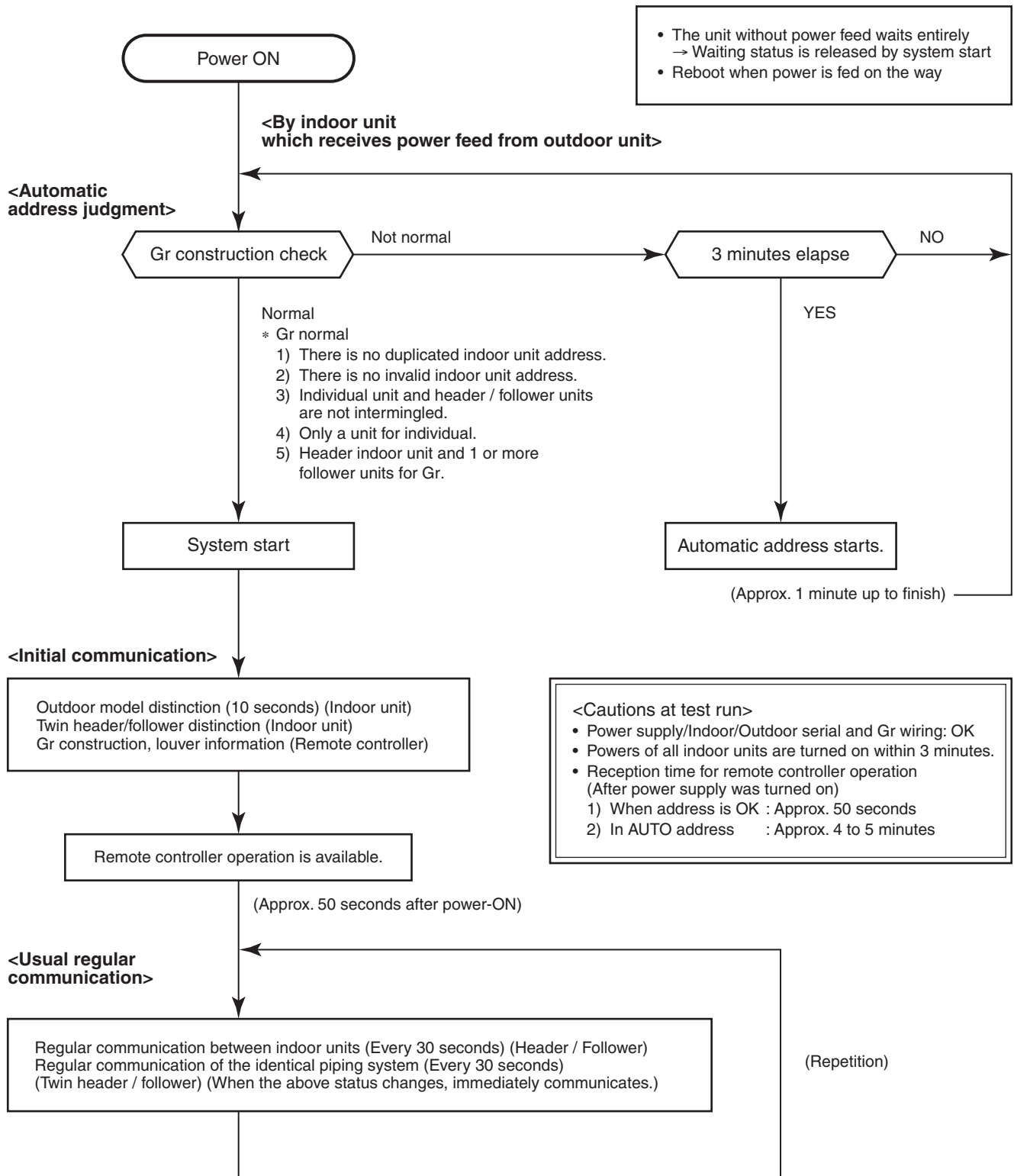

- In a group operation, if the indoor unit which was fed power after judgment of automatic address cannot receive regular communication from the header unit and regular communication on identical pipe within 120 seconds after power was turned on, it reboots (system reset).
→ The operation starts from judgment of automatic address (Gr construction check) again.
(If the address of the header unit was determined in the previous time, the power fed to the header unit and reboot works, the header unit may change though the indoor unit line address is not changed.)

8-2. Setup at Local Site / Others

Model name: TCB-PCNT30TLE2

8-2-1. 1:1 Model Connection Interface (TCC-LINK adapter)

1. Function

This model is an optional P.C. board to connect the indoor unit to 1:1 model connection interface.

2. Microprocessor block diagram

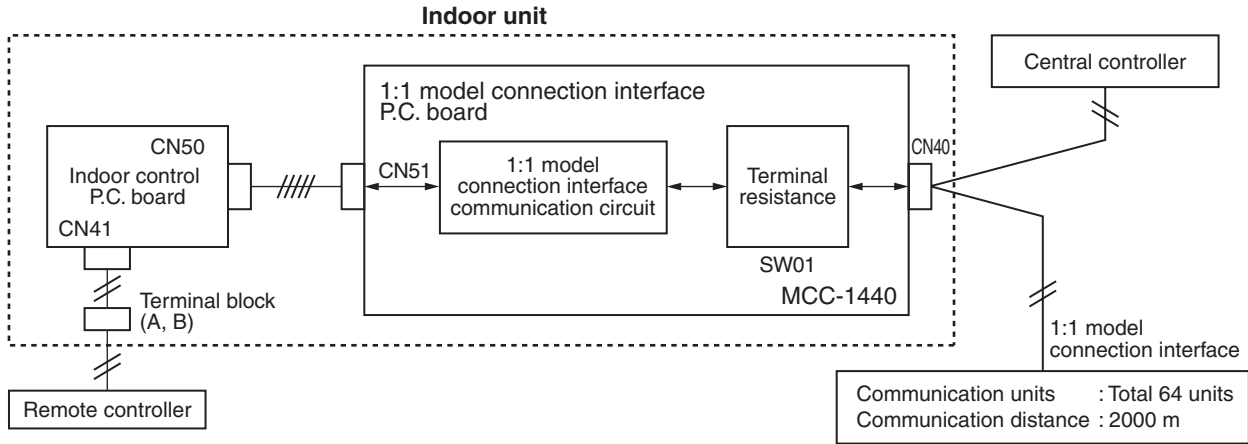

3. 1:1 model connection interface wiring connection

⚠ CAUTION

- 1) When controlling DI, SDI series collectively, 1:1 model connection interface (This option) is required.
- 2) In case of group operation, twin-triple operation, the 1:1 model connection interface is necessary to be connected to the header unit.
- 3) Connect the central control devices to the central control system wiring.
- 4) When controlling DI, SDI series only, turn on only Bit 1 of SW01 of the least line of the system address No. (OFF when shipped from the factory)

*** In case of DI, SDI series, the address is necessary to be set up again from the wired remote controller after automatic addressing.**

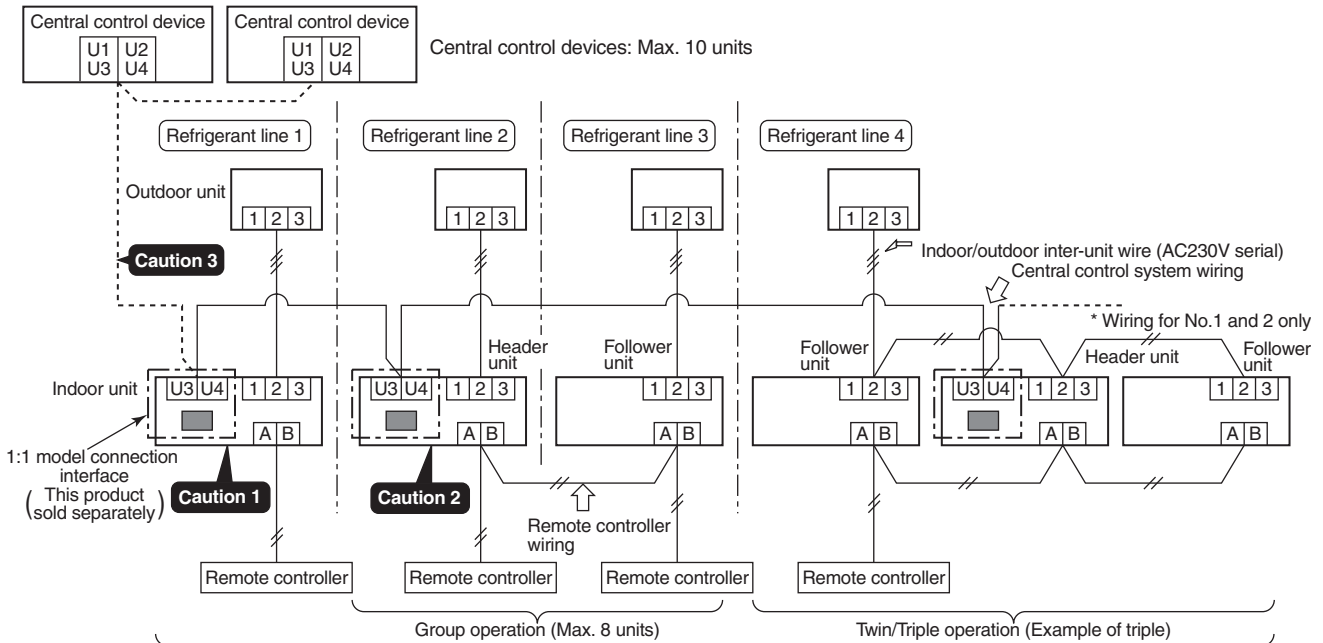

Indoor units in all refrigerant lines: Max. 64 units
 [If mixed with SMMS (Link wiring), multi indoor units are included.]
 * However group follower units of SDI, DI series are not included in number of the units.

4. Wiring Specifications

- Use 2-core with no polar wire.
- Match the length of wire to wire length of the central control system. If mixed in the SMMS system, the wire length is lengthened with all indoor/outdoor inter-unit wire length at side.
- To prevent noise trouble, use 2-core shield wire.
- Connect the shield wire by closed-end connection and apply open process (insulating process) to the last terminal. Ground the earth wire to 1 point at indoor unit side. (In case of central controlling of digital inverter (DI, SDI) unit setup)

No. of wires	Size
2	Up to 1000m: twisted wire 1.25mm ² Up to 2000m: twisted wire 2.0mm ²

⚠ CAUTION

- 1) Closed-end connection of shield wire (Connect all the connecting parts of each indoor unit)
- 2) Apply open process to the last terminal (insulating process).
- 3) Ground earth wire to 1 point at indoor unit side.

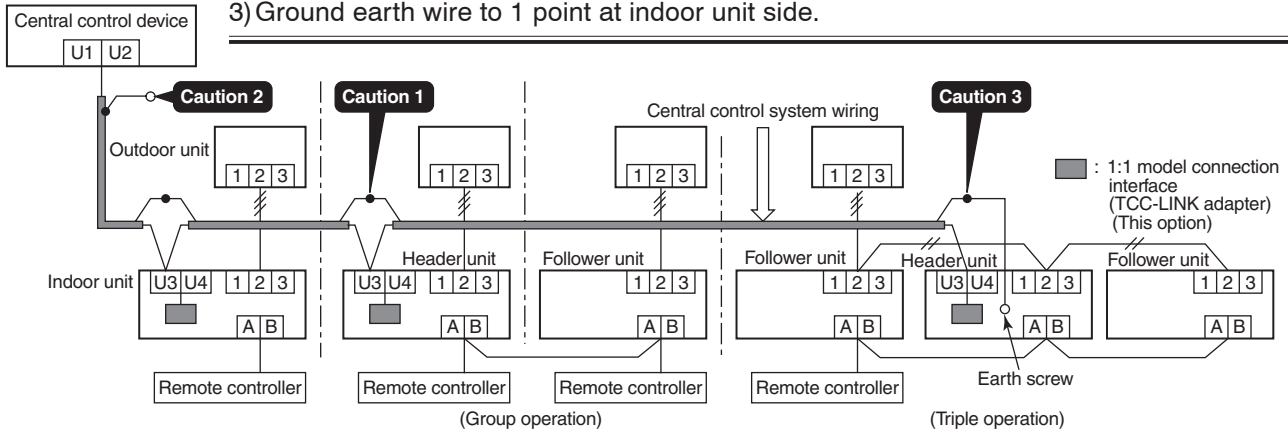

5. P.C. Board Switch (SW01) Setup

When performing collective control by customized setup only, the setup of terminator is necessary.

- Using SW01, set up the terminator.
- Set up the terminator to only the interface connected to the indoor unit of least line address No.

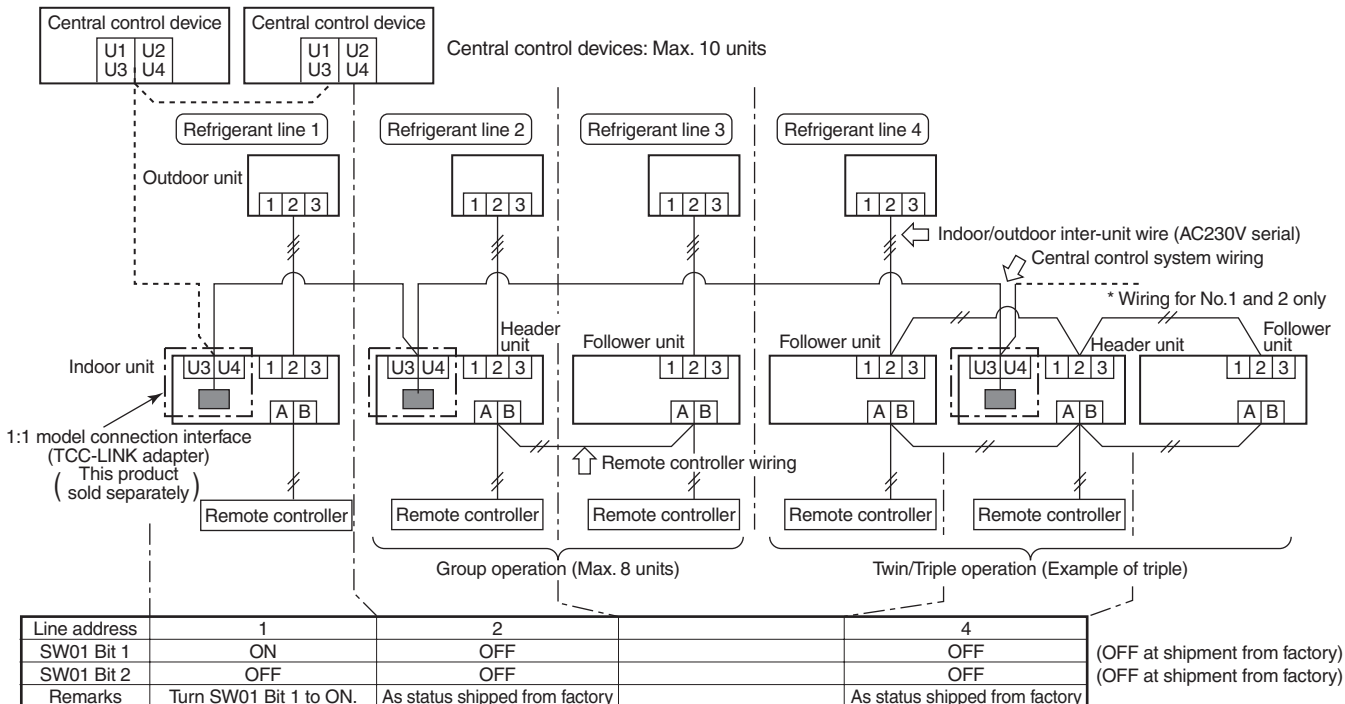

(Reference) Setup contents of switch

SW01		Terminator	Remarks
Bit 1	Bit 1		
OFF	OFF	None	Mixed with SMMS (Link wiring) at shipment from factory
ON	OFF	100Ω	Central control by digital inverter only
OFF	ON	75Ω	Spare
ON	ON	43Ω	Spare

6. External view of P.C. board assembly

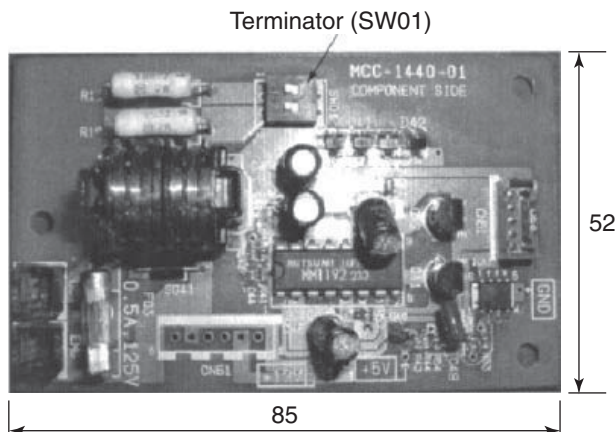

7. Address setup

In addition to set up the central control address, it is necessary to change the indoor unit number. (Line/Indoor/Group address). For details, refer to 1:1 model connection interface Installation Manual.

8-3. How to Set up Central Control Address Number

When connecting the indoor unit to the central control remote controller using 1:1 model connection interface, it is necessary to set up the central control address number.

- The central control address number is displayed as the line No. of the central control remote controller.

How to set up from indoor unit side by remote controller

<Procedure> Perform setup while the unit stops.

- 1 Push the [MENU] button to display the menu screen.
- 2 Push and hold the [MENU] button and the [▼] button at the same time to display the “Field setting menu”.
 - Push and hold the buttons for more than 4 seconds.
- 3 Push the [▲] / [▼] button to select “7. DN setting” on the “Field setting menu” screen, then push the “ Set ” [F2 F2] button.
 - The fan and louver of the indoor unit operate.
When the group control is used, the fan and louver of the selected indoor unit operate.
 - Move the cursor to select “Code(DN)” with the “ < ” [F1 F1] button, then set “0003” with the [▲] / [▼] button.
 - Move the cursor to select “Data” with the “ > ” [F2 F2] button, then set “Data” with the [▲] / [▼] button. **The setup data is shown in the table below (Table 1).**
- 4 Push the [MENU] button to set the other Code(DN) and Data. After “Continue?” is displayed on the screen, push the “ No ” [F2 F2] button to finish the setting operation.

“ ⏸ Setting ” appears on the screen for a while, then the screen returns to the “Field setting menu” screen.

(Table 1)

SET DATA	Central control address No.
0001	1
0002	2
0003	3
⋮	⋮
0064	64
0099	Unset (Setup at shipment from factory)

9. ADDRESS SETUP

9-1. Address Setup

<Address setup procedure>

When an outdoor unit and an indoor unit are connected and they are twin-triple, or when an outdoor unit is connected to each indoor unit respectively in the group operation even if multiple refrigerant lines are provided, the automatic address setup completes with power-ON of the outdoor unit. The operation of the remote controller is not accepted while automatic address works. (Approx. 4 to 5 minutes)

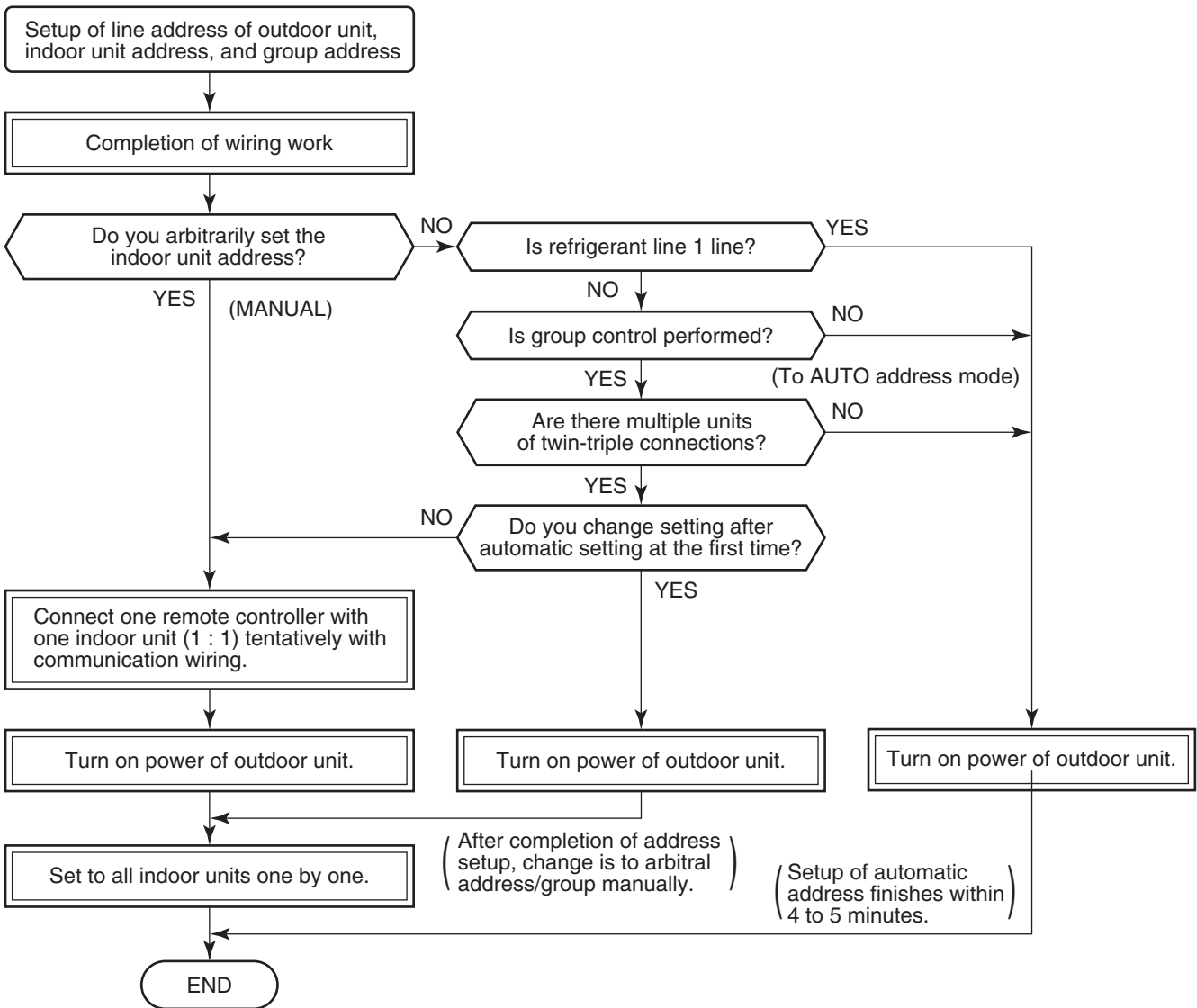

- When the following addresses are not stored in the neutral memory (IC10) on the indoor P.C. board, a test run operation cannot be performed. (Unfixed data at shipment from factory)

	CODE No.	Data at shipment	SET DATA range
Line address	0012	0099	0001 (No. 1 unit) to 0030 (No. 30 unit)
Indoor unit address	0013	0099	0001 (No. 1 unit) to 0064 (No. 64 unit) Max. value of indoor units in the identical refrigerant line (Double twin = 4)
Group address	0014	0099	0000 : Individual (Indoor units which are not controlled in a group) 0001 : Header unit (1 indoor unit in group control) 0002 : Follower unit (Indoor units other than header unit in group control)

9-2. Address Setup & Group Control

<Terminology>

- Indoor unit No. : N – n = Outdoor unit line address N (Max. 30) – Indoor unit address n (Max. 64)
- Group address : 0 = Single (Not group control)
1 = Header unit in group control
2 = Follower unit in group control
- Header unit (= 1) : The representative of multiple indoor units in group operation sends/receives signals to/from the remote controllers and follower indoor units.
(*It has no relation with an indoor unit which communicates serially with the outdoor units.)
The operation mode and setup temperature range are displayed on the remote controller LCD. (Except air direction adjustment of louver)
- Follower unit (= 2) : Indoor units other than header unit in group operation
Basically, follower units do not send/receive signals to/from the remote controllers.
(Except trouble and response to demand of service data)
- Master unit (Representative unit) : This unit communicates with the indoor unit (sub) which serial-communicates with the outdoor units and sends/receives signal (Command from compressor) to/from the outdoor units as the representative of the cycle control in the indoor units of the identical line address within the minimum unit which configures one of the refrigerating cycles of Twin, Triple, Double twin.
- Sub unit (Subordinate unit) (Follower Twin) : Indoor units excluding the header unit in Twin, Triple, Double twin
This unit communicates with (Header) indoor unit in the identical line address and performs control synchronized with (Header) indoor unit.
This unit does not perform the signal send/receive operation with the outdoor units.:
N judgment for serial signal trouble.

9-2-1. System configuration

1. Single

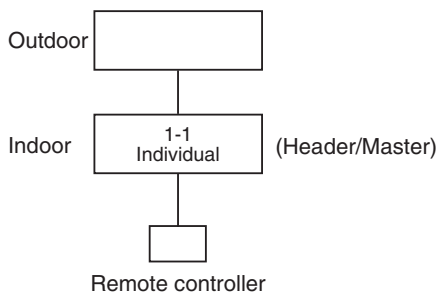

2. Twin

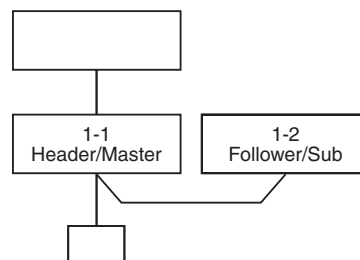

3. Triple

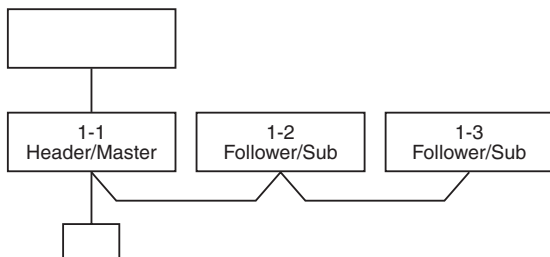

4. Double twin

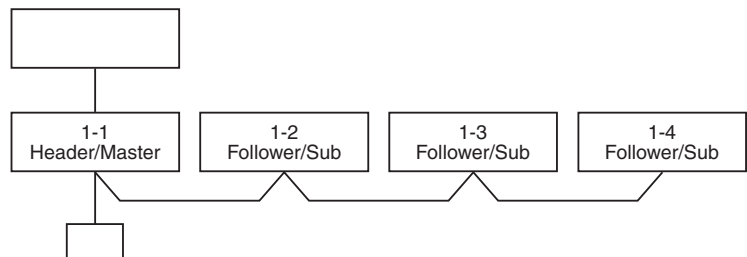

4. Single group operation

- Each indoor unit controls the outdoor unit individually.

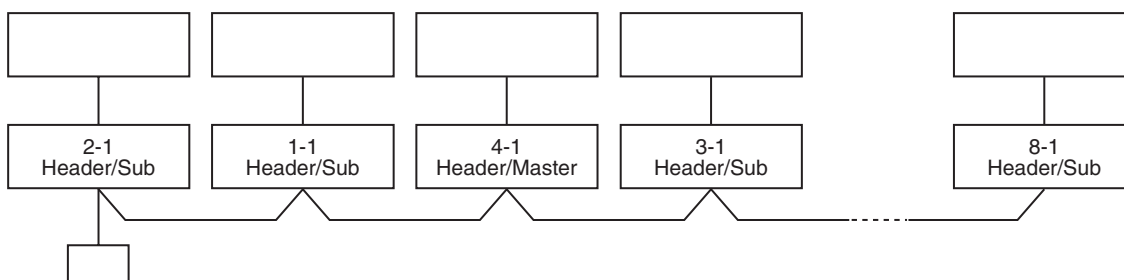

5. Multiple groups operation (Manual address setting)

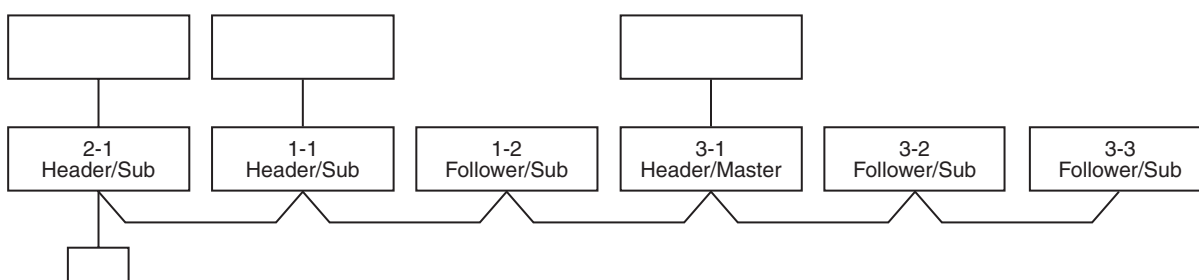

- Master unit: The master unit receives the indoor unit data (thermostat status) of the sub (Without identical line address & indoor/outdoor serial) and then finally controls the outdoor compressor matching with its own thermostat status. The master unit sends this command information to the sub unit.
- Sub unit: The sub unit receives the indoor unit data from the master (With identical line address & indoor/outdoor serial) and then performs the thermostat operation synchronized with the master unit. The sub unit sends own thermostat ON/OFF demand to the master unit.

(Example)

No. 1-1 master unit sends/receives signal to/from No. 1-2 and No. 1-3 sub units.
(It is not influenced by the line 2 or 3 address indoor unit.)

9-2-2. Automatic Address Example from Unset Address (No miswiring)

1. Standard (One outdoor unit)

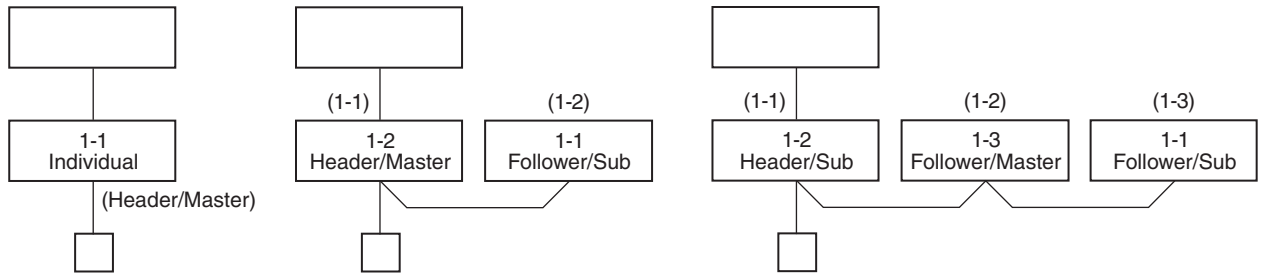

Only turning on source power supply (Automatic completion)

2. Group operation

(Multiple outdoor units = Multiple indoor units with serial communication only, without twin)

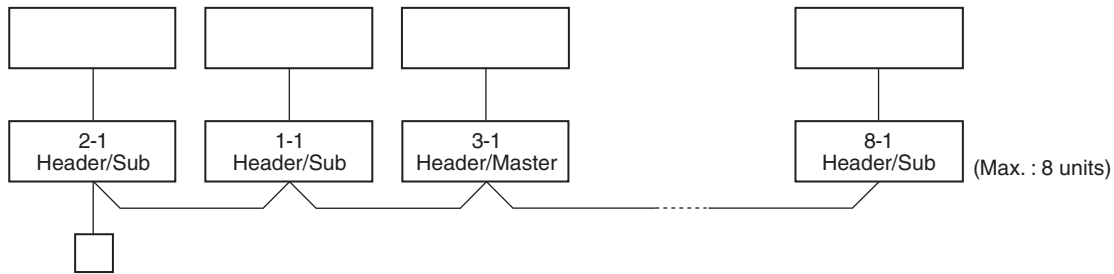

Only turning on source power supply (Automatic completion)

3. Multiple groups operation

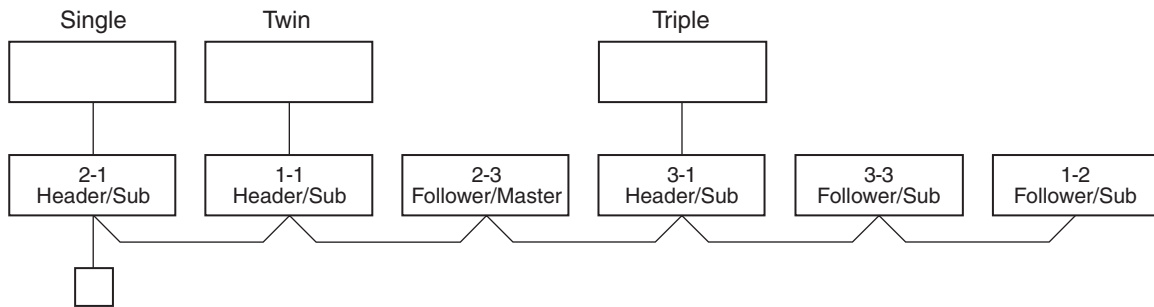

**Change is necessary
Manually change addresses of the multiple sub units
simultaneously from the remote controller.**

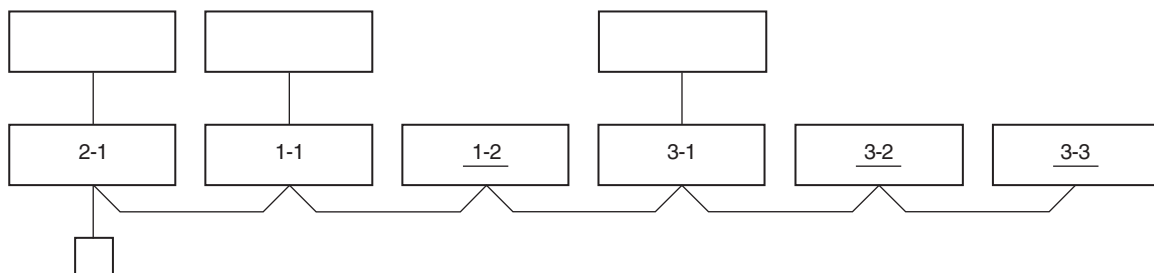

9-3. Address Setup (Manual Setting from Remote Controller)

In case that addresses of the indoor units will be determined prior to piping work after wiring work

- Set an indoor unit per a remote controller.
- Turn on power supply.

<Procedure>

1 Push the [MENU] button to display the menu screen.

2 Push and hold the [MENU] button and the [V] button at the same time to display the “Field setting menu”.

→ Push and hold the buttons for more than 4 seconds.

3 Push the [^] / [V] button to select “7. DN setting” on the “Field setting menu” screen, then push the “ Set ” [F2] button.

→ The fan and louver of the indoor unit operate.
When the group control is used, the fan and louver of the selected indoor unit operate.

(Line address)

→ Move the cursor to select “Code(DN)” with the “ < ” [F1] F1] button, then set “0012” with the [^] / [V] button.

→ Move the cursor to select “Data” with the “ > ” [F2] F2] button, then set **Line address** “Data” with the [^] / [V] button.

4 Push the [MENU] button to set the other Code(DN) and Data. After “Continue?” is displayed on the screen, push the “ Yes ” [F1] F1] button.

(Indoor address)

→ Move the cursor to select “Code(DN)” with the “ < ” [F1] F1] button, then set “0013” with the [^] / [V] button.

→ Move the cursor to select “Data” with the “ > ” [F2] F2] button, then set **Indoor address** “Data” with the [^] / [V] button.

5 Push the [MENU] button to set the other Code(DN) and Data. After “Continue?” is displayed on the screen, push the “ Yes ” [F1] F1] button.

(Group address)

→ Move the cursor to select “Code(DN)” with the “ < ” [F1] F1] button, then set “0014” with the [^] / [V] button.

→ Move the cursor to select “Data” with the “ > ” [F2] F2] button, then set “0001” to Header unit, and “0002” to Follower unit with the [^] / [V] button.

6 Push the [MENU] button to set the other Code(DN) and Data. After “Continue?” is displayed on the screen, push the “ No ” [F2] F2] button to finish the setting operation.

“ Setting ” appears on the screen for a while, then the screen returns to the “Field setting menu” screen.

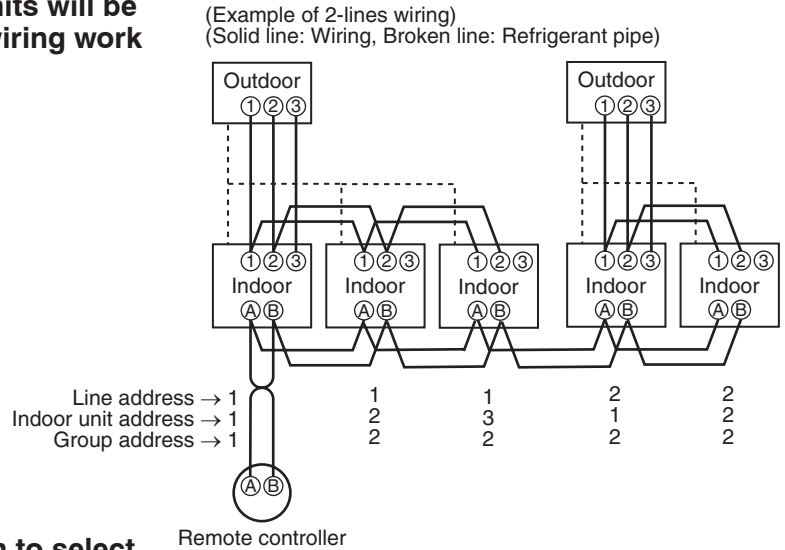

For the above example, perform setting by connecting singly the wired remote controller without remote controller inter-unit wire.

Group address
Individual : 0000
Header unit : 0001
Follower unit : 0002 } In case of group control

















9-4. Confirmation of Indoor Unit No. Position

Procedure to know the position of indoor unit body by address while indoor unit No. is known.

- Confirm each indoor unit address while indoor unit is stopped. (Be sure to stop air conditioner.)

<Procedure>

The position of indoor unit body by address

- 1 Push the [ MENU] button to display the menu screen.
- 2 Push and hold the [ MENU] button and the [ V] button at the same time to display the “Field setting menu”.
→ Push and hold the buttons for more than 4 seconds.
- 3 Push the [ ^] / [ V] button to select “7. DN setting” on the “Field setting menu” screen, then push the “  Set ” [ F2] button.
- 4 Push the “  Unit ” [ F1] button to confirm the address of indoor unit.
→ The selected unit changes as follows each time the button is pushed:

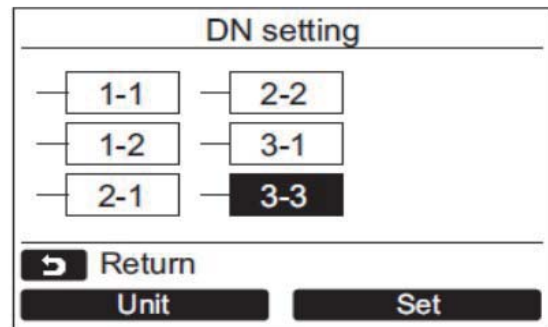
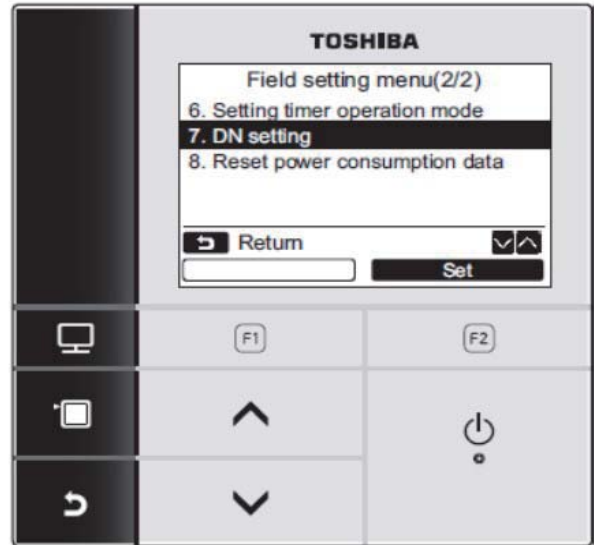
- 5 Push the “  Set ” [ F2] button.
→ The setting display for the selected unit appears.
→ When the group control is used, the fan and louver of the selected indoor unit operate.
- 6 Push the [ MENU] button to set the other Code(DN) and Data. After “Continue?” is displayed on the screen, push the “  No ” [ F2] button to finish the setting operation. “  Setting ” appears on the screen for a while, then the screen returns to the “Field setting menu” screen.

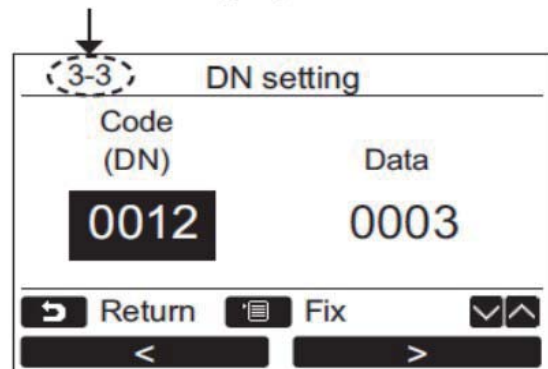

Address is displayed here.



10. MAINTENANCE/CHECK LIST

Aiming in environmental preservation, it is strictly recommended to clean and maintain the indoor/outdoor units of the operating air conditioning system regularly to secure effective operation of the air conditioner.

It is also recommended to maintain the units once a year regularly when operating the air conditioner for a long time.

Check periodically signs of rust or scratches, etc. on coating of the outdoor units.

Repair the trouble position or apply the rust resisting paint if necessary.

If an indoor unit operates for approx. 8 hours or more per day, usually it is necessary to clean the indoor/outdoor units once three months at least.

These cleaning and maintenance should be carried out by a qualified dealer.

Although the customer has to pay the charge for the maintenance, the life of the unit can be prolonged.

Failure to clean the indoor/outdoor units regularly will cause shortage of capacity, freezing, water leakage or trouble on the compressor.

Part name	Object		Contents of check	Contents of maintenance
	Indoor	Outdoor		
Heat exchanger	✓	✓	• Blocking with dust, damage check	• Clean it when blocking is found.
Fan motor	✓	✓	• Audibility for sound	• When abnormal sound is heard
Filter	✓	—	• Visual check for dirt and breakage	• Clean the filter with water or a vacuum cleaner. • Replace if any breakage
Fan	✓	✓	• Visual check for swing and balance • Check adhesion of dust and external appearance.	• Replace fan when swinging or balance is remarkably poor. • If a large dust adheres, clean it with brush or water.
Suction/ Discharge grille	✓	—	• Visual check for dirt and scratch	• Wipe off dirt with a soft cloth.
Drain pan	✓	—	• Check blocking by dust and dirt of drain water.	• Clean drain pan, Inclination check
Face panel, Louver	✓	—	• Check dirt and scratch.	• Cleaning/Coating with repair painting
External appearance	—	✓	• Check rust and peeling of insulator • Check peeling and floating of coating film	• Coating with repair painting
Refrigerant leak detection sensor	✓	—	• Is (Check indicator) on the remote controller flashing? . Does check code of J29, J30, or J31 appear on the remote controller?	• Contact the service man to have the refrigerant leak detection sensor checked.

11. DETACHMENTS

WARNING

Be sure to stop operation of the air conditioner before work and then turn off switch of the breaker.

CAUTION

Be sure to put on gloves during working time; otherwise an injury will be caused by a part etc.

1. Intake grille, Electrical parts box

<Procedure>

1. Unfasten two intake grille screws at the upper part of the intake grille to draw the intake grille toward you, and remove two strings that connect the intake grille to the unit to remove the intake grille while lifting it up.

* E-type retaining rings (E-ring) are provided with the intake grille screws to prevent the screw from coming off the grille. Unfasten the E-ring until it can be turned, and then open the grille.

2. Remove an electrical parts box equipped at bottom part of plate in following procedures.

• RM56, RM80

- 1) Remove the Screw 1 and Screw 2 from drip-proof cover on the bottom plate to remove the cover.
- 2) Remove the Screw 3 and Screw 4 from the electrical parts box cover to remove the cover.
- 3) Remove the connectors for Fan motor (7P) from CN210 (White).
- 4) Remove the connectors for louver motor (20P) from CN510 (White).
- 5) Remove the relay connector for remote controller.
- 6) Remove connectors for three temperature sensors (CN101 (Black), CN102 (Red), and CN104 (Yellow)) from the P.C. board.
- 7) Remove the indoor/outdoor communication wires from terminal block for power supply.
- 8) Remove the two screws that fix the electrical parts box to lower part of the cabinet, and slide the electrical parts box to the right to draw it toward you.

• RM110 to RM160

- 1) Remove the Screw 3 and Screw 4 from the electrical parts box cover, to remove the cover.
- 2) Remove the connectors for Fan motor (7P) from CN210 (White).
- 3) Remove the connectors for louver motor (20P) from CN510 (White).
- 4) Remove the relay connector for remote controller.
- 5) Remove connectors for three temperature sensors (CN101 (Black), CN102 (Red), and CN104 (Yellow)) from the P.C. board.
- 6) Remove the indoor/outdoor communication wires from terminal block for power supply.
- 7) Remove the two screws that fix the electrical parts box to lower part of the cabinet, and slide the electrical parts box to the right to draw it toward you.

* Drip-proof cover is equipped with only RM56 and RM80 models.

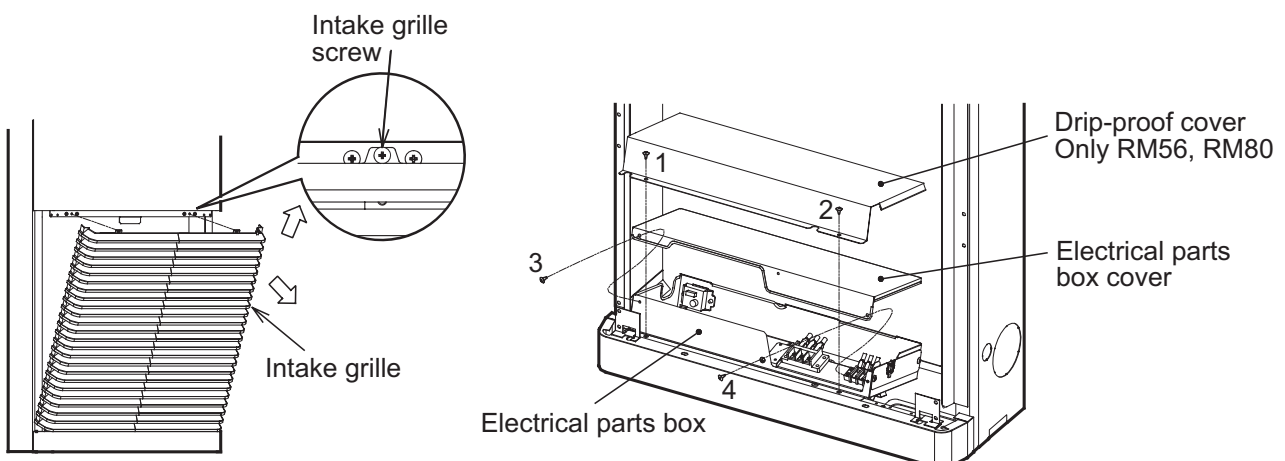

Position of Fan motor and Louver motor connectors

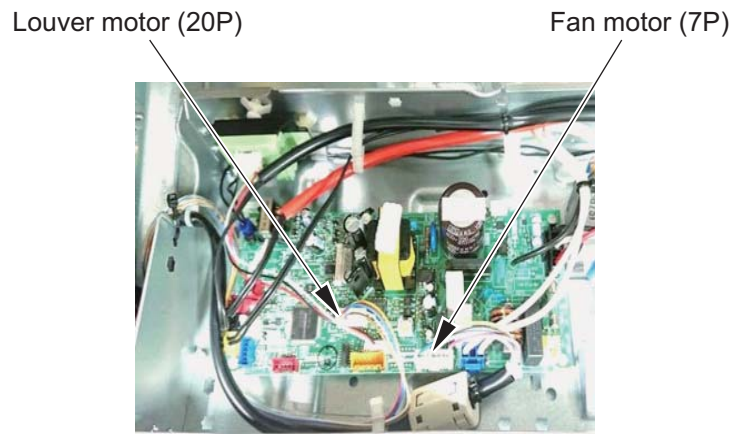

Position of Temperature sensors connectors

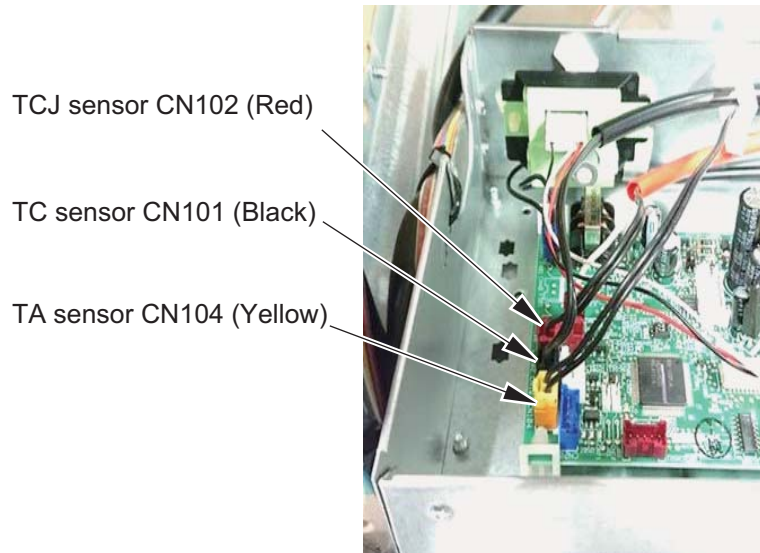

Position of Relay connectors for remote controller

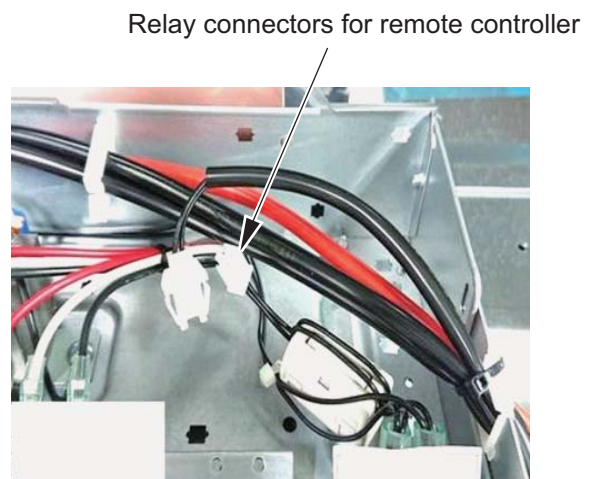

2. Heat exchanger

<Procedure>

1. Remove the intake grille.
2. Remove the two screws for the access panel, and after sliding the panel up about 30 mm, draw it toward you to remove it.

* E-type retaining rings (E-ring) are provided with the screws for access panel to prevent the screw from coming off the panel. Unfasten the E-ring until it can be turned, and then remove the panel.

3. Remove the heat exchanger assembly in front of you in following procedures.

• RM56, RM80

- 1) Remove the Screw 1 (four screws) that fixes the unit to the upper shield plate, and then draw the heat exchanger assembly toward you.
- 2) Remove the Screw 2 (two screws) on the heat exchanger to remove the upper shield plate.
- 3) Remove the Screw 3 (four screws) on the heat exchanger to remove the shield plate.
- 4) Remove two types of temperature sensor from the heat exchanger assembly to remove the heat exchanger assembly.

• RM110 to RM160

- 1) Remove the Screw 1 (three screws) that fixes the unit to the upper shield plate, and then draw the heat exchanger assembly toward you.
- 2) Remove the Screw 2 (two screws) on the heat exchanger to remove the upper shield plate.
- 3) Remove the Screw 3 (four screws) on the heat exchanger to remove the shield plate.
- 4) Remove two types of temperature sensor from the heat exchanger assembly to remove the heat exchanger assembly.

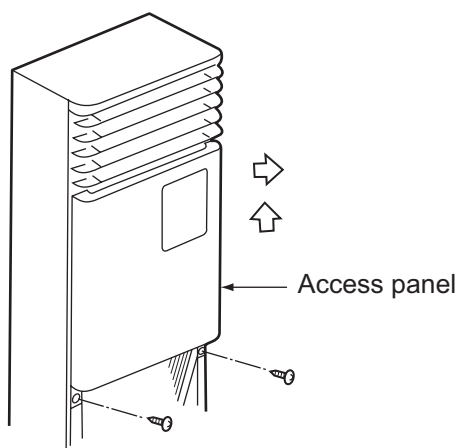

<RM56, RM80>

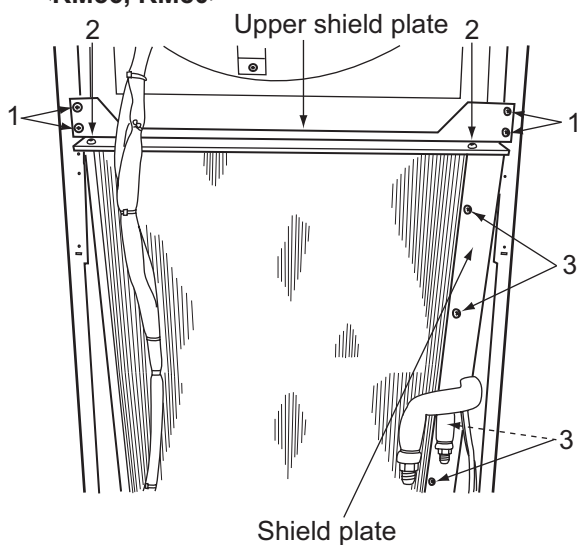

<RM110 to RM160>

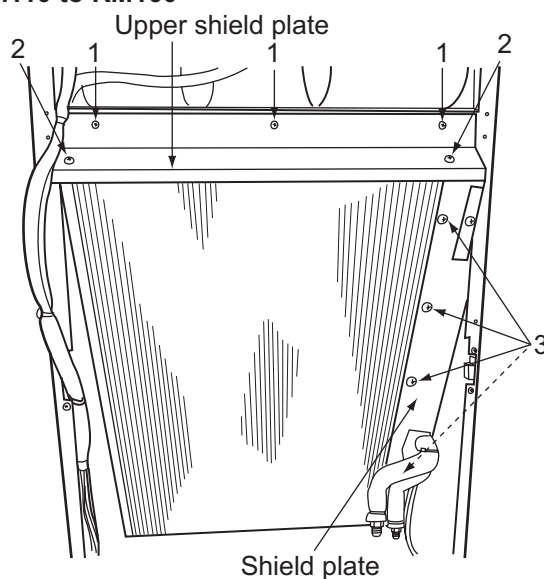

Position of temperature sensor

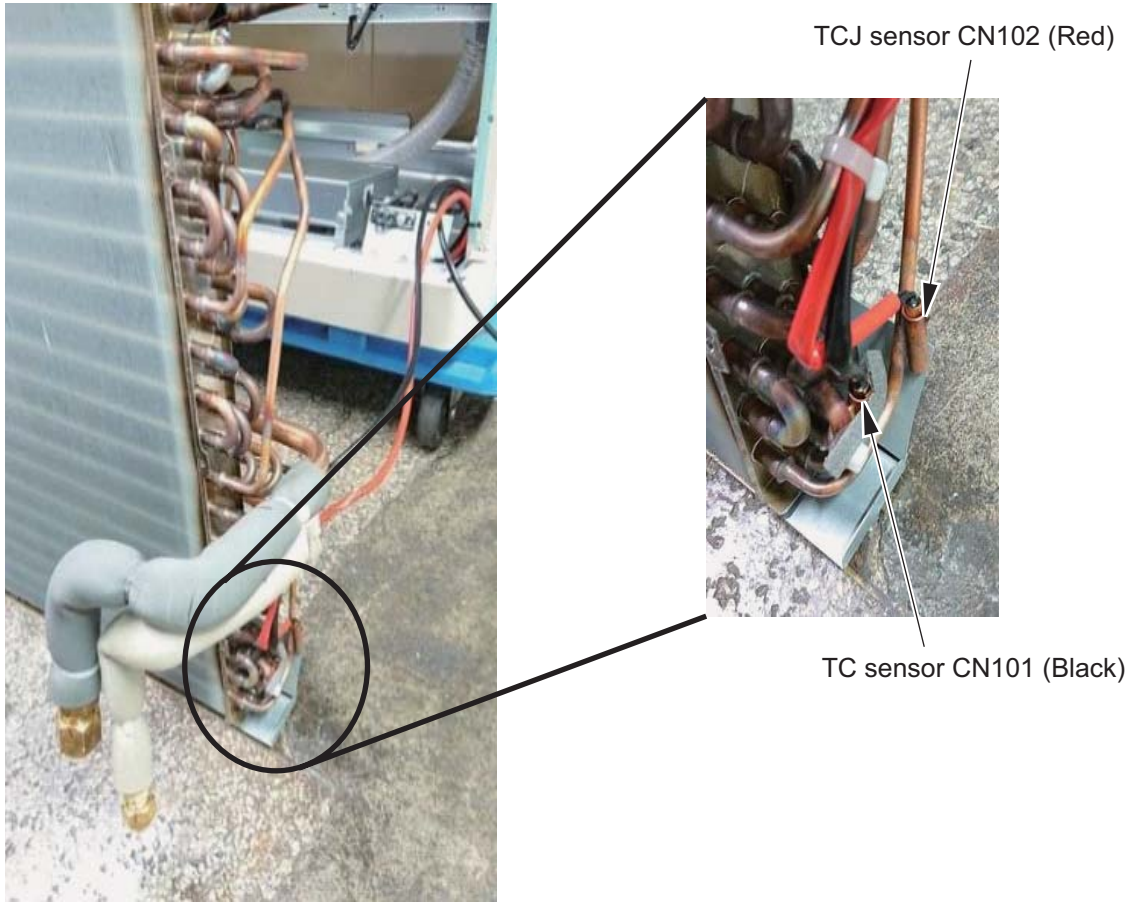

3. Fan, Fan motor

<Procedure>

1. Remove the intake grille.
2. Remove the access panel. (Carry out the work of item 2 of 2. Heat exchanger.)
3. Remove the fan in front of you in following procedures.

Note: Cut the binding band as shown in the pictures below before removing a fan.

Also, when a fan has been replaced, fix it into the place as before by the binding band.

• RM56, RM80

- 1) Remove the Screw 1 (five screws) that fixes the motor base.
- 2) Remove the fan (one screw) from the fan motor assembly.
- 3) Remove the Screw 3 (three screws) that fixes the fan motor from the motor base, and take out the fan motor.

• RM110 to RM160

- 1) Remove the Screw 1 (three screws) that fixes the shield plate to remove the shield plate.
- 2) Remove the Screw 2 (four screws) that fixes the motor base, and draw the fan with assembly toward you.
- 3) Remove the fan case (one side : three screws) from the motor base.
- 4) Remove the fan (one side : one screw) from the fan motor.
- 5) Remove the motor band from the fan motor to take out the fan motor.

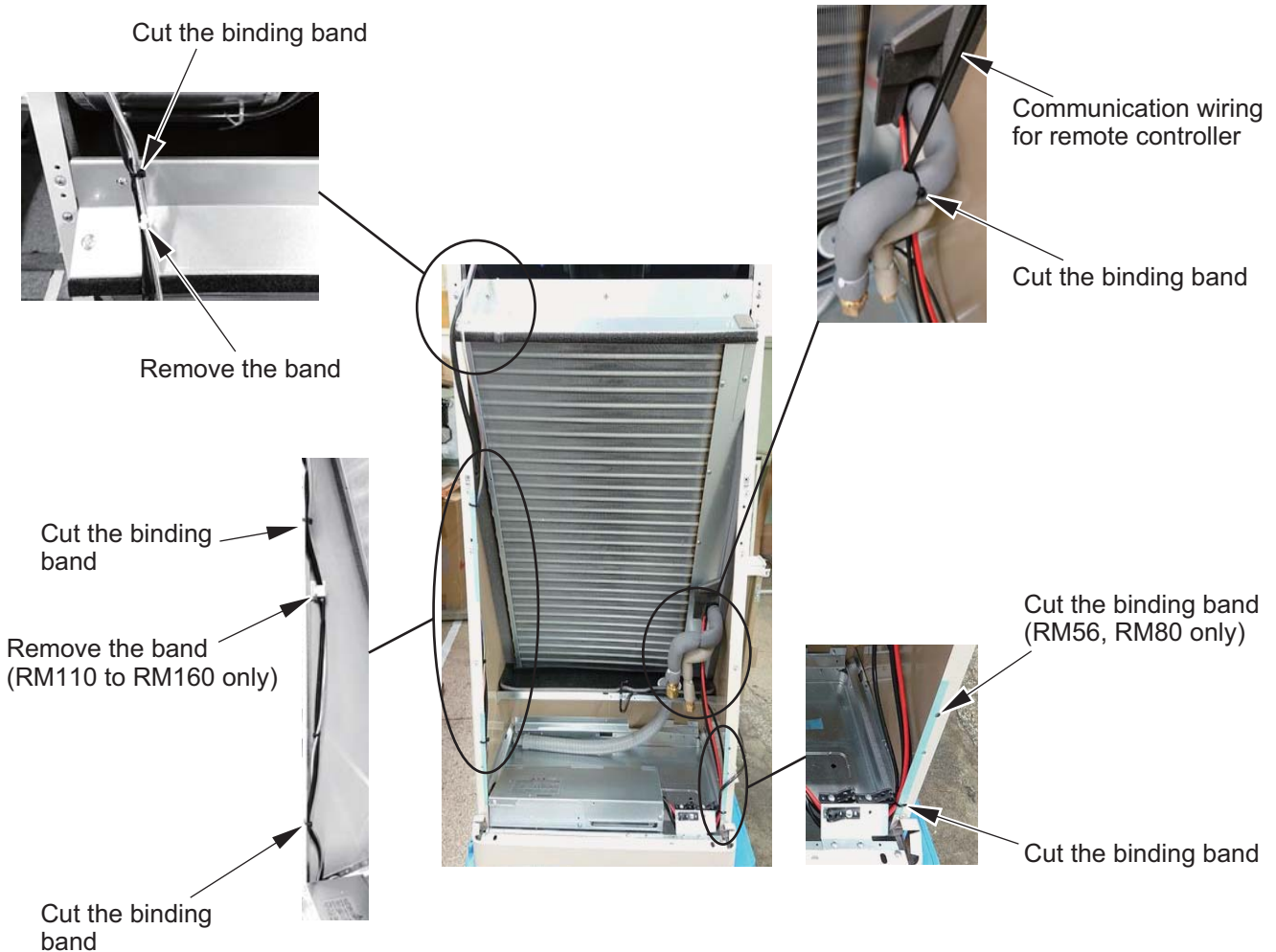

<RM56, RM80>

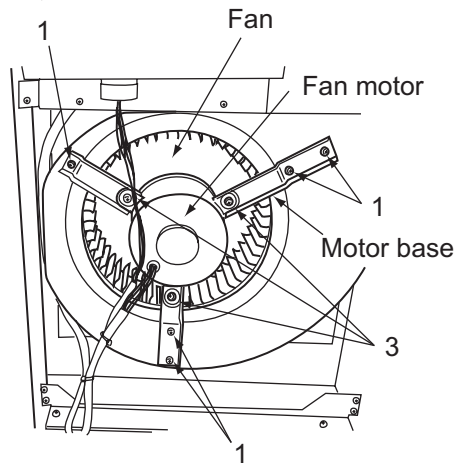

<RM56, RM80>

Exploded view of fan assembly

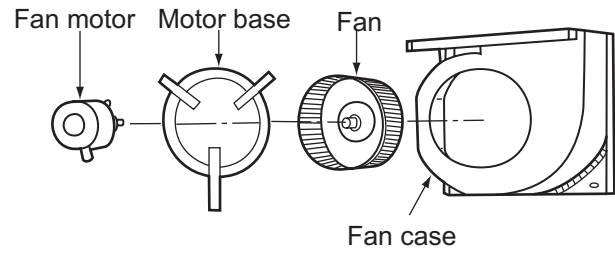

<RM110 to RM160>

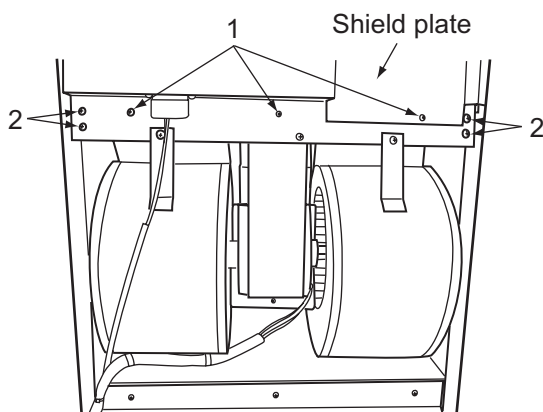

<RM110 to RM160>

Exploded view of fan assembly

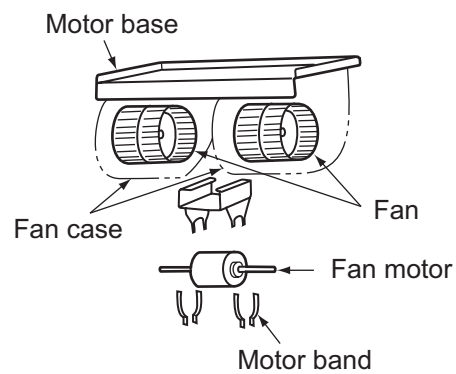

Note: After the fan has been replaced, pay attention to two followings to assemble each component.

1. After the fan was fixed, check that it turns smoothly without coming in contact with a fan case when turned by hand.
2. Check that fan blades on the fan are pointed toward the rotational direction as shown in figure below.

<RM56, RM80>

Details of the fan position

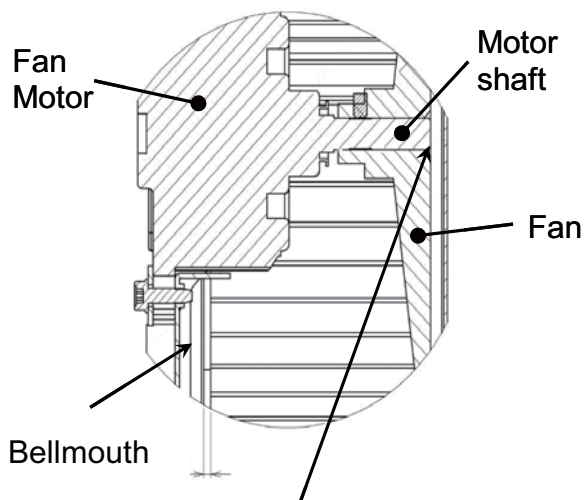

Fit the end face of motor shaft to the face of fan.
The gap between them shall be within $\pm 1\text{mm}$.

<RM110, RM160>

Details of the fan position

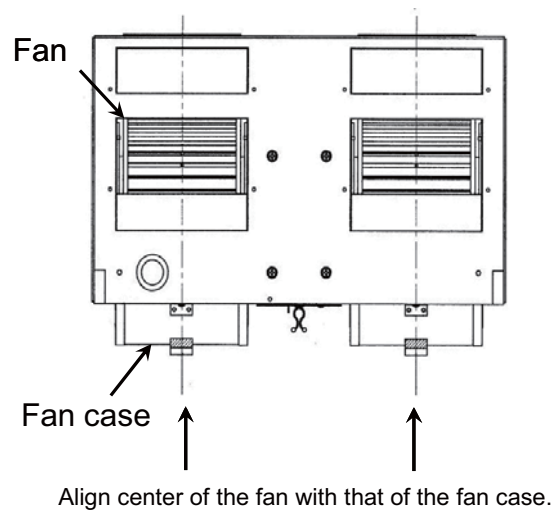

4. Horizontal louver

<Procedure>

1. Remove the intake grille and the access panel.
(Carry out the work of item 1 and 2 of **2. Heat exchanger**.)
2. Remove three screws that fixes the shield plate assembly to remove the shield plate assembly.
3. Remove two screws that fixes the discharge grille assembly. Draw the discharge grille toward you while lifting it upward slightly to remove it.
* Be careful not to lose the supporting plate.
4. Turn the horizontal louver in the vertical direction and draw it toward you to remove it from the discharge grille frame (ten places on both left and right).
5. Remove the horizontal louver from the center clamp. (five places at the center) (Lift the horizontal louver to diagonally upward.)
6. Remove the horizontal louver from the louver joint (five places).

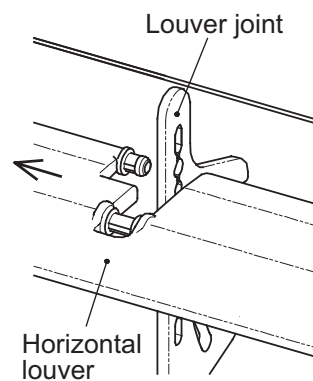
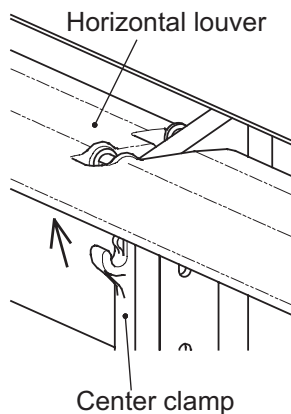
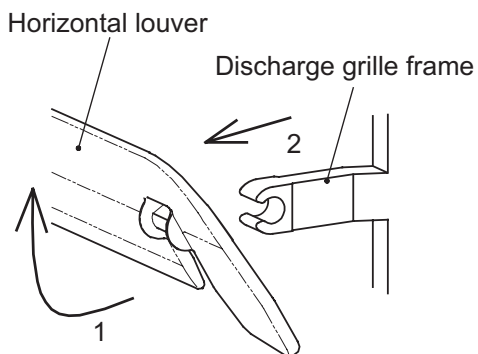
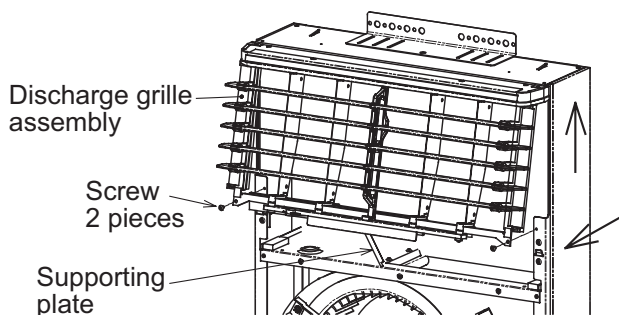
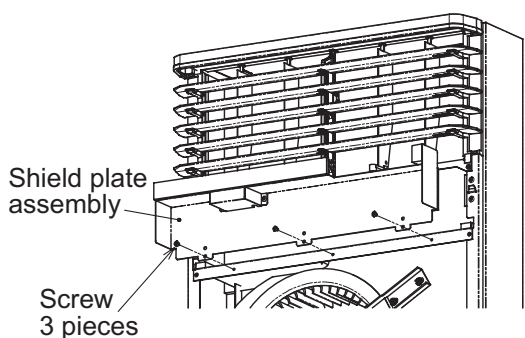

* Apply the grease to the receptor of axis (five places) when replacing the center clamp.
(Recommended grease : Shinetsu Silicone HIVAC-G)

5. Refrigerant leak detection sensor

<Procedure>

1. Remove an electrical parts box cover in the procedure of **1. Intake grille and Electrical parts box**.
2. Remove connector from the refrigerant leak detection sensor placed at the inner left corner of the electrical parts box.
3. Remove the sensor while pinching two nail tips on the spacer by needle-nose pliers.
 - * Push the refrigerant leak detection sensor until two nail tips on the spacer are locked with two holes on both side of the sensor when installing it.

Remove the connector

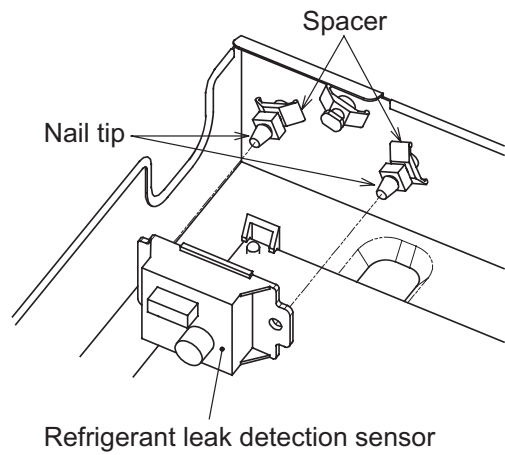
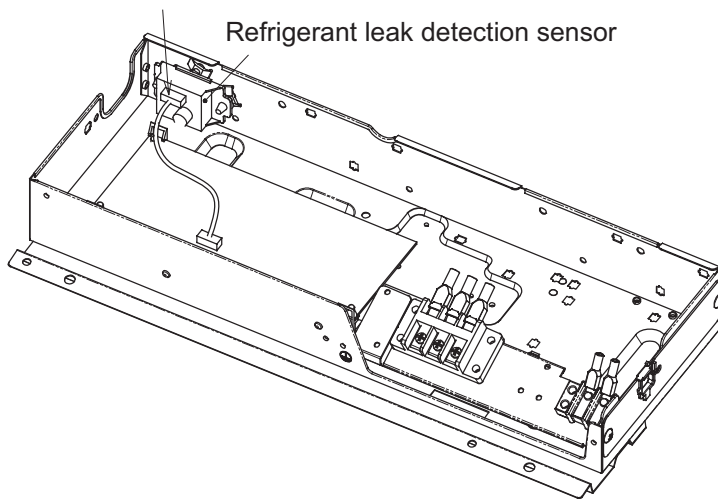

6. Remote controller

<Procedure>

1. Remove the intake grille and the access panel.
(Carry out the work of item 2 of **2. Heat exchanger**.)
2. Remove two screws that fix the insulation cover to remove remote controller assembly.
3. Cut the binding band that fixes wires, and use a flat-head screwdriver to draw remote controller body from four rectangular holes.
4. Remove two screws that fix back side cover of remote controller and unfasten two screws to remove wires connected to remote controller body.

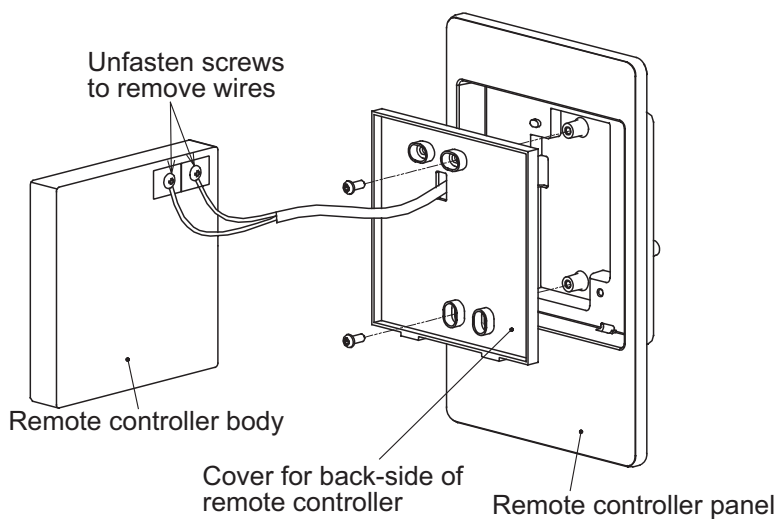
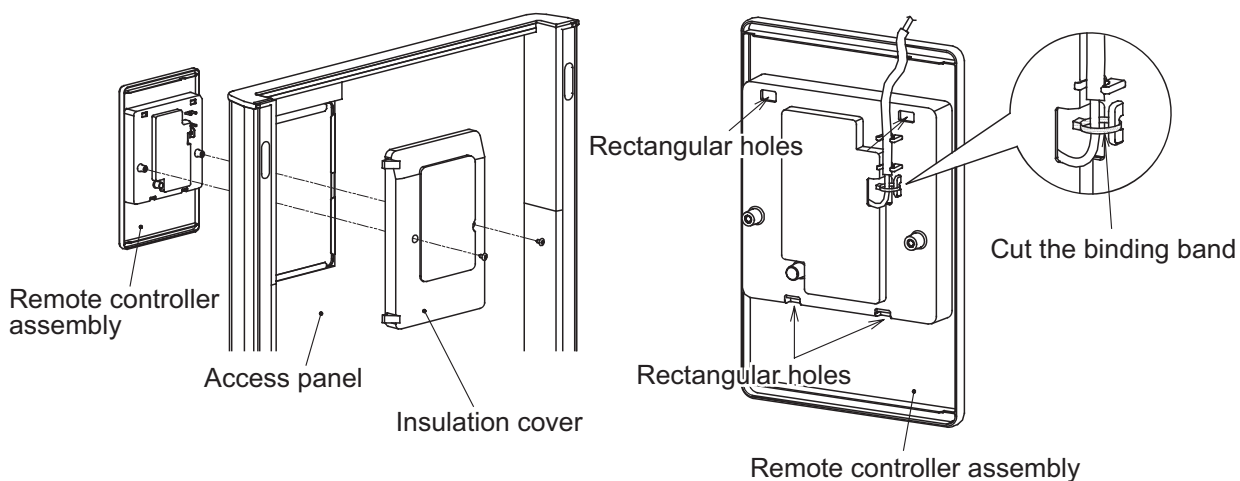

12. EXPLODED VIEWS AND PARTS LIST

1. RAV-RM561FT*, RM801FT*

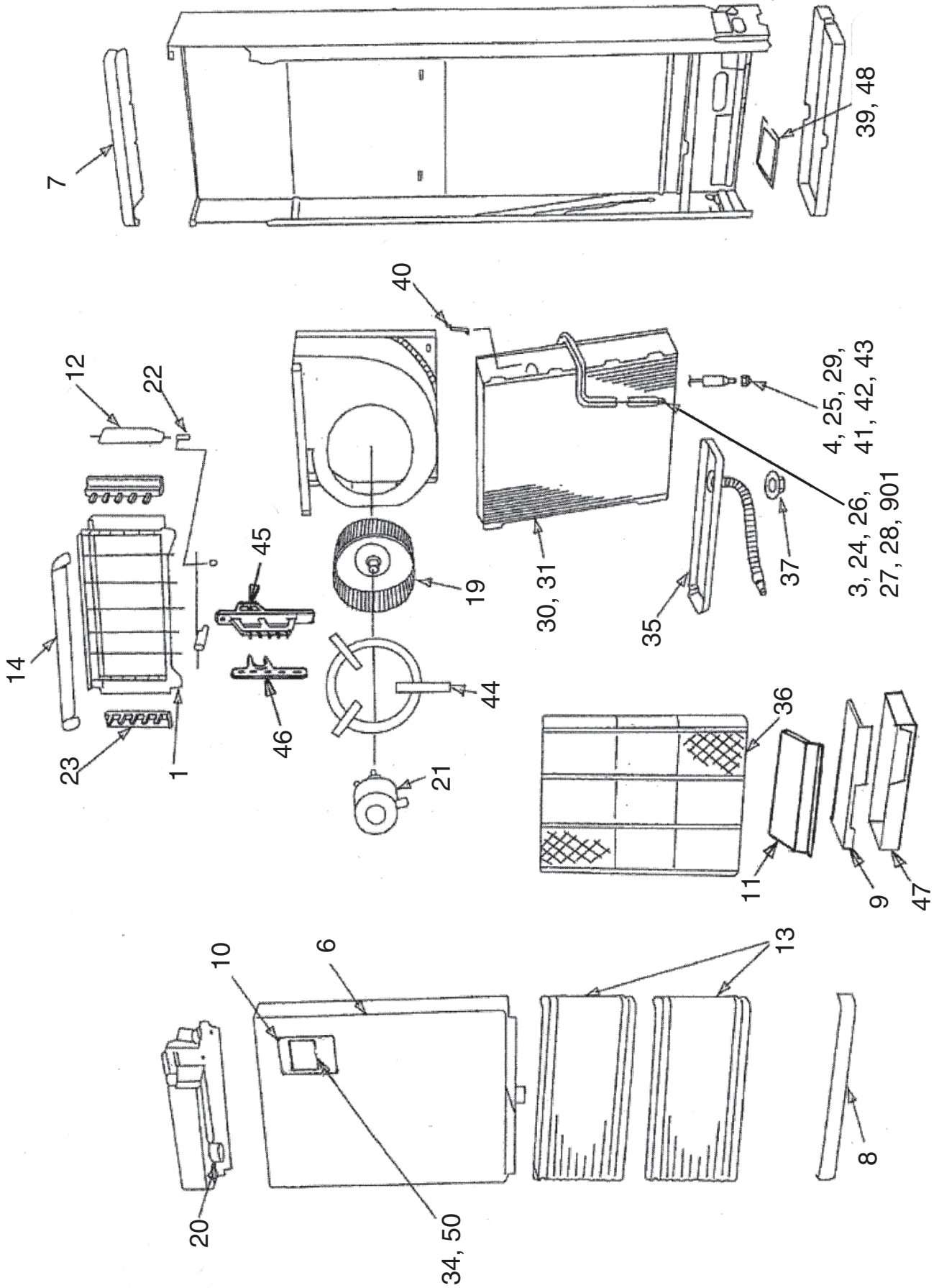

Location No.	Part No.	Description	Q'ty/Set RAV-RM					
			RM561FT -EN	RM561FT -ES	RM801FT -EN	RM801FT -ES	RM561FT -TR	RM801FT -TR
001	3759V024	GRILLE ASSY	1	1	1	1	1	1
003	43149501	NUT, FLARE, 1/2 IN	1	1			1	
004	43149498	SOCKET, 3/8 IN			1	1		1
006	4310A181	CABINET ASSY	1	1	1	1	1	1
007	43100367	CABINET, UPPER, ASSY	1	1	1	1	1	1
008	43100373	CABINET, LOWER	1	1	1	1	1	1
009	43162101	COVER, E-PARTS	1	1	1	1	1	1
010	43108040	PANEL, REMOTE CONTROLER	1	1	1	1	1	1
011	43162102	COVER ASSY	1	1	1	1	1	1
012	43109207	GRILLE, OUTLET, VERTICAL	4	4	4	4	4	4
013	43109456	GRILLE, INLET	2	2	2	2	2	2
014	43122193	LOUVER, HORIZONTAL	5	5	5	5	5	5
019	43120271	FAN, MULTI BLADE	1	1	1	1	1	1
020	43F2C076	MOTOR, LOUVER	1	1	1	1	1	1
021	4312C133	MOTOR, FAN, ICF-340D62-1	1	1	1	1	1	1
022	43139093	CONNECTION ROD	4	4	4	4	4	4
023	43109455	CLAMP, LOUVER	2	2	2	2	2	2
024	43147195	BONNET, 1/2 IN	1	1			1	
025	43149497	SOCKET, 1/4 IN	1	1			1	
026	43149495	NUT, FLARE, 5/8 IN			1	1		1
027	43149494	SOCKET, 1/2 IN	1	1			1	
028	43149496	SOCKET, 5/8 IN			1	1		1
029	43149500	NUT, FLARE, 3/8 IN			1	1		1
030	4314J605	REFRIGERATION CYCLE ASSY	1	1			1	
031	4314J606	REFRIGERATION CYCLE ASSY			1	1		1
034	43166036	REMOTE CONTROLLER, SX-P01BE	1		1		1	1
035	43172090	PAN, DRAIN	1	1	1	1	1	1
036	43180238	AIR FILTER	1	1	1	1	1	1
037	43197136	WASHER	1	1	1	1	1	1
039	431S8419	OWNERS MANUAL	1	1	1	1		
039	431S8420	OWNERS MANUAL					1	1
040	43F19904	HOLDER, SENSOR (TS)	2	2	2	2	2	2
041	43F47609	BONNET, 3/8 IN			1	1		1
042	43149499	NUT, FLARE, 1/4 IN	1	1			1	
043	43F49697	BONNET, 1/4 IN	1	1			1	
044	43122167	SUPPORTER, MOTOR	1	1	1	1	1	1
045	43122194	CLAMP, LOUVER, CENTER	1	1	1	1	1	1
046	43122195	JOINT, LOUVER	1	1	1	1	1	1
047	43161079	BOX, E-PARTS	1	1	1	1	1	1
048	431S8421	OWNERS MANUAL	1	1	1	1		
048	431S8422	OWNERS MANUAL					1	1
050	43166037	REMOTE CONTROLLER, SX-P02BE		1		1		

2. RAV-RM1101FT-EN/ES, RM1401FT-EN/ES, RM1601FT-EN/ES

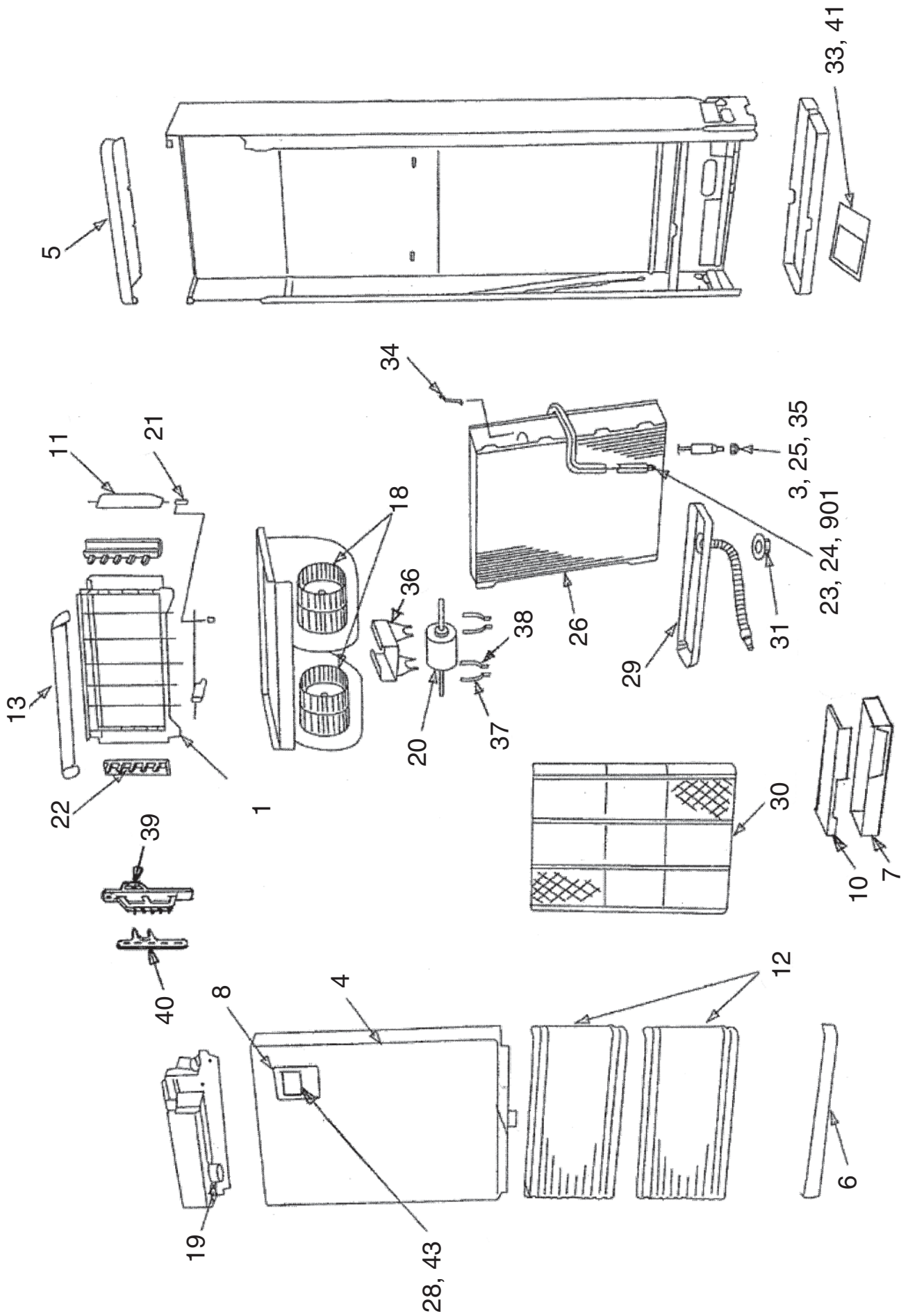

Location No.	Part No.	Description	Q'ty/Set RAV-RM					
			RM1101FT -EN	RM1101FT -ES	RM1401FT -EN	RM1401FT -ES	RM1601FT -EN	RM1601FT -ES
001	3759V024	GRILLE ASSY	1	1	1	1	1	1
003	43149498	SOCKET, 3/8 IN	1	1	1	1	1	1
004	4310A182	CABINET ASSY	1	1	1	1	1	1
005	43100368	CABINET, UPPER, ASSY	1	1	1	1	1	1
006	43100373	CABINET, LOWER	1	1	1	1	1	1
007	43161079	BOX, E-PARTS	1	1	1	1	1	1
008	43108040	PANEL, REMOTE CONTROLER	1	1	1	1	1	1
010	43162101	COVER, E-PARTS	1	1	1	1	1	1
011	43109207	GRILLE, OUTLET, VERTICAL	4	4	4	4	4	4
012	43109456	GRILLE, INLET	2	2	2	2	2	2
013	43122193	LOUVER, HORIZONTAL	5	5	5	5	5	5
018	43120272	FAN, MULTI BLADE	2	2	2	2	2	2
019	43F2C076	MOTOR, LOUVER	1	1	1	1	1	1
020	4312C134	MOTOR, FAN, ICF-340WD109-1	1	1	1	1	1	1
021	43139093	CONNECTION ROD	4	4	4	4	4	4
022	43109455	CLAMP, LOUVER	2	2	2	2	2	2
023	43149495	NUT, FLARE, 5/8 IN	1	1	1	1	1	1
024	43149496	SOCKET, 5/8 IN	1	1	1	1	1	1
025	43149500	NUT,FLARE, 3/8 IN	1	1	1	1	1	1
026	4314J607	REFRIGERATION CYCLE ASSY	1	1	1	1	1	1
028	43166036	REMOTE CONTROLLER, SX-P01BE	1		1		1	
029	43172090	PAN, DRAIN	1	1	1	1	1	1
030	43180238	AIR FILTER	1	1	1	1	1	1
031	43197136	WASHER	1	1	1	1	1	1
033	431S8419	OWNERS MANUAL	1	1	1	1	1	1
034	43F19904	HOLDER, SENSOR (TS)	2	2	2	2	2	2
035	43F47609	BONNET, 3/8 IN	1	1	1	1	1	1
036	43122168	SUPPORTER, MOTOR	1	1	1	1	1	1
037	43139154	BAND, MOTOR, LEFT	2	2	2	2	2	2
038	43139155	BAND, MOTOR, RIGHT	2	2	2	2	2	2
039	43122194	CLAMP, LOUVER, CENTER	1	1	1	1	1	1
040	43122195	JOINT, LOUVER	1	1	1	1	1	1
041	431S8421	OWNERS MANUAL	1	1	1	1	1	1
043	43166037	REMOTE CONTROLLER, SX-P02BE		1		1		1
901	43147194	BONNET, 5/8 IN	1	1	1	1	1	1

3. RAV-RM1101FT-TR, RM1401FT-TR, RM1601FT-TR

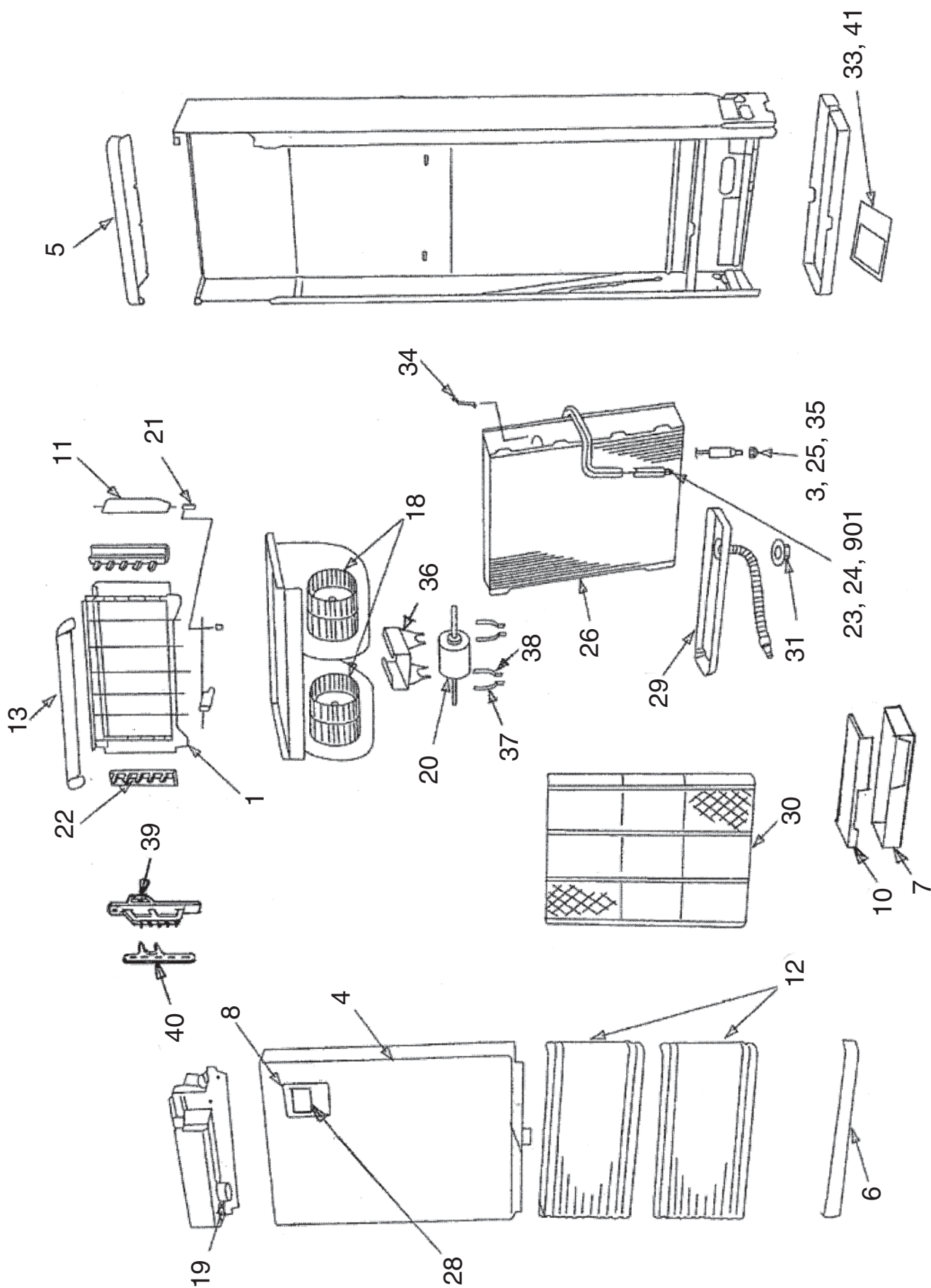

Location No.	Part No.	Description	Q'ty/Set RAV-RM		
			RM1101FT-TR	RM1401FT-TR	RM1601FT-TR
001	3759V024	GRILLE ASSY	1	1	1
003	43149498	SOCKET, 3/8 IN	1	1	1
004	4310A182	CABINET ASSY	1	1	1
005	43100368	CABINET, UPPER, ASSY	1	1	1
006	43100373	CABINET, LOWER	1	1	1
007	43161079	BOX, E-PARTS	1	1	1
008	43108040	PANEL, REMOTE CONTROLER	1	1	1
010	43162101	COVER, E-PARTS	1	1	1
011	43109207	GRILLE, OUTLET, VERTICAL	4	4	4
012	43109456	GRILLE, INLET	2	2	2
013	43122193	LOUVER, HORIZONTAL	5	5	5
018	43120272	FAN, MULTI BLADE	2	2	2
019	43F2C076	MOTOR, LOUVER	1	1	1
020	4312C134	MOTOR, FAN, ICF-340WD109-1	1	1	1
021	43139093	CONNECTION ROD	4	4	4
022	43109455	CLAMP, LOUVER	2	2	2
023	43149495	NUT, FLARE, 5/8 IN	1	1	1
024	43149496	SOCKET, 5/8 IN	1	1	1
025	43149500	NUT,FLARE, 3/8 IN	1	1	1
026	4314J607	REFRIGERATION CYCLE ASSY	1	1	1
028	43166036	REMOTE CONTROLLER, SX-P01BE	1	1	1
029	43172090	PAN, DRAIN	1	1	1
030	43180238	AIR FILTER	1	1	1
031	43197136	WASHER	1	1	1
033	431S8420	OWNERS MANUAL	1	1	1
034	43F19904	HOLDER, SENSOR (TS)	2	2	2
035	43F47609	BONNET, 3/8 IN	1	1	1
036	43122168	SUPPORTER, MOTOR	1	1	1
037	43139154	BAND, MOTOR, LEFT	2	2	2
038	43139155	BAND, MOTOR, RIGHT	2	2	2
039	43122194	CLAMP, LOUVER, CENTER	1	1	1
040	43122195	JOINT, LOUVER	1	1	1
041	431S8422	OWNERS MANUAL	1	1	1
901	43147194	BONNET, 5/8 IN	1	1	1

4. Electrical parts

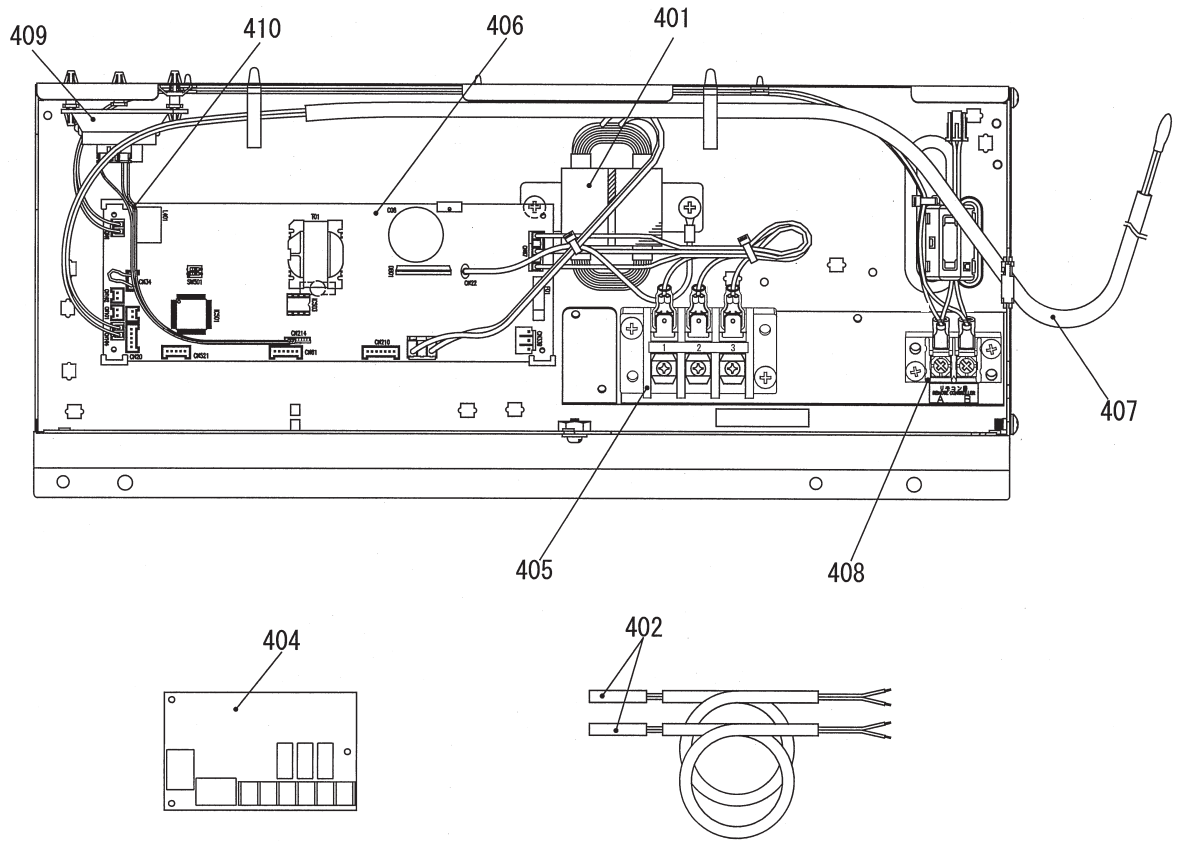

Location No.	Part No.	Description	Q'ty/Set All model common
401	44258091	REACTOR, CH-49-Z-T	1
402	43050425	SENSOR ASSY, SERVICE, TC, TCJ	2
404	43459017	PC BOARD ASSY, TCB-PCUC*E	1
405	43160565	TERMINAL BLOCK, 3P, 20A	1
406	4316V721	PC BOARD ASSY, MCC-1643	1
407	43F50426	SENSOR, SERVICE, TA	1
408	43160692	TERMINAL, 2P	1
409	4316V712	R32 SENSING MODULE, FIS5084-T1C1	1
410	43160693	HOUSING ASSY, SENSOR	1

Toshiba Carrier Corporation

72-34 Horikawa-cho, Saiwai-ku, Kawasaki-shi, Kanagawa 212-8585, JAPAN

Copyright © 2019 TOSHIBA CARRIER CORPORATION, ALL Rights Reserved.