

TOSHIBA

FILE NO. SVM-16046-2

SERVICE MANUAL

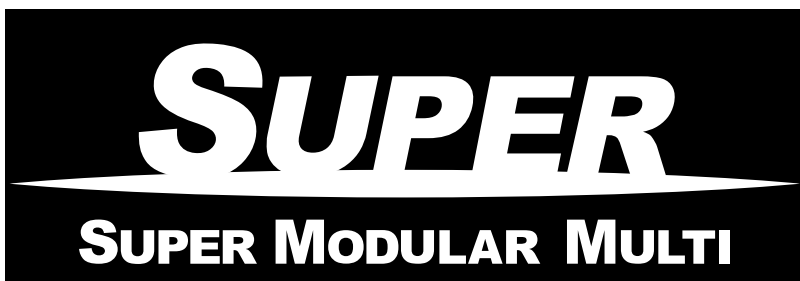

<High Wall Type>

MMK-AP0073HP1-E1 (TR1)

MMK-AP0093HP1-E1 (TR1)

MMK-AP0123HP1-E1 (TR1)

MMK-AP0153HP1-E1 (TR1)

MMK-AP0183HP1-E1 (TR1)

MMK-AP0243HP1-E1 (TR1)









- This Service Manual describes contents of the new High Wall indoor unit.
For the outdoor unit, refer to the Manual with FILE NO. A03-009, A05-004, A05-015.
- The service parts will be supplied by TCTC.









CONTENTS



SAFETY CAUTION	3
1. CONSTRUCTION VIEWS (EXTERNAL VIEWS).....	8
2. WIRING DIAGRAM	9
3. PARTS RATING	10
4. REFRIGERATING CYCLE DIAGRAM	60
5. CONTROL OUTLINE	61
6. APPLIED CONTROL	68
7. TROUBLESHOOTING	75
8. CONFIGURATION OF CONTROL CIRCUIT	149
9. HOW TO REPLACE MAIN PARTS.....	151
10. REPLACEMENT OF SERVICE INDOOR P.C. BOARD	159
11. EXPLODED VIEWS AND PARTS LIST	164

SAFETY CAUTION

The important contents concerned to the safety are described on the product itself and on this Service Manual. Please read this Service Manual after understanding the described items thoroughly in the following contents, and keep them.

 WARNING	
 Check earth wires.	Before troubleshooting or repair work, check the earth wire is connected to the earth terminals of the main unit, otherwise an electric shock is caused when a leak occurs. If the earth wire is not correctly connected, contact an electric engineer for rework.
 Prohibition of modification.	Do not modify the products. Do not also disassemble or modify the parts. It may cause a fire, electric shock or injury.
 Use specified parts.	For spare parts, use those specified (*). If unspecified parts are used, a fire or electric shock may be caused. *: For details, refer to the parts list.
 Do not bring a child close to the equipment.	Before troubleshooting or repair work, do not bring a third party (a child, etc.) except the repair engineers close to the equipment. It causes an injury with tools or disassembled parts. Please inform the users so that the third party (a child, etc.) does not approach the equipment.
 Insulating measures	Connect the cut-off lead cables with crimp contact, etc, put the closed end side upward and then apply a water-cut method, otherwise a leak or production of fire is caused at the users' side.
 No fire	When repairing the refrigerating cycle, take the following measures. 1) Be attentive to fire around the cycle. When using a gas stove, etc, be sure to put out fire before work; otherwise the oil mixed with refrigerant gas may catch fire. 2) Do not use a welder in the closed room. When using it without ventilation, carbon monoxide poisoning may be caused. 3) Do not bring inflammables close to the refrigerant cycle, otherwise fire of the welder may catch the inflammables.
 Refrigerant	Check the used refrigerant name and use tools and materials of the parts which match with it. For the products which use R410A refrigerant, the refrigerant name is indicated at a position on the outdoor unit where is easy to see. To prevent miss-charging, the route of the service port is changed from one of the former R22. For an air conditioner which uses R410A, never use other refrigerant than R410A. For an air conditioner which uses other refrigerant (R22, etc.), never use R410A. If different types of refrigerant are mixed, abnormal high pressure generates in the refrigerating cycle and an injury due to breakage may be caused. Do not charge refrigerant additionally. If charging refrigerant additionally when refrigerant gas leaks, the refrigerant composition in the refrigerating cycle changes resulted in change of air conditioner characteristics or refrigerant over the specified standard amount is charged and an abnormal high pressure is applied to the inside of the refrigerating cycle resulted in cause of breakage or injury. Therefore if the refrigerant gas leaks, recover the refrigerant in the air conditioner, execute vacuuming, and then newly recharge the specified amount of liquid refrigerant. In this time, never charge the refrigerant over the specified amount. When recharging the refrigerant in the refrigerating cycle, do not mix the refrigerant or air other than R410A into the specified refrigerant. If air or others is mixed with the refrigerant, abnormal high pressure generates in the refrigerating cycle resulted in cause of injury due to breakage. After installation work, check the refrigerant gas does not leak. If the refrigerant gas leaks in the room, poisonous gas generates when gas touches to fire such as fan heater, stove or cooking stove though the refrigerant gas itself is innocuous. Never recover the refrigerant into the outdoor unit. When the equipment is moved or repaired, be sure to recover the refrigerant with recovering device. The refrigerant cannot be recovered in the outdoor unit; otherwise a serious accident such as breakage or injury is caused.

 WARNING	
 Assembly/Cabling	<p>After repair work, surely assemble the disassembled parts, and connect and lead the removed cables as before. Perform the work so that the cabinet or panel does not catch the inner cables.</p> <p>If incorrect assembly or incorrect cable connection was done, a disaster such as a leak or fire is caused at user's side.</p>
 Insulator check	<p>After the work has finished, be sure to use an insulation tester set (500V megger) to check the resistance is 2MW or more between the charge section and the non-charge metal section (Earth position).</p> <p>If the resistance value is low, a disaster such as a leak or electric shock is caused at user's side.</p>
 Ventilation	<p>When the refrigerant gas leaks during work, execute ventilation.</p> <p>If the refrigerant gas touches to a fire, poisonous gas generates. A case of leakage of the refrigerant and the closed room full with gas is dangerous because a shortage of oxygen occurs. Be sure to execute ventilation.</p>
 Be attentive to electric shock	<p>When checking the circuit inevitably under condition of the power-ON, use rubber gloves and others not to touch to the charging section.</p> <p>If touching to the charging section, an electric shock may be caused.</p>
 Compulsion	<p>When the refrigerant gas leaks, find up the leaked position and repair it surely.</p> <p>If the leaked position cannot be found up and the repair work is interrupted, pump-down and tighten the service valve, otherwise the refrigerant gas may leak into the room.</p> <p>The poisonous gas generates when gas touches to fire such as fan heater, stove or cooking stove though the refrigerant gas itself is innocuous.</p> <p>When installing equipment which includes a large amount of charged refrigerant such as a multi air conditioner in a sub-room, it is necessary that the density does not the limit even if the refrigerant leaks.</p> <p>If the refrigerant leaks and exceeds the limit density, an accident of shortage of oxygen is caused.</p> <p>For the installation/moving/reinstallation work, follow to the Installation Manual.</p> <p>If an incorrect installation is done, a trouble of the refrigerating cycle, water leak, electric shock or fire is caused.</p>
 Check after repair	<p>After repair work has finished, check there is no trouble.</p> <p>If check is not executed, a fire, electric shock or injury may be caused. For a check, turn off the power breaker.</p> <p>After repair work (installation of front panel and cabinet) has finished, execute a test run to check there is no generation of smoke or abnormal sound.</p> <p>If check is not executed, a fire or an electric shock is caused. Before test run, install the front panel and cabinet.</p>
 Check after reinstallation	<p>Check the following items after reinstallation.</p> <ol style="list-style-type: none"> 1) The earth wire is correctly connected. 2) The power cord is not caught in the product. 3) There is no inclination or unsteadiness and the installation is stable. <p>If check is not executed, a fire, an electric shock or an injury is caused.</p>

 CAUTION	
 Put on gloves	<p>Be sure to put on gloves (*) and long-sleeved shirt during repair work.</p> <p>If not putting on gloves, an injury may be caused with the parts, etc.</p> <p>(*) Heavy gloves such as work gloves</p>
 Cooling check	<p>When the power was turned on, start to work after the equipment has been sufficiently cooled.</p> <p>As temperature of the compressor pipes and others became high due to cooling/heating operation, a burn may be caused.</p>

• New Refrigerant (R410A)

This air conditioner adopts a new HFC type refrigerant (R410A) which does not deplete the ozone layer.

1. Safety Caution Concerned to New Refrigerant

The pressure of R410A is high 1.6 times of that of the former refrigerant (R22).

Accompanied with change of refrigerant, the refrigerating oil has been also changed.

Therefore, be sure that water, dust, the former refrigerant or the former refrigerating oil is not mixed into the refrigerating cycle of the air conditioner with new refrigerant during installation work or service work.

If an incorrect work or incorrect service is performed, there is a possibility to cause a serious accident.

Use the tools and materials exclusive to R410A to purpose a safe work.

2. Cautions on Installation/Service

(1) Do not mix the other refrigerant or refrigerating oil.

For the tools exclusive to R410A, shapes of all the joints including the service port differ from those of the former refrigerant in order to prevent mixture of them.

(2) As the use pressure of the new refrigerant is high, use material thickness of the pipe and tools which are specified for R410A.

(3) In the installation time, use clean pipe materials and work with great attention so that water and others do not mix in because pipes are affected by impurities such as water, oxide scales, oil, etc.

Use the clean pipes.

Be sure to brazing with flowing nitrogen gas. (Never use gas other than nitrogen gas.)

(4) For the earth protection, use a vacuum pump for air purge.

(5) R410A refrigerant is azeotropic mixture type refrigerant.

Therefore use liquid type to charge the refrigerant. (If using gas for charging, composition of the refrigerant changes and then characteristics of the air conditioner change.)

3. Pipe Materials

For the refrigerant pipes, copper pipe and joints are mainly used.

It is necessary to select the most appropriate pipes to conform to the standard.

Use clean material in which impurities adhere inside of pipe or joint to a minimum.

(1) Copper pipe

<Piping>

The pipe thickness, flare finishing size, flare nut and others differ according to a refrigerant type.

When using a long copper pipe for R410A, it is recommended to select "Copper or copper-base pipe without seam" and one with bonded oil amount 40mg/10m or less.

Also do not use crushed, deformed, discolored (especially inside) pipes. (Impurities cause clogging of expansion valves and capillary tubes.)

<Flare nut>

Use the flare nuts which are attached to the air conditioner unit.

(2) Joint

The flare joint and socket joint are used for joints of the copper pipe.

The joints are rarely used for installation of the air conditioner.

However clear impurities when using them.

4. Tools

(1) Required Tools for R410A

Mixing of different types of oil may cause a trouble such as generation of sludge, clogging of capillary, etc. Accordingly, the tools to be used are classified into the following three types.

- 1) Tools exclusive for R410A (Those which cannot be used for conventional refrigerant (R22))
- 2) Tools exclusive for R410A, but can be also used for conventional refrigerant (R22)
- 3) Tools commonly used for R410A and for conventional refrigerant (R22)

The table below shows the tools exclusive for R410A and their interchangeability.

Tools exclusive for R410A (The following tools for R410A are required.)

Tools whose specifications are changed for R410A and their interchangeability

No.	Used tool	Usage	R410A air conditioner installation		Conventional air conditioner installation
			Existence of new equipment for R410A	Whether conventional equipment can be used	Whether new equipment can be used with conventional refrigerant
①	Flare tool	Pipe flaring	Yes	*(Note 1)	Yes
②	Copper pipe gauge for adjusting projection margin	Flaring by conventional flare tool	Yes	*(Note 1)	*(Note 1)
③	Torque wrench	Connection of flare nut	Yes	No	No
④	Gauge manifold	Evacuating, refrigerant charge, run check, etc.	Yes	No	No
⑤	Charge hose				
⑥	Vacuum pump adapter	Vacuum evacuating	Yes	No	Yes
⑦	Electronic balance for refrigerant charging	Refrigerant charge	Yes	Yes	Yes
⑧	Leakage detector	Gas leakage check	Yes	No	Yes
⑨	Charging cylinder	Refrigerant charge	(Note 2)	No	No

(Note 1) When flaring is carried out for R410A using the conventional flare tools, adjustment of projection margin is necessary. For this adjustment, a copper pipe gauge, etc. are necessary.

(Note 2) Charging cylinder for R410A is being currently developed.

General tools (Conventional tools can be used.)

In addition to the above exclusive tools, the following equipments which serve also for R22 are necessary as the general tools.

- 1) Vacuum pump
Use vacuum pump by attaching vacuum pump adapter.
- 2) Torque wrench
- 3) Pipe cutter
- 4) Reamer
- 5) Pipe bender
- 6) Level vial
- 7) Screwdriver (+, -)
- 8) Spanner or Monkey wrench
- 9) Hole core drill
- 10) Hexagon wrench (Opposite side 4mm)
- 11) Tape measure
- 12) Metal saw

Also prepare the following equipments for other installation method and run check.

- 1) Clamp meter
- 2) Thermometer
- 3) Insulation resistance tester
- 4) Electroscopes

5. Recharge of Refrigerant

When recharge of the refrigerant is required, charge the new refrigerant with the specified amount in the procedure as described below.

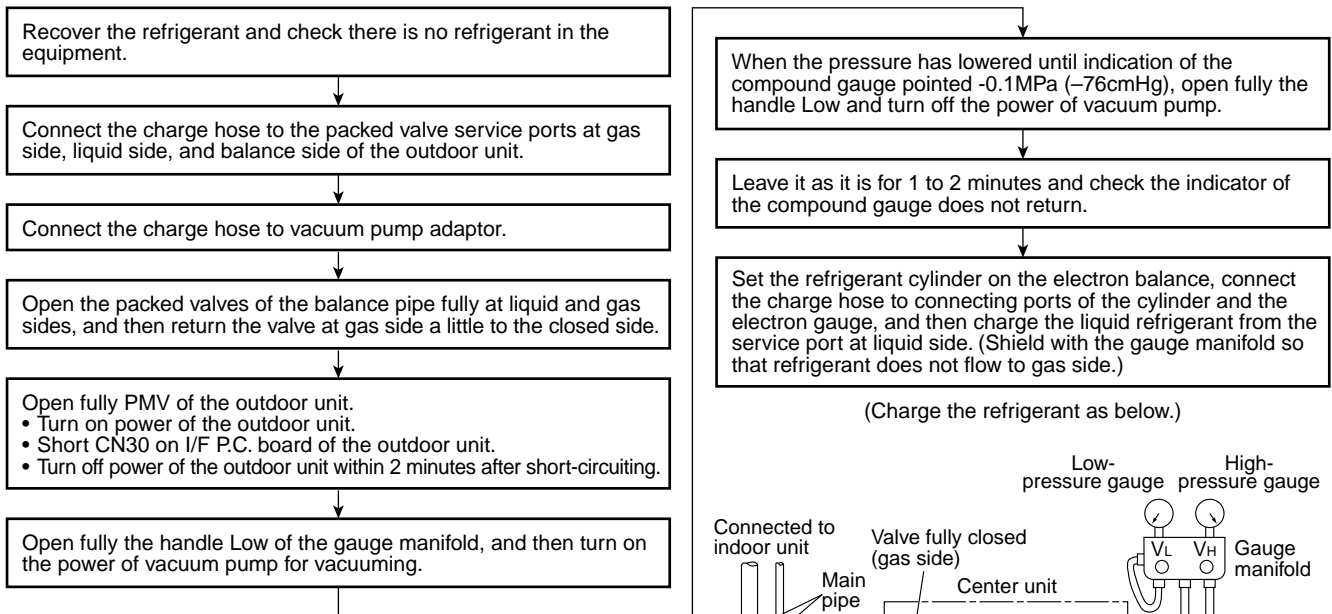

- 1) Never charge the refrigerant over the specified amount.
- 2) Do not charge the additional refrigerant. If charging refrigerant additionally when refrigerant gas leaks, the refrigerant composition in the refrigerating cycle changes resulted in change of air conditioner characteristics or refrigerant over the specified standard amount is charged and an abnormal high pressure is applied to the inside of the refrigerating cycle resulted in cause of breakage or injury.

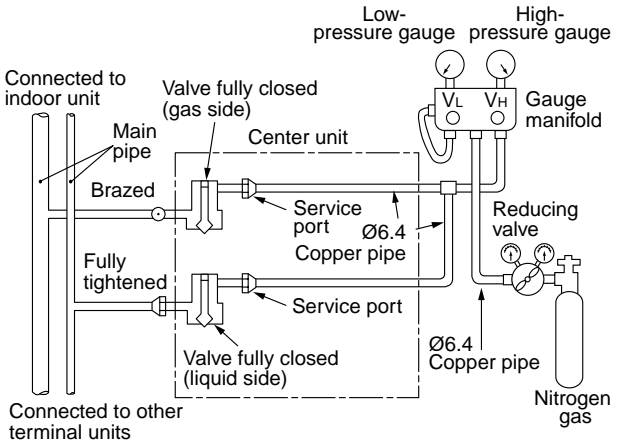

4mm-hexagonal wrench is required.

- 1) Set the equipment so that liquid refrigerant can be charged.
- 2) When using a cylinder with siphon pipe, liquid can be charged without inverting the cylinder.

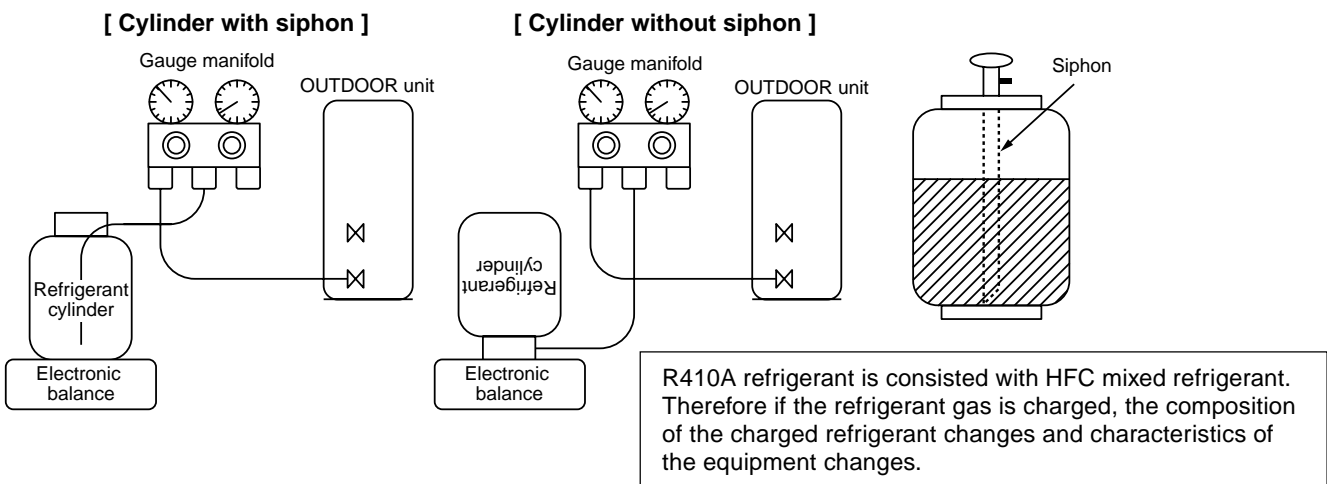

6. Environment

Use "Vacuum pump method" for an air purge (Discharge of air in the connecting pipe) in installation time.

- Do not discharge flon gas into the air to protect the earth environment.
- Using the vacuum pump method, clear the remained air (Nitrogen, etc.) in the unit. If the air remains, the pressure in the refrigerating cycle becomes abnormally high and an injury and others are caused due to burst.

1. CONSTRUCTION VIEWS (EXTERNAL VIEWS)

1-1. Indoor Unit

Model: MMK-AP0073HP1-E1 (TR1), MMK-AP0093HP1-E1 (TR1), MMK-AP0123HP1-E1 (TR1),
MMK-AP0153HP1-E1 (TR1), MMK-AP0183HP1-E1 (TR1), MMK-AP0243HP1-E1 (TR1)

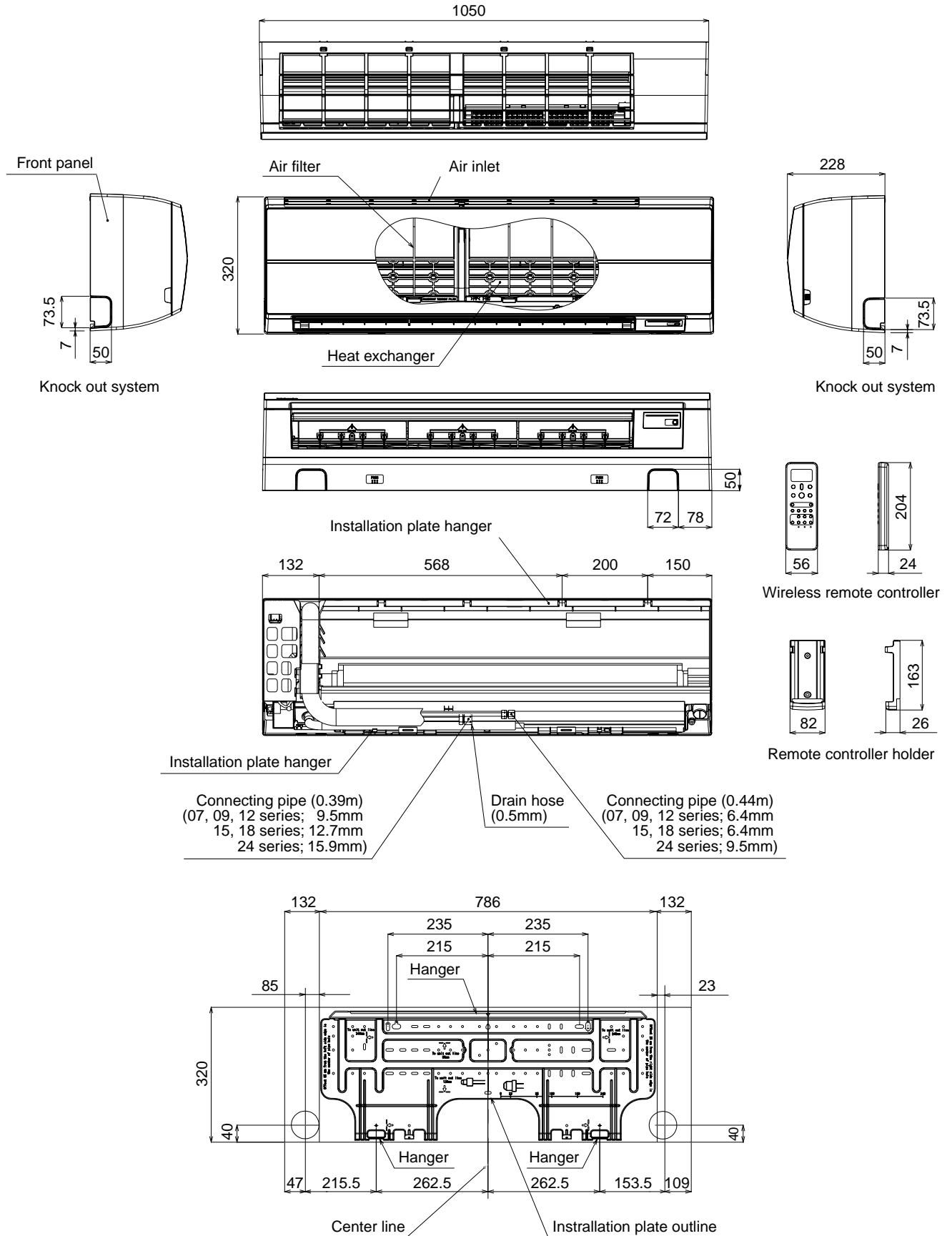

2. WIRING DIAGRAM

Model: MMK-AP0073HP1-E1 (TR1), MMK-AP0093HP1-E1 (TR1), MMK-AP0123HP1-E1 (TR1), MMK-AP0153HP1-E1 (TR1), MMK-AP0183HP1-E1 (TR1), MMK-AP0243HP1-E1 (TR1)

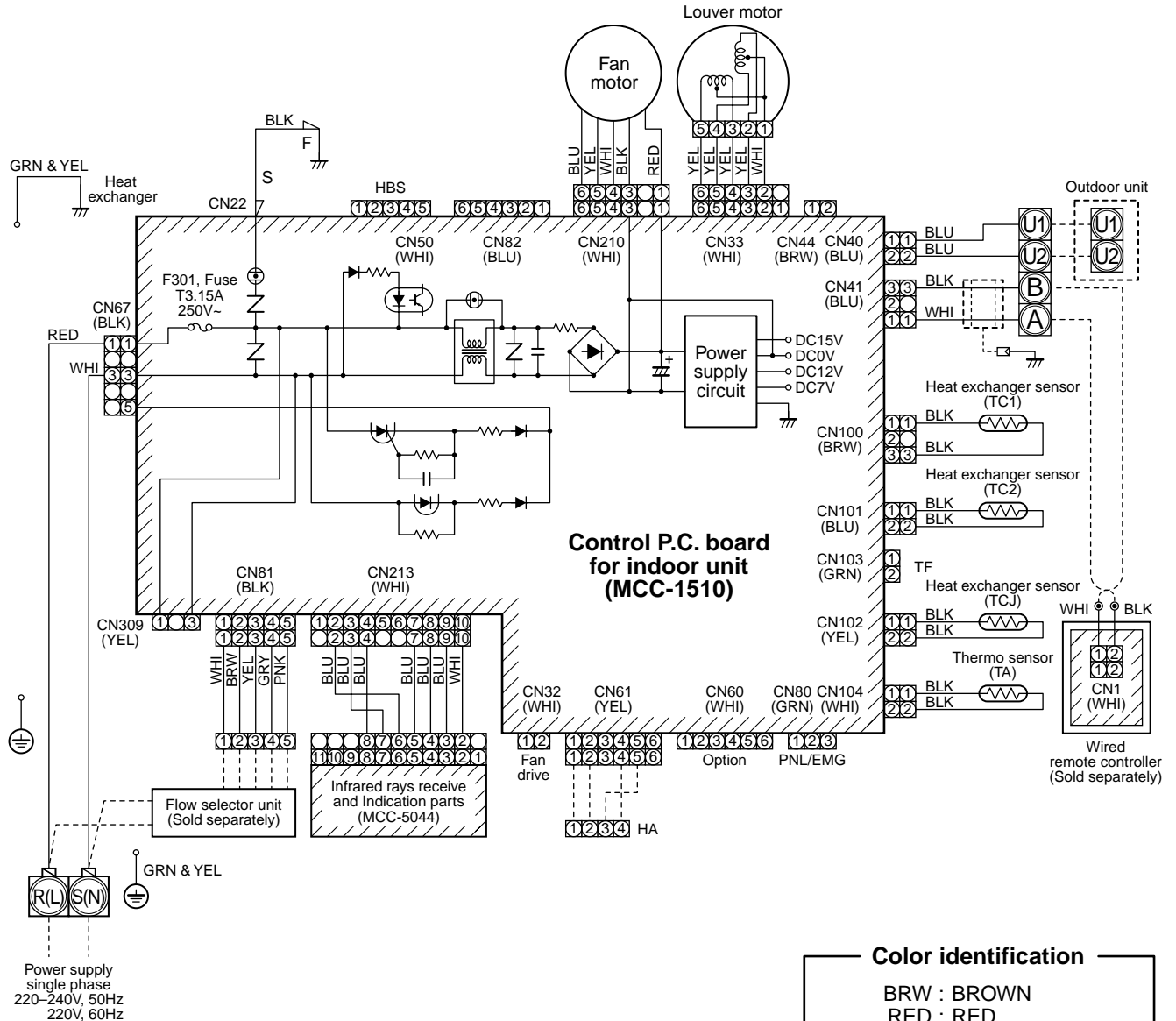

1. indicates the terminal block.
Letter at inside indicates the terminal number.
2. A dotted line and broken line indicates the wiring at site.
3. indicates the control P.C. board.

3. PARTS RATING

3-1. Parts Rating

No.	Parts Name	Type	Specications
1	Fan motor (for indoor)	ICF-340-30-4	Output (Rated) 30W,340V DC
2	Grille motor	MP24Z3N	Output (Rated) 1W, 16 poles DC
3	Thermo. Sensor (TA sensor)	268mm	10kΩ at 25°C
4	Heat exchanger sensor (TC1 sensor)	Ø4,650mm	10kΩ at 25°C
5	Heat exchanger sensor (TC2 sensor)	Ø6,800mm	10kΩ at 25°C
6	Heat exchanger sensor (TCJ sensor)	Ø6,800mm	10kΩ at 25°C

3-2. Name of Each Part

Model: MMK-APXXX3HP1

Air outlet / Louver

Change the direction of the air to be discharged according to cool/heat mode.

Air inlet grille

Air in the room is sucked from here.

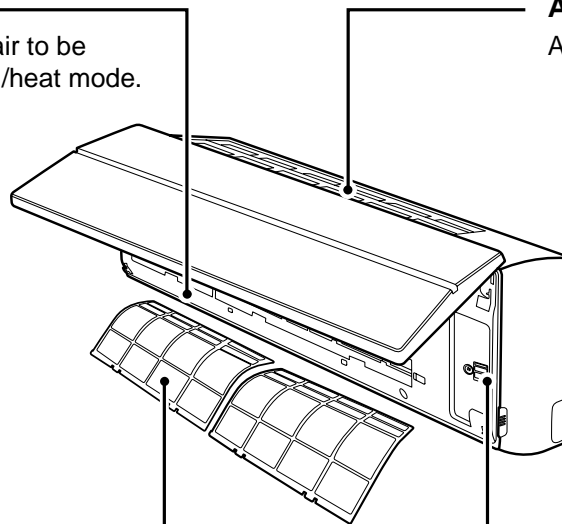

Air filter

Removes dirt or dust.
(Provided in the air inlet grille)

Earth screw

Earth screws are provided in the electric parts box.

3-3. Parts Name of Remote Controller

■ Display section

In the display example, all indicators are displayed for the explanation. In reality only, the selected contents are indicated.

- When turning on the main power switch and leak breaker at the first time, **SETTING** flashes on the display part of the remote controller.
- While this display is flashing, the model is being automatically confirmed.

Accordingly, wait for a while after **SETTING** display has disappeared, and then use the remote controller.

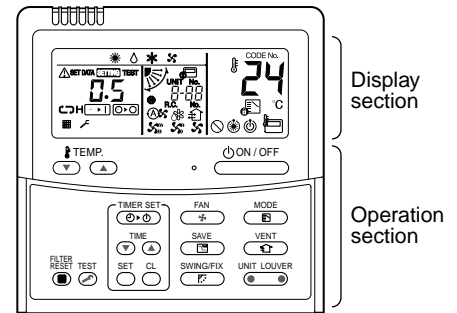

This remote controller can control the operation of Max. 8 indoor units.

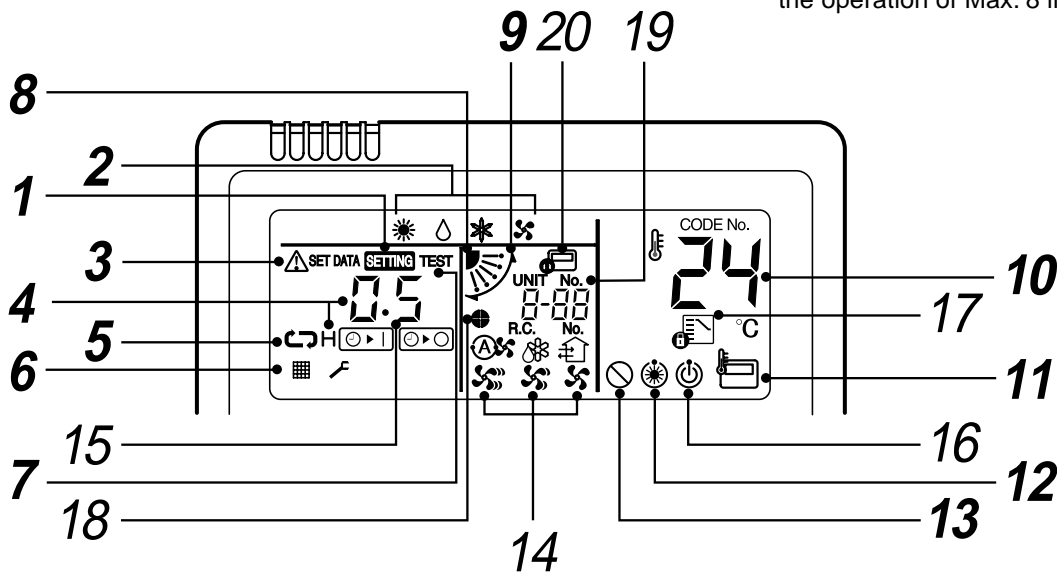

1 SETTING display

Displayed during setup of the timer etc.

2 Operation mode select display

The selected operation mode is displayed.

3 CHECK display

Displayed while the protective device works or a trouble occurs.

4 Timer time display

Time of the timer with H mark is displayed. (When a trouble occurs, the check code is displayed.)

5 Timer SET IN setup display

When pushing the Timer SET IN button, the display of the timer is selected in order of [OFF] → [OFF] repeat OFF timer → [ON] → No display.

6 Filter display

If "FILTER " is displayed, clean the air filter.

7 TEST run display

Displayed during a test run.

8 Louver position display

(4-way Air Discharge Cassette, 2-way Air Discharge Cassette, 1-way Air Discharge Cassette, Under Ceiling and High Wall Type only (2H, 3H))

Displays louver position.

9 SWING display

Displayed during up/down movement of the louver.

10 Set up temperature display

The selected set up temp. is displayed.

11 Remote controller sensor display

Displayed while the sensor of the remote controller is used.

12 PRE-HEAT display (Heat-pump model only)

Displayed when the heating operation starts or defrost operation is carried out.

While this indication is displayed, the indoor fan stops or the mode enters in LOW.

13 No function display

Displayed if there is no function even if the button is pushed.

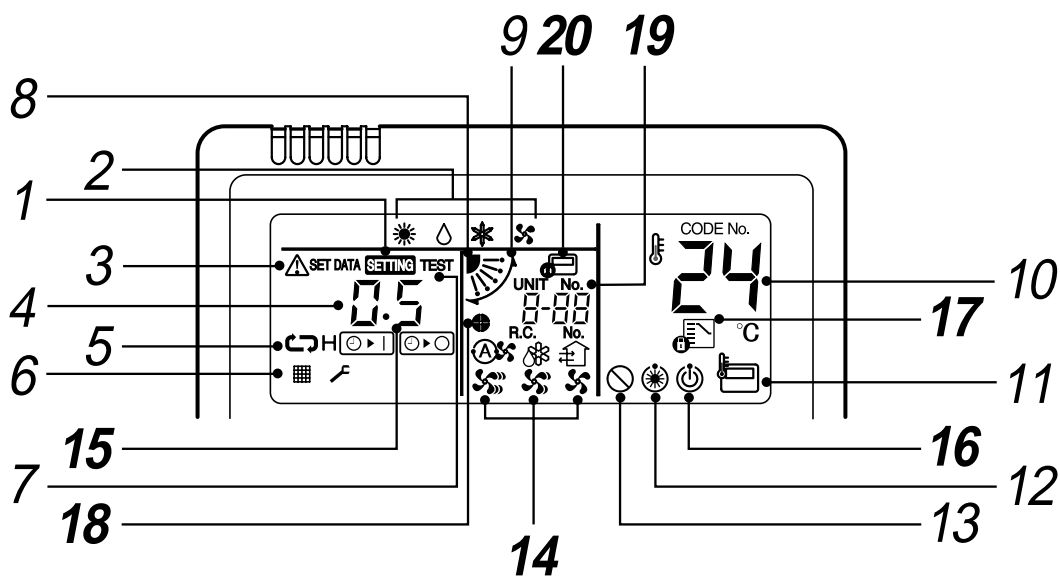

14 Air volume select display

The selected air volume mode is displayed.

- (AUTO) (HIGH)
- (MED.) (LOW)

**15 Louver Number display
(exapmle:01, 02, 03, 04)**

16 Operation ready display

Displayed when cooling or heating operation is impossible because the outdoor temperature goes out of the operable range.

17 Mode select control display

Displayed when pushing "Operation mode select" button while the operation mode is fixed to heating or cooling by the system manager of the air conditioner.

**18 Louver lock display
(4-way Air Discharge Cassette Type
2H series only)**

Displayed when there is a louver-locked unit in the group (including 1 indoor unit by 1 outdoor unit).

19 Unit Number display

Unit number of the indoor unit selected with the unit select button or abnormal indication of the indoor/outdoor unit.

20 Central control display

Displayed when the air conditioner is used under the central control in combination with a central control remote controller.

In case the remote controller is disabled by the central control system, flashes.

The button operation is not accepted.

Even when you push ON/OFF, MODE, or TEMP. button, the button operation is not accepted.

(Settings made by the remote controller vary with the central control mode.

For details, refer to the Owner's Manual of the central control remote controller.)

■ Operation section

Push each button to select a desired operation.

- The details of the operation needs to be set up once, afterward, the air conditioner can be used by pushing  button only.

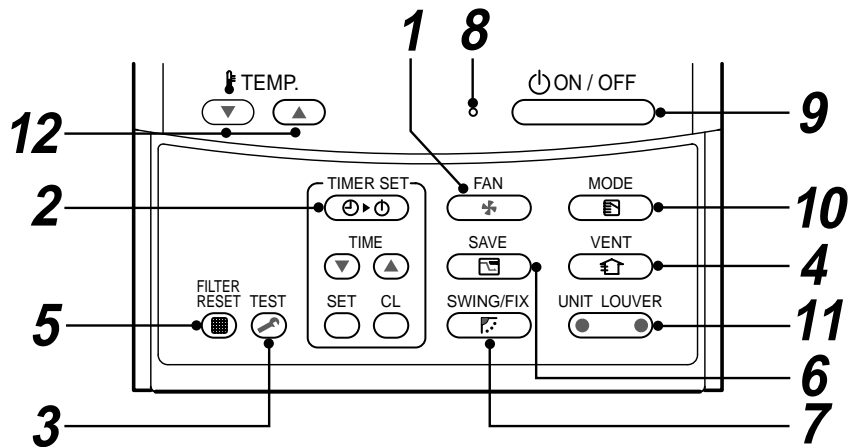

1 button (Air volume select button)

Selects the desired air volume mode.

2 button (Timer set button)

TIMER SET button is used when the timer is set up.

3 button (Check button)

The CHECK button is used for the check operation. During normal operation, do not use this button.

4 button (Ventilation button)

Ventilation button is used when a fan which is sold on the market is connected.

- If “No function  button, a fan is not connected.

5 button (Filter reset button)

Resets (Erases) “ FILTER” display.

6 button (Power save operation)

No function

7 button (Swing/Wind direction button)

Selects automatic swing or setting the louver direction.

- This function is not provided to
Concealed Duct Standard Type,
High Static Pressure Type,
Floor Standing Cabinet Type,
Floor Standing Concealed Type or Slim Duct Type.

8 Operation lamp

Lamp is lit during the operation.

Lamp is off when stopped.

Also it flashes when operating the protection device or abnormal time.

9 button

When the button is pushed, the operation starts, and it stops by pushing the button again. When the operation has stopped, the operation lamp and all the displays disappear.

10 button (Operation mode select button)

Selects desired operation mode.

11 button (Unit/Louver select button)

Selects a unit number (left) and louver number (right).

UNIT:



Selects an indoor unit when adjusting wind direction when multiple indoor units are controlled with one remote controller.

LOUVER (4-way Air Discharge Cassette Type 2H series only):

Selects a louver when setting louver lock or wind direction adjustment independently.

12 button (Set up temperature button)

Adjusts the room temperature.

Set the desired set temperature by pushing  TEMP. .

OPTION :

Remote controller sensor

Usually the TEMP. sensor of the indoor unit senses the temperature. The temperature on the surrounding of the remote controller can also be sensed. For details, contact the dealer from which you have purchased the air conditioner.

- In case that one remote controller controls the multiple indoor units, the setup operation is unavailable in group control.

3-4. Correct Usage

- When you use the air conditioner for the first time or when you change the SET DATA value, follow the procedure below.
From the next time, the operation displayed on the remote controller will start by pushing the  button only.

■ Preparation

Turn on the main power switch and/or the leakage breaker.

- When the power supply is turned on, a partition line is displayed on the display part of the remote controller.
- * After the power supply is turned on, the remote controller does not accept an operation for approx. 1 minute, but it is not a failure.

REQUIREMENT

- While using the air conditioner, operate it only with  button without turning off the main power switch and the leak breaker.
- When you use the air conditioner after it has not been used for a long period, turn on the power switch at least 12 hours before starting operation.

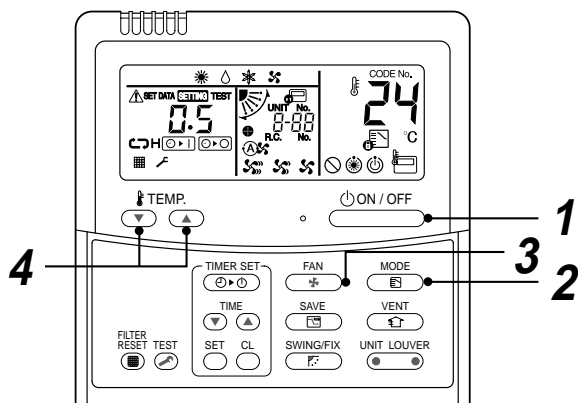

3 Select air volume with “ ” button.

One push of the button, and the display changes in the order shown as follows.

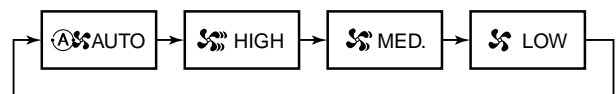

Start

1 Push button.







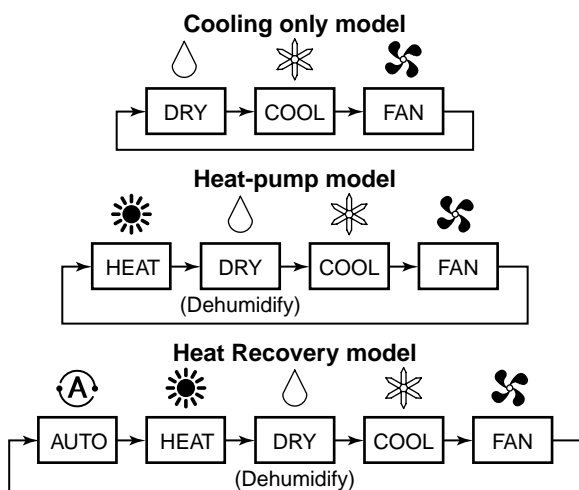

The operation lamp goes on, and the operation starts.

2 Select an operation mode with the “MODE ” button.

One push of the button, and the display changes in the order shown as follows.

- “  DRY mode” function is not provided to Concealed Duct High Static Pressure Type.



- When air volume is “  AUTO”, air volume differs according to the room temperature.
- In  DRY mode, “  AUTO” is displayed and the air volume is LOW.
- In heating operation, if the room temperature is not heated sufficiently with VOLUME “  LOW” operation, select “  MED.” or “  HIGH” operation.
- The temperature sensor senses temperature near the air inlet of the indoor unit, which differs from the room temperature depending on the installation condition.
A value of setting temperature is the measure of room temperature. (“  AUTO” is not selectable in the FAN mode.)
- Air volume of function is not provided to “Concealed Duct High Static Pressure Type” but air speed “  HIGH” only is displayed.

4 Determine the set up temperature by pushing the “TEMP. ” or “TEMP. ” button.

Stop

Push button.

The operation lamp goes off, and the operation stops.

[In case of cooling]

- Start the cooling operation after approx. 1 minute.

[In case of heating (For Heat-pump model only)]

- The heating operation mode is selected in accordance with the room temperature and operation starts after approximately 3 to 5 minutes.
- After the heating operation has stopped, FAN operation may continue for approx. 30 seconds.
- When the room temperature reaches the set temperature, the super low wind is discharged and the air volume decreases excessively.
- During defrost operation, the fan stops so that cool air is not discharged. (“ PRE-HEAT” is displayed.)

NOTE**When restarting the operation after stop**

- When restarting the operation immediately after stop, the air conditioner does not operate for approx. 3 minutes to protect the machine.

Automatic Operation (Super Heat Recovery Type Only)

When you set the air conditioner in  mode or switch over from AUTO operation because of some settings change, it will automatically select either cooling, heating, or fan only operation depending on the indoor temperature.

3-5. Adjustment of Wind Direction

For best cooling and heating performance, adjust the louvers (adjustment of up/down wind direction) appropriately.

 **CAUTION**

- If cooling operation is performed with downward air outlet, dew may fall on surface of the cabinet or the horizontal louver resulted in dripping.
 - If heating operation is performed with horizontal air outlet, unevenness of temperature may increase in the room.
 - Do not move the horizontal louver directly with hands; otherwise a trouble is caused.
Select direction of the horizontal louver using  switch on the remote controller.
The horizontal louver does not stop immediately even if the switch is pushed.
Adjusting the stop position, push the switch.
-

◆ For all models**[In Cooling operation]**

Use the louvers with horizontal set point.

[In Heating operation (For Heat-pump model only)]

Use the louvers with downward set point.

◆ For Under Ceiling, 1-way Air Discharge Cassette, High Wall Type**[Right / Left air direction adjustment]**

To change the air outlet direction to right or left side, set the vertical louver inside of the horizontal louver to the desired direction.

◆ 4-way Air Discharge Cassette Type (1H series), Compact 4-way Type

- When the air conditioner is not operating, the louvers automatically direct downward.
- While the air conditioner is in ready status for heating, the louvers direct upward.

The swinging operation starts after heating ready status has been cleared, but “SWING ↷” is displayed on the remote controller even if the status is ready to heating.

◆ 4-way Air Discharge Cassette Type (2H series)

- When the air conditioner is not operating, the louvers automatically close.
- The louvers direct horizontally when heating begins, during defrost operation, or during the minimum operation after reaching the set temperature.

When you make a swing or air direction setting at this time, the remote controller display varies with the setting, but the louvers stay pointed straight out horizontally.

When the air conditioner starts heating, the louvers direct to the set direction.

- As the refrigerant recovery control for the outdoor units in the Modular Multi system works even if the outdoor units stop, in some cases, the louver of the stopped indoor unit may open for several minutes.

[In Cooling operation]

Use the louvers with horizontal set point.

For Cooling (Cool)

Direct the louvers horizontally.

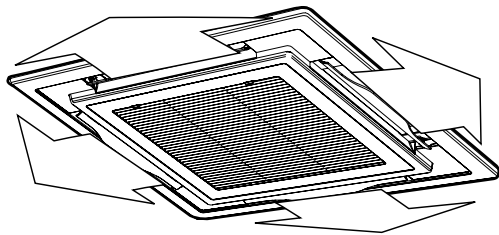

[In Heating operation (For Heat-pump model only)]

Use the louvers with downward set point.

For Heating (Heat)

Direct the louvers downward.

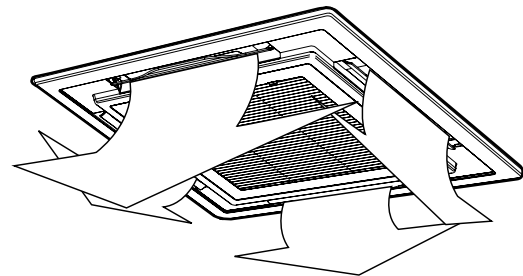

According to the shape or arrangement of the room, the cold air and hot air can be discharged for two directions or three directions. For details, contact the dealer.

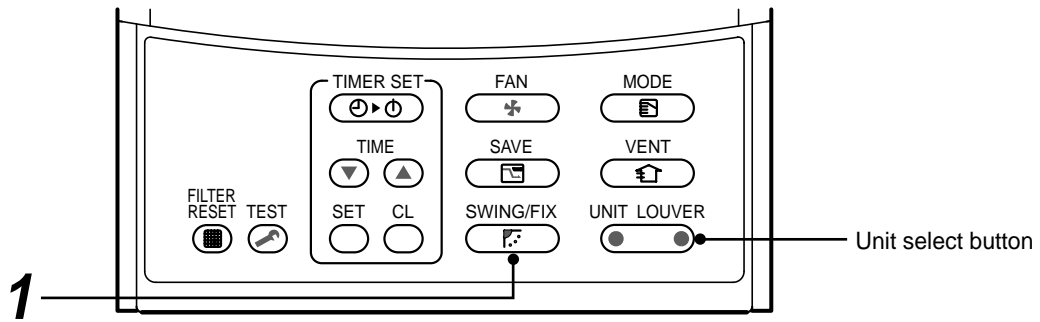

How to set up the wind direction

1 Push during operation.

The wind direction changes for every push of the button.

[In HEAT operation]

Direct the louver (adjustment plate of up/down wind direction) downward.

If directing horizontally, hot air may not come to the foot.

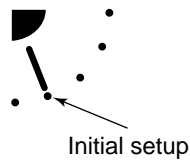

[In COOL/DRY operation]

Direct the louver (adjustment plate of up/down wind direction) horizontally.

If directing it downward, the dew may form on the surface of the air discharge port and may drop down.

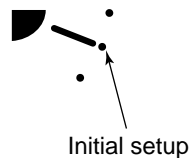

[In FAN operation]

Select a desired wind direction.

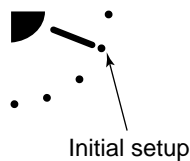

How to start swinging

1 Push , set the louver (adjustment plate of up/down wind direction) direction to the lowest position, and then push again.

SWING is displayed and the up/down wind direction is automatically selected.

Display during swinging

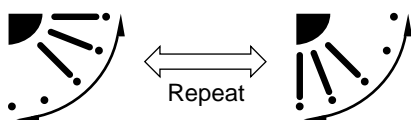

How to stop swinging

1 Push at a desired position while the louver is swinging.

- When is pushed after that, wind direction can be set again from the highest position.
- * However, even if is pushed while the louver is swinging, the louver position is displayed as follows and highest position of the louver may not be selected.

Display when swinging is stopped



In this case, push again two seconds later.

- In COOL/DRY operation, the louver does not stop as it directs downward. If stopping the louver as it directs downward during swing operation, it stops after moving to the third position from the highest position.

Display when stopping the swing



Unit select button

- When multiple indoor units are controlled with one remote controller, wind direction can be set for each indoor unit by selecting individually.
- To set wind direction individually, push button to display an indoor unit number in the control group. Then set the wind direction of the displayed indoor unit.
- When no indoor unit number is displayed, all indoor units in the control group can be controlled simultaneously.
- Each time you push button, the display changes as follows:

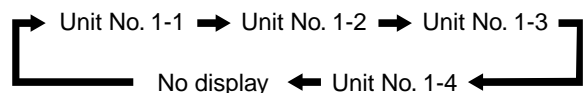

3-6. Timer Operation

- A type of timer operation can be selected from the following three types. (Setting of up to 168 hours is enabled.)
 - OFF timer : The operation stops when the time of timer has reached the set time.
 - Repeat OFF timer : Every time, the operation stops after the set time has passed.
 - ON timer : The operation starts when the time of timer has reached the set time.

■ Timer operation

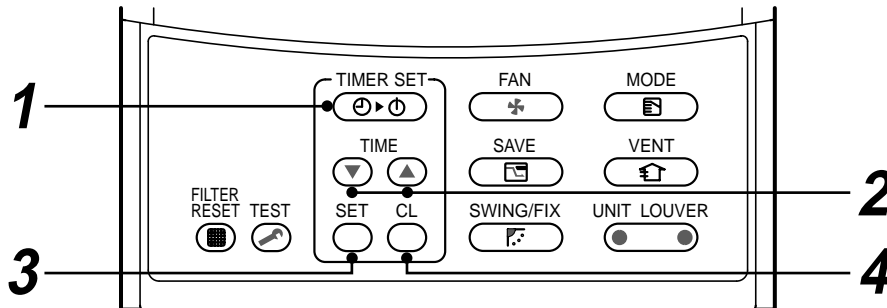

Set

1 Push TIMER SET button.

The timer display (type) changes for every push of the button.

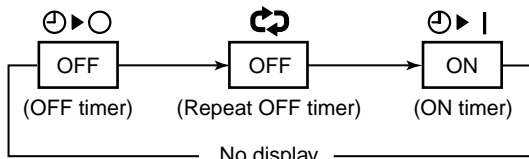

- SETTING and timer time displays flash.

2 Push TIME button to select "SET TIME".

- For every push of ▲ button, the set time increases in the unit of 0.5 hr (30 minutes). When setting a time more than 24 hours for timer operation, timer time can be set in the unit of 1 hr. The maximum set time is 168hr (7 days). The remote controller displays the set time with time (between 0.5 and 23.5 hours) (*1) or number of days and time (24 hours or more) (*2) as shown below.
- For every push of ▼ button, the set time decreases in the unit of 0.5 hr (30 minutes) (0.5 to 23.5 hours) or 1 hr (24 to 168 hours).

Example of remote controller display

- In the case of 23.5 hours (*1)



- In the case of 34 hours (*2)



- 1d shows 1 day (24 hours).
- 10h shows 10 hours. (Total 34 hours).

3 Push SET button.

- SETTING display disappears and timer time display goes on, and ◀▶ or ▶▶ display flashes. (When ON timer is activated, timer time, ON timer ▶▶ are displayed and other displays disappear.)

4 Cancel of timer operation

Push CL button.

TIMER display disappears.

NOTE

- When the operation stops after the timer reached the preset time, the Repeat OFF timer resumes the operation by pushing ON/OFF button and stops the operation after the reached the set time.
- When you push SWING/FIX while the OFF timer function of the air conditioner is active, the indication of the timer function disappears and then appears again after about 5 seconds. This is due to normal processing of the remote controller.

3-7. Installation

Installation place

CAUTION

-
- Check that the air conditioner is not installed in a place subject to combustible gas leak. Accumulation of combustible gas around the unit may cause a fire.
 - Drain the dehumidified water from the indoor unit and outdoor unit to a well-drained place.
 - Do not put any obstacle near the air inlets and air outlet of the outdoor unit. Doing so may hinder the radiation, which may reduce the performance or activate the protective device.
-

Electrical wiring

WARNING

-
- Be sure to connect earth wire. (grounding work) Incomplete grounding cause an electric shock. Do not connect ground wires to gas pipes, water pipes, lightning rods or ground wires for telephone wires.
-

CAUTION

-
- **Make sure that a leakage breaker is connected.**
Using the air conditioner without leakage breaker may cause electric shock.
 - **Use a leakage breaker with an appropriate capacity.**
Be sure to use the rated voltage and an exclusive circuit for power supply of the air conditioner.
-

Do not install the air conditioner in the following places

- Do not install the air conditioner in any place within 1 m from a TV, stereo, or radio set. If the unit is installed in such place, noise transmitted from the air conditioner affects the operation of these appliances.
- Do not install the air conditioner near a high frequency appliance (sewing machine or massager for business use, etc.), otherwise the air conditioner may malfunction.
- Do not install the air conditioner in a humid or oily place, or in a place where steam, soot, or corrosive gas is generated.
- Do not install the air conditioner in a salty place such as seaside area.
- Do not install the air conditioner in a place where a great deal of machine oil is used.
- Do not install the air conditioner in a place where it is usually exposed to strong wind such as in seaside area.
- Do not install the air conditioner in a place where sulfurous gas generated such as in a spa.
- Do not install the air conditioner in a vessel or mobile crane.
- Do not install the air conditioner in an acidic or alkaline atmosphere (in a hot-spring area or near a chemicals factory, or in a place subject to combustion emissions). Corrosion may be generated on the aluminum fin and copper pipe of the heat exchanger.
- Do not install the air conditioner near an obstacle (air vent, lighting equipment, etc.) that disturbs discharge air. (Turbulent airflow may reduce the performance or disable devices.)
- Do not use the air conditioner for special purposes such as preserving food, precision instruments, or art objects, or where breeding animals or growing plants are kept. (This may degrade the quality of preserved materials.)
- Do not install the air conditioner over an object that must not get wet. (Condensation may drop from the indoor unit at a humidity of 80% or more or when the drain port is clogged.)
- Do not install the air conditioner in a place where an organic solvent is used.
- Do not install the air conditioner near a door or window subject to humid outside air. Condensation may form on the air conditioner.
- Do not install the air conditioner in a place where special spray is used frequently.

Be careful with noise or vibrations

- Do not install the air conditioner in a place where noise by outdoor unit or hot air from its air outlet annoys your neighbors.
- Install the air conditioner on a solid and stable foundation so that it prevents transmission of resonating, operation noise and vibration.
- If one indoor unit is operating, some sound may be audible from other indoor units that are not operating.

3-8. Maintenance

WARNING



Be sure to turn off the main power switch prior to the maintenance.

- Please do not intend to do the daily maintenance and/or Air Filter cleaning by yourself.

Cleaning of the air filter and other parts of the air filter involves dangerous work in high places, so be sure to have a service person do it. Do not attempt it yourself.

Cleaning of air filters

Clogging of air filters will reduce the cooling and heating performance.

- 1 When “ FILTER” appears on the remote controller, clean the air filters.
- 2 When the cleaning of air filters has been completed, push  button. “ FILTER” disappears.

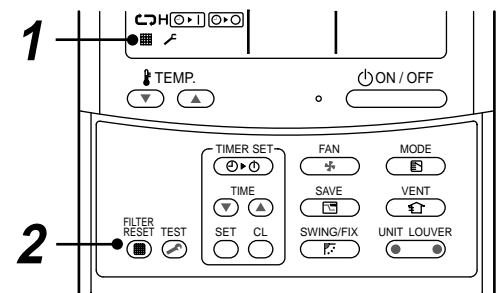

CAUTION

Cleaning of unit

Clean the unit with a soft dry cloth.

If dirt cannot be removed with the dry cloth, use a cloth slightly dampened with lukewarm (under 40 °C) water.

Cleaning of remote controller

- Use a dry cloth to wipe the remote controller.
- A cloth dampened with cold water may be used on the indoor unit if it is very dirty.
- Never use a damp cloth on the remote controller.
- Do not use a chemically-treated duster for wiping or leave such materials on the unit for long. It may damage or fade the surface of the unit.
- Do not use benzine, thinner, polishing powder, or similar solvents for cleaning. These may cause the plastic surface to crack or deform.

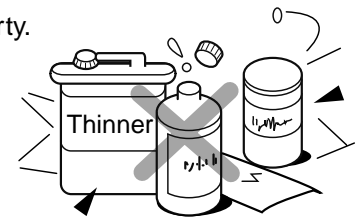

Periodic check

Long-period use of the air conditioner may cause deterioration or failure of parts due to heat, humidity, dust, and operating conditions, or may cause poor drainage of dehumidified water.

If you do not plan to use the unit for more than 1 month

- 1) Operate the fan for 3 to 4 hours to dry inside the unit.
 - Operate “FAN” mode.
- 2) Stop the air conditioner and turn off the main power switch or the circuit breaker.

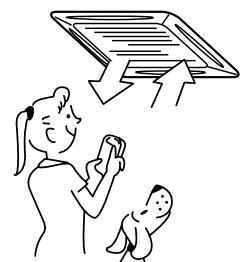

Checks before operation

- 1) Check that the air filters are installed.
- 2) Check that the air outlet or inlet is not blocked.
- 3) Turn on the main power switch or the circuit breaker for the main power supply to the air conditioner.

NOTE

- For environmental conservation, it is strongly recommended that the indoor and outdoor units of the air conditioner in use be cleaned and maintained regularly to ensure efficient operation of the air conditioner. When the air conditioner is operated for a long time, periodic maintenance (once a year) is recommended. Furthermore, regularly check the outdoor unit for rust and scratches, and remove them or apply rustproof treatment, if necessary.

As a general rule, when an indoor unit is operated for 8 hours or more daily, clean the indoor unit and outdoor unit at least once every 3 months. Ask a professional for this cleaning/maintenance work.

Such maintenance can extend the life of the product though it involves the owner's expense.

Failure to clean the indoor and outdoor units regularly will result in poor performance, freezing, water leakage, and even compressor failure.

Maintenance List

Part	Check (visual/auditory)	Maintenance
Heat exchanger	• Dust/dirt clogging, scratches	• Wash the heat exchanger when it is clogged.
Fan motor	• Sound	• Take appropriate measures when abnormal sound is generated.
Filter	• Dust/dirt, breakage	• Wash the filter with water when it is contaminated. • Replace it when it is damaged.
Fan	• Vibration, balance • Dust/dirt, appearance	• Replace the fan when vibration or balance is terrible. • Brush or wash the fan when it is contaminated.
Air inlet/outlet grilles	• Dust/dirt, scratches	• Fix or replace them when they are deformed or damaged.
Drain pan	• Dust/dirt clogging, drain contamination	• Clean the drain pan and check the downward slope for smooth drainage.
Ornamental panel, louvers	• Dust/dirt, scratches	• Wash them when they are contaminated or apply repair coating.

 **WARNING**
Re-Installation

Ask the dealer or an installation professional to re-install the air conditioner to a new place or move it to another place and to observe the following items.

If the air conditioner is inappropriately installed by yourself, it may cause electric shock or fire.

 **CAUTION**

Be sure to clean the heat exchanger with pressurized water.

If an commercially detergent (strong alkaline or acid cleaning agent) is used, the surface treatment of the heat exchanger will be marred, which may degrade the self cleaning performance. For details, contact the dealer.

◆ High Wall Type

- Open the air inlet grille. Lift the air inlet grille up to the horizontal position.
- Take hold of the left and right handles of the air filter and lift it up slightly, then pull downward to take it out from the filter holder.

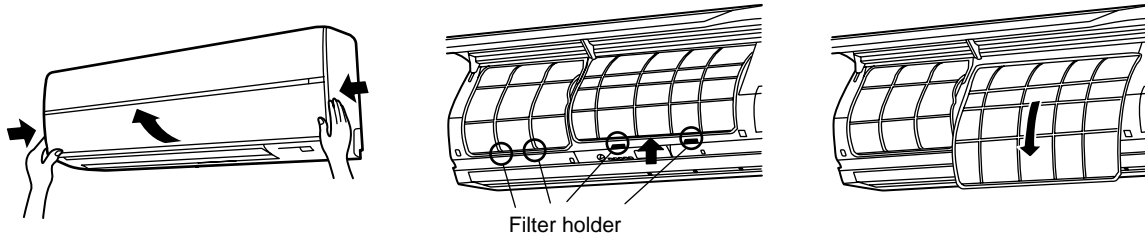

Return the air filter

- Insert the upper portion of air filter confirming to fit it is right and left edges on the indoor unit until it is firmly set.
- Close the air inlet grille.

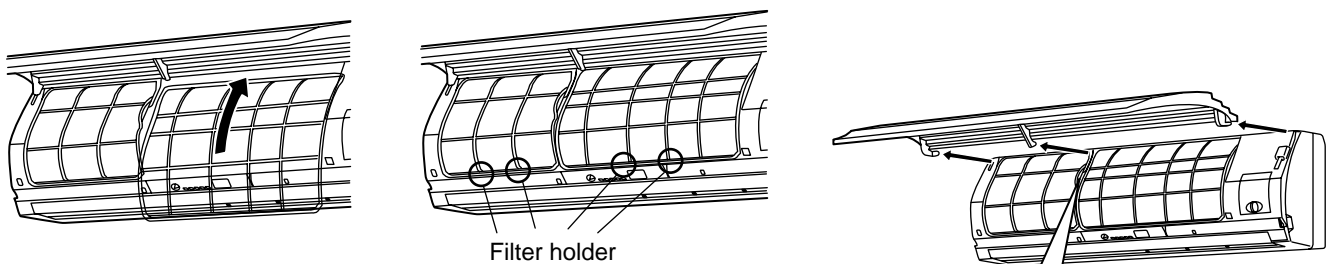

Cleaning the air inlet grille

1. Remove the air inlet grille.
Hold the two sides of the air inlet grille and open upwards.
Move the center arm to the left and remove the grille.
2. Wash it with water using a soft sponge or towel.
(Do not use metallic scrubbing brush or other hard brushes.)
 - Use of such hard objects will cause scratches on the surface of the grille, and the metal coating to peel off.
 - If very dirty, clean the air inlet grille with a neutral detergent for kitchen use, and rinse it off with water.
3. Wipe out water from the air inlet grille and dry it.
4. Fit the left and right arms of the air inlet grille to the shafts on the two sides of the air conditioner and push in completely, and then push in the center arm.
5. Check that the center arm has been completely inserted and close the air inlet grille.
 - Push the arrow locations (Four) at the bottom of the air inlet grille to check whether the grill is completely closed.

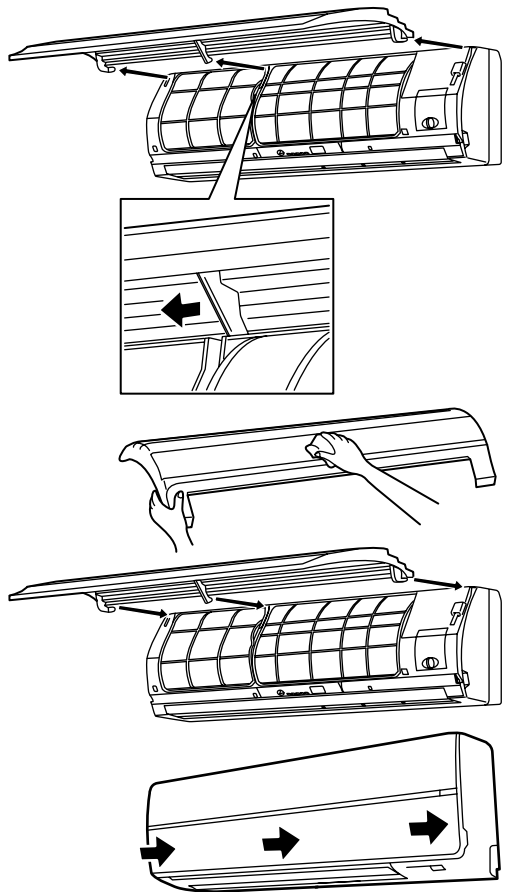

NOTE

Cleaning of air filter

- For cleaning of air filter, use a cleaner or brush clean.
If stain is heavy, it is effective to wash the air filter in tepid water mixed with neutral detergent.
- After washing, rinse it well, and dry it in the shade.
- Install again the air filter which has been cleaned.



3-9. Air Conditioner Operations and Performance

Check before operation

- Check whether earth wire is disconnected or out of place.
- Check that air filter is installed to the indoor unit.
- Check that the air outlet or inlet is not blocked.
- Turn on the main power switch or the circuit breaker for the main power supply to the air conditioner.



WARNING

Turn on the power switch 12 hours or more before starting before operation.

Heating capacity (for Heat-pump model only)

- For heating, a heat pump system which sucks in outside heat air and discharges it into the room is adopted. If temperature of the outside air lowers, the heating capacity decreases.
- When temperature of the outside air is low, it is recommended to use other heating equipment together.

Defrost operation during heating operation (for Heat-pump model only)

- If the outdoor unit has some frost during heating operation, the operation mode changes automatically to defrost mode to increase the heating effect (for approx. 2 to 10 minutes).
- During defrost operation, fans of the indoor and the outdoor units stop.

3 minutes protection

- The outdoor unit does not operate for approx. 3 minutes after air conditioner has been immediately restarted after stop, or power switch has been turned on. This is to protect the system.

Main power failure

- If a power failure occurred during the operation, all operations stop.
- When restarting the operation, push ON/OFF button again.

Fan rotation of stopped unit

- While other indoor units operate, the fan on indoor units on “stand-by” rotates to protect the machine once per approx. 1 hour for several minutes.

Protective device (High pressure switch)

The high pressure switch stops the air conditioner automatically when excessive load is applied to the air conditioner. If the protective device works, the operation lamp keeps lit but the operation stops. When the protective device works, “” in the remote controller display part flash. The protective device may work in the following cases.



<Cooling operation>

- When the air inlet or air outlet of the outdoor unit is blocked.
- When strong wind blows continuously against the air outlet of the outdoor unit.

<Heating operation>

- When dust or dirt is excessively adhered to air filter of the indoor unit.
- When the air outlet of the indoor unit is blocked.

Cooling/heating operation of Modular Multi system air conditioner

- In Modular Multi system air conditioner, each indoor unit can be individually controlled. However, cooling operation and heating operation cannot be performed concurrently for the indoor units which are connected to one outdoor unit. When cooling operation and heating operation are performed concurrently, the indoor unit which is performing cooling operation stops, and “” on the display is lit. The indoor unit which is performing heating operation continues operation. If the manager has fixed the setting to COOL or HEAT, other operation than set up one cannot be performed. When other operation than set up one is performed, “” on the display is lit and the operation stops.

Characteristics of heating operation (for Heat-pump model only)

- Hot air is not out immediately after the operation has started. After 3 to 5 minutes (differs according to room or outside temperature) has passed and the indoor heat exchanger has been warmed up, hot air blows out.
- During operation, the outdoor unit may stop if outside temperature becomes high.
- When other outdoor unit performs heating operation while the fan is operating, the fan operation may be stopped temporarily to prevent blowing of hot air.

Air conditioner operating conditions

For proper performance, operate the air conditioner under the following temperature conditions:

Cooling operation	Outdoor temperature : -5°C to 43°C (Dry-bulb temp.)
	Room temperature : 21°C to 32°C (Dry-bulb temp.), 15°C to 24°C (Wet-bulb temp.)
	CAUTION Room relative humidity: less than 80 %. If the air conditioner operates in excess of this figure, the surface of the air conditioner may cause dewing.
Heating operation	Outdoor temperature : -15°C to 15.5°C (Wet-bulb temp.)
	Room temperature : 15°C to 28°C (Dry-bulb temp.)

If air conditioner is used outside of the above conditions, safety protection may operate.

3-10. When the Following Symptoms are Found

Check the points described below before asking repair servicing.

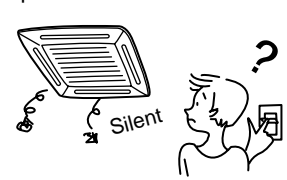
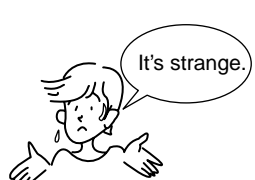
	Symptom	Cause
It is not a failure.	Outdoor unit <ul style="list-style-type: none"> • White misty cold air or water is out. • Sometimes, noise "Pushu !" is heard. 	<ul style="list-style-type: none"> • Fan of the outdoor unit stops automatically and performs defrost operation. • Solenoid valve works when defrost operation starts or finishes.
	Indoor unit <ul style="list-style-type: none"> • "Swish" sound is heard sometimes. • Slight "Pishi!" sound is heard. • Discharge air smells. • "Ⓢ" indication is lit.  <ul style="list-style-type: none"> • Sound or cool air is output from the stand by indoor unit. 	<ul style="list-style-type: none"> • When the operation has started, during the operation, or immediately after the operation has stopped, a sound such as water flows may be heard, and the operation sound may become larger for 2 or 3 minutes immediately after the operation has started. They are flowing sound of refrigerant or draining sound of dehumidifier. • This is sound generated when heat exchanger, etc. expand and contract slightly due to change of temperature. • Various smell such as one of wall, carpet, clothes, cigarette, or cosmetics adhere to the air conditioner. • When cooling operation cannot be performed because another indoor unit performs heating operation. • When the manager of the air conditioner has fixed the operation to COOL or HEAT, and an operation contrary to the setup operation is performed. • When fan operation stopped to prevent discharge of hot air. • Since refrigerant is flowed temporarily to prevent stay of oil or refrigerant in the stand by indoor unit, sound of flowing refrigerant, "Kyururu" or "Shaa" may be heard or white steam when other indoor unit operates in HEAT mode, and cold air in COOL mode may be blow-out. • Sound is generated when the expansion valve operates when power has been turned on. • Intermittent operation of the fan with louvers open is sometimes carried out for the refrigerant recovery control of unoperated unit.
	<ul style="list-style-type: none"> • When power of the air conditioner is turned on, "Ticktock" sound is heard. • Fan and louvers of the indoor unit moves when the unit is not operated. 	
Check again.	Operates or stops automatically.	<ul style="list-style-type: none"> • Is the timer "ON" or "OFF"?
	Does not operate. 	<ul style="list-style-type: none"> • Is it a power failure? • Is the power switch turned off? • Is the power fuse or breaker blown? • Has the protective device operated? (The operation lamp goes on.) • Is the timer "ON"? (The operation lamp goes on.) • Are COOL and HEAT selected simultaneously? ("Ⓢ" indication is lit on the display of the remote controller.)
	Air is not cooled or warmed sufficiently. 	<ul style="list-style-type: none"> • Is the air inlet or air outlet of the outdoor unit obstructed? • Are any door or window open? • Is the air filter clogged with dust? • Is discharge louver of the indoor unit set at appropriate position? • Is air selection set to "LOW" "MED", and is the operation mode set to "FAN"? • Is the setup temp. the appropriate temperature? • Are COOL and HEAT selected simultaneously? ("Ⓢ" indication is lit on the display of the remote controller.)

CAUTION

If any of the following conditions occur, turn off the main power supply switch and immediately contact the dealer :

- Switch operation does not work properly.
- The main power fuse often blows out, or the circuit breaker is often activated.
- A foreign matter or water fall inside the air conditioner.
- When the air conditioner does not operate even after the cause of the protective device activation has been removed. (The operation lamp and  on the remote controller are flashing.)
- Any other unusual conditions are observed.

Confirmation and check

When a trouble occurred in the air conditioner, the check code and the indoor unit No. appear on the display part of the remote controller.

The check code is only displayed during the operation.

If the display disappears, operate the air conditioner according to the following "Confirmation of error history" for confirmation.

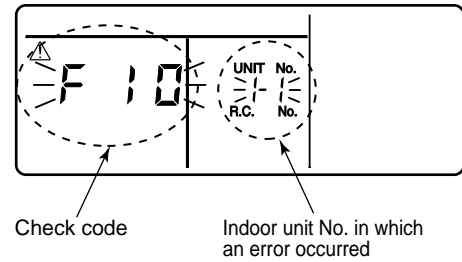

Confirmation of error history

When a trouble occurred on the air conditioner, the trouble history can be confirmed with the following procedure. (The trouble history is stored in memory up to 4 troubles.)

The history can be confirmed from both operating status and stop status.

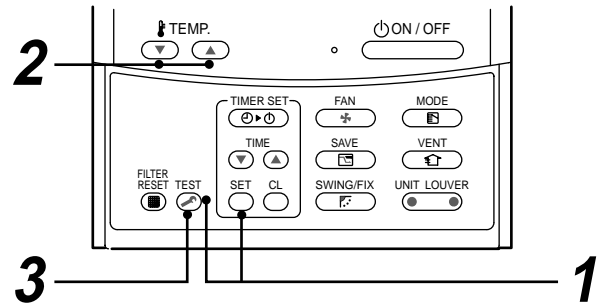

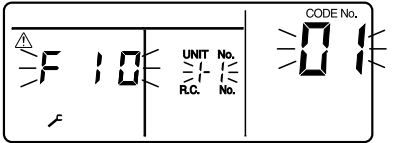
Procedure	Description
1	<p>When pushing ^{SET} and ^{TEST} buttons at the same time for 4 seconds or more, the following display appears.</p> <p>If [Service check] is displayed, the mode enters in the trouble history mode.</p> <ul style="list-style-type: none"> • [01 : Order of trouble history] is displayed in CODE No. window. • [Check code] is displayed. • [Indoor unit address in which an error occurred] is displayed in UNIT No. 
2	<p>Every pushing of [/] button used to set temperature, the trouble history stored in memory is displayed in order.</p> <p>The numbers in CODE No. indicate CODE No. [01] (latest) → [04] (oldest).</p> <p>CAUTION</p> <p>Do not push ^{CL} button because all the trouble history of the indoor unit will be deleted.</p>
3	<p>After confirmation, push ^{TEST} button to return to the usual display.</p>

1. Check the troubles according to the above procedure.
2. Ask an authorized dealer or qualified service (maintenance) professional to repair or maintain the air conditioner.
3. More details of the service code are explained in Service Manual.

Check these items.

If any of these problems still remains, stop the operation, turn off the leakage breaker, and then notifies the dealer of the serial number and details of the error. Never repair any part by yourself as it is dangerous.

When and a combination of *E*, *F*, *H*, *L*, or *P* and a number are displayed on the remote controller, also inform the dealer of the display content.

Thank you for purchasing this Toshiba air conditioner.

Please read carefully through these instructions that contain important information which complies with the “Machinery” Directive (Directive 2006 / 42 / EC), and ensure that you understand them.

After completing the installation work, hand over this Installation Manual as well as the Owner’s Manual provided to the user, and ask the user to keep them in a safe place for future reference.

Generic Denomination: Air Conditioner

Definition of Qualified Installer or Qualified Service Person

The air conditioner must be installed, maintained, repaired and removed by a qualified installer or qualified service person. When any of these jobs is to be done, ask a qualified installer or qualified service person to do them for you.

A qualified installer or qualified service person is an agent who has the qualifications and knowledge described in the table below.

Agent	Qualifications and knowledge which the agent must have
Qualified installer	<ul style="list-style-type: none"> • The qualified installer is a person who installs, maintains, relocates and removes the air conditioners made by Toshiba Carrier Corporation. He or she has been trained to install, maintain, relocate and remove the air conditioners made by Toshiba Carrier Corporation or, alternatively, he or she has been instructed in such operations by an individual or individuals who have been trained and is thus thoroughly acquainted with the knowledge related to these operations. • The qualified installer who is allowed to do the electrical work involved in installation, relocation and removal has the qualifications pertaining to this electrical work as stipulated by the local laws and regulations, and he or she is a person who has been trained in matters relating to electrical work on the air conditioners made by Toshiba Carrier Corporation or, alternatively, he or she has been instructed in such matters by an individual or individuals who have been trained and is thus thoroughly acquainted with the knowledge related to this work. • The qualified installer who is allowed to do the refrigerant handling and piping work involved in installation, relocation and removal has the qualifications pertaining to this refrigerant handling and piping work as stipulated by the local laws and regulations, and he or she is a person who has been trained in matters relating to refrigerant handling and piping work on the air conditioners made by Toshiba Carrier Corporation or, alternatively, he or she has been instructed in such matters by an individual or individuals who have been trained and is thus thoroughly acquainted with the knowledge related to this work. • The qualified installer who is allowed to work at heights has been trained in matters relating to working at heights with the air conditioners made by Toshiba Carrier Corporation or, alternatively, he or she has been instructed in such matters by an individual or individuals who have been trained and is thus thoroughly acquainted with the knowledge related to this work.
Qualified service person	<ul style="list-style-type: none"> • The qualified service person is a person who installs, repairs, maintains, relocates and removes the air conditioners made by Toshiba Carrier Corporation. He or she has been trained to install, repair, maintain, relocate and remove the air conditioners made by Toshiba Carrier Corporation or, alternatively, he or she has been instructed in such operations by an individual or individuals who have been trained and is thus thoroughly acquainted with the knowledge related to these operations. • The qualified service person who is allowed to do the electrical work involved in installation, repair, relocation and removal has the qualifications pertaining to this electrical work as stipulated by the local laws and regulations, and he or she is a person who has been trained in matters relating to electrical work on the air conditioners made by Toshiba Carrier Corporation or, alternatively, he or she has been instructed in such matters by an individual or individuals who have been trained and is thus thoroughly acquainted with the knowledge related to this work. • The qualified service person who is allowed to do the refrigerant handling and piping work involved in installation, repair, relocation and removal has the qualifications pertaining to this refrigerant handling and piping work as stipulated by the local laws and regulations, and he or she is a person who has been trained in matters relating to refrigerant handling and piping work on the air conditioners made by Toshiba Carrier Corporation or, alternatively, he or she has been instructed in such matters by an individual or individuals who have been trained and is thus thoroughly acquainted with the knowledge related to this work. • The qualified service person who is allowed to work at heights has been trained in matters relating to working at heights with the air conditioners made by Toshiba Carrier Corporation or, alternatively, he or she has been instructed in such matters by an individual or individuals who have been trained and is thus thoroughly acquainted with the knowledge related to this work.

Definition of Protective Gear















When the air conditioner is to be transported, installed, maintained, repaired or removed, wear protective gloves and 'safety' work clothing.

In addition to such normal protective gear, wear the protective gear described below when undertaking the special work detailed in the table below.

Failure to wear the proper protective gear is dangerous because you will be more susceptible to injury, burns, electric shocks and other injuries.

Work undertaken	Protective gear worn
All types of work	Protective gloves 'Safety' working clothing
Electrical-related work	Gloves to provide protection for electricians and from heat Insulating shoes Clothing to provide protection from electric shock
Work done at heights (50 cm or more)	Helmets for use in industry
Transportation of heavy objects	Shoes with additional protective toe cap
Repair of outdoor unit	Gloves to provide protection for electricians and from heat

■ Warning indications on the air conditioner unit

Warning indication	Description		
<table border="1"> <tr> <td data-bbox="176 296 270 459"></td> <td data-bbox="270 296 522 459"> <p>WARNING</p> <p>ELECTRICAL SHOCK HAZARD Disconnect all remote electric power supplies before servicing.</p> </td> </tr> </table>		<p>WARNING</p> <p>ELECTRICAL SHOCK HAZARD Disconnect all remote electric power supplies before servicing.</p>	<p>WARNING</p> <p>ELECTRICAL SHOCK HAZARD Disconnect all remote electric power supplies before servicing.</p>
	<p>WARNING</p> <p>ELECTRICAL SHOCK HAZARD Disconnect all remote electric power supplies before servicing.</p>		
<table border="1"> <tr> <td data-bbox="176 524 270 687"></td> <td data-bbox="270 524 522 687"> <p>WARNING</p> <p>Moving parts. Do not operate unit with grille removed. Stop the unit before the servicing.</p> </td> </tr> </table>		<p>WARNING</p> <p>Moving parts. Do not operate unit with grille removed. Stop the unit before the servicing.</p>	<p>WARNING</p> <p>Moving parts. Do not operate unit with grille removed. Stop the unit before the servicing.</p>
	<p>WARNING</p> <p>Moving parts. Do not operate unit with grille removed. Stop the unit before the servicing.</p>		
<table border="1"> <tr> <td data-bbox="176 749 270 912"></td> <td data-bbox="270 749 522 912"> <p>CAUTION</p> <p>High temperature parts. You might get burned when removing this panel.</p> </td> </tr> </table>		<p>CAUTION</p> <p>High temperature parts. You might get burned when removing this panel.</p>	<p>CAUTION</p> <p>High temperature parts. You might get burned when removing this panel.</p>
	<p>CAUTION</p> <p>High temperature parts. You might get burned when removing this panel.</p>		
<table border="1"> <tr> <td data-bbox="176 974 270 1137"></td> <td data-bbox="270 974 522 1137"> <p>CAUTION</p> <p>Do not touch the aluminum fins of the unit. Doing so may result in injury.</p> </td> </tr> </table>		<p>CAUTION</p> <p>Do not touch the aluminum fins of the unit. Doing so may result in injury.</p>	<p>CAUTION</p> <p>Do not touch the aluminium fins of the unit. Doing so may result in injury.</p>
	<p>CAUTION</p> <p>Do not touch the aluminum fins of the unit. Doing so may result in injury.</p>		
<table border="1"> <tr> <td data-bbox="176 1198 270 1361"></td> <td data-bbox="270 1198 522 1361"> <p>CAUTION</p> <p>BURST HAZARD Open the service valves before the operation, otherwise there might be the burst.</p> </td> </tr> </table>		<p>CAUTION</p> <p>BURST HAZARD Open the service valves before the operation, otherwise there might be the burst.</p>	<p>CAUTION</p> <p>BURST HAZARD Open the service valves before the operation, otherwise there might be the burst.</p>
	<p>CAUTION</p> <p>BURST HAZARD Open the service valves before the operation, otherwise there might be the burst.</p>		

1 PRECAUTIONS FOR SAFETY

- Ensure that all Local, National and International regulations are satisfied.
- Read this "PRECAUTIONS FOR SAFETY" carefully before Installation.
- The precautions described below include the important items regarding safety. Observe them without fail.
- After the installation work, perform a trial operation (test run) to check for any problem. Follow the Owner's Manual to explain how to use and maintain the unit to the customer.
- Turn off the main power supply switch (or breaker) before the unit maintenance.
- Ask the customer to keep the Installation Manual together with the Owner's Manual.

The manufacturer shall not assume any liability for the damage caused by not observing the description of this manual.

WARNING

General

- Before starting to install the air conditioner, read through the Installation Manual carefully, and follow its instructions to install the air conditioner.
- Only a qualified installer(*1) or qualified service person(*1) is allowed to do installation work. Inappropriate installation may result in water leakage, electric shock or fire.
- Do not use any refrigerant different from the one specified for complement or replacement. Otherwise, abnormally high pressure may be generated in the refrigeration cycle, which may result in a failure or explosion of the product or an injury to your body.
- Before opening the front panel of the indoor unit or service panel of the outdoor unit, set the circuit breaker to the OFF position. Failure to set the circuit breaker to the OFF position may result in electric shocks through contact with the interior parts. Only a qualified installer(*1) or qualified service person(*1) is allowed to remove the front panel of the indoor unit or service panel of the outdoor unit and do the work required.
- Before carrying out the installation, maintenance, repair or removal work, be sure to set the circuit breaker to the OFF position. Otherwise, electric shocks may result.
- Place a "Work in progress" sign near the circuit breaker while the installation, maintenance, repair or removal work is being carried out. There is a danger of electric shocks if the circuit breaker is set to ON by mistake.
- Only a qualified installer(*1) or qualified service person(*1) is allowed to undertake work at heights using a stand of 50 cm or more or to remove the front panel of the indoor unit to undertake work.
- Wear protective gloves and safety work clothing during installation, servicing and removal.
- Do not touch the aluminium fin of the unit. You may injure yourself if you do so. If the fin must be touched for some reason, first put on protective gloves and safety work clothing, and then proceed.
- Do not climb onto or place objects on top of the outdoor unit. You may fall or the objects may fall off of the outdoor unit and result in injury.
- When work is performed at heights, use a ladder which complies with the ISO 14122 standard, and follow the procedure in the ladder's instructions. Also wear a helmet for use in industry as protective gear to undertake the work.
- Before cleaning the filter or other parts of the outdoor unit, set the circuit breaker to OFF without fail, and place a "Work in progress" sign near the circuit breaker before proceeding with the work.
- Before working at heights, put a sign in place so that no-one will approach the work location, before proceeding with the work. Parts and other objects may fall from above, possibly injuring a person below. While carrying out the work, wear a helmet for protection from falling objects.
- The refrigerant used by this air conditioner is the R410A.
- The air conditioner must be transported in stable condition. If any part of the product is broken, contact the dealer.
- When the air conditioner must be transported by hand, carry it by two or more people.
- Do not move or repair any unit by yourself. There is high voltage inside the unit. You may get electric shock while removing the cover and main unit.

Selection of installation location

- When the air conditioner is installed in a small room, provide appropriate measures to ensure that the concentration of refrigerant leakage occur in the room does not exceed the critical level.
- Do not install the air conditioner in a location that may be subject to a risk of exposure to a combustible gas. If a combustible gas leaks and becomes concentrated around the unit, a fire may occur.
- To transport the air conditioner, wear shoes with additional protective toe caps.
- To transport the air conditioner, do not take hold of the bands around the packing carton. You may injure yourself if the bands should break.
- Do not place any combustion appliance in a place where it is directly exposed to the wind of air conditioner, otherwise it may cause imperfect combustion.
- Do not install in a location where flammable gas leaks are possible. If the gas leak and accumulate around the unit, it may ignite and cause a fire.
- Install the indoor unit at least 2.5 m above the floor level since otherwise the users may injure themselves or receive electric shocks if they poke their fingers or other objects into the indoor unit while the air conditioner is running.

Installation

- Install the air conditioner securely in a location where the base can sustain the weight adequately. If the strength is not enough, the unit may fall down resulting in injury.
- Follow the instructions in the Installation Manual to install the air conditioner. Failure to follow these instructions may cause the product to fall down or topple over or give rise to noise, vibration, water leakage or other trouble.
- Carry out the specified installation work to guard against the possibility of high winds and earthquake. If the air conditioner is not installed appropriately, a unit may topple over or fall down, causing an accident.
- If refrigerant gas has leaked during the installation work, ventilate the room immediately. If the leaked refrigerant gas comes in contact with fire, noxious gas may generate.
- Use forklift to carry in the air conditioner units and use winch or hoist at installation of them.

Refrigerant piping

- Install the refrigerant pipe securely during the installation work before operating the air conditioner. If the compressor is operated with the valve open and without refrigerant pipe, the compressor sucks air and the refrigeration cycles is over pressurized, which may cause a injury.
- Tighten the flare nut with a torque wrench in the specified manner. Excessive tighten of the flare nut may cause a crack in the flare nut after a long period, which may result in refrigerant leakage.
- After the installation work, confirm that refrigerant gas does not leak. If refrigerant gas leaks into the room and flows near a fire source, such as a cooking range, noxious gas may be generated.
- When the air conditioner has been installed or relocated, follow the instructions in the Installation Manual and purge the air completely so that no gases other than the refrigerant will be mixed in the refrigerating cycle. Failure to purge the air completely may cause the air conditioner to malfunction.
- Nitrogen gas must be used for the airtight test.
- The charge hose must be connected in such a way that it is not slack.

Electrical wiring

- Only a qualified installer(*1) or qualified service person(*1) is allowed to carry out the electrical work of the air conditioner. Under no circumstances must this work be done by an unqualified individual since failure to carry out the work properly may result in electric shocks and/or electrical leaks.
- To connect the electrical wires, repair the electrical parts or undertake other electrical jobs, wear gloves to provide protection for electricians and from heat, insulating shoes and clothing to provide protection from electric shocks. Failure to wear this protective gear may result in electric shocks.
- Use wiring that meets the specifications in the Installation Manual and the stipulations in the local regulations and laws. Use of wiring which does not meet the specifications may give rise to electric shocks, electrical leakage, smoking and/or a fire.
- Connect earth wire. (grounding work)
Incomplete grounding causes an electric shock.
- Do not connect earth wires to gas pipes, water pipes, and lightning conductor or telephone earth wires.
- After completing the repair or relocation work, check that the earth wires are connected properly.
- Install a circuit breaker that meets the specifications in the installation manual and the stipulations in the local regulations and laws.
- Install the circuit breaker where it can be easily accessed by the agent.
- When installing the circuit breaker outdoors, install one which is designed to be used outdoors.
- Under no circumstances the power wire must not be extended. Connection trouble in the places where the wire is extended may give rise to smoking and/or a fire.
- Electrical wiring work shall be conducted according to law and regulation in the community and installation manual. Failure to do so may result in electrocution or short circuit.

Test run

- Before operating the air conditioner after having completed the work, check that the electrical control box cover of the indoor unit and service panel of the outdoor unit are closed, and set the circuit breaker to the ON position. You may receive an electric shock if the power is turned on without first conducting these checks.
- If there is any kind of trouble (such as an error display has appeared, smell of burning, abnormal sounds, the air conditioner fails to cool or heat or water is leaking) has occurred in the air conditioner, do not touch the air conditioner yourself but set the circuit breaker to the OFF position, and contact a qualified service person. Take steps to ensure that the power will not be turned on (by marking "out of service" near the circuit breaker, for instance) until qualified service person(*1) arrives. Continuing to use the air conditioner in the trouble status may cause mechanical problems to escalate or result in electric shocks or other trouble.
- After the work has finished, use an insulation tester set (500 V Megger) to check the resistance is 1 MΩ or more between the charge section and the non-charge metal section (earth section). If the resistance value is low, a disaster such as a leak or electric shock is caused at user's side.
- Upon completion of the installation work, check for refrigerant leaks and check the insulation resistance and water drainage. Then conduct a test run to check that the air conditioner is operating properly.

Explanations given to user

- Upon completion of the installation work, tell the user where the circuit breaker is located. If the user does not know where the circuit breaker is, he or she will not be able to turn it off in the event that trouble has occurred in the air conditioner.
- If the fan grille is damaged, do not approach the outdoor unit but set the circuit breaker to the OFF position, and contact a qualified service person(*1) to have the repairs done. Do not set the circuit breaker to the ON position until the repairs are completed.
- After the installation work, follow the Owner's Manual to explain to the customer how to use and maintain the unit.

Relocation

- Only a qualified installer(*1) or qualified service person(*1) is allowed to relocate the air conditioner. It is dangerous for the air conditioner to be relocated by an unqualified individual since a fire, electric shocks, injury, water leakage, noise and/or vibration may result.
- While carrying out the pump-down work shut down the compressor before disconnecting the refrigerant pipe. Disconnecting the refrigerant pipe with the service valve left open and the compressor still operating will cause air or other gas to be sucked in, raising the pressure inside the refrigeration cycle to an abnormally high level, and possibly resulting in rupture, injury or other trouble.

 **CAUTION**

New refrigerant air conditioner installation

- **This air conditioner adopts the new HFC refrigerant (R410A) which does not destroy ozone layer.**
- The characteristics of R410A refrigerant are; easy to absorb water, oxidizing membrane or oil, and its pressure is approx. 1.6 times higher than that of refrigerant R22. Accompanied with the new refrigerant, refrigerating oil has also been changed. Therefore, during installation work, be sure that water, dust, former refrigerant, or refrigerating oil does not enter the refrigerating cycle.
- To prevent charging an incorrect refrigerant and refrigerating oil, the sizes of connecting sections of charging port of the main unit and installation tools are changed from those for the conventional refrigerant.
- Accordingly the exclusive tools are required for the new refrigerant (R410A).
- For connecting pipes, use new and clean piping designed for R410A, and please care so that water or dust does not enter.

To disconnect the appliance from main power supply.









- This appliance must be connected to the main power supply by means of a switch with a contact separation of at least 3 mm.

The installation fuse (all types can be used) must be used for the power supply line of this conditioner.

Install the indoor unit at least 2.0 m above the floor level since otherwise the users may injure themselves or receive electric shocks if they poke their fingers or other objects into the indoor unit while the air conditioner is running.

(*1) Refer to the "Definition of Qualified Installer or Qualified Service Person".

2 ACCESSORY PARTS

Part name	Q'ty	Shape	Usage
Installation Manual	1	This manual	(Hand over to customers) (For other languages that do not appear in this installation Manual, please refer to the enclosed CD-R.)
Owner's Manual	1		(Hand over to customers) (For other languages that do not appear in this installation Manual, please refer to the enclosed CD-R.)
CD-ROM	1	-	Owner's Manual and Installation Manual.
Installation plate	1		
Wireless remote controller	1		
Battery	2		
Remote controller holder	1		
Mounting screw $\varnothing 4 \times 25l$	6		
Pan head wood screw $\varnothing 3.1 \times 16l$	2		
Screw $\varnothing 4 \times 10l$	2		
Heat insulator	1		

3 SELECTION OF INSTALLATION PLACE

WARNING

- **Install the air conditioner at enough strong place to withstand the weight of the unit.**
If the strength is not enough, the unit may fall down resulting in injury.

CAUTION

- **Do not install the air conditioner in a location subject to a risk of exposure to a combustible gas.**
If a combustible gas leaks and stays around the unit, a fire may occur.

Upon approval of the customer, install the air conditioner in a place that satisfies the following conditions.

- Place where the unit can be installed horizontally.
- Place where a sufficient servicing space can be ensured for safety maintenance and check.
- Place where drained water will not cause any problem.

Avoid installing in the following places.

Select a location for the indoor unit where the cool or warm air will circulate evenly.

Avoid installation in the following kinds of locations.

- Saline area (coastal area).
- Locations with acidic or alkaline atmospheres (such as areas with hot springs, factories where chemicals or pharmaceuticals are made and places where the exhaust air from combustion appliances will be sucked into the unit).
Doing so may cause the heat exchanger (its aluminum fins and copper pipes) and other parts to become corroded.
- Locations with atmospheres with mist of cutting oil or other types of machine oil.
Doing so may cause the heat exchanger to become corroded, mists caused by the blockage of the heat exchanger to be generated, the plastic parts to be damaged, the heat insulators to peel off, and other such problems to result.
- Places where iron or other metal dust is present. If iron or other metal dust adheres to or collects on the interior of the air conditioner, it may spontaneously combust and start a fire.
- Locations where vapors from food oils are formed (such as kitchens where food oils are used).
Blocked filters may cause the air conditioner's performance to deteriorate, condensation to form, the plastic parts to be damaged, and other such problems to result.
- Locations near obstructions such as ventilation openings or lighting fixtures where the flow of the blown air will be disrupted (a disruption of the air flow may cause the air conditioner's performance to deteriorate or the unit to shut down).
- Locations where an in-house power generator is used for the power supply.
The power line frequency and voltage may fluctuate, and the air conditioner may not work properly as a result.
- On truck cranes, ships or other moving conveyances.
- The air conditioner must not be used for special applications (such as for storing food, plants, precision instruments or art works).
(The quality of the items stored may be degraded.)
- Locations where high frequencies are generated (by inverter equipment, in-house power generators, medical equipment or communication equipment).
(Malfunctioning or control trouble in the air conditioner or noise may adversely affect the equipment's operation.)
- Locations where there is anything under the unit installed that would be compromised by wetness.
(If the drain has become blocked or when the humidity is over 80 %, condensation from the indoor unit will drip, possibly causing damage to anything underneath.)
- In the case of the wireless type of system, rooms with the inverter type of fluorescent lighting or locations exposed to direct sunlight.
(The signals from the wireless remote controller may not be sensed.)
- Locations where organic solvents are being used.
- The air conditioner cannot be used for liqueed carbonic acid cooling or in chemical plants.
- Location near doors or windows where the air conditioner may come into contact with high-temperature, high-humidity outdoor air.
(Condensation may occur as a result.)
- Locations where special sprays are used frequently.

■ Installation diagram of Indoor and outdoor units

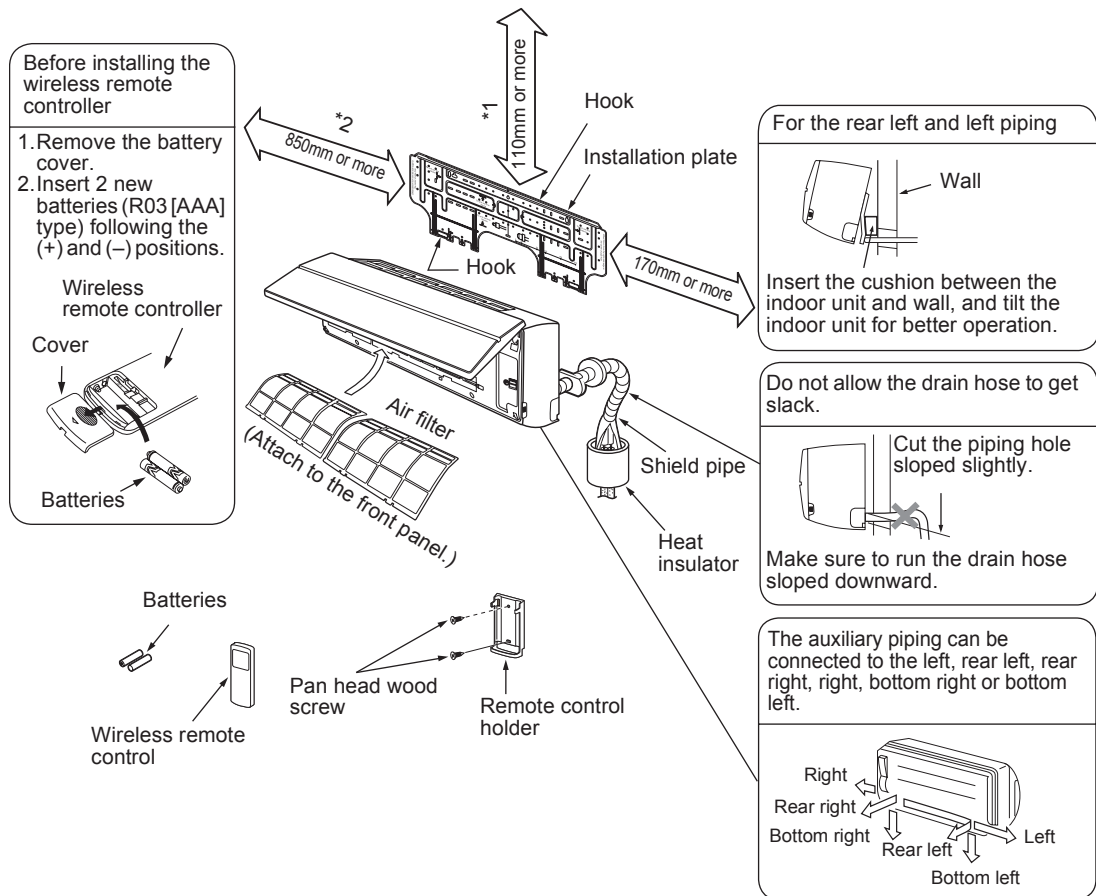

■ Installation space

The indoor unit shall be installed so that its top surface comes at a height of 2m or more. Also it must be avoided to put anything on top of the indoor unit.

*1 Reserve space required to install the indoor unit and for service work.

Keep 110mm or more for clearance between top plate of the indoor unit and the ceiling surface.

*2 Provide a space as shown for service clearance for the cross flow fan.

■ Installation place

- A place which provides the spaces around the indoor unit as shown in the above diagram.
- A place where there is no obstacle near the air inlet and outlet.
- A place that allows easy installation of the piping to the outdoor unit.
- A place which allows the front panel to be opened.

⚠ CAUTION

- Direct sunlight to the indoor unit's wireless receiver should be avoided.
- The microprocessor in the indoor unit should not be too close to RF noise sources. (For details, see the owner's manual.)

5 CUTTING A HOLE AND MOUNTING INSTALLATION PLATE

■ Cutting a hole

In case of installing the refrigerant pipes from the rear:

1. Decide the hole position for piping at 180mm from the arrow mark (⇒) on the installation plate and drill a hole at a slight downward slant toward outdoor side.
Pipe hole; dia.65mm: AP007-AP018 type
Pipe hole; dia.80mm: AP024 type

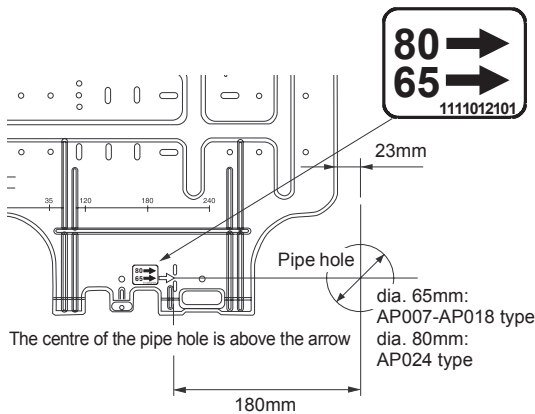

NOTE

- When drilling a wall that contains a metal lath, wire lath or metal plate, be sure to use a pipe hole brim ring sold separately.

■ Mounting the installation plate

Be sure that the installation plate is fix to the wall with screws to make the indoor unit fit to the wall.

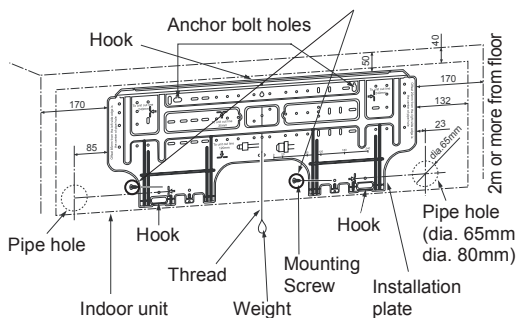

■ When the installation plate is directly mounted on the wall

1. Securely fit the installation plate onto the wall by screwing it in the upper and lower parts to hook up the indoor unit.
2. To mount the installation plate on a concrete wall with anchor bolts, utilize the anchor bolt holes as illustrated in the above figure.
3. Install the installation plate horizontally in the wall.

⚠ CAUTION

When installing the installation plate with a mounting screw, do not use the anchor bolt hole. Otherwise the unit may fall down and result in personal injury and property damage.

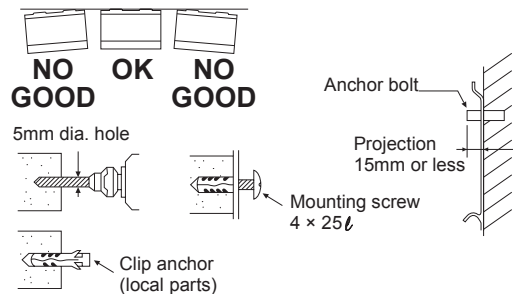

⚠ CAUTION

Failure to firmly install the unit may result in personal injury and property damage if the unit falls.

- In case of block, brick, concrete or similar type walls, make 5mm dia. holes in the wall.
- Insert clip anchors for appropriate mounting screws.

NOTE

- Secure four corners and lower parts of the installation plate with 6 mounting screws to install it.

6 PIPING AND DRAIN HOSE INSTALLATION

■ Piping and drain hose forming

* Apply heat-insulation for both refrigerant pipe and drain hose surely so that no dew generates inside of the equipment. (Use polyethylene foam for insulating material.)

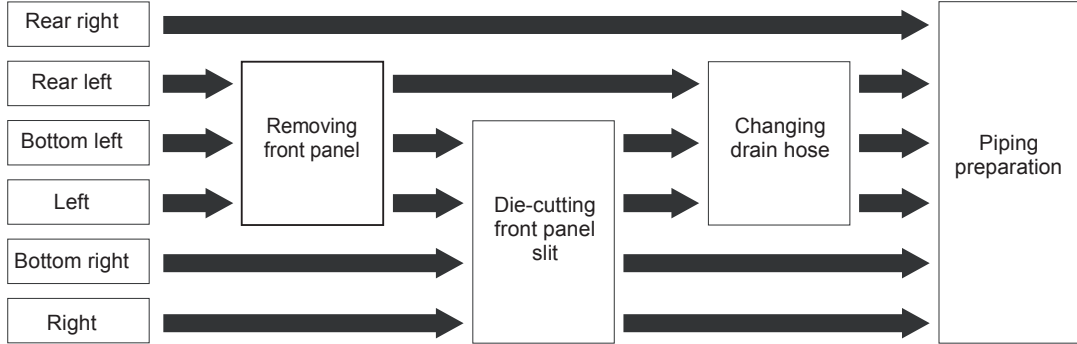

1. Remove the front panel

The front panel must be removed for piping connections in the left, bottom left, and rear left directions.

- Open the air inlet grille upward.
- Remove the four screws securing the front panel.
- Slightly open the lower part of the front panel, and then pull the upper part of the front panel toward you to remove it from the rear plate.

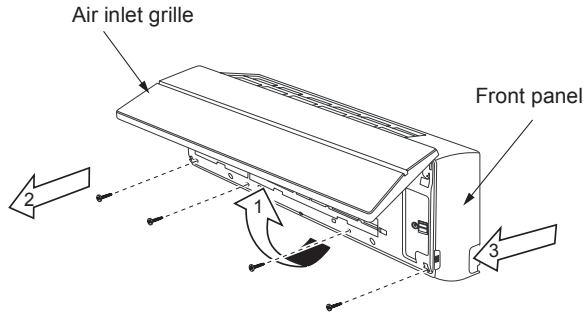

2. Die-cutting front panel slit

Cut out the slit on the leftward or right side of the front panel for the left or right connection and the slit on the bottom left or right side of the front panel for the bottom left or right connection with a pair of nippers.

3. Changing drain hose

For leftward connection, bottom-leftward connection and rear leftward connection's piping, it is necessary to change the drain hose and drain cap.

Without changing the drain hose position, the indoor unit will not fit to the wall.

How to remove the drain hose

- The drain hose can be removed by removing the screw securing the drain hose and then pulling out the drain hose.
- When removing the drain hose, be careful of any sharp edges of steel plate. The edges can injuries.
- To install the drain hose, insert the drain hose firmly until the connection part contacts with heat insulator, and the secure it with original screw.

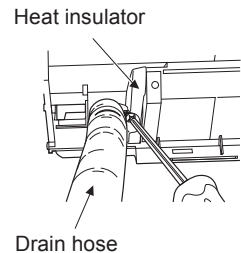

How to remove the drains cap

Clip the drain cap by needle-nose pliers and pull out.

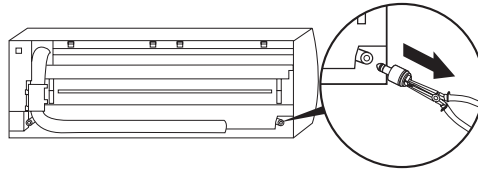

How to fix the drains cap

1) Insert hexagonal wrench (dia. 4mm) in a centre head.

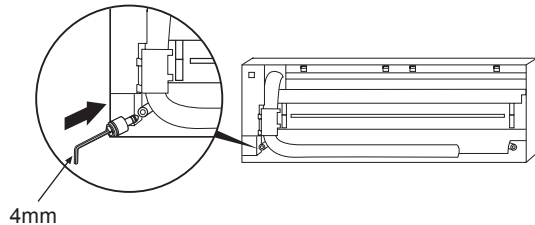

2) Firmly insert drains cap.

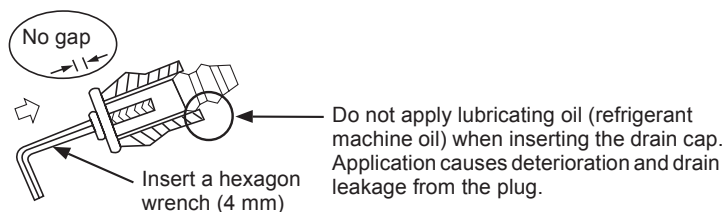

⚠ CAUTION

Firmly insert the drain hose and drain cap; otherwise, water may leak.

How to remove the drain hose

- 1) Remove the front panel.
- 2) Remove the screws of drain hose.
- 3) Pull out the drain hose.

How to fix the drain hose

- 1) Put the drain hose.
- 2) Screw the drain hose to the indoor unit.
- 3) Install the front panel.

▼ In case of right or left piping

- After scribing slits of the front panel with a knife or a marking-off pin, cut them with a pair of nippers or an equivalent tool.

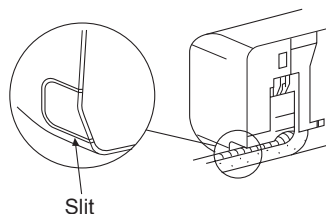

▼ In case of bottom right or bottom left piping

- After scribing slits of the front panel with a knife or a marking-off pin, cut them with a pair of nippers or an equivalent tool.

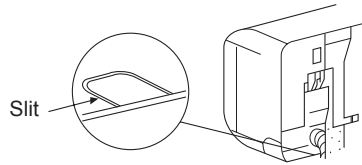

▼ Left-hand connection with piping

Bend the connecting pipe so that it is laid within 43mm above the wall surface. If the connecting pipe is laid exceeding 43mm above the wall surface, the indoor unit may unstably be set on the wall. When bending the connecting pipe, make sure to use a spring bender so as not to crush the pipe.

Bend the connection pipe within a radius of 30 mm.

To connect the pipe after installation of the unit (figure)

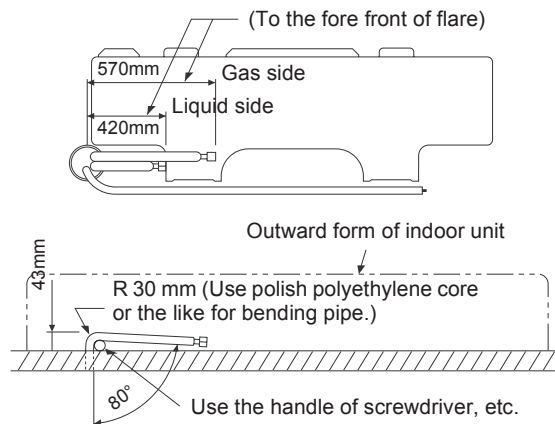

NOTE

If the pipe is bent incorrectly, the indoor unit may unstably be set on the wall.

After passing the connecting pipe through the pipe hole, connect the connecting pipe to the auxiliary pipes and wrap the facing tape around them.

⚠ CAUTION

- Bind the auxiliary pipes (two) and power supply wiring and control wiring with facing tape tightly. In case of leftward piping and rear leftward piping, bind the auxiliary pipes (two) only with facing tape.

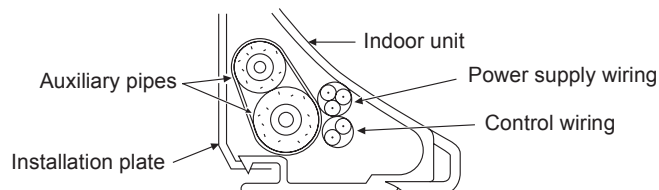

- Carefully arrange pipes so that any pipe does not stick out of the rear plate of the indoor unit.
- Carefully connect the auxiliary pipes and connecting pipes to one another and cut off the insulating tape wound on the connecting pipe to avoid double-taping at the joint, moreover, seal the joint with the vinyl tape, etc.
- Since dew results in a machine trouble, make sure to insulate both the connecting pipes. (Use polyethylene foam as insulating material.)
- When bending a pipe, carefully do it, not to crush it.

7 INDOOR UNIT FIXING

1. Pass the pipe through the hole in the wall, and hook the indoor unit on the installation plate at the upper hooks.
2. Swing the indoor unit to right and left to confirm that it is firmly hooked up on the installation plate.
3. While pressing the indoor unit onto the wall, hook it at the lower part on the installation plate. Pull the indoor unit toward you to confirm that it is firmly hooked up on the installation plate.

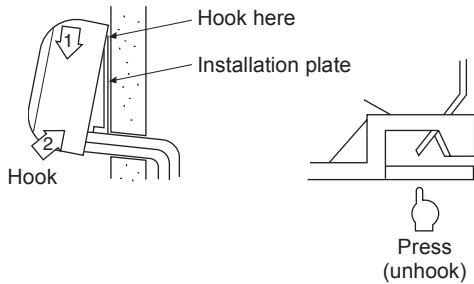

- For detaching the indoor unit from the installation plate, pull the indoor unit toward you while pushing its bottom up at the specified parts.

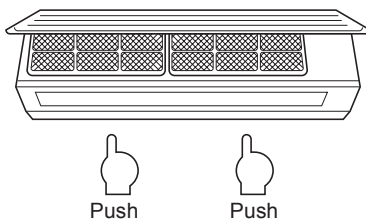

REQUIREMENT

The lower part of indoor unit may float, due to the condition of piping and you cannot fix it to the installation plate. In that case, use the screws provided to fix the unit and the installation plate. **Especially when the pipes are pulled out from the left side, the unit must be screwed to the installation plate.**

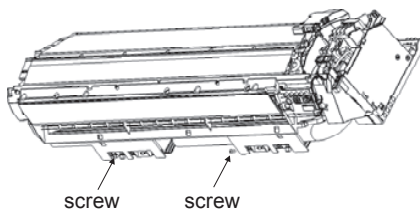

8 DRAINAGE

1. Run the drain hose sloped downwards.

NOTE

- Hole should be made at a slight downward slant on the outdoor side.
2. Put water in the drain pan and make sure that the water is drained out of doors.
 3. When connecting extension drain hose, insulate the connecting part of extension drain hose with shield pipe.

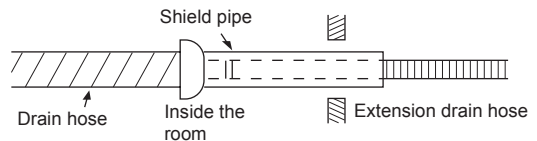
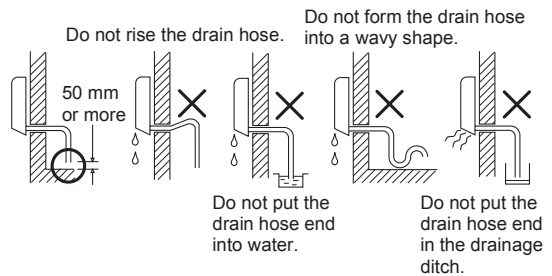

CAUTION

Arrange the drain pipe for proper drainage from the unit. Improper drainage can result in dew-dropping.

This air conditioner has the structure designed to drain water collected from dew, which forms on the back of the indoor unit, to the drain pan. Therefore, do not store the power cord and other parts at a height above the drain guide.

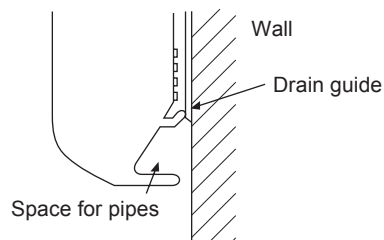

9 REFRIGERANT PIPING

Refrigerant Piping

1. Use copper pipe with 0.8 mm or more thickness. (In case pipe size is dia. 15.9, with 1.0mm or more.)
2. Flare nut and flare works are also different from those of the conventional refrigerant. Take out the flare nut attached to the main unit of the air conditioner, and use it.

REQUIREMENT

When the refrigerant pipe is long, provide support brackets at intervals of 2.5 to 3m to clamp the refrigerant pipe. Otherwise, abnormal sound may be generated.



IMPORTANT 4 POINTS FOR PIPING WORK

1. Remove dust and moisture from the inside of the connecting pipes.
2. Tight connection (between pipes and unit)
3. Evacuate the air in the connecting pipes using VACUUM PUMP.
4. Check the gas leakage. (Connected points)

Pipe size

(dia.: mm)

MMK-	AP007 to AP012 type	AP015 to AP018 type	AP024 type
Gas side	9.5	12.7	15.9
Liquid side	6.4	6.4	9.5

Permissible Piping Length and Height Difference

They vary according to the outdoor unit. For details, refer to the Installation Manual attached to the outdoor unit.

Flaring

- Cut the pipe with a pipe cutter. Remove burrs completely. Remaining burrs may cause gas leakage.
- Insert a flare nut into the pipe, and flare the pipe. As the flaring sizes of R410A differ from those of refrigerant R22, the flare tools newly manufactured for R410A are recommended. However, the conventional tools can be used by adjusting projection margin of the copper pipe.

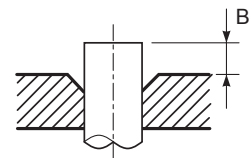

Projection margin in flaring: B (Unit: mm)

Rigid (Clutch type)

Outer dia. of copper pipe	R410A tool used	Conventional tool used
	R410A	R410A
6.4 , 9.5	0 to 0.5	1.0 to 1.5
12.7 , 15.9		

Flaring dia. meter size: A (Unit: mm)

Outer dia. of copper pipe	A ⁺⁰ _{-0.4}
	R410A
6.4	9.1
9.5	13.2
12.7	16.6
15.9	19.7

- * In case of flaring for R410A with the conventional flare tool, pull it out approx. 0.5 mm more than that for R22 to adjust to the specified flare size. The copper pipe gauge is useful for adjusting projection margin size.

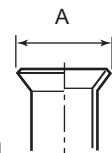

Tightening connection

CAUTION

- Do not apply excessive torque. Otherwise, the nut may crack depending on the conditions.

(Unit: N•m)

Outer dia. of copper pipe	Tightening torque
6.4 mm (dia.)	14 to 18 (1.4 to 1.8 kgf•m)
9.5 mm (dia.)	33 to 42 (3.3 to 4.2 kgf•m)
12.7 mm (dia.)	50 to 62 (5.0 to 6.2 kgf•m)
15.9 mm (dia.)	68 to 82 (6.8 to 8.2 kgf•m)

▼ Tightening torque of flare pipe connections

Pressure of R410A is higher than that of R22. (Approx. 1.6 times) Therefore, using a torque wrench, tighten the flare pipe connecting sections which connect the indoor and outdoor units of the specified tightening torque.

Incorrect connections may cause not only a gas leak, but also a trouble of the refrigeration cycle. Align the centres of the connecting pipes and tighten the flare nut as far as possible with your fingers. Then tighten the nut with a spanner and torque wrench as shown in the figure.

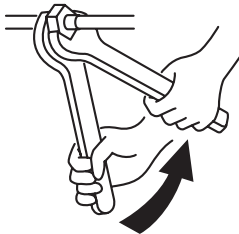

Work using double spanner

REQUIREMENT

Tightening with an excessive torque may crack the nut depending on installation conditions. Tighten the nut within the specified tightening torque.

Piping with outdoor unit

- Shape of valve differs according to the outdoor unit.
For details of installation, refer to the Installation Manual of the outdoor unit.

Heat insulation

Heat insulation for the pipes should be done separately for the liquid side and gas side. Because both of the liquid and gas side pipes become a low temperature during cooling operation, sufficient heat insulation should be done to prevent condensation.

- Heat insulator with a heat resistance of 120°C or more must be used for the gas side pipe.
- The pipe connection section of the indoor unit must be heat insulated securely and compactly with the attached heat insulator.

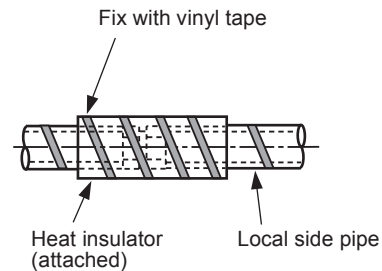

■ Airtight test/Air purge, etc.

For airtight test, air purge, addition of refrigerant, and gas leak check, follow the Installation Manual attached to the outdoor unit.

■ Open fully valves of the outdoor unit

■ Gas leak check

Check with a leak detector or soap water whether gas leaks or not, from the pipe connecting section or cap of the valve.

REQUIREMENT

Use a leak detector manufactured exclusively HFC refrigerant (R410A, R134a, etc.).

10 ELECTRIC WORK

WARNING

1. **Using the specified wires, ensure to connect the wires, and fix wires securely so that the external tension to the wires do not affect the connecting part of the terminals.**
Incomplete connection or fixation may cause a fire, etc.
2. **Be sure to connect earth wire. (grounding work)**
Incomplete grounding cause an electric shock. Do not connect ground wires to gas pipes, water pipes, lightning rods or ground wires for telephone wires.
3. **Appliance shall be installed in accordance with national wiring regulations.**
Capacity shortage of power circuit or incomplete installation may cause an electric shock or a fire.

- Run the refrigerant piping line and control wiring line in the same line.
- Do not turn on the power of the indoor unit until vacuuming of the refrigerant pipes completes.

CAUTION

- If incorrect/incomplete wiring is carried out, it will cause an electrical fire or smoke.
- Be sure to install an earth leakage breaker that is not tripped by shock waves.
If an earth leakage breaker is not installed, an electric shock may be caused.
- Be sure to use the cord clamps attached to the product.
- Do not damage or scratch the conductive core and inner insulator of power and inter-connecting wires when peeling them.
- Use the power cord and Inter-connecting wire of specified thickness, type, and protective devices required.
- Never connect 220–240V power to the terminal blocks (U₁, U₂, A, B, etc.) for control wiring.
(Otherwise, the system will fail.)

REQUIREMENT

- For power supply wiring, strictly conform to the Local Regulation in each country.
- For wiring of power supply of the outdoor units, follow the Installation Manual of each outdoor unit.
- Perform the electric wiring so that it does not come to contact with the high-temperature part of the pipe.
The coating may melt resulting in an accident.
- After connecting wires to the terminal blocks, provide a trap and fix wires with the cord clamp.

■ Power supply wire and communication wires specifications

Power supply wire and communication wires are procured locally.

For the power supply specifications, follow the table below. Power supply wiring and communication wiring are to be procured locally.

For specifications of the power capacity of the outdoor unit and the power supply wires, refer to the Installation Manual supplied with the outdoor unit.

Indoor unit power supply

- Prepare an exclusive power supply for the indoor unit independently of the outdoor unit.
- Arrange the power supplies to the indoor and outdoor units, so that a common earth leakage breaker and main switch can be used.
- Power supply wire specification: Cable 3-core 2.5mm², in conformity with Design H07 RN-F or 60245 IEC 57.

▼ Power supply

Power supply	220–240V ~ 50Hz 220V ~ 60Hz
Power supply switch/Earth leakage breaker or power supply wiring/fuse rating for indoor units should be selected by the accumulated total current values of the indoor units.	
Power supply wiring	Below 50m 2.5 mm ²

Control wiring, Central controller wiring

- Use a 2 core non polarity wire.
- To prevent any possible noise issues, use a shielded 2 core wire.
- The total stated length of communication wiring is determined by the interconnecting length of indoor to outdoor wire plus the length of the central control communication wire.

▼ Communication line

Control wiring between indoor units, and outdoor unit (2-core shield wire)	Wire size	(Up to 1000m) 1.25 mm ² (Up to 2000m) 2.0 mm ²
Central control line wiring (2-core shield wire)	Wire size	(Up to 1000m) 1.25 mm ² (Up to 2000m) 2.0 mm ²

Wired remote controller wiring

This wiring is not required when using the supplied wireless remote controller.

- For wiring remote controllers a 2 core non polarity wire must be used.

Wired remote controller wiring, remote controller inter-unit wiring	Wire size: 0.5mm ² to 2.0mm ²	
Total wire length of wired remote controller wiring and remote controller inter-unit wiring = L + L1 + L2 + ... Ln	In case of wired type only	Up to 500m
	In case of wireless type included	Up to 400m
Total wire length of wired remote controller inter-unit wiring = L1 + L2 + ... Ln	Up to 200m	

CAUTION

The remote controller wire (Communication line) and AC220–240V wires cannot be parallel to contact each other and cannot be stored in the same conduits. If doing so, a trouble may be caused on the control system due to noise, etc.

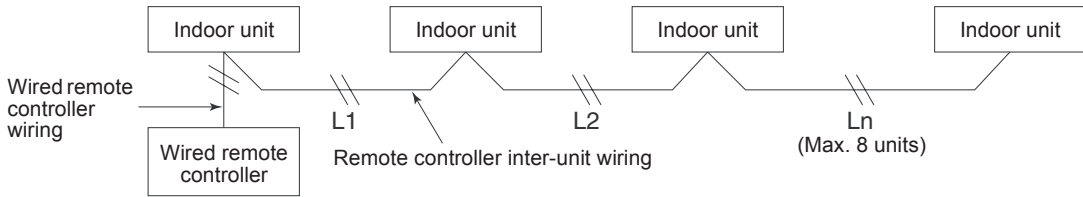

Control wiring between indoor and outdoor units

NOTE

An outdoor unit that is interconnected to the indoor units automatically becomes the header unit.

▼ Wiring example

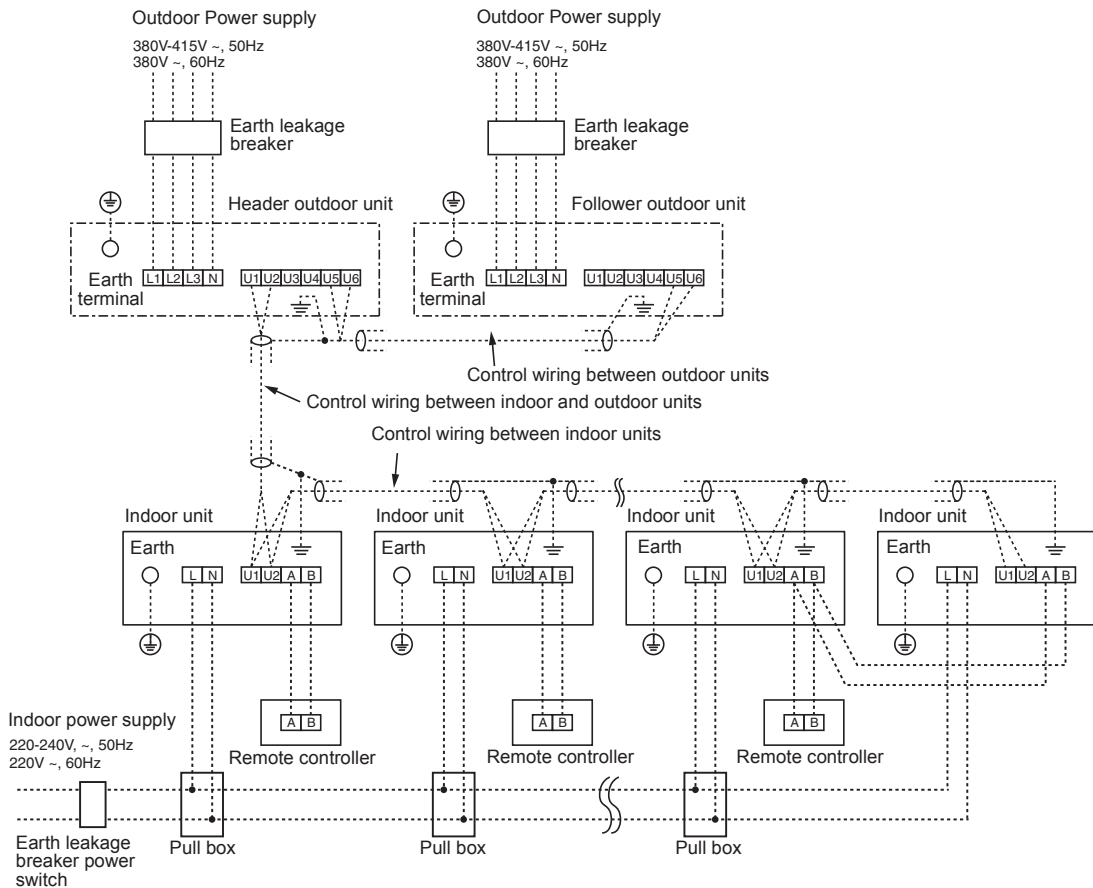

Address setup

Set up the addresses as per the Installation Manual supplied with the outdoor unit.

■ Wired remote controller wiring

- As the wired remote controller wire has non-polarity, there is no problem if connections to indoor unit terminal blocks A and B are reversed.

▼ Wiring diagram

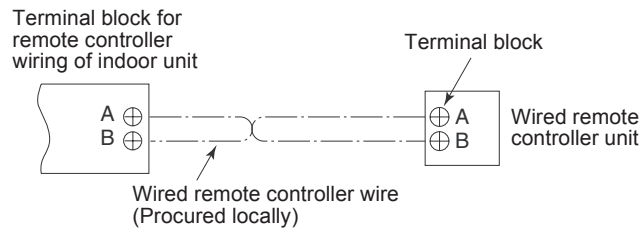

■ Wiring Connection

How to connect the power supply wiring and control wiring

The power supply wire and the control wire can be connected without removing the front panel.

REQUIREMENT

Connect the power supply wire after connecting the control wire for this model.

1. Remove the air inlet grille.
Open the air inlet grille upward and pull it toward you.
2. Remove the terminal cover and the clamp base.
3. Insert the power supply wire and control wire (according to the local rule) into the pipe hole on the wall.
4. Take the power supply wire out of the cable slot on the rear panel so that it protrudes about 150mm from the front.
5. Insert the control wire fully into the control/wired remote controller terminal block (U₁, U₂, A, B) and secure it tightly with screws.
6. Clamp the control wire with the cord clamp.
7. Install the clamp base with a screw.
8. Insert the power supply wire fully into the terminal block and secure it tightly with screws. Tightening torque: 1.2 N·m (0.12 kgf·m) Secure the earth line with the earth screw.
9. Clamp the power supply wire with the cord clamp.
10. Attach the terminal cover and the air inlet grille to the indoor unit.

⚠ CAUTION

- Be sure to refer to the wiring diagram attached inside the front panel.
- Check local electrical cords and also any specific wiring instructions and limitations.
- Do not catch the control wire when installing the clamp base.

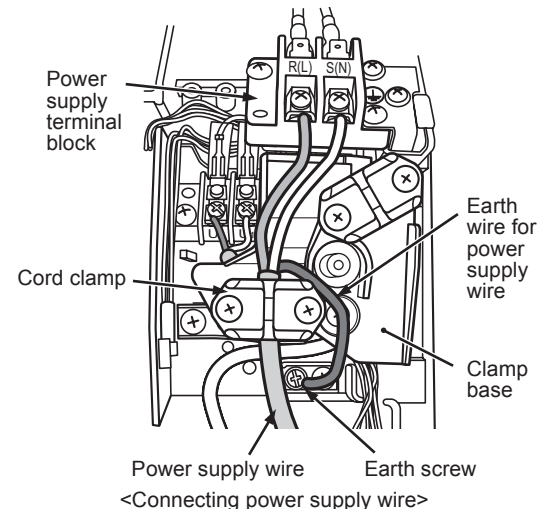
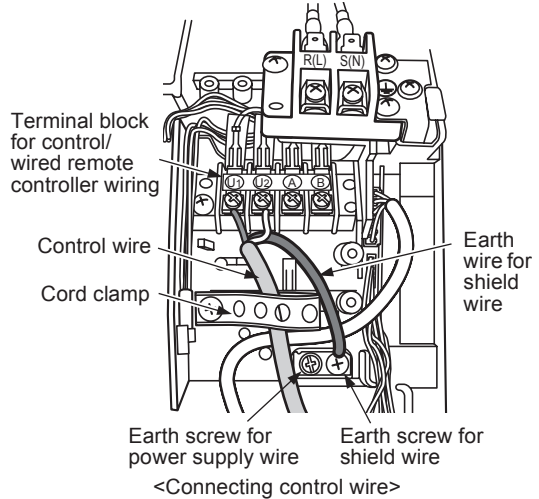
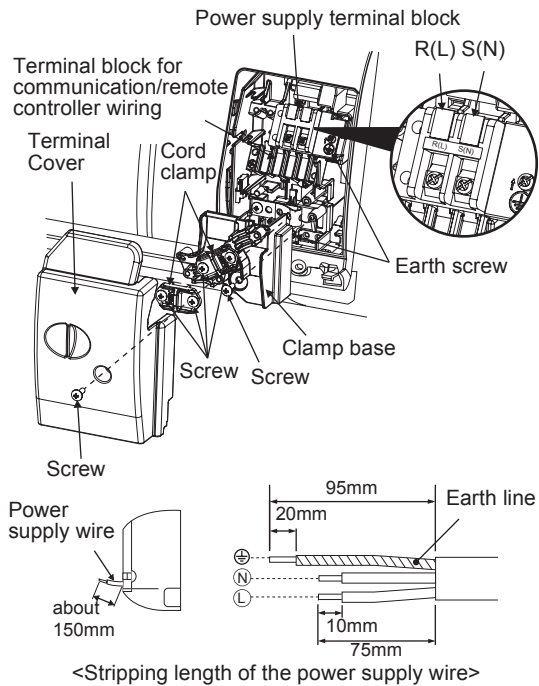
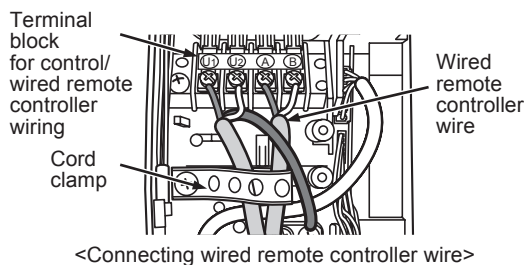

■ Wiring connection for flow selector unit

How to connect the wiring of flow selector unit

Connect the power supply wire and the communication wire supplied with the flow selector unit to the indoor unit.

1. Remove the air inlet grille.
Open the air inlet grille upward and pull it toward you.
2. Remove the four screws securing the front panel.
3. Slightly open the lower part of the front panel, and then pull the upper part of the front panel toward you to remove it from the rear plate.
4. Remove the terminal cover and the clamp base.
5. Insert the control wire fully into the control/wired remote controller terminal block and secure it tightly with screws.
6. Connect the control wire connector of the flow selector unit to the lead with a connector to the left of the control/wired remote controller terminal block.
7. Clamp the control wire and the control wire of the flow selector unit with the cord clamp.
8. Install the clamp base with a screw.
9. Insert the power supply wire fully into the terminal block and secure it tightly with screws.
Tightening torque: 1.2 N·m (0.12 kgf·m)
Secure the earth line with the earth screw.
10. Clamp the power supply wire with the cord clamp.
11. Insert the power supply wire fasten terminal of the flow selector unit into the power supply terminal.
12. Clamp the power supply wire of the flow selector unit tight with the cord clamp.
13. Attach the terminal cover, the front panel and the air inlet grille to the indoor unit.

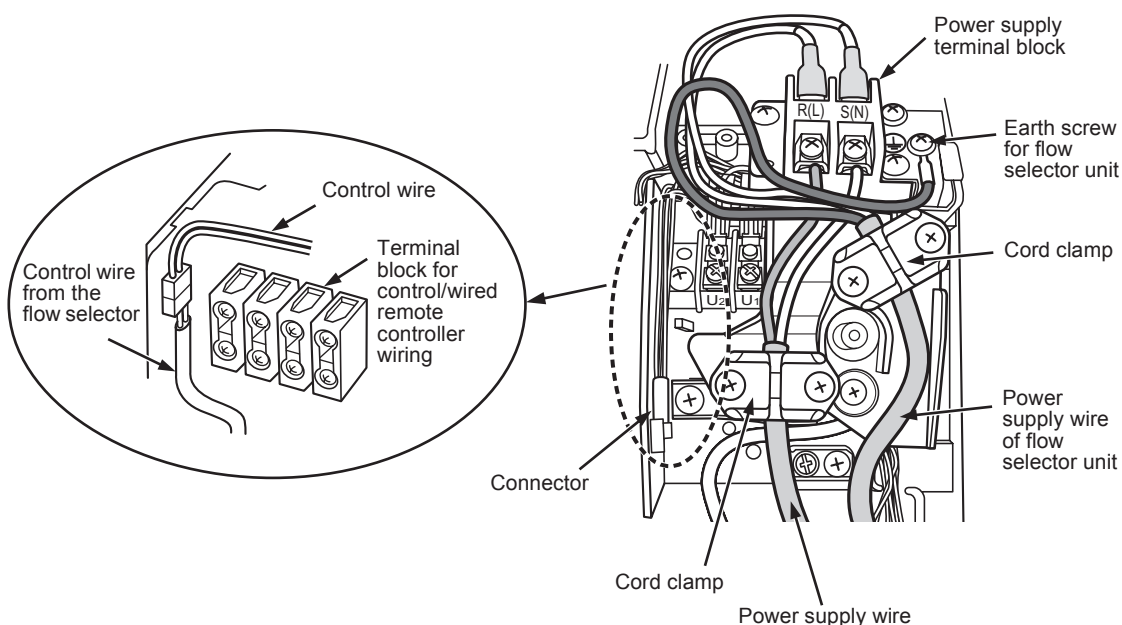

⚠ CAUTION

Confirm that every wires are stored in the electric parts box without getting caught before attaching the terminal cover.

11 APPLICABLE CONTROLS

A wired remote controller is necessary for this function. This function cannot be operate with a wireless remote controller.

REQUIREMENT

- When you use this air conditioner for the first time, it takes approx. 5 minutes until the remote controller becomes available after power-on. This is normal.

<When power is turned on for the first time after installation>

It takes **approx. 5 minutes** until the remote controller becomes available.

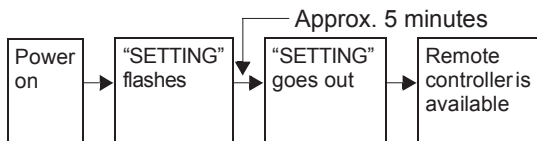

<When power is turned on for the second (or later) time>

It takes **approx. 1 minute** until the remote controller becomes available.

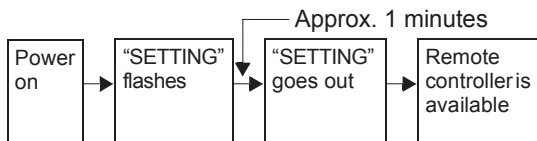

- Normal settings were made when the indoor unit was shipped from factory. Change the indoor unit settings as required.
- Use the wired remote controller to change the settings.
 - * The settings cannot be changed using the wireless remote controller, sub remote controller, or remote-controller less system (for central remote controller only). Therefore, install the wired remote controller to change the settings.

Changing of settings of for applicable controls

Basic procedure for changing settings

Change the settings while the air conditioner is not working.

(Be sure to stop the air conditioner before making settings.)

The display content for setting differs from that on the former types of remote controller (RBC-AMT21E/AMT31E). (The number of CODE No. has increased.)

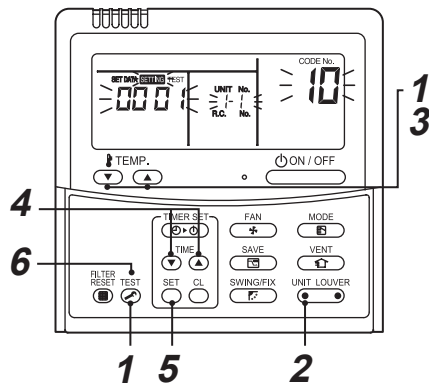

Procedure 1

Push **TEST** button and "TEMP." button simultaneously for at least 4 seconds.

After a while, the display flashes as shown in the figure.

Confirm that the CODE No. is [10].

- If the CODE No. is not [10], push **TEST** button to erase the display content, and repeat the procedure from the beginning.

(No operation of the remote controller is accepted for a while after **TEST** button is pushed.)

(While air conditioners are operated under the group control, "ALL" is displayed first. When

UNIT LOUVER is pushed, the indoor unit number displayed following "ALL" is the header unit.)

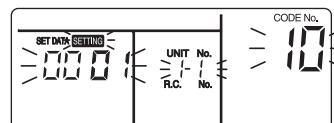

(* Display content varies with the indoor unit model.)

Procedure 2

Each time you push  button, indoor unit numbers in the control group change cyclically. Select the indoor unit you want to change settings for.

The fan of the selected unit runs and the louvers start swinging. You can confirm the indoor unit for which you want to change settings.

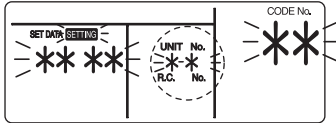

Procedure 3



Using "TEMP."  /  buttons, specify CODE No.. [**].

Procedure 4

Using timer "TIME"  /  buttons, select SET DATA [****].

Procedure 5

Push  button. When the display changes from flashing to lit, the setup is completed.

- To change settings of another indoor unit, repeat from Procedure 2.
 - To change other settings of the selected indoor unit, repeat from Procedure 3.
- Use  button to clear the settings.
To make settings after  button was pushed, repeat from Procedure 2.

Procedure 6

When settings have been completed, push  button to determine the settings.

When  button is pushed, "SETTING" flashes and then the display content disappears and the air conditioner enters the normal stop mode.

(While "SETTING" is flashing, no operation of the remote controller is accepted.)

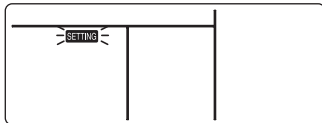

Change of lighting time of filter sign

According to the installation condition, the lighting time of the filter sign (Notification of filter cleaning) can be changed.

Follow to the basic operation procedure

(1 → 2 → 3 → 4 → 5 → 6).

- For the CODE No.. in Procedure 3, specify [01].
- For the [SET DATA] in Procedure 4, select the SET DATA of filter sign lighting time from the following table.

SET DATA	Filter sign lighting time
0000	None
0001	150H (Factory setting)
0002	2500H
0003	5000H
0004	10000H

To secure better effect of heating

When it is difficult to obtain satisfactory heating due to installation place of the indoor unit or structure of the room, the detection temperature of heating can be raised. Also use a circulator, etc. to circulate heat air near the ceiling.

Follow to the basic operation procedure

(1 → 2 → 3 → 4 → 5 → 6).

- For the CODE No.. in Procedure 3, specify [06].
- For the SET DATA in Procedure 4, select the SET DATA of shift value of detection temperature to be set up from the table below.

SET DATA	Detection temp shift value
0000	No shift
0001	+1°C
0002	+2°C
0003	+3°C (Factory setting)
0004	+4°C
0005	+5°C
0006	+6°C

■ Adjustment of air direction

1. Using the remote controller switch, change the up/down air direction by moving the horizontal louver.
2. Adjust the right/left air direction by bending the vertical grille inside of the air outlet port with hands.

REQUIREMENT

Do not touch the horizontal louver directly with hands; otherwise a trouble may be caused. For handling of the horizontal louver, refer to "Owner's Manual" attached to the outdoor unit.

■ Group control

In a group control, a remote controller can control up to maximum 8 units.

- The wired remote controller only can control a group control. The wireless remote controller is unavailable for this control.
- For cabling procedure and cables of the individual line (Identical refrigerant line) system, refer to "Electric work" in this Manual.
- Cabling between indoor units in a group is performed in the following procedure.
Connect the indoor units by connecting the remote controller inter-unit cables from the remote controller terminal blocks (A, B) of the indoor unit connected with a remote controller to the remote controller terminal blocks (A, B) of the other indoor unit. (Non-polarity)
- For address setup, refer to the Installation Manual attached to the outdoor unit.

NOTE

Net work adapter (Model TCB-PCNT20E) can not connect to this High Wall type air conditioner.

12 TEST RUN

A wired remote controller is necessary for this function. This function cannot be operate with a wireless remote controller.

■ Before test run

- Before turning on the power supply, carry out the following procedure.
 - 1) Using 500V-megger, check that resistance of 1MΩ or more exists between the terminal block of the power supply and the earth (grounding).
If resistance of less than 1MΩ is detected, do not run the unit.
 - 2) Check the valve of the outdoor unit being opened fully.
- To protect the compressor at activation time, leave power-ON for 12 hours or more before operating.

WARNING

- Never press the electromagnetic contactor to forcibly perform a test run. (This is very dangerous because the protective device does not work.)
- Before starting a test run, be sure to set addresses following the installation manual supplied with the outdoor unit.

■ How to execute a test run

Using the wired remote controller, operate the unit as usual.

For the procedure of the operation, refer to the attached Owner's Manual.

A forced test run can be executed in the following procedure even if the operation stops by thermo.-OFF.

In order to prevent a serial operation, the forced test run is released after 60 minutes have passed and returns to the usual operation.

CAUTION

- Do not use the forced test run for cases other than the test run because it applies an excessive load to the devices.

In case of wired remote controller

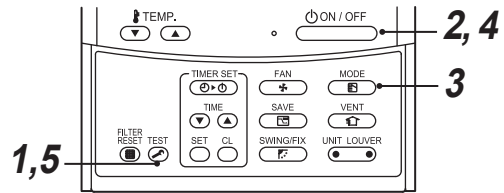

Procedure 1

Keep  button pushed for 4 seconds or more. [TEST] is displayed on the display part and the selection of mode in the test mode is permitted.

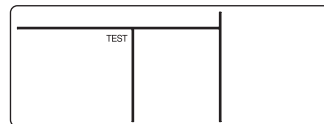

Procedure 2

Push  button.

Procedure 3

Using  button, select the operation mode, [COOL] or [HEAT].

- Do not run the air conditioner in a mode other than [COOL] or [HEAT].
- The temperature controlling function does not work during test run.
- The detection of error is performed as usual.

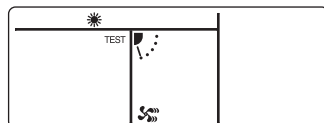

Procedure 4

After the test run, push  button to stop a test run.

(Display part is same as procedure 1.)

Procedure 5

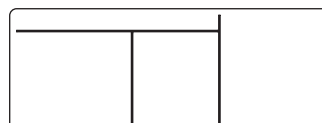

Push  check button to cancel (release from) the test run mode.

([TEST] disappears on the display and the status returns to a normal.)



In case of wireless remote controller
(Forced test operation is performed in a
different way.)

REQUIREMENT

- For the operation procedure, be sure to follow the Owner's Manual.
 - Finish the forced cooling operation in a short time because it applies excessive strength to the air conditioner.
 - A test operation of forced heating is unavailable. Perform a test operation by heating operation using the switches of the remote controller.
However heating operation may be not carried out according to the temperature conditions.
-
- **Check wiring/piping of indoor and outdoor units**
 1. When pushing  button for 10 seconds or more, "Pi!" sound is heard and the operation changes to a forced cooling operation. After approx. 3 minutes, a cooling operation starts forcedly. Check cool air starts blowing. If the operation does not start, check wiring again.
 2. To stop a test operation, push  button once again (Approx. 1 second). The louver closes and the operation stops.

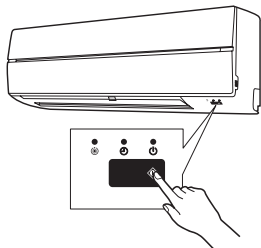

- **Check transmission of remote controller**
 1. Push "START/STOP" button of the remote controller to check an operation can also start by the remote controller.
 - "Cooling" operation by the remote controller may be unavailable according to the temperature conditions. Check wiring/piping of the indoor and outdoor units in forced cooling operation.

13 TROUBLESHOOTING

A wired remote controller is necessary for this function. This function cannot be operate with a wireless remote controller.

Confirmation and check

When a trouble occurred in the air conditioner, the check code and the indoor UNIT No. appear on the display part of the remote controller.

The check code is only displayed during the operation.

If the display disappears, operate the air conditioner according to the following "Confirmation of error history" for confirmation.

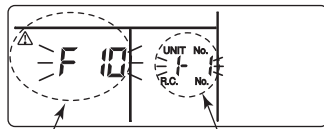

Check code

Indoor UNIT No. in which an error occurred

Confirmation of error history

When a trouble occurred on the air conditioner, the trouble history can be confirmed with the following procedure. (The trouble history is stored in memory up to 4 troubles.)

The history can be confirmed from both operating status and stop status.

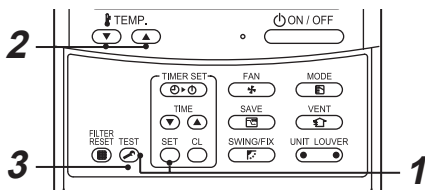

Procedure 1

When pushing SET and TEST buttons at the same time for 4 seconds or more, the following display appears.

If [Service check] is displayed, the mode enters in the trouble history mode.

- [01: Order of trouble history] is displayed in CODE No. window.
- [Check code] is displayed in CHECK window.
- [Indoor unit address in which an error occurred] is displayed in UNIT No.

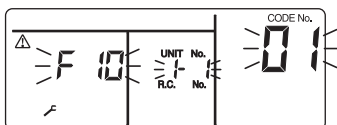

Procedure 2

Every pushing of "TEMP." button used to set temperature, the trouble history stored in memory is displayed in order.

The numbers in CODE No. indicate CODE No. [01] (latest) → [04] (oldest).

REQUIREMENT

Do not push CL button because all the trouble history of the indoor unit will be deleted.

Procedure 3

After confirmation, push TEST button to return to the usual display.

■ Check method

On the remote controller (Wired remote controller, Central control remote controller) and the interface P.C. board of the outdoor unit (I/F), a check display LCD (Remote controller) or 7-segment display (on the outdoor interface P.C. board) to display the operation is provided. Therefore the operation status can be known. Using this self-diagnosis function, a trouble or position with error of the air conditioner can be found as shown in the table below.

■ Check code list

The following list shows each check code. Find the check contents from the list according to part to be checked.

- In case of check from indoor remote controller: See “Wired remote controller display” in the list.
- In case of check from outdoor unit: See “Outdoor 7-segment display” in the list.
- In case of check from indoor unit with wireless remote controller: See “Sensor block display of receiving unit” in the list.

AI-NET: Artificial Intelligence.

IPDU: Intelligent Power Drive Unit

○ : Lighting, ◻ : Flashing, ● : Goes off

ALT.: Flashing is alternately when there are two flashing LED.

SIM: Simultaneous flashing when there are two flashing LED.

Check code		Wireless remote controller			Check code name	Judging device	
Wired remote controller display	Outdoor 7-segment display	Sensor block display of receiving unit					
	Auxiliary code	OPERATION	TIMER	PRE.DEF.			Flash
E01	—	—	◻	●	●	Communication error between indoor and remote controller (Detected at remote controller side)	Remote controller
E02	—	—	◻	●	●	Remote controller transmission error	Remote controller
E03	—	—	◻	●	●	Communication error between indoor and remote controller (Detected at indoor side)	Indoor
E04	—	—	●	●	◻	Communication circuit error between indoor/outdoor (Detected at indoor side)	Indoor
E06	E06	No. of indoor units in which sensor has been normally received	●	●	◻	Decrease of No. of indoor units	I/F
—	E07	—	●	●	◻	Communication circuit error between indoor/outdoor (Detected at outdoor side)	I/F
E08	E08	Duplicated indoor addresses	◻	●	●	Duplicated indoor addresses	Indoor / I/F
E09	—	—	◻	●	●	Duplicated main remote controllers	Remote controller
E10	—	—	◻	●	●	Communication error between indoor MCU	Indoor
E12	E12	01: Indoor/Outdoor communication 02: Communication between outdoor units	◻	●	●	Automatic address start error	I/F
E15	E15	—	●	●	◻	Indoor is nothing during automatic addressing	I/F
E16	E16	00: Capacity over 01 ~:No. of connected units	●	●	◻	Capacity over / No. of connected indoor units	I/F
E18	—	—	◻	●	●	Communication error between indoor units	Indoor
E19	E19	00: Header is nothing 02: Two or more header units	●	●	◻	Outdoor header units quantity error	I/F
E20	E20	01: Outdoor of other line connected 02: Indoor of other line connected	●	●	◻	Other line connected during automatic address	I/F

E23	E23	—	● ● □			Sending error in communication between outdoor units	I/F
E25	E25	—	● ● □			Duplicated follower outdoor addresses	I/F
E26	E26	No. of outdoor units which received signal normally	● ● □			Decrease of No. of connected outdoor units	I/F
E28	E28	Detected outdoor unit number	● ● □			Follower outdoor unit error	I/F
E31	E31	01: IPDU1 error 02: IPDU2 error 03: IPDU1, 2 error 04: Fan IPDU error 05: IPDU + Fan IPDU error 06: IPDU2 + Fan IPDU error 07: All IPDU error	● ● □			IPDU communication error	I/F
F01	—	—	□ □ ●	ALT		Indoor TCJ sensor error	Indoor
F02	—	—	□ □ ●	ALT		Indoor TC2 sensor error	Indoor
F03	—	—	□ □ ●	ALT		Indoor TC1 sensor error	Indoor
F04	F04	—	□ □ ○	ALT		TD1 sensor error	I/F
F05	F05	—	□ □ ○	ALT		TD2 sensor error	I/F
F06	F06	—	□ □ ○	ALT		TE1 sensor error	I/F
F07	F07	—	□ □ ○	ALT		TL sensor error	I/F
F08	F08	—	□ □ ○	ALT		TO sensor error	I/F
F10	—	—	□ □ ●	ALT		Indoor TA sensor error	Indoor
F12	F12	—	□ □ ○	ALT		TS1 sensor error	I/F
F13	F13	01: Comp. 1 side 02: Comp. 2 side	□ □ ○	ALT		TH sensor error	IPDU
F15	F15	—	□ □ ○	ALT		Outdoor temp. sensor miscabling (TE, TL)	I/F
F16	F16	—	□ □ ○	ALT		Outdoor pressure sensor miscabling (Pd, Ps)	I/F
F23	F23	—	□ □ ○	ALT		Ps sensor error	I/F
F24	F24	—	□ □ ○	ALT		Pd sensor error	I/F
F29	—	—	□ □ ●	SIM		Indoor other error	Indoor
F31	F31	—	□ □ ○	SIM		Indoor EEPROM error	I/F
H01	H01	01: Comp. 1 side 02: Comp. 2 side	● □ ●			Compressor break down	IPDU
H02	H02	01: Comp. 1 side 02: Comp. 2 side	● □ ●			Magnet switch error Overcurrent relay operation Compressor trouble (lock)	MG-SW Overcurrent relay IPDU
H03	H03	01: Comp. 1 side 02: Comp. 2 side	● □ ●			Current detect circuit system error	IPDU
H04	H04	—	● □ ●			Comp 1 case thermo operation	I/F
H06	H06	—	● □ ●			Low pressure protective operation	I/F
H07	H07	—	● □ ●			Oil level down detective protection	I/F
H08	H08	01: TK1 sensor error 02: TK2 sensor error 03: TK3 sensor error 04: TK4 sensor error	● □ ●			Oil level detective temp sensor error	I/F
H14	H14	—	● □ ●			Comp 2 case thermo operation	I/F
H16	H16	01: TK1 oil circuit system error 02: TK2 oil circuit system error 03: TK3 oil circuit system error 04: TK4 oil circuit system error	● □ ●			Oil level detective circuit error Magnet switch error Overcurrent relay operation	I/F MG-SW Overcurrent relay
L03	—	—	□ ● □	SIM		Indoor centre unit duplicated	Indoor
L04	L04	—	□ ○ □	SIM		Outdoor line address duplicated	I/F
L05	—	—	□ ● □	SIM		Duplicated indoor units with priority (Displayed in indoor unit with priority)	I/F
L06	L06	No. of indoor units with priority	□ ● □	SIM		Duplicated indoor units with priority (Displayed in unit other than indoor unit with priority)	I/F
L07	—	—	□ ● □	SIM		Group line in individual indoor unit	Indoor
L08	L08	—	□ ● □	SIM		Indoor group/Address unset	Indoor, I/F

L09	—	—	☐ ● ☐	SIM	Indoor capacity unset	Indoor
L10	L10	—	☐ ○ ☐	SIM	Outdoor capacity unset	I/F
L20	—	—	☐ ○ ☐	SIM	Duplicated central control addresses	AI-NET, Indoor
L28	L28	—	☐ ○ ☐	SIM	Over No. of connected outdoor units	I/F
L29	L29	01: IPDU1 error 02: IPDU2 error 03: IPDU3 error 04: Fan IPDU error 05: IPDU1 + Fan IPDU error 06: IPDU2 + Fan IPDU error 07: All IPDU error	☐ ○ ☐	SIM	No. of IPDU error	I/F
L30	L30	Detected indoor address	☐ ○ ☐	SIM	Indoor outside interlock	Indoor
—	L31	—	—		Extended I/C error	I/F
P01	—	—	● ☐ ☐	ALT	Indoor fan motor error	Indoor
P03	P03	—	☐ ● ☐	ALT	Discharge temp. TD1 error	I/F
P04	P04	01: Comp. 1 side 02: Comp. 2 side	☐ ● ☐	ALT	High-pressure SW system operation	IPDU
P05	P05	01: Phase-missing detection 02: Phase error	☐ ● ☐	ALT	Phase-missing detection /Phase error	I/F
P07	P07	01: Comp. 1 side 02: Comp. 2 side	☐ ● ☐	ALT	Heat sink overheat error	IPDU, I/F
P10	P10	Detected indoor address	● ☐ ☐	ALT	Indoor overflow error	Indoor
P12	—	—	● ☐ ☐	ALT	Indoor fan motor error	Indoor
P13	P13	—	● ☐ ☐	ALT	Outdoor liquid back detection error	I/F
P15	P15	01: TS condition 02: TD condition	☐ ● ☐	ALT	Gas leak detection	I/F
P17	P17	—	☐ ● ☐	ALT	Discharge temp. TD2 error	I/F
P19	P19	Detected outdoor unit number	☐ ● ☐	ALT	4-way valve inverse error	I/F
P20	P20	—	☐ ● ☐	ALT	High-pressure protective operation	I/F
P22	P22	0_ : IGBT short 1_ : Fan motor position detective circuit error 3_ : Fan motor trouble C_ : TH sensor temp. error (Heat sink overheat) D_ : TH sensor error E_ : Vdc output error	☐ ● ☐	ALT	Outdoor fan IPDU error	IPDU
P26	P26	01: Comp. 1 side 02: Comp. 2 side	☐ ● ☐	ALT	G-TR short protection error	IPDU
P29	P29	01: Comp. 1 side 02: Comp. 2 side	☐ ● ☐	ALT	Comp position detective circuit system error	IPDU
P31	P31	—	☐ ● ☐	ALT	Other indoor unit error (Group terminal unit error)	Indoor
—	—	—	By alarm device ALT		Error in indoor group	AI-NET

Error detected by TCC-LINK central control device

Check code		Wireless remote controller		Check code name	Judging device
Central control device indication	Outdoor 7-segment display	Sensor block display of receiving unit			
		Auxiliary code	OPERATION	TIMER PRE.DEF. Flash	
C05	—	—	—	Sending error in TCC-LINK central control device	TCC-LINK
C06	—	—	—	Receiving error in TCC-LINK central control device	TCC-LINK
C12	—	—	—	Batch alarm of general-purpose equipment control interface	General-purpose equipment I/F
P30	Differs according to error contents of unit with occurrence of alarm			Group control branching unit error	TCC-LINK
	—	—	(L20 is displayed.)	Duplicated central control addresses	

TCC-LINK: TOSHIBA Carrier Communication Link.

WARNINGS ON REFRIGERANT LEAKAGE

Check of Concentration Limit

The room in which the air conditioner is to be installed requires a design that in the event of refrigerant gas leaking out, its concentration will not exceed a set limit.

The refrigerant R410A which is used in the air conditioner is safe, without the toxicity or combustibility of ammonia, and is not restricted by laws to be imposed which protect the ozone layer. However, since it contains more than air, it poses the risk of suffocation if its concentration should rise excessively. Suffocation from leakage of R410A is almost non-existent. With the recent increase in the number of high concentration buildings, however, the installation of multi air conditioner systems is on the increase because of the need for effective use of floor space, individual control, energy conservation by curtailing heat and carrying power etc. Most importantly, the multi air conditioner system is able to replenish a large amount of refrigerant compared with conventional individual air conditioner systems. If a single unit of the multi conditioner system is to be installed in a small room, select a suitable model and installation procedure so that if the refrigerant accidentally leaks out, its concentration does not reach the limit (and in the event of an emergency, measures can be made before injury can occur).

In a room where the concentration may exceed the limit, create an opening with adjacent rooms, or install mechanical ventilation combined with a gas leak detection device.

The concentration is as given below.

$$\frac{\text{Total amount of refrigerant (kg)}}{\text{Min. volume of the indoor unit installed room (m}^3\text{)}} \leq \text{Concentration limit (kg/m}^3\text{)}$$

The concentration limit of R410A which is used in multi air conditioners is 0.3kg/m³.

▼ NOTE 1

If there are 2 or more refrigerating systems in a single refrigerating device, the amounts of refrigerant should be as charged in each independent device.

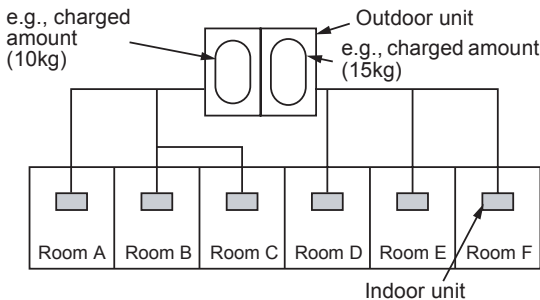

For the amount of charge in this example:

The possible amount of leaked refrigerant gas in rooms A, B and C is 10kg.

The possible amount of leaked refrigerant gas in rooms D, E and F is 15kg.

▼ NOTE 2

The standards for minimum room volume are as follows.

(1) No partition (shaded portion)

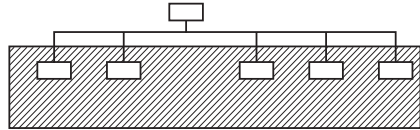

(2) When there is an effective opening with the adjacent room for ventilation of leaking refrigerant gas (opening without a door, or an opening 0.15% or larger than the respective floor spaces at the top or bottom of the door).

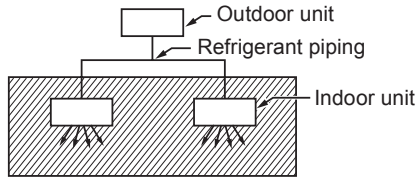

(3) If an indoor unit is installed in each partitioned room and the refrigerant piping is interconnected, the smallest room of course becomes the object. But when a mechanical ventilation is installed interlocked with a gas leakage detector in the smallest room where the density limit is exceeded, the volume of the next smallest room becomes the object.

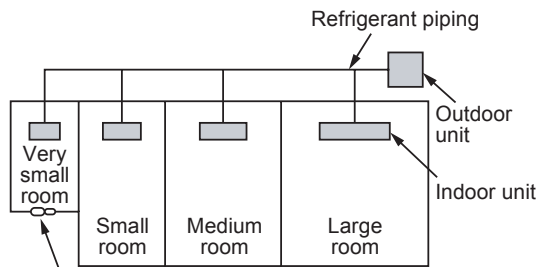

▼ NOTE 3

The minimum indoor floor area compared with the amount of refrigerant is roughly as follows: (When the ceiling is 2.7m high)

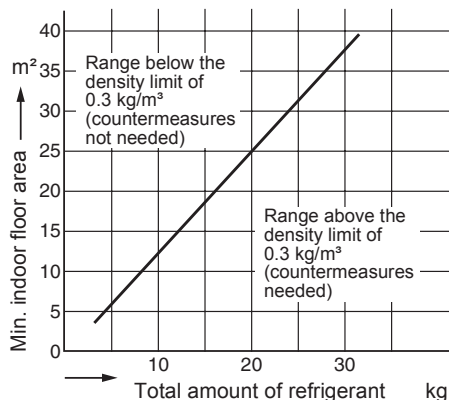

CONFIRMATION OF INDOOR UNIT SETUP

Prior to delivery to the customer, check the address and setup of the indoor unit, which has been installed in this time and fill the check sheet (Table below). Data of four units can be entered in this check sheet. Copy this sheet according to the No. of the indoor units. If the installed system is a group control system, use this sheet by entering each line system into each installation manual attached to the other indoor units.

REQUIREMENT

This check sheet is required for maintenance after installation. Be sure to fill this sheet and then pass this Installation Manual to the customers.

Indoor unit setup check sheet

Indoor unit			Indoor unit			Indoor unit			Indoor unit		
Room name			Room name			Room name			Room name		
Model			Model			Model			Model		
Check indoor unit address. (For check method, refer to Applicable controls in this sheet.)											
* In case of a single system, it is unnecessary to enter the indoor address. (CODE No.: Line [12], Indoor [13], Group [14], Central control [03])											
Line	Indoor	Group	Line	Indoor	Group	Line	Indoor	Group	Line	Indoor	Group
Central control address			Central control address			Central control address			Central control address		
Various setup			Various setup			Various setup			Various setup		
Have you changed high ceiling setup? If not, fill check mark [x] in [NO CHANGE], and fill check mark [x] in [ITEM] if changed, respectively. (For check method, refer to Applicable controls in this sheet.)* In case of replacement of short plugs on indoor microcomputer P.C. board, setup is automatically changed.											
High ceiling setup (CODE No. [5d])			High ceiling setup (CODE No. [5d])			High ceiling setup (CODE No. [5d])			High ceiling setup (CODE No. [5d])		
<input type="checkbox"/> NO CHANGE			<input type="checkbox"/> NO CHANGE			<input type="checkbox"/> NO CHANGE			<input type="checkbox"/> NO CHANGE		
<input type="checkbox"/> STANDARD [0000]			<input type="checkbox"/> STANDARD [0000]			<input type="checkbox"/> STANDARD [0000]			<input type="checkbox"/> STANDARD [0000]		
<input type="checkbox"/> HIGH CEILING 1 [0001]			<input type="checkbox"/> HIGH CEILING 1 [0001]			<input type="checkbox"/> HIGH CEILING 1 [0001]			<input type="checkbox"/> HIGH CEILING 1 [0001]		
<input type="checkbox"/> HIGH CEILING 3 [0003]			<input type="checkbox"/> HIGH CEILING 3 [0003]			<input type="checkbox"/> HIGH CEILING 3 [0003]			<input type="checkbox"/> HIGH CEILING 3 [0003]		
Have you changed lighting time of filter sign? If not, fill check mark [x] in [NO CHANGE], and fill check mark [x] in [ITEM] if changed, respectively. (For check method, refer to Applicable controls in this sheet.)											
Filter sign lighting time (CODE No. [01])			Filter sign lighting time (CODE No. [01])			Filter sign lighting time (CODE No. [01])			Filter sign lighting time (CODE No. [01])		
<input type="checkbox"/> NO CHANGE			<input type="checkbox"/> NO CHANGE			<input type="checkbox"/> NO CHANGE			<input type="checkbox"/> NO CHANGE		
<input type="checkbox"/> NONE [0000]			<input type="checkbox"/> NONE [0000]			<input type="checkbox"/> NONE [0000]			<input type="checkbox"/> NONE [0000]		
<input type="checkbox"/> 150H [0001]			<input type="checkbox"/> 150H [0001]			<input type="checkbox"/> 150H [0001]			<input type="checkbox"/> 150H [0001]		
<input type="checkbox"/> 2500H [0002]			<input type="checkbox"/> 2500H [0002]			<input type="checkbox"/> 2500H [0002]			<input type="checkbox"/> 2500H [0002]		
<input type="checkbox"/> 5000H [0003]			<input type="checkbox"/> 5000H [0003]			<input type="checkbox"/> 5000H [0003]			<input type="checkbox"/> 5000H [0003]		
<input type="checkbox"/> 10000H [0004]			<input type="checkbox"/> 10000H [0004]			<input type="checkbox"/> 10000H [0004]			<input type="checkbox"/> 10000H [0004]		
Have you changed detected temp. shift value? If not, fill check mark [x] in [NO CHANGE], and fill check mark [x] in [ITEM] if changed, respectively. (For check method, refer to Applicable control in this sheet.)											
Detected temp. shift value setup (CODE No. [06])			Detected temp. shift value setup (CODE No. [06])			Detected temp. shift value setup (CODE No. [06])			Detected temp. shift value setup (CODE No. [06])		
<input type="checkbox"/> NO CHANGE			<input type="checkbox"/> NO CHANGE			<input type="checkbox"/> NO CHANGE			<input type="checkbox"/> NO CHANGE		
<input type="checkbox"/> NO SHIFT [0000]			<input type="checkbox"/> NO SHIFT [0000]			<input type="checkbox"/> NO SHIFT [0000]			<input type="checkbox"/> NO SHIFT [0000]		
<input type="checkbox"/> +1°C [0001]			<input type="checkbox"/> +1°C [0001]			<input type="checkbox"/> +1°C [0001]			<input type="checkbox"/> +1°C [0001]		
<input type="checkbox"/> +2°C [0002]			<input type="checkbox"/> +2°C [0002]			<input type="checkbox"/> +2°C [0002]			<input type="checkbox"/> +2°C [0002]		
<input type="checkbox"/> +3°C [0003]			<input type="checkbox"/> +3°C [0003]			<input type="checkbox"/> +3°C [0003]			<input type="checkbox"/> +3°C [0003]		
<input type="checkbox"/> +4°C [0004]			<input type="checkbox"/> +4°C [0004]			<input type="checkbox"/> +4°C [0004]			<input type="checkbox"/> +4°C [0004]		
<input type="checkbox"/> +5°C [0005]			<input type="checkbox"/> +5°C [0005]			<input type="checkbox"/> +5°C [0005]			<input type="checkbox"/> +5°C [0005]		
<input type="checkbox"/> +6°C [0006]			<input type="checkbox"/> +6°C [0006]			<input type="checkbox"/> +6°C [0006]			<input type="checkbox"/> +6°C [0006]		
Incorporation of parts sold separately			Incorporation of parts sold separately			Incorporation of parts sold separately			Incorporation of parts sold separately		
Have you incorporated the following parts sold separately? If incorporated, fill check mark [x] in each [ITEM]. (When incorporating, the setup change is necessary in some cases. For setup change method, refer to Installation Manual attached to each part sold separately.)											
Panel <input type="checkbox"/> Standard panel			Panel <input type="checkbox"/> Standard panel			Panel <input type="checkbox"/> Standard panel			Panel <input type="checkbox"/> Standard panel		
Filter <input type="checkbox"/> Super long life filter			Filter <input type="checkbox"/> Super long life filter			Filter <input type="checkbox"/> Super long life filter			Filter <input type="checkbox"/> Super long life filter		
<input type="checkbox"/> Others ()			<input type="checkbox"/> Others ()			<input type="checkbox"/> Others ()			<input type="checkbox"/> Others ()		
<input type="checkbox"/> Others ()			<input type="checkbox"/> Others ()			<input type="checkbox"/> Others ()			<input type="checkbox"/> Others ()		

4. REFRIGERATING CYCLE DIAGRAM

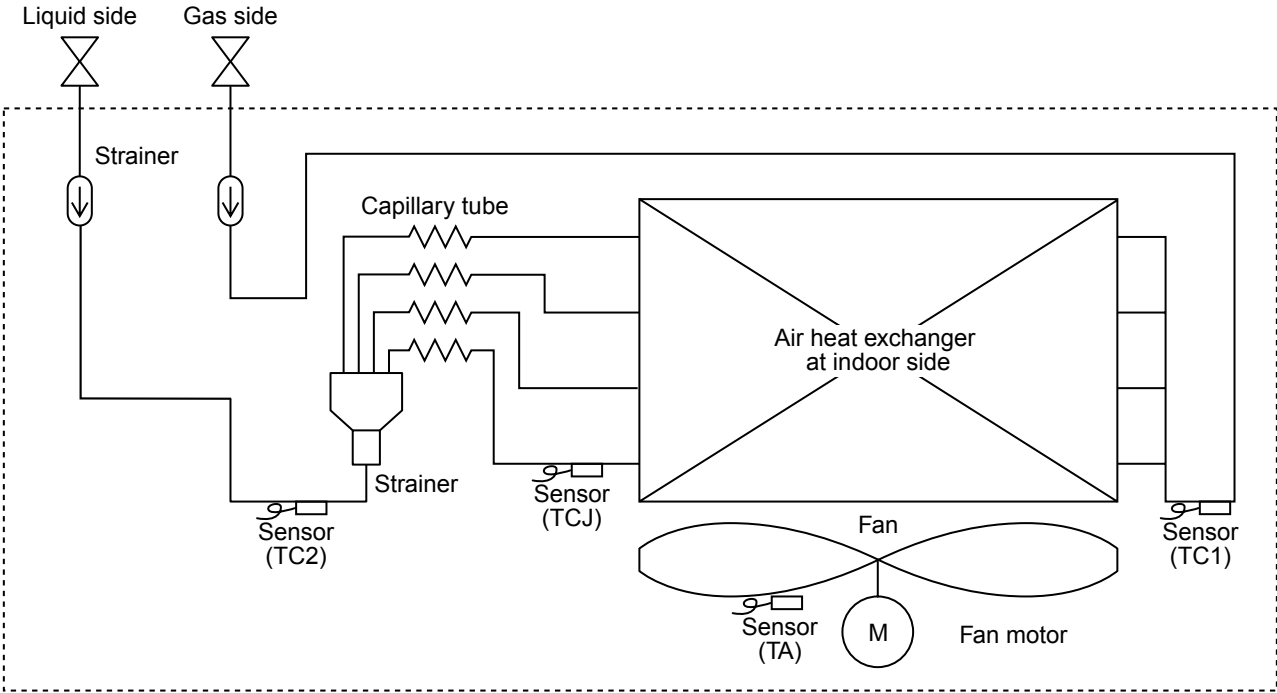

Functional part name		Functional outline
Temp. sensor	1. TA	(Connector CN104 (2P): White) 1) Detects indoor suction temperature
	2. TC1	(Connector CN100 (3P): Brown) 1) Controls PMV super heat in cooling operation
	3. TC2	(Connector CN101 (2P): Blue) 1) Controls PMV under cool in heating operation
	4. TCJ	(Connector CN102 (2P): Yellow) 1) Controls PMV super heat in cooling operation









5. CONTROL OUTLINE





5-1. Control Specifications



No.	Item	Outline of specifications	Remarks																										
1	When power supply is reset	1) Distinction of outdoor unit When the power supply is reset, the outdoors are distinguished and the control is selected according to the distinguished result. 2) If resetting the power supply during occurrence of a trouble, the check code is once cleared. After ON/OFF button of the remote controller was pushed and the operation was resumed, if the abnormal status continues, the check code is again displayed on the remote controller.																											
2	Operation mode selection	1) Based on the operation mode selecting command from the remote controller, the operation mode is selected. <table border="1" style="margin: 10px 0;"> <thead> <tr> <th>Remote controller command</th> <th>Control outline</th> </tr> </thead> <tbody> <tr> <td>STOP</td> <td>Air conditioner stops.</td> </tr> <tr> <td>FAN</td> <td>Fan operation</td> </tr> <tr> <td>COOL</td> <td>Cooling operation</td> </tr> <tr> <td>DRY</td> <td>Dry operation</td> </tr> <tr> <td>HEAT</td> <td>Heating operation</td> </tr> <tr> <td>AUTO (SHRM only)</td> <td> <ul style="list-style-type: none"> Ta and Ts automatically select COOL/HEAT operation mode for operation. </td> </tr> </tbody> </table> <p>* Except SHRM, the automatic mode cannot be selected. While a wireless remote controller is used, the mode is notified by "Pi Pi" (two times) receiving sound. To clear the alternate flashing, change the mode on the wireless remote controller.</p>	Remote controller command	Control outline	STOP	Air conditioner stops.	FAN	Fan operation	COOL	Cooling operation	DRY	Dry operation	HEAT	Heating operation	AUTO (SHRM only)	<ul style="list-style-type: none"> Ta and Ts automatically select COOL/HEAT operation mode for operation. 	Ta: Room temp. Ts: Setup temp.												
Remote controller command	Control outline																												
STOP	Air conditioner stops.																												
FAN	Fan operation																												
COOL	Cooling operation																												
DRY	Dry operation																												
HEAT	Heating operation																												
AUTO (SHRM only)	<ul style="list-style-type: none"> Ta and Ts automatically select COOL/HEAT operation mode for operation. 																												
3	Room temp. control	1) Adjustment range: Remote controller setup temperature (°C) <table border="1" style="margin: 10px 0;"> <thead> <tr> <th></th> <th>COOL/DRY</th> <th>HEAT</th> <th>AUTO*</th> </tr> </thead> <tbody> <tr> <td>Wired type</td> <td>18 to 29</td> <td>18 to 29</td> <td>18 to 29</td> </tr> <tr> <td>Wireless type</td> <td>17 to 30</td> <td>17 to 30</td> <td>17 to 30</td> </tr> </tbody> </table> 2) Using the Item code 06, the setup temperature in heating operation can be corrected. <table border="1" style="margin: 10px 0;"> <thead> <tr> <th>Setup data</th> <th>0</th> <th>2</th> <th>3</th> <th>4</th> <th>6</th> </tr> </thead> <tbody> <tr> <td>Setup temp. correction</td> <td>+0°C</td> <td>+2°C</td> <td>+3°C</td> <td>+4°C</td> <td>+6°C</td> </tr> </tbody> </table> Setting at shipment <table border="1" style="margin: 10px 0;"> <tbody> <tr> <td>Setup data</td> <td>3</td> </tr> </tbody> </table>		COOL/DRY	HEAT	AUTO*	Wired type	18 to 29	18 to 29	18 to 29	Wireless type	17 to 30	17 to 30	17 to 30	Setup data	0	2	3	4	6	Setup temp. correction	+0°C	+2°C	+3°C	+4°C	+6°C	Setup data	3	* For SHRM only Shift of suction temperature in heating operation Except while sensor of the remote controller is controlled (Code No. [32], "0001")
	COOL/DRY	HEAT	AUTO*																										
Wired type	18 to 29	18 to 29	18 to 29																										
Wireless type	17 to 30	17 to 30	17 to 30																										
Setup data	0	2	3	4	6																								
Setup temp. correction	+0°C	+2°C	+3°C	+4°C	+6°C																								
Setup data	3																												
4	Automatic capacity control	1) Based on the difference between Ta and Ts, the operation capacity is determined by the outdoor unit.	Ts: Setup temp. Ta: Room temp.																										

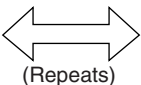

No.	Item	Outline of specifications	Remarks									
5	Air speed selection	1) Operation with (HH), (H), (L) or [AUTO] mode is carried out by the command from the remote controller. For the wireless remote controller type, (HH), (H+), (H), (L+), (L) or [AUTO] operation is carried out. 2) When the air speed mode [AUTO] is selected, the air speed varies by the difference between Ta and Ts.	HH > H+ > H > L+ > L > UL									
6	Prevention of cold air discharge	1. In heating operation, the higher temperature of TC2 sensor and TCJ sensor is compared with temperature of TC1 sensor and then the lower temperature is used to set the upper limit of the fan tap. <ul style="list-style-type: none"> When B zone has continued for 6 minutes, the operation shifts to C zone. In defrost time, the control point is set to +6°C. 	TCJ: Temperature of indoor heat exchanger sensor <ul style="list-style-type: none"> In D and E zones, priority is given to remote controller air speed setup. In A zone “☀” is displayed. 									
7	Freeze prevention control (Low temp. release)	1. In all cooling operation, the air conditioner operates as described below based upon temp. detected by TC1, TC2 and TCJ sensors. <ul style="list-style-type: none"> When “J” zone is detected for 5 minutes, the thermostat is forcedly off. In “K” zone, the timer count is interrupted, and held. When “I” zone is detected, the timer is cleared and the operation returns to the normal operation. If forced thermo OFF by continuation of “J” zone, operation of the indoor fan in LOW mode continues until it reaches the “I” zone. It is rest when the following conditions are satisfied. <p>Reset conditions</p> 1) TC1 ≥ 12°C and TC2 ≥ 12°C and TCJ ≥ 12°C 2) 20 minutes passed after stop.	TC1: Temperature of indoor heat exchanger sensor <p>() value: When the power supply is turned on, the Forced thermo becomes OFF if the temperature is less than this indicated temperature.</p> <table border="1" data-bbox="758 1444 1077 1556"> <thead> <tr> <th></th> <th>TC1</th> <th>TC2, TCJ</th> </tr> </thead> <tbody> <tr> <td>P1</td> <td>10°C (5°C)</td> <td>-10°C</td> </tr> <tr> <td>Q1</td> <td>0°C</td> <td>-14°C</td> </tr> </tbody> </table> 2. In all cooling operation, the air conditioner operates as described below based upon temp. detected by TC2 and TCJ sensors. <ul style="list-style-type: none"> When “M” zone is detected for 45 minutes, the thermostat is forcedly off. In “N” zone, the timer count is interrupted and held. When shifting to “M” zone again, the timer count restarts and continues. If “L” zone is detected, the timer is cleared and the operation returns to normal operation. <p>Reset conditions</p> 1) TC1 ≥ 12°C and TC2 ≥ 12°C and TCJ ≥ 12°C 2) 20 minutes passed after stop.		TC1	TC2, TCJ	P1	10°C (5°C)	-10°C	Q1	0°C	-14°C
	TC1	TC2, TCJ										
P1	10°C (5°C)	-10°C										
Q1	0°C	-14°C										

No.	Item	Outline of specifications	Remarks
8	Recovery control for cooling oil (Refrigerant)	<p>The indoor unit which is under STOP/Thermo-OFF status or which operates in [FAN] mode performs the following controls when it received the cooling oil (Refrigerant) recovery signal from the outdoor unit.</p> <ol style="list-style-type: none"> 1) Opens PMV of the indoor unit with a constant opening degree. 2) Operates the indoor fan for approx. 3 minutes during recovery control and after finish of control. 	<ul style="list-style-type: none"> • Recovery operation is usually performed every 2 hours.
9	Recovery control for heating refrigerant (Oil)	<p>The indoor unit which is under STOP/Thermo-OFF status or which operates in [FAN] mode performs the following controls when it received the heating refrigerant (Oil) recovery signal from the outdoor unit.</p> <ol style="list-style-type: none"> 1) Opens PMV of the indoor unit with a constant opening degree. 2) Stop the indoor fan. 	<ul style="list-style-type: none"> • The indoor unit which is under thermo-OFF (COOL) status or which operates in [FAN] mode stops the indoor fan and displays [*]. • Recovery operation is usually performed every 1 hour.
10	Compensation control for short intermittent operation	<ol style="list-style-type: none"> 1) For 3 minutes after start of operation, the operation is forcibly continued even if the unit enters in Thermo-OFF condition. 2) However the thermostat is OFF giving prior to COOL/HEAT selection, ready for operation and protective control. 	Usually the priority is given to 5 minutes at outdoor controller side.
11	Elimination of retained heat	<ol style="list-style-type: none"> 1) When the unit stopped from [HEAT] operation, the indoor fan operates with [L] for approx. 30 seconds. 	
12	HA control	<ol style="list-style-type: none"> 1) ON/OFF operation is available by input of HA signal from the remote site when connected to remote controller or the remote ON/OFF interface. 2) HA control outputs ON/OFF status to HA terminal. 3) The I/O specifications of HA conform to JEMA standard. 	<p>When using HA terminal (CN61) for the remote ON/OFF, a connector sold separately is necessary.</p> <p>In case of group operation, use the connector to connect HA terminal to either master or follower indoor unit.</p>
13	<p>Display of filter sign [■] (Not provided to the wireless type)</p> <p>* Separately set type TCB-AX21E2 is prepared.</p>	<ol style="list-style-type: none"> 1) The filter sign is displayed with LC by sending the filter-reset signal to the remote controller when the specified time (15 0H) elapsed as a result of integration of the operation time of the indoor fan. 2) The integrated timer is cleared when the filter-reset signal is received from the remote controller. In this time, if the specified time elapsed, the counted time is reset and the LC display is deleted. 	[■ FILTER] goes on.

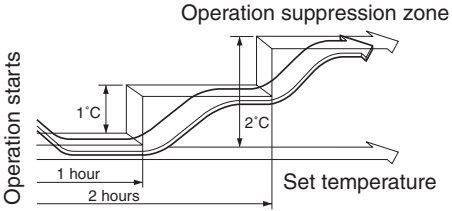
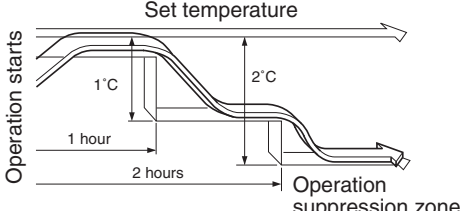
No.	Item	Outline of specifications	Remarks																																																			
14	Display of [ OPERATION READY] [ PRE-HEAT]	<p><OPERATION READY> Displayed on the remote controller</p> <ol style="list-style-type: none"> When the following check codes are indicated <ul style="list-style-type: none"> Open phase of power supply wiring [P05] was detected. There is an indoor unit that detected the indoor overflow [P10]. There is an indoor unit that detected the interlock alarm [L30]. During Force Thermo-OFF <ul style="list-style-type: none"> [COOL/DRY] operation is unavailable because the other indoor unit operates with [HEAT] mode. [HEAT] operation is unavailable because COOL priority (SW11-bit1 of the Outdoor I/F P. C. board is ON) is set and the other indoor unit operates with [COOL/DRY] mode. The above indoor units that cannot operate stay in Thermo-OFF status. The indoor fan stops because the system performs [Recovery operation for heating refrigerant (Oil)]. <p><PRE-HEAT> Displayed on the remote controller The indoor fan stops in order to prevent discharge of cool air when heating operation started or during heating operation. (including the defrost operation during thermo-OFF)</p>	<ul style="list-style-type: none"> <  > display No display for wireless remote controller <  > display 																																																			
15	Selection of central control mode	<ol style="list-style-type: none"> Selection of the contents that can be operated by the remote controller at the indoor unit side is possible according to setting at the central controller side. Setting contents <p>• In case of TCC-LINK central control</p> <table border="1" data-bbox="236 1171 1422 1429"> <thead> <tr> <th rowspan="2">Operation from TCC-LINK central control</th> <th colspan="6">Operation on RBC-AMT32E</th> <th rowspan="2">On RBC-AMT32E</th> </tr> <tr> <th>ON/OFF setting</th> <th>Operation selection</th> <th>Timer setting</th> <th>Temp. setting</th> <th>Air speed setting</th> <th>Air direction setting</th> </tr> </thead> <tbody> <tr> <td>Individual</td> <td>○</td> <td>○</td> <td>○</td> <td>○</td> <td>○</td> <td>○</td> <td>No display</td> </tr> <tr> <td>[Central 1]</td> <td>×</td> <td>○</td> <td>×</td> <td>○</td> <td>○</td> <td>○</td> <td rowspan="4">[Central control ] display</td> </tr> <tr> <td>[Central 2]</td> <td>×</td> <td>×</td> <td>×</td> <td>×</td> <td>○</td> <td>○</td> </tr> <tr> <td>[Central 3]</td> <td>○</td> <td>×</td> <td>○</td> <td>×</td> <td>○</td> <td>○</td> </tr> <tr> <td>[Central 4]</td> <td>○</td> <td>×</td> <td>○</td> <td>○</td> <td>○</td> <td>○</td> </tr> </tbody> </table> <p>(○: Operation possible ×: Operation impossible)</p> <ul style="list-style-type: none"> In case of wired remote controller type, [Central control ] display (Goes on) in the central control mode Display flashes when an item of the operation prohibited was changed on the remote controller. In case of wireless remote controller type, the display lamp does not change but the contents that can be operated are same in the central control mode. <ul style="list-style-type: none"> (*1) The operation from the wireless remote controller in the central control mode is notified with the receiving sound, Pi, Pi, Pi, Pi, Pi (5 times). (*1) If the operation select modes are different in the central 2 to 4 from those at the central controller side, the operations Temp. Setting, air volume setting, and air direction setting are inoperable. 	Operation from TCC-LINK central control	Operation on RBC-AMT32E						On RBC-AMT32E	ON/OFF setting	Operation selection	Timer setting	Temp. setting	Air speed setting	Air direction setting	Individual	○	○	○	○	○	○	No display	[Central 1]	×	○	×	○	○	○	[Central control ] display	[Central 2]	×	×	×	×	○	○	[Central 3]	○	×	○	×	○	○	[Central 4]	○	×	○	○	○	○	
Operation from TCC-LINK central control	Operation on RBC-AMT32E						On RBC-AMT32E																																															
	ON/OFF setting	Operation selection	Timer setting	Temp. setting	Air speed setting	Air direction setting																																																
Individual	○	○	○	○	○	○	No display																																															
[Central 1]	×	○	×	○	○	○	[Central control ] display																																															
[Central 2]	×	×	×	×	○	○																																																
[Central 3]	○	×	○	×	○	○																																																
[Central 4]	○	×	○	○	○	○																																																

No.	Item	Outline of specifications	Remarks
16	Louver control	<p>1) Louver position setup (Wired type)</p> <ul style="list-style-type: none"> The louver position can be set up in the following operation range. <p style="text-align: center;">In cooling/dry operation In heating/fan operation</p> <div style="display: flex; justify-content: space-around; align-items: center;">   </div> <ul style="list-style-type: none"> In group operation, the louver positions can be set up collectively or individually. <p>2) Swing setup</p> <ul style="list-style-type: none"> The following display is repeated. <p style="text-align: center;">In all operations</p> <div style="display: flex; justify-content: center; align-items: center;">    </div> <ul style="list-style-type: none"> In group operation, the louver positions can be set up collectively or individually. <p>3) FIX setup (Wireless type)</p> <p>Keep pushing or pushing briefly the FIX button to move the louver in the desired direction.</p> <p>Operating angle of louver will be different during cooling, dry and heating operation.</p> <p>4) When the unit stopped or the warning was output, the louver is automatically set to full closed position.</p> <p>5) When PRE-HEAT (⊕) is displayed (Heating operation started or defrost operation is performed), heating thermo is off, the louver is automatically set to horizontal discharge position.</p>	
17	Hi POWER operation (Wireless remote controller specific operations)	<p>When you push the Hi POWER button during cooling, heating or A operation, the air conditioner will start the following operation.</p> <ul style="list-style-type: none"> Cooling operation Performs the cooling operation at 1°C lower than the setting temperature. Only when the fan speed before the Hi POWER operation is not high, the fan speed will be increased. Heating operation Performs the heating operation at 2°C higher than the setting temperature. Only when the fan speed before the Hi POWER operation is not high, the fan speed will be increased. 	<ul style="list-style-type: none"> [Hi POWER] Display

No.	Item	Outline of specifications	Remarks
18	COMFORT SLEEP operation (Wireless remote controller specific operations)	<p>When you push the COMFORT SLEEP button during cooling, heating or A operation, the air conditioner will start the following operation.</p> <p>The fan speed display will indicate AUTO and low speed will be used.</p> <ul style="list-style-type: none"> Cooling operation In the operation suppression zone, where capacity is kept to the minimum, overcooling is prevented by raising the temperature setting by 1°C after 1 hour and by 2°C after 2 hours of operation. The room temperature is thus regulated between the operation suppression zone and the set temperature. When the OFF timer is simultaneously set, 1, 3, 5 and 9 hours appear by turns every pushing COMFORT SLEEP button and one of them can be selected for OFF timer. Heating operation In the operation suppression zone, where capacity is kept to the minimum, overheating is prevented by lowering the temperature setting by 1°C after 1 hour and by 2°C after 2 hours of operation. The room temperature is thus regulated between the set temperature and the operation suppression zone. When the OFF timer is simultaneously set, 1, 3, 5 and 9 hours appear by turns every pushing COMFORT SLEEP button and one of them can be selected for OFF timer. <div style="display: flex; justify-content: space-around; align-items: flex-end;">   </div>	<ul style="list-style-type: none"> [] display
19	PRESET operation (Wireless remote controller specific operations)	<p>Start the air conditioner in the operation mode which you want the remote controller to memorize.</p> <ol style="list-style-type: none"> Push and hold the PRESET button for more than 3 seconds while the display flashes. <ul style="list-style-type: none"> The mark is indicated and the setting is memorized. If you do not push the PRESET button within 3 seconds or if you push another button, the memory setting is cancelled. Operation modes which can be memorized with the PRESET button are MODE, Temperatures, FAN, TIMER and Hi POWER. <p>To operate the air conditioner with the setting memorized by the PRESET button.</p> <ol style="list-style-type: none"> Push the PRESET button briefly. <ul style="list-style-type: none"> The setting memorized will be indicated and the air conditioner operates with regards to the setting. The lamp (green) on the display panel of the indoor unit goes on, and operation starts after approximately 3 minutes. Initial setting: MODE : AUTO Temperature : 22 	<ul style="list-style-type: none"> [] display

No.	Item	Outline of specifications	Remarks
20	QUIET operation (Wireless remote controller specific operation)	When you push the QUIET button during cooling, heating, fan only or A operation, the air conditioner will start the following operation. • The fan speed display will indicate AUTO and low speed will be used.	• [] display
21	SLEEP operation (Wireless remote controller specific operation)	When the OFF timer is set, 1, 3, 5 and 9 hours appear by turns every pushing SLEEP button and one of them can be selected for OFF timer.	
22	Save operation	1) The function [Save operation] is not provided to the Super Modular Multi series models.	• If pushing [SAVE] button “  ” on the remote controller, “No function” is displayed.

6. APPLIED CONTROL

6-1. Indoor Unit

6-1-1. Setup of Selecting Function in Indoor Unit (Be Sure to Execute Setup by a Wired Remote Controller)

<Procedure> Execute the setup operation while the unit stops.

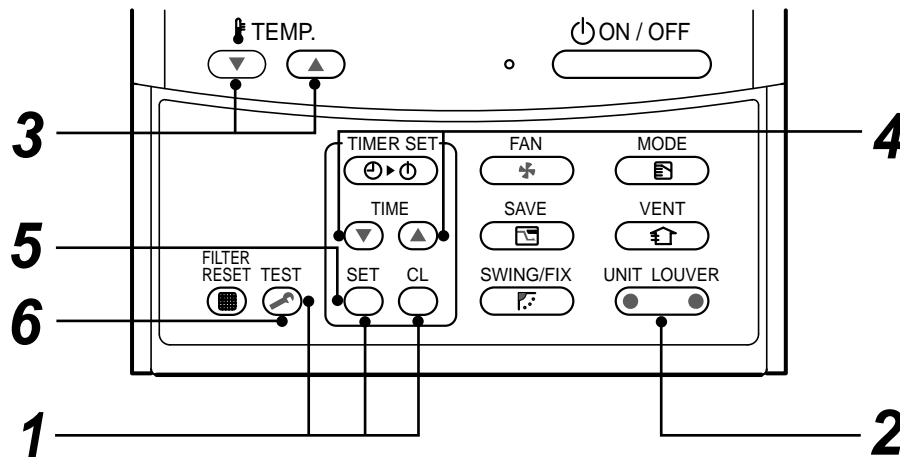

- 1** Push **SET**, **CL**, and **TEST** buttons simultaneously for 4 seconds or more.
The firstly displayed unit No. indicates the header indoor unit address in the group control.
In this time, the fan of the selected indoor unit is turned on.
- 2** Every pushing **UNIT LOUVER** button, the indoor unit numbers in the group control are successively displayed. In this time, the fan of the selected indoor unit only is turned on.
- 3** Specify the item code (DN) using the setup temperature **DOWN** and **UP** buttons.
- 4** Select the setup data using the timer time **DOWN** and **UP** buttons.
(When selecting the DN code to “33”, change the temperature indication of the unit from “°C” to “°F” on the remote controller.)
- 5** Push **SET** button. (OK if display goes on.)
 - To change the selected indoor unit, return to procedure **2**.
 - To change the item to be set up, return to procedure **3**.
- 6** Pushing **TEST** button returns the status to normal stop status.

Table: Function selecting item numbers (DN)
(Items necessary to perform the applied control at the local site are described.)

DN	Item	Description	At shipment
01	Filter display delay timer	0000 : None 0002 : 2500H 0004 : 10000H 0001 : 150H 0003 : 5000H	0001 : 150H
02	Dirty state of filter	0000 : Standard 0001 : High degree of dirt (Half of standard time)	0000 : Standard
03	Central control address	0001 : No.1 unit to 0064 : No.64 unit 0099 : Unfixed	0099 : Unfixed
04	Specific indoor unit priority	0000 : No priority 0001 : Priority	0000 : No priority
06	Heating temp shift	0000 : No shift 0002 : +2°C to 0003 : +3°C 0010 : +10°C (Up to +6 recommended)	0003 : +3°C
0d	Existence of [AUTO] cool / heat mode	0000 : Provided 0001 : Not provided (Automatic selection from connected outdoor unit)	0001 : Not provided
0F	Cooling only	0000 : Heat pump 0001 : Cooling only (No display of [AUTO] [HEAT])	0000 : Heat pump
10	Type	0008: High Wall	Depending on model type
11	Indoor unit capacity	0000 : Unfixed 0001 to 0034	According to capacity type
12	Line address	0001 : No.1 unit to 0030 : No.30 unit	0099 : Unfixed
13	Indoor unit address	0001 : No.1 unit to 0064 : No.64 unit	0099 : Unfixed
14	Group address	0000 : Individual 0002 : Follower unit of group 0001 : Header unit of group	0099 : Unfixed
1E	Temp difference of [AUTO] mode selection COOL → HEAT, HEAT → COOL	0000 : 0 deg to 0010 : 10 deg (For setup temperature, reversal of COOL/HEAT by ± (Data value)/2)	0003 : 3 deg (Ts±1.5)
28	Automatic restart of power failure	0000 : None 0001 : Restart	0000 : None
2A	Selection of option/error input (CN80)	0000 : Filter input 0002 : Outside error input 0001 : Alarm input (Air washer, etc.)	0002 : Outside error input (Interlock)
2E	HA terminal (CN61) select	0000 : Usual 0002 : Fire alarm input 0001 : Leaving-ON prevention control	0000 : Usual (HA terminal)
31	Ventilating fan control	0000 : Unavailable 0001 : Available	0000 : Unavailable
32	TA sensor selection	0000 : Body TA sensor 0001 : Remote controller sensor	0000 : Body TA sensor
33	Temperature unit select	0000 : °C (at factory shipment) 0001 : °F	0000 : °C

TYPE

Item code [10]

Setup data	Type	Abbreviated Model name
0008	High Wall	MMK-AP XXX HP1

Indoor unit capacity

Item code [11]

Setup data	Model
0001	007
0003	009
0005	012
0007	015
0009	018
0011	024

6-1-2. Applied Control in Indoor Unit

■ **Remote location ON/OFF control box (TCB-IFCB-4E2)**

[Wiring and setup]

- Use the exclusive connector for connection with the indoor control P.C. board.
- In a group control, the system can operate when connecting with any indoor unit (Control P.C. board) in the group. However when taking out the operation/error signal from the other unit, it is necessary to take out from each unit individually.

(1) Control items

- 1) Start/Stop input signal : Operation start/stop in unit
- 2) Operation signal : Output during normal operation
- 3) Error signal : Output during alarm
(Serial communication error or indoor/outdoor protective device) operation

(2) Wiring diagram using remote control interface (TCB-IFCB-4E2)

Input IFCB-4E2 : No voltage ON/OFF serial signal
 Output No voltage contact for operation, error display
 Contact capacity: Below Max. AC240V 0.5A

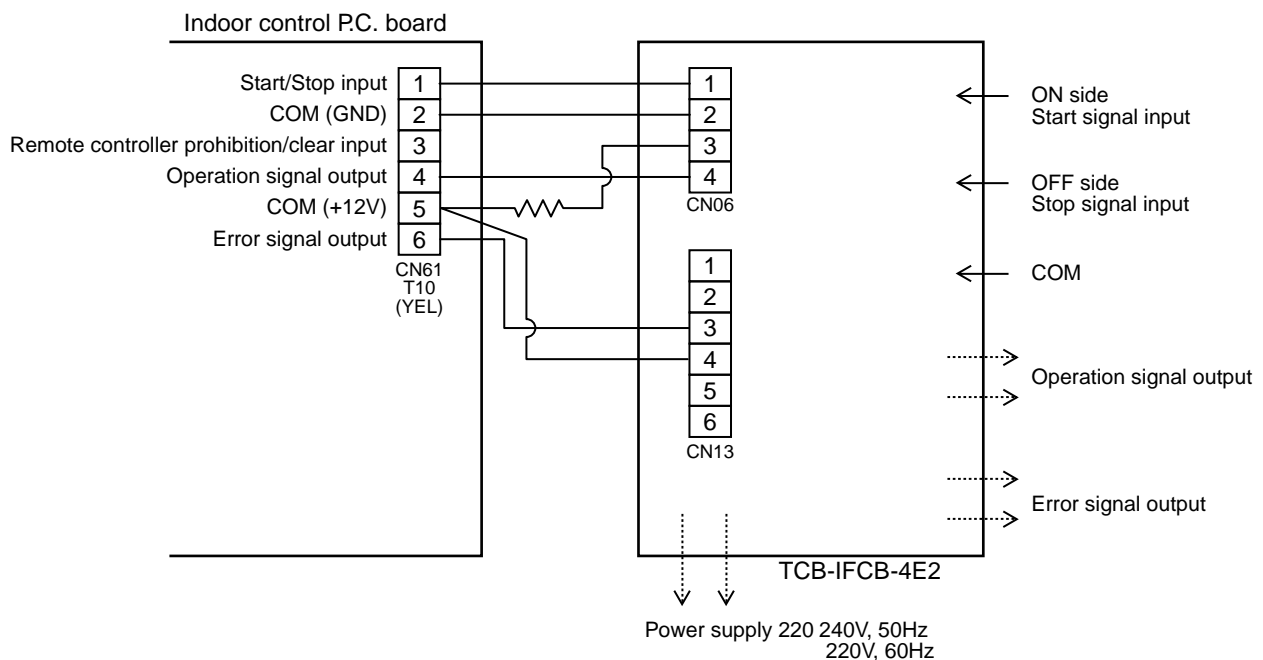

■ Ventilating fan control from remote controller

[Function]

- The start/stop operation can be operated from the wired remote controller when air to air heat exchanger or ventilating fan is installed in the system.
- The fan can be operated even if the indoor unit is not operating.
- Use a fan which can receive the no-voltage A contact as an outside input signal.
- In a group control, the units are collectively operated and they can not be individually operated.

1. Operation

Handle a wired remote controller in the following procedure.

- * Use the wired remote controller during stop of the system.
- * Be sure to set up the wired remote controller to the header unit. (Same in group control)
- * In a group control, if the wired remote controller is set up to the header unit, both header and follower units are simultaneously operable.

1 Push concurrently + + buttons for 4 seconds or more.

The unit No. displayed firstly indicates the header indoor unit address in the group control.

In this time, the fan of the selected indoor unit turns on.

2 Every pushing button, the indoor unit numbers in group control are displayed successively.

In this time, the fan of the selected indoor unit only turns on.

3 Using the setup temp or button, specify the item code 31 .

4 Using the timer time or button, select the setup data. (At shipment: 0000)

The setup data are as follows:

Setup data	Handling of operation of air to air heat exchanger or ventilating fan
0000	Unavailable (At shipment)
0001	Available

5 Push button. (OK if display goes on.)

- To change the selected indoor unit, go to the **procedure 2**).
- To change the item to be set up, go to the **procedure 3**).

6 Pushing returns the status to the usual stop status.

2. Wiring

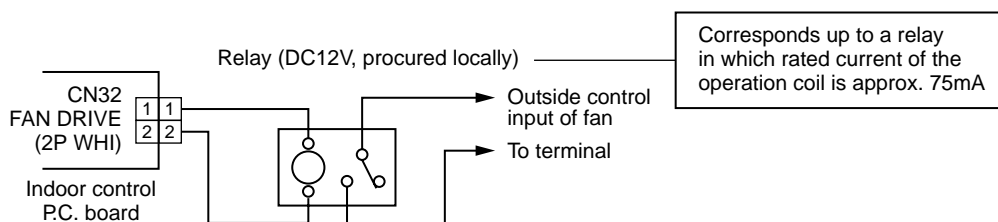

Note) Determine the cable length between the indoor control P.C. board and the relay within 2m.

■ Leaving-ON prevention control

[Function]

- This function controls the indoor units individually. It is connected with cable to the control P.C. board of the indoor unit.
- In a group control, it is connected with cable to the indoor unit (Control P.C. board), and the item code 2E is set to the connected indoor unit.
- It is used when the start operation from outside if unnecessary but the stop operation is necessary.
- Using a card switch box, card lock, etc, the forgotten-OFF of the indoor unit can be protected.
- When inserting a card, start/stop operation from the remote controller is allowed.
- When taking out a card, the system stops if the indoor unit is operating and start/stop operation from the remote controller is forbidden.

1. Control items









- 1) Outside contact ON : The start/stop operation from the remote controller is allowed.
(Status that card is inserted in the card switch box)
- 2) Outside contact OFF : If the indoor unit is operating, it is stopped forcedly.
(Start/Stop prohibited to remote controller)
(Status that card is taken out from the card switch box)

* When the card switch box does not perform the above contact operation, convert it using a relay with b contact.

2. Operation

Handle the wired remote controller switch in the following procedure.

* Use the wired remote controller switch during stop of the system.

- 1 Push concurrently  +  +  buttons for 4 seconds or more.**
- 2 Using the setup temp  or  button, specify the item code *2E*.**
- 3 Using the timer time  or  button, set *0001* to the setup data.**
- 4 Push  button.**
- 5 Push  button. (The status returns to the usual stop status.)**

3. Wiring

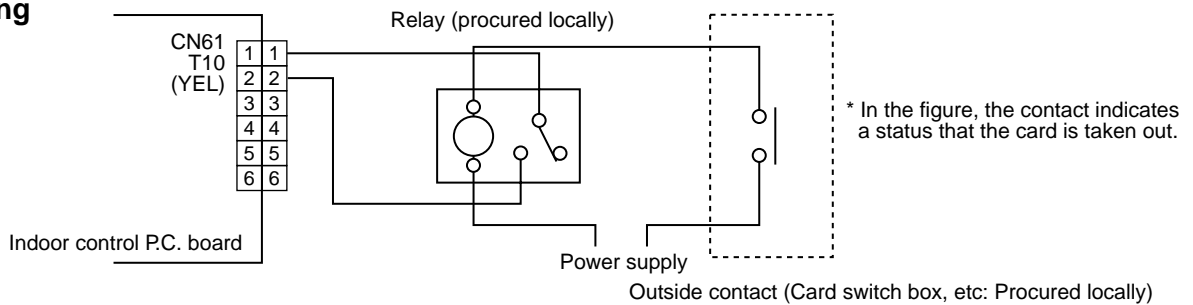

Note) Determine the cable length between the indoor control P.C. board and the relay within 2m.

■ Power peak-cut from indoor unit

When the relay is turned on, a forced thermostat-OFF operation starts.

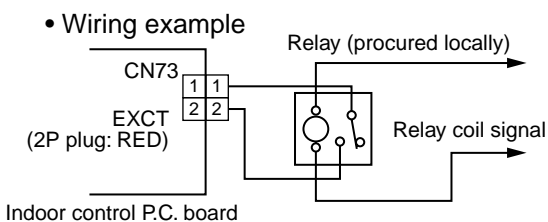

Note) Determine the cable length between the indoor or outdoor control P.C. board and the relay within 2m.

■ Indoor P.C. Board
MCC-1510

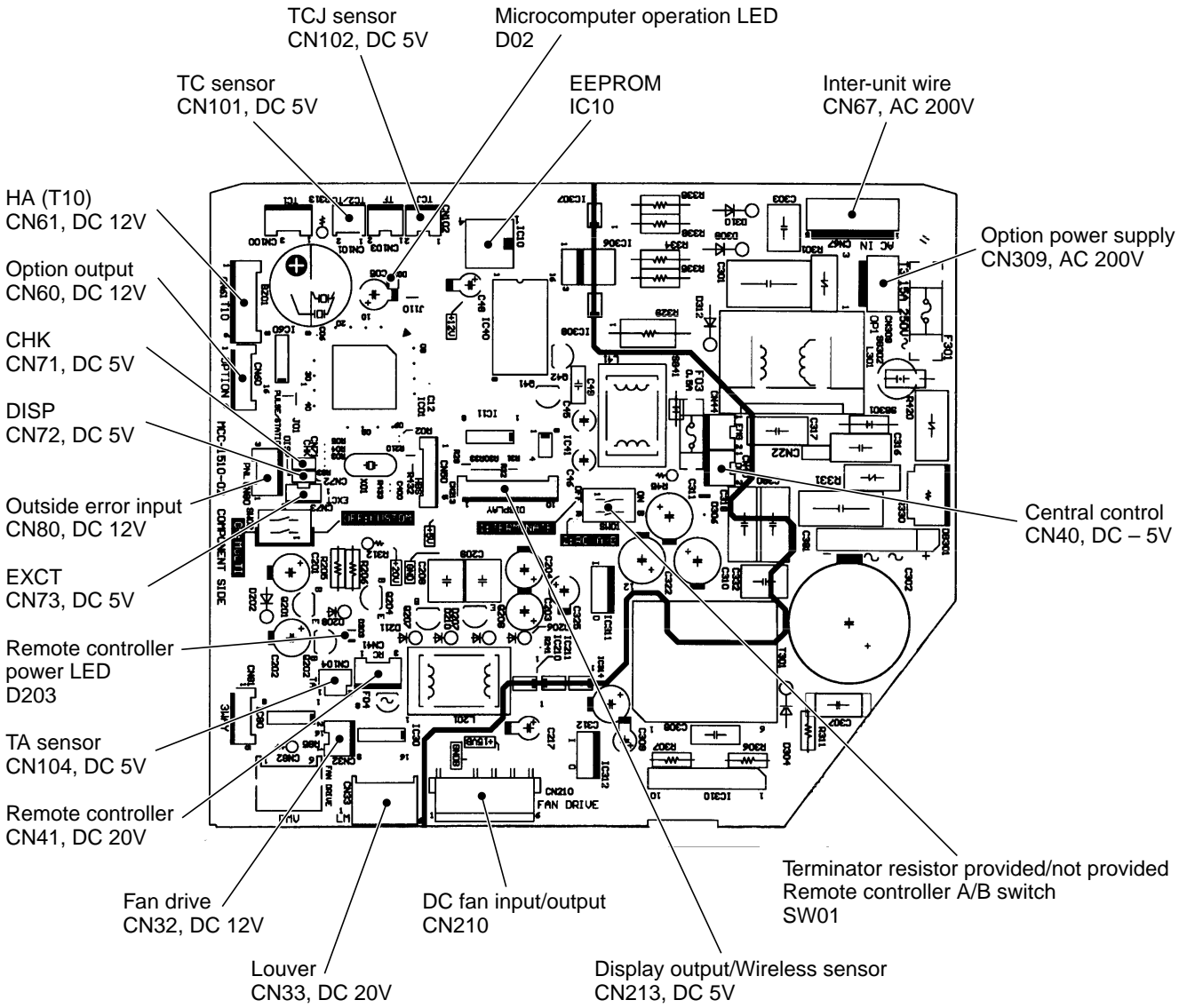

Wall-Type P.C. Board Optional Switch/Connector Specifications

Function	Connector No.	Pin No.	Specifications	Remarks
Terminator resistor provided/Not provided	SW01	Bit 1	OFF: No terminator resistor, ON: Terminator resistor provided	Setup at shipment OFF: No terminator resistor. Only 1 unit is ON during central control by custom only.
Remote controller A/B		Bit 2	OFF: Remote controller A ON: Remote controller B	Setup at shipment OFF: Remote controller A
Fan output	CN32	1	DC12V	Setup at shipment: Linked operation of ON with operation of indoor unit and OFF with stop
		2	Output	* The setup of single operation by FAN button on remote controller is executed from remote controller. (DN = 31)
HA	CN61	1	Start/Stop input	HA Start/Stop input (J01: Provided/Not provided = Pulse (At shipment from factory)/Static input switch)
		2	0V (COM)	
		3	Handy prohibition input	Operation stop of handy remote controller is permitted / prohibited by input.
		4	Operation output	ON during operation (Answer back of HA)
		5	DC12V (COM)	
		6	Alarm output	ON during output of alarm
Optional output	CN60	1	DC12V (COM)	
		2	Defrost output	ON during defrosting of outdoor unit
		3	Thermo-ON output	ON when Real thermo. ON (Comp. ON)
		4	Cooling output	ON when operation mode is cooling line (Cool, Dry, Cooling/Heating AUTO cooling)
		5	Heating output	ON when operation mode is heating line (Heat, Cooling/Heating AUTO heating)
		6	Fan output	ON when indoor fan is ON
Outside error input	CN80	1	DC12V (COM)	At shipment from factory, the error code "L30" generates and optional error input to stop operation forcedly (DN:2A = 1) is controlled (Display of protection for devices attached to outside) by setup of outside error input (DN:2A = 2) for 1 minute. * Optional error input control is set up on the remote controller.
		2	DC12V (COM)	
		3	Filter/Option/Outside error input	
CHK Operation check	CN71	1	Check mode input	This check is used for operation check of indoor unit. (The specified operation such as indoor fan "H", drain pump ON, etc. is executed without communication with outdoor unit or remote controller.)
		2	0V	
DISP Display mode	CN72	1	Display mode input	Display mode, communication is enabled by indoor unit and remote controller only. (When power supply is turned on.) Timer short (Usual)
		2	0V	
EXCT Demand	CN73	1	Demand input	Indoor unit forced thermo-OFF operation
		2	0V	

7. TROUBLESHOOTING

7-1. Troubleshooting Summary

1. Before troubleshooting

1) Applied models

All Super Module Multi-system type models

(Indoor unit: MMX-APXXX, Outdoor unit: MMY-MAPXXX)

2) Required tools / measuring devices

- Screwdrivers (Philips, Minus), spanner, radio pinchers, nipper, push pin for reset switch, etc.
- Tester, thermometer, pressure gauge, etc.

3) Confirmation before check (The following items are not troubles.)

No.	Operation	Check items
1	Compressor does not operate.	<ul style="list-style-type: none"> • Is not delayed for 3 minutes? (3 minutes after compressor-OFF) • Is not thermostat OFF? • Is not the fan operating or timer? • Is not the system initially communicating?
2	Indoor fan does not work.	<ul style="list-style-type: none"> • Is not the cold draft prevention being controlled in heating operation?
3	Outdoor fan does not rotate, or fan speed changes.	<ul style="list-style-type: none"> • Is not low cooling operation being controlled? • Is not a defrost operation being performed?
4	Indoor fan does not stop.	<ul style="list-style-type: none"> • Is not after-heat elimination operation being controlled after heating operation?
5	Start/stop operation on remote controller is unavailable.	<ul style="list-style-type: none"> • Is not auxiliary unit or remote control being operated?
6	—	<ul style="list-style-type: none"> • Is connecting wire of indoor unit or remote controller correct?

2. Troubleshooting procedure

When a trouble occurred, advance the check operation in the following procedure.

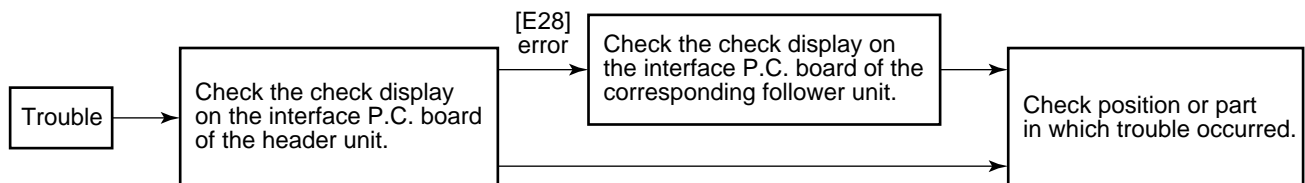

NOTE) While a check operation is performed, a malfunction of the microprocessor may be caused due to condition of the power supply or the external noise.

If there is any noise source, change wires of the remote controller and signal wires to shield wires.

7-2. Check Method

On the remote controller (Main remote controller, Central control remote controller) and the interface P.C. board of the outdoor unit, a check display LCD (Remote controller) or 7-segment display (on the outdoor interface P.C. board) to display the operation is provided. Therefore the operation status can be known. Using this self-diagnosis function, a trouble or position with trouble of the air conditioner can be found as shown in the table below.

7-2-1. Check Code List

The following list shows each check code. Find the check contents from the list according to part to be checked.

- In case of check from indoor remote controller: See “Main remote controller display” in the list.
- In case of check from outdoor unit: See “Outdoor 7-segment display” in the list.
- In case of check from TCC-LINK central control remote controller: See “TCC-LINK central control display” in the list.
- However connection with AI-NET central control is disabled for the wall type (3 series).
- In case of check from indoor unit with wireless remote controller: See “Sensor block display of receiving unit” in the list.

IPDU: Intelligent Power Drive Unit

○ : Lighting, ✕ : Flashing, ● : Goes off

ALT.: Flashing is alternately when there are two flashing LED.

SIM: Simultaneous flashing when there are two flashing LED.

Check code				Wireless remote controller				Check code name	Judging device
Main remote controller display	Outdoor 7-segment display		AI-NET central control display	Sensor block display of receiving unit					
		Sub code		Ready ⊗	Timer ⊖	Operation ⊕	Flash		
E01	—	—	—	●	●	✕		Communication error between indoor and remote controller (Detected at remote controller side)	Remote controller
E02	—	—	—	●	●	✕		Sending error of remote controller	Remote controller
E03	—	—	97	●	●	✕		Communication error between indoor and remote controller (Detected at indoor side)	Indoor
E04	—	—	04	✕	●	●		Communication circuit error between indoor and outdoor (Detected at indoor side)	Indoor
E06	E06	No. of indoor units in which sensor has been normally received	04	✕	●	●		Decrease of No. of indoor units	I/F
—	E07	—	—	✕	●	●		Communication circuit error of indoor and outdoor (Detected at outdoor side)	I/F
E08	E08	Duplicated indoor addresses	96	●	●	✕		Duplicated indoor addresses	Indoor/I/F
E09	—	—	99	●	●	✕		Duplicated master remote controllers	Remote controller
E12	E12	01: Indoor/Outdoor communication 02: Communication between outdoor units	42	●	●	✕		Automatic address start error	I/F
E15	E15	—	42	✕	●	●		No indoor automatic address	I/F
E16	E16	00: Capacity over 01: No. of connected units	89	✕	●	●		No. of connected indoor units / Capacity over	I/F
E18	—	—	97, 99	●	●	✕		Communication error between indoor header and follower units	Indoor
E19	E19	00: No header unit 02: Two or more header units	96	✕	●	●		Outdoor header units quantity error	I/F
E20	E20	01: Outdoor of other line connected 02: Indoor of other line connected	42	✕	●	●		Other line connected during automatic address	I/F
E23	E23	—	15	✕	●	●		Sending error in communication between outdoor units	I/F
E25	E25	—	15	✕	●	●		Duplicated follower outdoor addresses	I/F
E26	E26	No. of outdoor units which received signal normally	15	✕	●	●		Decrease of No. of connected outdoor units	I/F
E28	E28	Detected outdoor unit number	d2	✕	●	●		Follower outdoor error	I/F
E31	E31	01: IPDU1 error 02: IPDU2 error 03: IPDU1, 2 error 04: Fan IPDU error 05: IPDU + Fan IPDU error 06: IPDU2 + Fan IPDU error 07: All IPDU error	CF	✕	●	●		IPDU communication error	I/F

Check code				Wireless remote controller				Check code name	Judging device
Main remote controller display	Outdoor 7-segment display		AI-NET central control display	Sensor block display of receiving unit			Flash		
		Sub code		Ready	Timer	Operation			
F01	—	—	OF	●	☒	☒	ALT	Indoor TCJ sensor error	Indoor
F02	—	—	Od	●	☒	☒	ALT	Indoor TC2 sensor error	Indoor
F03	—	—	93	●	☒	☒	ALT	Indoor TC1 sensor error	Indoor
F04	F04	—	19	○	☒	☒	ALT	TD1 sensor error	I/F
F05	F05	—	A1	○	☒	☒	ALT	TD2 sensor error	I/F
F06	F06	—	18	○	☒	☒	ALT	TE1 sensor error	I/F
F07	F07	—	18	○	☒	☒	ALT	TL sensor error	I/F
F08	F08	—	1b	○	☒	☒	ALT	TO sensor error	I/F
F10	—	—	OC	●	☒	☒	ALT	Indoor TA sensor error	Indoor
F12	F12	—	A2	○	☒	☒	ALT	TS1 sensor error	I/F
F13	F13	01: Comp. 1 side 02: Comp. 2 side	43	○	☒	☒	ALT	TH sensor error	IPDU
F15	F15	—	18	○	☒	☒	ALT	Outdoor temp sensor misconnecting (TE, TL)	I/F
F16	F16	—	43	○	☒	☒	ALT	Outdoor pressure sensor misconnecting (Pd, Ps)	I/F
F23	F23	—	43	○	☒	☒	ALT	Ps sensor error	I/F
F24	F24	—	43	○	☒	☒	ALT	Pd sensor error	I/F
F29	—	—	12	●	☒	☒	SIM	Indoor other error	Indoor
F31	F31	—	1C	○	☒	☒	SIM	Outdoor EEPROM error	I/F
H01	H01	01: Comp. 1 side 02: Comp. 2 side	IF	●	☒	●		Compressor break down	IPDU
H02	H02	01: Comp. 1 side 02: Comp. 2 side	1d	●	☒	●		Magnet switch error Overcurrent relay operation Compressor error (lock)	MG-SW Overcurrent relay IPDU
H03	H03	01: Comp. 1 side 02: Comp. 2 side	17	●	☒	●		Current detect circuit system error	IPDU
H04	H04	—	44	●	☒	●		Comp 1 case thermo operation	I/F
H06	H06	—	20	●	☒	●		Low pressure protective operation	I/F
H07	H07	—	d7	●	☒	●		Oil level down detective protection	I/F
H08	H08	01: TK1 sensor error 02: TK2 sensor error 03: TK3 sensor error 04: TK4 sensor error	d4	●	☒	●		Oil level detective temp sensor error	I/F
H14	H14	—	44	●	☒	●		Comp 2 case thermo operation	I/F
H16	H16	01: TK1 oil circuit system error 02: TK2 oil circuit system error 03: TK3 oil circuit system error 04: TK4 oil circuit system error	d7	●	☒	●		Oil level detective circuit error Magnet switch error Overcurrent relay operation	I/F MG-SW Overcurrent relay
L03	L03	—	96	☒	●	☒	SIM	Duplicated indoor header units	Indoor
L04	L04	—	96	☒	○	☒	SIM	Duplicated outdoor line addresses	I/F
L05	L05	—	96	☒	●	☒	SIM	Duplicated indoor units with priority (Displayed on indoor unit with priority)	I/F
L06	L06	No. of indoor units with priority	96	☒	●	☒	SIM	Duplicated indoor units with priority (Displayed in unit other than indoor unit with priority)	I/F
L07	—	—	99	☒	●	☒	SIM	Group line in individual indoor unit	Indoor
L08	L08	—	99	☒	●	☒	SIM	Indoor group/Address unset	Indoor I/F
L09	—	—	46	☒	●	☒	SIM	Indoor capacity unset	Indoor
L10	L10	—	88	☒	○	☒	SIM	Outdoor capacity unset	I/F
L20	—	—	98	☒	○	☒	SIM	Duplicated central control addresses	AI-NET Indoor
L28	L28	—	46	☒	○	☒	SIM	Over No. of connected outdoor units	I/F
L29	L29	01: IPDU1 error 02: IPDU2 error 03: IPDU3 error 04: Fan IPDU error 05: IPDU1 + Fan IPDU error 06: IPDU2 + Fan IPDU error 07: All IPDU error	CF	☒	○	☒	SIM	No. of IPDU error	I/F
L30	L30	Detected indoor address	b6	☒	○	☒	SIM	Auxiliary interlock in indoor unit	Indoor
—	L31	—	—	—	—	—		IC error	I/F

Check code			Wireless remote controller				Check code name	Judging device	
Main remote controller display	Outdoor 7-segment display		AI-NET central control display	Sensor block display of receiving unit					
	Auxiliary code			Ready	Timer	Operation			Flash
P01	—	—	11	☒	☒	●	ALT	Indoor fan motor error	Indoor
P03	P03	—	1E	☒	●	☒	ALT	Discharge temp TD1 error	I/F
P04	P04	01: Comp. 1 side 02: Comp. 2 side	21	☒	●	☒	ALT	High-pressure SW detection error	IPDU
P05	P05	01: Phase-missing detection 02: Phase order error	AF	☒	●	☒	ALT	Phase-missing detection / Phase order error	I/F
P07	P07	01: Comp. 1 side 02: Comp. 2 side	1C	☒	●	☒	ALT	Heat sink overheat error	IPDU I/F
P12	—	—	11	☒	☒	●	ALT	Indoor fan motor error	Indoor
P13	P13	—	47	☒	☒	●	ALT	Outdoor liquid back detection error	I/F
P15	P15	01: TS condition 02: TD condition	AE	☒	●	☒	ALT	Gas leak detection	I/F
P17	P17	—	bb	☒	●	☒	ALT	Discharge temp TD2 error	I/F
P19	P19	Detected outdoor unit number	08	☒	●	☒	ALT	4-way valve inverse error	I/F
P20	P20	—	22	☒	●	☒	ALT	High-pressure protective operation	I/F
P22	P22	0 — : IGBT short 1 — : Fan motor position detective circuit error 3 — : Fan motor trouble C — : TH sensor temp. error (Heat sink overheat) D — : TH sensor error E — : Vdc output error	1A	☒	●	☒	ALT	Outdoor fan IPDU error	Fan IPDU
P26	P26	01: Comp. 1 side 02: Comp. 2 side	14	☒	●	☒	ALT	G-TR short protection error	IPDU
P29	P29	01: Comp. 1 side 02: Comp. 2 side	16	☒	●	☒	ALT	Comp position detective circuit system error	IPDU
P31	—	—	47	☒	●	☒	ALT	Other indoor unit error (Group follower unit error)	Indoor
—	—	—	b7	By alarm device			ALT	Error in indoor group	AI-NET
—	—	—	97	—			—	AI-NET communication system error	AI-NET
—	—	—	99	—			—	Duplicated network adaptors	AI-NET

Error detected by TCC-LINK central control device

Check code			Wireless remote controller				Check code name	Judging device	
Central control device indication	Outdoor 7-segment display		AI-NET central control display	Sensor block display of receiving unit					
	Auxiliary code			Ready	Timer	Operation			Flash
C05	—	—	—	—				Sending error in TCC-LINK central control device	TCC-LINK
C06	—	—	—	—				Receiving error in TCC-LINK central control device	TCC-LINK
C12	—	—	—	—				Batch alarm of general-purpose equipment control interface	HA control interface I/F
P30	Differs according to error contents of unit with occurrence of alarm						Group control follower unit error	TCC-LINK	
	—	—	(L20 is displayed.)				Duplicated central control addresses		

7-3. Troubleshooting by Check Display on Remote Controller

7-3-1. In Case of Main Remote Controller (RBC-AMT32E)

1. Confirmation and check

When a trouble occurred on the air conditioner, the check code and the indoor unit No. are displayed on the display section of the remote controller.

The check code is displayed while the air conditioner operates.

If the display disappeared, operate the air conditioner and check the error based upon the following "Confirmation of error history".

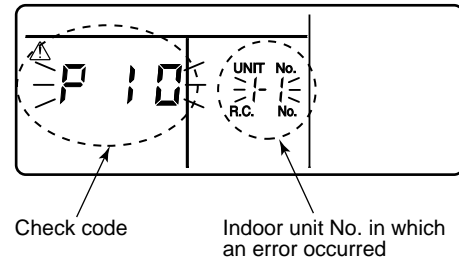

2. Confirmation of error history

When a trouble occurred on the air conditioner, the error history can be confirmed with the following procedure.

(Up to 4 error histories are stored in memory.)

This history can be confirmed from either operating status or stop status.

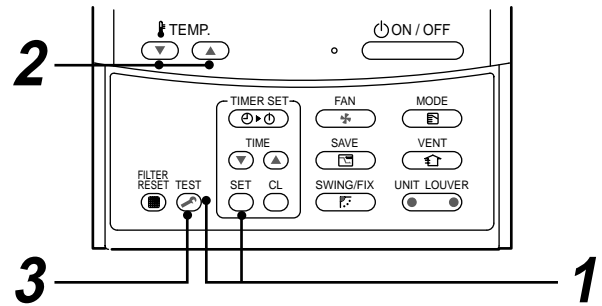

Procedure	Description
1	<p>When pushing and buttons simultaneously for 4 seconds or more, the below display appears. If [Service Check] is displayed, the mode enters in the error history mode.</p> <ul style="list-style-type: none"> • [01: Error history order] is displayed in CODE No. window. • [Check Code] is displayed in check code window. • [Indoor unit address with error] is displayed in UNIT No.
2	<p>Every pushing temp. set / buttons, the error histories stored in the memory are displayed in order. The numbers in CODE No. indicates CODE No. [01] (Latest) to [04] (Oldest).</p> <p>CAUTION Do not push button because all the error histories of the indoor unit will be deleted.</p>
3	<p>After confirmation, push button to return to the usual display.</p>

How to read the check monitor display

<7-segment display>



<How to read>

0 1 2 3 4 5 6 7 8 9 A b C d E F H J L P

7-3-2. In Case of TCC-LINK Central Control Remote Controller (TCB-SC642TLE2)

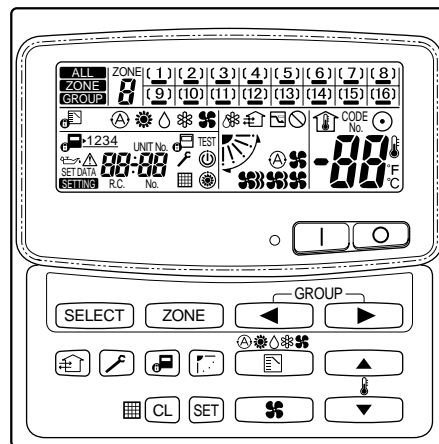

1. Confirmation and check

When a trouble occurred on the air conditioner, the check code and the indoor unit No. are displayed on the display section of the remote controller.

The check code is displayed while the air conditioner operates.

If the display disappeared, operate the air conditioner and check the error based upon the following "Confirmation of error history".

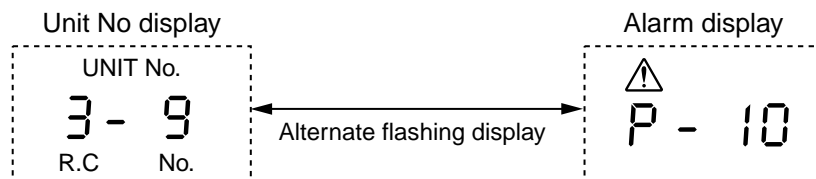

2. Confirmation of error history

When a trouble occurred on the air conditioner, the error history can be confirmed with the following procedure. (Up to 4 error histories are stored in memory.)

This history can be confirmed from either operating or stop.

- 1) Push and buttons in succession for 4 seconds or more.
- 2) SERVICE CHECK goes on and Item code 01 goes on.
- 3) When selecting (flash) the group number if there is the alarm history, the UNIT number and the latest alarm history are displayed alternately.
 - * In this time, the temperature cannot be set up.
- 4) To confirm the alarm history other than the latest one, push temp. set / to select Item code (01 to 04).
- 5) To confirm the alarm in the other group, push and to select the group number.

Do not push button because all the alarm histories of the currently selected group are deleted.

- 6) To finish the service check, push button.

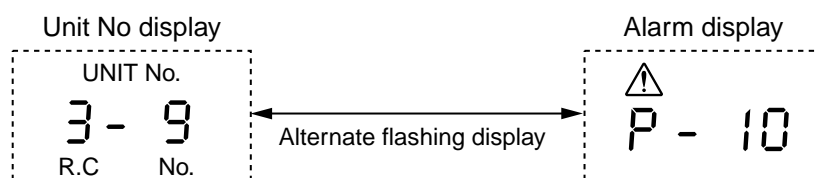

7-4. Check Code and Check Position Displayed on the Remote Controller and Outdoor Unit (7-Segment Display of Interface)

Main remote controller	Check code			Detected position	Check code name	Status	Error detection condition	Check item (position)
	Outdoor 7-segment display		AI-NET central control remote controller					
	Check code	Sub-code						
E01	—	—	—	Remote controller	Communication error between indoor and remote controller (Detected at remote controller side)	Corresponding unit only stops.	Communication interrupted between indoor P.C. board and remote controller.	<ul style="list-style-type: none"> • Check remote controller inter-unit wire (A/B). • Check disconnection, connector contact error. • Check indoor power supply. • Check indoor P.C. board error. • Check remote controller address setup. (When two remote controllers operate) • Check remote controller P.C. board.
E02	—	—	—	Remote controller	Remote controller sending error	Corresponding unit only stops.	Signal could not be sent from remote controller to indoor unit.	<ul style="list-style-type: none"> • Check the communication wire of remote controller: Exchange remote controller.
E03	—	—	97	Indoor unit	Communication error between indoor and remote controller (Detected at indoor side)	Corresponding unit only stops.	No communication from remote controller (including wireless) and communication adaptor.	<ul style="list-style-type: none"> • Check remote controller and communication adaptor wiring.
E04	—	—	4	Indoor unit	Indoor/outdoor communication circuit error (Detected at indoor side)	Corresponding unit only stops.	Indoor unit does not receive communication from outdoor unit.	<ul style="list-style-type: none"> • Check power-ON order of indoor/outdoor. • Check indoor address setup. • Check inter-unit wiring between indoor and outdoor. • Check outdoor end terminal resistance setup (SW30-2). • Check SW02 setup on the wall type P.C. board. (Should be Bit 1: ON, Bit 2: OFF)
E06	E06	No. of indoor units which received signal normally	4	I/F	Decreased number of indoor units	All stop	When signal is not sent for a certain period from the indoor unit which has been used to send signals, [E06] is normally displayed.	<ul style="list-style-type: none"> • Check the power supply of indoor unit. (Power-ON) • Check connection of communication line between indoor and outdoor. • Check connector connection for communication in indoor P.C. board. • Check connector connection for communication in outdoor P.C. board. • Check indoor P.C. board failure. • Check outdoor P.C. board (I/F) failure.
—	E07	—	—	I/F	Indoor/outdoor communication circuit error (Detected at outdoor side)	All stop	Transmission from outdoor to indoor cannot continue for 30 seconds.	<ul style="list-style-type: none"> • Check outdoor end terminal resistance setup (SW30-2). • Check the communication connection between indoor and outdoor.
E08	E08	Duplicated indoor addresses	96	Indoor I/F	Duplicated indoor addresses	All stop	Multiple indoor unit address setup are duplicated.	<ul style="list-style-type: none"> • Check indoor address. • Check the change of remote controller connection (Group / individual) after setup of indoor address. • Check SW02 setup on the wall type P.C. board. (Should be Bit 1: ON, Bit 2: OFF)
E09	—	—	99	Remote controller	Duplicated master remote controllers	Corresponding unit only stops.	In 2-remote controller control (including wireless), both are setup as master (Header indoor unit stops and other indoor unit is operating.)	<ul style="list-style-type: none"> • Check remote controller setup. • Check remote controller P.C. board.

Main remote controller	Check code		AI-NET central control remote controller	Detected position	Check code name	Status	Error detection condition	Check item (position)
	Outdoor 7-segment display	Sub-code						
E12	E12	01: Indoor/outdoor communication 02: Between outdoors communication	42	I/F	Automatic address start error	All stop	<ul style="list-style-type: none"> When indoor automatic address started, other refrigerant circuit system was setting automatic address. When outdoor automatic address started, indoor automatic address was executed. 	<ul style="list-style-type: none"> Setup the address again after disconnecting communication connection with other refrigerant circuit system.
E15	E15	—	42	I/F	No corresponding indoor unit during automatic address	All stop	Indoor unit is not found when indoor automatic address start was set up.	<ul style="list-style-type: none"> Check the communication line connection between indoor and outdoor. Check the electric power line error in indoor. Check the noise of surrounding devices. Power failure Check indoor P.C. board error.
E16	E16	00: Capacity over 01 to: No. of connected units	89	I/F	No. of connected indoor units / Capacity over	All stop	<ul style="list-style-type: none"> Total capacity of indoor units exceeded 135% of total outdoor capacity. No. of connected indoor units are more than 48 units. <p>[Note] If this code appears after backup setup of outdoor unit trouble, set up "No capacity-over detection".</p> <p><Setup method of "No capacity-over detection"> Turn on SW09/Bit 2 on I/F P.C. board of outdoor header unit.</p>	<ul style="list-style-type: none"> Check the connection capacity of indoor unit. Check the HP capacity of indoor unit. Check the indoor/outdoor capacity setup Check the No. of connected indoor units. Check the outdoor I/F P.C. board error
E18	—	—	97, 99	Indoor unit	Communication error between indoor header and follower units	Corresponding unit only stops.	Regular communication between indoor header and follower units .	<ul style="list-style-type: none"> Check wire of the remote controller. Check power wiring of indoor. Check P.C. board of indoor. Check SW02 setup on the wall type P.C. board. (Should be Bit 1: ON, Bit 2: OFF)
E19	E19	00: No header unit 02: Two or more header units	96	I/F	Outdoor header unit quantity error	All stop	<ul style="list-style-type: none"> There are multiple outdoor header units in 1 line. There is none of outdoor header unit in 1 line. 	<p>The outdoor unit connected with communication wire between indoor and outdoor (U1.U2) is the outdoor header unit.</p> <ul style="list-style-type: none"> Check connection of communication line between indoor and outdoor. Check outdoor P.C. board(I/F) error.
E20	E20	01: Connection of outdoor of other line 02: Connection of indoor of other line	42	I/F	Other line unit connected during automatic address	All stop	Unit of other line was connected when indoor automatic address started.	Separate the wire between lines according to automatic address setup method in "Address setup".
E23	E23	—	15	I/F	Communication sending error between outdoor units	All stop	Transmission of other outdoor unit was unavailable for 30 seconds or more.	<ul style="list-style-type: none"> Check the power of outdoor unit. (Is the power turned on?) Check connection of communication wire or disconnection between outdoor units. Check the connector for communication on outdoor P.C. board. Check outdoor P.C. board (I/F) error. Check the end terminal resistance setup for communication between outdoor units.

Main remote controller	Check code			Detected position	Check code name	Status	Error detection condition	Check item (position)
	Outdoor 7-segment display		AI-NET central control remote controller					
	Check code	Sub-code						
E25	E25	—	15	I/F	Duplicated outdoor follower address setup	All stop	Outdoor addresses manually set up are duplicated.	Note) Do not set up the outdoor address manually.
E26	E26	No. of normally received outdoor units	15	I/F	Decreased number of connected outdoor units	All stop	The signal was not returned for constant from the outdoor unit which was receiving signal.	<ul style="list-style-type: none"> Outdoor is performing backup. Check the power of outdoor unit. (Is the power turned on?) Check connection of inter-unit wire or disconnection between outdoor units. Check the connector connection for communication on outdoor P.C. board. Check outdoor P.C. board (I/F) error.
E28	E28	No. of detected outdoor units	d2	I/F	Outdoor follower unit error	All stop	Outdoor header unit received error code from outdoor follower unit.	<ul style="list-style-type: none"> Check the check code of outdoor follower unit. <div style="border: 1px solid black; padding: 5px; margin-top: 10px;"> <p align="center"><Convenient functions></p> <p>When pushing SW04 for 1 second or more under condition that [E28] is displayed on 7-segment display of outdoor header unit, the fan of outdoor unit which stopped abnormally starts rotating. If pushing SW04 and SW05 simultaneously, the fan of normal outdoor unit operates. When pushing SW05 singly, the operation of fan is cleared.</p> </div>
E31	E31	01: IPDU1 error 02: IPDU2 error 03: IPDU1, 2 errors 04: Fan IPDU error 05: IPDU1 + Fan IPDU error 06: IPDU2 + Fan IPDU error 07: All IPDU error or communication error between IPDU and I/F P.C. board or outdoor I/F P.C. board error	CF	I/F	IPDU communication error	All stop	Communication of each IPDU (P.C. board) in inverter box interrupted.	<ul style="list-style-type: none"> Check connection of communication connector and disconnection between IPDU and I/F P.C. board. Check outdoor P.C. board (I/F, IPDU, Fan IPDU) error. Check external noise. Check power supply P.C. board for fan error.
F01	—	—	OF	Indoor unit	Indoor TCJ sensor error	Corresponding unit only stops.	Resistance value of sensor is infinite or zero. (Open/Short)	<ul style="list-style-type: none"> Check connection/wiring of TCJ sensor connector. Check characteristics of TCJ sensor resistance value. Check indoor P.C. board error.
F02	—	—	Od	Indoor unit	Indoor TC2 sensor error	Corresponding unit only stops.	Resistance value of sensor is infinite or zero (Open/Short).	<ul style="list-style-type: none"> Check connection/wiring of TC2 sensor connector. Check characteristics of TC2 sensor resistance value. Check indoor P.C. board error.
F03	—	—	93	Indoor unit	Indoor TC1 sensor error	Corresponding unit only stops.	Resistance value of sensor is infinite or zero (Open/Short).	<ul style="list-style-type: none"> Check connection/wiring of TC1 sensor connector. Check characteristics of TC1 sensor resistance value. Check indoor P.C. board error.
F04	F04	—	19	I/F	TD1 sensor error	All stop	Resistance value of sensor is infinite or zero (Open/Short).	<ul style="list-style-type: none"> Check connection of TD1 sensor connector. Check characteristics of TD1 sensor resistance value. Check outdoor P.C. board (I/F) error.
F05	F05	—	A1	I/F	TD2 sensor error	All stop	Resistance value of sensor is infinite or zero (Open/Short).	<ul style="list-style-type: none"> Check connection of TD2 sensor connector. Check characteristics of TD2 sensor resistance value. Check outdoor P.C. board (I/F) error.
F06	F06	—	18	I/F	TE1 sensor error	All stop	Resistance value of sensor is infinite or zero (Open/Short).	<ul style="list-style-type: none"> Check connection of TE1 sensor connector. Check characteristics of TE1 sensor resistance value. Check outdoor P.C. board (I/F) error.

Main remote controller	Check code			Detected position	Check code name	Status	Error detection condition	Check item (position)
	Outdoor 7-segment display		AI-NET central control remote controller					
	Check code	Sub-code						
F07	F07	—	18	I/F	TL sensor error	All stop	<ul style="list-style-type: none"> Resistance value of sensor is infinite or zero (Open/Short). 	<ul style="list-style-type: none"> Check connection of TL sensor connector. Check characteristics of TL sensor resistance value. Check outdoor P.C. board (I/F) error.
F08	F08	—	1b	I/F	TO sensor error	All stop	<ul style="list-style-type: none"> Resistance value of sensor is infinite or zero (Open/Short). 	<ul style="list-style-type: none"> Check connection of TO sensor connector. Check characteristics of TO sensor resistance value. Check outdoor P.C. board (I/F) error.
F10	—	—	OC	Indoor	Indoor TA sensor error	Corresponding unit only stops.	<ul style="list-style-type: none"> Resistance value of sensor is infinite or zero (Open/Short). 	<ul style="list-style-type: none"> Check connection/wiring of TA sensor connector. Check characteristics of TA sensor resistance value. Check indoor P.C. board error.
F12	F12	—	A2	I/F	TS1 sensor error	All stop	<ul style="list-style-type: none"> Resistance value of sensor is infinite or zero (Open/Short). 	<ul style="list-style-type: none"> Check connection of TS1 sensor connector. Check characteristics of TS1 sensor resistance value. Check outdoor P.C. board (I/F) error.
F13	F13	01: Compressor 1 side 02: Compressor 2 side	43	IPDU	TH sensor error	All stop	<ul style="list-style-type: none"> Resistance value of sensor is infinite or zero (Open/Short). 	<ul style="list-style-type: none"> IGBT built-in temp sensor error → Exchange IPDU P.C. board.
F15	F15	—	18	I/F	Outdoor temp sensor miscabling (TE1, TL)	All stop	During operation of compressor in HEAT mode, the TE1 detection temp was higher than that of TL by the specified value continued for 3 minutes or more.	<ul style="list-style-type: none"> Check installation of TE1 sensor and TL sensor. Check characteristics of TE1 and TL sensor resistance value. Check outdoor P.C. board (I/F) error.
F16	F16	—	43	I/F	Outdoor pressure sensor miscabling (Pd, Ps)	All stop	High-pressure Pd sensor and low-pressure Ps sensor were exchanged, or output voltages of both sensors are zero.	<ul style="list-style-type: none"> Check connection of high-pressure Pd sensor connector. Check connection of low-pressure Ps sensor connector. Check pressure sensors Pd and Ps error. Check outdoor P.C. board (I/F) error. Check compression error of compressor.
F23	F23	—	43	I/F	Ps sensor error	All stop	Output voltage of Ps sensor was zero.	<ul style="list-style-type: none"> Misconnection of Ps sensor and Pd sensor connectors Check connection of Ps sensor connector. Check Ps sensor error. Check compression error of compressor. Check 4-way valve error. Check outdoor P.C. board (I/F) error. Check SV4 circuit error.
F24	F24	—	43	I/F	Pd sensor error	All stop	Output voltage of Pd sensor was zero. (Sensor Open) Pd > 4.15MPa during stop of compressor	<ul style="list-style-type: none"> Check connection of Pd sensor connector. Check Pd sensor error. Check outdoor P.C. board (I/F) error.
F29	—	—	12	Indoor	Indoor other error	Corresponding unit only stops.	Indoor P.C. board did not operate normally.	<ul style="list-style-type: none"> Check indoor P.C. board error (EEPROM error).
F31	F31	—	1C	I/F	Outdoor EEPROM error	All stop (*1)	Outdoor P.C. board (I/F) did not operate normally.	<ul style="list-style-type: none"> Check power voltage. Check power noise. Check outdoor P.C. board (I/F) error.
H01	H01	01: Compressor 1 side 02: Compressor 2 side	1F	IPDU	Compressor breakdown	All stop	Inverter current detection circuit detected over-current and stopped.	<ul style="list-style-type: none"> Check power voltage. (AC220–240V ± 10%). Check compressor error. Check cause of abnormal overload operation. Check outdoor P.C. board (IPDU) error.

(*1) All stop only in case of the header unit. The follower unit continues operation.

Main remote controller	Check code			Detected position	Check code name	Status	Error detection condition	Check item (position)
	Outdoor 7-segment display		AI-NET central control remote controller					
	Check code	Sub-code						
H02	H02	01: Compressor 1 side 02: Compressor 2 side	1d	IPDU	Compressor error (lock) MG-SW error OCR operation	All stop	Over-current was detected several seconds after header compressor had started.	<ul style="list-style-type: none"> • Check compressor error. • Check power voltage. (AC380 –10%, 415V +10%). • Check cable of compressor and phase-missing. • Check connector/terminal connection on IPDU P.C. board. • Check conduction of case heater. (Check activation error due to liquid stagnation in compressor.) • Check outdoor P.C. board (IPDU) error. • Check outdoor MG-SW or OCR.
H03	H03	01: Compressor 1 side 02: Compressor 2 side	17	IPDU	Current detection circuit system error	All stop	While header compressor stopped, current flowed more than the specified current and was detected.	<ul style="list-style-type: none"> • Check wiring of current detection circuit system. • Check outdoor P.C. board (IPDU) error.
H04	H04	—	44	I/F	Compressor 1 case thermo operation	All stop	Compressor 1 case thermostat performed protective operation.	<ul style="list-style-type: none"> • Check compressor 1 case thermo circuit. (Connector, wire, P.C. board) • Check full opening of service valve. (Gas and liquid side) • Check outdoor PMV clogging. (PMV1, 2) • Check SV41 circuit leakage. • Check miscabling/misinstallation of SV41 and SV42. • Check valve open status of indoor PMV. • Check compressor error. • Check 4-way valve error. • Check refrigerant shortage.
H06	H06	—	20	I/F	Low-pressure protective operation	All stop	Low-pressure Ps detected operation lower than 0.02MPa.	<ul style="list-style-type: none"> • Check full opening of service valve. (Gas and liquid side) • Check outdoor PMV clogging. (PMV1, 2) • Check SV41 circuit and SV42 circuit error. • Check low-pressure Ps sensor error. • Check indoor air filter clogging. • Check valve open of indoor PMV. • Check refrigerant pipe clogging. • Check outdoor fan operation. (In heating mode) • Check refrigerant shortage.
H07	H07	—	d7	I/F	Protection for oil level drop detection	All stop	The operating compressor detected oil shortage continuously for 2 hours.	<p><Check all the outdoor units in the corresponding line.></p> <ul style="list-style-type: none"> • Check full opening of service valve of balance pipe. • Check connection and installation of TK1, TK2, TK3, and TK4 sensors. • Check characteristics of TK1, TK2, TK3, and TK4 resistance values. • Check gas leak and oil leak in the same line. • Check refrigerant stagnation in compressor. • Check error of SV3A, SV3B, SV3C, SV3D, and SV3E valves. • Check clogging of oil separator oil return circuit. • Check clogging of oil-equation circuit.

MG-SW : Magnet Switch
OCR : Over-current Relay

Check code				Detected position	Check code name	Status	Error detection condition	Check item (position)
Main remote controller	Outdoor 7-segment display		AI-NET central control remote controller					
	Check code	Sub-code						
H08	H08	01: TK1 sensor error 02: TK2 sensor error 03: TK3 sensor error 04: TK4 sensor error	d4	I/F	Oil level detective temp sensor error	All stop	<ul style="list-style-type: none"> Resistance value of sensor is infinite or zero. (Open/Short) 	<ul style="list-style-type: none"> Check connection of TK1 sensor connector. Check characteristics of TK1 sensor resistance value. Check outdoor P.C. board (I/F) error.
						All stop	<ul style="list-style-type: none"> Resistance value of sensor is infinite or zero. (Open/Short) 	<ul style="list-style-type: none"> Check connection of TK2 sensor connector. Check characteristics of TK2 sensor resistance value. Check outdoor P.C. board (I/F) error.
						All stop	<ul style="list-style-type: none"> Resistance value of sensor is infinite or zero. (Open/Short) 	<ul style="list-style-type: none"> Check connection of TK3 sensor connector. Check characteristics of TK3 sensor resistance value. Check outdoor P.C. board (I/F) error.
						All stop	<ul style="list-style-type: none"> Resistance value of sensor is infinite or zero. (Open/Short) 	<ul style="list-style-type: none"> Check connection of TK4 sensor connector. Check characteristics of TK4 sensor resistance value. Check outdoor P.C. board (I/F) error.
H14	H14	—	44	I/F	Compressor 2 case thermo operation	All stop	Compressor 2 case thermostat operated.	<ul style="list-style-type: none"> Check compressor 2 case thermo circuit. (Connector, wire, P.C. board) Check full opening of service valve. (Gas and liquid side) Check outdoor PMV clogging. (PMV1, 2) Check SV42 valve leak. Check miswiring/misinstallation of SV41 and SV42. Check valve opening of indoor PMV. Check 4-way valve error. Check refrigerant shortage. Check compressor error.
H16	H16	01: TK1 oil circuit system error 02: TK2 oil circuit system error 03: TK3 oil circuit system error 04: TK4 oil circuit system error	d7	I/F	Oil level detective circuit system error MG-SW error OCR operation	All stop	Temperature change of TK1 could not be detected though compressor 1 started the operation.	<ul style="list-style-type: none"> Check TK1 sensor coming-off. Check characteristics of TK1 sensor resistance value. Check TK1, TK2, TK3, and TK4 misconnection. Check operation error of SV3E valve. Check capillary clogging of oil-equation circuit and operation error of stop valve. Check refrigerant stagnation in compressor. Check MG-SW or OCR.
						All stop	Temperature change of TK2 could not be detected though compressor 2 started the operation.	<ul style="list-style-type: none"> Check TK2 sensor coming-off. Check characteristics of TK2 sensor resistance value. Check TK1, TK2, TK3, and TK4 misconnection. Check SV3E valve operation. Check capillary clogging of oil equalization circuit and check stop valve operation. Check refrigerant stagnation in compressor shell. Check MG-SW or OCR.
						All stop	Temperature change of TK3 could not be detected though compressor started the operation.	<ul style="list-style-type: none"> Check TK3 sensor coming-off. Check characteristics of TK3 sensor resistance value. Check TK1, TK2, TK3, and TK4 misconnection. Check SV3E valve operation. Check capillary clogging of oil-equalization circuit and check valve operation. Check refrigerant stagnation in compressor shell. Check MG-SW or OCR.
						All stop	Temperature change of TK4 could not be detected though compressor started the operation, or the difference from other TK sensor changed for a constant time only within the specified range.	<ul style="list-style-type: none"> Check TK4 sensor coming-off. Check characteristics of TK4 sensor resistance value. Check TK1, TK2, TK3, and TK4 misconnection. Check SV3E valve operation. Check capillary clogging of oil-equalization circuit and check valve operation. Check refrigerant stagnation in compressor shell. Check MG-SW or OCR.

MG-SW : Magnet Switch
OCR : Over-current Relay

Main remote controller	Check code		AI-NET central control remote controller	Detected position	Check code name	Status	Error detection condition	Check item (position)
	Outdoor 7-segment display							
	Check code	Sub-code						
L03	—	—	96	Indoor	Duplicated indoor center units	Corresponding unit only stops.	There are multiple center units in a group.	<ul style="list-style-type: none"> • Check indoor address. • Check the change of remote controller connection (Group/individual) after indoor address setup.
L04	L04	—	96	I/F	Duplicated outdoor line address	All stop	Line address setup is duplicated against the outdoor unit in different refrigerant pipe system.	<ul style="list-style-type: none"> • Check line address.
L05	—	—	96	I/F	Duplicated indoor units with priority (Displayed on indoor unit with priority)	All stop	Indoor units with priority were duplicated.	<ul style="list-style-type: none"> • Check display of indoor unit with priority.
L06	L06	No. of indoor units with priority	96	I/F	Duplicated indoor units with priority (Displayed on the unit other than indoor unit with priority)	All stop	Indoor units with priority were duplicated.	<ul style="list-style-type: none"> • Check display of indoor unit with priority and outdoor unit.
L07	—	—	99	Indoor	Group line in individual indoor unit.	Corresponding unit only stops.	At least one indoor unit connected to a group existed in the individual indoor units.	<ul style="list-style-type: none"> • Check indoor address.
L08	L08	—	99	Indoor	Indoor group / address unset	Corresponding unit only stops.	Address was not yet set up.	<ul style="list-style-type: none"> • Check indoor address. <p>[Note] After installation, this code is displayed when the power is firstly turned on.</p>
L09	—	—	46	Indoor	Indoor capacity unset	Corresponding unit only stops.	Indoor unit capacity was unset.	Set up indoor capacity. (DN=11)
L10	L10	—	88	I/F	Outdoor capacity unset	All stop	On the I/F P.C. board for service, jumper line was not cut according to the model.	Check model setup on outdoor I/F P.C. board A'ssy for service.
L20	—	—	98	AI-NET, Indoor	Duplicated central control addresses	All stop	Duplicated central control addresses	<ul style="list-style-type: none"> • Check central control address. • Check network adaptor P.C. board. (In case of AI-NET)
L28	L28	—	46	I/F	Quantity over of connected outdoor units	All stop	There were more than four outdoor units.	<ul style="list-style-type: none"> • Check No. of connected outdoor units. (Max. 4 units per 1 system) • Check communication line between outdoor units. • Check outdoor P.C. board (I/F) error.
L29	L29	01: IPDU1 error 02: IPDU2 error 03: IPDU1, 2 errors 04: Fan IPDU error 05: IPDU1 + Fan IPDU error 06: IPDU2 + Fan IPDU error 07: All IPDU error or communication error between IPDU and I/F P.C. board, or outdoor I/F P.C. board error	CF	I/F	IPDU quantity error	All stop	No. of IPDU units detected when power was turned on were less.	<ul style="list-style-type: none"> • Check model setup for outdoor I/F service P.C. board. • Check connection of UART communication connector. • Check IPDU, fan IPDU, and I/F P.C. board error. <p>[Note] UART: Universal Asynchronous Receiver Transmitter.</p>

Main remote controller	Check code			Detected position	Check code name	Status	Error detection condition	Check item (position)
	Outdoor 7-segment display		AI-NET central control remote controller					
	Check code	Sub-code						
L30	L30	Detected indoor address	b6	Indoor	Interlock in indoor unit from outside	Corresponding unit only stops.	<ul style="list-style-type: none"> • Outside error input terminal Detected signal to (CN80) for more 1 minute 	<ul style="list-style-type: none"> ■ Outside device is connected to connector (CN80): <ol style="list-style-type: none"> 1) Check outside device error. 2) Check indoor P.C. board error. ■ Outside device is not connected to connector (CN80): <ol style="list-style-type: none"> 1) Check indoor P.C. board error.
—	L31	—	—	I/F	Extended IC (Integrated Circuit) error	Operation continues.	P.C. board (I/F) parts error	Check indoor (I/F) P.C. board.
P01	—	—	11	Indoor	Indoor fan motor error	Corresponding unit only stops.		<ul style="list-style-type: none"> • Check the lock of fan motor (AC fan). • Check wiring.
P03	P03	—	1E	I/F	Discharge temp TD1 error	All stop	Discharge temp (TD1) exceeded 115°C.	<ul style="list-style-type: none"> • Check full opening of outdoor service valves (Gas side, Liquid side). • Check clogging of outdoor PMV. (PMV1,2) • Check characteristics of TD1 sensor resistance value. • Check refrigerant shortage. • Check 4-way valve error. • Check leakage of SV41 circuit. • Check SV4 circuit. (Miscabling and misinstallation of SV41 and SV42)
P04	P04	01: Compressor 1 side 02: Compressor 2 side	21	I/F	Actuation of high-pressure SW	All stop	High-pressure SW actuated.	<ul style="list-style-type: none"> • Check Pd pressure sensor error. • Check full opening of outdoor service valves (Gas side, Liquid side). • Check outdoor fan error. • Check outdoor fan motor error. • Check clogging of outdoor PMV. (PMV1,2) • Check clogging of indoor/outdoor heat exchangers. • Check short-circuiting of outdoor suction/discharge air. • Check clogging of SV2 circuit. • Check outdoor P.C. board (I/F) error. • Check indoor fan system error. (Cause of air volume decrease) • Check opening of indoor PMV. • Check miswiring of communication line between indoor and outdoor. • Check operation error of check valve of discharge pipe. • Check SV4 valve circuit. • Check SV5 valve circuit. • Check refrigerant overcharge.
P05	P05	01: Power supply open phase 02: Power supply negative phase	AF	I/F	Open phase negative phase	All stop	<ul style="list-style-type: none"> • Open phase was detected when the power turned on. • Negative phase was detected when the power turned on. 	<ul style="list-style-type: none"> • Check outdoor power line. • Check outdoor P.C. board (I/F) error.

Main remote controller	Check code			Detected position	Check code name	Status	Error detection condition	Check item (position)
	Outdoor 7-segment display		AI-NET central control remote controller					
	Check code	Sub-code						
P07	P07	01: Compressor 1 side 02: Compressor 2 side	1C	IPDU I/F	Heat sink overheat error	All stop	IGBT built-in temp sensor (TH) was overheated.	<ul style="list-style-type: none"> • Check power voltage. • Check outdoor fan system error. • Check clogging of heat sink cooling duct. • Check fixation between IGBT and heat sink. (Check screwing and contact.) • Check IPDU error.(IGBT built-in temp sensor (TH) error)
P12	—	—	11	Indoor	Indoor fan motor error	Corresponding unit only stops.	<ul style="list-style-type: none"> • The value of motor speed deviated from target value was detected for certain time. • Over-current protection operated. 	<ul style="list-style-type: none"> • Check connection of fan connector and wiring. • Check fan motor error. • Check indoor P.C. board error. • Check influence of outside air control. • Check indoor type code (DN=10) and the capacity code (DN=11).
P13	P13	—	47	I/F	Outdoor liquid back detection error	All stop	<p><In cooling> While the system is operating in COOL mode, a high pressure value was detected in follower unit in which compressor did not operate.</p> <p><In heating> While the system is operating in HEAT mode, outdoor PMV of which opening degree was 100p or less for a certain time.</p>	<ul style="list-style-type: none"> • Check full close operation of outdoor PMV (1, 2). • Check Pd and Ps sensor error. • Check clogging of SV2 circuit. • Check clogging of balance pipe. • Check clogging of SV3B circuit. • Check outdoor P.C. board (I/F) error. • Check capillary clogging of oil return circuit from oil separator. • Check leakage of check valve of the main discharge pipe.
P15	P15	01: TS condition	AE	I/F	Gas leak detection (TS1 condition)	All stop	<p>Suction temp exceeded the judgment standard temp for 10 minutes or more.</p> <p><TS error judgment standard temperature> In cooling operation: 60°C or higher In heating operation: 40°C or higher</p>	<ul style="list-style-type: none"> • Check refrigerant shortage. • Check full open of outdoor service valves (gas side, liquid side). • Check outdoor PMV clogging (PMV1, 2). • Check characteristics of TS1 sensor resistance value. • Check 4-way valve error. • Check leakage of SV4 circuit.
		02: TD condition	AE	I/F	Gas leak detection (TD condition)	All stop	<p>Discharge temperature TD1 or TD2 was continuously 108°C or higher for 10 minutes.</p>	<ul style="list-style-type: none"> • Check refrigerant shortage. • Check outdoor PMV clogging (PMV1, 2). • Check characteristics of TD1, TD2 sensor resistance value. • Check indoor air filter clogging. • Check pipe clogging. • Check SV4 circuit (Valve leakage, misinstallation)
P17	P17	—	bb	I/F	Discharge temp TD2 error	All stop	Discharge temperature (TD2) exceeded 115°C.	<ul style="list-style-type: none"> • Check full opening of outdoor service valves (gas side, liquid side). • Check clogging of outdoor PMV (PMV1, 2). • Check characteristics of TD2 sensor resistance value. • Check 4-way valve error. • Check leakage of SV42 circuit. • Check SV4 circuit. (Miscabling and misinstallation of SV41 and SV42)
P19	P19	Detected outdoor unit No.	8	I/F	4-way valve operation error	All stop	When abnormal refrigerating cycle data was detected in heating	<ul style="list-style-type: none"> • Error of 4-way valve error • Check coil error and connector connection of 4-way valve. • Check characteristics of TS1/TE1 sensor resistance value. • Check characteristics of Pd, Ps pressure sensor output voltage. • Check misconnection of TE1 and TL sensors.

Main remote controller	Check code			Detected position	Check code name	Status	Error detection condition	Check item (position)
	Outdoor 7-segment display		AI-NET central control remote controller					
	Check code	Sub-code						
P20	P20	—	22	I/F	High-pressure protective operation	All stop	Pd sensor detected 3.6MPa or more.	<ul style="list-style-type: none"> • Check Pd pressure sensor error. • Check full opening of service valves (Gas side, Liquid side). • Check outdoor fan error. • Check outdoor fan motor error. • Check clogging of outdoor PMV. (PMV1,2) • Check clogging of indoor/outdoor heat exchangers. • Check air short-circuiting in outdoor unit. • Check clogging of SV2 circuit. • Check outdoor P.C. board (I/F) error. • Check indoor fan system error. (Cause of air volume decrease) • Check valve opening of indoor PMV. • Check miswiring of communication line between indoor and outdoor. • Check operation error of check valve of discharge pipe. • Check circuit of gas balance SV4 valve. • Check circuit of SV5 valve. • Check refrigerant overcharge.
P22	P22	0: IGBT shortage 1: Position detection circuit error 3: Motor lock error 4: Motor current error detection C: TH sensor temp. error D: TH sensor error E: Vdc error	1A	FAN-IPDU	Outdoor fan IPDU error	All stop	(Sub-code: 0) <ul style="list-style-type: none"> • Short-circuit current was detected at start time. • Short-circuit current was detected when checking IGBT short-circuit before start time. 	<ul style="list-style-type: none"> • Check fan motor. (Interphase short-circuit) • Check fan IPDU error.
						All stop	(Sub-code: 1) <ul style="list-style-type: none"> • The standard value of detection circuit of fan IPDU current fluctuated at start time. 	<ul style="list-style-type: none"> • Check fan IPDU error.
						All stop	(Sub-code: 3) <ul style="list-style-type: none"> • Abnormal current was detected within 30 seconds after start time. 	<ul style="list-style-type: none"> • Check fan motor. (Lock, phase missing) • Check cause of abnormal overload at start time. • Check connection of connector to fan motor.
						All stop	(Sub-code: 4) <ul style="list-style-type: none"> • Short-circuit current was detected when 2 seconds or more passed after start time. • Over-current was detected when 30 seconds or more passed after start time. 	<ul style="list-style-type: none"> • Check power supply voltage. • Check fan IPDU error.
						All stop	(Sub-code: C) <ul style="list-style-type: none"> • Heat sink sensor (TH) of fan IPDU detected 95°C error. 	<ul style="list-style-type: none"> • Check outdoor fan system. • Check fan IPDU error. • Check fixation between fan IPDU and heat sink.
						All stop	(Sub-code: D) <ul style="list-style-type: none"> • Heat sink sensor (TH) of fan IPDU detected short-circuiting or open. 	<ul style="list-style-type: none"> • Check fan IPDU error.
						All stop	(Sub-code: E) <ul style="list-style-type: none"> • Input power supply voltage of the fan IPDU over the setup value was detected. • Input power supply terminal of the fan IPDU was unconnected. • Power supply P.C. board error of the fan IPDU 	<ul style="list-style-type: none"> • Check input power supply voltage of the fan IPDU. • Check power supply P.C. board error of the fan IPDU. • Check error of external electrolytic condenser.

Check code				Detected position	Check code name	Status	Error detection condition	Check item (position)
Main remote controller	Outdoor 7-segment display		AI-NET central control remote controller					
	Check code	Sub-code						
P26	P26	01: Compressor 1 side 02: Compressor 2 side	14	IPDU	G-Tr short-circuit protection error	All stop	Instantaneous over-current was detected when compressor started.	<ul style="list-style-type: none"> • Check connector connection and wiring on IPDU P.C. board. • Check compressor error and defect of compressor coil. • Check outdoor P.C. board (IPDU) error.
P29	P29	01: Compressor 1 side 02: Compressor 2 side	16	IPDU	Compressor position detection circuit error	All stop	Position was not normally detected.	<ul style="list-style-type: none"> • Check connector connection and wiring. • Check compressor error and defect of compressor coil. • Check P.C. board (IPDU) error.
P31	—	—	47	Indoor	Other indoor error (Group follower unit error)	Corresponding unit only stops.	E07/L07/L03/L08 was detected when other indoor unit in the group was defective.	<ul style="list-style-type: none"> • Check indoor P.C. board.

Error detected by TCC-LINK central control device

Check code				Detected position	Check code name	Status	Error detection condition	Check item (position)
Display on central control device	Outdoor 7-segment display		AI-NET central control remote controller					
	Check code	Sub-code						
C05	—		—	TCC-LINK	TCC-LINK central control device transmission error	Operation continued.	Signal is not transmit from central control device.	<ul style="list-style-type: none"> • Check central control device error. • Check communication line error of central control device. • Check setup of end terminal resistance.
C06	—		—		TCC-LINK central control device receiving error	Operation continued.	Signal is not received from central control device.	<ul style="list-style-type: none"> • Check central control device error. • Check communication line error of central control device. • Check setup of end terminal resistance. • Check the power of connecting destination connected device. • Check P.C. board error of the connected device.
C12	—		—	General-purpose device I/F	Interface batch alarm of general-purpose control devices	Operation continued.	Error was input in general-purpose control device control interface.	<ul style="list-style-type: none"> • Check error input.
P30	Differs according to error contents of the with alarm			TCC-LINK	Follower unit error of group control	Operation continued.	An error occurred in follower unit of the group control. ([P30] is displayed only on the central control remote controller.)	<ul style="list-style-type: none"> • Check the check code of the unit with alarm.
	(L20 is displayed.)				Duplicated central control address	Operation continued.	Central control addresses were duplicated.	<ul style="list-style-type: none"> • Check the address setup.

92

Error detected by AI-NET central control device

Check code				Detected position	Check code name	Status	Error detection condition	Check item (position)
Main remote controller	Outdoor 7-segment display		AI-NET central control remote controller					
	Check code	Sub-code						
—	—	—	97	AI-NET	AI-NET communication system error	Operation continued.	E07/L07/L03/L08 was detected when other indoor unit in the group was defective.	<ul style="list-style-type: none"> • Check multiple network adaptors. • Check wire and miswiring of remote controller: Only one network adaptor can be connected to communication line of remote controller.
—	—	—	99	AI-NET	Duplicated network adaptors	Operation continued.	Multiple network adaptors were connected to communication line of remote controller. (Detected at central controller side)	<ul style="list-style-type: none"> • Check communication line, miswiring, and power of indoor unit. • Check communication. (X, Y terminals) • Check network adaptor P.C. board. • Check the central controller (Central control remote controller, etc.)
—	—	—	b7	AI-NET	Error in indoor group	Operation continued.	Error of follower unit in the group	<ul style="list-style-type: none"> • Check follower unit in the group.

* These errors are concerned to communication of remote controllers (A, B) and central system [AI-NET X, Y], and the main remote controller displays [E01], [E02], [E03], [E09], or [E18] in some cases and displays none in other cases according to the contents.

7-4-1. Cautions When Servicing for Compressor

1. Removing wires of both compressors check output of the inverter as described below.

7-4-2. How to Check Inverter Output

1. Turn off the power supply.
2. Remove the compressor lead cables from the compressors.
(Be sure to remove lead cables of both compressors.)
3. Turn on the power supply and start cooling or heating operation.
In this time, pay attention to touch the fasten receptacle terminal lug of the compressor leads so that they do not contact with other fasten receptacle terminal lug or other position (unit cabinet, etc.).
4. Check output voltage of compressor lead cable at inverter side.

When the output voltage does not satisfy the criteria in the following table, replace IPDU P.C. board.

No.	Measured position	Criteria
1	Between Red and White	400 V to 650 V
2	Between White and Black	400 V to 650 V
3	Between Black and Red	400 V to 650 V

* After checking the output, when connecting the compressor lead again to the compressor terminal, check surely there is no distortion on the fasten terminal lug. If it is loosened, caulk it with pinchers, etc and then connect lead to the terminal.

7-4-3. How to Check Resistance of Compressor Winding

1. Turn off the power supply.
2. Remove the compressor lead cables from the compressors.
In each compressor, check the winding resistance between phases and resistance of the outdoor cabinet using a tester.
 - Is not it earthed?
→ Normal if 10MΩ or more are measured
 - Is not shorted between windings?
→ Normal if 0.7Ω to 0.9Ω are measured (Use a precise digital tester.)

7-4-4. How to Check the External Fan Motor

1. Turn off the power supply.
2. Take off three connectors (U.V.W) from the external fan IPDU P.C. board.
3. Turn the fan with hands. If the fan does not turn, it is a fan motor error (Lock). Replace the fan motor.
If the fan turns, measure the winding resistance between the phases of the connector (Motor winding) with a tester. If 13 to 33Ω are measured, it is normal. (Use a digital tester.)

7-5. Diagnosis Procedure for Each Check Code

Check code	Check code name	Cause of operation
[E01] / [-] (Current code / AI-NET)	Communication error between indoor and remote controller (Detected at remote controller side)	<ol style="list-style-type: none"> 1. Remote controller inter-unit cable error 2. Indoor power error 3. Indoor P.C. board error 4. Remote controller address setup error 5. Remote controller P.C. board error

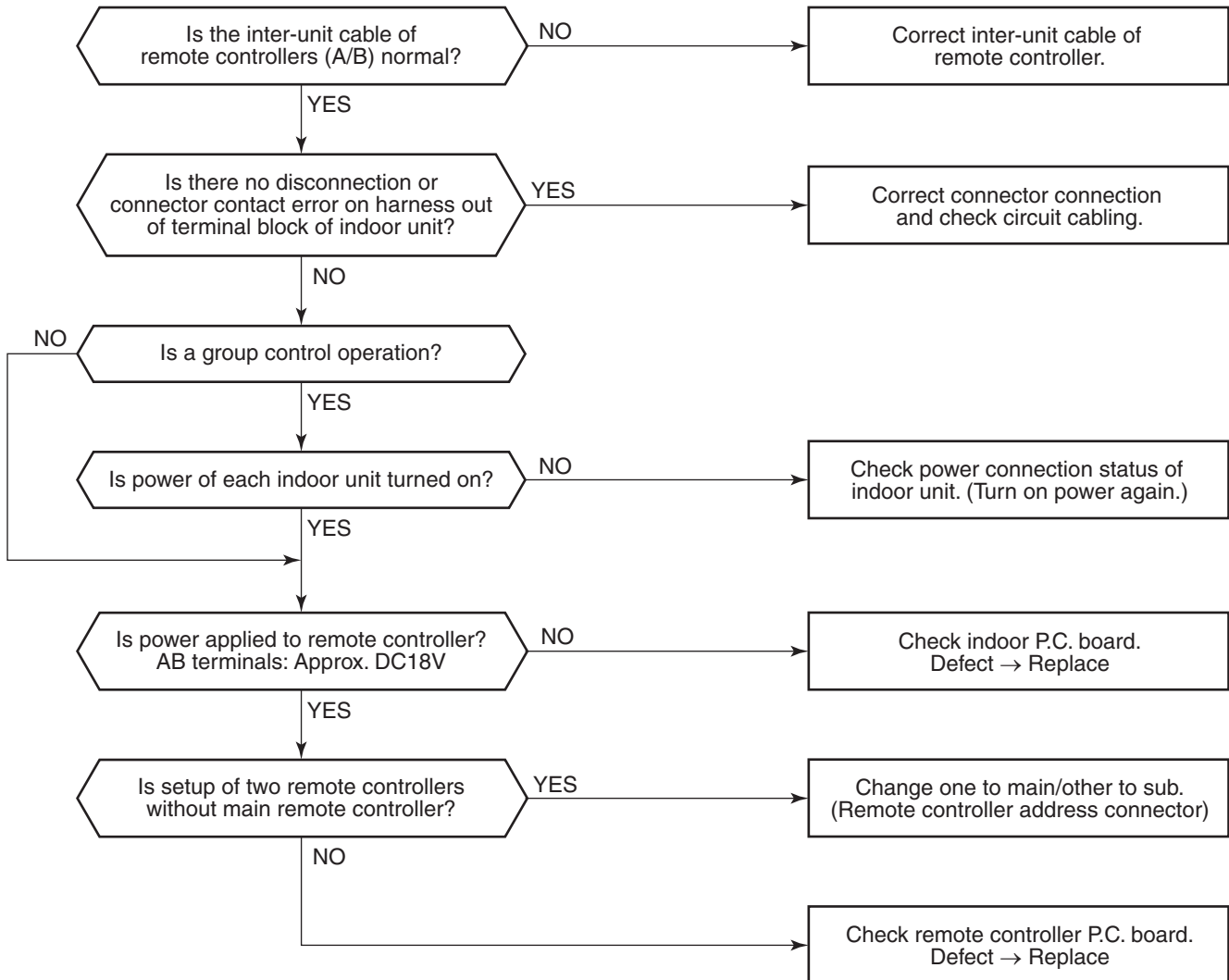

Check code	Check code name	Cause of operation
[E02] / [-] (Current code / AI-NET)	Remote controller sending error	Signal could not be sent to indoor unit. Check the communication wire of the remote controller.

* It is not displayed on 7-segment display of the central control controller.

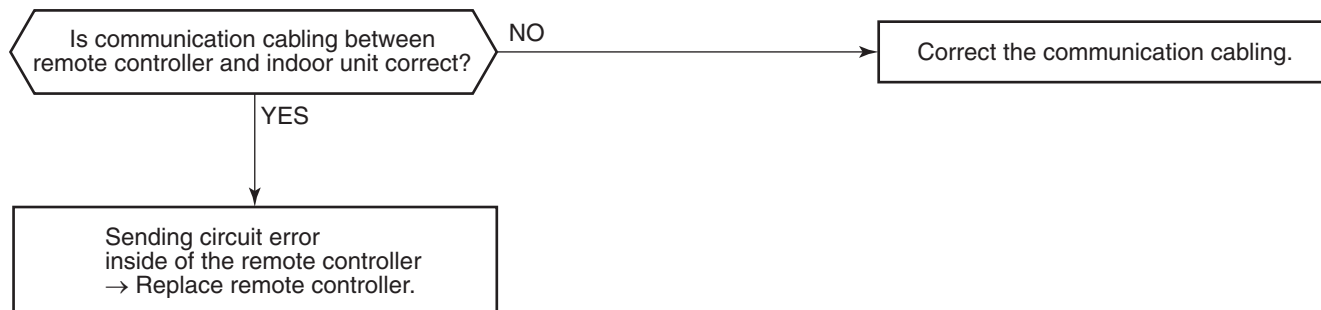

Check code	Check code name	Cause of operation
[E03] / [97] (Current code / AI-NET)	Communication error between indoor and remote controller (Detected at indoor side)	No communication from remote controller and communication adaptor

This error is detected when the indoor unit cannot receive a signal from the remote controller.
 Check communication cables of the remote controllers A and B.
 As communication is impossible, this check code [E03] is not displayed on the main remote controller.
 It is displayed on TCC-LINK central controller.

Check code	Check code name	Cause of operation
[E04] / [04] (Current code / AI-NET)	Indoor/Outdoor communication circuit error (Detected at indoor side)	<ol style="list-style-type: none"> 1. Power of outdoor unit was firstly turned on. 2. Connection error of communication line between indoor and outdoor 3. End terminal resistance setup error on communication between indoor and outdoor 4. Address setup error 5. Switch setup error of wall type P.C. board

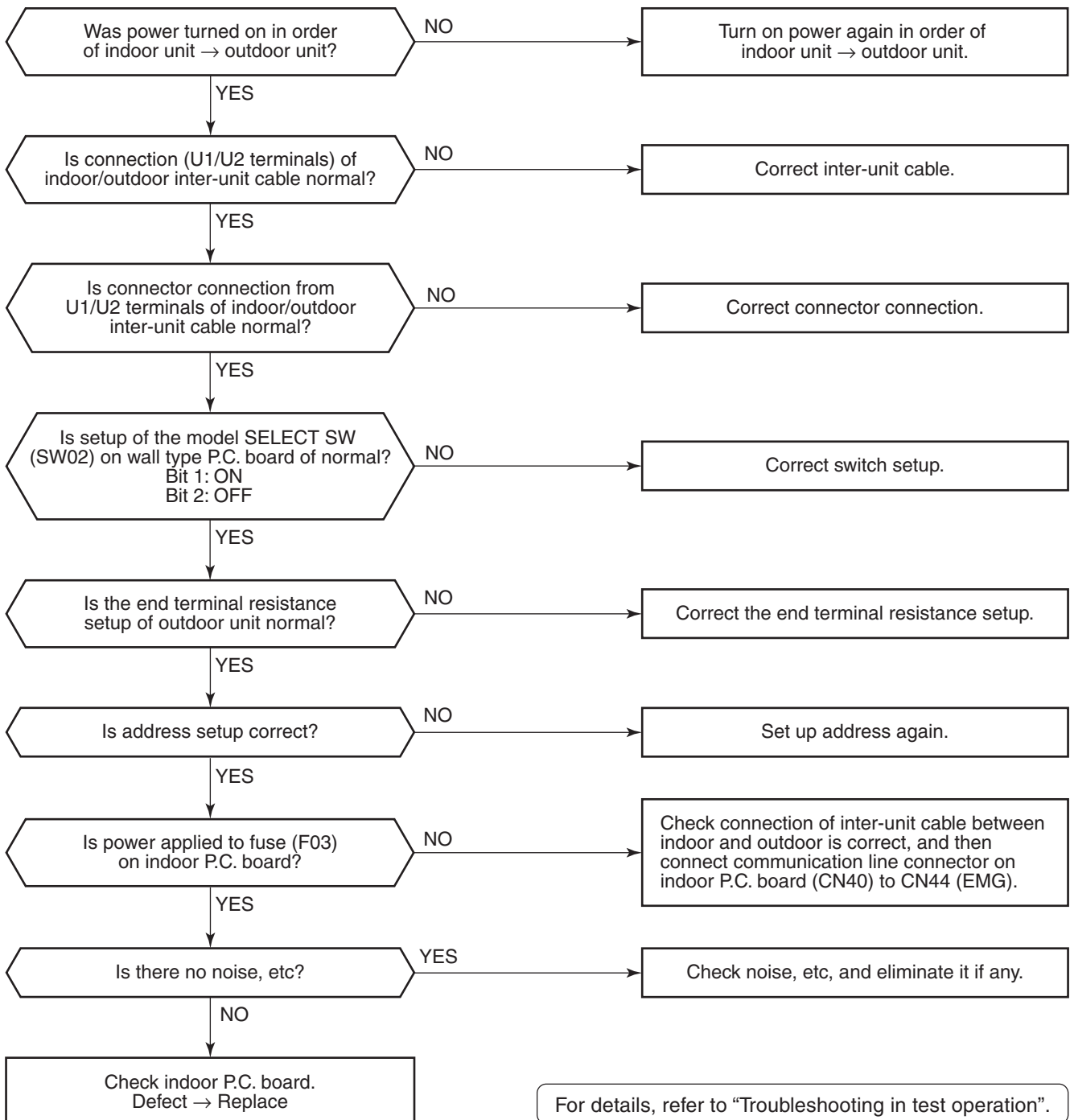

Check code	Check code name	Cause of operation
[E06] / [04] (Current code7 / AI-NET)	Decreased number of indoor units	<ol style="list-style-type: none"> 1. Communication lines (U1, U2) connection error between indoor and outdoor 2. Connector connection error of communication for indoor P.C. board 3. Connector connection error of communication for outdoor I/F board 4. Power supply of indoor unit (Is power turned on?)

Sub-code: No. of indoor units which received signals normally

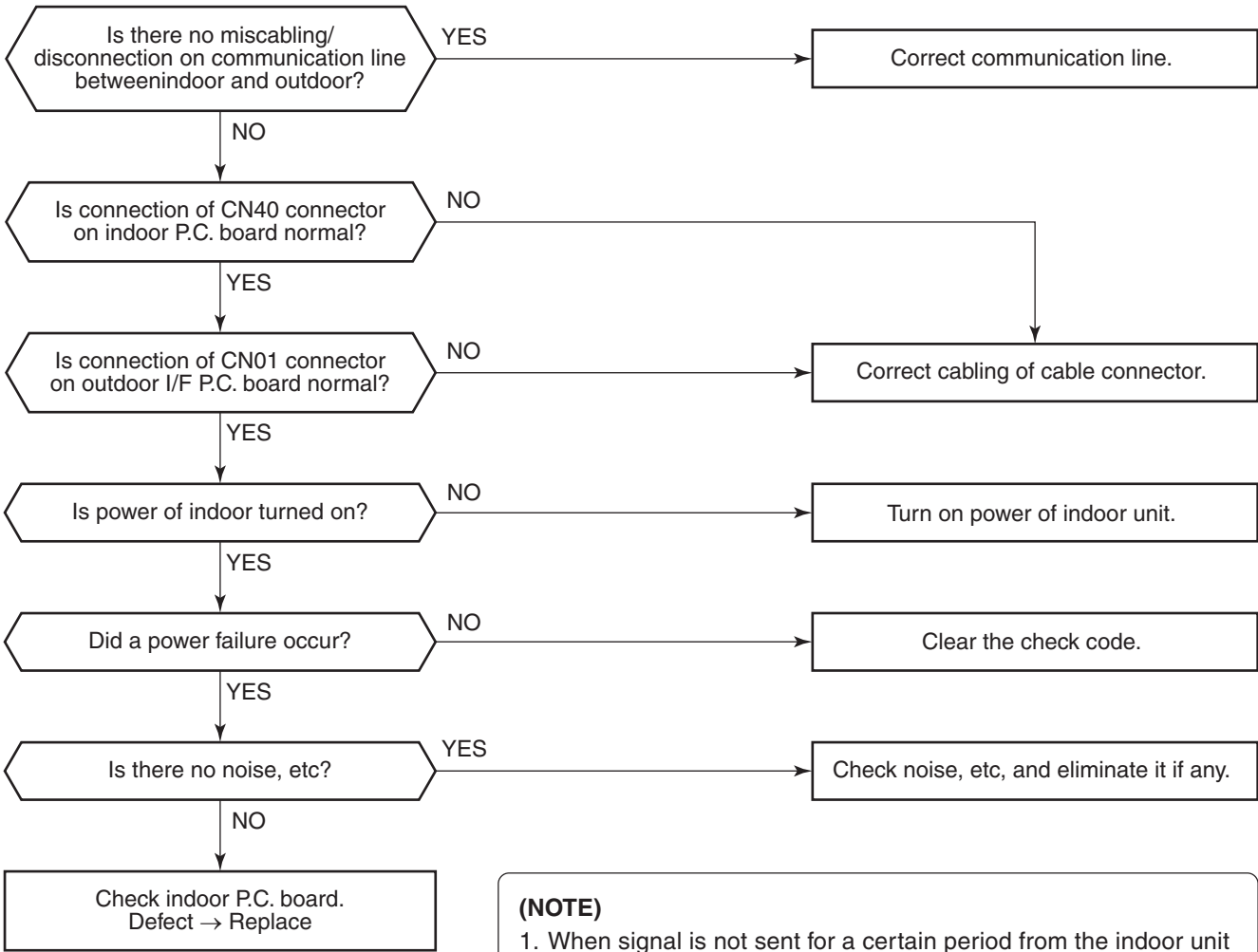

(NOTE)
1. When signal is not sent for a certain period from the indoor unit which has used to send signals normally, [E06] is displayed.

Check code	Check code name	Cause of operation
[E07] / [-] (Current code / AI-NET)	Indoor/Outdoor communication circuit error (Detected at outdoor side)	1. Indoor/outdoor communication end terminal resistance setup error 2. Indoor/outdoor communication connection error

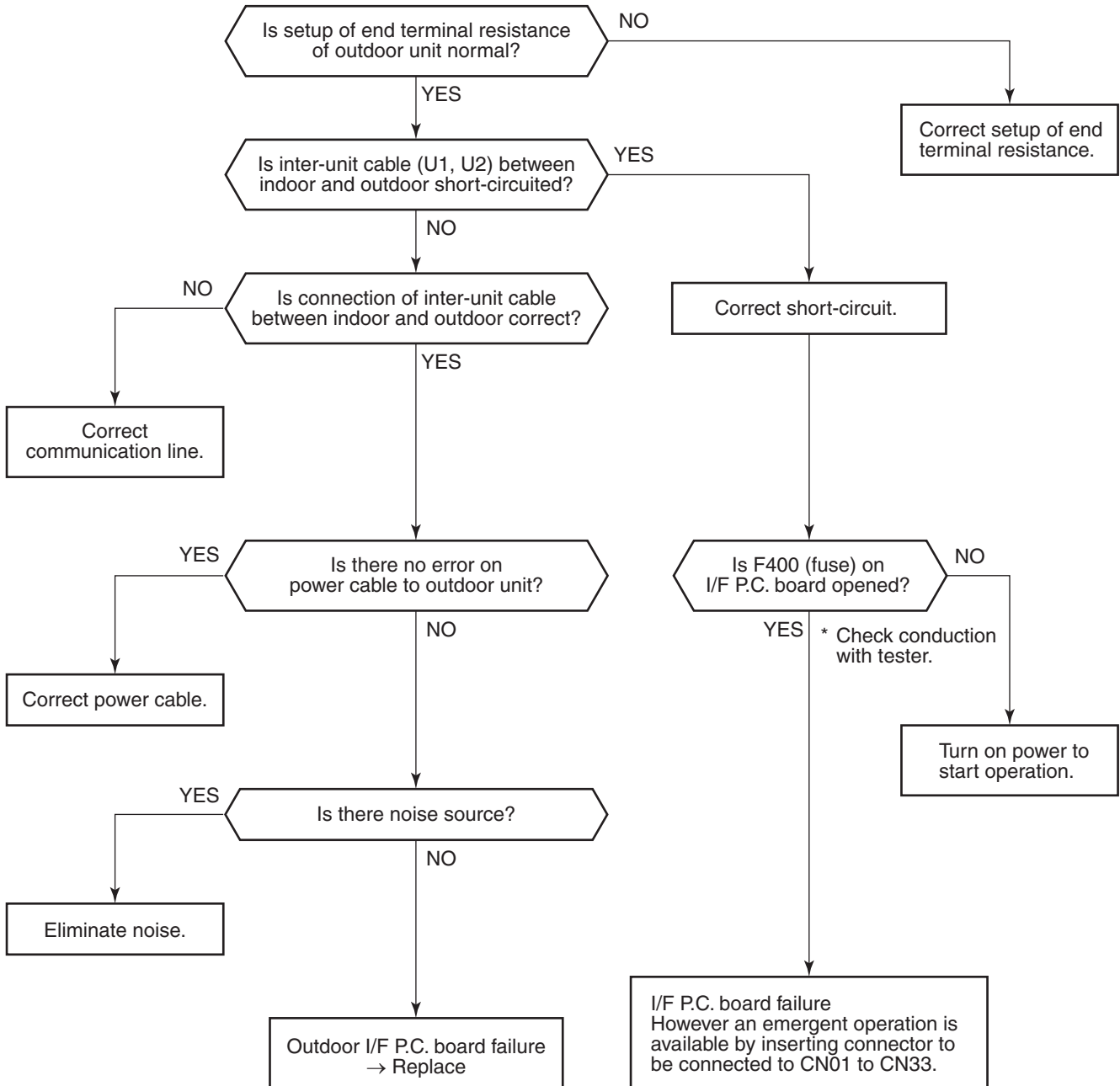

Check code	Check code name	Cause of operation
[E08] / [96] (Current code / AI-NET)	Duplicated indoor addresses	1. Indoor addresses are duplicated. 2. Switch setup error of wall type P.C. board

Sub-code: Duplicated indoor address

Using a main remote controller (RBC-AMT32E), check the setup item codes (DN code) 12, 13, and 14. When there is no address duplication, check to the following flowchart.

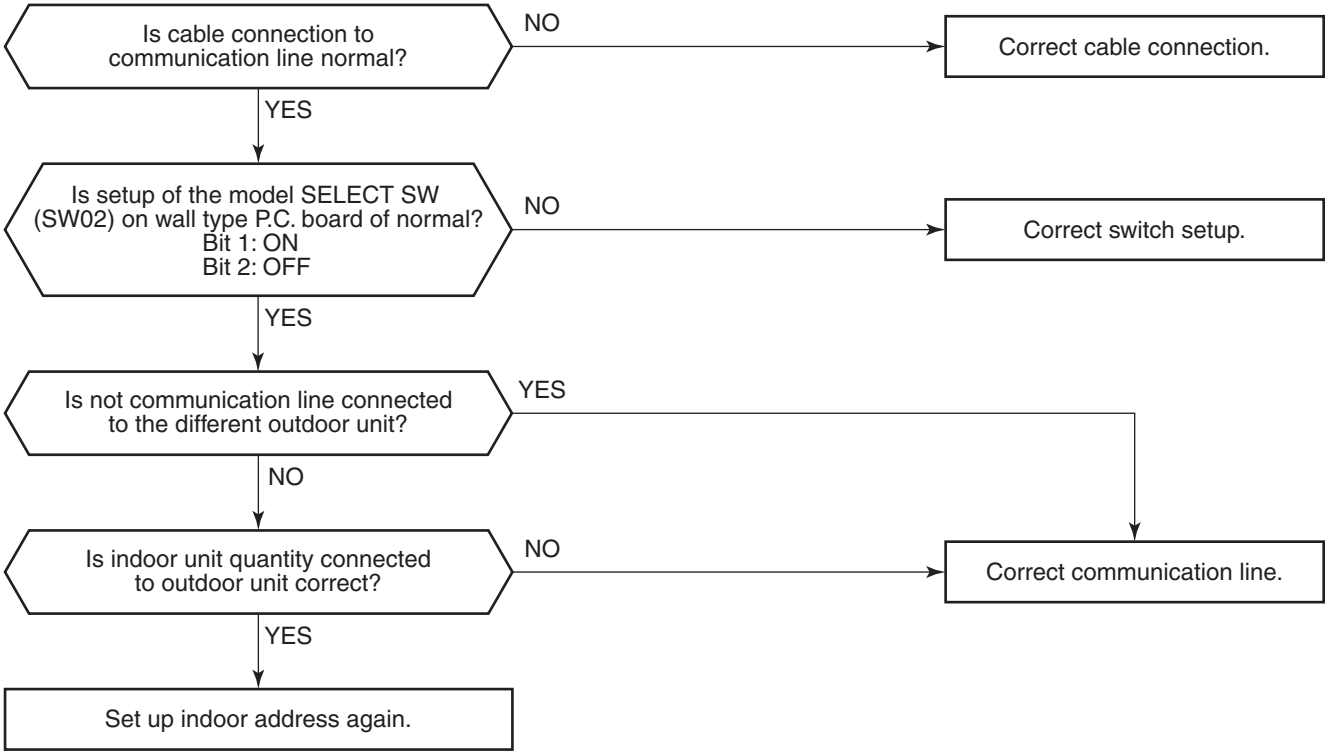

Check code	Check code name	Cause of operation
[E09] / [99] (Current code / AI-NET)	Duplicated master remote controller	Setup of master remote controller is duplicated.

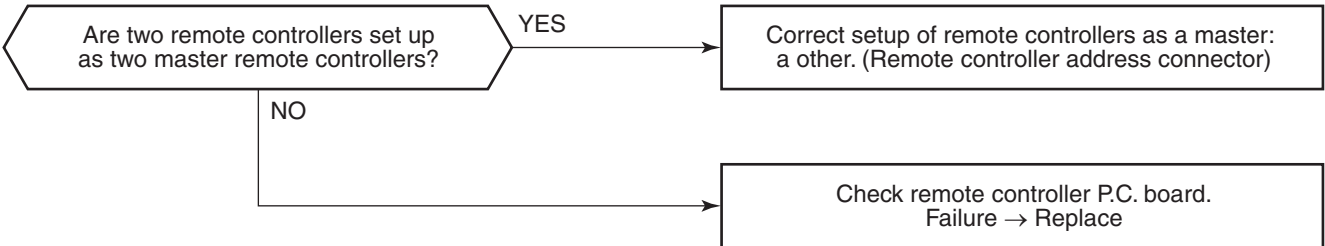

Check code	Check code name	Cause of operation
[E12] / [42] (Current code / AI-NET)	Automatic address start error	1. When indoor automatic address started, other refrigerant circuit system was setting automatic address. 2. When outdoor automatic address started, the indoor automatic address was being set. (Sub-code: 02)

Sub-code: 01: Communication between indoor and outdoor 02: Communication between outdoor units

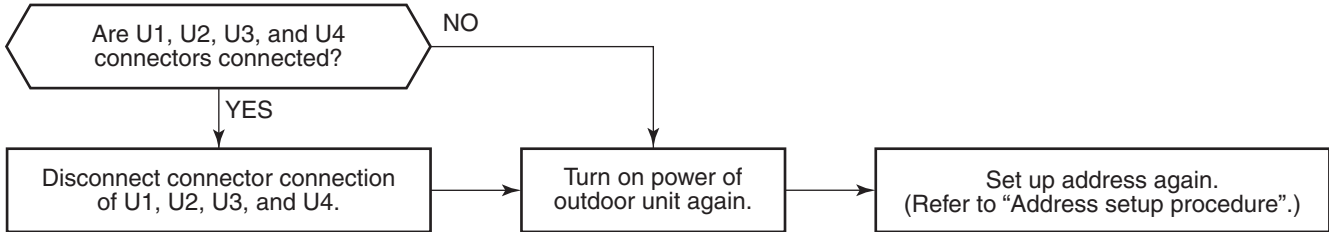

Check code	Check code name	Cause of operation
[E15] / [42] (Current code / AI-NET)	No corresponding indoor unit during automatic address	1. Communication line connection error between indoor and outdoor. 2. Indoor power system error 3. Noise from surrounding devices 4. Power failure 5. Indoor P.C. board error

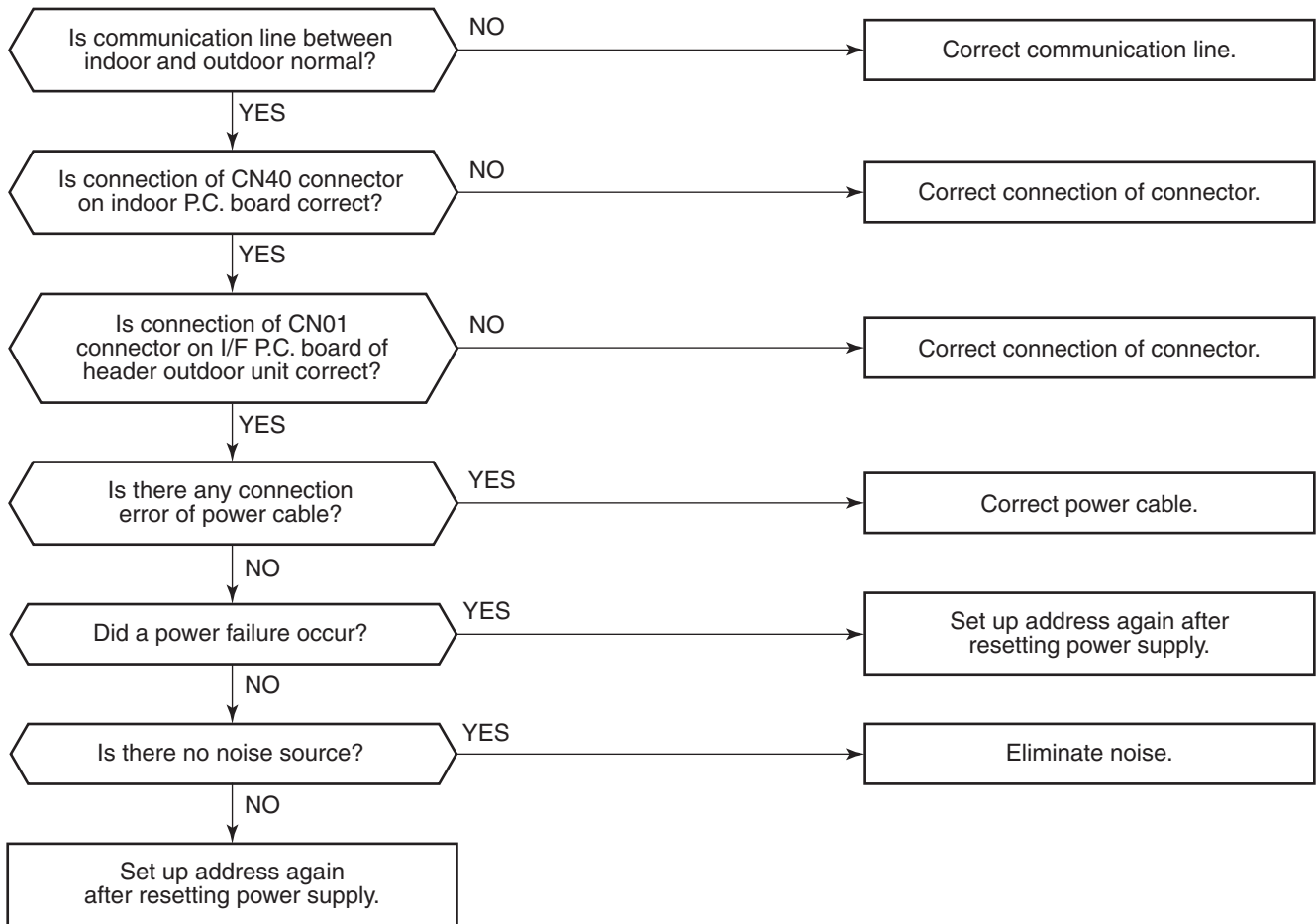

Check code	Check code name	Cause of operation
[E16] / [89] (Current code / AI-NET)	Connected indoor units capacity over	1. There are 48 or more connected indoor units. 2. Capacity over of total connected indoor units. 3. Incorrect setup of indoor/outdoor capacity

Sub-code: 00 : Capacity over 49 to 64 of connected units

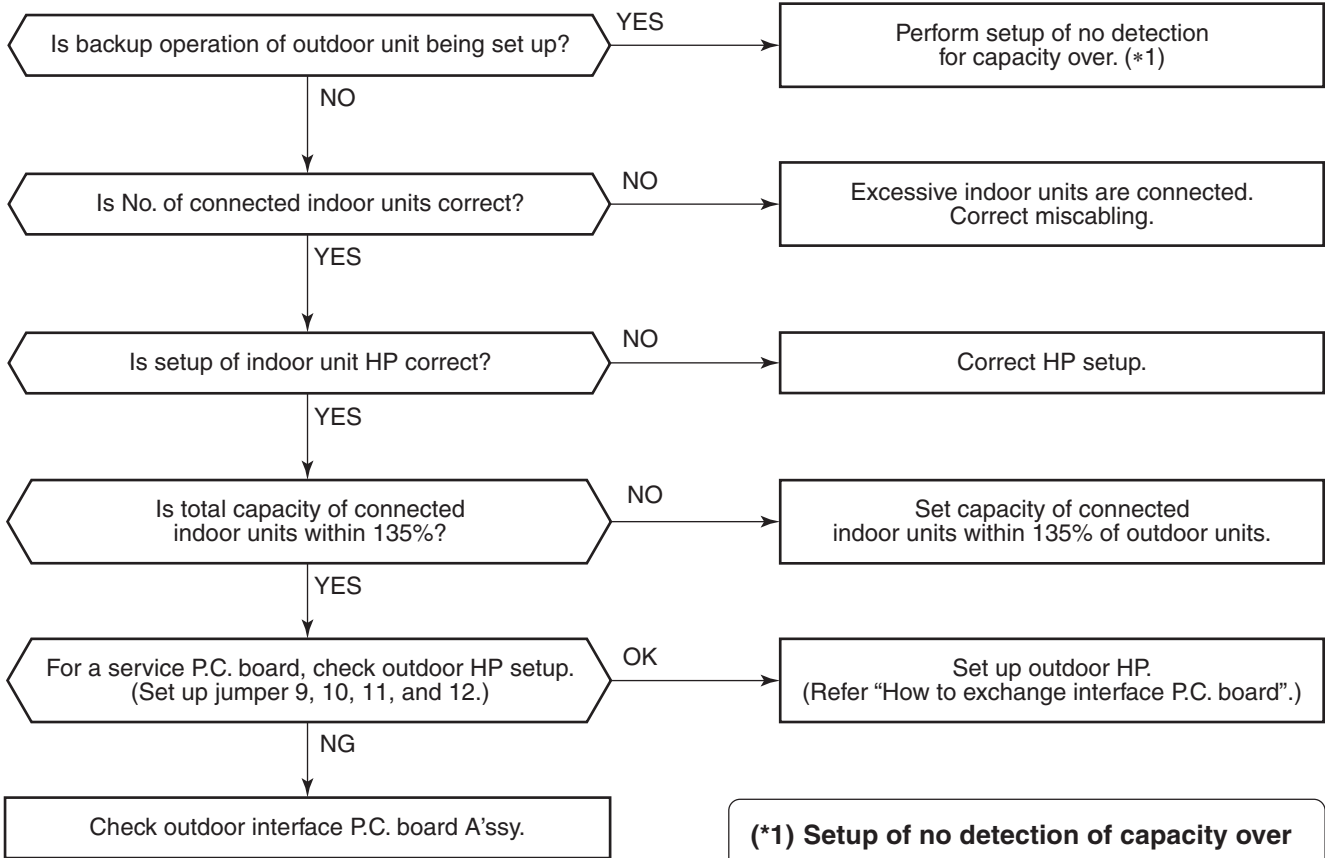

(*1) Setup of no detection of capacity over
 Turn SW09 Bit 2 on I/F P.C. board of header outdoor unit to ON. (Usually OFF)

Check code	Check code name	Cause of operation
[E18] / [97/99] (Current code / AI-NET)	Communication error between indoor header and follower	1. Regular communication between indoor header and follower is unavailable. 2. Switch setup error of wall type P.C. board

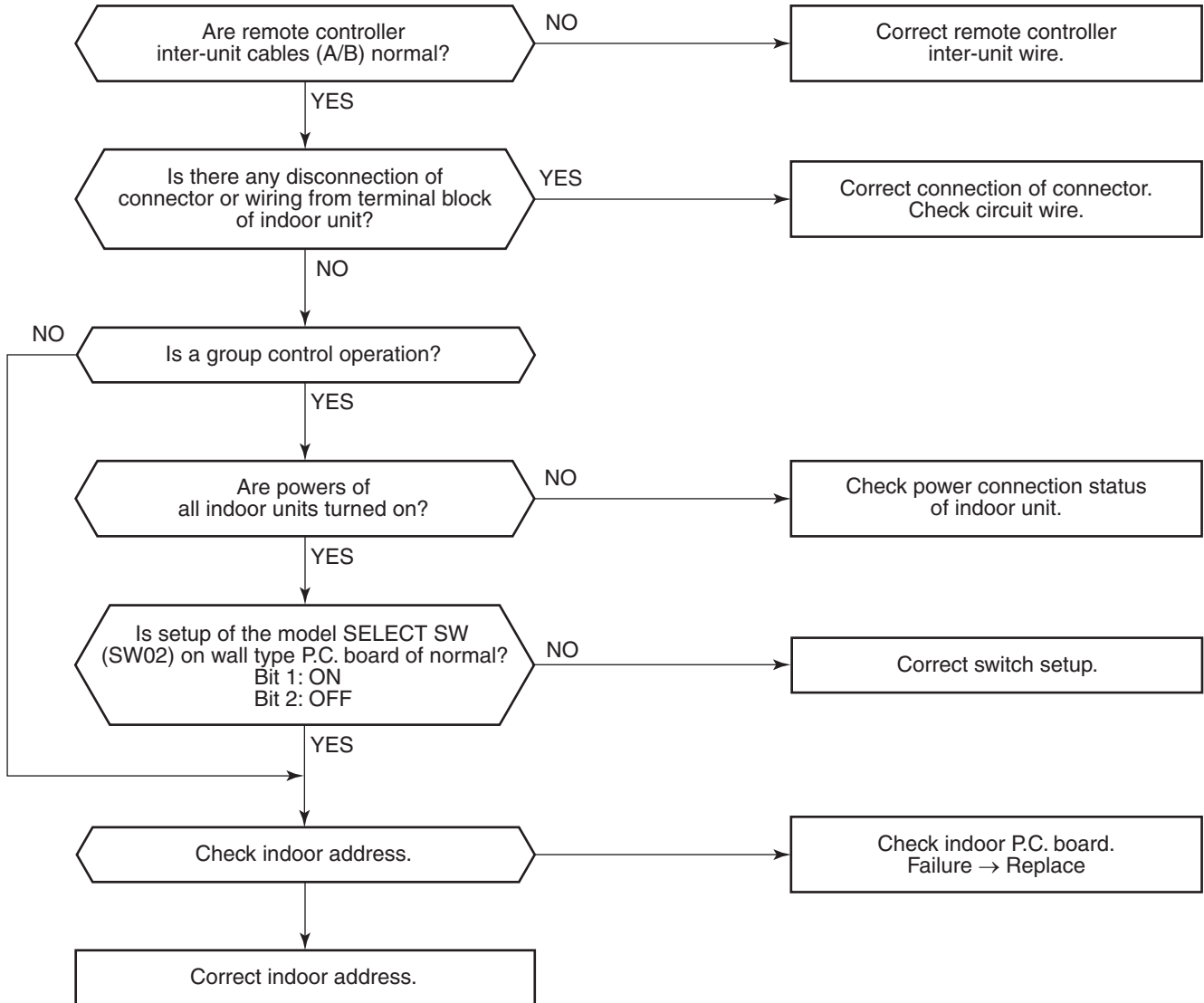

Check code	Check code name	Cause of operation
[E19] / [96] (Current code / AI-NET)	Header outdoor units quantity error	1. Misconnection of inter-unit cable between indoor and outdoor 2. Outdoor I/F P.C. board error

Sub-code: 00: No header unit 02: Two or more header units

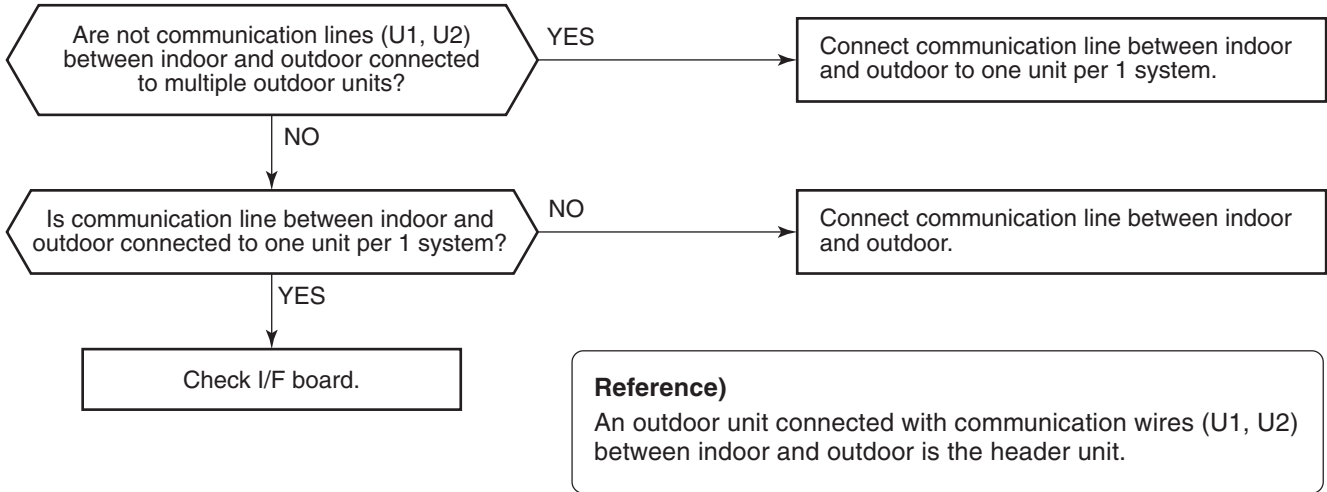

Check code	Check code name	Cause of operation
[E20] / [42] (Current code / AI-NET)	Unit connected to other line during automatic address	When starting automatic indoor address, a device in other line is connected.

Sub-code: 01: Connection of outdoor in other line 02: Connection of indoor unit in other line

Separate the wire between lines according to address setup method.

Check code	Check code name	Cause of operation
[E23] / [15] (Current code / AI-NET)	Communication sending error between outdoor units	1. Inter-unit cable connection error between outdoor units 2. Communication connector connection error between outdoor units, I/F P.C. board error 3. End terminal resistance setup error between outdoor units

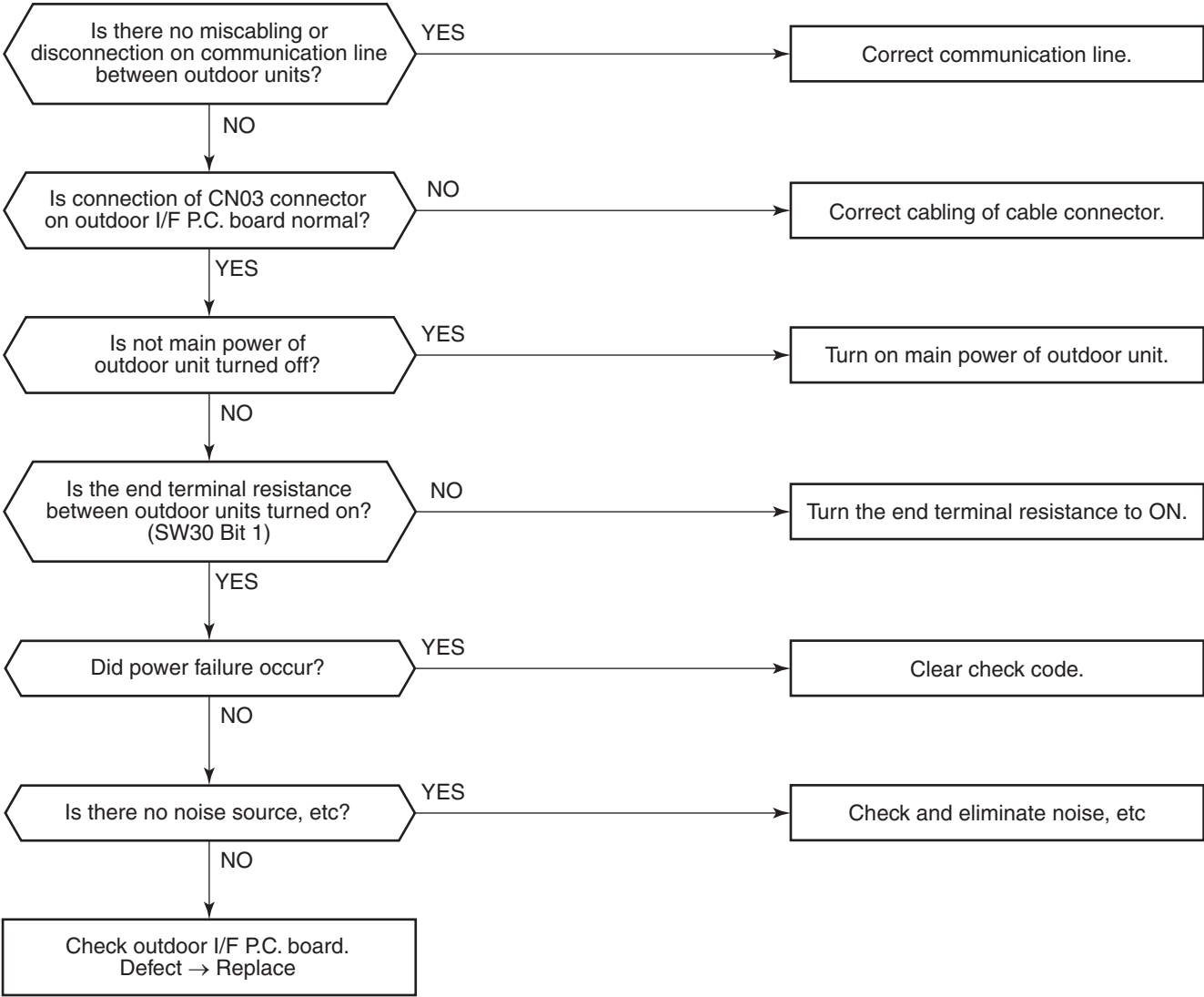

Check code	Check code name	Cause of operation
[E25] / [15] (Current code / AI-NET)	Duplicated follower outdoor address setup	Addresses are duplicated by manual setup of outdoor address

Do not set up outdoor address manually.

Check code	Check code name	Cause of operation
[E26] / [15] (Current code / AI-NET)	Decrease of connected outdoor units	1. Outdoor unit backup setup 2. Outdoor power error 3. Communication line connection error between outdoor units 4. Connector connection error for communication 5. Outdoor I/F P.C. board error

Sub-code: No. of outdoor units which received signals normally

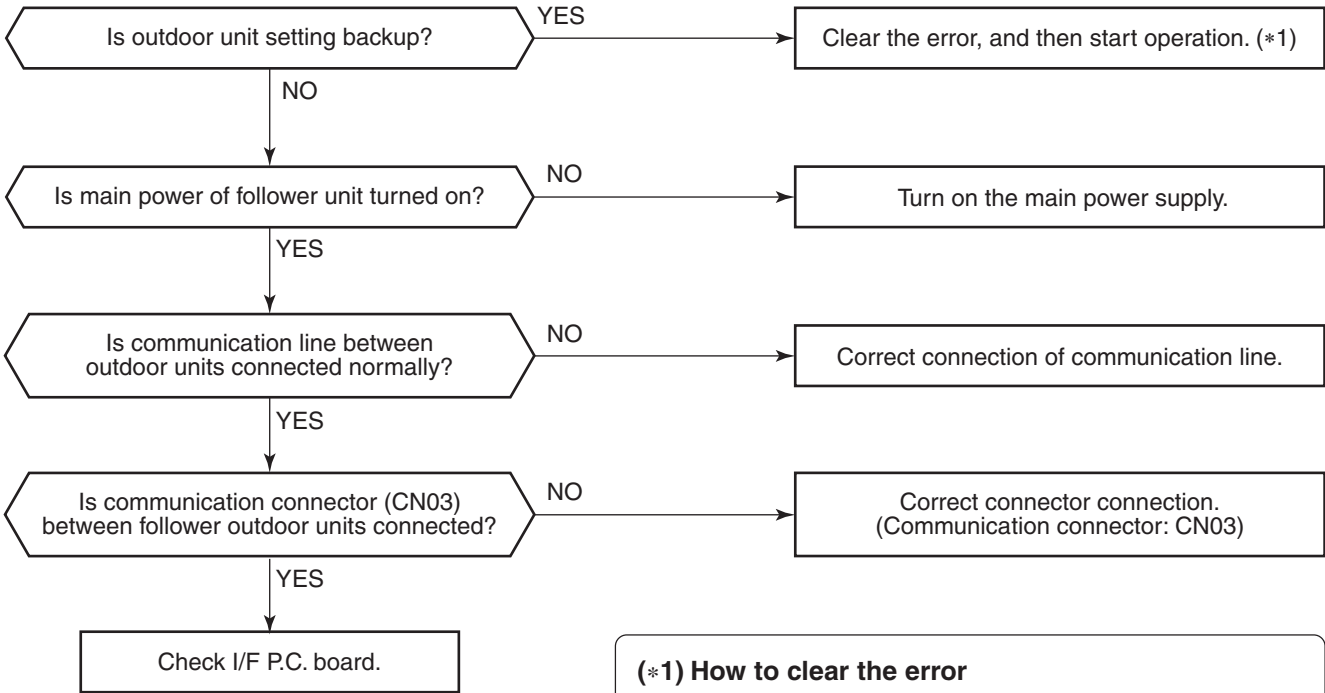

(*1) How to clear the error
 Set SW01/SW02/SW03 on I/F P.C. board of header unit to 2/16/1, and push SW04 for 5 seconds or more. (7-segment display: [Er.] [CL])

Check code	Check code name	Cause of operation
[F01] / [0F] (Current code / AI-NET)	Indoor TCJ sensor error	TCJ sensor Open/Short

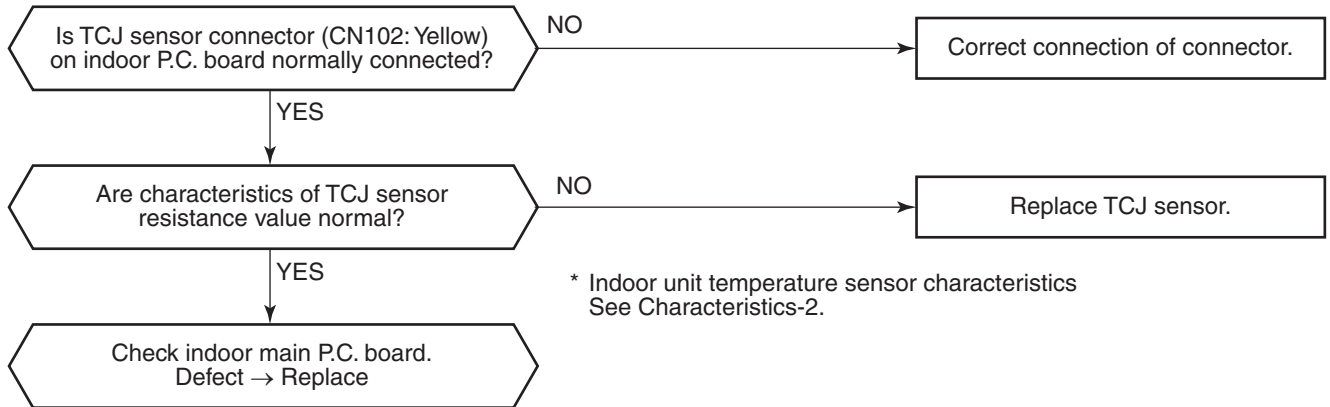

Check code	Check code name	Cause of operation
[F02] / [0d] (Current code / AI-NET)	Indoor TC2 sensor error	TC2 sensor Open/Short

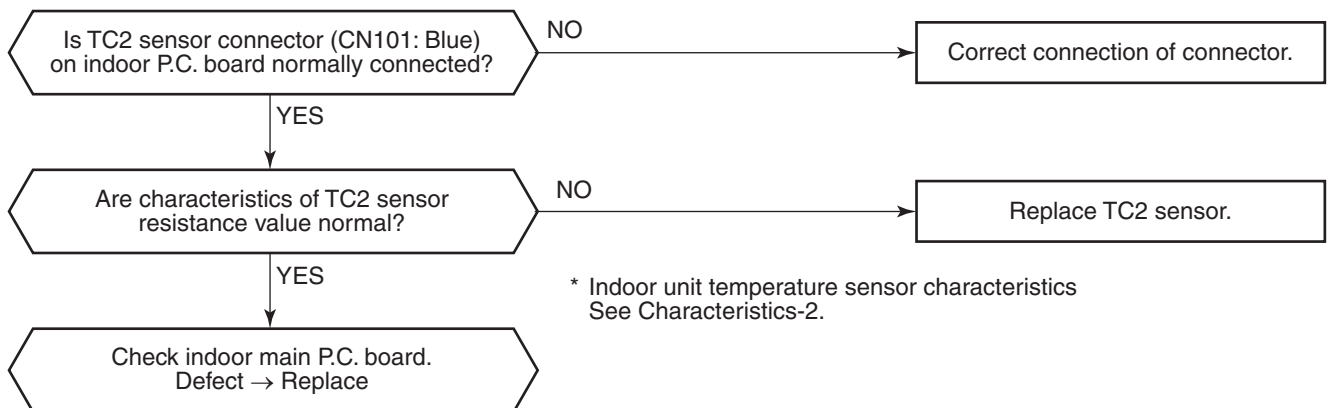

Check code	Check code name	Cause of operation
[F03] / [93] (Current code / AI-NET)	Indoor TC1 sensor error	TC1 sensor Open/Short

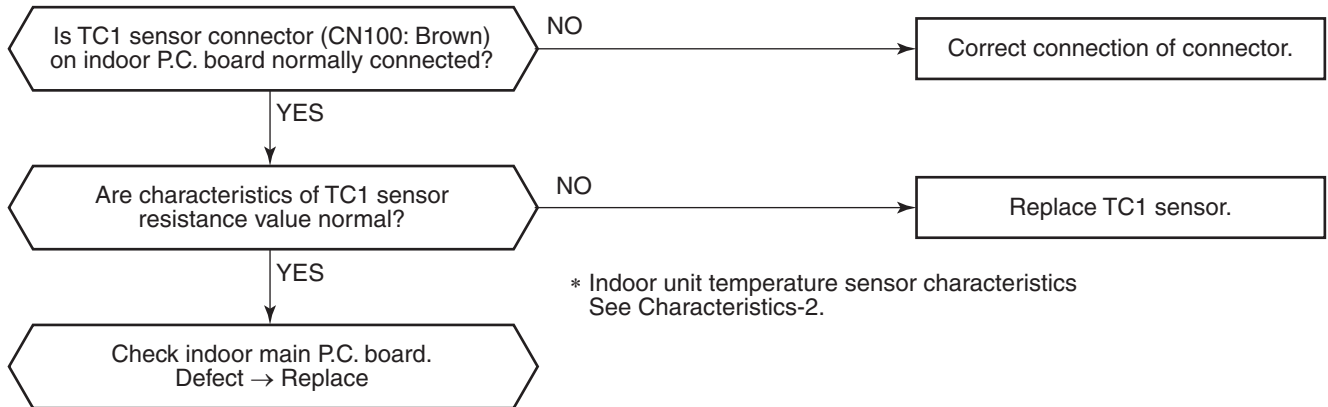

Check code	Check code name	Cause of operation
[F04] / [19] (Current code / AI-NET)	TD1 sensor error	TD1 sensor Open/Short

This error code means detection of Open/Short of TD1 sensor.
Check disconnection of circuit for connection of connector (TD1 sensor: CN502, White) and characteristics of sensor resistance value. (Refer to Outdoor unit temperature sensor characteristics.)
If sensor is normal, replace outdoor I/F P.C. board.

Check code	Check code name	Cause of operation
[F05] / [A1] (Current code / AI-NET)	TD2 sensor error	TD2 sensor Open/Short

This error code means detection of Open/Short of TD2 sensor.
Check disconnection of circuit for connection of connector (TD2 sensor: CN503, Pink) and characteristics of sensor resistance value. (Refer to Outdoor unit temperature sensor characteristics.)
If sensor is normal, replace outdoor I/F P.C. board.

Check code	Check code name	Cause of operation
[F06] / [18] (Current code / AI-NET)	TE1 sensor error	TE1 sensor Open/Short

This error code means detection of Open/Short of TE1 sensor.
Check disconnection of circuit for connection of connector (TE1 sensor: CN505, Green) and characteristics of sensor resistance value. (Refer to Outdoor unit temperature sensor characteristics.)
If sensor is normal, replace outdoor I/F P.C. board.

Check code	Check code name	Cause of operation
[F07] / [18] (Current code / AI-NET)	TL sensor error	TL sensor Open/Short

This error code means detection of Open/Short of TL sensor.
 Check disconnection of circuit for connection of connector (TL sensor: CN521, White) and characteristics of sensor resistance value. (Refer to Outdoor unit temperature sensor characteristics.)
 If sensor is normal, replace outdoor I/F P.C. board.

Check code	Check code name	Cause of operation
[F08] / [1b] (Current code / AI-NET)	TO sensor error	TO sensor Open/Short

This error code means detection of Open/Short of TO sensor.
 Check disconnection of circuit for connection of connector (TO sensor: CN507, Yellow) and characteristics of sensor resistance value. (Refer to Outdoor unit temperature sensor characteristics.)
 If sensor is normal, replace outdoor I/F P.C. board.

Check code	Check code name	Cause of operation
[F10] / [0C] (Current code / AI-NET)	Indoor TA sensor error	TA sensor Open/Short

This error code means detection of Open/Short of TA sensor.
 Check disconnection of circuit for connection of connector (TA sensor: CN104, White) and characteristics of sensor resistance value. (Refer to Outdoor unit temperature sensor characteristics.)
 If sensor is normal, replace indoor P.C. board.

Check code	Check code name	Cause of operation
[F12] / [A2] (Current code / AI-NET)	TS1 sensor error	TS1 sensor Open/Short

This error code means detection of Open/Short of TS1 sensor.
 Check disconnection of circuit for connection of connector (TS1 sensor: CN504, White) and characteristics of sensor resistance value. (Refer to Outdoor unit temperature sensor characteristics.)
 If sensor is normal, replace outdoor I/F P.C. board.

Check code	Check code name	Cause of operation
[F13] / [43] (Current code / AI-NET)	TH sensor error	IGBT built-in sensor error in A3-IPDU

Sub-code: 01: Compressor 1 side 02: Compressor 2 side

This error code means IGBT built-in temperature sensor error.
 Check connection of connectors CN06 on IPDU P.C. board and CN600 on I/F P.C. board.
 If sensor is normal, replace IPDU P.C. board.

Check code	Check code name	Cause of operation
[F15] / [18] (Current code / AI-NET)	Outdoor temp sensor miscabling (TE1, TL)	<ol style="list-style-type: none"> Misinstallation and misconnection of TE1 sensor and TL sensor Resistance characteristics error of TE1 sensor and TL sensor Outdoor P.C. board (I/F) error

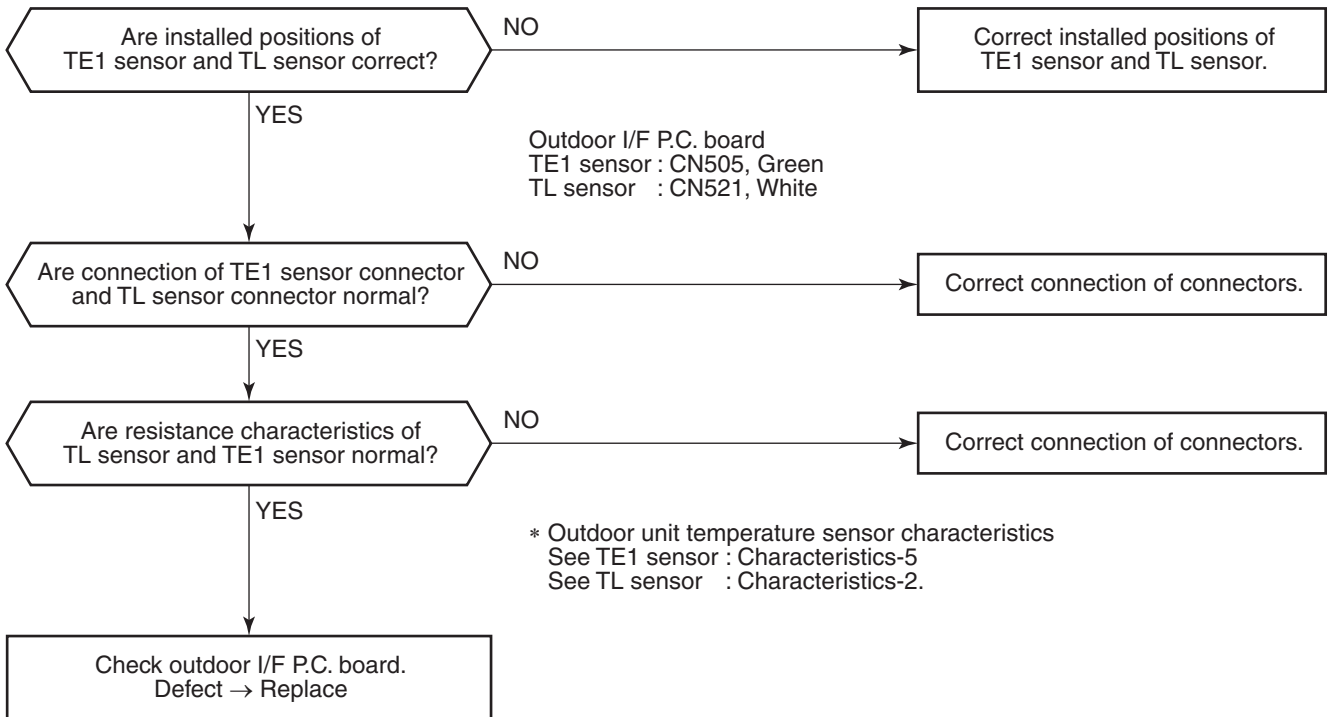

* TE1 sensor : Outdoor heat exchanger temp sensor
 TL sensor : Temp sensor between liquid tanks of outdoor PMV1/2

Check code	Check code name	Cause of operation
[F16] / [43] (Current code / AI-NET)	Outdoor pressure sensor miscabling (Pd, Ps)	1. High-pressure Pd sensor and low-pressure sensor Ps are exchanged. 2. Output voltage of each sensor is zero.

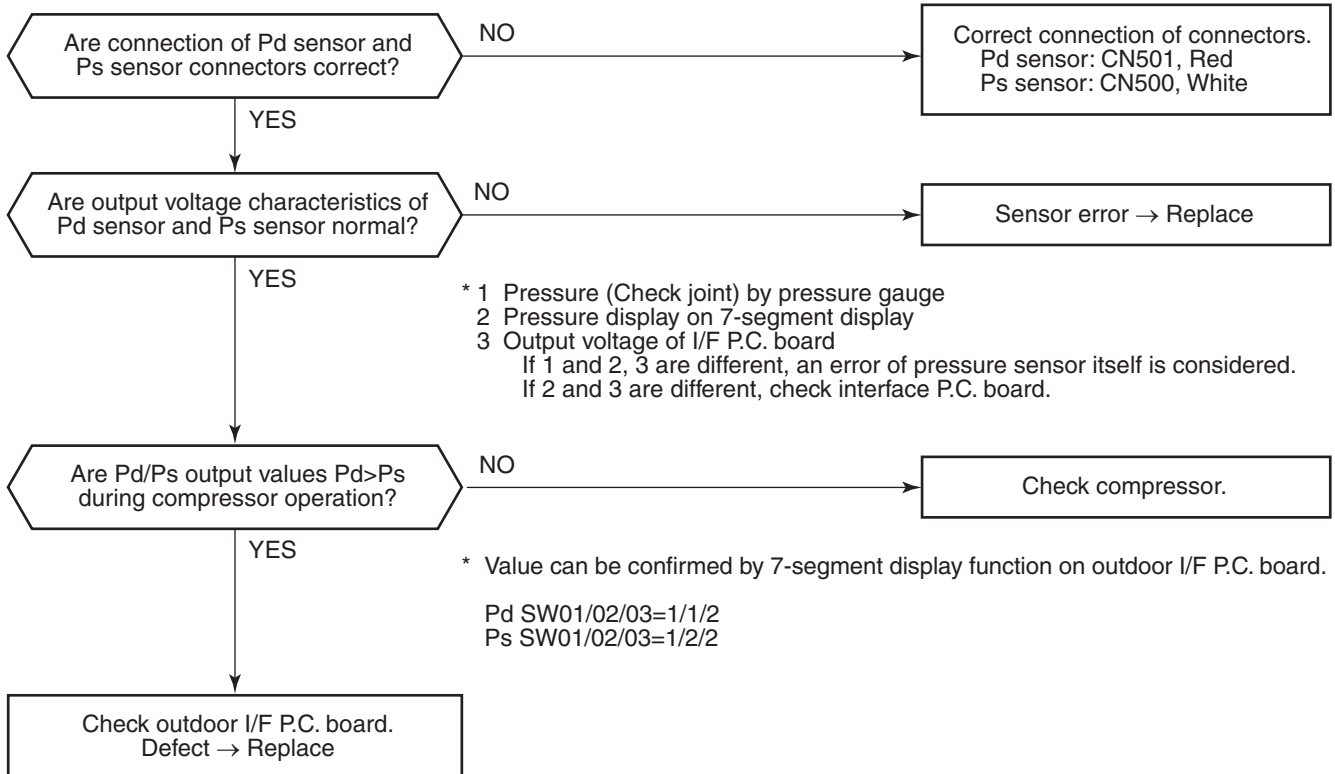

Check code	Check code name	Cause of operation
[F23] / [43] (Current code / AI-NET)	Ps sensor error	Output voltage error of Ps sensor

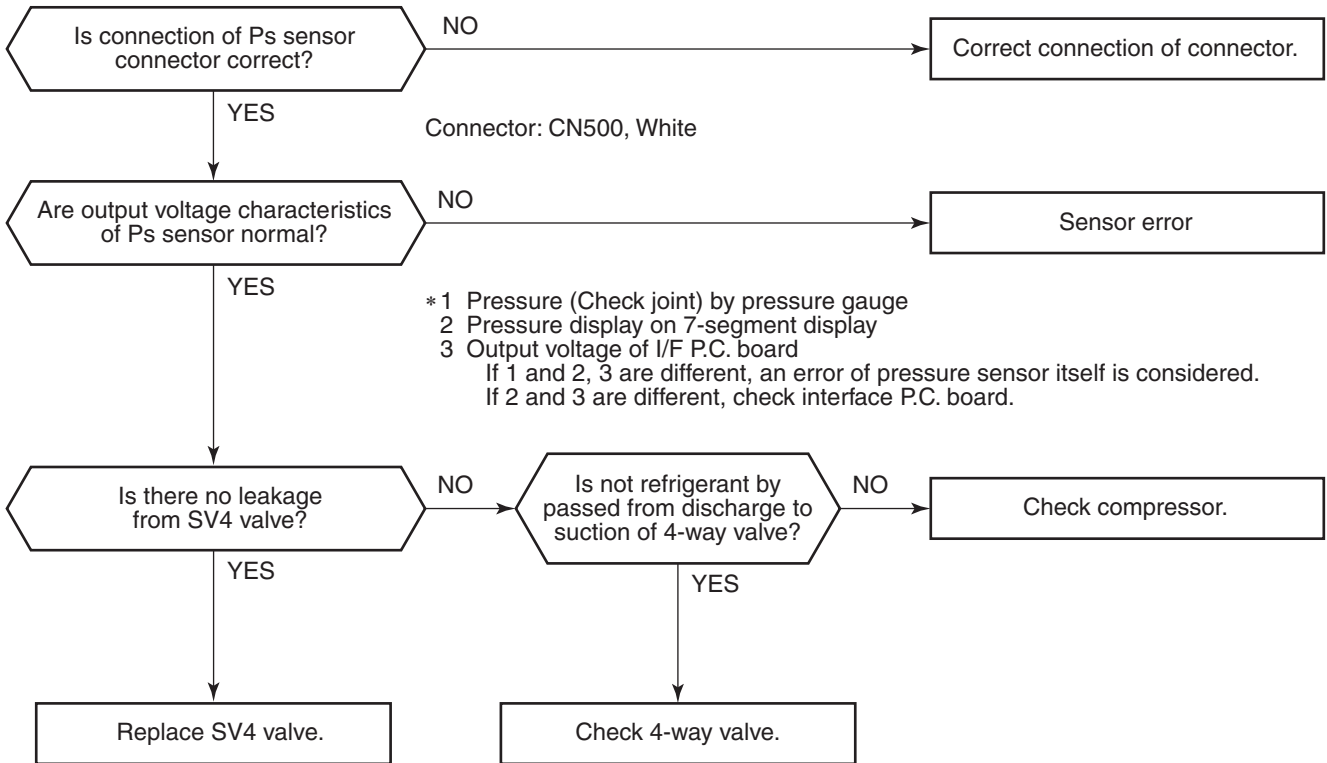

Check code	Check code name	Cause of operation
[F24] / [43] (Current code / AI-NET)	Pd sensor error	Output voltage error of Pd sensor

It is output voltage error of Pd sensor.
 Check disconnection of connection of connector (Pd sensor: CN501) circuit and output voltage of sensor.
 If the sensor is normal, replace outdoor I/F P.C. board.

Check code	Check code name	Cause of operation
[F29] / [12] (Current code / AI-NET)	Indoor other error	Indoor P.C. board error EEROM error

This error is detected during operation of air conditioner of IC10 non-volatile memory (EEPROM) on indoor unit P.C. board. Replace service P.C. board.

* If EEPROM was not inserted when power was turned on or it is absolutely impossible to read/write EEPROM data, the automatic address mode is repeated. In this case, [97 error] is displayed on AI-NET central controller.

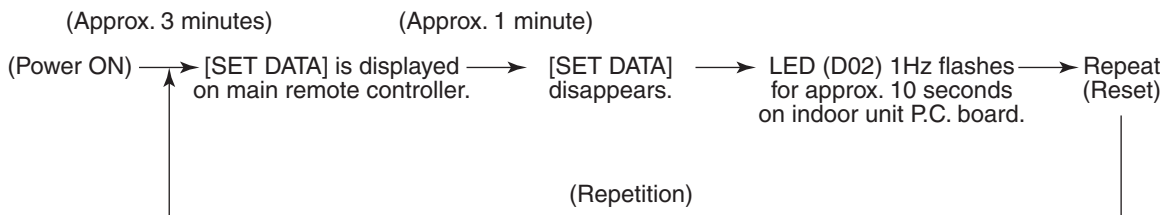

Check code	Check code name	Cause of operation
[F31] / [1C] (Current code / AI-NET)	Outdoor EEPROM error	1. Outdoor unit power error (Voltage, noise, etc.) 2. Outdoor I/F P.C. board error



Check code	Check code name	Cause of operation
[H01] / [1F] (Current code / AI-NET)	Compressor breakdown	1. Outdoor unit power line error 2. Compressor circuit system error 3. Compressor error 4. Cause of abnormal overload operation 5. IPDU P.C. board error

Sub-code: 01: Compressor 1 side 02: Compressor 2 side

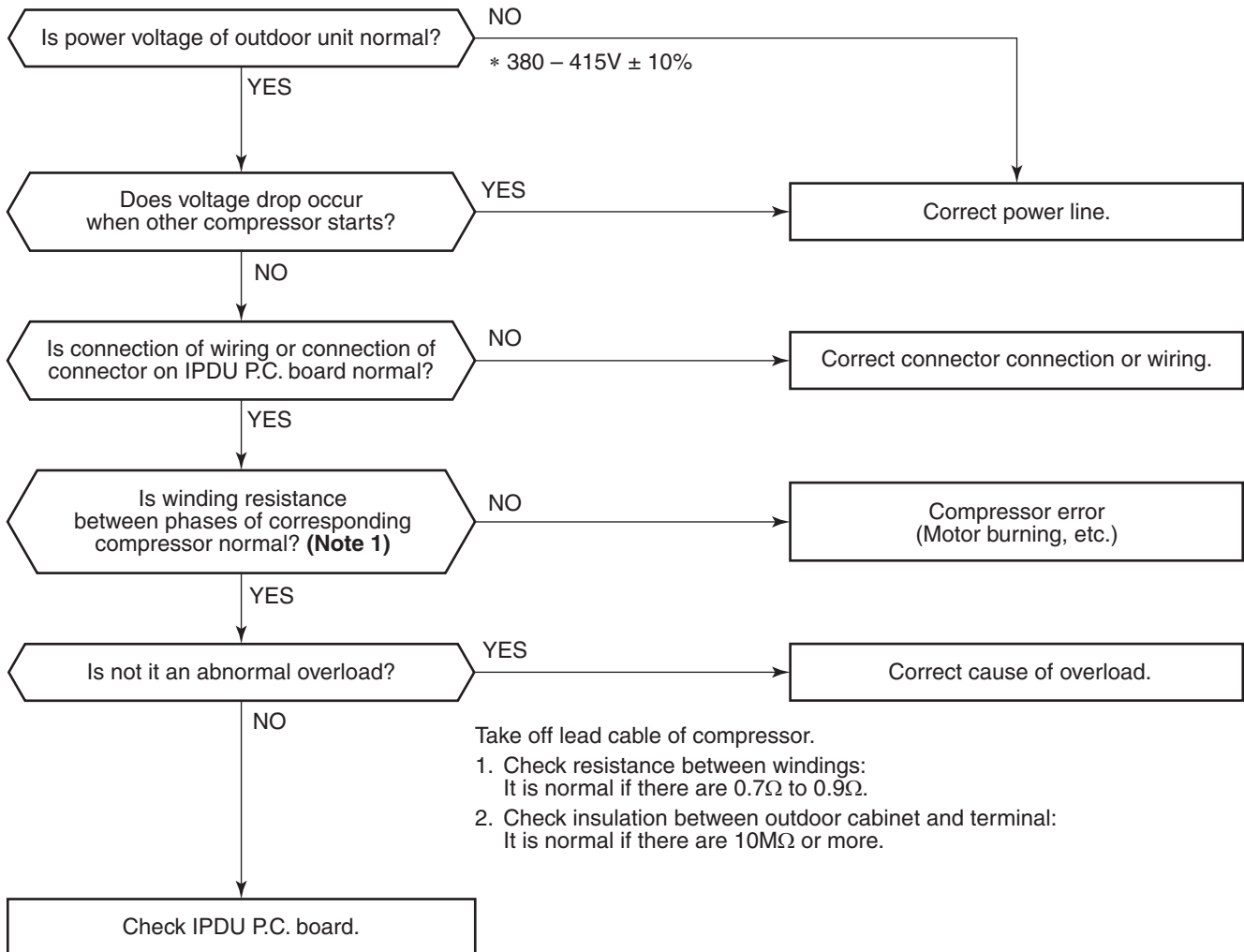

Take off lead cable of compressor.
 1. Check resistance between windings:
 It is normal if there are 0.7Ω to 0.9Ω.
 2. Check insulation between outdoor cabinet and terminal:
 It is normal if there are 10MΩ or more.

Note 1

* After checking the output, when connecting the compressor lead again to the compressor terminal, check surely there is no distortion on the Fasten receptacle terminal. If it is loosened, caulk it with pinchers, etc and then connect lead to the terminal firmly.

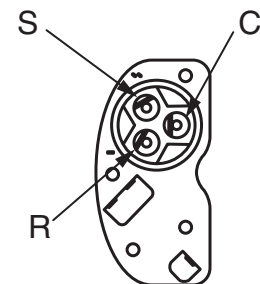

Details of compressor power connecting section

Check code	Check code name	Cause of operation
[H02] / [1d] (Current code / AI-NET)	Compressor error (Lock)	1. Outdoor unit power line error 2. Compressor circuit system error 3. Compressor error 4. Refrigerant stagnation in compressor shell 5. IPDU P.C. board error

Sub-code: 01: Compressor 1 side 02: Compressor 2 side

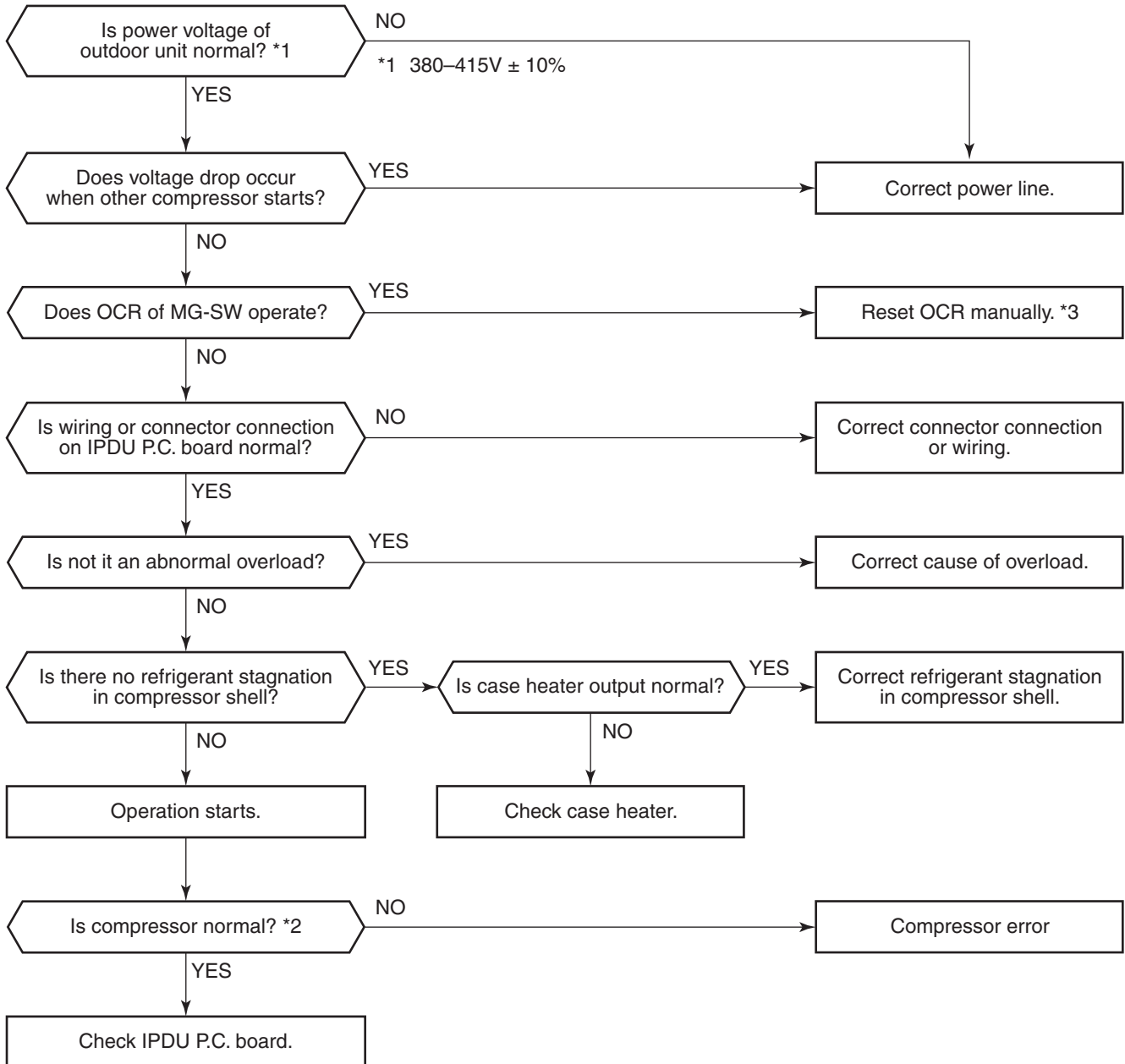

*2 Check the following items mainly.
 1. Existence of abnormal sound and abnormal vibration during operation or starting
 2. Abnormal overheat of case during operation or stop time (Never touch with hands.)
 3. Current of compressor lead during operation or starting time
 (No varied change of current) change

*3 If OCR operates even after manual reset of OCR, check whether the wiring to the current sensor (TO2) of Comp-IPDU is correct or not.

Check code	Check code name	Cause of operation
[H03] / [17] (Current code / AI-NET)	Current detective circuit system error	1. Cabling or connector connection error on IPDU P.C. board 2. IPDU P.C. board error

Sub-code: 01: Compressor 1 side 02: Compressor 2 side

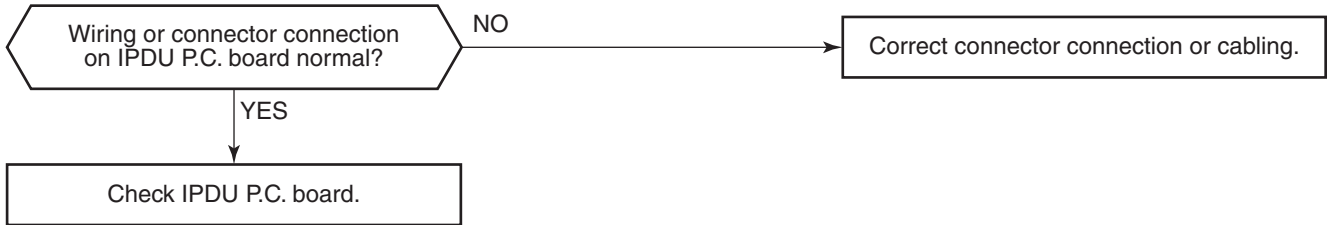

Check code	Check code name	Cause of operation
[H04] / [44] (Current code / AI-NET)	Compressor 1 case thermo operation	1. Case thermo circuit error 2. I/F P.C. board error 3. Service valve closed
[H14] / [44] (Current code / AI-NET)	Compressor 2 case thermo operation	4. Outdoor PMV clogging 5. SV4 valve leak, Coil misinstallation 6. 4-way valve error 7. Compressor error 8. Refrigerant shortage

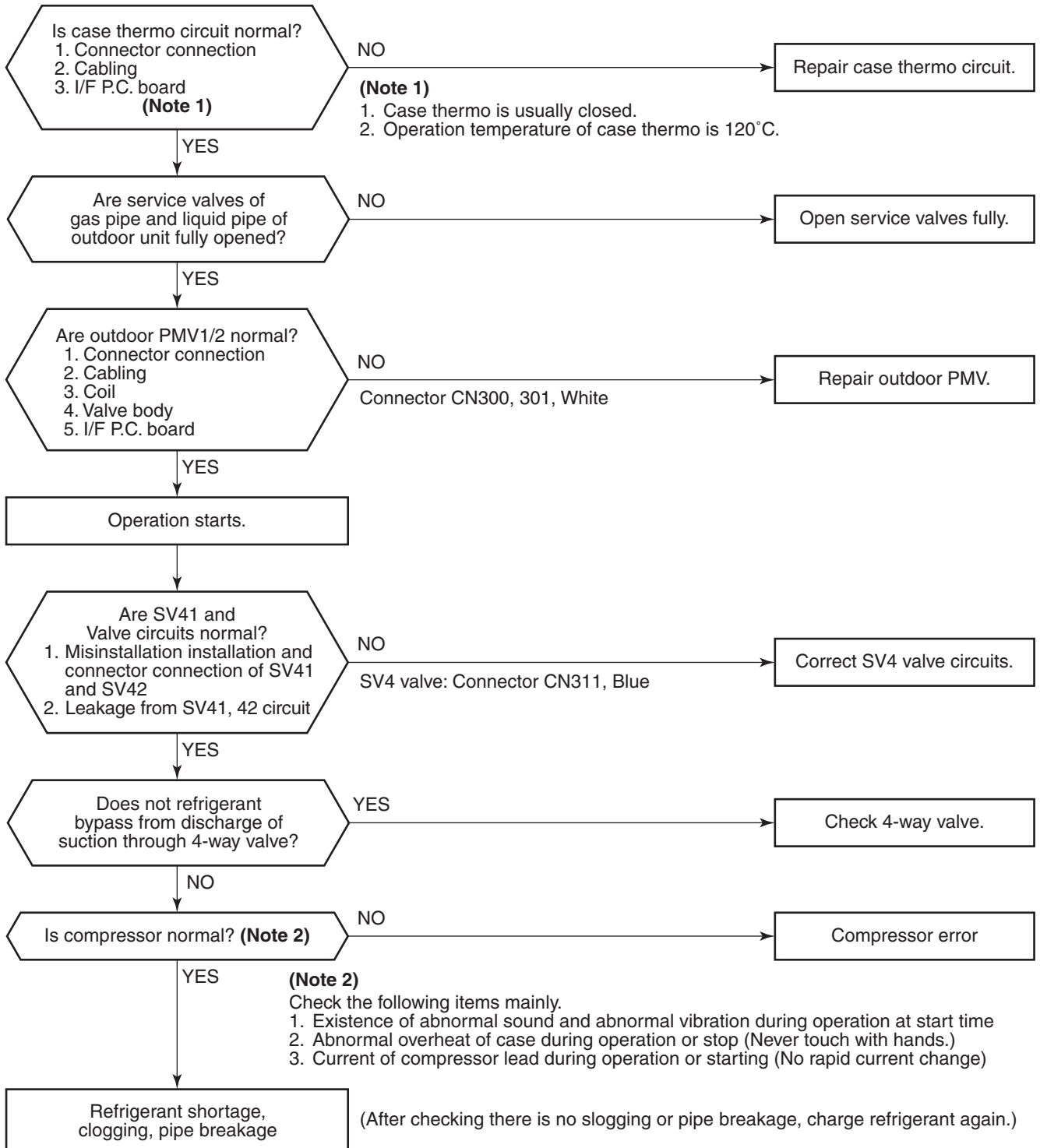

Check code	Check code name	Cause of operation
[H06] / [20] (Current code / AI-NET)	Low-pressure protective operation	1. Service valve close 2. Ps sensor error 3. SV2, SV4 circuit error 4. Miscabling of communication between indoor and outdoor 5. Indoor/outdoor fan and condenser error 6. Indoor/outdoor PMV clogging 7. Indoor/outdoor heat exchanger clogging 8. Refrigerant shortage

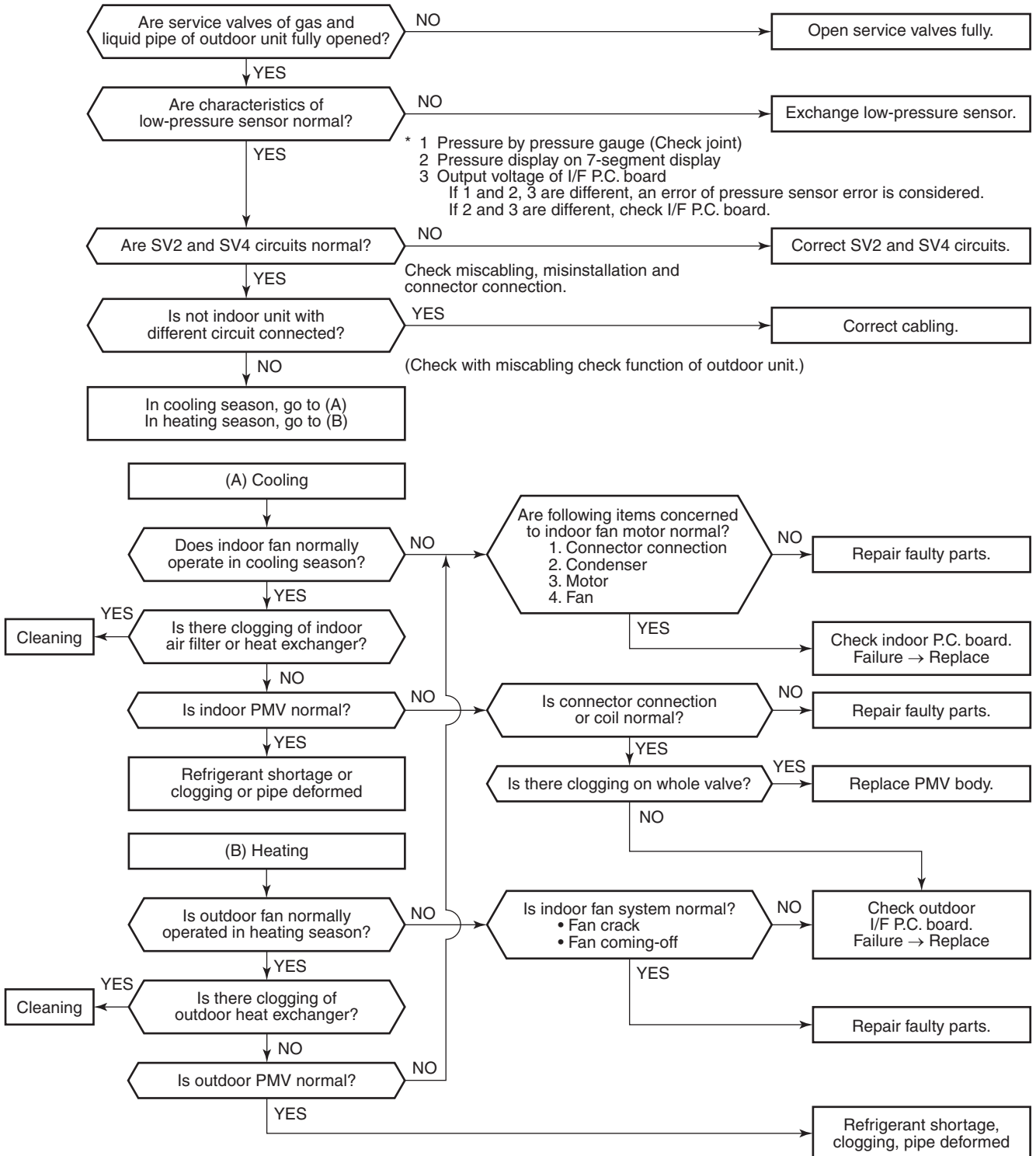

Check code	Check code name	Cause of operation
[H07] / [d7] (Current code / AI-NET)	Oil level down detection protection	1. Valves of balance pipes closed. 2. Miscabling or misinstallation of TK1 to TK4 sensors 3. TK1 to TK4 sensor error 4. Gas leak or oil leak of all outdoor units 5. Refrigerant stagnation of compressor case 6. SV3A, 3B, 3D, 3C, 3E valve error 7. Clogging of oil return circuit from oil separator 8. Clogging of oil-equalization circuit system

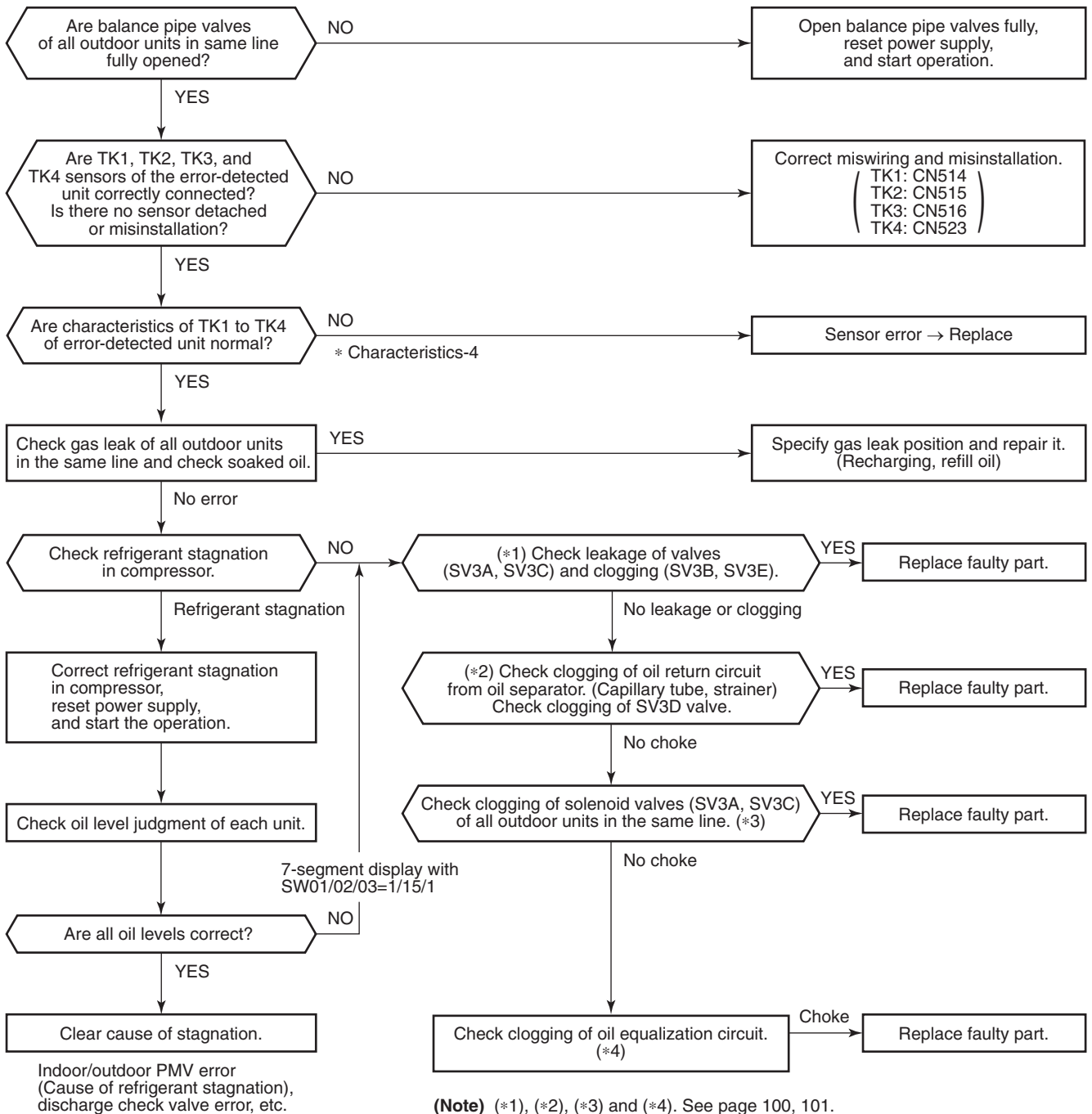

(Reference) When refrigerant stagnates in compressor shell, the oil level shortage may be judged.

In some cases, it may be difficult to check the leakage of clogging in the following condition of refrigerant stagnation in low ambient temperature condition.

In this case, take a longer operating time prior to check.

(Criterion: Discharge temperature of TD1 and TD2 are 60°C or higher)

(*1)

a) Leakage check for SV3A valve (For multiple outdoor unit system)

- Turn off the power supply, take off connector of SV3A valve, and then start a test operation after power-ON.
- Check the temperature change at secondary side of SV3A valve during operation. (① in the figure.)
→ If temperature is raised, it is a leakage of SV3A valve. Replace SV3A valve.

b) Leakage check for SV3C valve

- Turn off the power supply, take off connector of SV3C valve, and then start a test operation after power-ON.
- After operation for several minutes, check temperature at secondary side of SV3C valve. (② in the figure.)
→ If temperature is high (equivalent to discharge temperature TD), it is a leakage of SV3C valve. Replace SV3C valve. (Even if there is leakage from SV3C valve does not occur, temperature of SV3C valve at secondary side rises during operation. When the checked temperature is equivalent to TD temperature, it is a leakage of SV3C valve. Replace SV3C valve.)

c) Clogging check for SV3B valve (For multiple outdoor unit system)

- While outdoor unit is operated, set up SW01/02/03 = [2] [1] [3] to 7-segment display [Hr] [2], and push SW04 for 2 seconds or more.
- Set up SW02 = [9], and turn on SV3A, SV3B, SV3C valves. (7-segment display [Hr] [3-])
- While outdoor unit is operating, check temperature change at secondary side of SV3B valve. (③ in the figure.)
→ If temperature does not rise (equivalent to suction temperature), it is a clogging of SV3B valve. Replace SV3B valve.

d) Clogging for SV3E valve

Reset the power supply.



Referring to “Valve forced open/close function” of the outdoor unit, check ON/OFF operation (Sound, coil surface temp up) of SV3E valve is performed.



Start test operation in COOL or HEAT mode.



After operation for several minutes, check the pipe temperature at the secondary side of SV3E valve whether temperature changes or not.

If it is equivalent to outside temperature, clogging of SV3E is considered. (④ in the figure.)

(Reference)

If SV3E valve is clogged, temperature of all TK1, TK2, TK3, and TK4 do not change.

(*2) Clogging check for SV3D valve of oil return circuit from oil separator

a) Oil return circuit

- While outdoor unit is operating, check temperature (secondary side of capillary) on oil return circuit. (⑤ in the figure.)
→ If temperature is low equivalent to suction temperature), a clogging of strainer of oil return circuit or capillary is considered. Repair the clogged part.

b) Clogging check for SV3D valve

- While outdoor unit is operating, set up SW01/02/03 = [2] [1] [3] to 7-segment display [Hr] [2], and push SW04 for 2 seconds or more.
- Set up SW02 = [6], and turn on SV3D valve. (7-segment display [Hr] [3d])
- If temperature is low at secondary side of the valve or it does not change, clogging of valve, capillary, or strainer is considered. (⑥ in the figure.)

(*3) Check for solenoid valve of outdoor unit (For multiple outdoor unit system)

a) Clogging check for SV3A valve

- While outdoor unit is operating, set up SW01/02/03 = [2] [1] [3] to 7-segment display [Hr] [2], and push SW04 for 2 seconds or more.
- Set up SW02 = [4], and turn on SV3A valve. (7-segment display [Hr] [3A])
- If temperature is low at secondary side of the valve or it does not change, clogging of valve or check valve is considered. (① in the figure.)

b) Leakage check for SV3C valve

- While outdoor unit is operating, set up SW01/02/03 = [2] [1] [3] to 7-segment display [Hr] [2], and push SW04 for 2 seconds or more.
- Set up SW02 = [6], and turn on SV3C valve. (7-segment display [Hr] [3C])
- If temperature does not change (up), clogging of valve or strainer is considered. (② in the figure.)

(*4)

a) Clogging check for oil-equalization circuit

- Drive the outdoor unit. (Drive both compressors in the unit.)
- After driving for 10 minutes, check temperature of TK1 and TK2 sensors and temperature of oil-equalization circuit capillary (⑦ in the figure) were raised.

(Criterion)

TK1, TK2=TD1, TD2 temperature – Approx. 10 to 30°C

Oil-equalization capillary tubes should be higher sufficiently than outside air temperature and suction temperature.

- If temperature is low, a malfunction of capillary, strainer, or check valve is considered. Repair the defective parts.

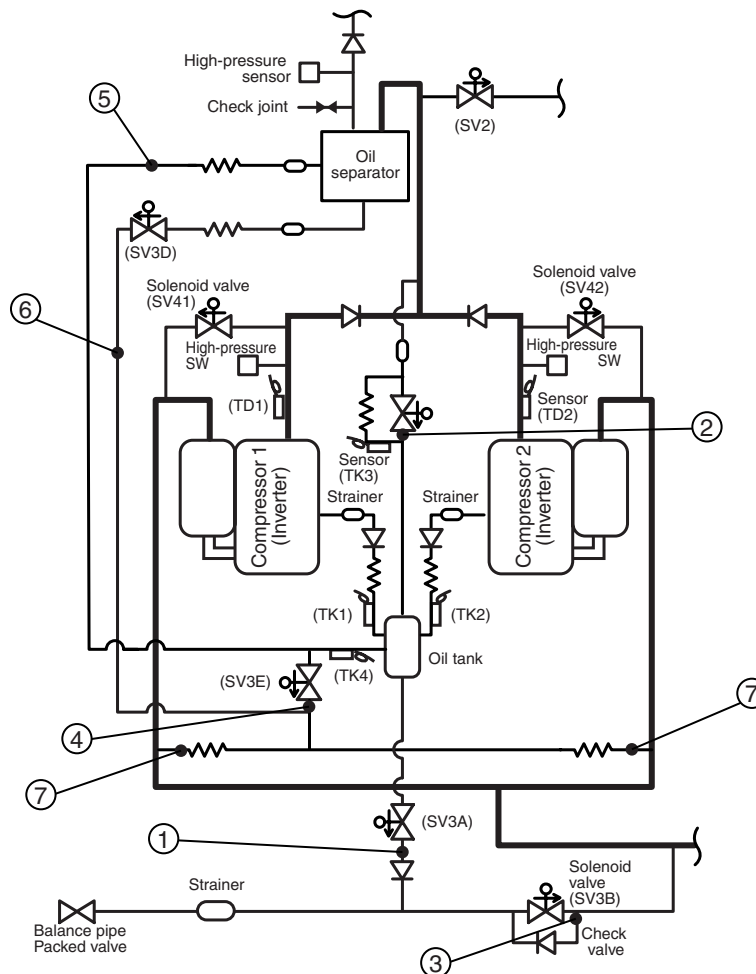

Check code	Check code name	Cause of operation
[H08] / [d4] (Current code / AI-NET)	Oil level detective temperature sensor error	TK1 to TK4 sensor Open/Short

Sub-code: 01: TK1 sensor error 02: TK2 sensor error 03: TK3 sensor error 04: TK4 sensor error

The detected error is an oil level detective temperature sensor error. Check disconnection of the wiring and resistance value of the sensor. If the sensors are normal, replace the outdoor I/F P.C. board.

Circuit	Connector
TK1	CN514 (Black)
TK2	CN515 (Green)
TK3	CN516 (Red)
TK4	CN523 (Yellow)

Check code	Check code name	Cause of operation
[H16] / [d7] (Current code / AI-NET)	TK1 temperature detective circuit error (Sub-code: 01)	<ol style="list-style-type: none"> Coming-off of TK1 sensor, miscabling, characteristics error of resistance value Oil-equalization circuit error (Check valve, capillary clogging, strainer clogging) Refrigerant stagnation in case of compressor shell

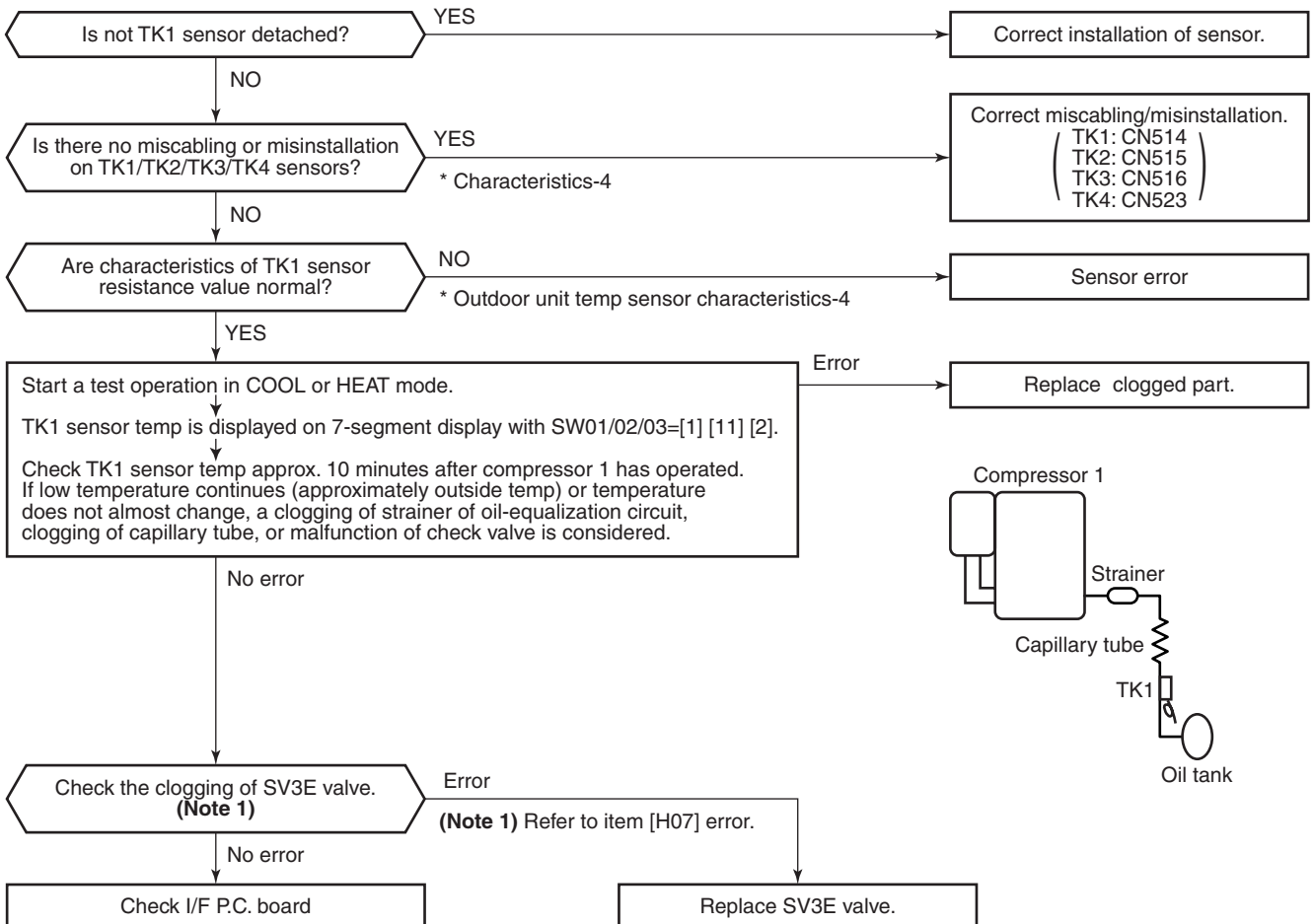

Check code	Check code name	Cause of operation
[H16] / [d7] (Current code / AI-NET)	Oil level detective circuit system error (Sub-code: 02)	1. Detachment of TK2 sensor, miscabling, characteristics error of resistance value 2. Oil-equalization circuit error (Check valve, capillary clogging, strainer clogging) 3. Refrigerant stagnation in compressor shell

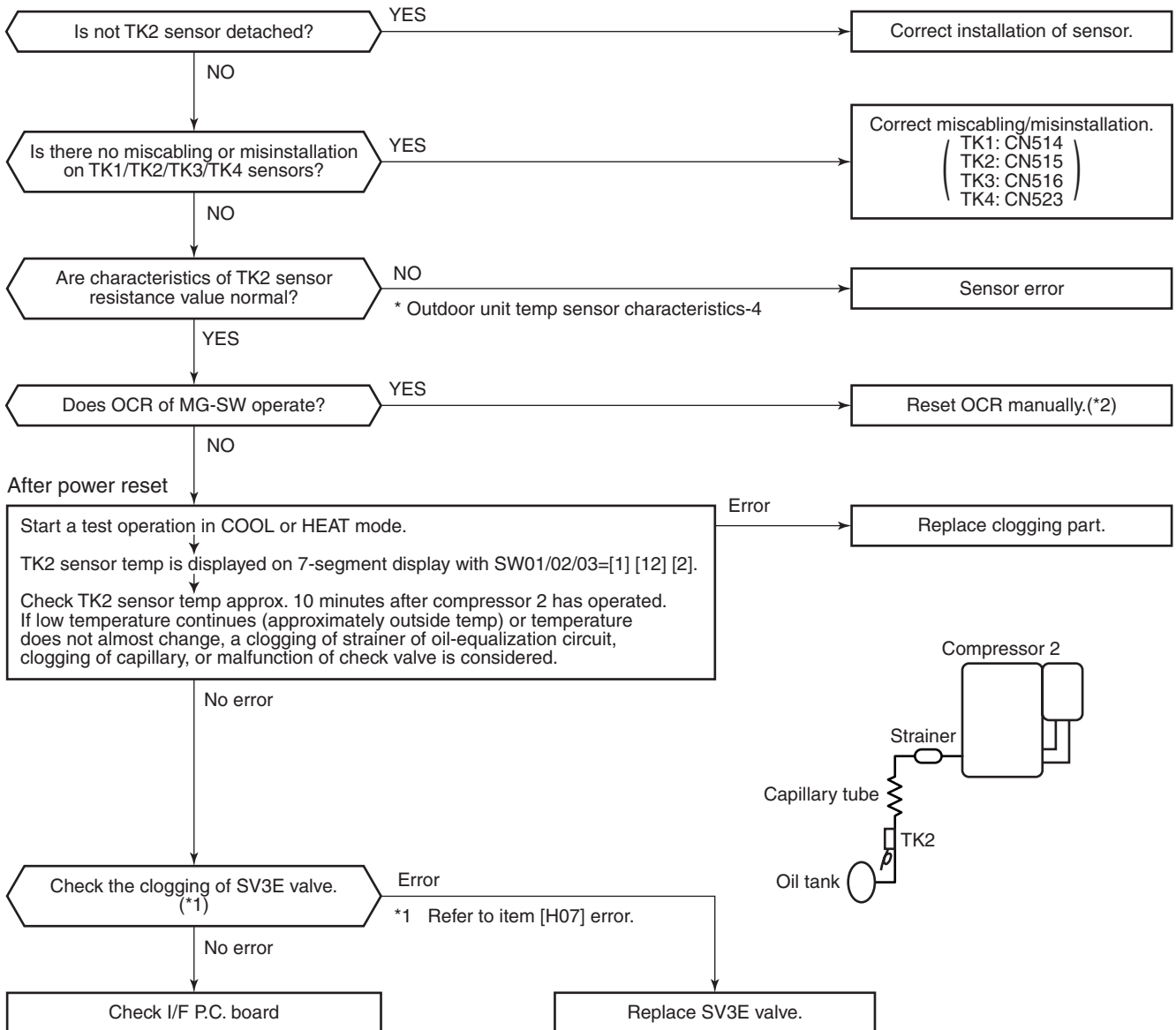

*2 If OCR operates even after manual reset of OCR, check whether the wiring to the current sensor (TO2) of Comp-IPDU is correct or not.

Check code	Check code name	Cause of operation
[H16] / [d7] (Current code / AI-NET)	TK3 temperature detective circuit error (Sub-code: 03)	1. Detachment of TK3 sensor, miscabling, characteristics error of resistance value 2. Error of SV3C valve circuit periphery (Check capillary clogging, strainer clogging) 3. Refrigerant stagnation in compressor shell

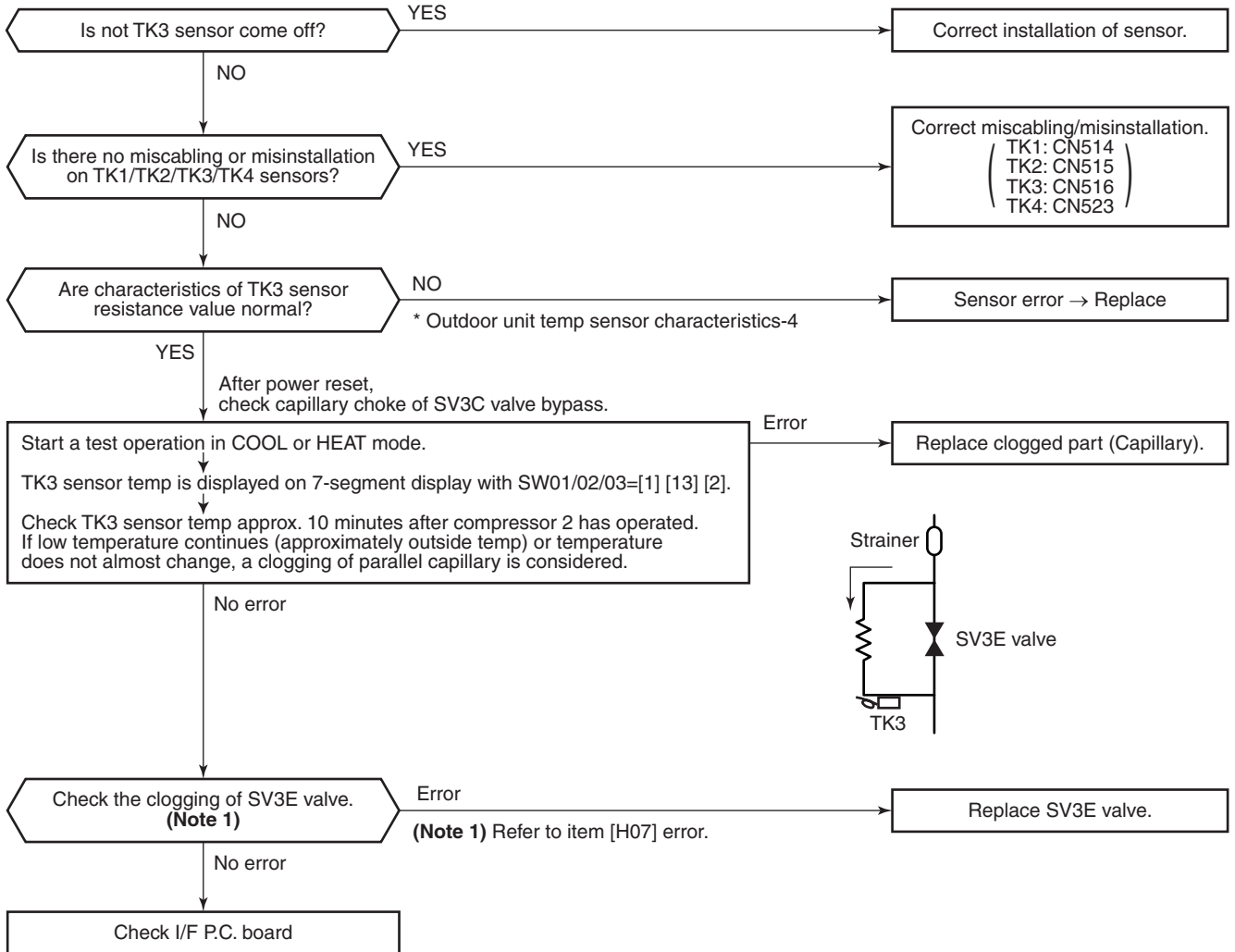

Check code	Check code name	Cause of operation
[H16] / [d7] (Current code / AI-NET)	TK4 temperature detective circuit error (Sub-code: 04)	1. Detachment of TK4 sensor, miscabling, characteristics error of resistance value 2. Check clogging and malfunction of SV3E valve circuit. 3. Oil-equalization circuit error (Check capillary clogging, strainer clogging) 4. Refrigerant stagnation in compressor shell

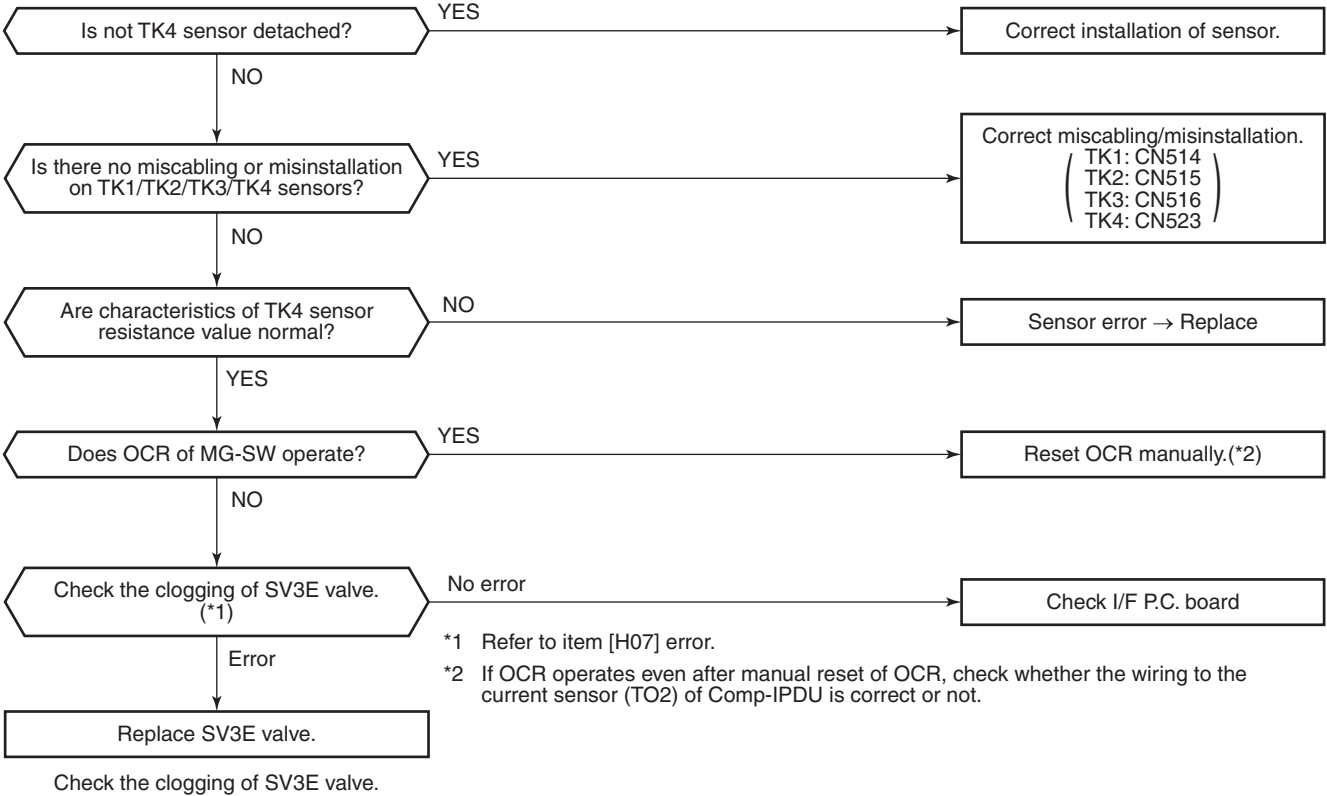

Check code	Check code name	Cause of operation
[L03] / [96] (Current code / AI-NET)	Duplicated indoor header units	There were two or more indoor header units in some remote controller group control.

1) Check the connection changing of the remote controller after the connection has been changed.
 2) If the group configuration and address are normal when power has been turned on, the mode automatically shifts to address setup mode. (Re-setup of address) → Refer to “Address setup”.

Check code	Check code name	Cause of operation
[L04] / [96] (Current code / AI-NET)	Duplicated setup of outdoor line address	Outdoor line addresses are duplicated.

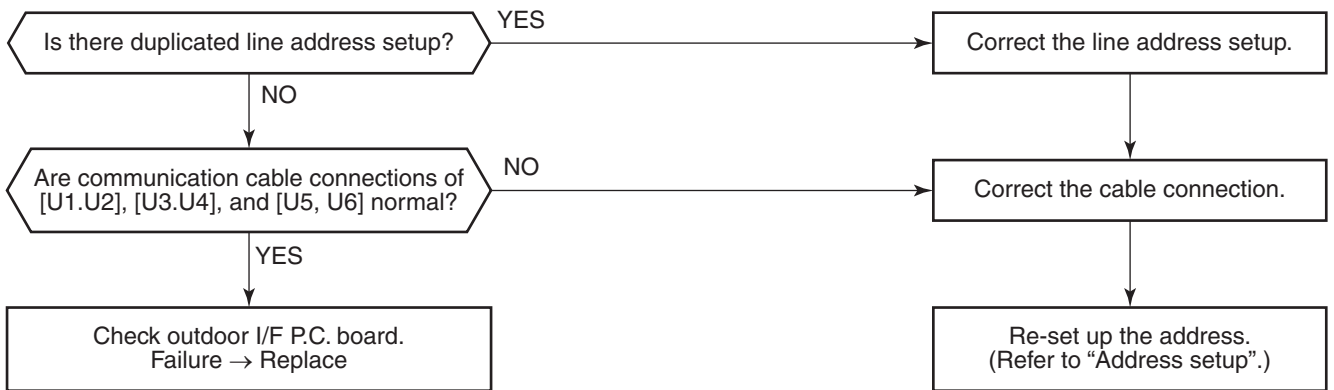

Check code	Check code name	Cause of operation
[L05] / [96] (Current code / AI-NET)	Duplicated indoor units with priority (Displayed on indoor unit with priority)	1. Two or more prior indoor units exist.

This check code is displayed on the set indoor unit when setup of indoor unit with priority is duplicated.
 • Priority setup with two or more units is not available. Choose one prior unit in one refrigerant circuit system.

Check code	Check code name	Cause of operation
[L06] / [96] (Current code / AI-NET)	Duplicated indoor units with priority (Displayed on the indoor unit other than one with priority and on the outdoor unit)	Two or more indoor units with priority are duplicated.

Sub-code: No. of indoor units with priority

When indoor unit with priority is duplicated, this check code is displayed on the unit other than the setup indoor unit and outdoor unit.

- As only one indoor unit with priority is valid, change the setup.

Check code	Check code name	Cause of operation
[L07] / [99] (Current code / AI-NET)	Group line in individual indoor unit	The group line is connected in the individual indoor unit.

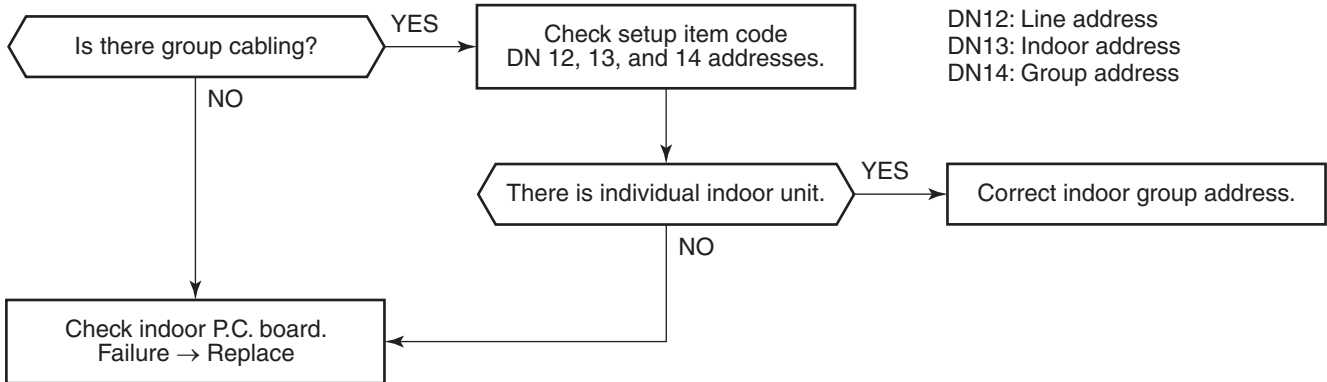

Check code	Check code name	Cause of operation
[L08] / [99]* (Current code / AI-NET)	Indoor group / address unset	Indoor address unset

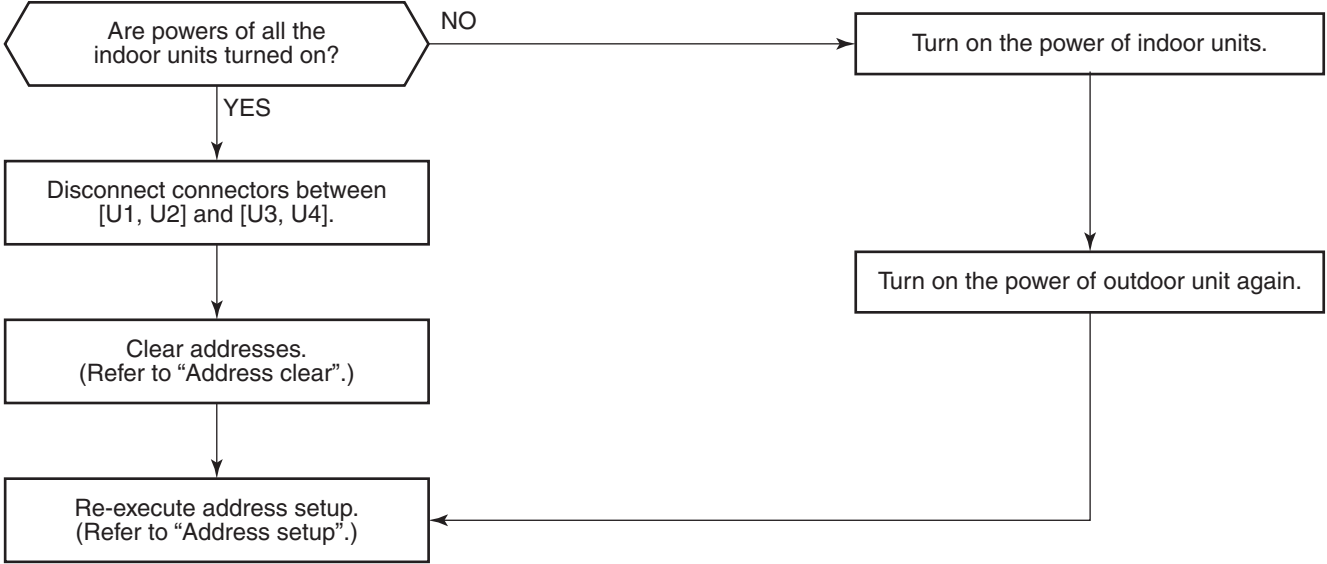

Note) This code is displayed when the power is turned on at the first time after installation. (Because the address is not yet set up)

Check code	Check code name	Cause of operation
[L09] / [46] (Current code / AI-NET)	Indoor capacity unset	Indoor capacity unset

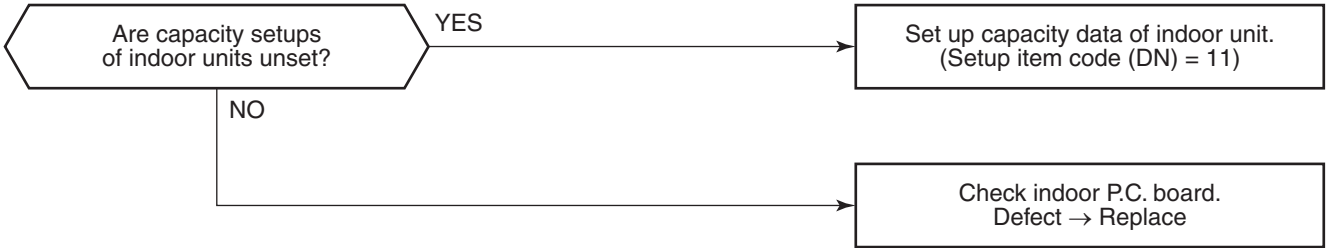

Check code	Check code name	Cause of operation
[L10] / [88] (Current code / AI-NET)	Outdoor capacity unset	On the outdoor I/F P.C. board for service, the model selecting jumper has not been set up so as to match with the model.

I/F P.C. board A'ssy service for the outdoor unit is common to this series.
 A setup for model selection different from that for P.C. board with trouble is necessary.
 Set up a model based upon the P.C. board A'ssy exchange procedure.

Check code	Check code name	Cause of operation
[L20] / [98] (Current code / AI-NET)	Duplicated central control addresses	Central control addresses are duplicated.



Check code	Check code name	Cause of operation
[L28] / [46] (Current code / AI-NET)	Quantity over of connected outdoor units	<ol style="list-style-type: none"> Quantity over of connected outdoor units. Connection error of communication line between outdoor units Outdoor I/F P.C. board error

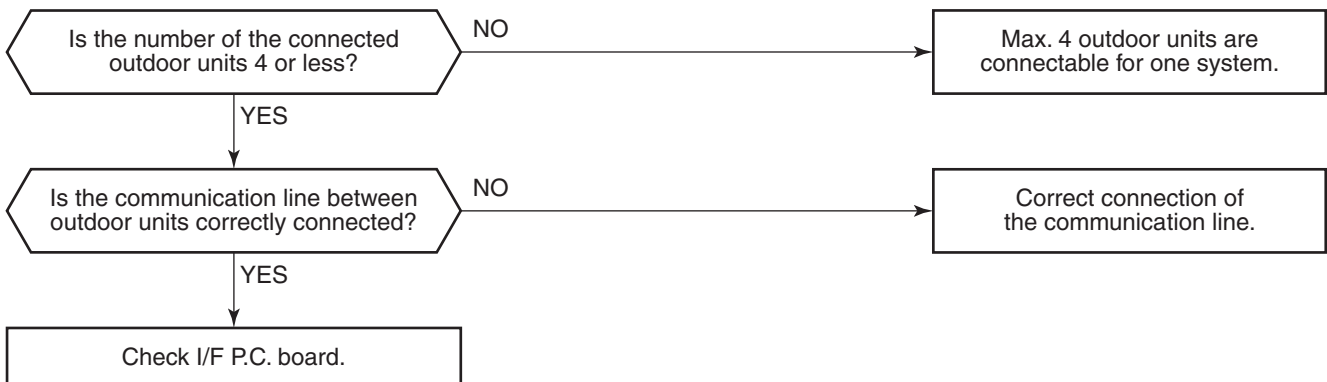

Check code	Check code name	Cause of operation
[L30] / [b6] (Current code / AI-NET)	Interlock in indoor unit from outside	Outside error was input.

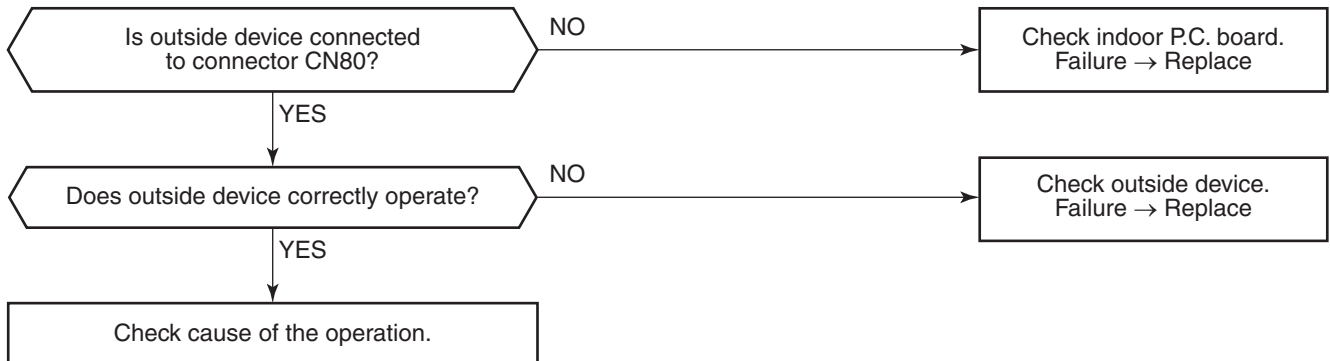

Check code	Check code name	Cause of operation
[L31] / [-] (Current code / AI-NET)	Extended IC error	1. Outdoor unit power error 2. Outdoor I/F P.C. board error

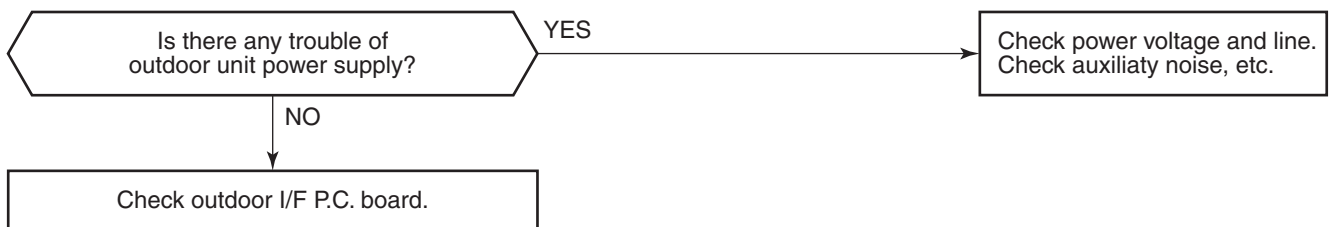

Check code	Check code name	Cause of operation
[P03] / [1E] (Current code / AI-NET)	Discharge temp TD1 error	1. Service valve of outdoor unit closed 2. Outdoor PMV error 3. TD sensor error 4. Refrigerant shortage, clogging of refrigerant circuit system 5. 4-way valve error 6. SV4 circuit leakage, misinstallation

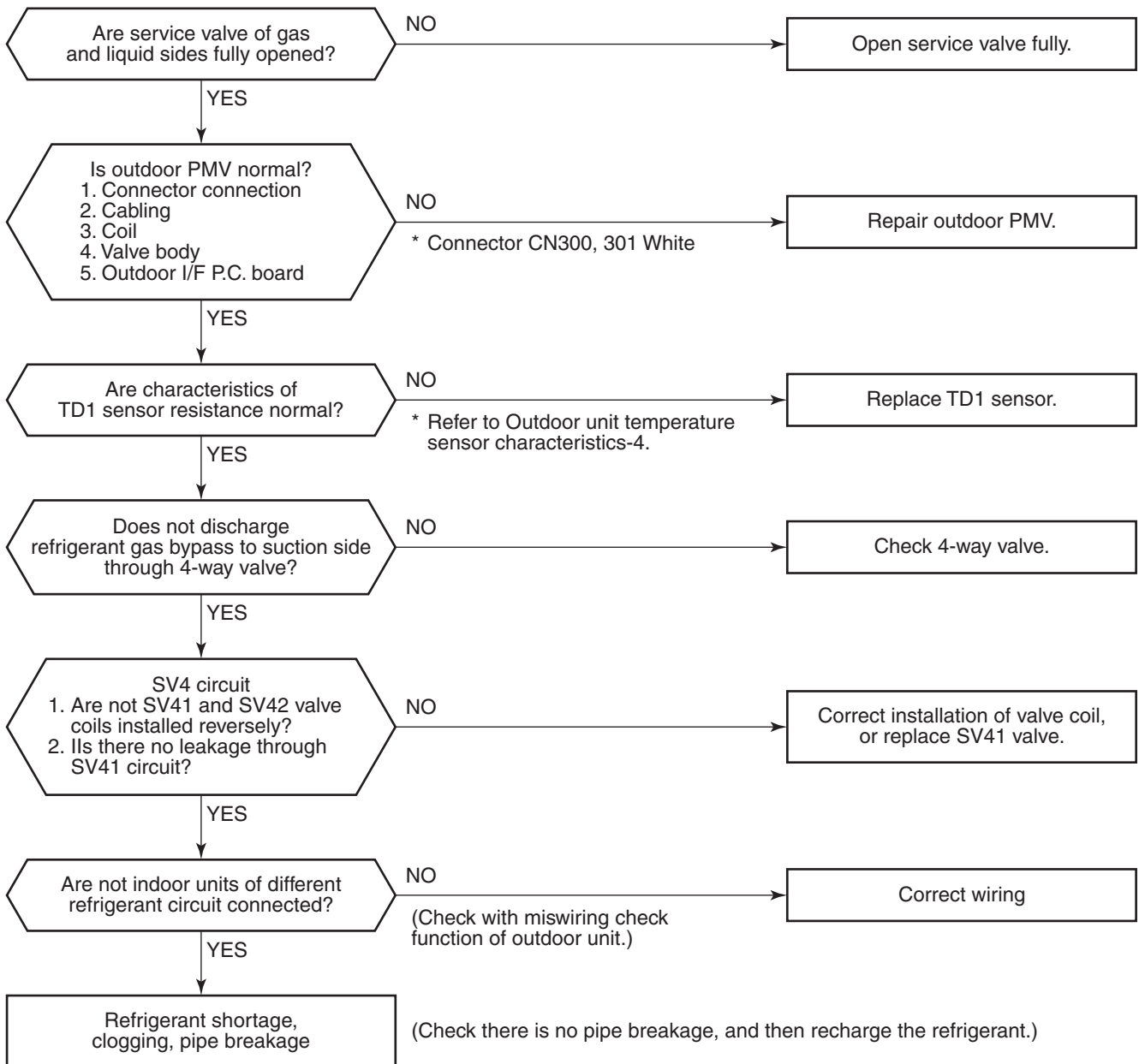

Check code	Check code name	Cause of operation
[P04] / [21] (Current code / AI-NET)	Actuation of high-pressure SW	1. High-pressure SW error 2. Service valve closed 3. Pd sensor error 4. Indoor/outdoor fan error 5. Indoor/outdoor PMV choke 6. Indoor/outdoor heat exchanger clogging, air short circuit 7. SV2 circuit error 8. SV4 circuit error 9. SV5 circuit error 10. Discharge line check valve malfunction 11. Refrigerant overcharge

Sub-code: 01: Compressor 1 side 02: Compressor 2 side

Note) High-pressure SW is normally closed. (B contact)

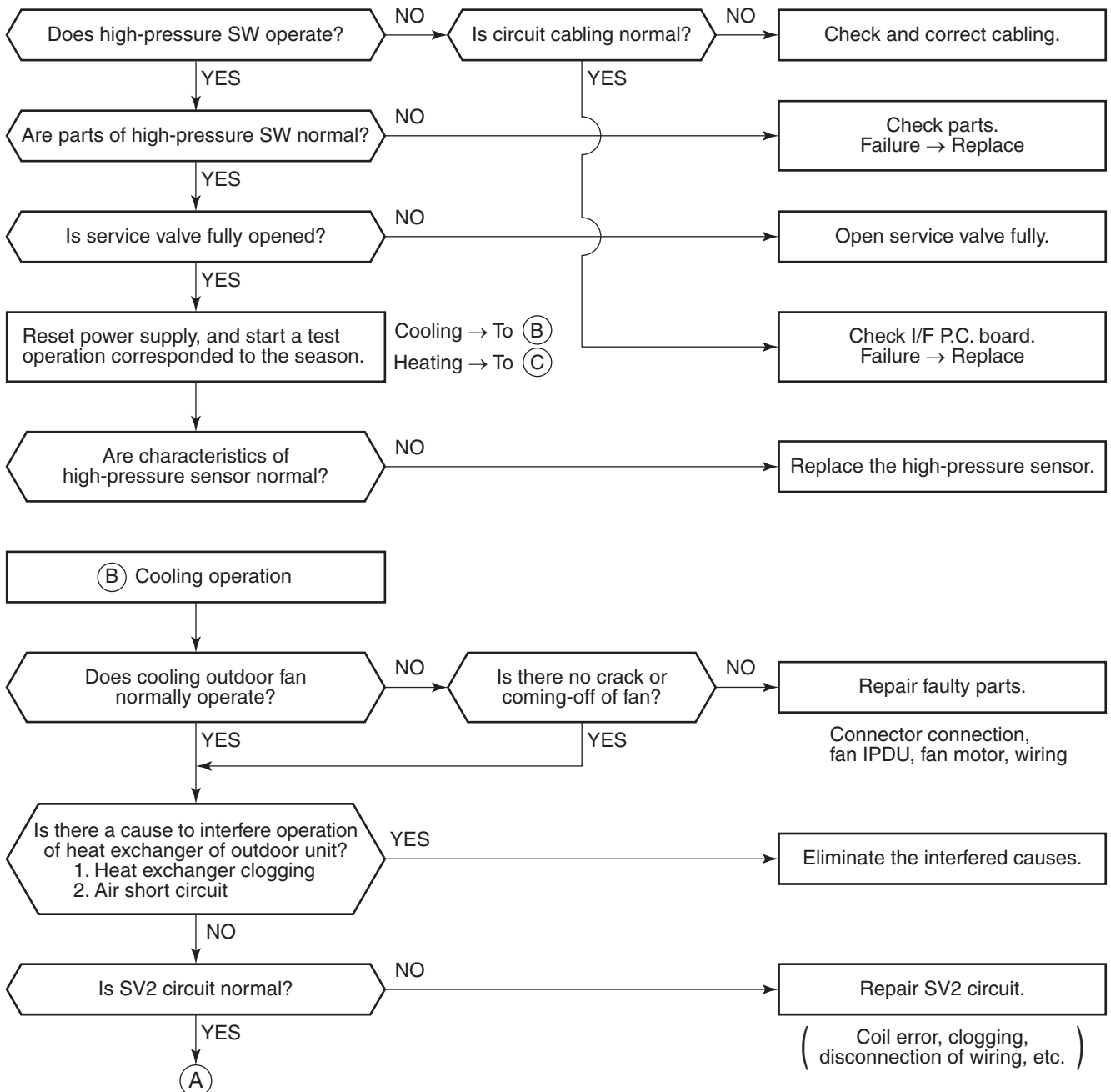

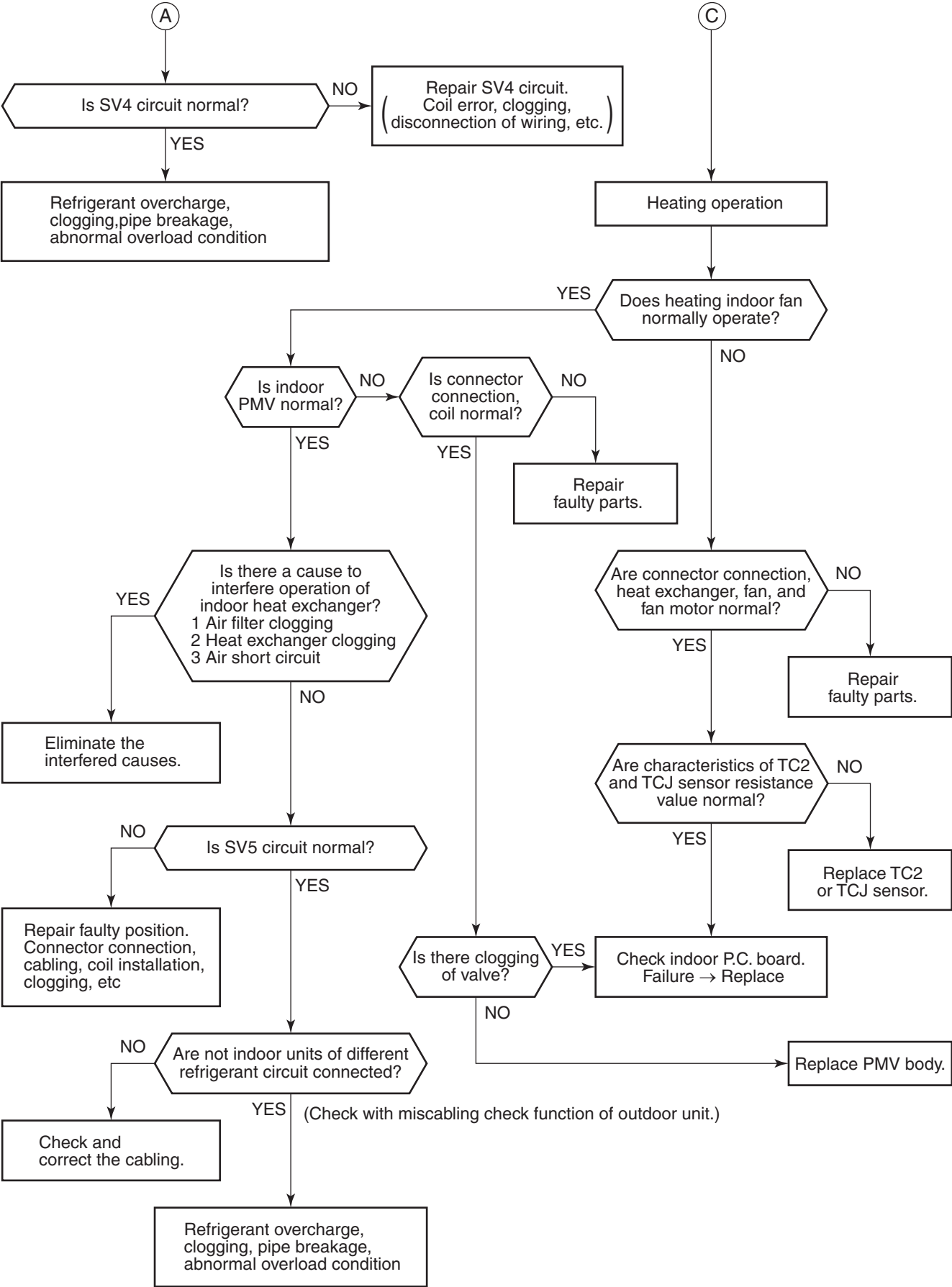

Check code	Check code name	Cause of operation
[P05] / [AF] (Current code / AI-NET)	Open phase, negative phase	1. Power supply open phase 2. Power supply negative phase

- Check the phase power line of outdoor unit.
- Check error of outdoor I/F P.C. board.
- Check there is no looseness, etc of terminal.

Check code	Check code name	Cause of operation
[P07] / [1C] (Current code / AI-NET)	Heat sink overheat error	1. Power voltage error 2. Outdoor fan system error 3. Heat sink installation error 4. Clogging of hear sink cooling duct 5. IPDU P.C. board error (TH sensor error)

Sub-code: 01: Compressor 1 side 02: Compressor 2 side

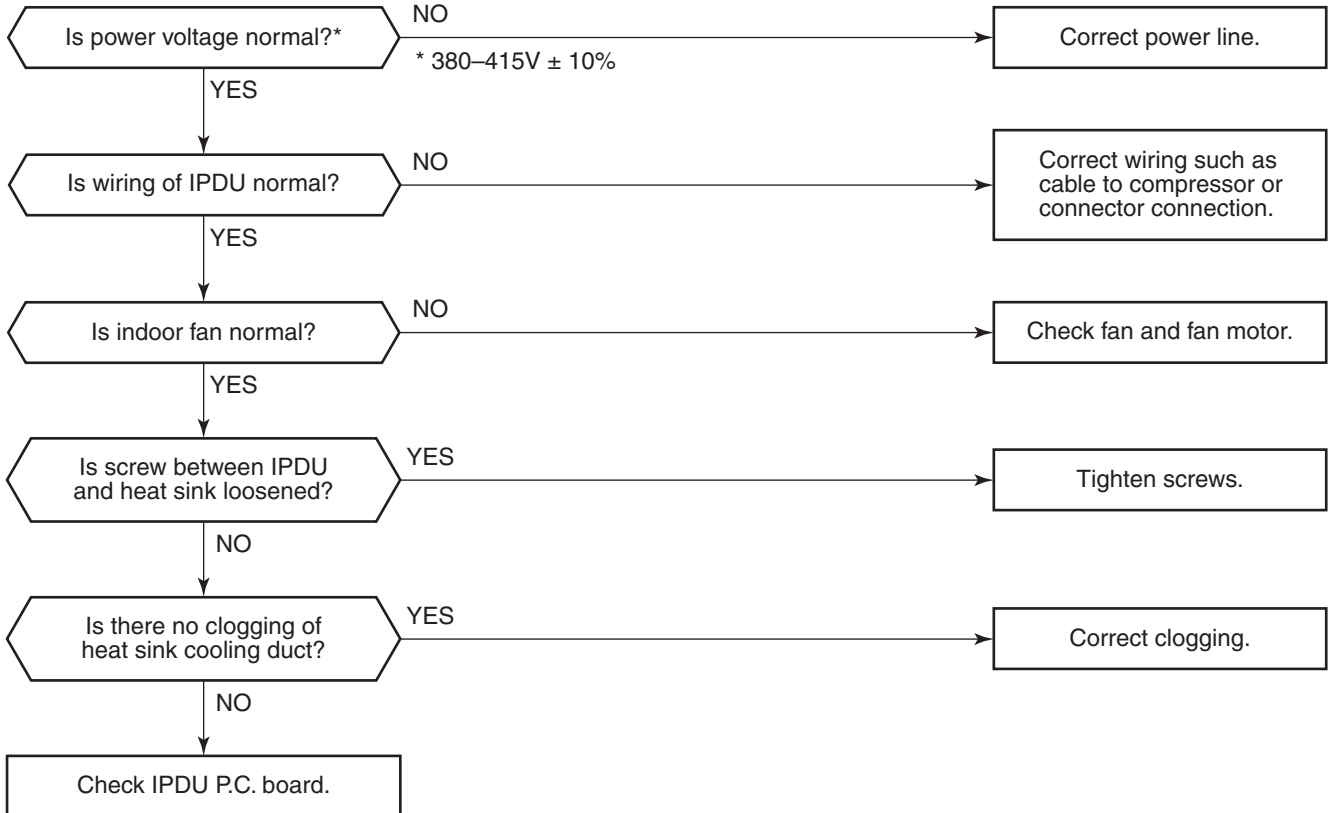

Check code	Check code name	Cause of operation
[P12] / [11] (Current code / AI-NET)	Indoor fan motor error	1. Fan motor connector error 2. Fan motor error 3. Indoor P.C. board error 4. Cross-flow fan bearing error

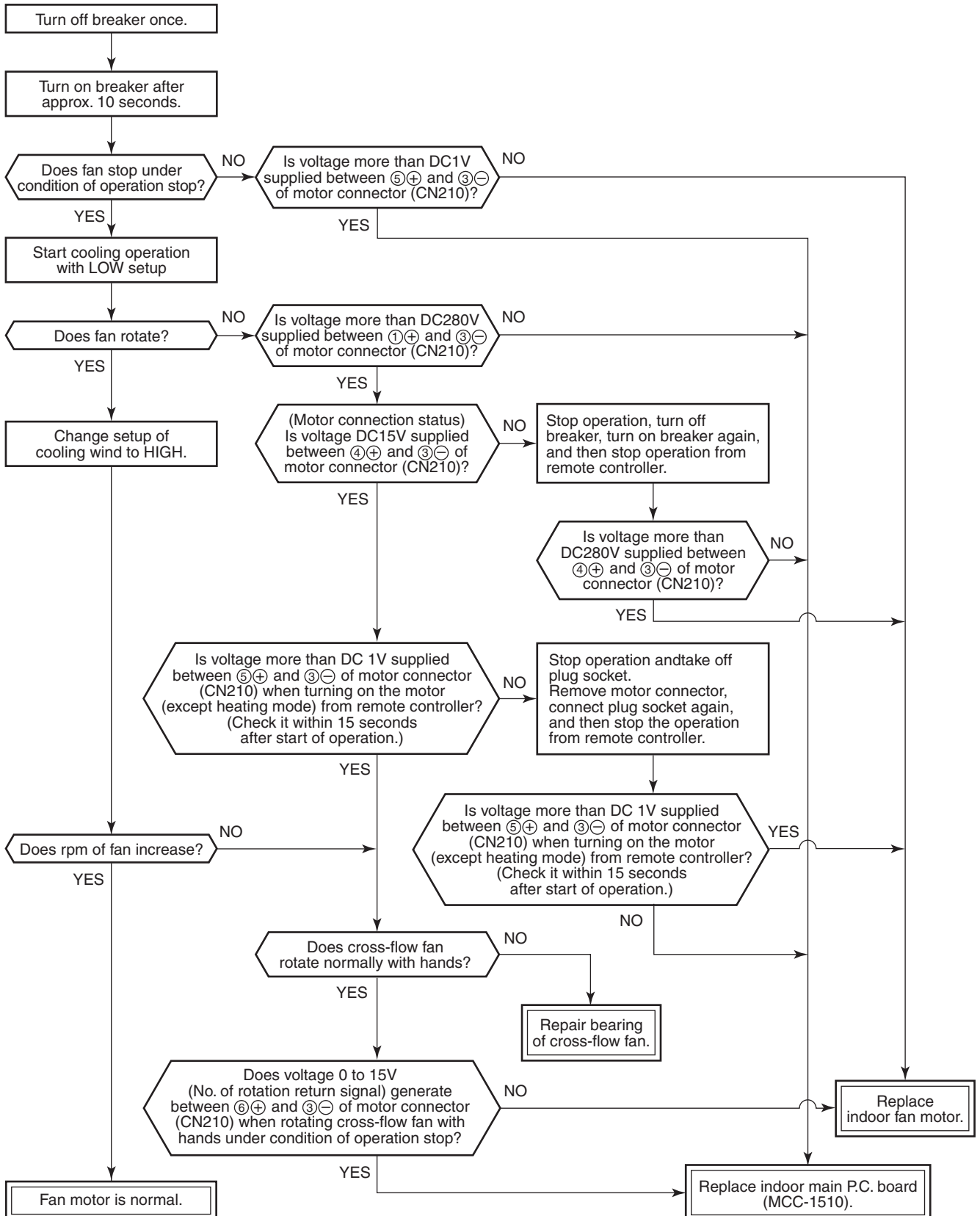

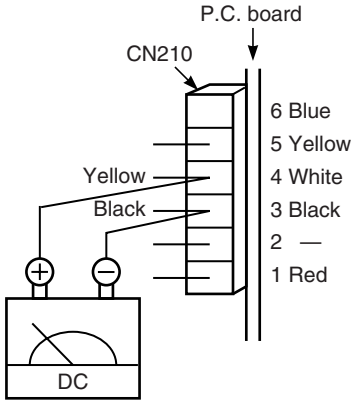
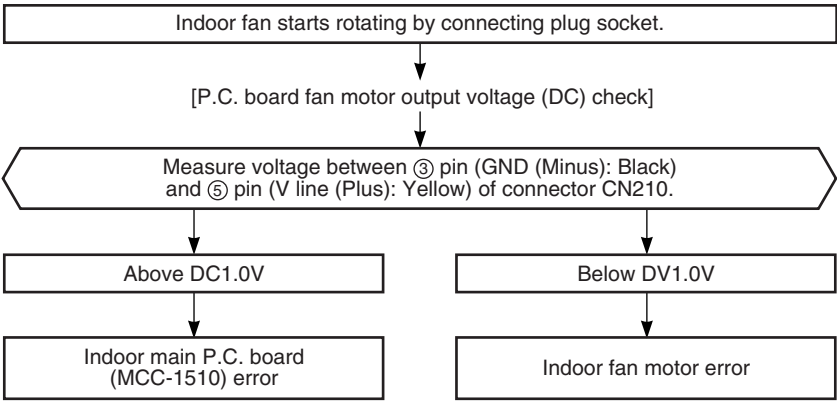

Check code	Check code name	Cause of operation
[P13] / [47] (Current code / AI-NET)	Outdoor liquid back detection error	1. PMV1/PMV2 error 2. Pd sensor, Ps sensor error 3. Clogging of SV2 circuit 4. Clogging of SV3B circuit, balance pipe 5. Leakage of main discharge pipe 6. Outdoor I/F P.C. board error

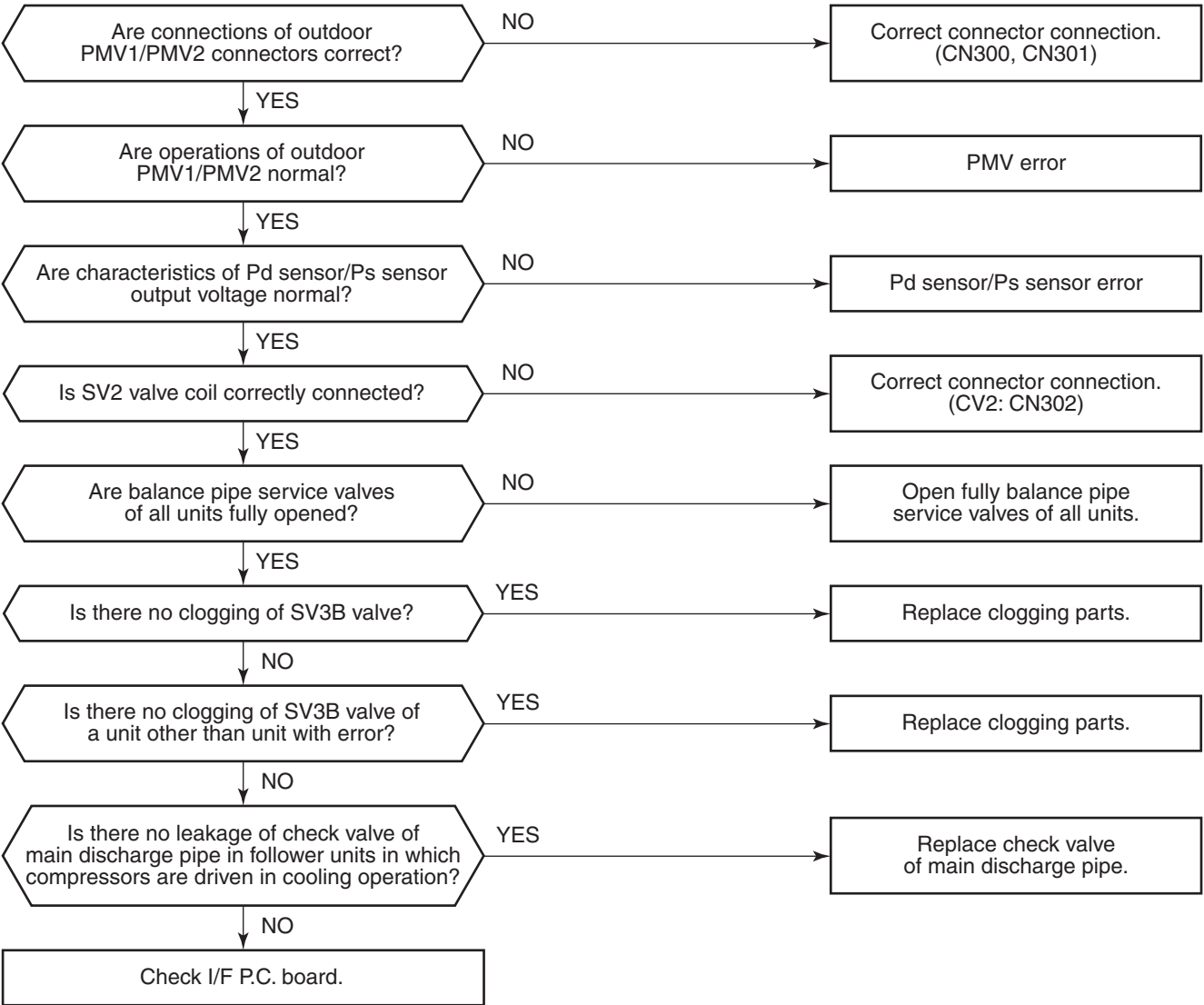

Check code	Check code name	Cause of operation
[P15] / [AE] (Current code / AI-NET)	Gas leak detection TS condition (Sub-code: 01)	1. Outdoor unit service valve closed 2. Outdoor PMV error 3. TS1 sensor error 4. Refrigerant shortage, clogging refrigerant circuit 5. 4-way valve error 6. SV4 circuit error

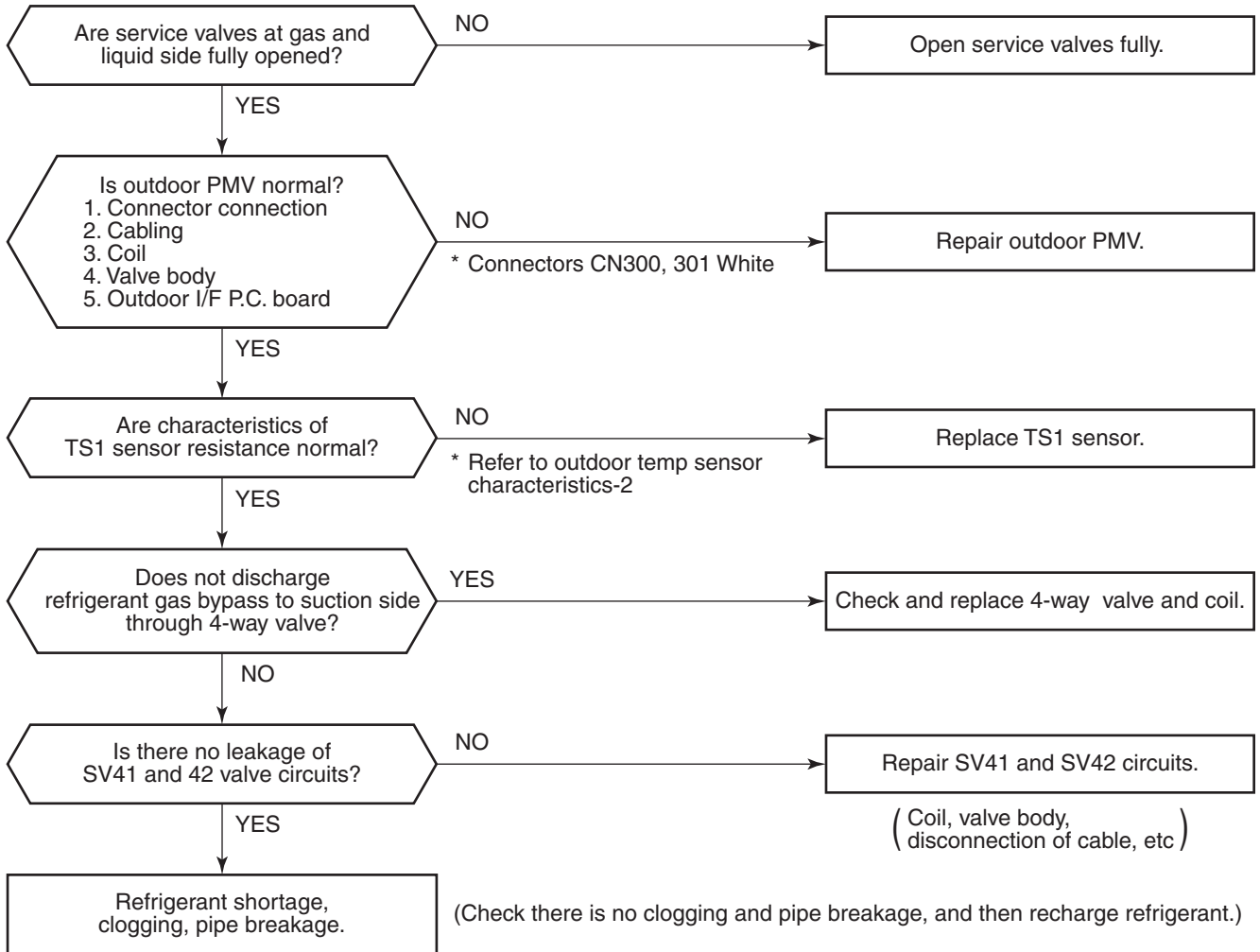

Check code	Check code name	Cause of operation
[P15] / [AE] (Current code / AI-NET)	Gas leak detection TD condition (Sub-code: 02)	1. Outdoor unit service valve closed 2. Outdoor PMV error 3. TD sensor error 4. SV4 circuit error 5. Refrigerant shortage, clogging refrigerant circuit

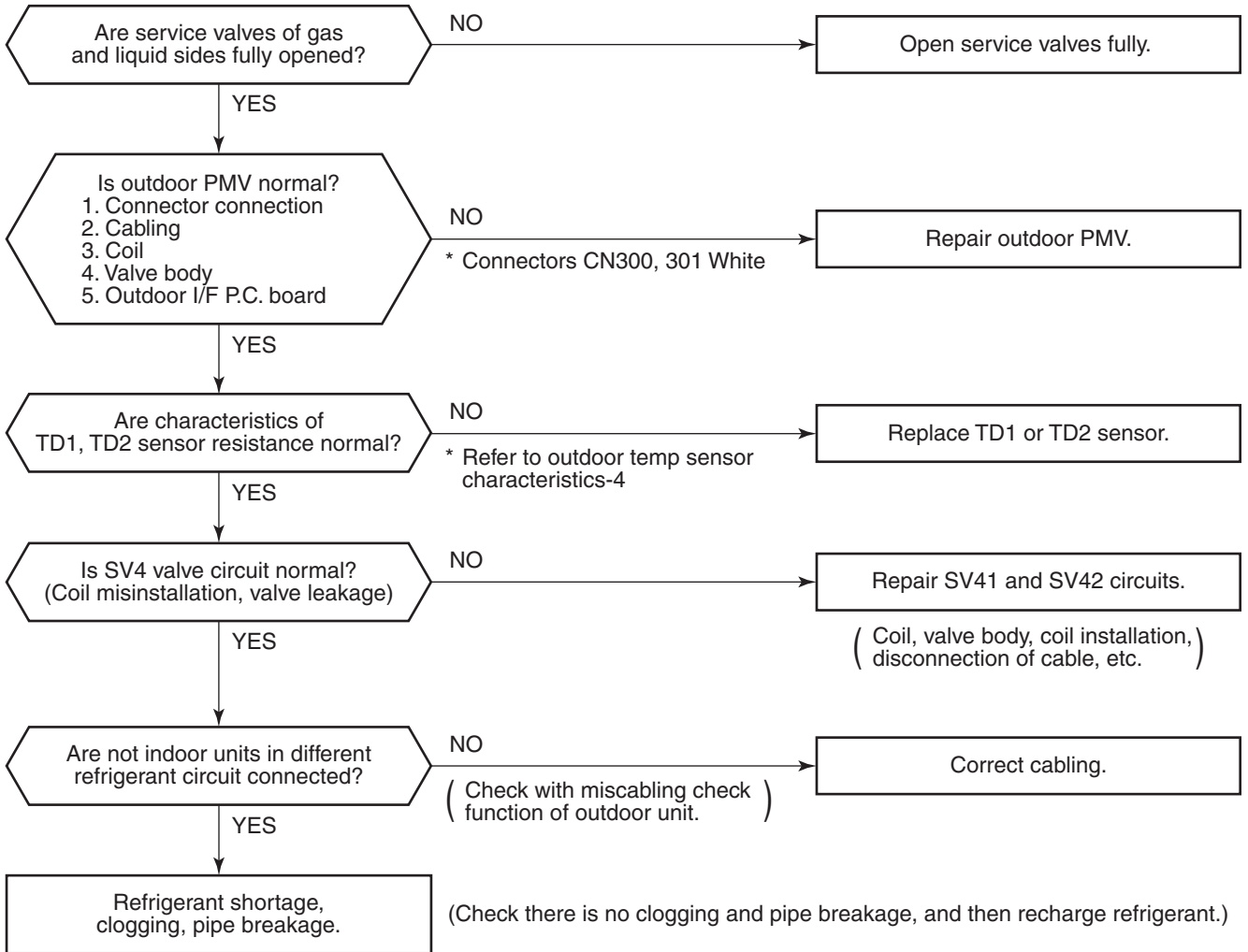

Check code	Check code name	Cause of operation
[P17] / [bb] (Current code / AI-NET)	Discharge temp TD2 error	1. Outdoor unit service valve closed 2. Outdoor PMV error 3. TD sensor error 4. Refrigerant shortage, clogging of refrigerant circuit 5. 4-way valve error 6. SV4 circuit leakage, misinstallation

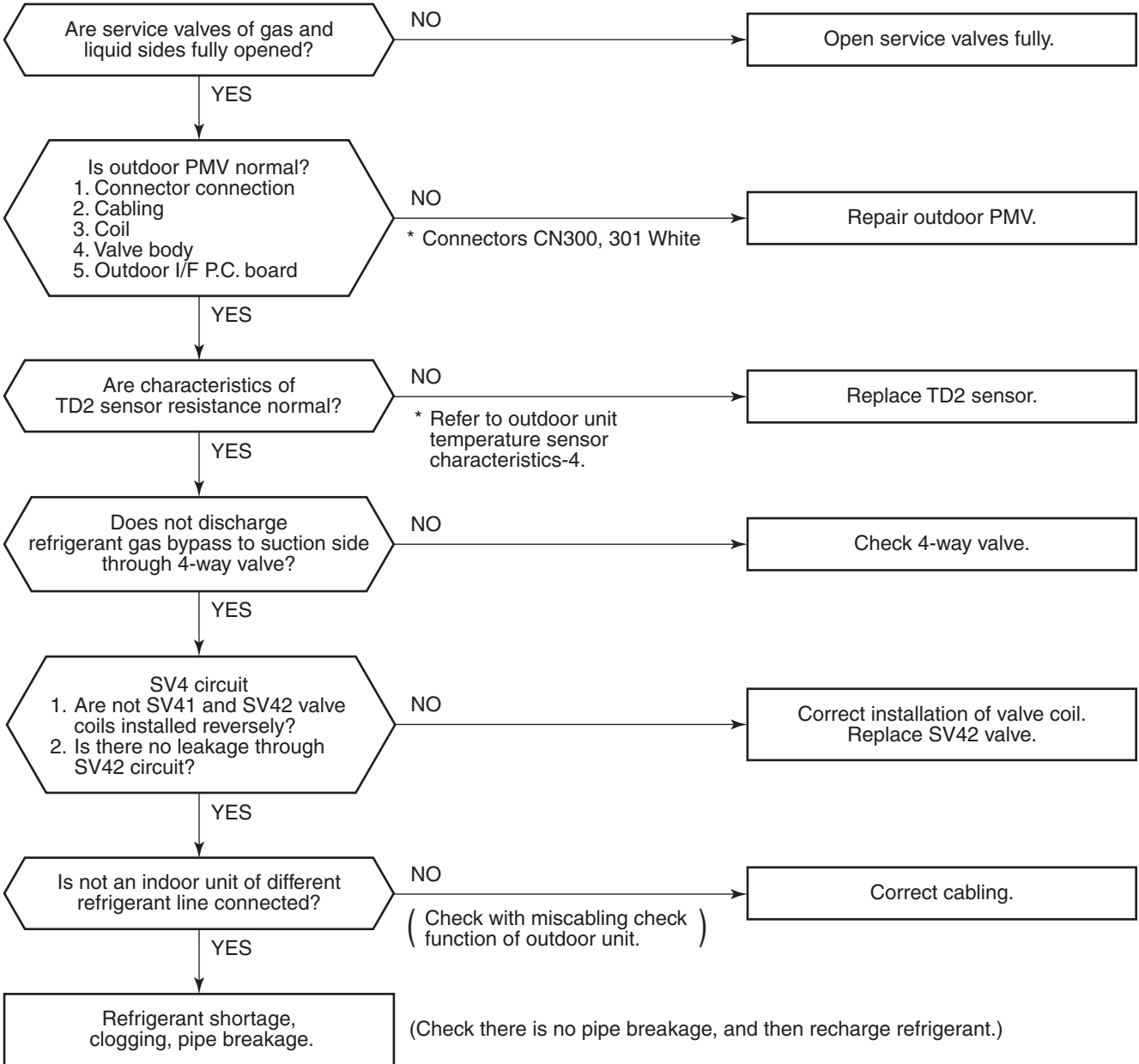

Check code	Check code name	Cause of operation
[P19] / [08] (Current code / AI-NET)	4-way valve operation error	1. 4-way valve error 2. TS1 sensor/TE1 sensor error 3. Pd sensor/Ps sensor error 4. TE sensor/TL sensor misconnection

Sub-code: Detected outdoor unit No.

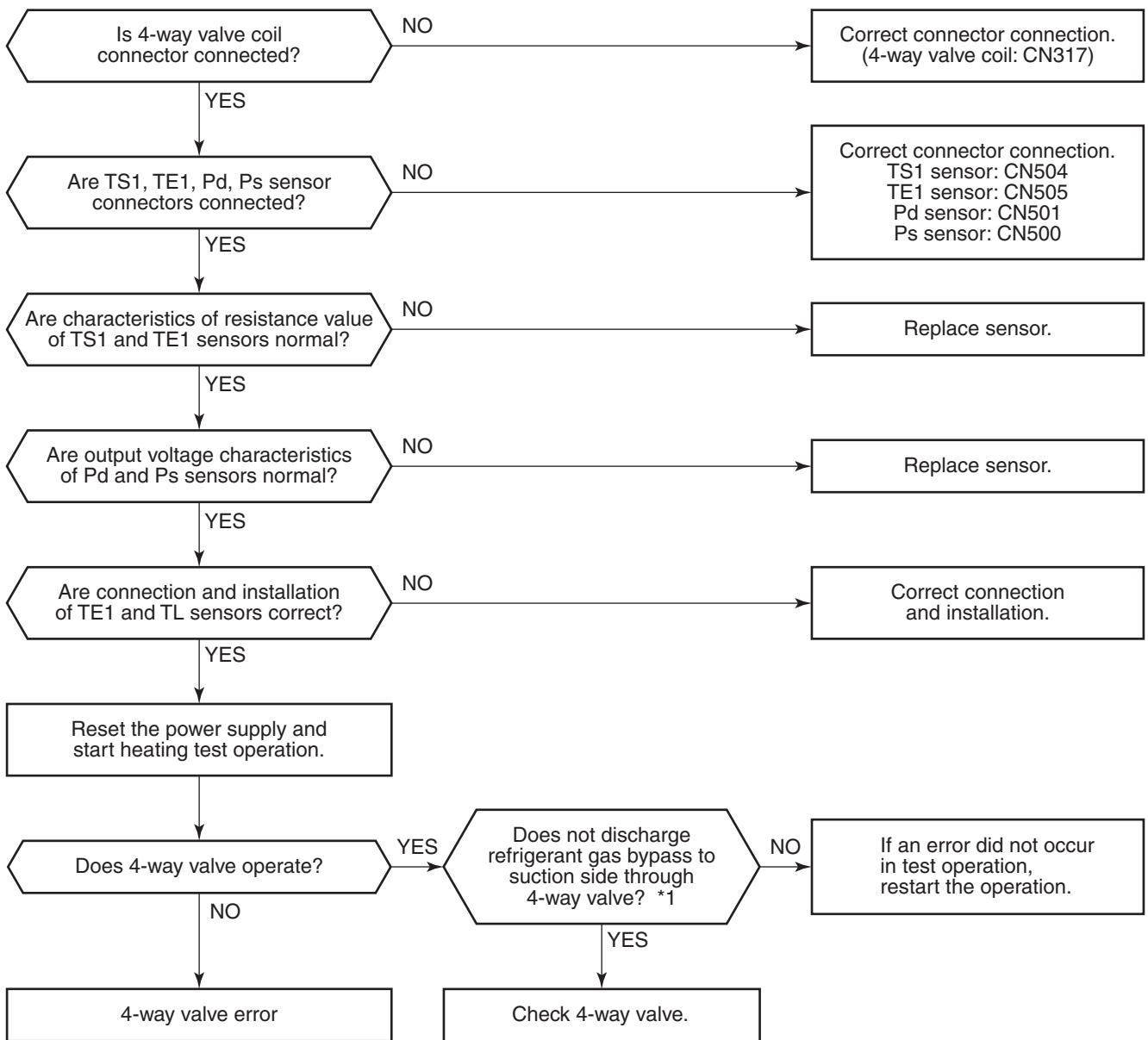

*1 Check TS and TE temperature of the outdoor unit which compressors is operated.
 (I/F) SW01=[1], SW02=[6], SW03=[2] → TS sensor temperature
 SW01=[1], SW02=[7], SW03=[2] → TE sensor temperature

<Judgment criteria>
 TE sensor: Normal if TE ≤ 20°C except summer season (Outside temp 20°C or lower)
 TS sensor: Normal if TS ≤ 40°C except summer season (Outside temp 20°C or lower)

Check code	Check code name	Cause of operation
[P20] / [22] (Current code / AI-NET)	High-pressure protective operation	1. Pd sensor error 2. Service valve closed. 3. Indoor/outdoor fan error 4. Indoor/outdoor PMV clogging 5. Indoor/outdoor heat exchanger clogging 6. SV2 circuit error 7. SV4 circuit error 8. SV5 circuit error 9. Outdoor I/F P.C. board error 10. Operation error of check valve of main discharge pipe 11. Refrigerant overcharge

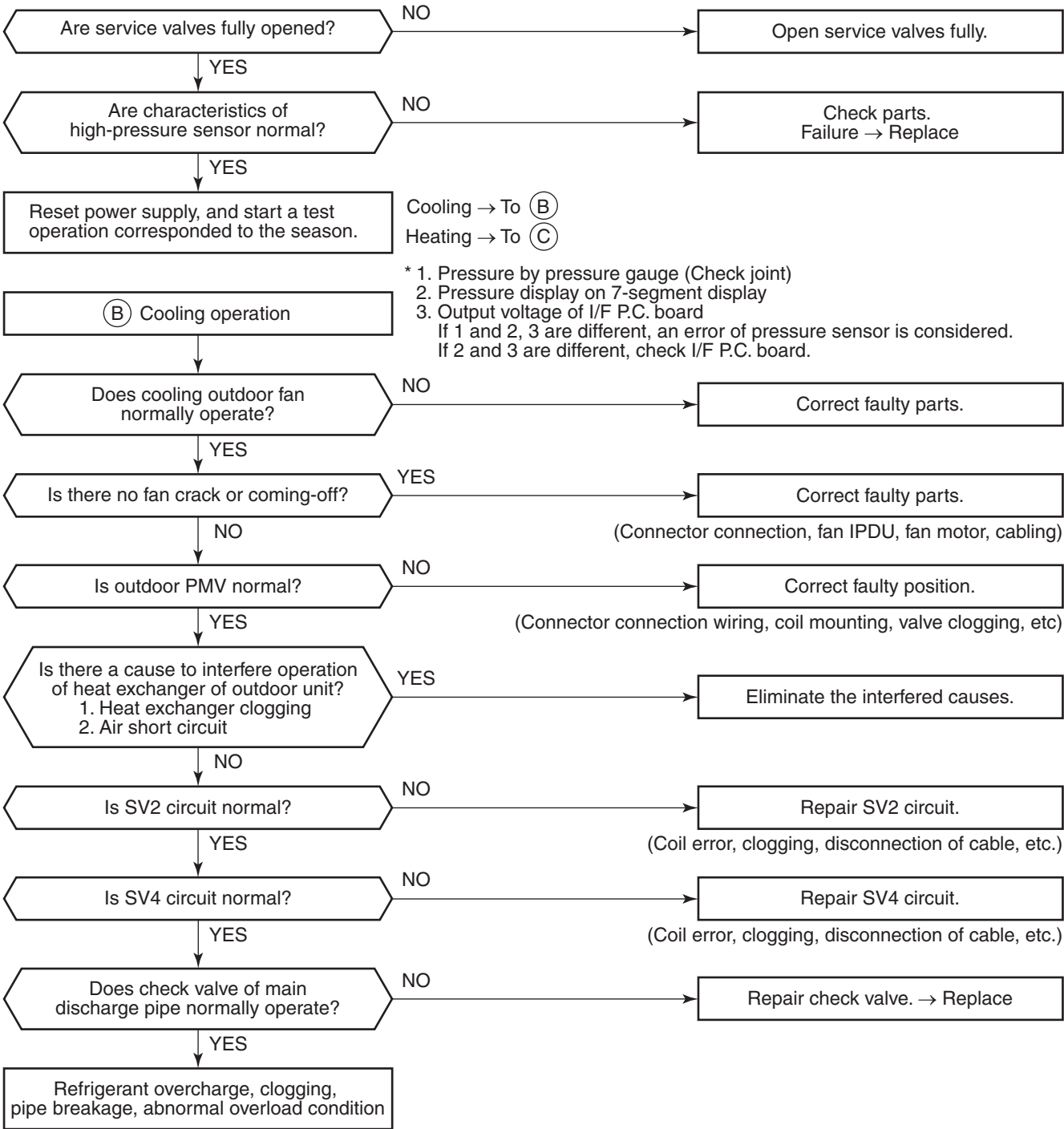

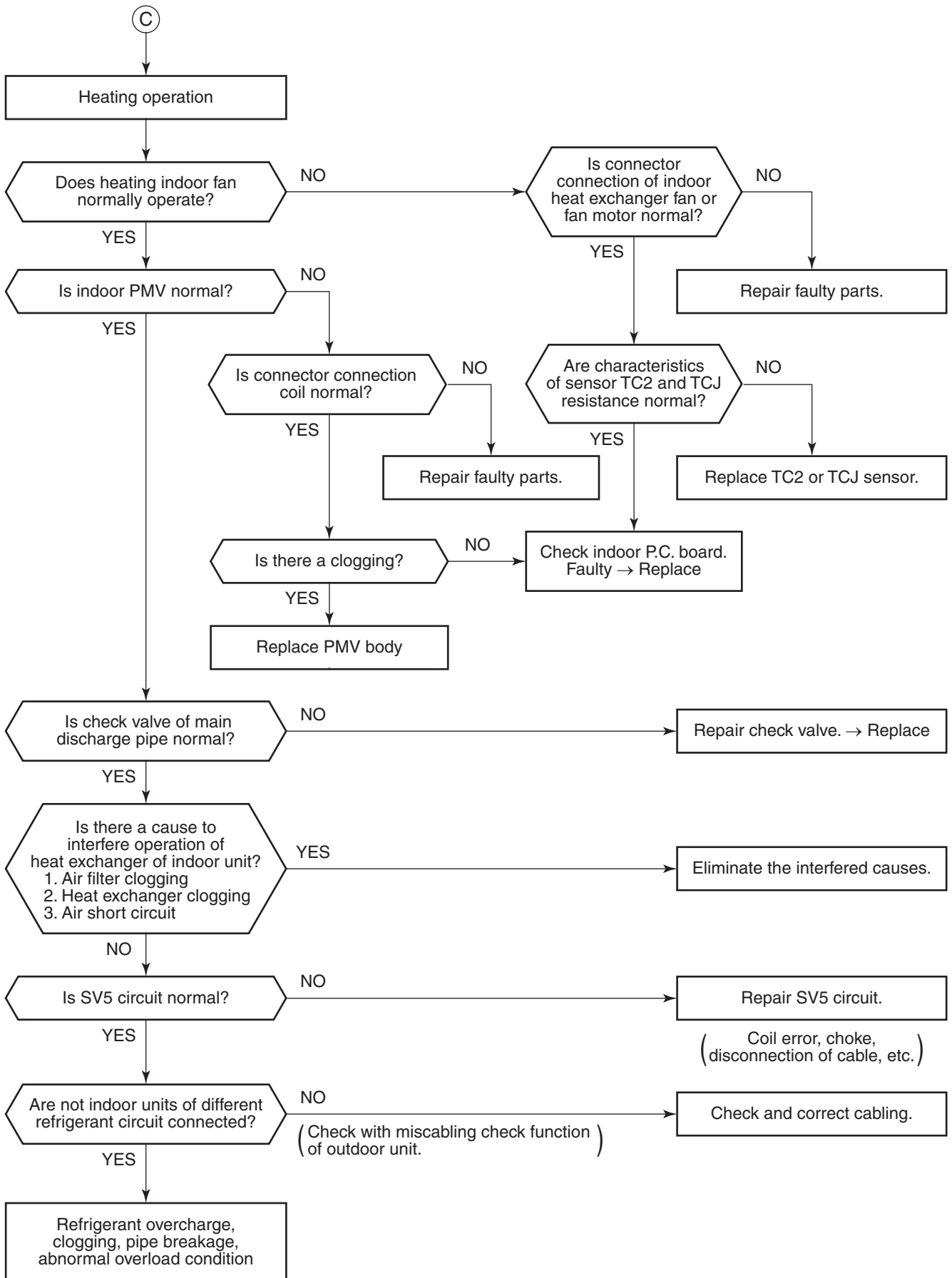

Check code	Check code name	Cause of operation
[P22] / [1A] (Current code / AI-NET)	Outdoor fan IPDU error	1. Fan lock 2. Fan IPDU P.C. board error 3. Overload cause 4. External cause such as blast 5. Fan IPDU power P.C. board error

Sub-code:

0 * : IGBT short circuit	1 * : Position detect circuit error
3 * : Motor lock error	4 * : Motor current error detected
C * : TH sensor error (Heat sink overheat)	D * : TH sensor error
E * : Vdc error	

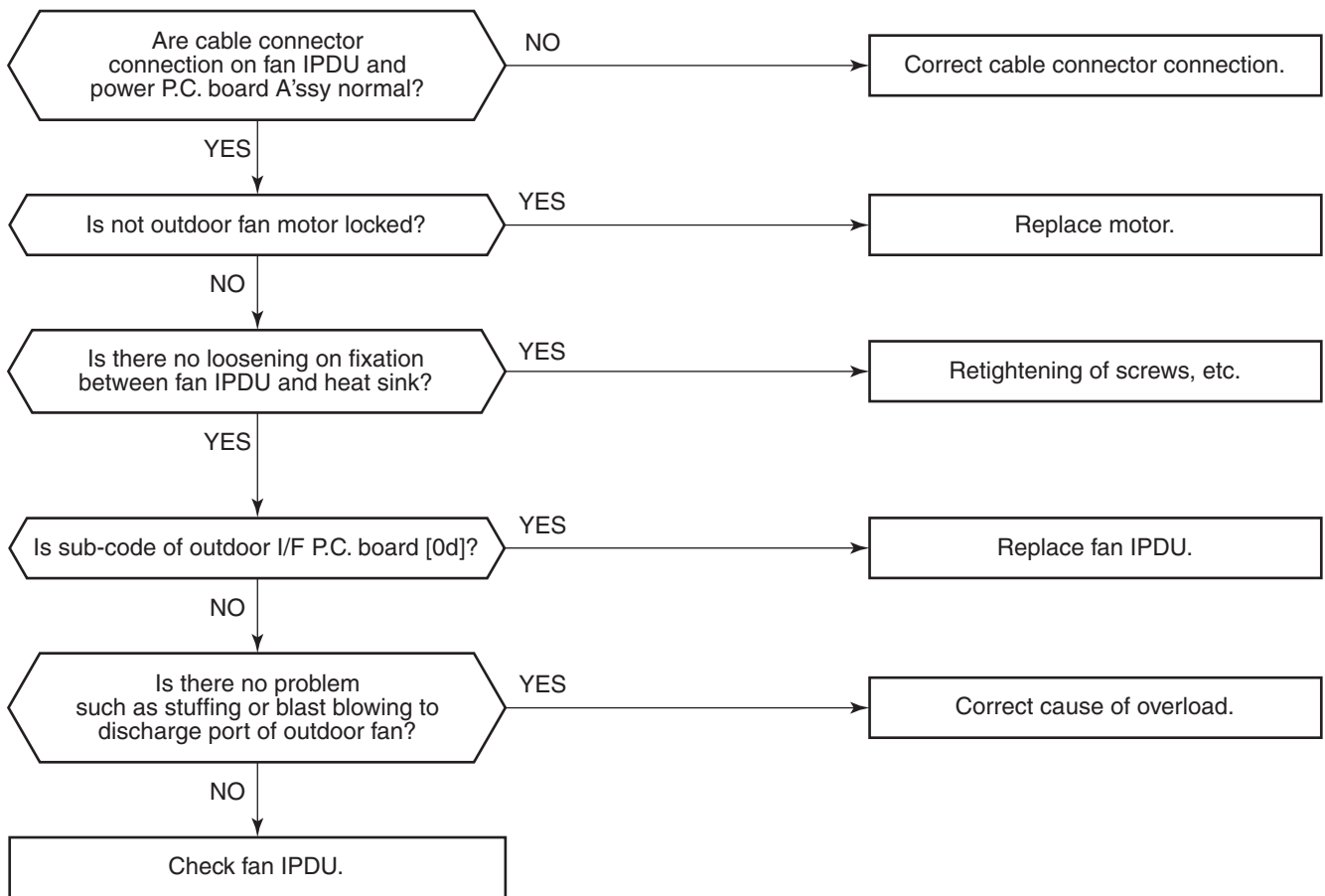

Check code	Check code name	Cause of operation
[P26] / [14] (Current code / AI-NET)	G-Tr short-circuit protection error	1. Outdoor unit power error 2. IPDU error/Cable connection error 3. Compressor error 4. IPDU P.C. board error

Sub-code: 01: Compressor 1 side 02: Compressor 2 side

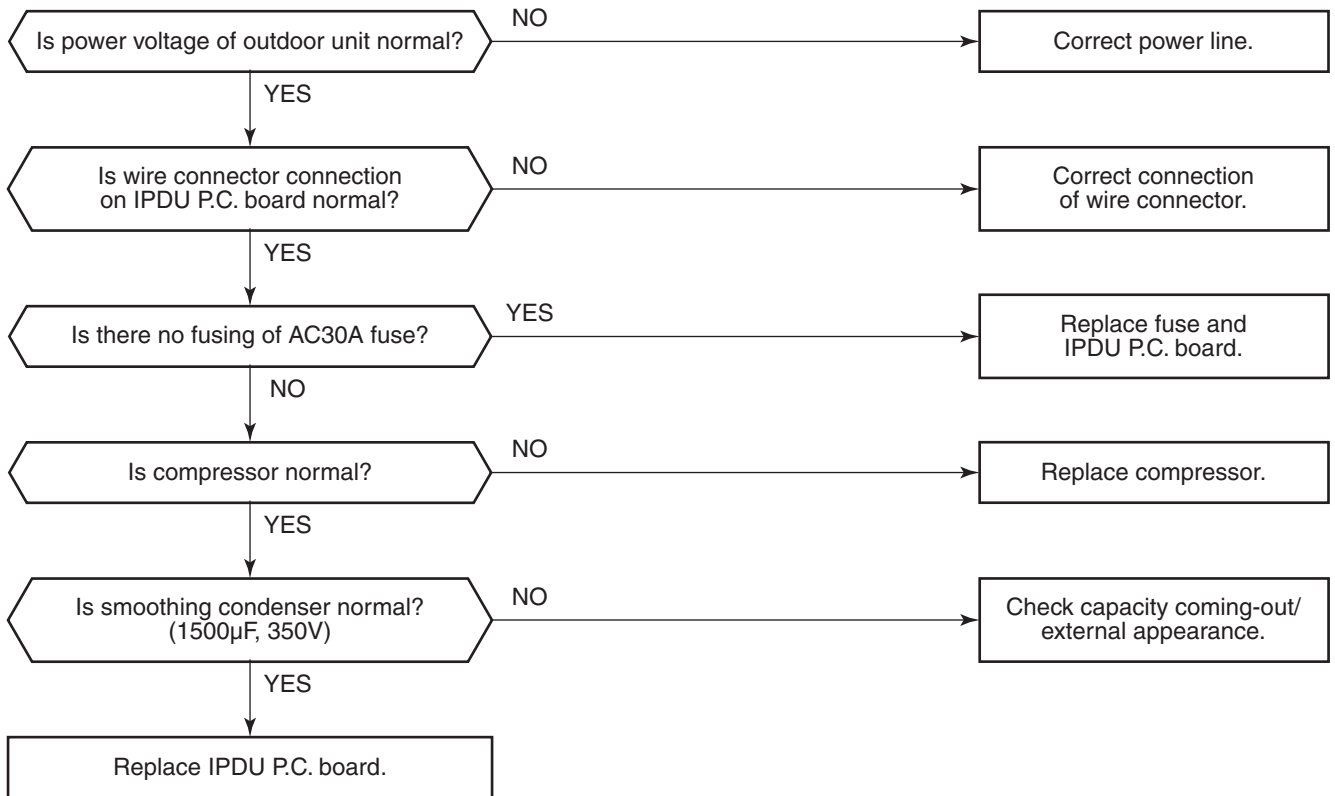

Check code	Check code name	Cause of operation
[P29] / [16] (Current code / AI-NET)	Compressor position detective circuit error	1. Cable/connector connection error 2. Compressor error 3. IPDU P.C. board error

Sub-code: 01: Compressor 1 side 02: Compressor 2 side

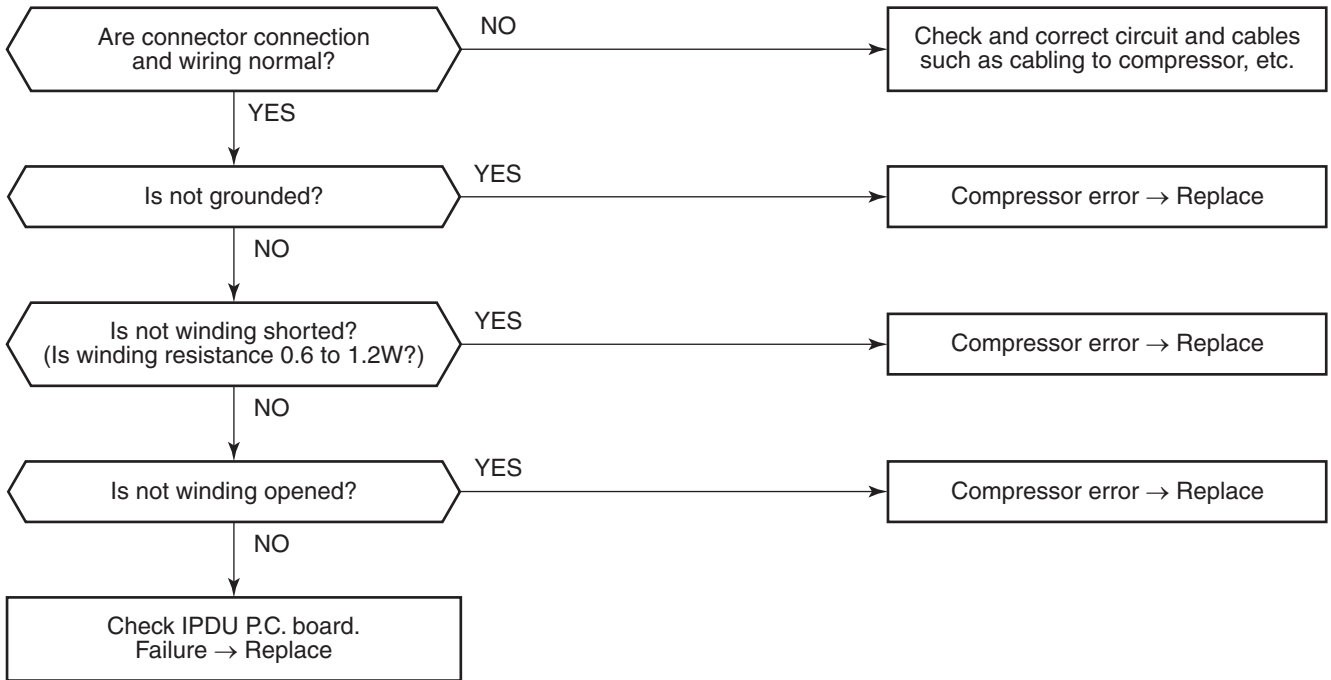

Check code	Check code name	Cause of operation
[P31] / [47] (Current code / AI-NET)	Other indoor error (Group follower unit error)	Other indoor unit in the group is abnormal.

When the header unit of the group detected [E03, L03, L07, L08 error], the follower unit of the group displays [P31] error and stops. There are no check code display and alarm record of the main remote controller.

Check code	Check code name	Cause of operation
[-] / [97] (Current code / AI-NET)	AI-NET communication line error	AI-NET communication line error

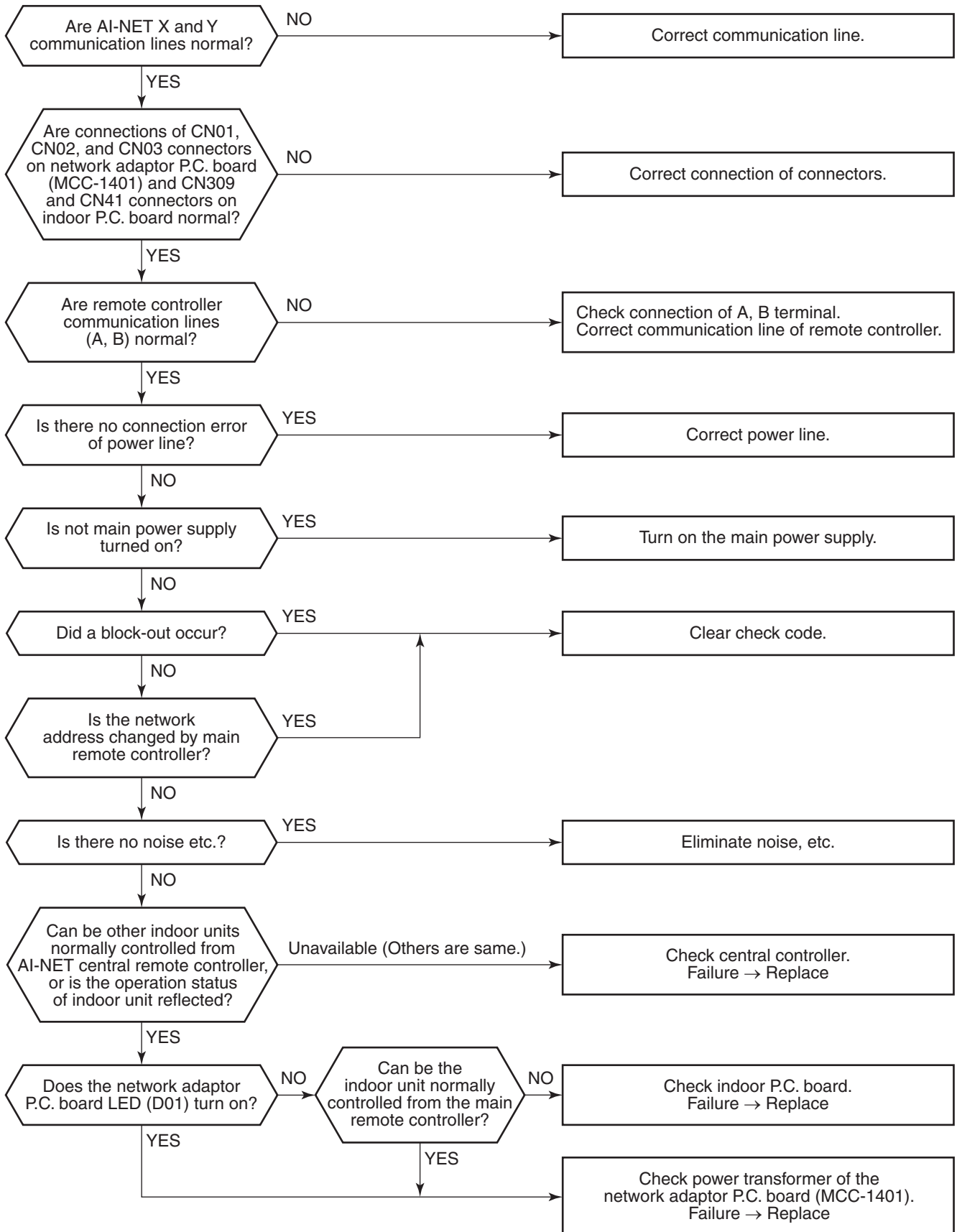

7-5-1. Indoor Unit

■ Temperature sensor characteristics

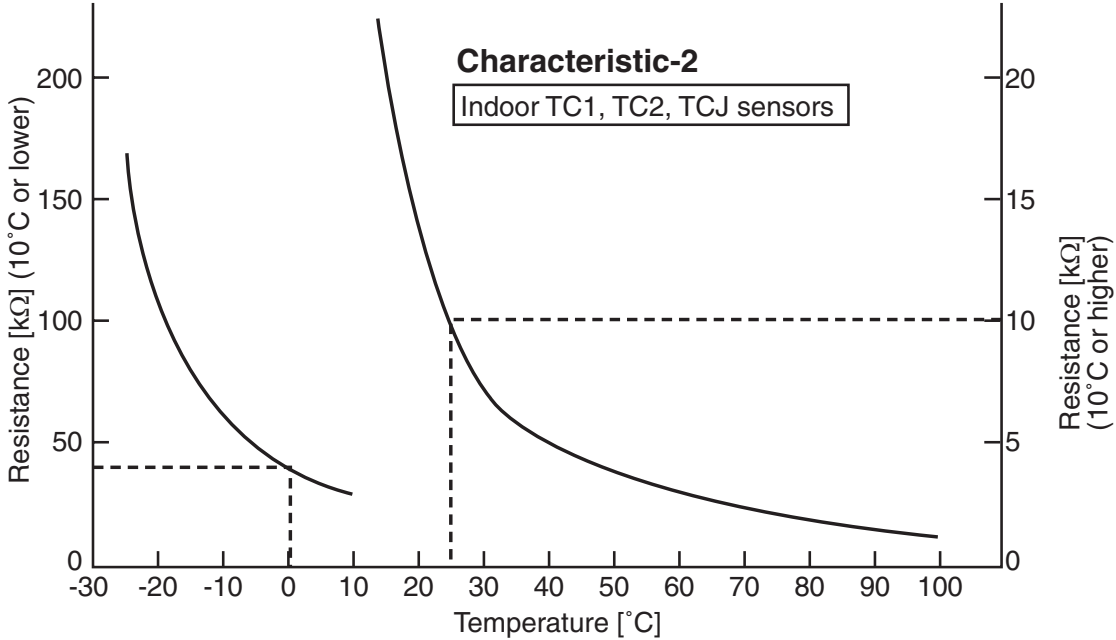
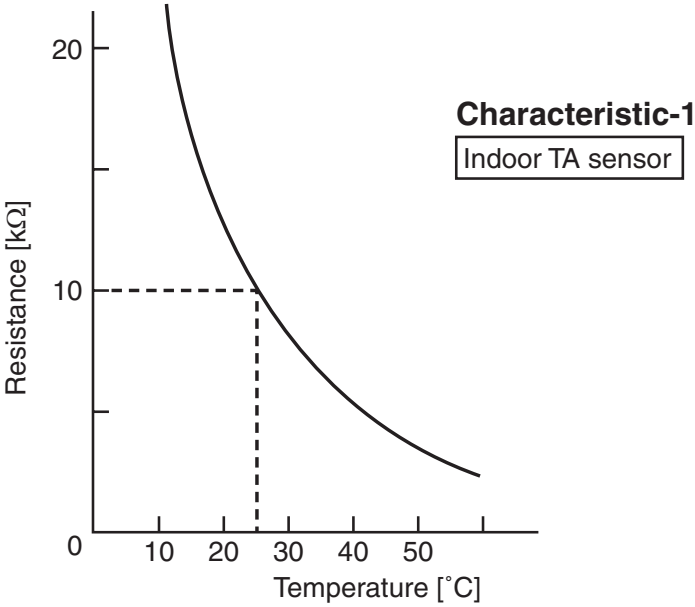

8. CONFIGURATION OF CONTROL CIRCUIT

8-1. Indoor Controller Block Diagram

8-1-1. Case of Main (Sub) Remote Controller Connected

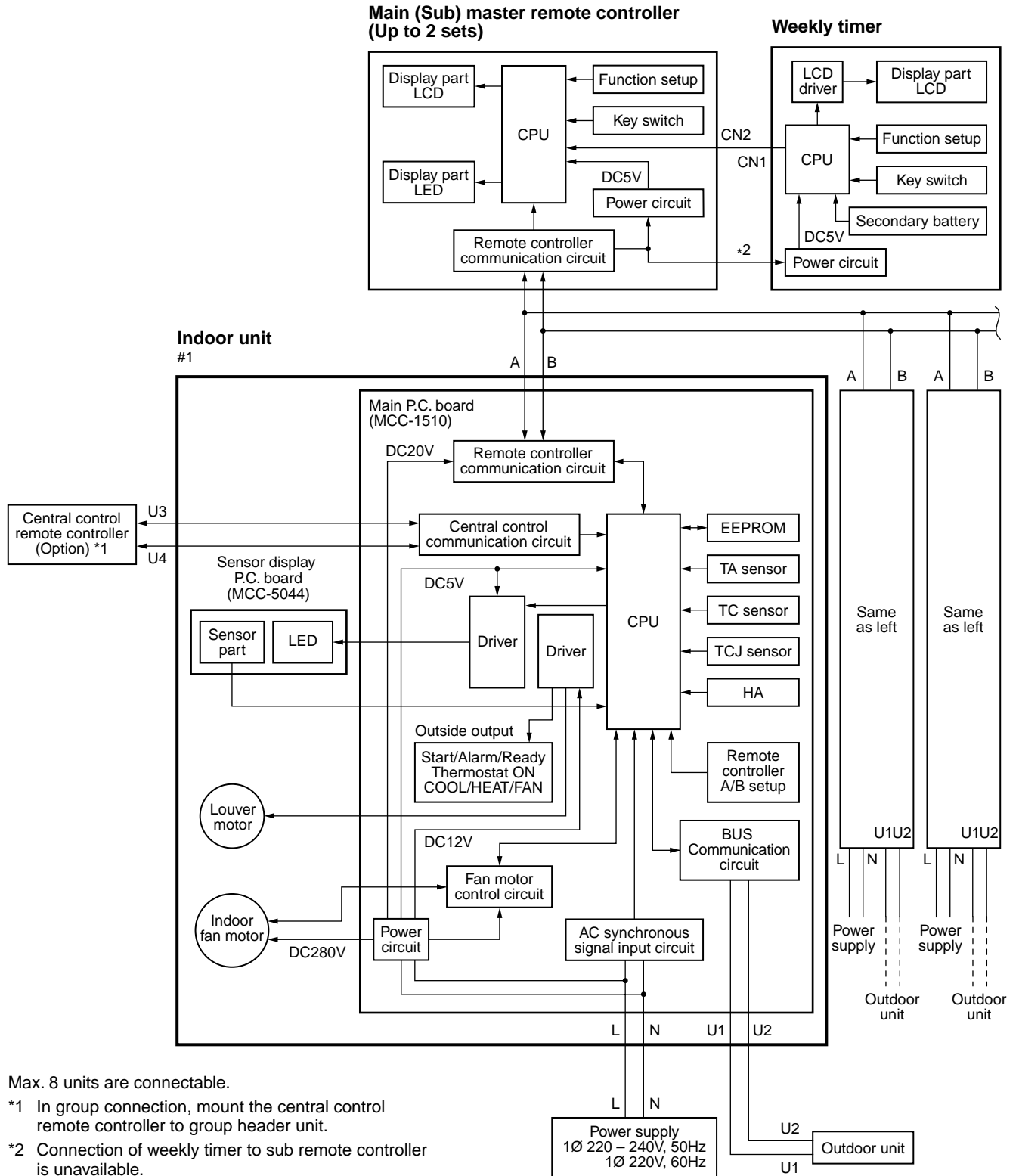

8-1-2. Case of Wireless Remote Controller Kit Connected

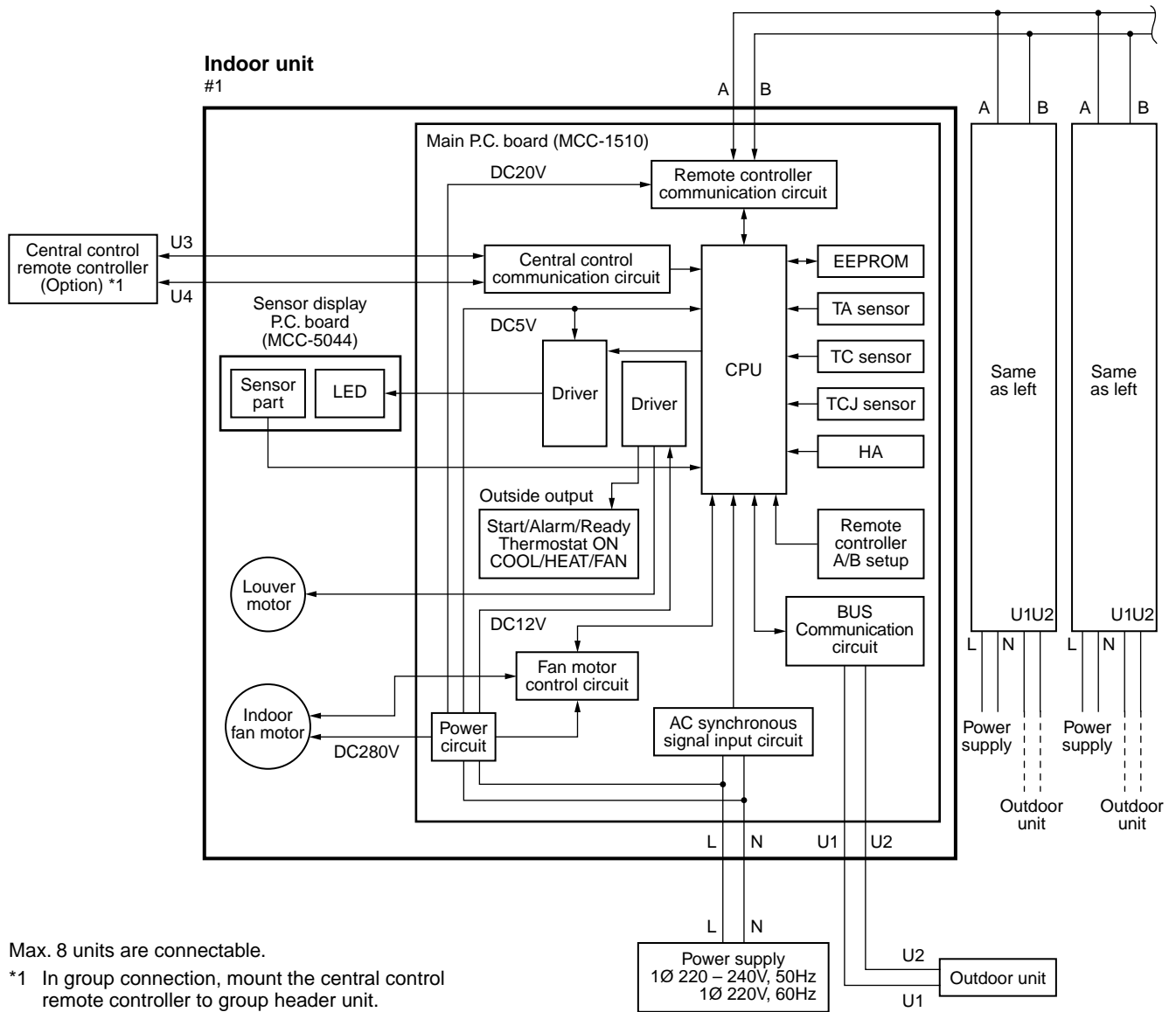

Max. 8 units are connectable.



*1 In group connection, mount the central control remote controller to group header unit.

9. HOW TO REPLACE MAIN PARTS

WARNING

- Since high voltages pass through the electrical parts, turn off the power without fail before proceeding with the repairs.
Electric shocks may occur if the main power supply switch or breakers are not turned off.
 - After the repairs have been completed (after the front panel and cabinet have been installed), perform a test run, and check for smoking, unusual sounds and other abnormalities.
If this check is omitted, a fire and/or electric shocks may occur.
Before proceeding with the test run, install the front panel and cabinet.
 - Ensure that the following steps are taken when doing repairs on the refrigerating cycle.
 1. Do not allow any naked flames in the surrounding area.
If a gas stove or other appliance is being used, extinguish the flames before proceeding.
If the flames are not extinguished, they may ignite any oil mixed with the refrigerant gas.
 2. Do not use welding equipment in an airtight room.
Carbon monoxide poisoning may result if the room is not properly ventilated.
 3. Do not bring welding equipment near flammable objects.
Flames from the equipment may cause the flammable objects to catch fire.
 - **If keeping the power on is absolutely unavoidable while doing a job such as inspecting the circuitry, wear rubber gloves to avoid contact with the live parts.**
Electric shocks may be received if the live parts are touched.
High-voltage circuits are contained inside this unit.
Proceed very carefully when conducting checks since directly touching the parts on the control circuit board may result in electric shocks.
-

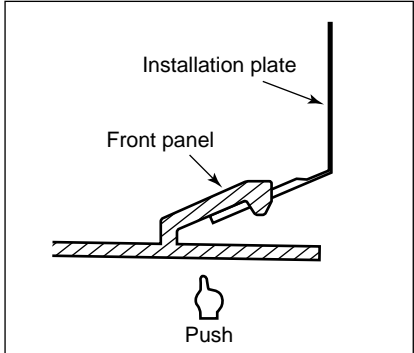
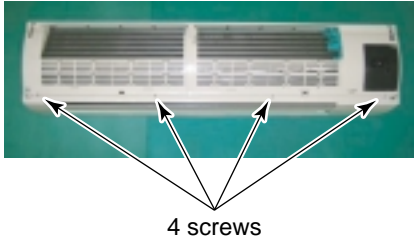
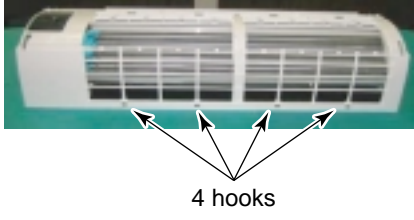
9-1. Indoor Unit

No.	Part name	Procedures	Remarks
①	Front panel	<p>1) Stop operation of the air conditioner and turn off its main power supply.</p> <p>2) Open the air inlet grille, push the arm toward the outside, and remove the grille.</p> <p>3) Push "PUSH" part under the front panel and remove hooks of the front panel from the installation plate.</p> <p>4) Remove the front panel fixing screws. (4 pcs.)</p> <p>5) Take off 4 hooks of panel from rear side.</p> <p><How to assemble the front panel></p> <p>1) Push 3 center positions and 2 lower center positions of the air outlet, and then hang the hanging hooks (4 pcs.) at the top side of the front panel to the rear plate.</p> <p>2) Tighten four screws.</p> <ul style="list-style-type: none"> • Incomplete hanging or incomplete pushing may cause a dewdrops or generation of a fluttering sound. 	    

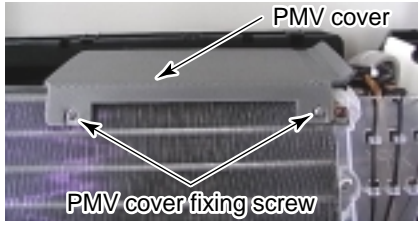
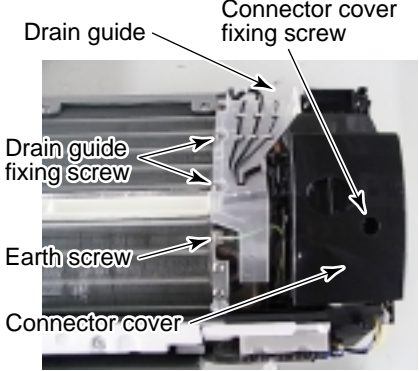
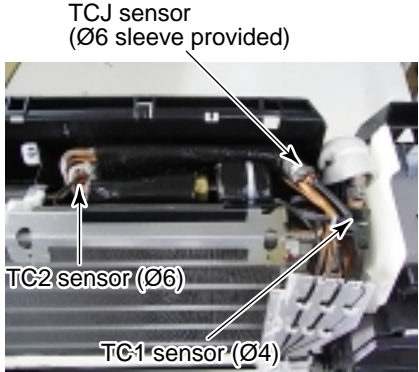
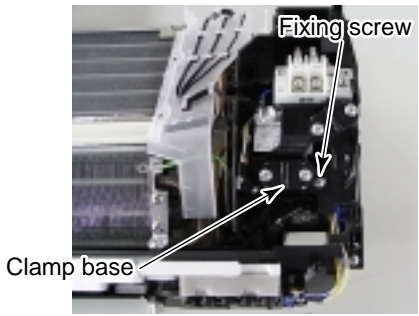
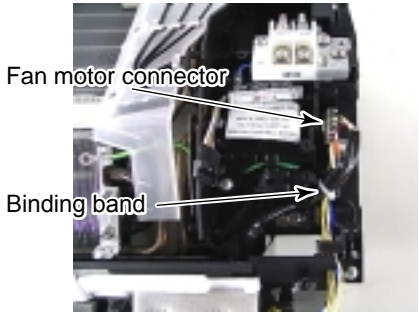
No.	Part name	Procedures	Remarks
②	Electric parts assembly	<p>1) Perform work of item ① .</p> <p>2) Take off PMV cover fixing screws (2 pcs.) and then remove PMV cover.</p> <p>3) Take off drain guide fixing screws (2 pcs.) and then remove the drain guide.</p> <p>4) Take off earth screw (1 pc.) fixed to the end plate.</p> <p>5) Pull out TC1, TC2 and TCJ sensors from the sensor holder of the heat exchanger. (When reassembling the electric parts, be careful to the attaching positions of every sensor. TC2 and TCJ sensors resemble in the shapes, so distinct them by marking, etc. when mounting them.)</p> <p>6) Take off the connector cover mounting screw (1 pc.) and then remove the connector cover.</p> <p>7) Take off the clamp base mounting screw (1 pc.) and then remove the clamp base.</p> <p>8) Remove the binding band and then remove the fan motor connector (5P), the connector (5P) for louver motor (When mounting the P.C. board, fix the lead wires again by the binding band.) Tighten the binding band at the same position before removing.)</p> <p>9) Disengage the display unit by simply pushing at the top of the display unit.</p> <p>10) Remove the fixing screw that secures the electric parts box assembly, LED assembly and remove the assembly.</p> <p>Same as reassembly pace Addition of the following cautions</p> <p><Cautions in reassembling> Mount the electric parts box to the main unit in the reverse order to the removing procedure. Determine the sensor positions and lead wire drawing as same as those before removing according to the figure.</p>	    

No.	Part name	Procedures	Remarks
③	Horizontal louver	1) Remove shaft of the horizontal louver from the back body. (First remove the left shaft, and then remove other shafts while sliding the horizontal louver leftward.)	

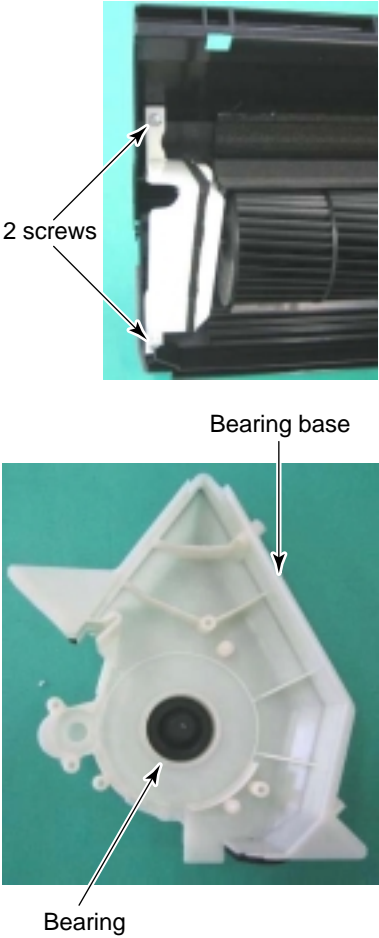
No.	Part name	Procedures	Remarks
⑤	Bearing	<p>1) Follow to the procedure in the item ③.</p> <p>2) Remove the 2 screws used to secure the bearing base.</p> <p>3) Remove the bearing base.</p> <p><Caution at assembling></p> <ul style="list-style-type: none">• If the bearing is out from the housing, push it into the specified position and then incorporate it in the main body.	 <p>2 screws</p> <p>Bearing base</p> <p>Bearing</p>

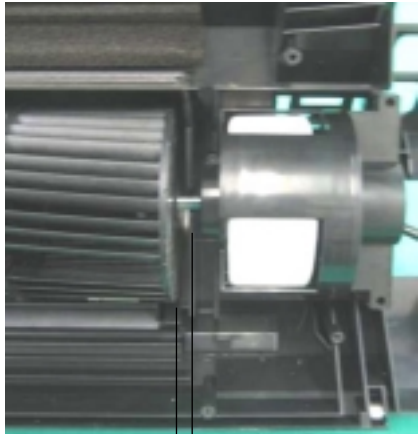
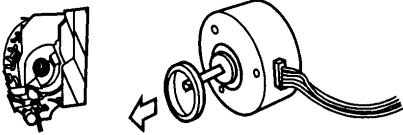
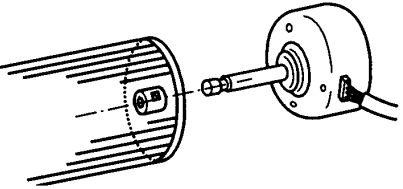
No.	Part name	Procedures	Remarks
⑦	Cross flow fan	<p><Caution at reassembling></p> <p>1) To incorporate the fan motor, remove the fan motor rubber (at shaft core side), incorporate the motor into the position in the following figure, and then install the fan motor.</p> <ul style="list-style-type: none"> • Install the cross flow fan so that the right end of the 1st joint from the right of the cross flow fan is set keeping 5 mm from wall of rear plate of the main unit. • Holding the set screw, install the cross flow fan so that U-groove of the fan motor comes to the mounting hole of the set screw. • Perform positioning of the fan motor as follows: • When assembling the fan motor, the fan motor must be installed in such a way that the fan motor leads will be taken out is positioned at the bottom front. • After assembling the 2 fixing screws of the motor band (right) into the main body, position the fan motor, insert it, and then secure the motor band (right) using the 2 fixing screws. 	 <p style="text-align: center;">5.0mm</p>  

10. REPLACEMENT OF SERVICE INDOOR P.C. BOARD

Model type	P.C. board model	Label display on P.C. board
MMK-AP *** 3HP1 series	MCC-1510	04DD M13S

[Requirement when replacing the service indoor P.C. board assembly]

In the non-volatile memory (Hereinafter said EEPROM, IC10) installed on the indoor P.C. board before replacement, the type and capacity code exclusive to the corresponding model have been stored at shipment from the factory and the important setup data such as refrigerant line /indoor unit /group address in (AUTO/MANUAL) mode have been stored at installation.

Replace the service indoor P.C. board assembly according to the following procedure.

After replacement, make sure that the indoor unit address is set correctly and also the refrigerant cycle is working correctly by test operation.

<Replacement procedure>

CASE 1

Before replacement, power of the indoor unit can be turned on and the setup data can be readout by the wired remote controller.

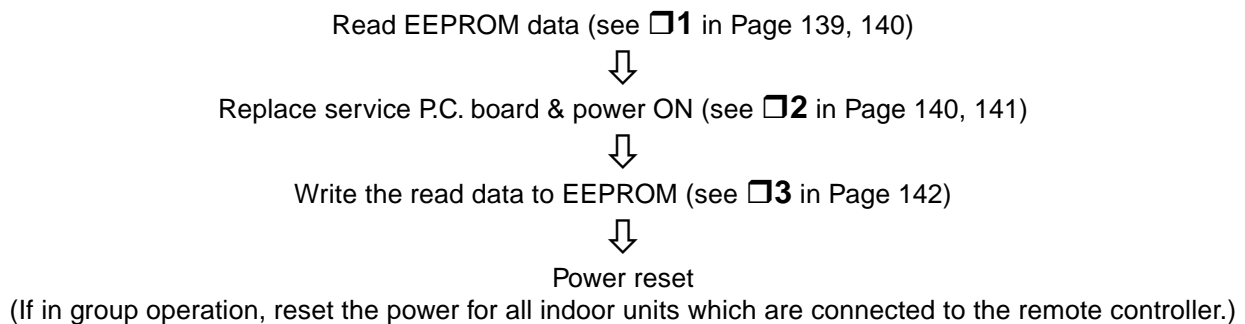

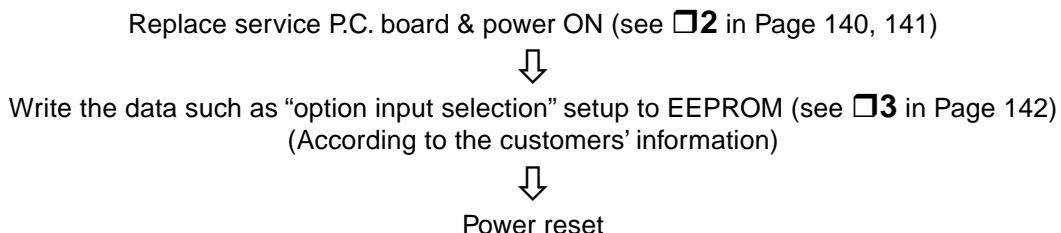

CASE 2

Before replacement, the setup data can not be read out by the wired remote controller.



□1 Readout of the setup data from EEPROM

(Data in EEPROM contents, which have been changed at the local site, are read out together with data in EEPROM set at shipment from the factory.)

1. Push ,  and  buttons of the remote controller at the same time for 4 seconds or more. **1**
(Corresponded with No. in Remote controller as shown below picture)

* When group operation, the header indoor unit address is displayed at the first time. In this time, the CODE No. (DN)  is displayed. The fan of the second indoor unit operates and the flap starts swinging if any.

2. Every pushing [Unit, Louver ^{UNIT LOUVER}] button, the indoor unit address in the group are displayed successively. **2**
Specify the indoor unit No. to be replaced.
3. Using the set temperature ∇ / \blacktriangle buttons, the CODE No. (DN) can be moved up and down one by one. **3**
4. First change the CODE No. (DN) from 10 to 01. (Setting of filter sign lighting time)
Make a note of the set data displayed in this time.
5. Next change the CODE No. (DN) using the set temperature ∇ / \blacktriangle buttons.
Also make a note of the set data.
6. Repeat item 5. and made a note of the important set data as shown in the below table.
* 01 to AA are provided in the CODE No. (DN). On the way of operation, DN No. may skip.
7. After finishing making a note, push ^{TEST} button to return to the usual stop status. **4**
(Approx. 1 minute is required to be able to use the remote controller.)

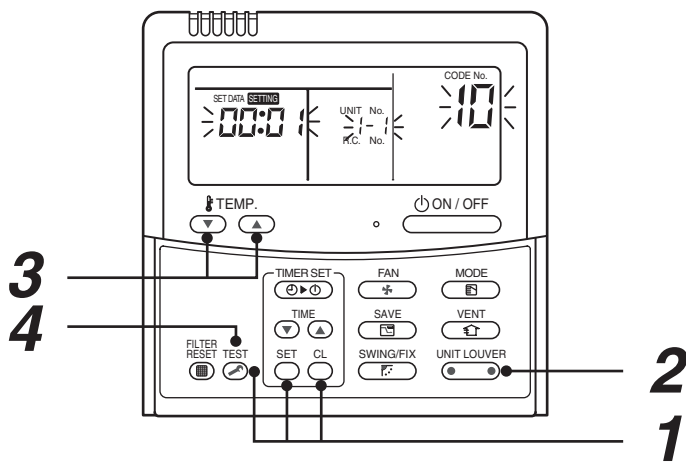

Minimum requirements for CODE No.

DN	Contents
11	Indoor unit capacity
12	Refrigerant line address
13	Indoor unit address
14	Group address

Capacity of the indoor unit is necessary to set the revolutions of the fan.

□2 Replacement of service P.C. board

1. Replace the P.C. board with a service P.C. board.
In this time, setting of jumper line (cut) or setting of DIP switch on the former P.C. board should be reflected on the service P.C. board. Refer to the following table about DIP switch setting and drawing of P.C. board parts layout.
 2. It is necessary to set Indoor unit to be exchanged : Remote controller = 1 : 1
Based upon the system configuration, turn on power of the indoor unit with one of the following items.
 - 1) Single (Individual) operation
Turn on power of the indoor units and proceed to □3.
 - 2) Group operation
 - A) In case that power of the exchanged indoor unit only can be turned on.
Turn on power of the exchanged indoor unit only and proceed to □3.
 - B) In case that power of the indoor units cannot be turned on individually. (**CASE 1**)
 - a) Remove temporarily the group wire connected to the terminal blocks A and B of the exchanged indoor unit.
 - b) After connecting the remote controller wire only to the removed terminal block, turn on power of the indoor units and proceed to □3.
- * When the above methods cannot be used, follow at the **CASE 2** below.

- C) In case that power of the indoor units cannot be turned in individually. (**CASE 2**)
- a) Remove all CN41 connectors of the indoor units in the same group except those of the exchanged indoor unit.
 - b) Turn on power of the indoor units and proceed to **□3**.
- * After **□3** operation has finished, be sure to return the temporarily removed group wire or CN41 connector to the original connection.

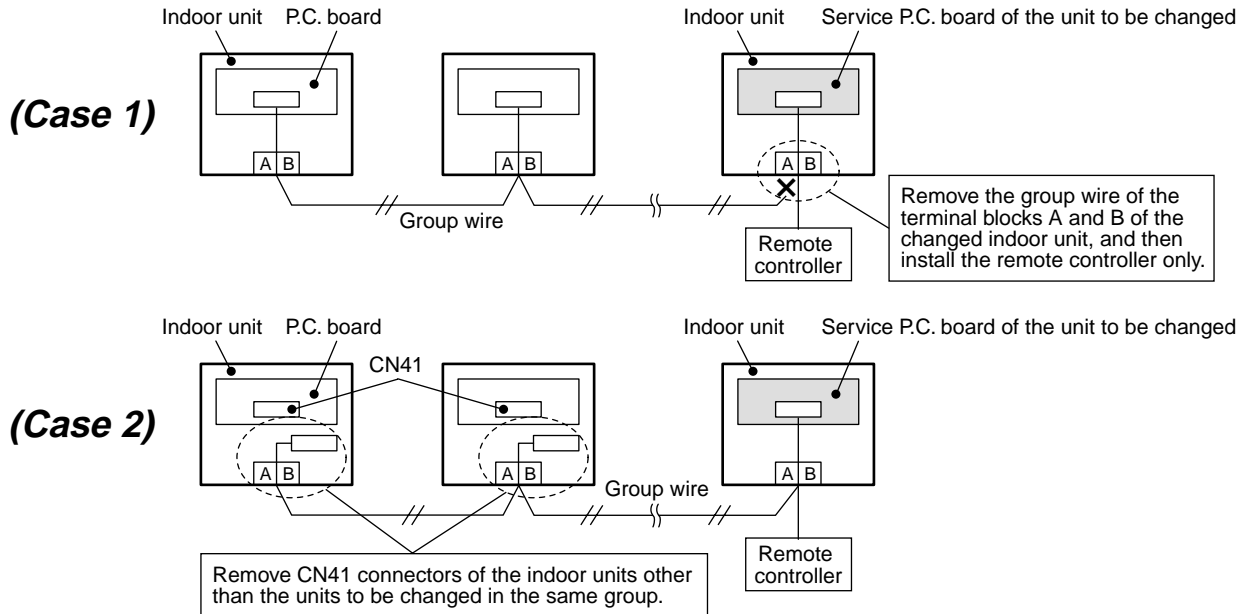

P.C. board parts layout drawing

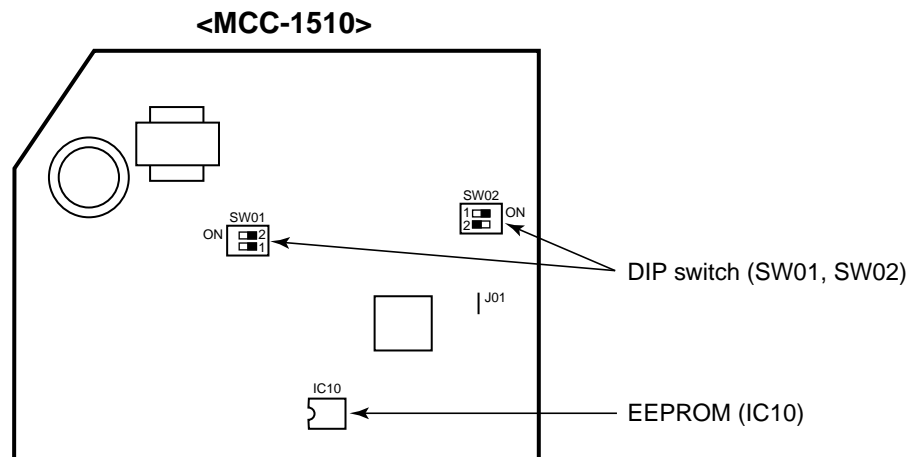



















Method of DIP switch setting

		Selected content	MMK-AP *** 3HP1 series	At shipment
SW01	Bit 1	Terminator resistor (for central control)	* 1	OFF (Without terminator)
	Bit 2	Remote controller A/B selection	* 1	OFF (A selection)
SW02	Bit 1	Custom / Multi model selection	ON	ON (Multi model)
	Bit 2	No use	OFF	OFF

*1 : Match to set up contents of P.C. board before replacement.

□3 Writing of the setup contents to EEPROM

(The contents of EEPROM installed on the service P.C. board have been set up at shipment from the factory.)

1. Push ^{SET} , ^{CL}  and ^{TEST}  buttons of the remote controller at the same time for 4 seconds or more. **1**
(Corresponded with No. in Remote controller as shown below picture) (The UNIT No. *ALL* is displayed.)
In this time, the CODE No. (DN) *10* is displayed.
The fan of the indoor unit operates and the flap starts swinging if any.
2. Using the set temperature  /  buttons, the CODE No. (DN) can be moved up and down one by one. **2**
3. First set the capacity of the indoor unit.
(Setting the capacity writes the data at shipment from the factory in EEPROM.)
 - 1) Using the set temperature  /  buttons, set *11* to the CODE No. (DN). **2**
 - 2) Using the timer time  /  buttons, set the capacity. **3**
(For example, 0005 for MMK-AP0123H) Refer to the attached table.
 - 3) Push ^{SET}  button. (OK when the display goes on.) **4**
 - 4) Push ^{TEST}  button to return to usual stop status. **5**
(Approx. 1 minute is required to start handling of the remote controller.)
4. Next write the contents that have been written at the installation such as the address data into EEPROM.
Repeat the above procedure 1.
5. Using the set temperature  /  buttons, set *01* to the CODE No. (DN). **2**
(Setup of lighting time of filter sign)
6. The contents of the displayed setup data in this time should be agreed with the contents in the previous memorandum in □1.
 - 1) If data disagree, change the displayed setup data to that in the previous memorandum by the timer time  /  buttons, and then push ^{SET}  button. (OK when the display goes on.)
 - 2) There is nothing to do when data agrees.
7. Using the set temperature  /  buttons, change the CODE No. (DN).
As same as the above 6., check the contents of the setup data and then change them to data contents in the previous memorandum in □1.
8. Then repeat the procedure 6. and 7.
9. After completion of setup, push ^{TEST}  button to return the status to the usual stop status. **5**
In a group operation, turn off the power supply once, return the group wires between indoor units and CN41 connectors as before, and then turn on power of all the indoor units.
(Approx. 1 minute is required to be able to use of the remote controller.)
* *01* to *AA* are provided in the CODE No. (DN). On the way of operation, DN No. may skip.

When data has been changed by mistake and ^{SET}  button has been pushed, the data can be returned to the data before change by pushing ^{CL}  button if the CODE No. (DN) was not yet changed.

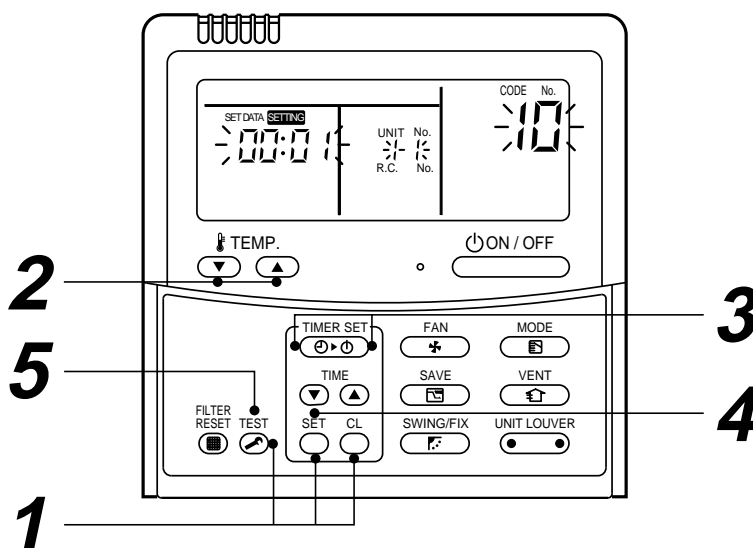

CODE No. table (Please record the objective unit data at field)

DN	Item	Memo	At shipment
01	Filter sign lighting time		0001: 150 hour
02	Dirty state of filter		0000: Standard
03	Central control address		0099: Unfixed
06	Heating suction temp shift		0002: +2°C
0C	PRE-DEF indication selection		0000: Standard
0d	Cooling auto mode existence		0001: No auto mode cooling/heating
0F	Cooling only		0000: Heat pump
10	Type	Be sure to set as 0008	0008: High wall type
11	Indoor unit capacity (See below table)		According to capacity type
12	Refrigerant line address		0099: Unfixed
13	Indoor unit address		0099: Unfixed
14	Group address		0099: Unfixed
1E	Temp difference of automatic cooling/heating selecting control points		0003: 3deg (Ts ± 1.5)
28	Automatic restart from power cut		0000: None
2A	Option input selection (CN80)		0002: External emergency input
2b	Thermo output selection (T10 ③)		0000: Thermo ON
2E	Input selection (T10 ①)		0000: Operation input
32	Sensor selection		0000: Available
60	Timer set (Wired remote controller)		0000: Available
69	Louver selection of cooling		0000: Standard

Indoor unit capacity (CODE No. [11])

Setup data	Model
0001*	Invalid
0001	MMK-AP0073HP1-E1 (TR1)
0003	MMK-AP0093HP1-E1 (TR1)
0005	MMK-AP0123HP1-E1 (TR1)
0007	MMK-AP0153HP1-E1 (TR1)
0009	MMK-AP0183HP1-E1 (TR1)
0011	MMK-AP0243HP1-E1 (TR1)

* Initial value of EEPROM installed on the supplied service P.C. board

11. EXPLODED VIEWS AND PARTS LIST

11-1. Indoor Unit

Model: MMK-AP0073HP1-E1 (TR1), MMK-AP0093HP1-E1 (TR1), MMK-AP0123HP1-E1 (TR1)

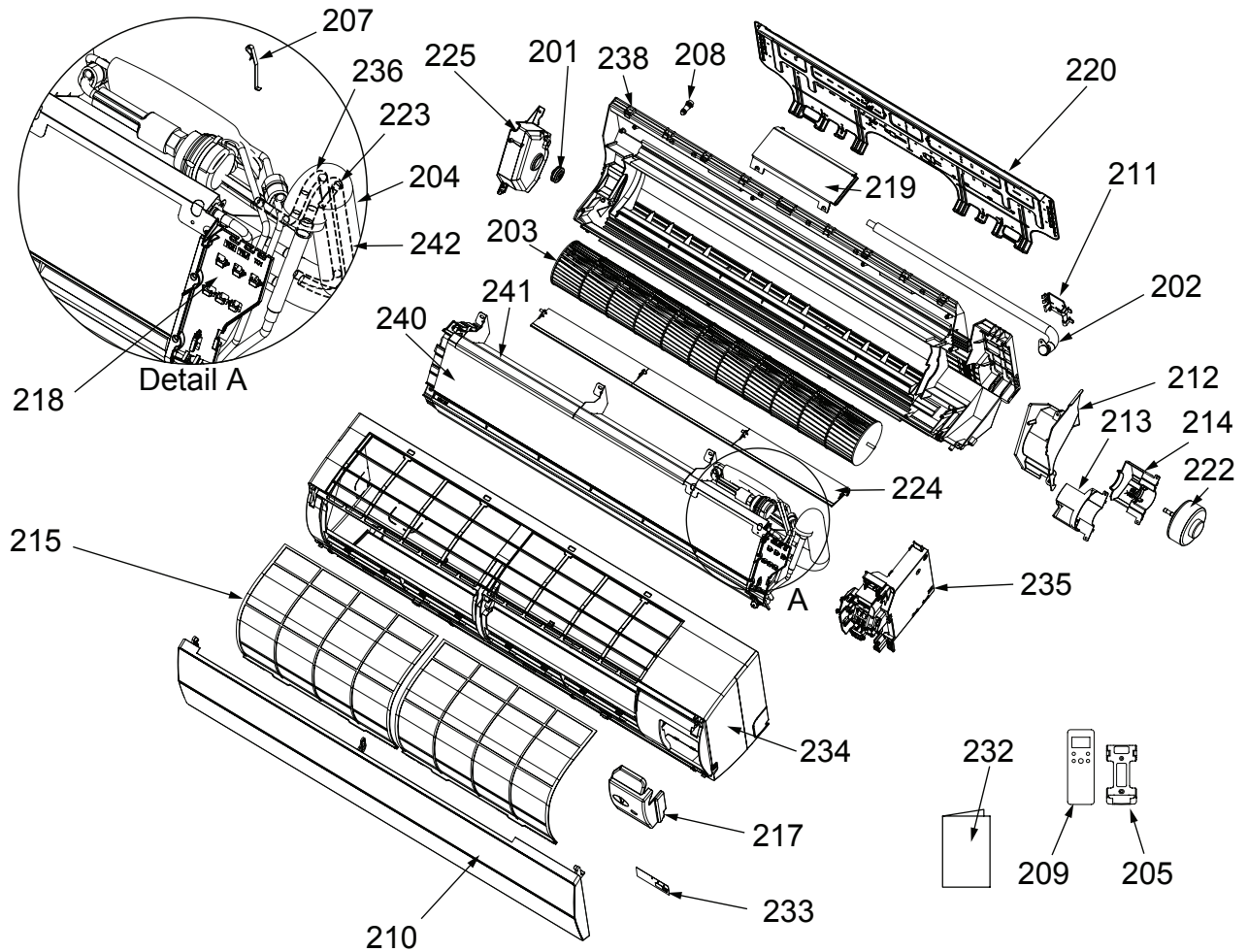

Location No.	Part No.	Description
201	43T22312	Bearing Ass'y
202	43T70313	Hose, Drain
203	43T20016	Fan Ass'y, Cross Flow
204	43T49010	Pipe, Shield
205	43T83003	Holder, Remote Controller
207	43T19333	Holder, Sensor
208	43T79313	Cap, Drain
209	43T66343	Remote Controller, Wireless, WH-L17SE
210	43T09439	Grille Ass'y
211	43T49043	Holder, Pipe
212	43T39026	Band, Motor, Left
213	43T39022	Band, Motor, Right Up
214	43T39023	Band, Motor, Right Down
215	43T80019	Air Filter
217	43T62031	Cover, Terminal
218	43T39024	Drain Guide

Location No.	Part No.	Description
219	43T49044	Cover PMV
220	43T82342	Plate, Installation Assembly
222	43T21407	Motor, Fan, MF340-30-2
223	43T19321	Holder, Sensor
224	43T09045	Louver, Horizontal
225	43T22011	Bearing, Base
232	43T85587	Owner's Manual (-E1)
232	43T85588	Owner's Manual (-TR1)
233	43T15002	Display
234	43T00057	Panel Ass'y
235	43T62032	Clamp, Base Ass'y
236	43T47044	Pipe, Inlet
238	43T03018	Body Ass'y, Back
240	43T44539	Evaporator Ass'y
241	43T39027	Plate, Back
242	43T47043	Pipe, Outlet

11-2. Indoor Unit

Model: MMK-AP0153HP1-E1 (TR1), MMK-AP0183HP1-E1 (TR1), MMK-AP0243HP1-E1 (TR1)

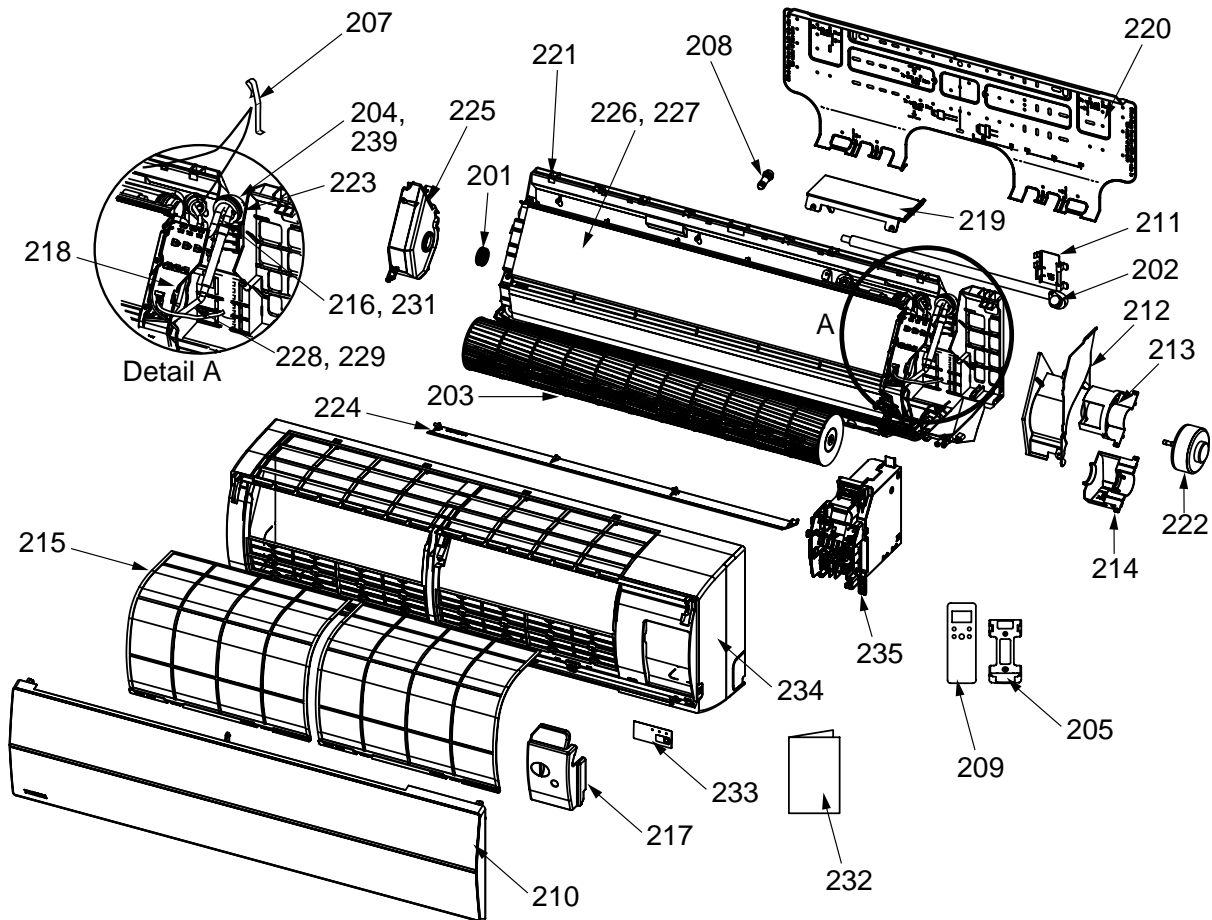

Location No.	Part No.	Description	Location No.	Part No.	Description
201	43T22312	BEARING ASSY, MOLD	223	43T19321	FIX-P-SENSOR
202	43T70313	HOSE, DRAIN	224	43T09045	LOUVER HORIZONTAL
203	43T20016	FAN, ASSY, CROSS FLOW	225	43T22011	BEARING, BASE
204	43T49045	PIPE, SHIELD (AP0153, 0183)	226	43T44538	EVAPORATOR ASSY (AP0243)
205	43T83003	HOLDER, REMOTE CONTROL	227	43T44537	EVAPORATOR ASSY (AP0153, 0183)
207	43T19333	HOLDER, SENSOR	228	43T47039	PIPE-OUTLET (AP0243)
208	43T79313	CAP, DRAIN	229	43T47040	PIPE-OUTLET (AP0153, 0183)
209	43T66343	REMOCON-WRS	231	43T47041	PIPE, INLET (AP0243)
210	43T09439	GRILLE OF AIR INLET ASSY	232	43T85587	OWNER'S MANUAL (AP0153, 0183, 0243HP1-E1)
211	43T49043	HOLDER, PIPE	232	43T85588	OWNER'S MANUAL (AP0153, 0183, 0243HP1-TR1)
212	43T39026	BAND, MOTOR, LEFT	233	43T15002	DISPLAY
213	43T39022	BAND, MOTOR, RIGHT UP	234	43T00057	PANEL ASSY
214	43T39023	BAND, MOTOR, RIGHT DOWN	235	43T62032	CLAMP BASE ASSY
215	43T80019	AIR FILTER	239	43T49045	PIPE, SHIELD (AP0243)
216	43T47045	PIPE, INLET (AP0153, 0183)			
217	43T62031	COVER, TERMINAL			
218	43T39024	DRAIN GUIDE			
219	43T49044	COVER PMV			
220	43T82342	PLATE, INSTALLATION ASSEMBLY			
221	43T03017	BODY, ASSY, BACK			
222	43T21407	MOTOR FAN			

Indoor Unit (Part-E)

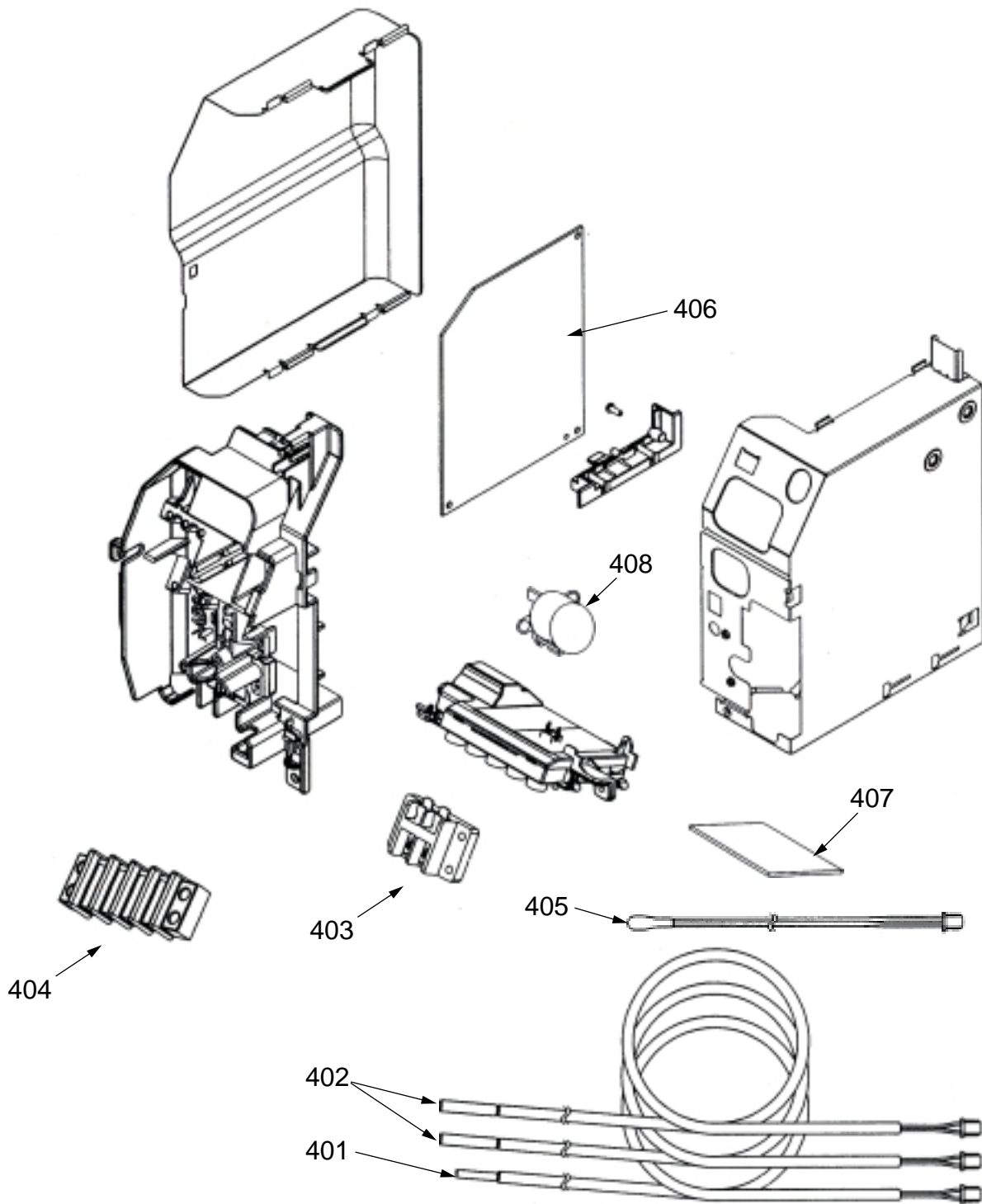

Location No.	Part No.	Description
401	43T50012	Sensor, Heat Exchanger
402	43T50304	Sensor Ass'y
403	43T60078	Terminal Block, 2P, 20A
404	43T60079	Terminal Block, 4P, 1A

Location No.	Part No.	Description
405	43T69320	Sensor (TA)
406	43T6V686	P.C.Board Ass'y, MCC-1510
407	43T69082	P.C.Board Ass'y, MCC-5044
408	43T21397	Louver, Motor, MP24Z3T

TOSHIBA CARRIER (THAILAND) CO., LTD.

144/9 MOO 5, BANGKADI INDUSTRIAL PARK, TIVANON ROAD, TAMBOL BANGKADI,
AMPHUR MUANG, PATHUMTHANI 12000, THAILAND.