

	INDOOR UNIT	OUTDOOR UNIT
MODEL CODE	AR09NXWXCWKNEU	AR09NXWXCWKXEU
	AR12NXWXCWKNEU	AR12NXWXCWKXEU
	AR09NXPXBWKNEU	AR09NXPXBWKXEU
	AR12NXPXBWKNEU	AR12NXPXBWKXEU
	AR09NXWXBWKNEU	AR09NXWXBWKXEU
	AR12NXWXBWKNEU	AR12NXWXBWKXEU
	AR07NXPXBWKNEU	-
	AR07NXWXBWKNEU	-
	AR07NXWXCWKNEU	-

SERVICE Manual

AIR CONDITIONER

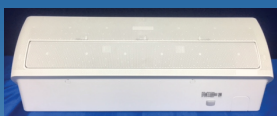

AR09NXWXCWKNEU
 AR12NXWXCWKNEU
 AR09NXPXBWKNEU
 AR12NXPXBWKNEU
 AR09NXWXBWKNEU
 AR12NXWXBWKNEU
 AR07NXPXBWKNEU
 AR07NXWXBWKNEU
 AR07NXWXCWKNEU



AR09NXWXCWKXEU
 AR12NXWXCWKXEU



AR09NXPXBWKXEU
 AR12NXPXBWKXEU
 AR09NXWXBWKXEU
 AR12NXWXBWKXEU

CONTENTS

1. Precautions
2. Product Specifications
3. Alignment and Adjustments
4. Disassembly and Reassembly
5. ASSY CONTROL
6. Electrical Parts List
7. Wiring Diagram
8. PCB Diagram
9. Operating Instructions
10. Troubleshooting
11. Block Diagram
12. Reference Sheet

Contents

1. Precautions	1-1
1-1 Installing the air conditioner	1-1
1-2 Power supply and circuit breaker	1-1
1-3 During operation	1-1
1-4 Disposing of the unit	1-2
1-5 Others	1-2
2. Product Specifications	2-1
2-1 The Feature of Product	2-1
2-2 Product Specifications	2-2
2-3 The Comparative Specifications of Product	2-3
2-4 Accessory and Option Specifications	2-4
3. Alignment and Adjustments	3-1
3-1 Test Mode	3-1
3-2 Display Error and Check Method	3-2
3-3 Setting Option Setup Method	3-4
4. Disassembly and Reassembly	4-1
4-1. Indoor Unit	4-2
4-2. Outdoor Unit	4-12
5. ASSY CONTROL	5-1
5-1 ASSY KIT CODE DB92-04408A	5-1
5-2 ASSY KIT CODE DB92-04376B	5-2
6. Electrical Parts List	6-1
6-1 INDOOR MAIN PCB CODE DB92-04101B	6-1
6-2 OUTDOOR MAIN PCB CODE DB92-04029D	6-4
6-3 INDOOR DISPLAY PBA CODE DB92-02877A	6-7
7. Wiring Diagram	7-1
7-1 Indoor Unit	7-1
7-2 Outdoor Unit	7-4

Contents

8. PCB Diagram	8-1
8-1 INDOOR MAIN PCB CODE DB92-04101B.....	8-1
8-2 INDOOR MAIN PCB CODE DB92-04029D.....	8-2
8-3 INDOOR MAIN PCB CODE DB92-04025C.....	8-3
8-4 INDOOR DISPLAY PBA CODE DB92-04106A	8-4
8-5 SUB PCB-Receive - DB92-02874A	8-5
8-6 Wire connecting the indoor unit terminal blocks.....	8-6
9. Operating Instructions.....	9-1
9-1 Name of Each Part.....	9-1
9-2 Wireless Remote Control-Buttons and Display.....	9-3
10. Troubleshooting	10-1
10-1 Items to be checked First.....	10-1
10-2 Communication Error.....	10-2
10-2-1 Communication Error	10-2
10-2-2 Indoor temperature sensor Error	10-3
10-2-3 Indoor fan motor speed detecting error (BLDC fan)	10-4
10-2-4 Outdoor temperature sensor error	10-5
10-2-5 Outdoor Cond temperature sensor error	10-6
10-2-6 Outdoor Discharge temperature sensor error	10-7
10-2-7 Operation condition secession error.....	10-8
10-2-8 EEPROM error/OTP error	10-9
10-2-9 Outdoor Fan motor error	10-10
10-2-10 Compressor starting error	10-11
10-2-11 Compressor wire missing error/rotation error	10-12
10-2-12 Current sensor error/Input current sensor error	10-13
10-2-13 O.C(Over Current) error	10-14
10-2-14 No power outdoor (Initial Diagnosis) (Not displayed).....	10-16
10-2-15 When the Up/Down, Left/Right, Grill louver motor does not operate (Initial Diagnosis) (Not displayed)	10-17
10-2-16 When the remote control is not receiving.....	10-18
10-2-17 Smart Install error	10-19
10-2-18 Outdoor OLP over temperature error (One way Inverter Only).....	10-20
11. Block Diagram	11-1
11-1 Indoor unit	11-1
11-2 Outdoor unit	11-2
12. Reference Sheet.....	12-1
12-1 Low Refrigerant Pressure Distribution	12-1
12-2 Pressure & Capacity mark.....	12-1
12-3 Q & A for Non-trouble	12-2
12-4 Cleaning /Filter Change.....	12-5
12-5 Installation	12-6
12-6 Installation Diagram of Indoor Unit and Outdoor Unit	12-7
12-7 Reference sheet	12-9

1. Precautions

1-1 Installing the air conditioner

- **Users should not install the air conditioner by themselves.**
Ask the dealer or authorized company to install the air conditioner except window-type air conditioner in U.S.A and Canada.
- **If you don't install the air conditioner properly, it may cause a fire, a water leakage or an electric shock.**
- **You must install the air conditioner according to the national wiring regulations and safety regulations.**
- **Install the indoor unit higher than 2.5m from the floor to avoid the injury caused by the operation of the fan.**
(except the window-type air conditioner)
- **The manufacturer is not responsible for any accidents or injury caused by an incorrect installation.**
- **When installing the built-in type air conditioner, keep all electric cables such as the power cable and the connection cord in pipes, ducts, or cable channels to protect them from the danger of impact or any other incidents.**

1-2 Power supply and circuit breaker

- **If the power cord of the air conditioner is damaged, it must be replaced by the manufacturer or a qualified person in order to avoid a hazard.**
- **The air conditioner must be plugged into an independent circuit if applicable or connect the power cable to the auxiliary circuit breaker.**
An all pole disconnection form the power supply must be incorporated in the fixed wiring with a contact opening of >3mm.
- **Do not extend an electric cord to the air conditioner.**
- **The air conditioner must be plugged in after you complete the installation.**

1-3 During operation

- **Do not repair the air conditioner at your discretion.**
It is recommended to contact a service center directly.
- **Never spill any kind of liquid on the air conditioner.**
If this happens, turn off the air conditioner and contact an authorized service center.
- **Do not insert anything between the airflow blades to prevent damage of the inner fan and consequent injury.**
Keep children away from the air conditioner.
- **Do not place any obstacles in front of the air conditioner.**
- **Do not spray any kind of liquid into the indoor unit. If this happens, turn off the air conditioner and contact a service center.**
- **Make sure that the air conditioner is well ventilated at all times.**
Do not place a cloth or other materials over it.
- **Remove the batteries if you don't use the remote control for a long time. (If applicable)**
- **Use the remote control within 7 meters from the indoor unit. (If applicable)**

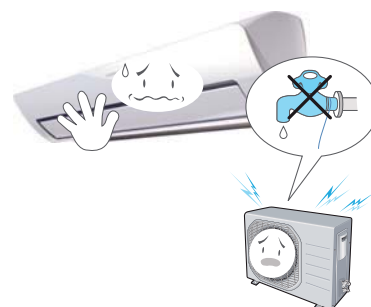

1-4 Disposing of the unit

- Before the throwing out the air conditioner, remove the batteries from the remote control.
- When you dispose of the air conditioner, consult your dealer. If pipes are removed incorrectly, refrigerant may blow out and cause air pollution. When it contacts with your skin, it can cause skin injury.
- The package of the air conditioner should be recycled or disposed of properly for environmental reasons.

1-5 Others

- Never store or load the air conditioner upside down or sideways to prevent the damage to the compressor.
- Young children or infirm persons should be always supervised when they use the air conditioner.
- Max current is measured according to IEC standard for safety.
- Current is measured according to ISO standard for energy efficiency.

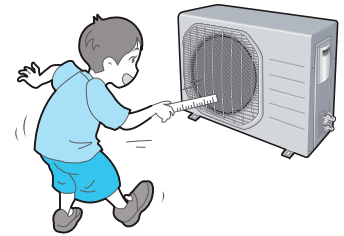

2. Product Specifications

2-1 The Feature of Product

■ 2-step cooling

2-step cooling function will quickly cool the room to reach the desired temperature and then it will adjust the fan speed and air flow direction automatically to help you stay comfortable and refreshed.

■ Fast cooling

If you want the strong and cool air, just select Fast function! It will get you the strongest air!

■ Comfort cooling

If you want the comfortable and refreshing air, Comfort function will spread the cool air indirectly to you, so that you can stay comfortable.

■ Single User

Use the Single User function when you're along at home. Aside from energy savings from the inverter technology, the Single User Mode will further minimize your energy consumption and reduce your electricity bill by adjusting the maximum operating capacity of the compressor.

■ Easy Filter

There is no grille to remove before separating the filter from the air conditioner! Therefore, filter can be cleaned easily and more frequently. Constant filter cleaning will prevent dust from entering the product or accumulating on the filter.

good'sleep function

good'sleep function will allow you to have deep, good night's sleep by adjusting the temperature, fan speed and air flow direction.

■ Smart Install

When the installation is done, your product will examine itself through trial operation to check if it was installed properly.

■ Easy Installation

It's so easy to install! You can easily hang the product on the wall and connect the pipes and wires by opening the cover on the bottom of the product. Now you won't have to tilt the product to connect the pipe and the wires!





2-2 Product Specifications



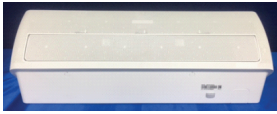
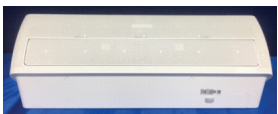

Model			AR09NXPXBWK/EU	AR12NXPXBWK/EU	AR09NXWBWK/EU	AR12NXWBWK/EU	AR09NXWCWK/EU	AR12NXWCWK/EU
Rating	Mode	Unit	Wall-mounted	Wall-mounted	Wall-mounted	Wall-mounted	Wall-mounted	Wall-mounted
Capacity	T1 Cool	W	2500	3500	2500	3500	2750	3500
	T3 Cool	W	-	-	-	-	-	-
	Heat	W	3200	3500	3200	3500	3200	3500
Power Input	T1 Cool	W	670	980	600	980	820	1220
	T3 Cool	W	-	-	-	-	-	-
	Heat	W	670	940	850	940	840	950
Current	T1 Cool	A	3.6	4.6	3.1	4.6	4	5.6
	T3 Cool	A	-	-	-	-	-	-
	Heat	-	4.4	4.4	4	4.6	4	4.3
Efficiency	EER	W/W	3.73	3.57	4.17	3.57	3.35	2.87
	COP	W/W	3.72	3.72	3.76	3.72	3.81	3.68
Dehumidifying	l/hr.		0.8	0.8	0.8	0.8	0.8	0.8
Platform	IDU	-	F-RAC-06 (Wind-Free)	F-RAC-06 (Wind-Free)	F-RAC-06 (Wind-Free)	F-RAC-06 (Wind-Free)	F-RAC-06 (Wind-Free)	F-RAC-06 (Wind-Free)
	ODU	-	N-WW	N-WW	N-WW	N-WW	N-V2MD	N-V2MD
Evap	Main	-	Φ7, 2R*10S*635mm, H1.3, N.G.S, 2by2	Φ7, 2R*8S*635mm, H1.3, N.G.S, 1by2	Φ7, 2R*8S*635mm, H1.3, N.G.S, 1by2	Φ7, 2R*8S*635mm, H1.3, N.G.S, 1by2	Φ7, 2R*8S*635mm, H1.3, N.G.S, 1by2	Φ7, 2R*8S*635mm, H1.3, N.G.S, 1by2
	Sub	-	Φ7, 2R*4S*635mm, H1.3, N.G.S : (F03-2-1)	Φ7, 2R*6S*635mm, H1.3, N.G.S : (F03-2-1-1)	Φ7, 2R*6S*635mm, H1.3, N.G.S : (F03-2-1-1)	Φ7, 2R*6S*635mm, H1.3, N.G.S : (F03-2-1-1)	Φ7, 2R*6S*635mm, H1.3, N.G.S : (F03-2-1-1)	Φ7, 2R*6S*635mm, H1.3, N.G.S : (F03-2-1-1)
Cond	Main	-	N-WW FMC (6Turn) FP1.4	Φ7W, 2R*24S*706mm, Corrugate1.5, N.G.S, 4by4by2	Φ7W, 2R*24S*706mm, Corrugate1.5, N.G.S, 4by4by2	Φ7W, 2R*24S*706mm, Corrugate1.5, N.G.S, 4by4by2	Φ7W, 2R*20(21)S*639/611 mm, Corrugate1.5, N.G.S, 4by4by2	Φ7W, 2R*20(21)S*639/611 mm, Corrugate1.5, N.G.S, 4by4by2
	Sub	-	-	-	-	-	-	-
Comp	Model	-	UG9AJ3090FERSI	UB9AK1090FERTS	UB9AK1090FERTS	UB9AK1090FERTS	UB9AK1090FJR	UB9AK1090FJR
	OLP	-	-	-	-	-	-	-
Motor In	Code	-	DB31-00636A	DB31-00636A	DB31-00636A	DB31-00636A	DB31-00636A	DB31-00636A
	Name	-	-	-	-	-	-	-
Motor Out	Code	-	DB31-00642C	DB31-00642C	DB31-00642C	DB31-00642C	DB31-00642C	DB31-00642C
	Name	-	-	-	-	-	-	-
Expansion	Φ * L	-	EEV Φ1.4	EEV Φ1.4	EEV Φ1.4	EEV Φ1.4	EEV Φ1.4	EEV Φ1.4
Refrigerant	type	-	R-32	R-32	R-32	R-32	R-32	R-32
	charge	g	750 g	750 g	750 g	700 g	700 g	700 g
SVC Valve	Liquid / Gas	-	6.35/9.52	6.35/9.52	6.35/9.52	6.35/9.52	6.35/9.52	6.35/9.52
Tube	Dis. / Suc.	-	7.94/9.52	7.94/9.52	7.94/9.52	7.94/9.52	9.52/12.7	7.94/9.52
Drain hose	D * L	mm	20*550	20*550	20*550	20*550	20*550	20*550
Power Cord	-	-	-	-	-	-	-	-
4-WAY V/V	-	-	1HP	1HP	1HP	1HP	1HP	1HP
Power Supply	V/Hz/Φ		220-240/50/1	220-240/50/1	220-240/50/1	220-240/50/1	220-240/50/1	220-240/50/1
Climate Class	-	-	T1	T1	T1	T1	T1	T1
Noise	IDU	dB	41	43	41	43	41	44
	ODU	dB	52	53	52	53	53	54
Net Size (W*D*H)	IDU	mm	828*265*267	828*265*267	828*265*267	828*265*267	828*265*267	828*265*267
	ODU	mm	720*265*548	720*265*548	720*265*548	720*265*548	660*242*475	660*242*475
Weight	IDU	kg	9.4	9.4	9.4	9.4	9.4	9.4
	ODU	kg	35	35	35	35	22.8	22.9
Operation range	Cooling	IDU	16 °C~32 °C	16 °C~32 °C	16 °C~32 °C	16 °C~32 °C	16 °C~32 °C	16 °C~32 °C
		ODU	-10 °C to 46 °C	-10 °C to 46 °C	-10 °C to 46 °C	-10 °C to 46 °C	-10 °C to 46 °C	-10 °C to 46 °C
	Heating	IDU	27 °C or less	27 °C or less	27 °C or less	27 °C or less	27 °C or less	27 °C or less
		ODU	-15 °C to 24 °C	-15 °C to 24 °C	-15 °C to 24 °C	-15 °C to 24 °C	-15 °C to 24 °C	-15 °C to 24 °C

2-2 Product Specifications

Model			AR07NXPXBWKNEU	AR07NXWXBWKNEU	AR07NXWXCWKNEU
Rating	Mode	Unit	Wall-mounted	Wall-mounted	Wall-mounted
Capacity	T1 Cool	Btu/h	6824	6824	6824
	T3 Cool	Btu/h	-	-	-
	Heat	Btu/h	7506	7506	7506
Power Input	T1 Cool	W	30	30	30
	T3 Cool	W	-	-	-
	Heat	W	-	-	-
Current	T1 Cool	A	0.3	0.3	0.3
	T3 Cool	A	-	-	-
	Heat	-	-	-	-
Dehumidifying		l/hr.	0.8	0.8	0.8
Platform	IDU	-	F-RAC-06	F-RAC-06	F-RAC-06
	ODU	-	-	-	-
Evap	Main	-	Φ7, F.P1.3, H-fin, NGS	Φ7, F.P1.3, H-fin, NGS	Φ7, F.P1.3, H-fin, NGS
	Sub	-	2ROWx14STEPx635, 1-2pass	2ROWx14STEPx635, 1-2pass	2ROWx14STEPx635, 1-2pass
Motor In	Code	-	DB31-00636A	DB31-00636A	DB31-00636A
	Name	-	-	-	-
Power Supply		V/Hz/Φ	220-240/50/1	220-240/50/1	220-240/50/1
Climate Class		-	T1	T1	T1
Noise	IDU UT,T	dB	43	43	43
Net Size (W*D*H)	IDU	mm	828*265*267	828*265*267	828*265*267
Weight	IDU	kg	9.4	9.4	9.4
Operation range	Cooling	IDU	16 °C~32 °C	16 °C~32 °C	16 °C~32 °C
		ODU	-10 °C to 46 °C	-10 °C to 46 °C	-10 °C to 46 °C
	Heating	IDU	27 °C or less	27 °C or less	27 °C or less
		ODU	-15 °C to 24 °C	-15 °C to 24 °C	-15 °C to 24 °C

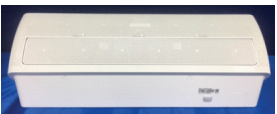
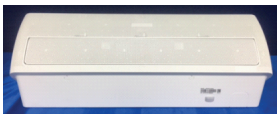
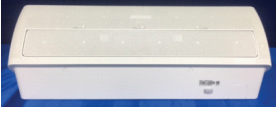
2-3 The Comparative Specifications of Product

Model		DEVELOPMENT MODEL		
		AR09NXPXBWK/EU	AR12NXPXBWK/EU	AR09NXWXBWK/EU
Design	Indoor Unit			
	Outdoor Unit			
Net Weight	Indoor Unit	9.4	9.4	9.4
	Outdoor Unit	35	35	35
Net Dimension	Indoor Unit	828*265*267	828*265*267	828*265*267
	Outdoor Unit	720*265*548	720*265*548	720*265*548
Noise	Indoor Unit	41	43	41
	Outdoor Unit	52	53	52
Air Purifying System		EASY CLEAN FILTER	EASY CLEAN FILTER	EASY CLEAN FILTER
Indoor Display		88 SEG	88 SEG	88 SEG

Model		DEVELOPMENT MODEL		
		AR12NXWXBWK/EU	AR09NXWXCWK/EU	AR12NXWXCWK/EU
Design	Indoor Unit			
	Outdoor Unit			
Net Weight	Indoor Unit	9.4	9.4	9.4
	Outdoor Unit	35	22.8	22.9
Net Dimension	Indoor Unit	828*265*267	828*265*267	828*265*267
	Outdoor Unit	720*265*548	660*242*475	660*242*475
Noise	Indoor Unit	43	41	44
	Outdoor Unit	53	53	54
Air Purifying System		EASY CLEAN FILTER	EASY CLEAN FILTER	EASY CLEAN FILTER
Indoor Display		88 SEG	88 SEG	88 SEG

2-3 The Comparative Specifications of Product

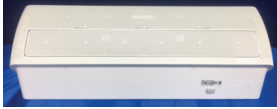
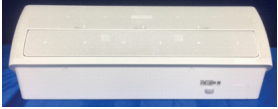
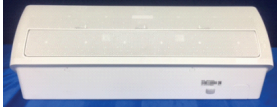
Model		DEVELOPMENT MODEL		
		AR07NXPXBWKNEU	AR07NXWXBWKNEU	AR07NXWXCWKNEU
Design	Indoor Unit			
Net Weight	Indoor Unit	9.4	9.4	9.4
Net Dimension	Indoor Unit	828*265*267	828*265*267	828*265*267
Noise	Indoor Unit	43	43	43
Air Purifying System		EASY CLEAN FILTER	EASY CLEAN FILTER	EASY CLEAN FILTER
Indoor Display		88 SEG	88 SEG	88 SEG

2-4 Accessory and Option Specifications

Item	Descriptions	Code No.	Q'ty	Remark
	ASSY HANGER	DB90-07731A	1	Indoor Unit
	ASSY WIRELESS REMOCON	DB93-16761D	1	
	HOLDER REMOCON	DB61-06087A	1	
	BATTERY	4301-000121	2	
	MANUAL USERS	DB68-07468A	1	
	MANUAL INSTALL	DB68-06730A	1	
	SCREW-TAPPING	6002-000623	2	
	CAP-SCREW	DB67-01404B	2	
	Rubber Leg	DB67-01533A	4	Outdoor unit case

3. Alignment and Adjustments

3-1 Test Mode

■ How to Approach Test Mode

You can approach the test mode by pressing the on/off switch of indoor unit for 5 seconds.

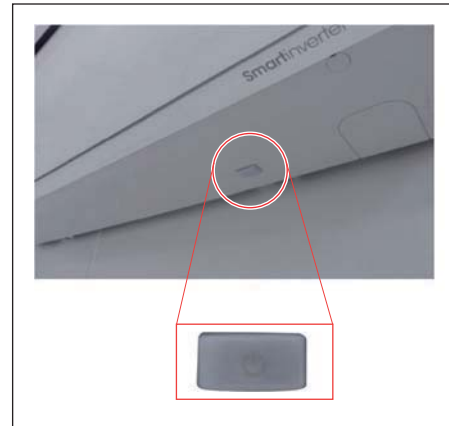

■ Test mode operation option

After installing the air conditioner, check whether each subordinate is normally operated or not by operating the test mode.

- **When an Error occurs, display the Error Mode.**
- **Operation Mode :** Cool mode. operate the cool mode by operating the compressor by force without the compressor ON/OFF according to the set temperature/indoor temperature. (Do not follow the antifreeze control)
- **Up-down louver :** Up-down swing mode
- **Indoor Fan :** Turbo



Note

- Because the test mode operates the cool mode by force not related to the set temperature / indoor temperature, check whether each subordinate is operated normally or not after completing installation and must turn off the power of the air conditioner.

3-2 Display Error and Check Method

3-2-1 Indoor Display Error and Check Method

7-SEG	ERROR MODE			DESCRIPTION
	LED1	LED2	LED3	
	OPERATION	TIMER	OPTION	
E101, E102	○	◐	◐	Communication error (Indoor <-> Outdoor)
E121	○	◐	○	ROOM TH sensor error
E122, E123	◐	◐	○	INDOOR MID, INDOOR IN PIPE-TH sensor error
E154	○	○	◐	Fan error (indoor)
E162	◐	◐	◐	EEPROM error
E163	◐	◐	◐	Option error
FROM E200	◐	○	◐	Outdoor error display
E203	◐	●	●	Time out comm. (Inv Micom <-> Main Micom)
E422/E554	●	○	◐	EEV or Valve Close error-Self diagnosis /Gas Leak Error
E458	●	●	◐	Out door and Fan Error
E461	◐	●	◐	Comp. Starting Error
E463	●	○	○	No display about the outdoor condition
E464	○	●	◐	IPM Over Current (O.C) Error
E465	◐	●	○	Comp V_limit/I_limit Error
E500				Heatsink overheat or IPM overheat

● : LAMP ON ○ : LAMP OFF ◐ : LAMP BLINK

Note

If the set doesn't work (No power), check the thermal fuse of terminal block OPEN or SHORT with Multimeter.

* Measure the thermal fuse housing PIN#1~2 :
OPEN(disconnection)-> defective product

3-2-2 Outdoor LED Display Error and Check method

LED PATTERN			7SEG DISPLAY	DESCRIPTION
YEL	GRN	RED		
○	○	○	-	POWER OFF / VDD NG
●	●	●	-	Power ON reset (1sec)
○	◎	●	-	NORMAL OPERATION
○	○	●	-	Abnormal Communication (Indoor ↔ Outdoor)
○	◎	●	-	
○	○	◎	E464	IPM Over Current(O.C) Error
○	◎	○	E461	Comp.Starting Error
○	●	○	E470	EEPROM Data Error (no data)
○	●	◎	E466	DC-Link Voltage Under / Over Error
			E484	PFC Over Load Error
			E483	Over Voltage Protection Error
◎	○	◎	E221	OUT-TH (Outdoor Temperature) Sensor Error
◎	○	●	E416	DIS-TH (Discharge Temperature) Over Error
◎	◎	○	E251	DIS-TH (Discharge Temperature) Sensor Error
◎	◎	●	E468	Current Sensor Error
			E474	Heatsink Sensor Error
			E485	Input Current Sensor Error
◎	●	○	E465	Comp V_limit / I_limit Error
			E500	Heatsink Over Temperature Error
◎	●	◎	E231	CON-TH (Cond Temperature) Sensor Error
◎	●	●	E203	Time out Comm. (Inv Micom ↔ Main Micom)
●	○	○	E458	Fan Error
●	○	◎	E471	EEPROM Data Error (Main Micom ↔ Inv Micom)
●	○	●	E467	Comp Wire Missing Error
●	◎	○	E440	Prohibit Operation Condition Error (Heating)
			E441	Prohibit Operation Condition Error (Cooling)
●	◎	◎	E469	DC-Link Voltage Sensor Error
			E488	AC Input Voltage Sensor Error
●	◎	●	E462	AC Input I_Limit Trip Error
●	●	○	E554	Gas Leak Error
			E422	EEV or Valve Close error-self diagnosis
◎	○	●	E463	Outdoor OLP over temperature error
○	◎	◎	-	Test Operation at Cooling Mode
◎	◎	◎	-	Test Operation at Heating Mode

● LED ON ○ LED OFF ◎ LED BLINKING



3-3 Setting Option Setup Method

Ex) Option No. :

11-F4-50-6A-6A-01-E0-07-F7-C4

Step 1

Enter the Option Setup mode.



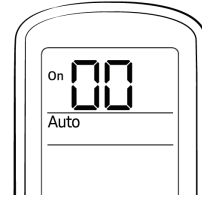





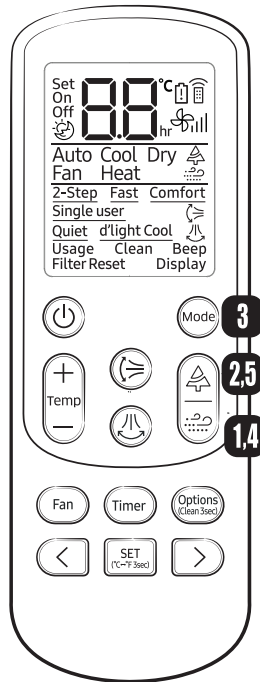

1. Tack out the batteries of remote control.
2. Press the temperature  button simultaneously and insert the battery again.
3. Make sure the remote control display shown as 

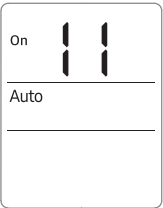



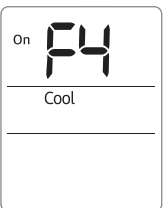





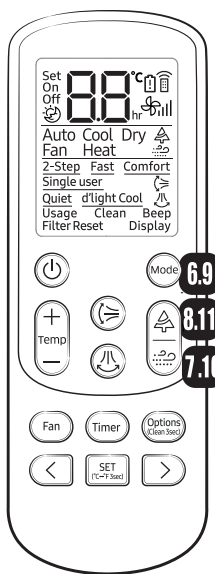

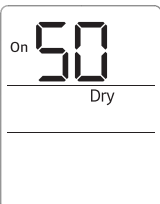
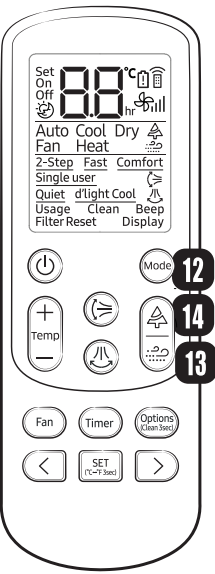





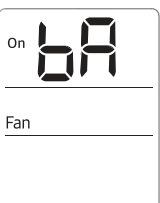





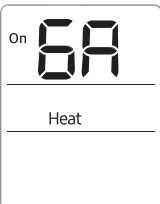





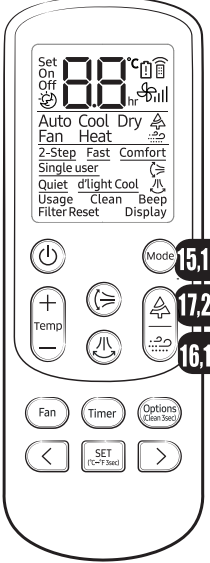





Step 2

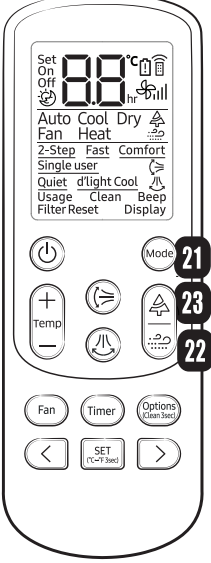









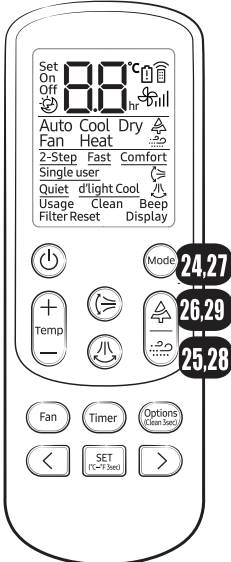

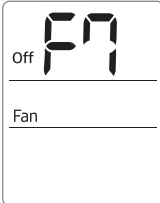
Enter the Options Setup mode and select your options according to the following procedure.

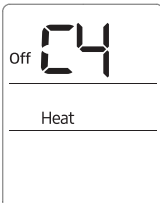

Method	Display
<p>1</p> <p>Setting option SEG1</p> <p>Press the  button the display panel to !.</p> <p>Press the  button repeatedly to select . 0 → 1 → 2 → 3 → ...</p> <p>9 → A → b → c → d → E → F</p>	
<p>2</p> <p>Setting option SEG2</p> <p>Press the  button the display panel to !.</p> <p>Press the  button repeatedly to select . 0 → 1 → 2 → 3 → ...</p> <p>9 → A → b → c → d → E → F</p>	
<p>3</p> <p>Press the  button to set Cool mode.</p>	
<p>4</p> <p>Setting option SEG3</p> <p>Press the  button the display panel to F.</p> <p>Press the  button repeatedly to select . 0 → 1 → 2 → 3 → ...</p> <p>9 → A → b → c → d → E → F</p>	
<p>5</p> <p>Setting option SEG4</p> <p>Press the  button the display panel to 4.</p> <p>Press the  button repeatedly to select . 0 → 1 → 2 → 3 → ...</p> <p>9 → A → b → c → d → E → F</p>	

	Method	Display
	<p>6</p> <p>Press the  button to set Dry mode.</p>	
	<p>7</p> <p>Setting option SEG5</p> <p>Press the  button the display panel to 5.</p> <p>Press the  button repeatedly to select . 0 → 1 → 2 → 3 → ...</p> <p>g → A → b → c → d → E → F</p>	
	<p>8</p> <p>Setting option SEG6</p> <p>Press the  button the display panel to 0.</p> <p>Press the  button repeatedly to select . 0 → 1 → 2 → 3 → ...</p> <p>g → A → b → c → d → E → F</p>	
	<p>9</p> <p>Press the  button to set Fan mode.</p>	
	<p>10</p> <p>Setting option SEG7</p> <p>Press the  button the display panel to b.</p> <p>Press the  button repeatedly to select . 0 → 1 → 2 → 3 → ...</p> <p>g → A → b → c → d → E → F</p>	
	<p>11</p> <p>Setting option SEG8</p> <p>Press the  button the display panel to A.</p> <p>Press the  button repeatedly to select . 0 → 1 → 2 → 3 → ...</p> <p>g → A → b → c → d → E → F</p>	
	<p>12</p> <p>Press the  button to set Heat mode.</p>	
	<p>13</p> <p>Setting option SEG9</p> <p>Press the  button the display panel to 5.</p> <p>Press the  button repeatedly to select . 0 → 1 → 2 → 3 → ...</p> <p>g → A → b → c → d → E → F</p>	
	<p>14</p> <p>Setting option SEG10</p> <p>Press the  button the display panel to A.</p> <p>Press the  button repeatedly to select . 0 → 1 → 2 → 3 → ...</p> <p>g → A → b → c → d → E → F</p>	

	Method	Display
	<p>15 Press the  button to set Auto mode.</p> <p>16 Setting option SEG11 Press the  button the display panel to 0. Press the  button repeatedly to select . 0 → 1 → 2 → 3 → ... g → A → b → c → d → E → F</p> <p>17 Setting option SEG12 Press the  button the display panel to !. Press the  button repeatedly to select . 0 → 1 → 2 → 3 → ... g → A → b → c → d → E → F</p> <p>18 Press the  button to set Cool mode.</p> <p>19 Setting option SEG13 Press the  button the display panel to E. Press the  button repeatedly to select . 0 → 1 → 2 → 3 → ... g → A → b → c → d → E → F</p>	<div data-bbox="1257 257 1417 465"> <p>Off 01</p> <p>Auto</p> </div> <div data-bbox="1257 869 1417 1077"> <p>Off E0</p> <p>Cool</p> </div>
	<p>20 Setting option SEG14 Press the  button the display panel to 0. Press the  button repeatedly to select . 0 → 1 → 2 → 3 → ... g → A → b → c → d → E → F</p> <p>21 Press the  button to set Dry mode.</p> <p>22 Setting option SEG15 Press the  button the display panel to 0. Press the  button repeatedly to select . 0 → 1 → 2 → 3 → ... g → A → b → c → d → E → F</p> <p>23 Setting option SEG16 Press the  button the display panel to !. Press the  button repeatedly to select . 0 → 1 → 2 → 3 → ... g → A → b → c → d → E → F</p>	<div data-bbox="1257 1467 1417 1675"> <p>Off 07</p> <p>Dry</p> </div>

	설정방법	표시부
	<p>24</p> <p>Press the  button to set Fan mode.</p>	
	<p>25</p> <p>Setting option SEG17</p> <p>Press the  button the display panel to F.</p> <p>Press the  button repeatedly to select . 0 → 1 → 2 → 3 → ...</p> <p>g → A → b → c → d → E → F</p>	
	<p>26</p> <p>Setting option SEG18</p> <p>Press the  button the display panel to 7.</p> <p>Press the  button repeatedly to select . 0 → 1 → 2 → 3 → ...</p> <p>g → A → b → c → d → E → F</p>	
	<p>27</p> <p>Press the  button to set Heat mode.</p>	
	<p>28</p> <p>Setting option SEG19</p> <p>Press the  button the display panel to C.</p> <p>Press the  button repeatedly to select . 0 → 1 → 2 → 3 → ...</p> <p>g → A → b → c → d → E → F</p>	
<p>29</p> <p>Setting option SEG20</p> <p>Press the  button the display panel to 4.</p> <p>Press the  button repeatedly to select . 0 → 1 → 2 → 3 → ...</p> <p>g → A → b → c → d → E → F</p>		

Step 3 After setting, check whether the setting is correct.

Press the  button and check whether the setting is correct per each mode.

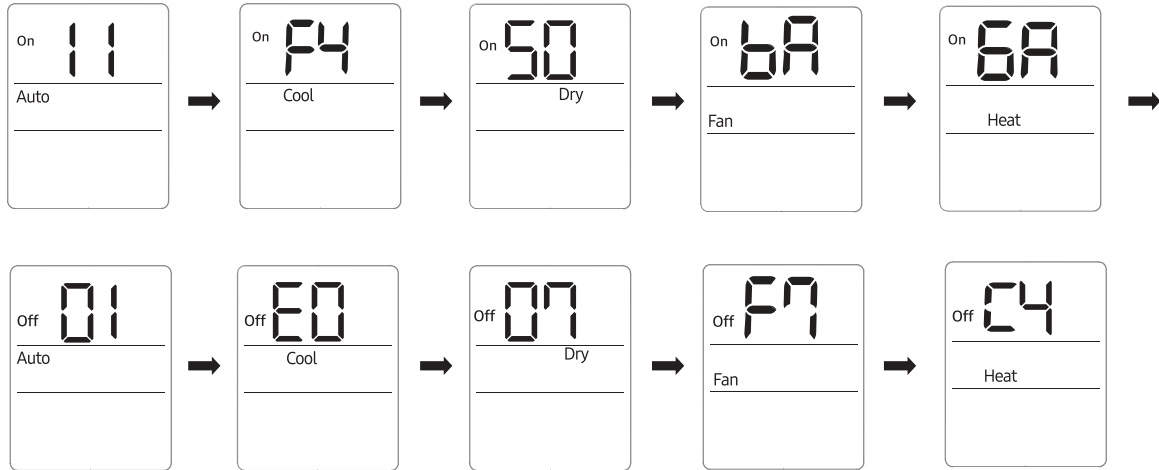

Step 4 Press the  button

Check whether operation lamp flashes with beep sound → Setting option is completed.

Proceed Step 2~4 to setting option 2 and option 3.

Step 5 Remove the batteries in remote control and insert the batteries again. Press power button to operate.

■ Error mode



1. When Operation lamp flashes, plug the power plug again and press power button to run.
2. Check whether you set correct option code per model when air-conditioner does not run or operation lamp flashes.

Option code :

Model	Option code
AR09NXPXBWK/EU	011C45-17EA2B-271920-3727C4
AR12NXPXBWK/EU	01C005-15628A-272325-3726A4
AR09NXWXBWK/EU	011C45-17EA2B-271920-3727C4
AR12NXWXBWK/EU	011C45-17EA4B-272323-3727C4
AR09NXWXCWK/EU	011C05-17EA29-271920-3715D4
AR12NXWXCWK/EU	011C05-15EA6B-272323-3717D4
AR07NXPXBWKNEU	011C45-16EA3A-271416-3727C4
AR07NXWXBWKNEU	011C05-16EA3A-271416-3727D4
AR07NXWXCWKNEU	011C05-16EA3A-271416-3727D4

4. Disassembly and Reassembly



■ Necessary Tools

Item	Remark
<p>+SCREW DRIVER Q'ty 1 ea. To assembly and disassembly the screw</p>	
<p>MONKEY SPANNER Q'ty 1 ea. To assembly and disassembly the Fan motor and Compressor</p>	
<p>- SCREW DRIVER Q'ty 1 ea. To assembly and disassembly the screw</p>	

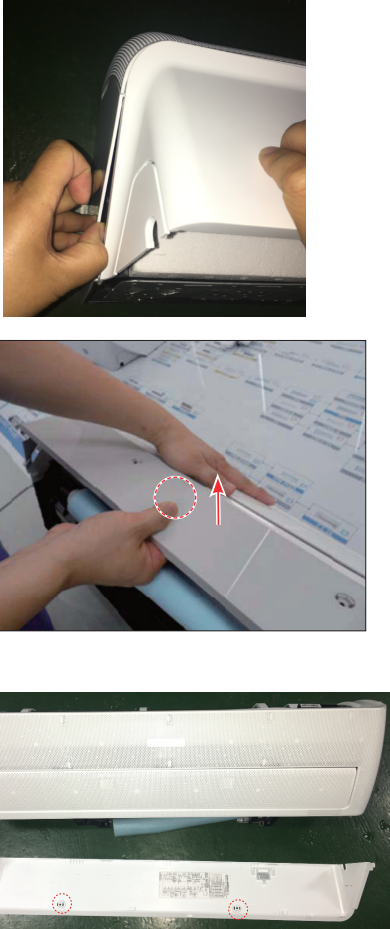

4-1. Indoor Unit

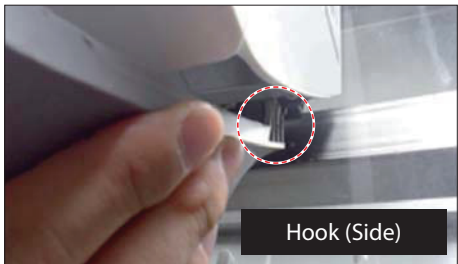
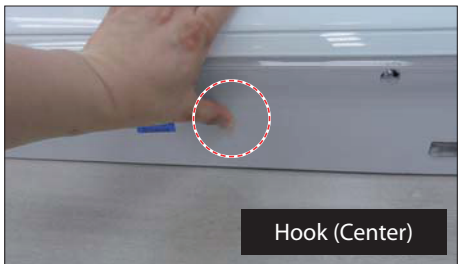
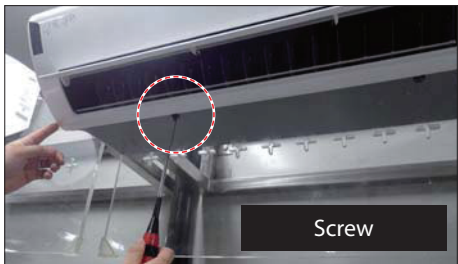

No.	Parts	Procedure	Remark												
1	PANEL-FRONT	<p>1) Stop the driving of air conditioner and shut off main power supply.</p> <p>2) Detach FILTER PRE from the PANEL FRONT.</p> <p>3) Cover Panel is assembled on bottom of indoorunit as shown in the figure. Remove the Cap Screw as shown on the right side and then remove the screw and separate the Cover Panel.</p>	   												
		<p>4) Cover Panel is fixed to body by Hook in center area and side area.</p>	 <table border="1" data-bbox="970 1731 1433 1884"> <thead> <tr> <th colspan="2"></th> <th colspan="2">HOOK</th> </tr> </thead> <tbody> <tr> <td>F03,F04</td> <td></td> <td></td> <td></td> </tr> <tr> <td>F05</td> <td></td> <td></td> <td></td> </tr> </tbody> </table>			HOOK		F03,F04				F05			
		HOOK													
F03,F04															
F05															

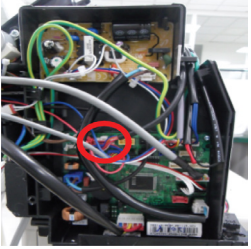
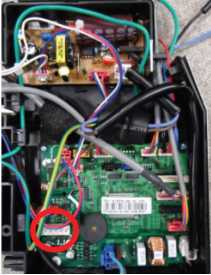
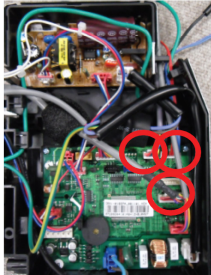
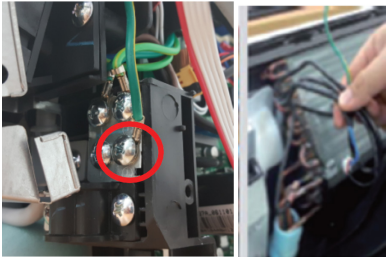
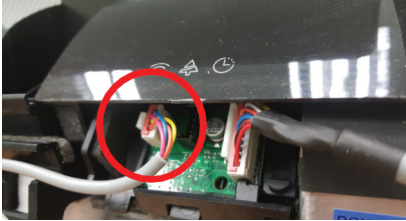
No.	Parts	Procedure	Remark
		<p>5) Separate the hook after pushing both end of Cover Panel as shown in the figure.(Watch out for the damage of the hook)</p> <p>6) Raise front part upward obliquely as shown in the figure and then remove the hooks.</p>	

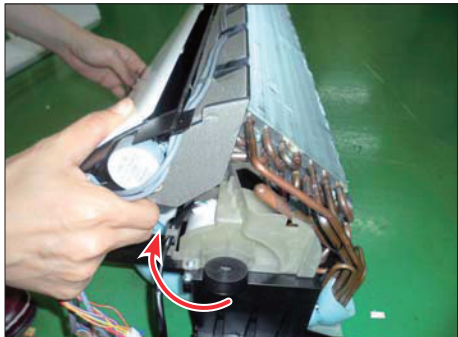
No.	Parts	Procedure	Remark
		<p>⚠ Caution: Assembly of Cover Panel after service end.</p> <ul style="list-style-type: none"> - Reassembly is in the reverse order of the removal. - Piping and drain hose must be careful not to damage and Progress must be done with both hands. 	  <p style="text-align: right;">Hook (Side)</p>  <p style="text-align: right;">Hook (Center)</p>  <p style="text-align: right;">Screw</p>  <p style="text-align: right;">Cap Screw</p>

No.	Parts	Procedure	Remark
2	CONTORL IN	<p>11) seperate Blade motor connect wire. Along with a picture</p> <p>12) Loosen MOTOR Wire.</p> <p>⚠ Caution: When you separate the connector, pull pressing the locking button.</p> <p>13) Loosen the Thermistor wires, Display wire and Humidity wire connector.</p> <p>⚠ Caution: When you separate the connector, pull pressing the locking button.</p> <p>14) Loosen the ground wire.</p> <p>15) Loosen the remote control PCB wire connector.</p> <p>⚠ Caution: When you separate the connector, pull pressing the locking button.</p>	    

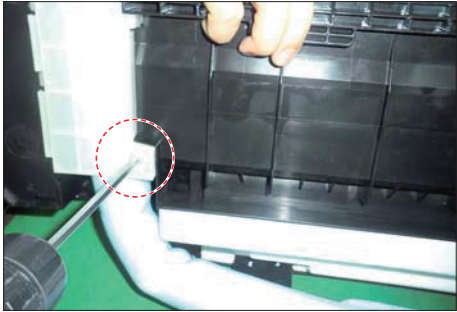

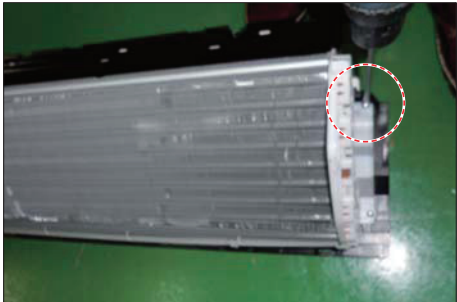
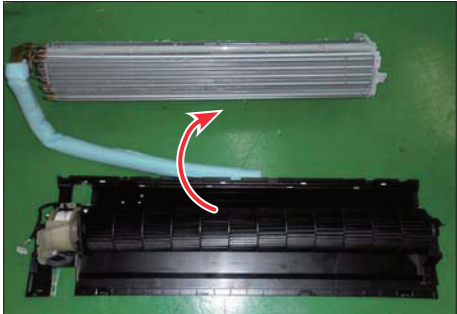

No.	Parts	Procedure	Remark
3	EVAPORATOR	16) Take off the CASE-CONTROL from the main frame after loosen the remaining connector. ▲ Caution: When you separate the connector, pull pressing the locking button.	
4	TRAY DRAIN	17) To detach TRAY-DRAIN from the main frame, pull the bottom of the TRAY-DRAIN towards you.	  

No.	Parts	Procedure	Remark
6	EVAPORATOR	<p>18) Detach the HOLDER PIPE.</p> <p>19) Unfasten the screw at the left side. (use + Screw Driver)</p> <p>20) Unfasten the screw at the right side. (use + Screw Driver)</p> <p>21) To detach Evaporator from the main frame, pull the bottom of the Evaporator towards you.</p>	   

No.	Parts	Procedure	Remark
7	FAN MOTOR & CROSS FAN	<p>22) Unfasten the screw. (use + Screw Driver)</p> <p>23) Detach the FAN Motor case.</p> <p>24) Unfasten the screw a little. (use + Screw Driver)</p> <p>25) Pull the CROSS-FAN to the left side.</p>	   

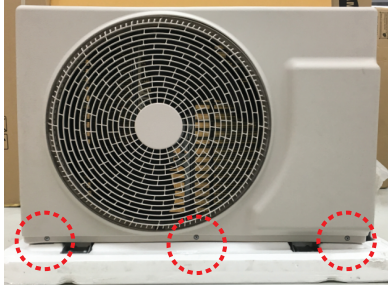

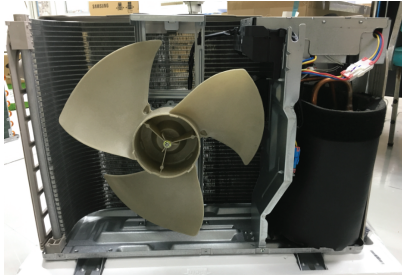

No.	Parts	Procedure	Remark
8	Assy SPI Lamp	<p>26) Remove the Assy SPI Lamp from the Back Body as shown on the right side.</p> <p>▲ Caution:</p> <ul style="list-style-type: none"> - Confirm Seal of backside necessarily after replace of Assy SPI Lamp. - Seal should be close adhesion to SPI Lamp. - Measure as shown on the right side since replace. <p>(If the seal is not close adhesion perfectly : Defectiveness can happen)</p>	

4-2 Outdoor Unit (N-V2MD model)

No	Parts	Procedure	Remark
1	Common Work	<p>1) First, stop the operation of the air conditioner, please cut off the supply of power.</p> <p>2) Please separate outdoor after loosen the bottom screw 3EA of the front three places. (+ screw driver Use)</p> <p>3) Please separate the positions of the sides screw 1EA (+ screw driver Use)</p> <p>4) Please remove the portions of the side screw 1. (+ screw driver Use)</p> <p>5) Please separate lifting up and grab the ends of the lower end of the CABINET FRONT.</p>	     <p><▲Separated CABINET FRONT ></p>

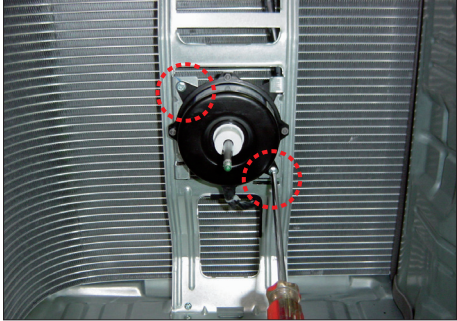
No.	Parts	Procedure	Remark
		<p>6) Please remove the screw 4ea located on the rear panel (use + screwdriver)</p> <p>7) Please separate the screw 2ea located on the side panel. (+ screw driver Use)</p> <p>8) Please separate the screw 4ea located on the side panel. (+ screw driver Use)</p> <p>9) Please remove the COVER CONTROL OUT downward.</p>	    

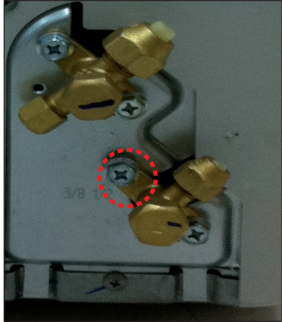
No.	Parts	Procedure	Remark
		<p>10) Please align the wire such as picture if you re-assemble after separate connector wire.</p> <p>⚠ If the connector is excessively folded, there is a risk of fire.</p> <p>11) Please remove the CABINET SIDE upward direction.</p>	 
2	FAN & MOTOR	<p>1) Please Loosen the NUT 1ea clockwise. (Using MONKEY SPANNER)</p> <p>2) Please remove the HOUSING's MOTOR WIRE.</p>	 

No.	Parts	Procedure	Remark
		<p>3) Remove the fixing points of the motor SCREW 2ea, please disconnect the MOTOR turning counterclockwise.</p>	
3	Capillary	<p>1) Please remove the weld point in one place. (COND-OUT)</p> <p>⚠ If you remove the compressor and heat exchanger, eliminate the refrigerant inside the compressor and heat exchanger completely with welding fire to remove the PIPE.</p> <p>2) Please separate NUT SERVICE-VALVE 2EA. (MONKEY SPANNER or + SCREW DRIVER Use)</p>	 
4	Condenser (heat exchanger)	<p>1) Please remove the welds in one place. (COND-IN)</p>	

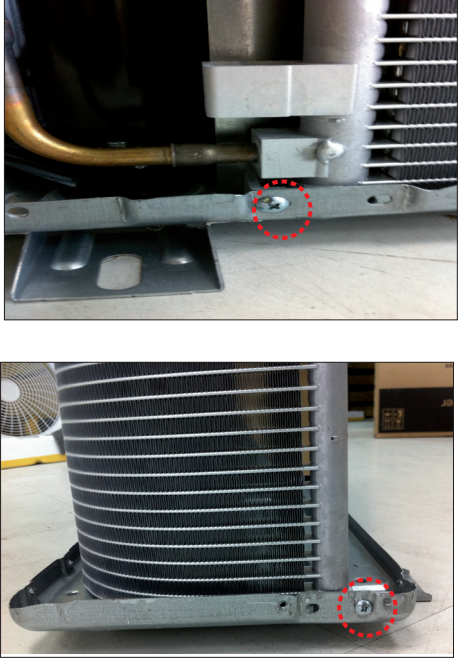
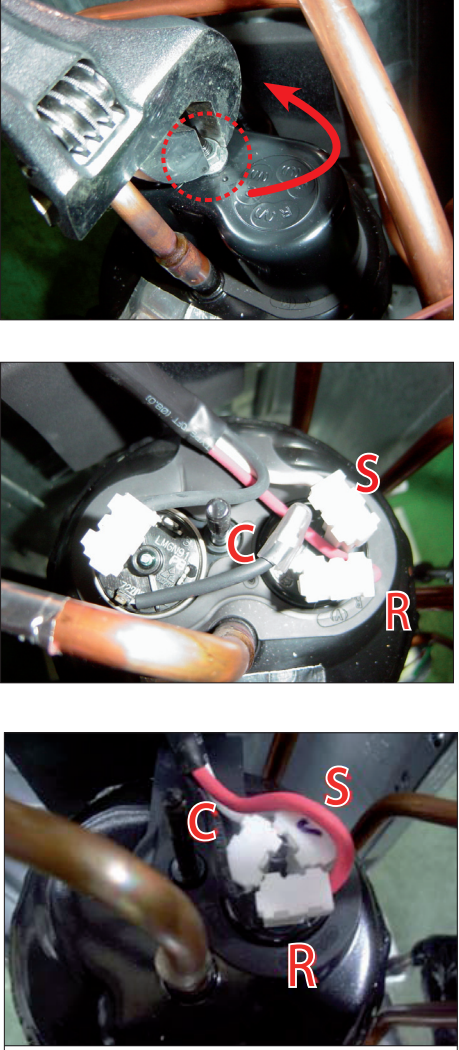

No.	Parts	Procedure	Remark
		<p>2) Please separate the two sides fixing screws loose. (+ SCREW DRIVER Use)</p>	
5	Compressor	<p>1) Please disassemble one NUT counterclockwise (using MONKEY SPANNER)</p> <p>[OLP external compressor] 2) Disassemble COVER-TERMINAL after remove the OLP.</p> <p>⚠ BE CAUTION Engraved position : C (black), S (white), R (red)</p> <p>[OLP internal compressor] 2) Please disassemble COVER-TERMINAL.</p>	

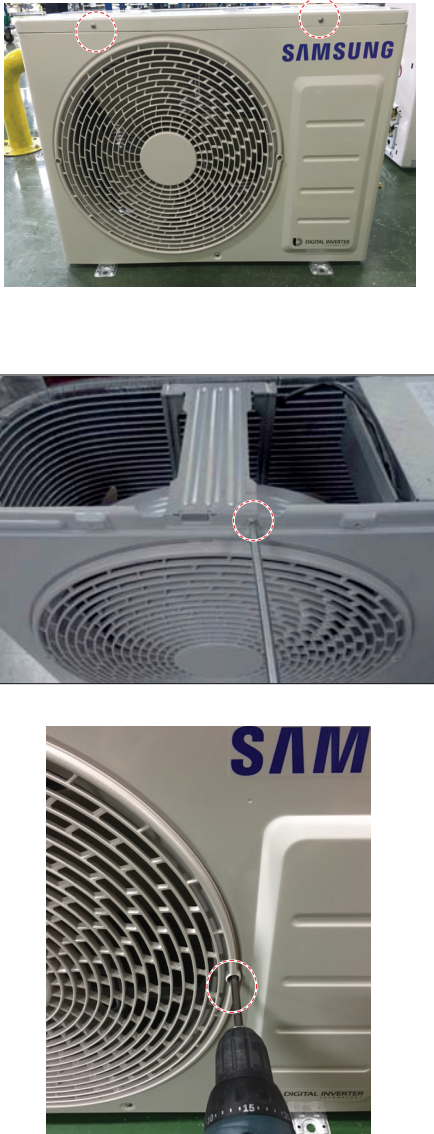
4-3 Outdoor Unit (N-WW)

No	Parts	Procedure	Remark
1	Common work	<p>1) Loosen each screws and detach the cabi Top cover.</p> <p>2) Loosen screws of the cabi front and detach it.</p>	

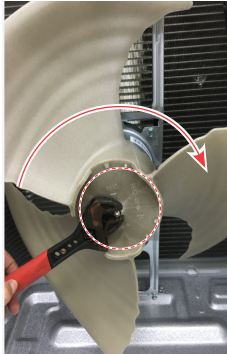
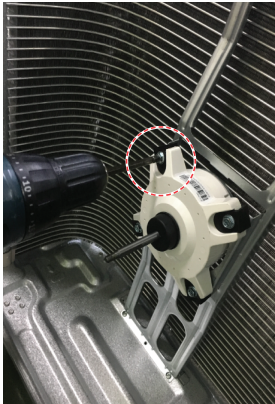
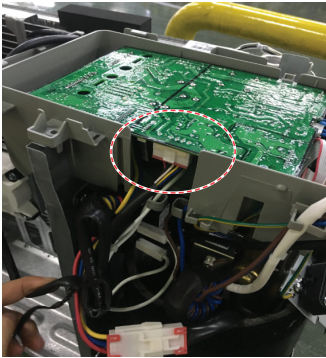
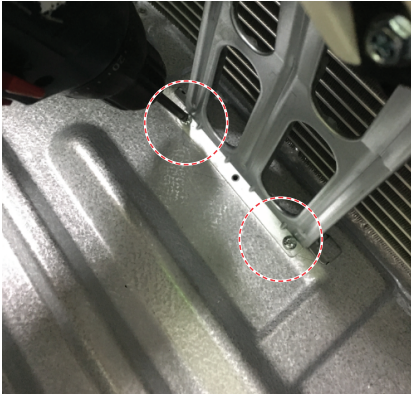
No	Parts	Procedure	Remark
		<p>3) Remove the 4 Cond Bar from the holder of outdoor unit cabinet. This process is supported by heating models only: AR*** NS*** series.</p> <p>4) Loosen fixing screws from the Cabi Front Lh and detach it.</p> <p>5) Loosen fixing screws from the Cabi Side Rh and detach it.</p>	   

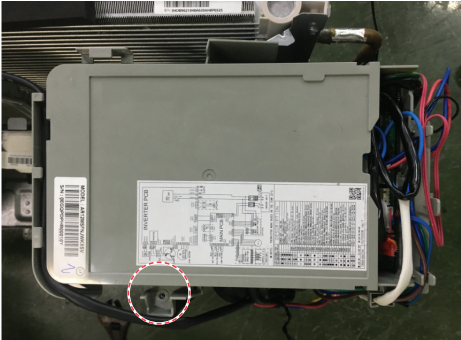
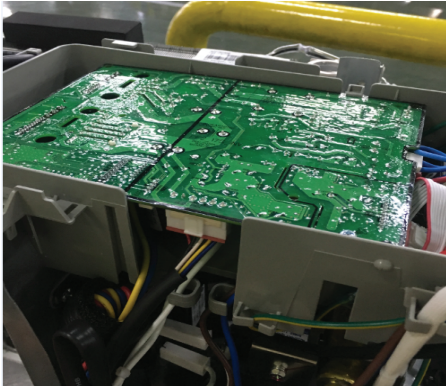
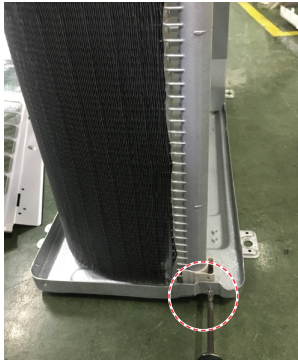
No	Parts	Procedure	Remark
2	Fan & Motor	<p>1) Detach the Nut Flange like the picture on the right side.(Turn clockwise because the screw is left-handed.) (Use Monkey Spanner.)</p> <p>2) Detach the Fan Propeller.</p> <p>3) Loosen 4 fixing screws to detach the Motor. (Use Monkey Spanner.)</p> <p>4) Disconnect the wire between Ass'y Control Out and Motor.</p> <p>5) Loosen 2 fixing bolts and detach the Bracket Motor</p>	   

No	Parts	Procedure	Remark
3	Ass'y Control Out	<ol style="list-style-type: none"> 1) To remove the Cover control box : Pull the motor wire is allow sufficient space as shown on the right side and then remove the screw. 2) Detach several connectors from the Ass'y Control Out. 3) Detach several connectors from the PCB of Ass'y Control Out. 	 
4	Heat Exchanger	<ol style="list-style-type: none"> 1) Release the refrigerant at first. 2) Loosen fixing screw on both sides. 3) Disassemble the pipes in both inlet and outlet with welding torch. 4) Detach the Heat Exchanger. 	 

5. ASSY CONTROL

5-1 ASSY KIT CODE DB92-04408A

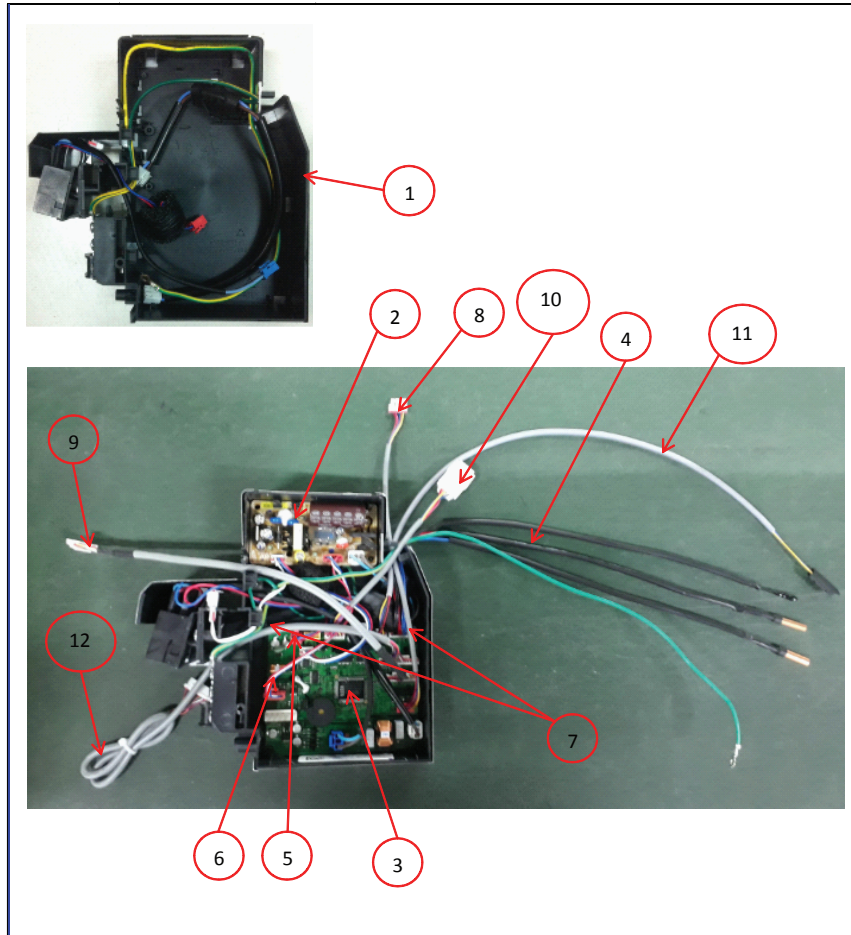

No	NAME	CODE	Q'ty
1	ASSY CASE ELECTRIC	DB90-07972N	1
2	SMPS PBA 11W	DB92-02861B	1
3	ASSY PCB MAIN	DB92-04101B	1
4	ASSY THERMISTOR	DB95-05163A	1
5	ASSY CONNECTOR WIRE-DC SIGNAL	DB93-14207A	1
6	ASSY CONNECTOR WIRE-DC SIGNAL	DB93-14208A	1
7	SCREW-TAPPING	6002-000630	2
8	ASSY CONNECTOR WIRE-DC SIGNAL	DB93-15445A	1
9	ASSY CONNECTOR WIRE-DISPLAY	DB93-14209B	1
10	ASSY CONNECTOR WIRE-DC SIGNAL	DB93-14218B	1
11	SENSOR HUMIDITY	DB32-00241A	1
12	ASSY CONNECTOR WIRE DC SIGNAL	DB93-14221A	1

5-2 ASSY KIT CODE DB92-04376B

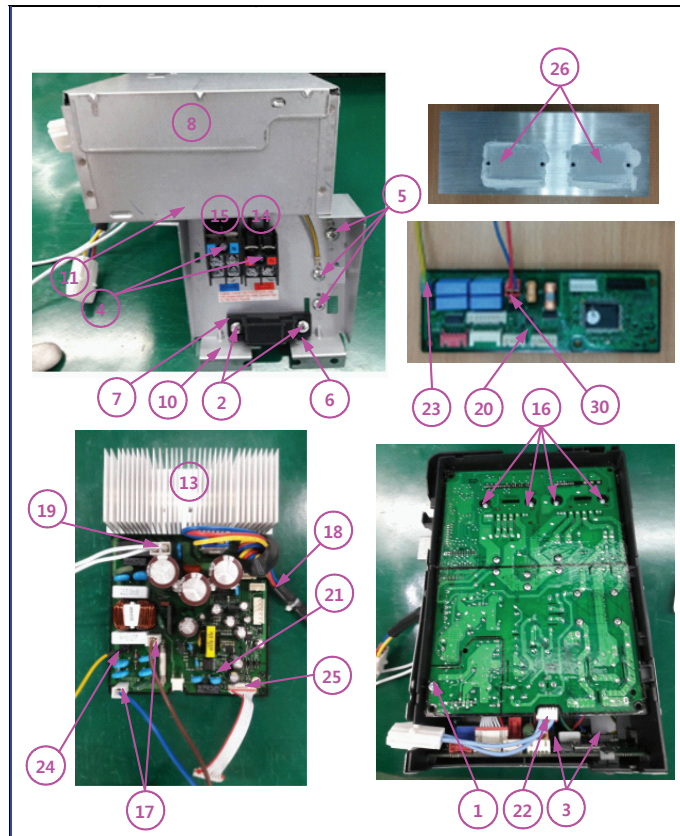

No	NAME	CODE	Q'ty
1	SCREW-TAPPING	6002-000536	1
2	SCREW-TAPPING	6002-000231	2
3	SCREW-TAPPING	6002-000239	2
4	SCREW-TAPPING	6002-000555	2
5	SCREW-SPECIAL	6009-001001	3
6	HOLDER-WIRE CLAMP	DB61-02200A	1
7	RUBBER	DB67-01534A	1
8	CASE CONTROL-UPPER S	DB61-06600A	1
9	COVER-CONTROL-UPPER INSIDE	DB63-03378A	1
10	PLATE-CONTROL OUT	DB61-06715B	1
11	PLATE-CONTROL LOW	DB61-06713A	1
12	CASE CONTROL-OUT	DB61-06714A	1
13	HEAT SINK	DB62-12196B	1
14	TERMINAL BLOCK	DB65-00274A	1
15	TERMINAL BLOCK	DB65-00298B	1
16	ASSY-SCREW MACHINE	DB91-00933A	4
17	ASSY CONNECTOR WIRE-POWER	DB93-09495S	1
18	ASSY CONNECTOR WIRE-COMP	DB93-10842D	1
19	ASSY CONNECTOR WIRE-REACTOR	DB93-15320B	1
20	ASSY PCB MAIN-OUT	DB92-04029D	1
21	ASSY PCB INVERTER	DB92-04025C	1
22	ASSY CONNECTOR WIRE 4-WAY	DB93-10846A	1
23	ASSY CONNECTOR WIRE-EARTH	DB93-12121B	1
24	ASSY CONNECTOR WIRE-EARTH	DB93-12121C	1
25	ASSY CONNECTOR WIRE	DB93-07452B	1
26	ASSY-THERMAL GREASE	0205-000178	0.002
27	ASSY-LABEL	DB98-33292A	1
28	ASSY-LABEL	DB98-33293A	1
29	ASSY-LABEL	DB98-34030A	1
30	ASSY CONNECTOR WIRE-COMM	DB93-16402A	1

5-3 ASSY KIT CODE DB92-04375B

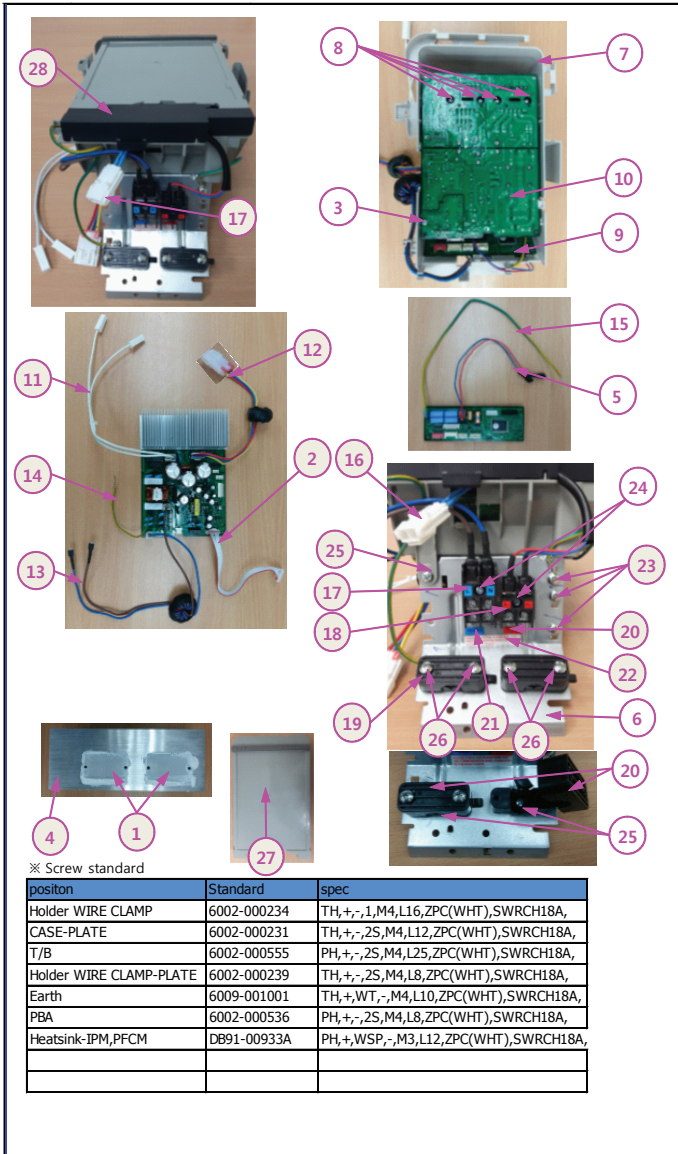

No	NAME	CODE	Q'ty	unit
1	GREASE-SILICON	0205-000178	0.002	KG
2	ASSY CONNECTOR WIRE	DB93-07452B	1	EA
3	SCREW-TAPPING	6002-000536	1	EA
4	HEAT SINK	DB62-12196B	1	EA
5	ASSY CONNECTOR WIRE-COMM	DB93-16402A	1	EA
6	PLATE CONTROL	DB61-05836A	1	EA
7	CASE CONTROL	DB61-06722A	1	EA
8	ASSY-SCREW MACHINE	DB91-00933A	4	EA
9	ASSY PCB MAIN	DB92-04029D	1	EA
10	ASSY PCB INVERTER	DB92-04025C	1	EA
11	ASSY CONNECTOR WIRE-REACTOR	DB93-15320A	1	EA
12	ASSY CONNECTOR WIRE-COMP	DB93-09497E	1	EA
13	ASSY CONNECTOR WIRE-POWER	DB93-16371A	1	EA
14	ASSY CONNECTOR WIRE-EARTH	DB93-12121B	1	EA
15	ASSY CONNECTOR WIRE-EARTH	DB93-12121C	1	EA
16	ASSY CONNECTOR WIRE 4-WAY	DB93-10846A	1	EA
17	TERMINAL BLOCK	DB65-00298B	1	EA
18	TERMINAL BLOCK	DB65-00274A	1	EA
19	HOLDER-WIRE CLAMP	DB61-00250A	2	EA
20	ASSY-LABEL	DB98-33292A	1	EA
21	ASSY-LABEL	DB98-33293A	1	EA
22	ASSY-LABEL	DB98-34030A	1	EA
23	SCREW SPACIAL	6009-001001	4	EA
24	SCREW	6002-000555	2	EA
25	SCREW	6002-000239	3	EA
26	SCREW	6002-000234	4	EA
27	ASSY COVER CONTROL	DB90-09878A	1	EA
28	COVER PCB	DB63-03885A	1	EA

6. Electrical Parts List

6-1 INDOOR MAIN PCB CODE DB92-04101B

Parts Code	Design Loc	Parts Description	Spec.	Quantity	Unit
0201-001528	COATING	ADHESIVE-SIL	LDC2577D,Y/GRN,175CPS,-	2	G
0201-001982	ADHESIVE-SIL	ADHESIVE-SIL	TSE3854DS-W,White,2.2,MIL-A-46146B,UL94V-0	0.0037	KG
0202-001338	SOLDER-BAR	SOLDER-BAR	Lead-free Solder BAR,W20L350H8,99.3Sn/0.7Cu/	0.17	G
0202-001463	SOLDER-WIRE	SOLDER-WIRE	LFC2-W3.0,D3,99.79Sn/0.2Cu/0.01P,NO Flux	1.51	G
0204-004665	FLUX	FLUX	KSP-70M-S,MIXTURE,NO,FLUX,13%	0.14	G
0204-005794	SOLVENT	SOLVENT	S-1000,(CH3)2CHOH,100%,0.79	1	G
0502-000245	Q701	TR-POWER	KSBI151-Y,PNP,1300mW,TO-126,160-320	1	PC
1405-001239	VA71	VARISTOR	680V,560VDC,6000A,17x10mm,TP,1120V,350pF,U	1	PC
2301-002032	XC71	C-FILM,LEAD-PPF	100nF,10%,275V,TP,12.5X6X12.0	1	PC
2301-002032	XC72	C-FILM,LEAD-PPF	100nF,10%,275V,TP,12.5X6X12.0	1	PC
3002-001139	BZ61	BUZZER-PIEZO	80dB,9V,2KHz,BK	1	PC
3711-000024	CN76	HEADER-BOARD TO CABLE	BOX,3P,1R,2.5MM,STRAIGHT,SN,WHT	1	PC
3711-000177	CN21	HEADER-BOARD TO CABLE	1WALL,2P,1R,3.96MM,STRAIGHT,SN,RED	1	PC
3711-000203	CN75	HEADER-BOARD TO CABLE	1WALL,2P,1R,7.92mm,STRAIGHT,SN,WHT,11.82x	1	PC
3711-000296	CN72	HEADER-BOARD TO CABLE	1WALL,6P,1R,3.96MM,STRAIGHT,SN,WHT	1	PC
3711-000941	CN81	HEADER-BOARD TO CABLE	BOX,4P,1R,2.5mm,STRAIGHT,SN,YEL	1	PC
3711-000998	CN77	CONNECTOR-HEADER	BOX,5P,1R,2.5MM,STRAIGHT,SN,RED	1	PC
3711-000999	CN61	HEADER-BOARD TO CABLE	BOX,5P,1R,2.5mm,STRAIGHT,SN,WHT,5.8x14.9x2	1	PC
3711-002001	CN31	HEADER-BOARD TO CABLE	BOX,20P,2R,2.0mm,STRAIGHT,SN,BLK,5.0X22.0X	1	PC
3711-003404	CN71	HEADER-BOARD TO CABLE	1WALL,2P,1R,7.92mm,STRAIGHT,SN,BLU	1	PC
3711-003845	CN91	HEADER-BOARD TO CABLE	BOX,11P,1R,2mm,STRAIGHT,SN,WHT	1	PC
3711-004122	CN32	HEADER-BOARD TO CABLE	BOX,14P,1R,2mm,STRAIGHT,SN,WHT	1	PC
3711-004236	CN43	HEADER-BOARD TO CABLE	BOX,6P,1R,2mm,STRAIGHT,SN,WHT	1	PC
3711-004379	CN42	HEADER-BOARD TO CABLE	BOX,4P,1R,2mm,STRAIGHT,SN,WHT	1	PC
3711-005096	CN63	HEADER-BOARD TO CABLE	BOX,5P,1R,2MM,STRAIGHT,SN,BLK	1	PC
3711-005097	CN62	HEADER-BOARD TO CABLE	BOX,5P,1R,2MM,STRAIGHT,SN,BLU	1	PC
DB27-00096A	FT71	COIL CHOKE	CV1615280,COIL CHOKE,28.0mH,+50~-30%,268.	1	PC
DB27-00102A	FT81	COIL CHOKE	1.0mH,2.5A,8.4x3.4,Mn-Zn,4,DIP	1	PC
DB94-06665A		ASSY PCB AUTO	MAIN,AR9500M,120*98,N,230V,19V, 12V, 5V,WIN	1	PC
0501-000362	Q801	TR-SMALL SIGNAL	KSC2328A-Y,NPN,1000mW,TO-92L,TP,160~320	1	PC
1404-001194	PTC2	THERMISTOR-PTC	39ohm,20%,220/240V,270Vac,1.2A,TP	1	PC
3601-001765	F701	FUSE-RADIAL LEAD	250V,3.15A,TIME-LAG,Thermoplastic,8.5x8mm	1	PC
3711-005098	CN51	HEADER-BOARD TO CABLE	BOX,5P,1R,2MM,STRAIGHT,SN,RED	1	PC
DB94-06666A		ASSY PCB SMD	MAIN,AR9500M,120*98,N,230V,19V, 12V, 5V,WIN	1	PC
0202-001933	SOLDER-CREAM	SOLDER-CREAM	LFM-48W TM-HP,D20~38um,96.5Sn/3Ag/0.5Cu,F	0.32	G
0402-001741	D701	DIODE-RECTIFIER	S1M,1000V,1A,SMA,TP	1	PC
0406-001005	TD420	DIODE-TVS	SM05,6V,20MAV,TP	1	PC
0406-001005	TD501	DIODE-TVS	SM05,6V,20MAV,TP	1	PC
0406-001204	CD81	DIODE-TVS	SMBJ5.0CA,6.4/-/7.25V,600W,SMB	1	PC
0406-001204	CD82	DIODE-TVS	SMBJ5.0CA,6.4/-/7.25V,600W,SMB	1	PC
0406-001204	CD83	DIODE-TVS	SMBJ5.0CA,6.4/-/7.25V,600W,SMB	1	PC
0501-000465	Q501	TR-SMALL SIGNAL	MMBT3904,NPN,350mW,SOT-23,TP,30~300	1	PC
0501-000465	Q702	TR-SMALL SIGNAL	MMBT3904,NPN,350mW,SOT-23,TP,30~300	1	PC
0504-001080	Q601	TR-DIGITAL	KRC246S,NPN,200mW,2.2K/10Kohm,SOT-23,TP	1	PC
0504-001080	Q802	TR-DIGITAL	KRC246S,NPN,200mW,2.2K/10Kohm,SOT-23,TP	1	PC
0506-000175	IC05	TR-ARRAY	2003,NPN,7,1000mW,SOP-16,TP,1000	1	PC
0506-000175	IC06	TR-ARRAY	2003,NPN,7,1000mW,SOP-16,TP,1000	1	PC
0604-001002	PC03	PHOTO-COUPLER	TR,100-600%,170mW,SOP-4,TP	1	PC
0604-001002	PC04	PHOTO-COUPLER	TR,100-600%,170mW,SOP-4,TP	1	PC
0604-001002	PC05	PHOTO-COUPLER	TR,100-600%,170mW,SOP-4,TP	1	PC
0801-000393	IC08	IC-CMOS LOGIC	74HC86,OR GATE,SOP,14P,150MIL,QUAD,ST,-,2.0	1	PC
1006-001325	IC07	IC-BUS TRANSCEIVER	SO,8P,4.9x3.8 mm,SINGLE,ST,PLASTIC,SV,-,40to+	1	PC
1202-000104	IC11	IC-VOLTAGE COMP.	393,SOP,8P,150MIL,DUAL,36V,CMOS,PLASTIC,18	1	PC
1203-006245	IC03	IC-VOL. DETECTOR	KIA7033AT,TSM,3P,2.9x1.6x0.7mm,PLASTIC,3.3V	1	PC
1203-007526	IC02	IC-POSIFIXED REG.	7815,TO-252,3Z30,6.6*6.1mm,14.4/15.6V,1.3W,-	1	PC
2007-000039	R717	R-CHIP	0ohm,1%,1/10W,TP,1608	1	PC
2007-000043	R703	R-CHIP	1Kohm,1%,1/10W,TP,1608	1	PC
2007-000043	R706	R-CHIP	1Kohm,1%,1/10W,TP,1608	1	PC
2007-000043	R805	R-CHIP	1Kohm,1%,1/10W,TP,1608	1	PC
2007-000043	R815	R-CHIP	1Kohm,1%,1/10W,TP,1608	1	PC
2007-000052	R701	R-CHIP	10Kohm,1%,1/10W,TP,1608	1	PC
2007-000052	R704	R-CHIP	10Kohm,1%,1/10W,TP,1608	1	PC
2007-000052	R705	R-CHIP	10Kohm,1%,1/10W,TP,1608	1	PC
2007-000052	R723	R-CHIP	10Kohm,1%,1/10W,TP,1608	1	PC
2007-000052	R801	R-CHIP	10Kohm,1%,1/10W,TP,1608	1	PC
2007-000052	R802	R-CHIP	10Kohm,1%,1/10W,TP,1608	1	PC
2007-000052	R803	R-CHIP	10Kohm,1%,1/10W,TP,1608	1	PC
2007-000052	R804	R-CHIP	10Kohm,1%,1/10W,TP,1608	1	PC
2007-000052	R816	R-CHIP	10Kohm,1%,1/10W,TP,1608	1	PC
2007-000116	R825	R-CHIP	120ohm,5%,1/10W,TP,1608	1	PC
2007-000143	R511	R-CHIP	4.7Kohm,5%,1/16W,TP,1005	1	PC
2007-000143	R512	R-CHIP	4.7Kohm,5%,1/16W,TP,1005	1	PC
2007-000143	R513	R-CHIP	4.7Kohm,5%,1/16W,TP,1005	1	PC
2007-000143	R552	R-CHIP	4.7Kohm,5%,1/16W,TP,1005	1	PC

Parts Code	Design Loc	Parts Description	Spec.	Quantity	Unit
2007-000148	R412	R-CHIP	10Kohm,5%,1/16W,TP,1005	1	PC
2007-000148	R413	R-CHIP	10Kohm,5%,1/16W,TP,1005	1	PC
2007-000148	R502	R-CHIP	10Kohm,5%,1/16W,TP,1005	1	PC
2007-000148	R503	R-CHIP	10Kohm,5%,1/16W,TP,1005	1	PC
2007-000148	R504	R-CHIP	10Kohm,5%,1/16W,TP,1005	1	PC
2007-000148	R505	R-CHIP	10Kohm,5%,1/16W,TP,1005	1	PC
2007-000148	R506	R-CHIP	10Kohm,5%,1/16W,TP,1005	1	PC
2007-000148	R521	R-CHIP	10Kohm,5%,1/16W,TP,1005	1	PC
2007-000148	R522	R-CHIP	10Kohm,5%,1/16W,TP,1005	1	PC
2007-000148	R523	R-CHIP	10Kohm,5%,1/16W,TP,1005	1	PC
2007-000148	R524	R-CHIP	10Kohm,5%,1/16W,TP,1005	1	PC
2007-000148	R525	R-CHIP	10Kohm,5%,1/16W,TP,1005	1	PC
2007-000148	R526	R-CHIP	10Kohm,5%,1/16W,TP,1005	1	PC
2007-000148	R527	R-CHIP	10Kohm,5%,1/16W,TP,1005	1	PC
2007-000148	R528	R-CHIP	10Kohm,5%,1/16W,TP,1005	1	PC
2007-000148	R529	R-CHIP	10Kohm,5%,1/16W,TP,1005	1	PC
2007-000148	R530	R-CHIP	10Kohm,5%,1/16W,TP,1005	1	PC
2007-000148	R531	R-CHIP	10Kohm,5%,1/16W,TP,1005	1	PC
2007-000148	R532	R-CHIP	10Kohm,5%,1/16W,TP,1005	1	PC
2007-000148	R533	R-CHIP	10Kohm,5%,1/16W,TP,1005	1	PC
2007-000148	R534	R-CHIP	10Kohm,5%,1/16W,TP,1005	1	PC
2007-000148	R543	R-CHIP	10Kohm,5%,1/16W,TP,1005	1	PC
2007-000148	R544	R-CHIP	10Kohm,5%,1/16W,TP,1005	1	PC
2007-000148	R551	R-CHIP	10Kohm,5%,1/16W,TP,1005	1	PC
2007-000148	R555	R-CHIP	10Kohm,5%,1/16W,TP,1005	1	PC
2007-000148	R556	R-CHIP	10Kohm,5%,1/16W,TP,1005	1	PC
2007-000148	R557	R-CHIP	10Kohm,5%,1/16W,TP,1005	1	PC
2007-000148	R807	R-CHIP	10Kohm,5%,1/16W,TP,1005	1	PC
2007-000148	R808	R-CHIP	10Kohm,5%,1/16W,TP,1005	1	PC
2007-000148	R810	R-CHIP	10Kohm,5%,1/16W,TP,1005	1	PC
2007-000148	R824	R-CHIP	10Kohm,5%,1/16W,TP,1005	1	PC
2007-000148	R826	R-CHIP	10Kohm,5%,1/16W,TP,1005	1	PC
2007-000148	R903	R-CHIP	10Kohm,5%,1/16W,TP,1005	1	PC
2007-000148	R904	R-CHIP	10Kohm,5%,1/16W,TP,1005	1	PC
2007-000157	R902	R-CHIP	47Kohm,5%,1/16W,TP,1005	1	PC
2007-000162	R820	R-CHIP	100Kohm,5%,1/16W,TP,1005	1	PC
2007-000162	R821	R-CHIP	100Kohm,5%,1/16W,TP,1005	1	PC
2007-000171	R831	R-CHIP	0ohm,5%,1/16W,TP,1005	1	PC
2007-000171	R833	R-CHIP	0ohm,5%,1/16W,TP,1005	1	PC
2007-000171	R835	R-CHIP	0ohm,5%,1/16W,TP,1005	1	PC
2007-000171	R837	R-CHIP	0ohm,5%,1/16W,TP,1005	1	PC
2007-000171	R839	R-CHIP	0ohm,5%,1/16W,TP,1005	1	PC
2007-000171	R843	R-CHIP	0ohm,5%,1/16W,TP,1005	1	PC
2007-000299	R702	R-CHIP	10Kohm,1%,1/4W,TP,3216	1	PC
2007-000385	R115	R-CHIP	14.3Kohm,1%,1/4W,TP,3216	1	PC
2007-000455	R712	R-CHIP	18Kohm,1%,1/10W,TP,1608	1	PC
2007-000475	R709	R-CHIP	1Mohm,1%,1/10W,TP,1608	1	PC
2007-000583	R714	R-CHIP	22Kohm,1%,1/10W,TP,1608	1	PC
2007-000763	R601	R-CHIP	330ohm,1%,1/10W,TP,1608	1	PC
2007-000763	R602	R-CHIP	330ohm,1%,1/10W,TP,1608	1	PC
2007-000763	R716	R-CHIP	330ohm,1%,1/10W,TP,1608	1	PC
2007-000828	R715	R-CHIP	39Kohm,1%,1/10W,TP,1608	1	PC
2007-000869	R707	R-CHIP	4.7Kohm,1%,1/10W,TP,1608	1	PC
2007-000924	R112	R-CHIP	470Kohm,1%,1/4W,TP,3216	1	PC
2007-000924	R113	R-CHIP	470Kohm,1%,1/4W,TP,3216	1	PC
2007-000924	R114	R-CHIP	470Kohm,1%,1/4W,TP,3216	1	PC
2007-000939	R711	R-CHIP	47Kohm,1%,1/10W,TP,1608	1	PC
2007-000979	R713	R-CHIP	5.6Kohm,1%,1/10W,TP,1608	1	PC
2007-001068	R708	R-CHIP	6.8Kohm,1%,1/10W,TP,1608	1	PC
2007-001313	R404	R-CHIP	330ohm,5%,1/16W,TP,1005	1	PC
2007-001313	R405	R-CHIP	330ohm,5%,1/16W,TP,1005	1	PC
2007-001313	R406	R-CHIP	330ohm,5%,1/16W,TP,1005	1	PC
2007-001313	R410	R-CHIP	330ohm,5%,1/16W,TP,1005	1	PC
2007-001313	R411	R-CHIP	330ohm,5%,1/16W,TP,1005	1	PC
2007-001313	R811	R-CHIP	330ohm,5%,1/16W,TP,1005	1	PC
2007-001433	R618	R-CHIP	12Kohm,1%,1/10W,TP,1608	1	PC
2007-007306	R508	R-CHIP	100ohm,1%,1/16W,TP,1005	1	PC
2007-007306	R515	R-CHIP	100ohm,1%,1/16W,TP,1005	1	PC
2007-007306	R516	R-CHIP	100ohm,1%,1/16W,TP,1005	1	PC
2007-007306	R517	R-CHIP	100ohm,1%,1/16W,TP,1005	1	PC
2007-007306	R518	R-CHIP	100ohm,1%,1/16W,TP,1005	1	PC
2007-007306	R519	R-CHIP	100ohm,1%,1/16W,TP,1005	1	PC

Parts Code	Design Loc	Parts Description	Spec.	Quantity	Unit
2007-007306	R520	R-CHIP	100ohm,1%,1/16W,TP,1005	1	PC
2007-007306	R539	R-CHIP	100ohm,1%,1/16W,TP,1005	1	PC
2007-007306	R542	R-CHIP	100ohm,1%,1/16W,TP,1005	1	PC
2007-007306	R553	R-CHIP	100ohm,1%,1/16W,TP,1005	1	PC
2007-007306	R809	R-CHIP	100ohm,1%,1/16W,TP,1005	1	PC
2007-007306	R905	R-CHIP	100ohm,1%,1/16W,TP,1005	1	PC
2007-007306	R906	R-CHIP	100ohm,1%,1/16W,TP,1005	1	PC
2007-007306	R907	R-CHIP	100ohm,1%,1/16W,TP,1005	1	PC
2007-007306	R908	R-CHIP	100ohm,1%,1/16W,TP,1005	1	PC
2007-007306	R909	R-CHIP	100ohm,1%,1/16W,TP,1005	1	PC
2007-007306	R910	R-CHIP	100ohm,1%,1/16W,TP,1005	1	PC
2007-007313	R401	R-CHIP	6.8Kohm,1%,1/16W,TP,1005	1	PC
2007-007313	R402	R-CHIP	6.8Kohm,1%,1/16W,TP,1005	1	PC
2007-007313	R403	R-CHIP	6.8Kohm,1%,1/16W,TP,1005	1	PC
2007-007318	R538	R-CHIP	1Kohm,1%,1/16W,TP,1005	1	PC
2007-007318	R545	R-CHIP	1Kohm,1%,1/16W,TP,1005	1	PC
2007-007318	R806	R-CHIP	1Kohm,1%,1/16W,TP,1005	1	PC
2007-007318	R901	R-CHIP	1Kohm,1%,1/16W,TP,1005	1	PC
2007-009922	R301	R-CHIP	300Kohm,1%,1/4W,TP,3216,T0.55	1	PC
2007-009922	R302	R-CHIP	300Kohm,1%,1/4W,TP,3216,T0.55	1	PC
2007-009922	R303	R-CHIP	300Kohm,1%,1/4W,TP,3216,T0.55	1	PC
2203-000257	C705	C-CER,CHIP	10nF,10%,50V,X7R,TP,1608	1	PC
2203-000257	C801	C-CER,CHIP	10nF,10%,50V,X7R,TP,1608	1	PC
2203-000438	C508	C-CER,CHIP	1nF,10%,50V,X7R,TP,1005	1	PC
2203-000438	C516	C-CER,CHIP	1nF,10%,50V,X7R,TP,1005	1	PC
2203-000438	C520	C-CER,CHIP	1nF,10%,50V,X7R,TP,1005	1	PC
2203-000438	C901	C-CER,CHIP	1nF,10%,50V,X7R,TP,1005	1	PC
2203-000440	C715	C-CER,CHIP	1nF,10%,50V,X7R,TP,1608	1	PC
2203-001071	C519	C-CER,CHIP	0.056nF,5%,50V,C0G,TP,1608	1	PC
2203-001083	C711	C-CER,CHIP	0.005nF,0.1pF,50V,NP0,TP,1608	1	PC
2203-005249	C501	C-CER,CHIP	100nF,10%,50V,X7R,TP,1608	1	PC
2203-005249	C513	C-CER,CHIP	100nF,10%,50V,X7R,TP,1608	1	PC
2203-005249	C514	C-CER,CHIP	100nF,10%,50V,X7R,TP,1608	1	PC
2203-005249	C702	C-CER,CHIP	100nF,10%,50V,X7R,TP,1608	1	PC
2203-005249	C704	C-CER,CHIP	100nF,10%,50V,X7R,TP,1608	1	PC
2203-005249	C710	C-CER,CHIP	100nF,10%,50V,X7R,TP,1608	1	PC
2203-005249	C712	C-CER,CHIP	100nF,10%,50V,X7R,TP,1608	1	PC
2203-005249	C713	C-CER,CHIP	100nF,10%,50V,X7R,TP,1608	1	PC
2203-005249	C802	C-CER,CHIP	100nF,10%,50V,X7R,TP,1608	1	PC
2203-005249	C803	C-CER,CHIP	100nF,10%,50V,X7R,TP,1608	1	PC
2203-005249	C805	C-CER,CHIP	100nF,10%,50V,X7R,TP,1608	1	PC
2203-005249	C806	C-CER,CHIP	100nF,10%,50V,X7R,TP,1608	1	PC
2203-005249	C807	C-CER,CHIP	100nF,10%,50V,X7R,TP,1608	1	PC
2203-006158	C401	C-CER,CHIP	100nF,10%,16V,X7R,TP,1005,T0.5	1	PC
2203-006158	C402	C-CER,CHIP	100nF,10%,16V,X7R,TP,1005,T0.5	1	PC
2203-006158	C403	C-CER,CHIP	100nF,10%,16V,X7R,TP,1005,T0.5	1	PC
2203-006158	C410	C-CER,CHIP	100nF,10%,16V,X7R,TP,1005,T0.5	1	PC
2203-006158	C411	C-CER,CHIP	100nF,10%,16V,X7R,TP,1005,T0.5	1	PC
2203-006158	C412	C-CER,CHIP	100nF,10%,16V,X7R,TP,1005,T0.5	1	PC
2203-006158	C517	C-CER,CHIP	100nF,10%,16V,X7R,TP,1005,T0.5	1	PC
2203-006158	C521	C-CER,CHIP	100nF,10%,16V,X7R,TP,1005,T0.5	1	PC
2203-006158	C522	C-CER,CHIP	100nF,10%,16V,X7R,TP,1005,T0.5	1	PC
2203-006158	C529	C-CER,CHIP	100nF,10%,16V,X7R,TP,1005,T0.5	1	PC
2203-006158	C530	C-CER,CHIP	100nF,10%,16V,X7R,TP,1005,T0.5	1	PC
2203-006158	C531	C-CER,CHIP	100nF,10%,16V,X7R,TP,1005,T0.5	1	PC
2203-006158	C533	C-CER,CHIP	100nF,10%,16V,X7R,TP,1005,T0.5	1	PC
2203-006158	C809	C-CER,CHIP	100nF,10%,16V,X7R,TP,1005,T0.5	1	PC
2203-006496	C707	C-CER,CHIP	2.2nF,10%,50V,X7R,1608	1	PC
2203-006960	C708	C-CER,CHIP	1000nF,10%,50V,X7R,TP,2012	1	PC
2203-007456	C509	C-CER,CHIP	1000nF,10%,25V,X5R,TP,1005(1106),T0.5	1	PC
2203-007456	C512	C-CER,CHIP	1000nF,10%,25V,X5R,TP,1005(1106),T0.5	1	PC
2203-007456	C515	C-CER,CHIP	1000nF,10%,25V,X5R,TP,1005(1106),T0.5	1	PC
2203-007456	C518	C-CER,CHIP	1000nF,10%,25V,X5R,TP,1005(1106),T0.5	1	PC
2203-007456	C523	C-CER,CHIP	1000nF,10%,25V,X5R,TP,1005(1106),T0.5	1	PC
2203-007456	C526	C-CER,CHIP	1000nF,10%,25V,X5R,TP,1005(1106),T0.5	1	PC
2203-007456	C528	C-CER,CHIP	1000nF,10%,25V,X5R,TP,1005(1106),T0.5	1	PC
2203-007456	C551	C-CER,CHIP	1000nF,10%,25V,X5R,TP,1005(1106),T0.5	1	PC
2203-007456	C552	C-CER,CHIP	1000nF,10%,25V,X5R,TP,1005(1106),T0.5	1	PC
2203-007456	C808	C-CER,CHIP	1000nF,10%,25V,X5R,TP,1005(1106),T0.5	1	PC
2203-007486	C804	C-CER,CHIP	1000nF,10%,50V,X5R,TP,1608	1	PC
2402-000120	C706	C-AL,SMD	10uF,20%,50V,GP,TP,6.6X6.6X5.4MM	1	PC
2402-001145	C701	C-AL,SMD	47uF,20%,50V,GP,TP,6.3X7.7mm	1	PC
2402-001145	C703	C-AL,SMD	47uF,20%,50V,GP,TP,6.3X7.7mm	1	PC
2802-001211	X501	RESONATOR-CERAMIC	8MHz,0.5%,TP,3.2x1.3x0.9 mm	1	PC
DB41-01362A	PCB MAIN	PCB MAIN	FR-4,2Layer,T1.6,120*98.4,WIND FREE, A-STD#4	1	PC
DB91-01837A	IC04	ASSY MICOM	17K_RAC_A3050_Inverter,STM-1632-OA,HART-m	1	PC
0903-001864	-	IC-MICROCONTROLLER	HART-M310,QFP,100P,20x14mm,8MHz,5V,600mV	1	PC

6-3 INDOOR DISPLAY PBA(DB92-04106A)

Parts Code	Design Loc	Parts Description	Spec.	Quantity	Unit
0201-001528	COATING	ADHESIVE-SIL	LDC2577D,Y/GRN,175CPS	0.5	G
0201-001982	ADHESIVE-SIL	ADHESIVE-SIL	TSE3854DS-W,White,2.2,MIL-A-46146B,UL94V-0	5.00E-04	KG
0202-001338	SOLDER-BAR	SOLDER-BAR	Lead-free Solder BAR,W20L350H8,99.3Sn/0.7Cu/	0.18	G
0202-001463	SOLDER-WIRE	SOLDER-WIRE	LFC2-W3.0,D3,99.79Sn/0.2Cu/0.01P,No Flux	1.62	G
0202-001608	SOLDER-WIRE FLUX	SOLDER-WIRE FLUX	LFC7-107,D0.8,99.3Sn/0.7Cu/0.01P,Flux 3.5%	0.05	G
0204-004665	FLUX	FLUX	KSP-70M-S,MIXTURE,NO,FLUX,13%	0.5	G
0204-005794	SOLVENT	SOLVENT	S-1000,(CH3)2CHOH,100%,0.79	0.5	G
3711-003845	CN01	HEADER-BOARD TO CABLE	BOX,11P,1R,2mm,STRAIGHT,SN,WHT	1	PC
3711-003942	CN03	HEADER-BOARD TO CABLE	BOX,2P,1R,2mm,STRAIGHT,SN,WHT,5.98x5.1x7.7	1	PC
3711-004379	CN02	HEADER-BOARD TO CABLE	BOX,4P,1R,2mm,STRAIGHT,SN,WHT	1	PC
3711-005096	CN04	HEADER-BOARD TO CABLE	BOX,5P,1R,2MM,STRAIGHT,SN,BLK	1	PC
DB07-00188A	IC02	LED DISPLAY	7S,2D,29mm*23mm*13.5mm,WHT,PIN	1	PC
DB94-06671A		ASSY PCB AUTO	SUB DISPLAY,WIND FREE,64*36,N,5V,WIND FREE	1	PC
0601-003285	LED1	LED	ROUND,WHT,3.1mm,3.9x5.4mm	1	PC
0601-003285	LED2	LED	ROUND,WHT,3.1mm,3.9x5.4mm	1	PC
0601-003285	LED3	LED	ROUND,WHT,3.1mm,3.9x5.4mm	1	PC
DB94-06672A		ASSY PCB SMD	SUB DISPLAY,WIND FREE,64*36,N,5V,WIND FREE	1	PC
0202-001933	SOLDER-CREAM	SOLDER-CREAM	LFM-48W TM-HP,D20~38um,96.5Sn/3Ag/0.5Cu,F	0.5	G
0403-000258	ZD01	DIODE-ZENER	BZX84C5V6,5.2~6V,225mW,SOT-23,TP,5.6V	1	PC
0501-000465	Q01	TR-SMALL SIGNAL	MMBT3904,NPN,350mW,SOT-23,TP,30~300	1	PC
1003-002078	IC01	IC-LED DRIVER	SO24,24P,7.55x15.48mm,TP,PLASTIC,5,-45+85,1	1	PC
2007-000039	R05	R-CHIP	0ohm,1%,1/10W,TP,1608	1	PC
2007-000043	R03	R-CHIP	1Kohm,1%,1/10W,TP,1608	1	PC
2007-000052	R02	R-CHIP	10Kohm,1%,1/10W,TP,1608	1	PC
2007-000052	R04	R-CHIP	10Kohm,1%,1/10W,TP,1608	1	PC
2007-000052	R06	R-CHIP	10Kohm,1%,1/10W,TP,1608	1	PC
2007-000052	R09	R-CHIP	10Kohm,1%,1/10W,TP,1608	1	PC
2007-000491	R08	R-CHIP	2.2Kohm,1%,1/10W,TP,1608	1	PC
2007-000869	R07	R-CHIP	4.7Kohm,1%,1/10W,TP,1608	1	PC
2203-000257	C04	C-CER,CHIP	10nF,10%,50V,X7R,TP,1608	1	PC
2203-000440	C03	C-CER,CHIP	1nF,10%,50V,X7R,TP,1608	1	PC
2203-005249	C02	C-CER,CHIP	100nF,10%,50V,X7R,TP,1608	1	PC
2203-005249	C05	C-CER,CHIP	100nF,10%,50V,X7R,TP,1608	1	PC
2402-001368	C01	C-AL,SMD	47uF,20%,25V,TP,6.3x4.9mm	1	PC
DB41-01365A	PCB DISPLAY	PCB DISPLAY	FR-4,2Layer,T1.6,64*36,12,WIND FREE, 88DISPL	1	PC

6-2 OUTDOOR MAIN PCB CODE DB92-04029D

Parts Code	Design Loc	Parts Description	Spec.	Quantity	Unit
0204-005754	COATING	COATING	SL 1301 ECO,55±5s,colorless	0.004	PC
DB94-06515A	-	ASSY PCB MANUAL	17 S-INV,OUTDOOR MAIN,17 S-INV,284*194,220	1	PC
0201-001528	ADHESIVE-SIL	ADHESIVE-SIL	LDC2577D,Y/GRN,175CPS,-	1	G
0202-001463	SOLDER-WIRE	SOLDER-WIRE	LFC2-W3.0,D3,99.79Sn/0.2Cu/0.01P,No Flux	6	G
0202-001608	SOLDER-WIRE FLUX	SOLDER-WIRE FLUX	LFC7-107,D0.8,99.3Sn/0.7Cu/0.01P,Flux 3.5%	0.2	G
0204-004665	FLUX	FLUX	KSP-70M-S,MIXTURE,NO,FLUX,13%	3	G
2301-001935	C308	C-FILM,LEAD	22nF,20%,300V,BK,18x7x13.5mm	1	PC
2301-001935	C309	C-FILM,LEAD	22nF,20%,300V,BK,18x7x13.5mm	1	PC
2301-001935	C310	C-FILM,LEAD	22nF,20%,300V,BK,18x7x13.5mm	1	PC
2301-001935	C311	C-FILM,LEAD	22nF,20%,300V,BK,18x7x13.5mm	1	PC
3711-000012	CN291	HEADER-BOARD TO CABLE	BOX,4P,1R,2.5MM,STRAIGHT,SN,WHT	1	PC
3711-000177	CN301	HEADER-BOARD TO CABLE	1WALL,2P,1R,3.96MM,STRAIGHT,SN,RED	1	PC
3711-000999	CN281	HEADER-BOARD TO CABLE	BOX,5P,1R,2.5mm,STRAIGHT,SN,WHT,5.8x14.9x7	1	PC
3711-001084	CN261	HEADER-BOARD TO CABLE	BOX,8P,1R,2.5mm,STRAIGHT,SN,WHT,5.8x22.4x7	1	PC
3711-002001	CN230	HEADER-BOARD TO CABLE	BOX,20P,2R,2.0mm,STRAIGHT,SN,BLK,5.0x22.0x7	1	PC
3711-003846	CN251	HEADER-BOARD TO CABLE	BOX,8P,1R,2mm,ANGLE,SN,WHT	1	PC
3711-006337	CN701	CONNECTOR-HEADER	BOX,5P,1R,2.5mm,ANGLE,SN,RED	1	PC
3711-007817	CN271	HEADER-BOARD TO BOARD	3WALL,7P,1R,2mm,STRAIGHT,SN,WHT	1	PC
3712-001047	CN302	CONNECTOR-TERMINAL	TAB,MALE,N,0.5/4.75mm	1	PC
DB27-00082A	L302	COIL CHOKE	40mH,0.5A,8.4x3.4,Mn-Zn	1	PC
DB27-00090A	L301	COIL CHOKE	31uH,13*15	1	PC
DB94-06511A	-	ASSY PCB AUTO	17 S-INV,OUTDOOR MAIN,17 S-INV,284*194,220	1	PC
1404-001194	PTC301	THERMISTOR-PTC	39ohm,20%,220/240V,270Vac,1.2A,TP	1	PC
DB27-00034A	BEAD301	COIL CHOKE	0.0012mH,2A	1	PC
DB94-06512A	-	ASSY PCB SMD	17 S-INV,OUTDOOR MAIN,17 S-INV,284*194,220	1	PC
0202-001933	SOLDER-CREAM	SOLDER-CREAM	LFM-48W TM-HP,D20~38um,96.5Sn/3Ag/0.5Cu,F	1	G
0406-001204	TD301	DIODE-TVS	SMBJ5.0CA,6.4/-/7.25V,600W,SMB	1	PC
0406-001204	TD302	DIODE-TVS	SMBJ5.0CA,6.4/-/7.25V,600W,SMB	1	PC
0406-001204	TD303	DIODE-TVS	SMBJ5.0CA,6.4/-/7.25V,600W,SMB	1	PC
0506-000175	IC701	TR-ARRAY	2003,NPN,7,1000mW,SOP-16,ST,1000	1	PC
0601-002345	LED801	LED	SMD,RED,1.6x0.8x0.55mm,660nm,1.6x0.8x0.55mm	1	PC
0601-002419	LED803	LED	SMD(TOP VIEW),YEL,1.6x0.8mm,591nm,1.6x0.8x0.55mm	1	PC
0601-002679	LED802	LED	SMD(TOP VIEW),Y-GRN,1.6x0.8mm,573nm,1.6x0.8x0.55mm	1	PC
0801-000393	IC302	IC-CMOS LOGIC	74HC86,OR GATE,SOP,14P,150MIL,QUAD,ST,-,2.0	1	PC
1006-001325	IC301	IC-BUS TRANSCEIVER	SO,8P,4.9x3.8 mm,SINGLE,ST,PLASTIC,5V,-40to+	1	PC
1203-006245	IC230	IC-VOL. DETECTOR	KIA7033AT,TSM,3P,2.9x1.6x0.7mm,PLASTIC,3.3V	1	PC
2007-000116	R304	R-CHIP	120ohm,5%,1/10W,TP,1608	1	PC
2007-000148	R201	R-CHIP	10Kohm,5%,1/16W,TP,1005	1	PC
2007-000148	R202	R-CHIP	10Kohm,5%,1/16W,TP,1005	1	PC
2007-000148	R203	R-CHIP	10Kohm,5%,1/16W,TP,1005	1	PC
2007-000148	R204	R-CHIP	10Kohm,5%,1/16W,TP,1005	1	PC
2007-000148	R205	R-CHIP	10Kohm,5%,1/16W,TP,1005	1	PC
2007-000148	R206	R-CHIP	10Kohm,5%,1/16W,TP,1005	1	PC
2007-000148	R207	R-CHIP	10Kohm,5%,1/16W,TP,1005	1	PC
2007-000148	R208	R-CHIP	10Kohm,5%,1/16W,TP,1005	1	PC
2007-000148	R209	R-CHIP	10Kohm,5%,1/16W,TP,1005	1	PC
2007-000148	R210	R-CHIP	10Kohm,5%,1/16W,TP,1005	1	PC
2007-000148	R212	R-CHIP	10Kohm,5%,1/16W,TP,1005	1	PC
2007-000148	R213	R-CHIP	10Kohm,5%,1/16W,TP,1005	1	PC
2007-000148	R214	R-CHIP	10Kohm,5%,1/16W,TP,1005	1	PC
2007-000148	R215	R-CHIP	10Kohm,5%,1/16W,TP,1005	1	PC
2007-000148	R216	R-CHIP	10Kohm,5%,1/16W,TP,1005	1	PC
2007-000148	R217	R-CHIP	10Kohm,5%,1/16W,TP,1005	1	PC
2007-000148	R218	R-CHIP	10Kohm,5%,1/16W,TP,1005	1	PC
2007-000148	R219	R-CHIP	10Kohm,5%,1/16W,TP,1005	1	PC
2007-000148	R220	R-CHIP	10Kohm,5%,1/16W,TP,1005	1	PC
2007-000148	R221	R-CHIP	10Kohm,5%,1/16W,TP,1005	1	PC
2007-000148	R222	R-CHIP	10Kohm,5%,1/16W,TP,1005	1	PC

Parts Code	Design Loc	Parts Description	Spec.	Quantity	Unit
2007-000148	R223	R-CHIP	10Kohm,5%,1/16W,TP,1005	1	PC
2007-000148	R237	R-CHIP	10Kohm,5%,1/16W,TP,1005	1	PC
2007-000148	R238	R-CHIP	10Kohm,5%,1/16W,TP,1005	1	PC
2007-000148	R239	R-CHIP	10Kohm,5%,1/16W,TP,1005	1	PC
2007-000148	R240	R-CHIP	10Kohm,5%,1/16W,TP,1005	1	PC
2007-000148	R241	R-CHIP	10Kohm,5%,1/16W,TP,1005	1	PC
2007-000148	R242	R-CHIP	10Kohm,5%,1/16W,TP,1005	1	PC
2007-000148	R250	R-CHIP	10Kohm,5%,1/16W,TP,1005	1	PC
2007-000148	R271	R-CHIP	10Kohm,5%,1/16W,TP,1005	1	PC
2007-000148	R272	R-CHIP	10Kohm,5%,1/16W,TP,1005	1	PC
2007-000148	R284	R-CHIP	10Kohm,5%,1/16W,TP,1005	1	PC
2007-000148	R285	R-CHIP	10Kohm,5%,1/16W,TP,1005	1	PC
2007-000148	R286	R-CHIP	10Kohm,5%,1/16W,TP,1005	1	PC
2007-000148	R306	R-CHIP	10Kohm,5%,1/16W,TP,1005	1	PC
2007-000148	R307	R-CHIP	10Kohm,5%,1/16W,TP,1005	1	PC
2007-000148	R308	R-CHIP	10Kohm,5%,1/16W,TP,1005	1	PC
2007-000148	R309	R-CHIP	10Kohm,5%,1/16W,TP,1005	1	PC
2007-000148	R310	R-CHIP	10Kohm,5%,1/16W,TP,1005	1	PC
2007-000171	R312	R-CHIP	0ohm,5%,1/16W,TP,1005	1	PC
2007-000455	R251	R-CHIP	18Kohm,1%,1/10W,TP,1608	1	PC
2007-000455	R253	R-CHIP	18Kohm,1%,1/10W,TP,1608	1	PC
2007-000614	R252	R-CHIP	24Kohm,1%,1/10W,TP,1608	1	PC
2007-000614	R254	R-CHIP	24Kohm,1%,1/10W,TP,1608	1	PC
2007-000763	R255	R-CHIP	330ohm,1%,1/10W,TP,1608	1	PC
2007-000763	R256	R-CHIP	330ohm,1%,1/10W,TP,1608	1	PC
2007-000763	R257	R-CHIP	330ohm,1%,1/10W,TP,1608	1	PC
2007-000763	R258	R-CHIP	330ohm,1%,1/10W,TP,1608	1	PC
2007-000869	R801	R-CHIP	4.7Kohm,1%,1/10W,TP,1608	1	PC
2007-000869	R802	R-CHIP	4.7Kohm,1%,1/10W,TP,1608	1	PC
2007-000869	R803	R-CHIP	4.7Kohm,1%,1/10W,TP,1608	1	PC
2007-001433	R225	R-CHIP	12Kohm,1%,1/10W,TP,1608	1	PC
2007-007306	R224	R-CHIP	100ohm,1%,1/16W,TP,1005	1	PC
2007-007306	R231	R-CHIP	100ohm,1%,1/16W,TP,1005	1	PC
2007-007306	R232	R-CHIP	100ohm,1%,1/16W,TP,1005	1	PC
2007-007306	R233	R-CHIP	100ohm,1%,1/16W,TP,1005	1	PC
2007-007306	R234	R-CHIP	100ohm,1%,1/16W,TP,1005	1	PC
2007-007306	R235	R-CHIP	100ohm,1%,1/16W,TP,1005	1	PC
2007-007306	R243	R-CHIP	100ohm,1%,1/16W,TP,1005	1	PC
2007-007306	R244	R-CHIP	100ohm,1%,1/16W,TP,1005	1	PC
2007-007306	R245	R-CHIP	100ohm,1%,1/16W,TP,1005	1	PC
2007-007306	R246	R-CHIP	100ohm,1%,1/16W,TP,1005	1	PC
2007-007306	R247	R-CHIP	100ohm,1%,1/16W,TP,1005	1	PC
2007-007306	R248	R-CHIP	100ohm,1%,1/16W,TP,1005	1	PC
2007-007306	R249	R-CHIP	100ohm,1%,1/16W,TP,1005	1	PC
2007-007306	R261	R-CHIP	100ohm,1%,1/16W,TP,1005	1	PC
2007-007306	R262	R-CHIP	100ohm,1%,1/16W,TP,1005	1	PC
2007-007306	R263	R-CHIP	100ohm,1%,1/16W,TP,1005	1	PC
2007-007306	R264	R-CHIP	100ohm,1%,1/16W,TP,1005	1	PC
2007-007306	R273	R-CHIP	100ohm,1%,1/16W,TP,1005	1	PC
2007-007306	R274	R-CHIP	100ohm,1%,1/16W,TP,1005	1	PC
2007-007306	R275	R-CHIP	100ohm,1%,1/16W,TP,1005	1	PC
2007-007306	R276	R-CHIP	100ohm,1%,1/16W,TP,1005	1	PC
2007-007306	R281	R-CHIP	100ohm,1%,1/16W,TP,1005	1	PC
2007-007306	R282	R-CHIP	100ohm,1%,1/16W,TP,1005	1	PC
2007-007306	R283	R-CHIP	100ohm,1%,1/16W,TP,1005	1	PC
2007-007306	R291	R-CHIP	100ohm,1%,1/16W,TP,1005	1	PC
2007-007306	R292	R-CHIP	100ohm,1%,1/16W,TP,1005	1	PC
2007-007318	R303	R-CHIP	1Kohm,1%,1/16W,TP,1005	1	PC
2007-007318	R305	R-CHIP	1Kohm,1%,1/16W,TP,1005	1	PC
2007-007318	R311	R-CHIP	1Kohm,1%,1/16W,TP,1005	1	PC
2007-007942	R211	R-CHIP	1Mohm,1%,1/16W,TP,1005	1	PC

Parts Code	Design Loc	Parts Description	Spec.	Quantity	Unit
2203-000438	C211	C-CER,CHIP	1nF,10%,50V,X7R,TP,1005	1	PC
2203-000438	C219	C-CER,CHIP	1nF,10%,50V,X7R,TP,1005	1	PC
2203-000438	C220	C-CER,CHIP	1nF,10%,50V,X7R,TP,1005	1	PC
2203-000438	C281	C-CER,CHIP	1nF,10%,50V,X7R,TP,1005	1	PC
2203-000438	C282	C-CER,CHIP	1nF,10%,50V,X7R,TP,1005	1	PC
2203-000438	C283	C-CER,CHIP	1nF,10%,50V,X7R,TP,1005	1	PC
2203-001071	C210	C-CER,CHIP	0.056nF,5%,50V,C0G,TP,1608	1	PC
2203-002285	C302	C-CER,CHIP	10nF,10%,50V,X7R,TP,1005	1	PC
2203-002285	C303	C-CER,CHIP	10nF,10%,50V,X7R,TP,1005	1	PC
2203-005249	C251	C-CER,CHIP	100nF,10%,50V,X7R,TP,1608	1	PC
2203-005249	C252	C-CER,CHIP	100nF,10%,50V,X7R,TP,1608	1	PC
2203-005249	C253	C-CER,CHIP	100nF,10%,50V,X7R,TP,1608	1	PC
2203-005249	C254	C-CER,CHIP	100nF,10%,50V,X7R,TP,1608	1	PC
2203-005249	C701	C-CER,CHIP	100nF,10%,50V,X7R,TP,1608	1	PC
2203-005249	C702	C-CER,CHIP	100nF,10%,50V,X7R,TP,1608	1	PC
2203-006158	C202	C-CER,CHIP	100nF,10%,16V,X7R,TP,1005,T0.5	1	PC
2203-006158	C203	C-CER,CHIP	100nF,10%,16V,X7R,TP,1005,T0.5	1	PC
2203-006158	C206	C-CER,CHIP	100nF,10%,16V,X7R,TP,1005,T0.5	1	PC
2203-006158	C209	C-CER,CHIP	100nF,10%,16V,X7R,TP,1005,T0.5	1	PC
2203-006158	C212	C-CER,CHIP	100nF,10%,16V,X7R,TP,1005,T0.5	1	PC
2203-006158	C215	C-CER,CHIP	100nF,10%,16V,X7R,TP,1005,T0.5	1	PC
2203-006158	C216	C-CER,CHIP	100nF,10%,16V,X7R,TP,1005,T0.5	1	PC
2203-006158	C218	C-CER,CHIP	100nF,10%,16V,X7R,TP,1005,T0.5	1	PC
2203-006158	C248	C-CER,CHIP	100nF,10%,16V,X7R,TP,1005,T0.5	1	PC
2203-006158	C304	C-CER,CHIP	100nF,10%,16V,X7R,TP,1005,T0.5	1	PC
2203-006158	C305	C-CER,CHIP	100nF,10%,16V,X7R,TP,1005,T0.5	1	PC
2203-006158	C306	C-CER,CHIP	100nF,10%,16V,X7R,TP,1005,T0.5	1	PC
2203-006158	C307	C-CER,CHIP	100nF,10%,16V,X7R,TP,1005,T0.5	1	PC
2203-007306	C261	C-CER,CHIP	1000nF,10%,25V,X5R,TP,2012,1.25T	1	PC
2203-007306	C262	C-CER,CHIP	1000nF,10%,25V,X5R,TP,2012,1.25T	1	PC
2203-007456	C201	C-CER,CHIP	1000nF,10%,25V,X5R,TP,1005(1106),T0.5	1	PC
2203-007456	C204	C-CER,CHIP	1000nF,10%,25V,X5R,TP,1005(1106),T0.5	1	PC
2203-007456	C205	C-CER,CHIP	1000nF,10%,25V,X5R,TP,1005(1106),T0.5	1	PC
2203-007456	C207	C-CER,CHIP	1000nF,10%,25V,X5R,TP,1005(1106),T0.5	1	PC
2203-007456	C208	C-CER,CHIP	1000nF,10%,25V,X5R,TP,1005(1106),T0.5	1	PC
2203-007456	C213	C-CER,CHIP	1000nF,10%,25V,X5R,TP,1005(1106),T0.5	1	PC
2203-007456	C214	C-CER,CHIP	1000nF,10%,25V,X5R,TP,1005(1106),T0.5	1	PC
2203-007456	C217	C-CER,CHIP	1000nF,10%,25V,X5R,TP,1005(1106),T0.5	1	PC
2802-001211	X201	RESONATOR-CERAMIC	8MHz,0.5%,TP,3.2x1.3x0.9 mm	1	PC
DB41-01352A	PCB	PCB MAIN	FR-4,2Layer,T1.6,142*48.5,8,RAC_OUT_MAIN,10	1	PC
DB91-01825A	IC231	ASSY MICOM	16_RAC_PF23_SG_OUT,STM-1622-OA, HART_M3	1	PC
0903-001864	-	IC-MICROCONTROLLER	HART-M310,QFP,100P,20x14mm,8MHz,5V,600mW	1	PC

7. Wiring Diagram

7-1 Indoor Unit

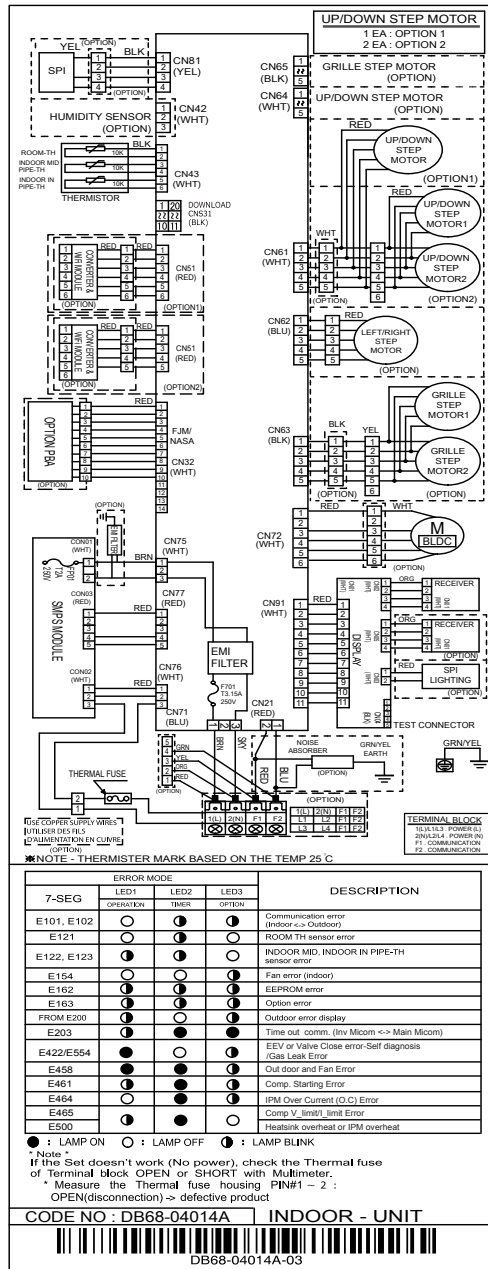

Indoor Unit

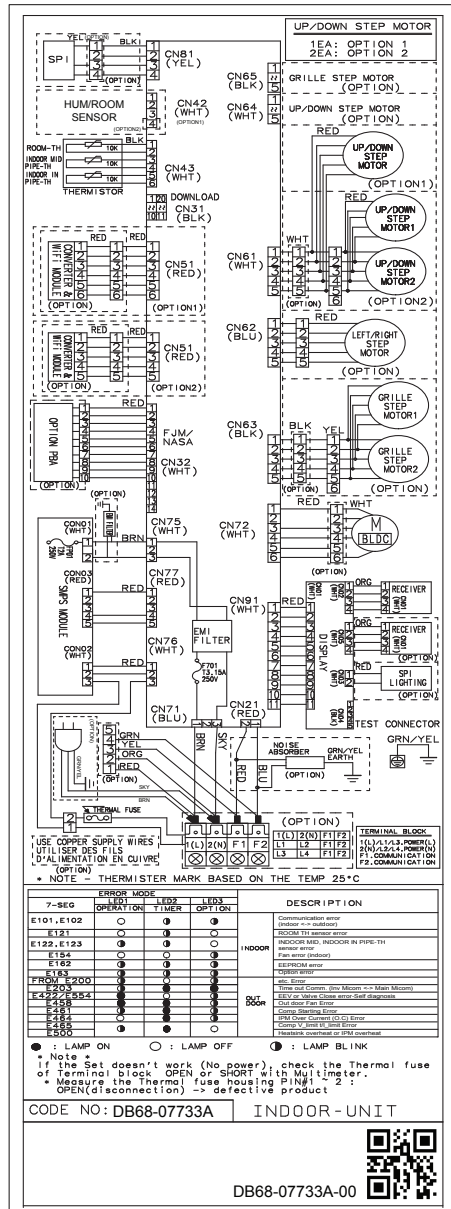

This document can not be used without Samsung's authorization.

7-2 Outdoor Unit

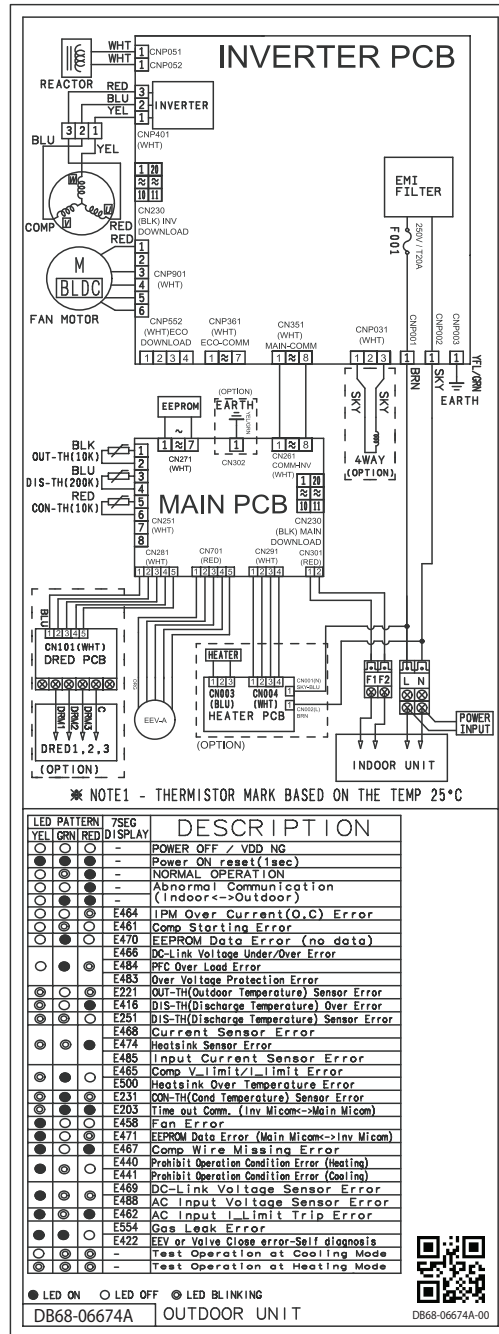

Outdoor Unit

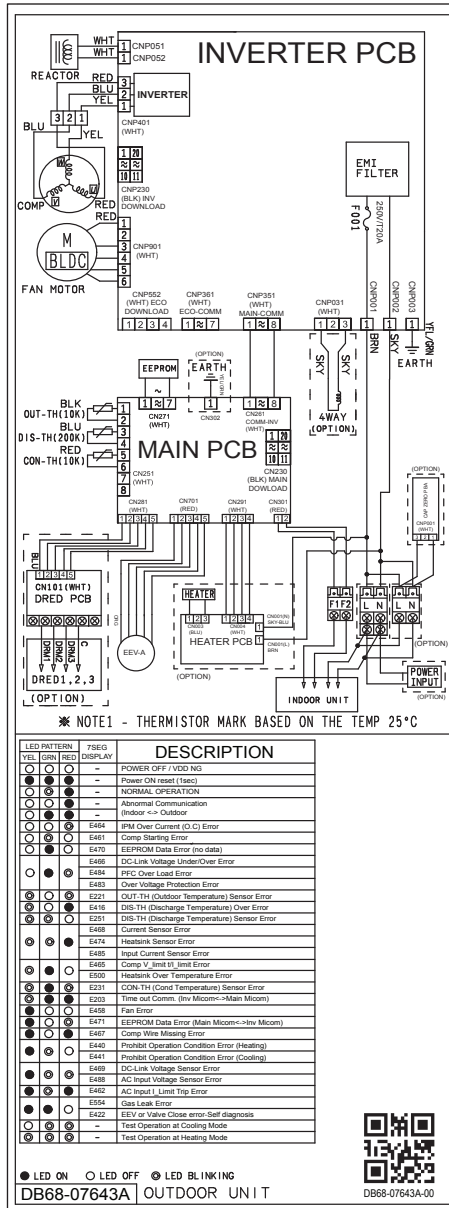

8. PCB Diagram

8-1 Indoor Main PCB-DB92-04101B

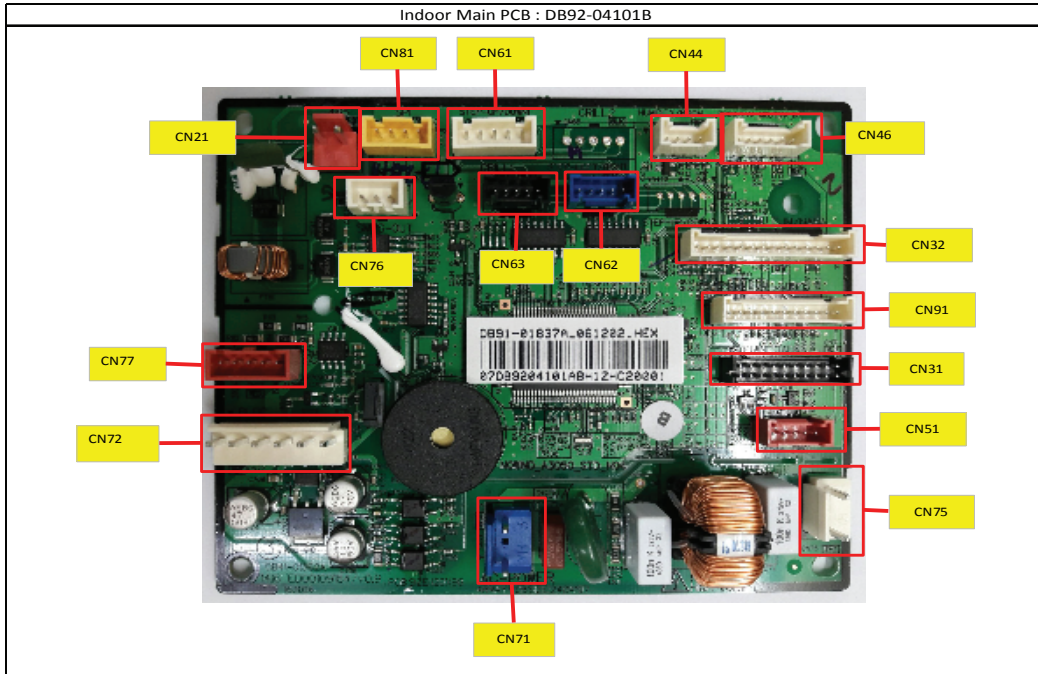

CN32 : FJM SUB PBA #1 : COM2_RXD #2 : COM2_TXD #3 : COM2_ENABLE #4 : COM2_LED #5 : EXT_CTRL #6 : COMP_CHK #7 : ERROR_CHK #8 : 5VDC #9 : GND #10 : 12VDC #11 : COM2_PCTRL_MICOM #12 : COM2_VCHECK_A #13 : COM2_VCHECK_B #14 : COM2_MICOM_AD	CN91 : DISPLAY #1 : DIO #2 : CLK #3 : STB #4 : IRQ #5 : GND #6 : 5VDC #7 : Vout #8 : SPI LAMP #9 : REMOCON_SIGN_OUT #10 : NULL #11 : NULL	CN72 : BLDC FAN #1 : 310VDC #2 : NULL #3 : AGND #4 : 15VDC #5 : MOTOR signal #6 : FEEDBACK signal
CN63 : STEP MOTOR-1 #1 : 12VDC #2 : 04 #3 : 03 #4 : 02 #5 : 01	CN21 : 485 COMMUNICATION #1 : RX #2 : TX	CN61 : STEP-UP/DOWN #1 : 12VDC #2 : O3 #3 : O4 #4 : O5 #5 : O6
CN31 : DOWNLOAD #1 : RXD1 #2 : TXD1 #3 : BOOT #4 : J-TAG_TDO #5 : J-TAG_TCK #6 : J-TAG_TDI #7 : J-TAG_TMS #8 : TraceCLK #9 : GND #10 : VCC #11 : VCC #12 : NULL #13 : NULL #14 : Trace3 #15 : NULL #16 : NULL #17 : GND #18 : Trace2 #19 : Trace1 #20 : Trace0	CN51 : WiFi BLOCK #1 : MAIN_RX-WiFi_TX #2 : MAIN_TX-WiFi_RX #3 : WiFi_RESET #4 : GND #5 : 12V	CN62 : STEP MOTOR-L/R #1 : 12VDC #2 : 01 #3 : 07 #4 : 06 #5 : 05
	CN75 : SPMS #1 : L #2 : NULL #3 : N	CN81 : SPI #1 : SPI #2 : NULL #3 : 12VDC
	CN77 : SPMS_OUT #1 : 310VDC #2 : NULL #3 : NULL #4 : 19VDC #5 : AGND	CN46 : ROOM/VA #1 : ROOM_TEMP #2 : GND #3 : EVA_TEMP (MID) #4 : GND #5 : EVA_TEMP (IN) #6 : GND
	CN44 : TEMPERATURE SENSOR #1 : 5VDC #2 : GND #3 : TEMP SENSOR #4 : HUMID SENSOR #5 : EVA_IN_TEMP #6 : GND	CN76 : SMP5_OUT #1 : 12VDC #2 : GND #3 : 5VDC
		CN71 : AC POWER #1 : POWER #2 : NULL #3 : N

8-2 Outdoor PCB-DB92-04029D

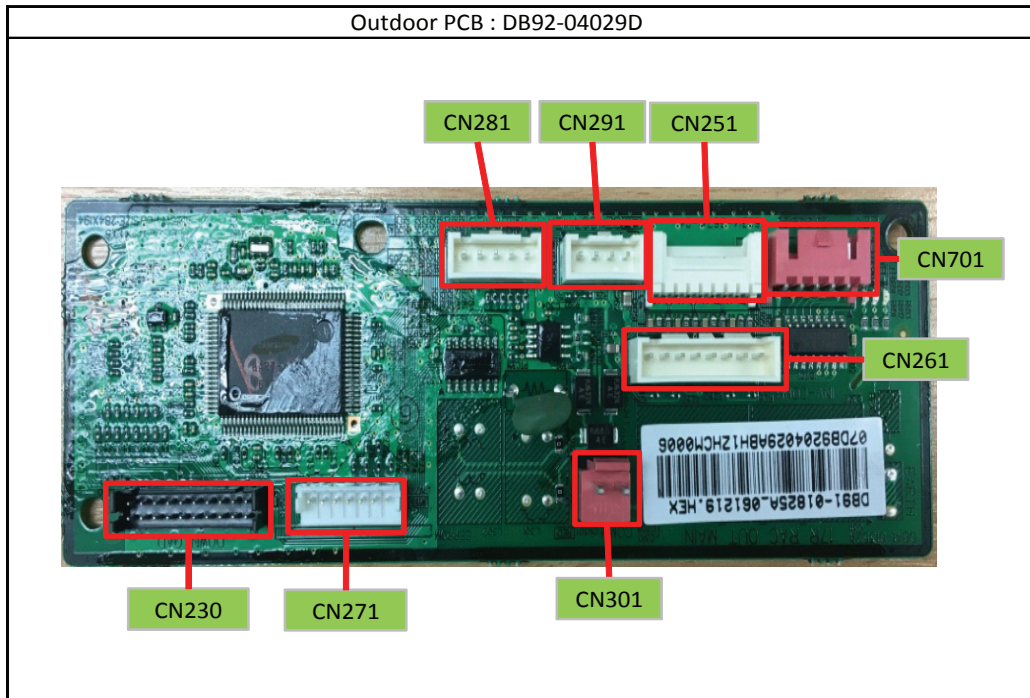

CN301 : 485 COMM

#1 : PTC301
#2 : L301

CN230 : DOWNLOAD

#1 : RXD
#2 : TXD
#3 : BOOT
#4 : TDO
#5 : TCK
#6 : TDI
#7 : TMS
#8 : TRACKCLK
#9 : SGND
#10 : +5v
#11 : NULL
#12 : NULL
#13 : NULL
#14 : Trace3
#15 : NULL
#16 : NULL
#17 : SGND
#18 : Trace2
#19 : Trace1
#20 : Trace0

CN271 : EEPROM

#1 : SGND
#2 : NULL
#3 : +5V
#4 : EEP_CS
#5 : EEP_SO_MIC0
#6 : EEP_SO_MIC0
#7 : EEP_CLK

CN251 : SENSOR

#1 : OUT_TH
#2 : SGND
#3 : DIS_TH
#4 : SGND
#5 : COND_TH
#6 : SGND
#7 : OLP_TH
#8 : SGND

CN281 : DRED

#1 : DRED1
#2 : DRED2
#3 : DRED3
#4 : SGND

CN261 : COMM (MAIN)

#1 : TDX_MAIN
#2 : RXD_MAIN
#3 : +5V
#4 : SGND
#5 : +12V
#6 : POWER_SAVE
#7 : 4WAY
#8 : NULL

CN701

#1 : O4
#2 : O3
#3 : O2
#4 : O1
#5 : COM

CN291 : SENSOR

#1 : +12V
#2 : SGND
#3 : HEATER_L
#4 : HEATER_R

8-3 Outdoor PCB-DB92-04025C

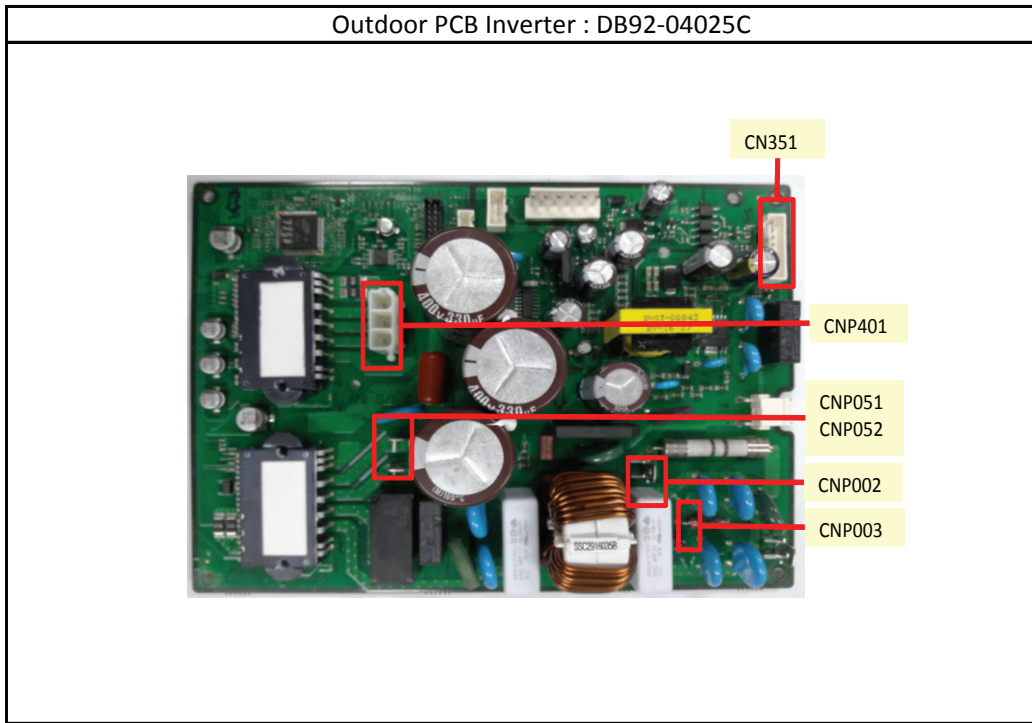

CN051 : WIRE REACTOR	CN052 : WIRE REACTOR	CN002 : WIRE POWER INPUT
#1 : PR	#1 : L	#1 : POWER INPUT #2 : GND
CNP003 : WIRE EARTH	CNP351: COMM	CNP401 : WIRE COMP
#1 : GND	#1 : R351 #2 : R354 #3 : +5V_1 #4 : SGND #5 : +12V_1 #6 : POWER_SAVE #7 : 4WAY #8 : HOT_GAS	#1 : W #2 : V #3 : U

8-4 DISPLAY PCB DB92-04106A

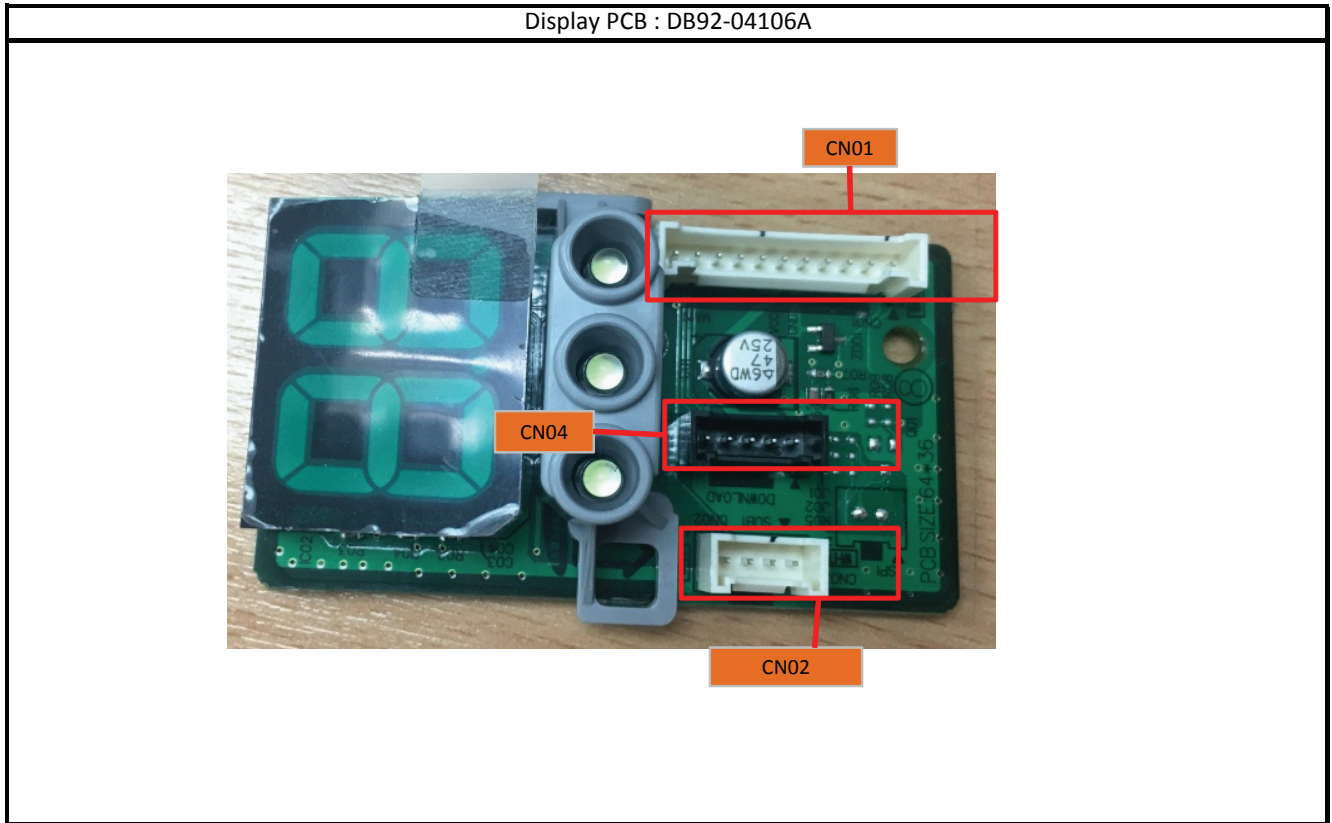

CN01		CN02		CN04	
#1	DIN/DOUT	#1	GND	#1	DIN/DOUT
#2	CLK	#2	Vout	#2	CLK
#3	STB	#3	5VDC	#3	STB
#4	IRQ	#4	IRQ	#4	SWITCH INPUT
#5	GND			#5	GND
#6	5VDC				
#7	Vout				
#8	PWM_LED				
#9	TEST_RX				
#10	TEST_TX				
#11	MODE0				

8-' SUB PCB--RECEIVE-DB92-02874A

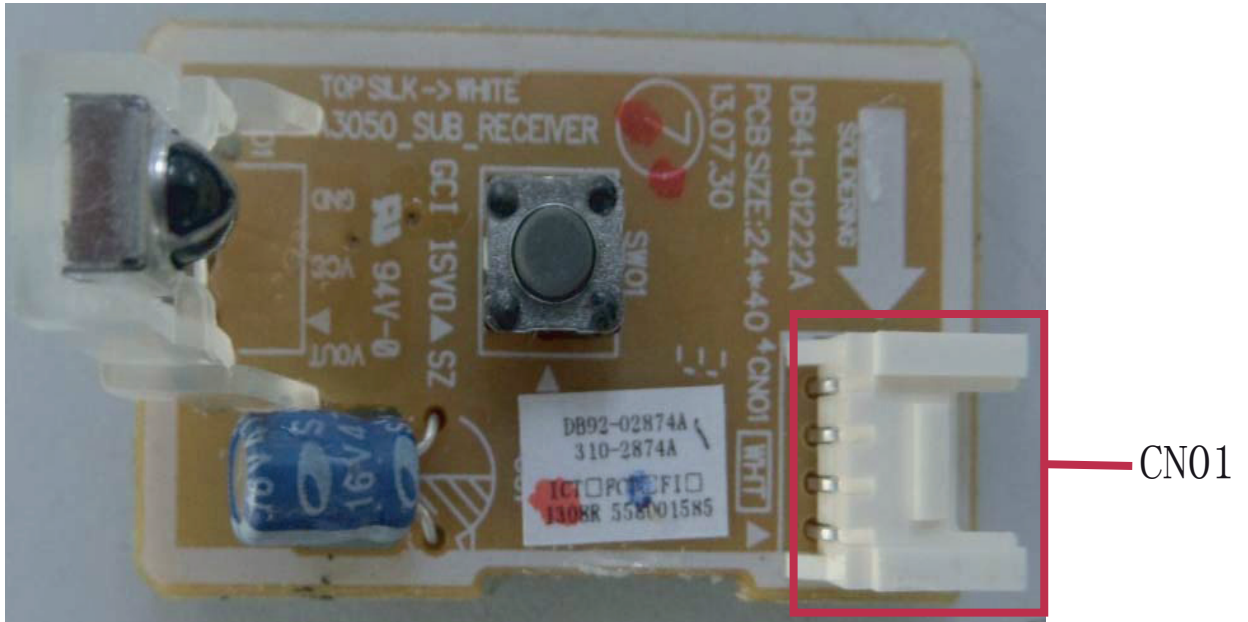

<p>CN01 - RECEIVE</p> <p>#1: GND #2: Vout #3: Vcc #4: SW</p>			

8-(Wire connecting the indoor unit terminal blocks

1. Terminal press of Ring terminal shall be set facing up before connecting wire.



Is inverted



Terminal has been cut.

2. There shall be no empty space between Ring terminal and Screw after Clamp.
If not, there exists a possibility of fire which can be caused by electric heat in the connecting part.

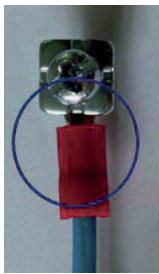

①



②



③

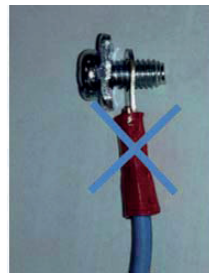

④



⑤



⑥

①, ② : Good

③ Bad : Ring terminal is connected reversely

④ Bad : Not clamped Screw

⑤ Bad : In the gap between Ring terminal & Screw

⑥ Bad : Unused Ring Terminal

9. Operating Instructions

9-1 Name of Each Part

9-1-1 Indoor Unit

The design and shape are subject to change according to the model.

■ Main Parts

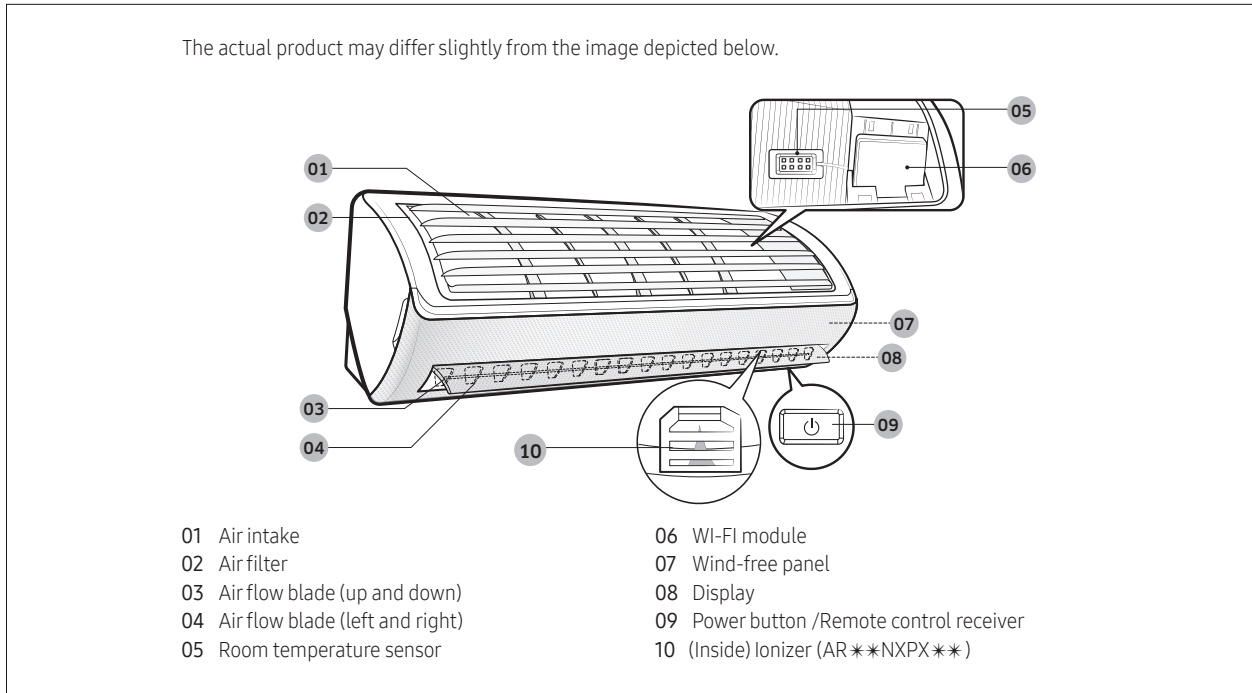

■ Display

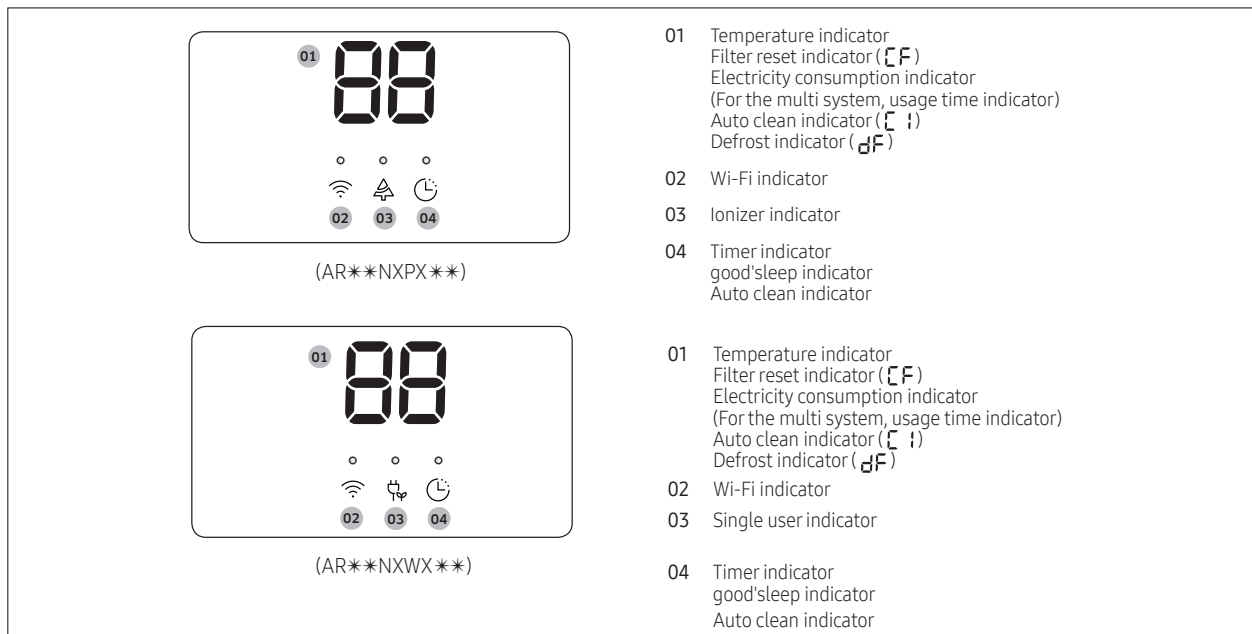

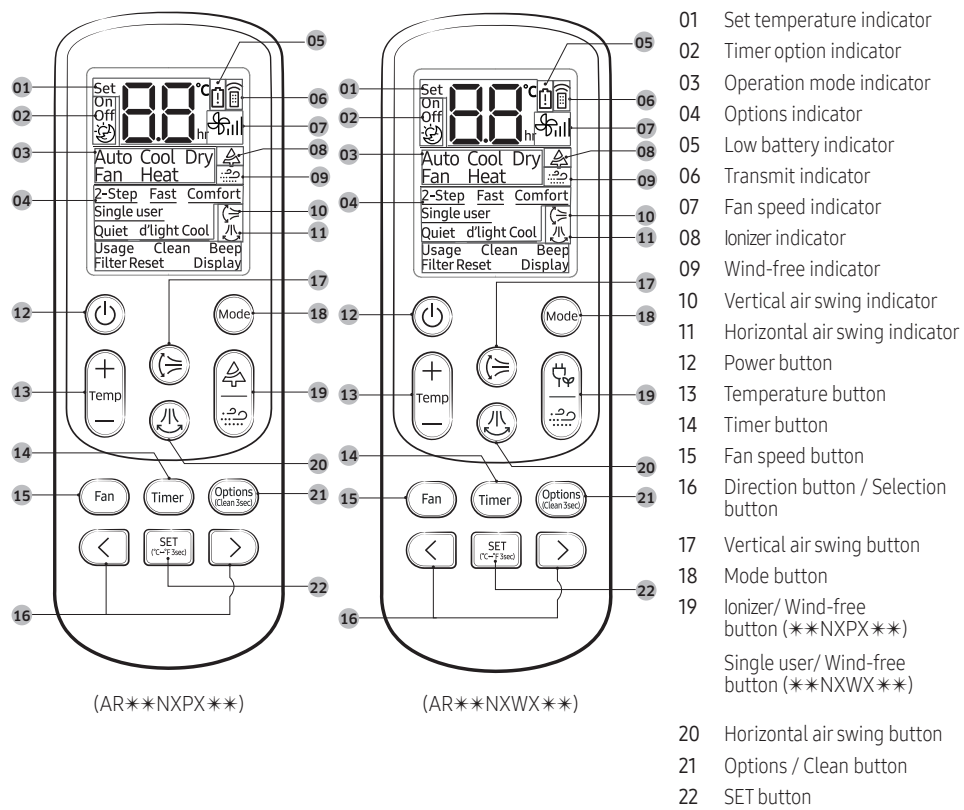

9-2 Wireless Remote control-Buttons and Display



10. Troubleshooting

10-1 Items to be checked first

1. The input voltage should be rating voltage $\pm 10\%$ range.
The air conditioner may not operate properly if the voltage is out of this range.
2. Is the line cable linking the indoor unit and the outdoor unit linked properly?
The indoor unit and the outdoor unit shall be linked by 5 cables.
Check the terminals if the indoor unit and outdoor unit are properly linked by the same number of cables.
Otherwise the air conditioner may not operate properly.
3. When a problem occurs due to the contents illustrated in the table below it is a symptom not related to the malfunction of the air conditioner.

NO	Operation of air conditioner	Explanation
1	The OPERATION indication LED(BLUE) blinks when a power plug of the indoor unit is plugged in for first time.	It indicates power is on. The LED stops blinking if the operation ON/OFF button on the remote control unit is pushed.
2	In a COOL operation mode, the compressor does not operate at a room temperature higher than the setting temperature that the INDOOR FAN should operate. [In case of heat pump model] In a HEAT operation mode, the compressor does not operate at a room temperature lower than the setting temperature that indoor fan should operate.	In happens after a delay of 3 minutes when the compressor is reoperated. The same phenomenon occurs when a power is on. As a phenomenon that the compressor is reoperated after a delay of 3 minutes, the indoor fan is adjusted automatically with reference to a temperature of the air blew.
3	Fan speed setting is not allowed in DRY  mode.	The speed of the indoor fan is set to LL in DRY mode. Fan speed is selected automatically in AUTO mode.
4	Compressor stops operation intermittently in Dry  mode.	Compressor operation is controlled automatically in DRY mode depending on the room temperature and humidity.
5	Timer LED(ORANGE) of the indoor unit lights up and the air conditioner does not operate.	Timer is being activated and the unit is in ready mode. The unit operates normally if the timer operation is cancelled.
6	The compressor stops intermittently in a COOL mode or DRY mode, and fan speed of the indoor unit decreases.	The compressor stops intermittently or the fan speed of the indoor unit decreases to prevent inside/outside air frozen depending on the inside/outside air temperature.
7	[In case of heat pump model] Compressor of the outdoor unit is operating although it is turned off in a HEAT mode.	When the unit is turned off while de-ice is activated, the compressor continues operation for up to 9 minutes(maximum) until the deice is completed.
8	[In case of heat pump model] The compressor and indoor fan stop intermittently in HEAT mode.	The compressor and indoor fan stop intermittently if room temperature exceeds a setting temperature in order to protect the compressor from overheated air in a HEAT mode.
9	[In case of heat pump model] Indoor fan and outdoor fan stop operation intermittently in a HEAT mode.	The compressor operates in a reverse cycle to remove exterior ice in a HEAT mode, and indoor fan and outdoor fan do not operate intermittently for within 20% of the total heater operation.

10-2 Communication Error

10-2-1 Communication Error

Indoor display

3-LED DISPLAY			7-SEG DISPLAY	DESCRIPTION
LED1	LED2	LED3	E101/E102	Communication error(Indoor<->outdoor)
○	◎	◎		

Outdoor display

◎	●	●	1min. Time out Comm.
○	○	●	Abnormal Communication
○	●	●	

● LED ON ◎ LED BLINKING ○ LED OFF

1. Checklist :

- 1) Is the cable between the indoor unit and outdoor unit connected correctly?
- 2) Isn't the power cable and communication cable cross?

2. Troubleshooting procedure

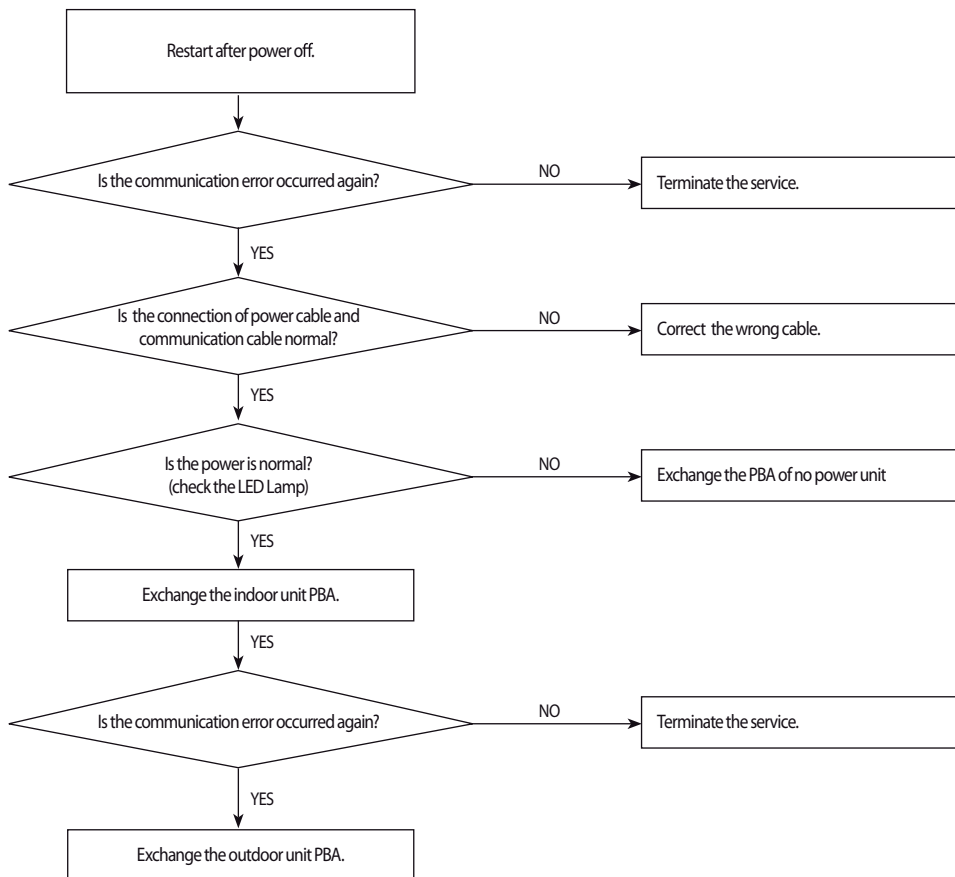

10-2-2 Indoor temperature sensor Error

Indoor display

3-LED DISPLAY			7-SEG DISPLAY	DESCRIPTION
LED1	LED2	LED3	E121	Indoor room temp sensor error
○	◎	○		

● LED ON ◎ LED BLINKING ○ LED OFF

1. Checklist :

- 1) Is the indoor units temperature sensor connected correctly?
- 2) Is the sensor placed correctly?
- 3) Does the both terminal of sensor satisfy the resistance value in accordance with temperature?

2. Troubleshooting procedure

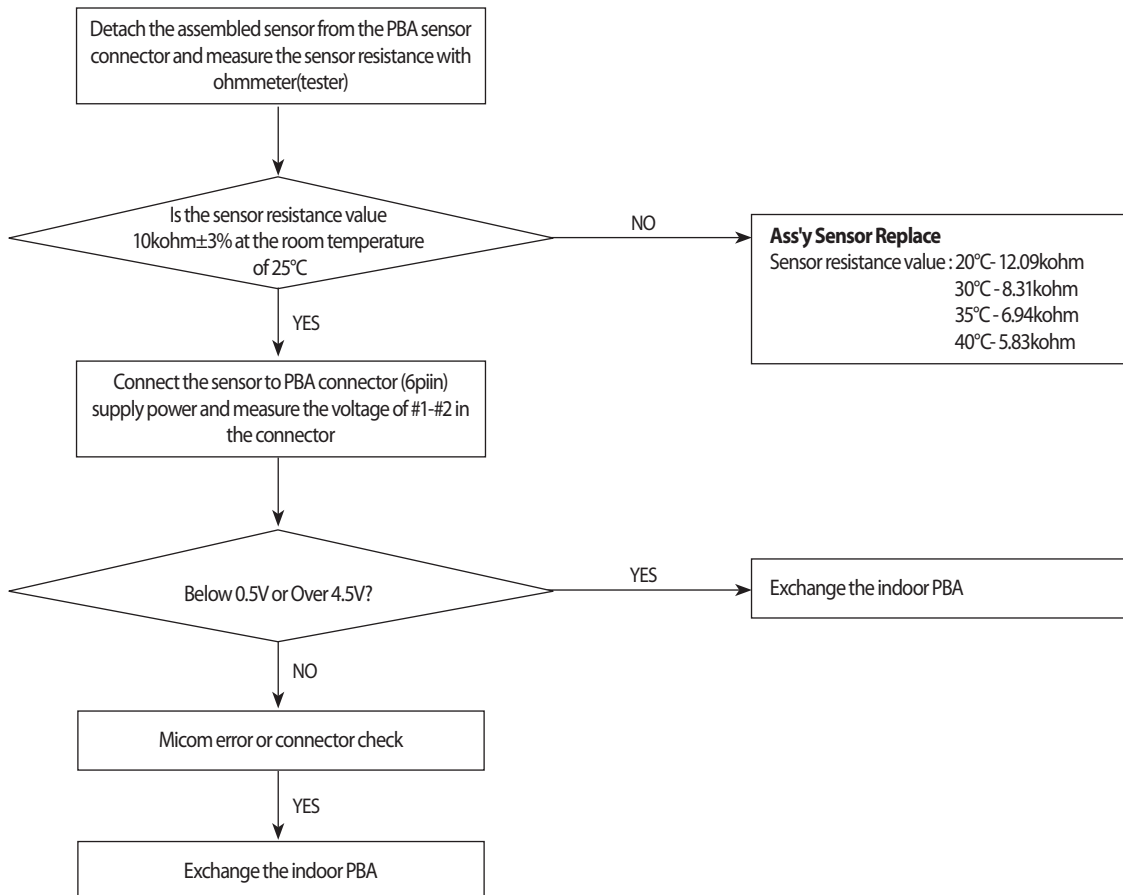

10-2-3 Indoor fan motor speed detecting error (BLDC fan)

Indoor display

3-LED DISPLAY			7-SEG DISPLAY	DESCRIPTION
LED1	LED2	LED3	E154	Indoor fan error
○	○	◎		

● LED ON ◎ LED BLINKING ○ LED OFF

1. Checklist :

- 1) Is the indoor units fan motor properly connected with the connector(CN72)?
- 2) Is the AC voltage correct?

2. Troubleshooting procedure

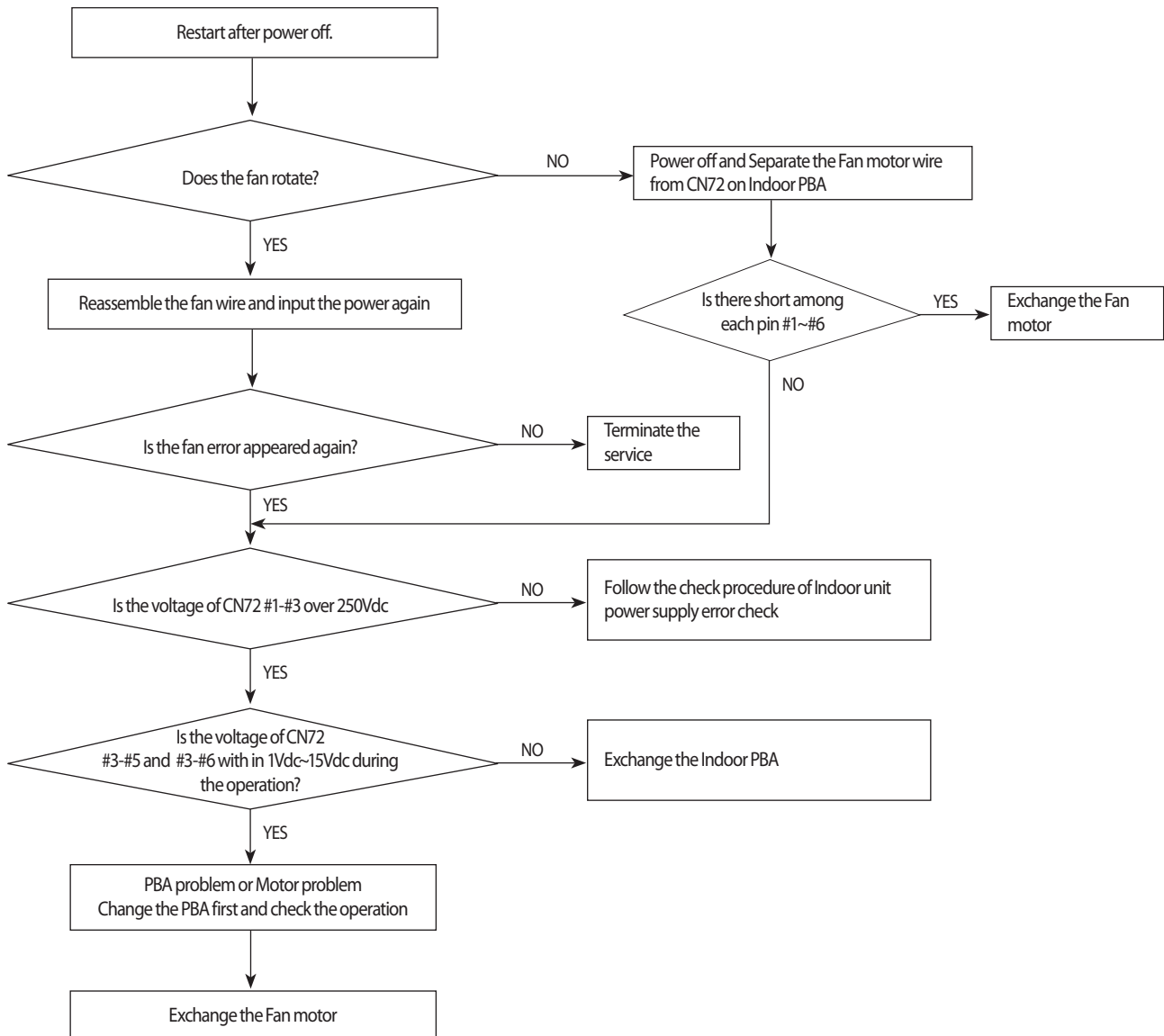

10-2-4 Outdoor temperature sensor error

Indoor display

3-LED DISPLAY			7-SEG DISPLAY	DESCRIPTION
LED1	LED2	LED3	E221	Outdoor temperature sensor error
⊙	○	⊙		

Outdoor display

⊙	○	⊙	Outdoor temperature sensor error
---	---	---	----------------------------------

● LED ON ⊙ LED BLINKING ○ LED OFF

1. Checklist :

- 1) Is the sensor connected correctly?
- 2) Is the sensor placed correctly?
- 3) Does the both terminal of sensor satisfy the resistance value in accordance with temperature?
- 4) Is the resistance value of sensor connection pull-up correct?

MODEL	"A"	"B"
ALL	CN251	CN251 #1-#2

2. Troubleshooting procedure

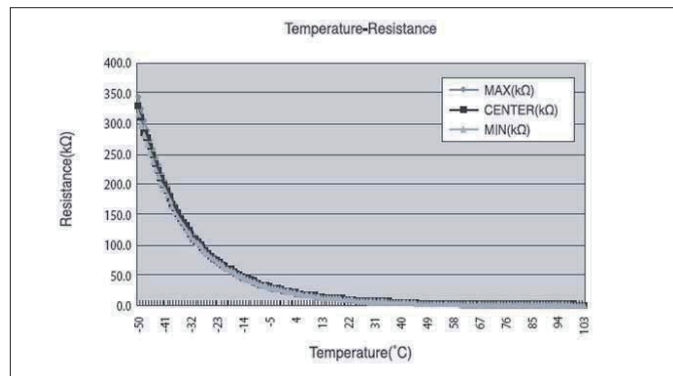
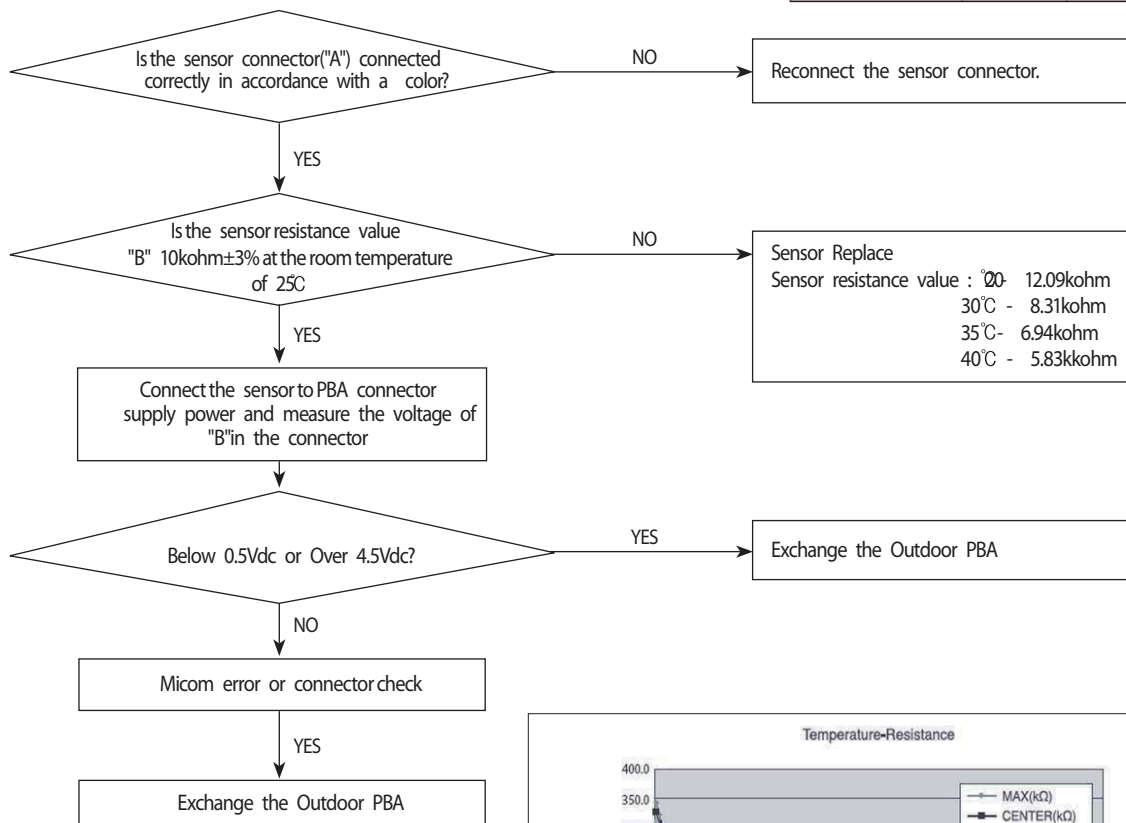

10-2-5 Outdoor Cond temperature sensor error

Indoor display

3-LED DISPLAY			7-SEG DISPLAY	DESCRIPTION
LED1	LED2	LED3	E231	Outdoor Cond temperature sensor error
⊙	○	⊙		

Outdoor display

⊙	●	⊙	Outdoor Cond temperature sensor error
---	---	---	---------------------------------------

● LED ON ⊙ LED BLINKING ○ LED OFF

1. Checklist :

- 1) Is the sensor connected correctly?
- 2) Is the sensor placed correctly?
- 3) Does the both terminal of sensor satisfy the resistance value in accordance with temperature?
- 4) Is the resistance value of sensor connection pull-up correct?

MODEL	"A"	"B"
ALL	CN251	CN251 #5-#6

2. Troubleshooting procedure

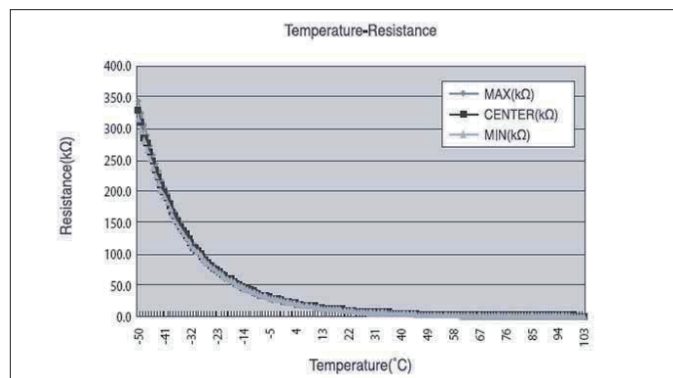
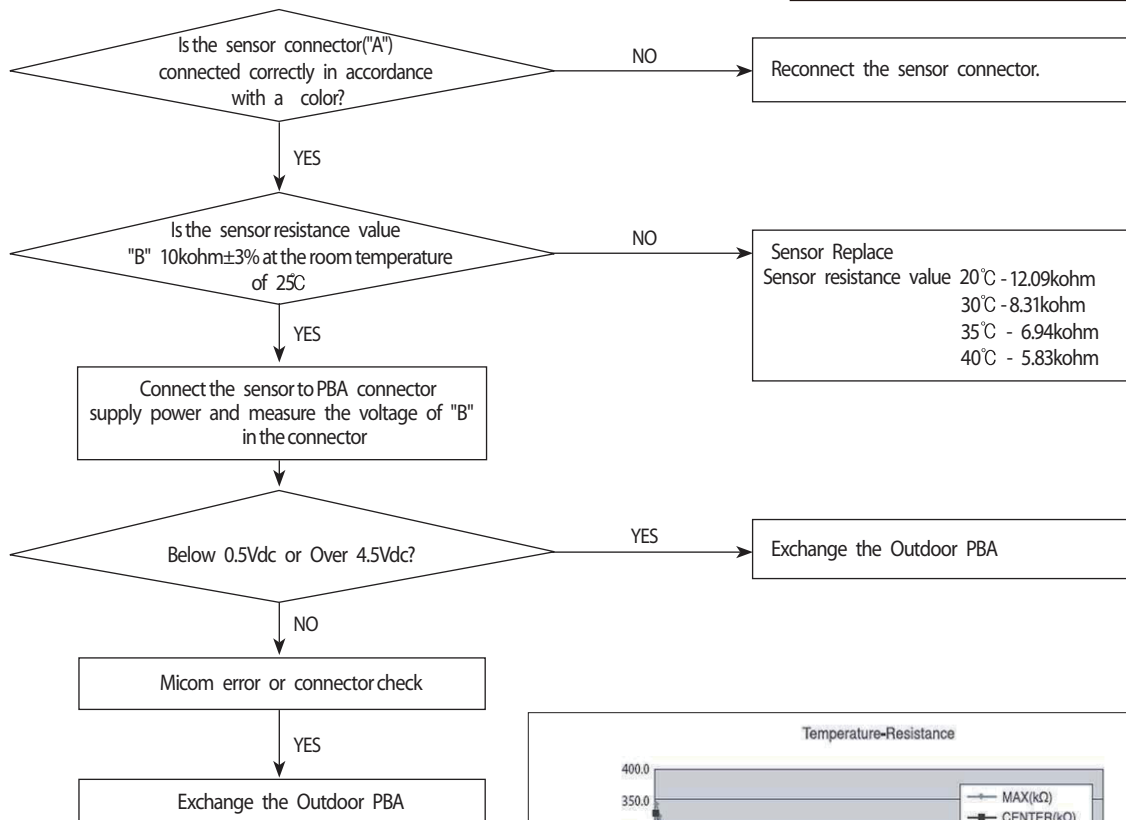

10-2-6 Outdoor Discharge temperature sensor error

Indoor display

3-LED DISPLAY			7-SEG DISPLAY	DESCRIPTION
LED1	LED2	LED3	E251	Outdoor Discharge temperature sensor error
⊙	○	⊙		

Outdoor display

⊙	⊙	○	Outdoor Discharge temperature sensor error
---	---	---	--

● LED ON ⊙ LED BLINKING ○ LED OFF

1. Checklist :

- 1) Is the sensor connected correctly?
- 2) Is the sensor placed correctly?
- 3) Does the both terminal of sensor satisfy the resistance value in accordance with temperature?
- 4) Is the resistance value of sensor connection pull-up correct?

MODEL	"A"	"B"
ALL	CN251	CN251 #3-#4

2. Troubleshooting procedure

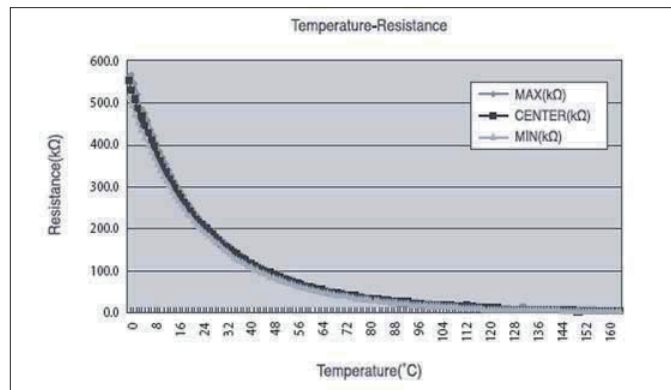
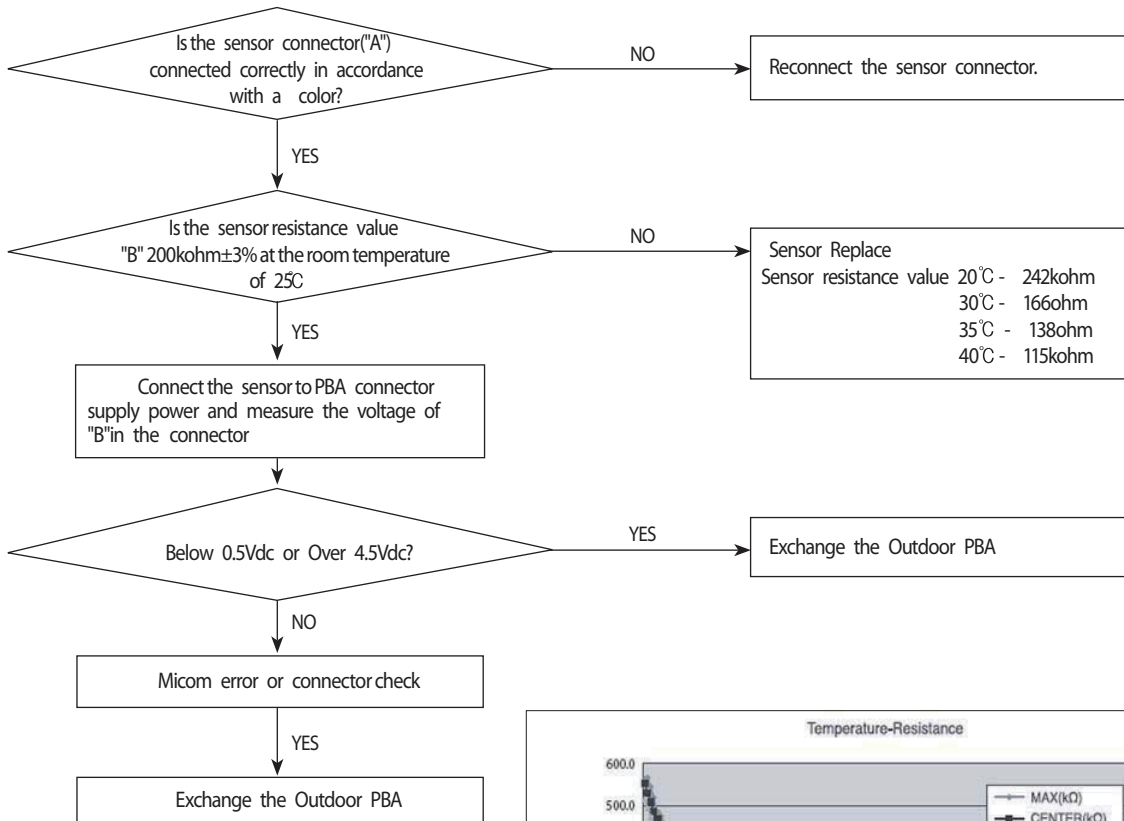

10-2-7 Operation condition secession error

Indoor display

3-LED DISPLAY			7-SEG DISPLAY	DESCRIPTION
LED1	LED2	LED3		
◎	○	◎	E440	Prohibit Operation Condition Error (Heating)
			E441	Prohibit Operation Condition Error (Cooling)

Outdoor display

●	◎	○	Operation condition secession
---	---	---	-------------------------------

● LED ON ◎ LED BLINKING ○ LED OFF

1. Checklist :

- 1) Check the temperature around the outdoor unit.

2. Troubleshooting procedure

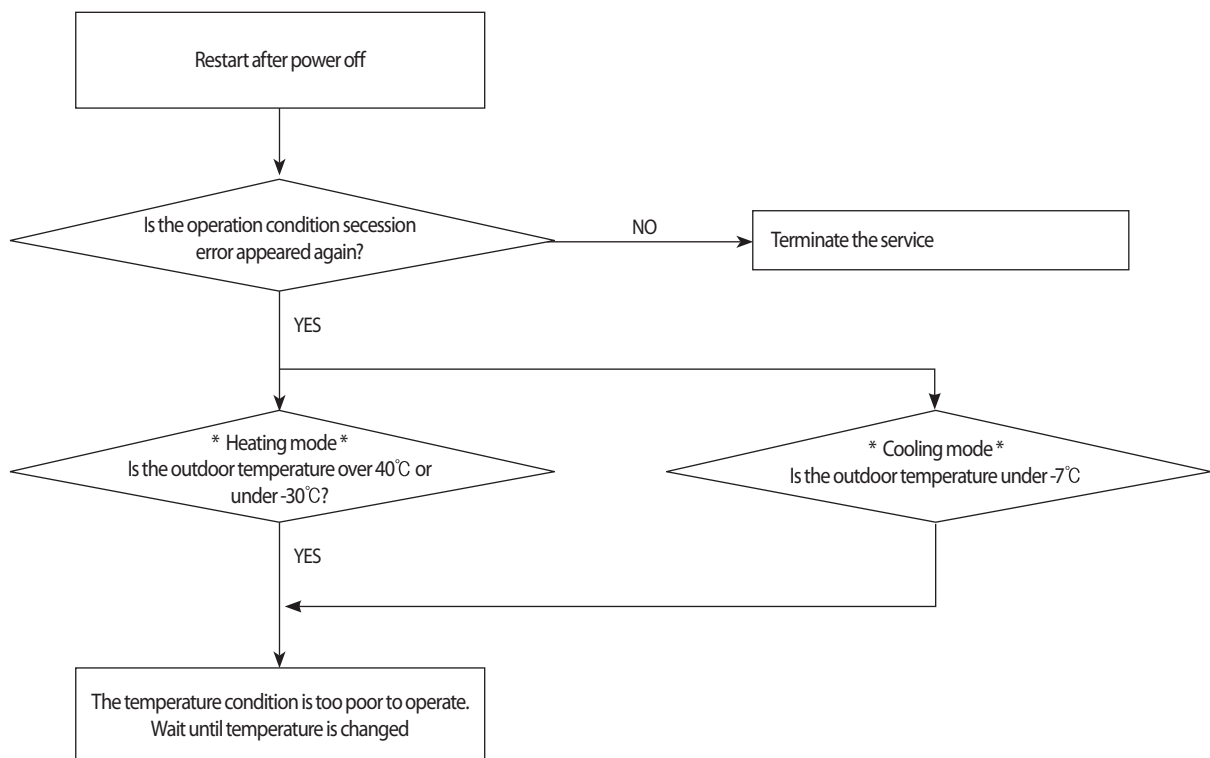

10-2-8 EEPROM error / OTP error

Indoor display

3-LED DISPLAY			7-SEG DISPLAY	DESCRIPTION
LED1	LED2	LED3		
◎	○	◎	E470	EEPROM Data Error (no data)
			E471	OTP errorEEPROM Data Error (Main Micom→Inv Micom)

Outdoor display

○	●	○	EEPROM Data Error (no data)
●	○	◎	OTP errorEEPROM Data Error (Main Micom→Inv Micom)

● LED ON ◎ LED BLINKING ○ LED OFF

1. Checklist :

- 1) Is there a short around micom?
- 2) Is there a short around "A"?
- 3) Did you download or insert EEPROM IC, after changing outdoor PBA?

2. Troubleshooting procedure

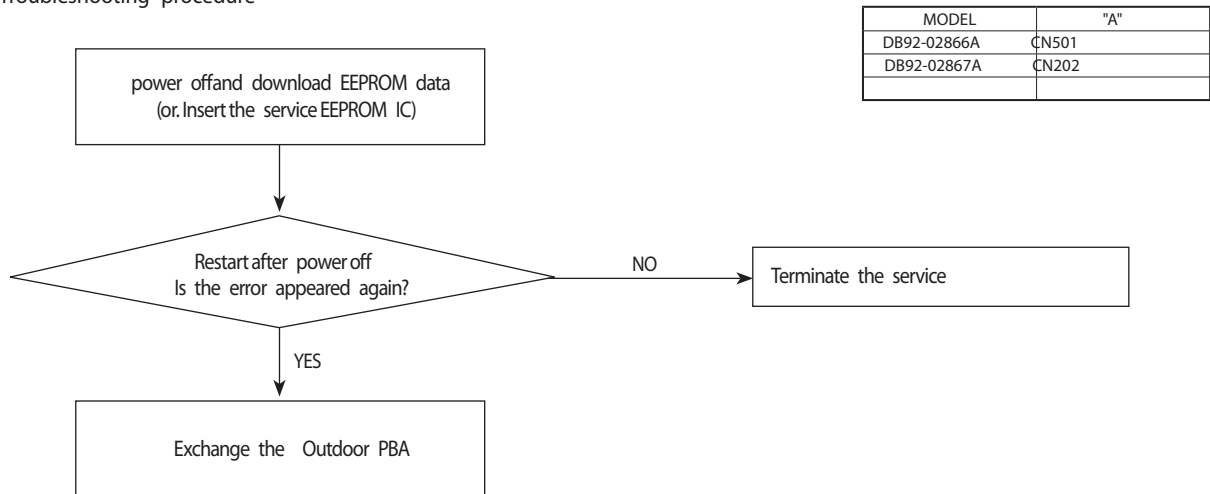

10-2-9 Outdoor Fan motor error

Indoor display

3-LED DISPLAY			7-SEG DISPLAY	DESCRIPTION
LED1	LED2	LED3	E458	Outdoor fan error
◎	○	◎		

Outdoor display

●	○	○	Outdoor fan error
---	---	---	-------------------

● LED ON ◎ LED BLINKING ○ LED OFF

1. Checklist :

- 1) Are the input power voltage and the power connection correct?
- 2) Is the motor wire connected to the outdoor PBA correctly?
- 3) Is there no assembly error or non-assembly in the terminal of motor wire connector?
- 4) Is there no obstacle at the surrounding of motor and propeller?

2. Troubleshooting procedure

MODEL	"A"
ALL	CN901

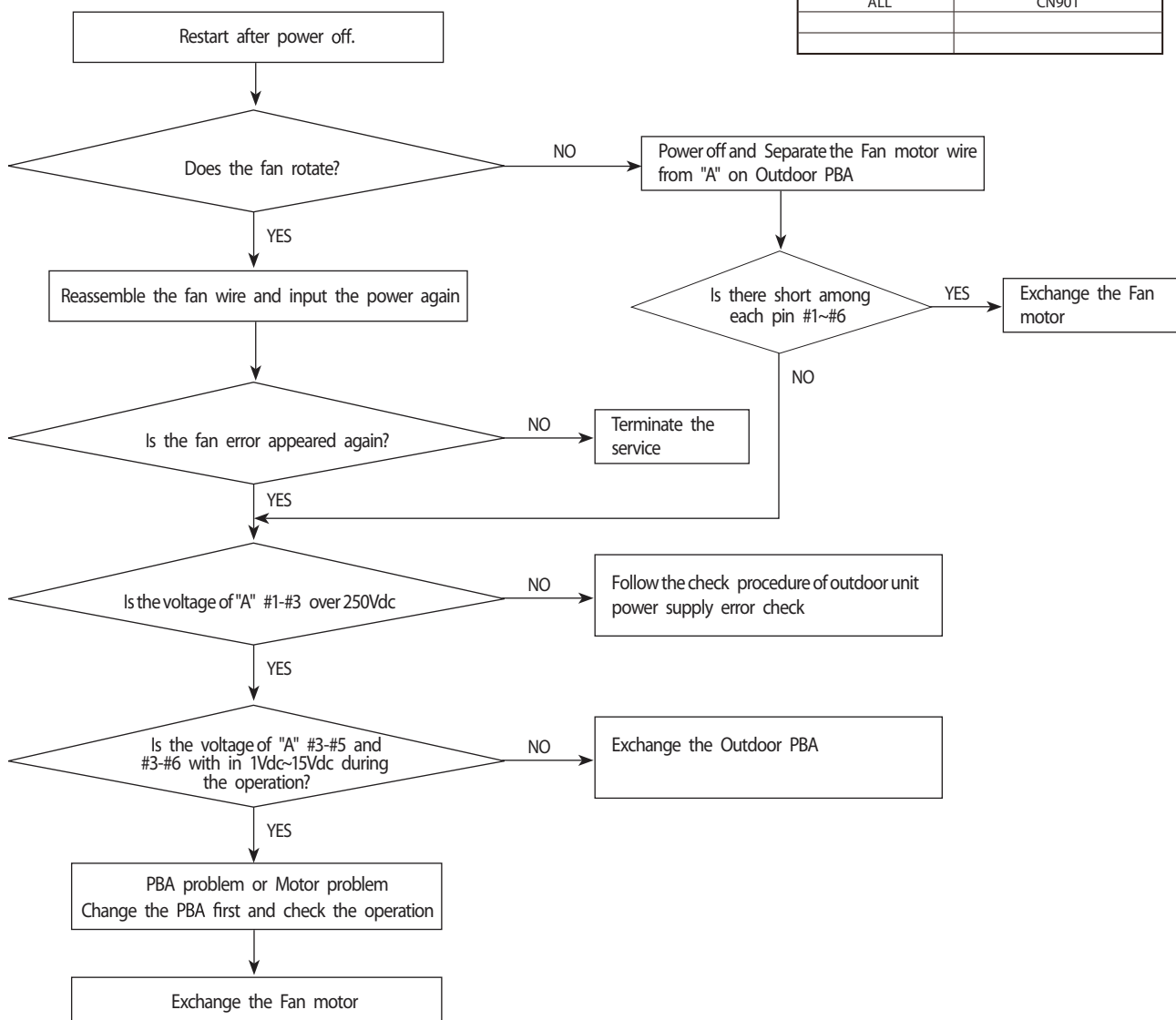

10-2-10 Compressor starting error

Indoor display

3-LED DISPLAY			7-SEG DISPLAY	DESCRIPTION
LED1	LED2	LED3	E461	Comp starting error
⊙	○	⊙		

Outdoor display

○	⊙	○	Comp starting error
---	---	---	---------------------

● LED ON ⊙ LED BLINKING ○ LED OFF

1. Checklist :

- 1) Is the connection of cable for the compressor?
- 2) Is the compressor wire is connected clockwise? U(RED)-V(BLU)-W(YEL)
- 3) Is the interphase resistance of compressor normal?

2. Troubleshooting procedure

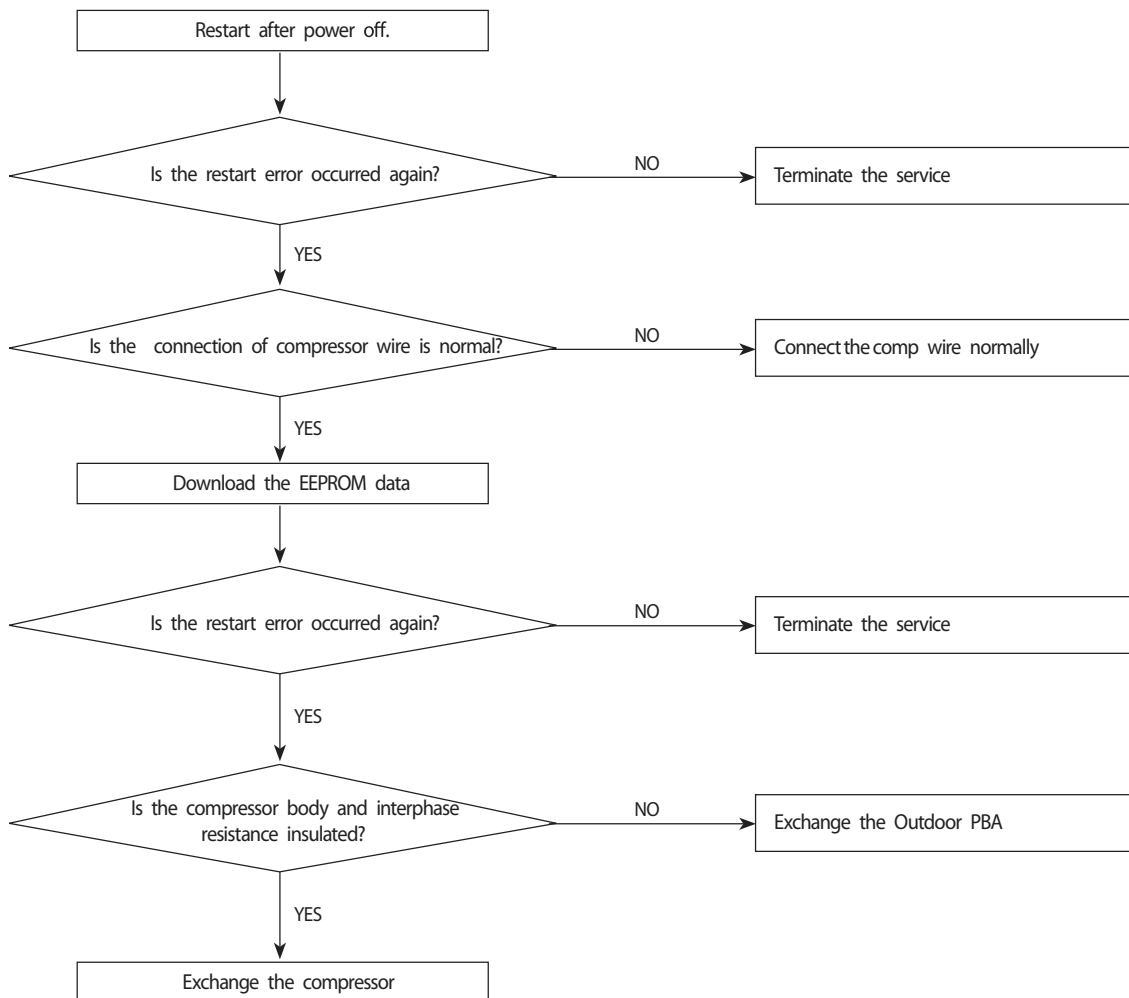

10-2-11 Compressor wire missing error/rotation error

Indoor display

3-LED DISPLAY			7-SEG DISPLAY	DESCRIPTION
LED1	LED2	LED3	E467	Compressor wire missing error/rotation error
◎	○	◎		

Outdoor display

●	○	●	Compressor wire missing error/rotation error
---	---	---	--

● LED ON ◎ LED BLINKING ○ LED OFF

1. Checklist :

- 1) Is the connection of cable for the compressor?
- 2) Is the compressor wire is connected clockwise? U(RED)-V(BLU)-W(YEL)
- 3) Is the interphase resistance of compressor normal?

2. Troubleshooting procedure

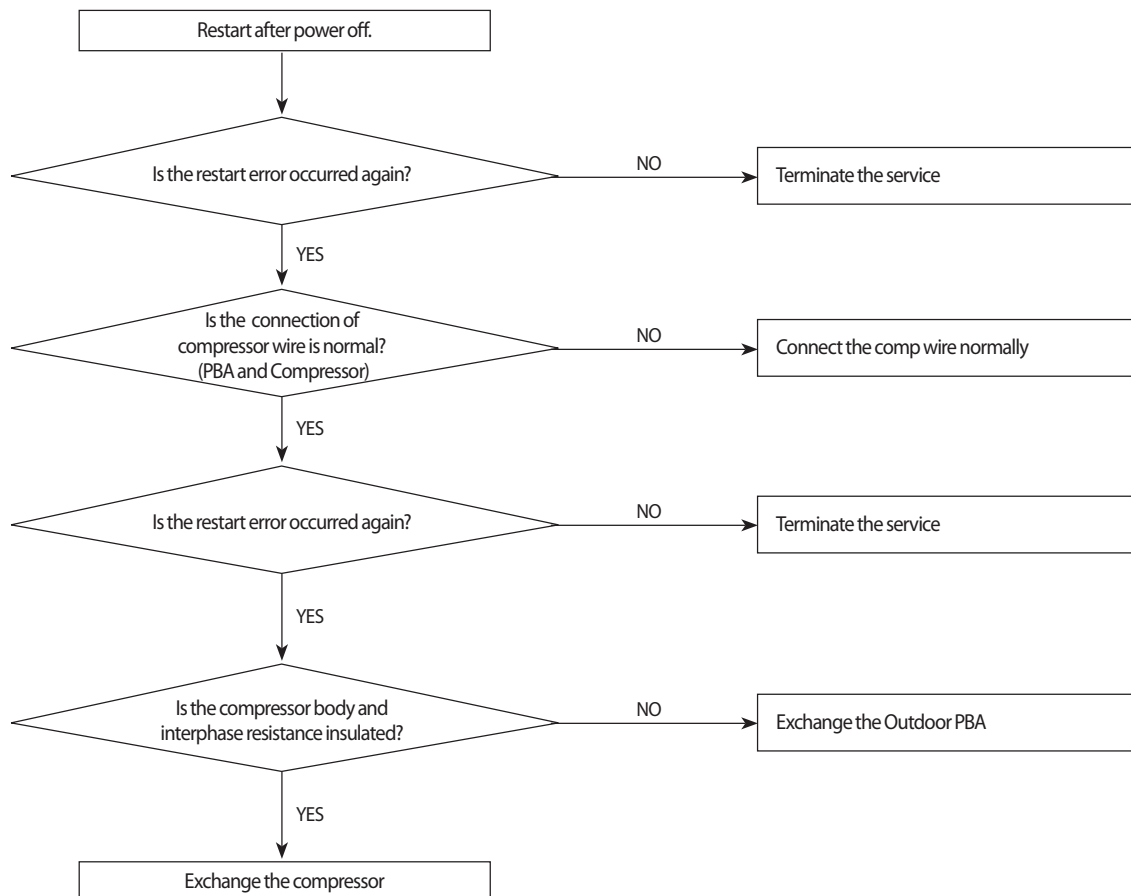

10-2-12 Current sensor error/Input current sensor error

Indoor display

3-LED DISPLAY			7-SEG DISPLAY	DESCRIPTION
LED1	LED2	LED3		
◎	○	◎	E462	AC Input I_Limit Trip Error

Outdoor display

●	◎	○	Current sensor error
●	◎	●	Input current sensor error

● LED ON ◎ LED BLINKING ○ LED OFF

1. Checklist :

- 1) Is the PFC Shunt("A") resistance value correct? Check the resistor is opened
- 2) Is the IPM Shunt("B") resistance value correct? Check the resistor is opened
- 3) Is there no short or open around "C"?

2. Troubleshooting procedure

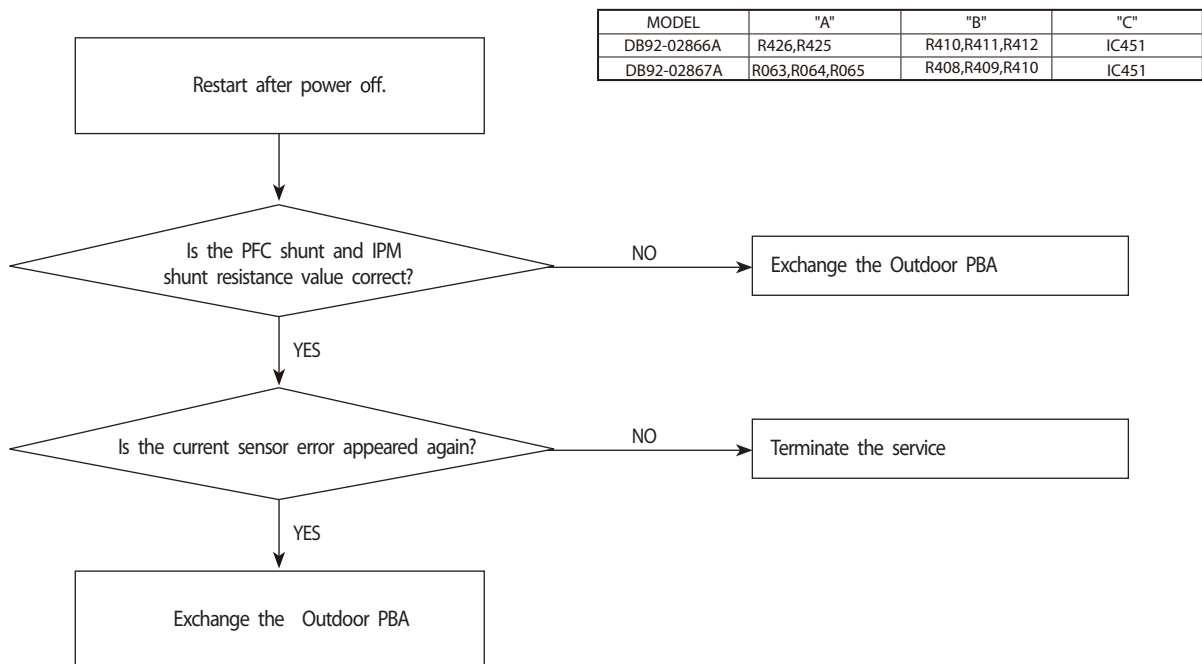

10-2-13 O.C(Over Current) error

Indoor display

3-LED DISPLAY			7-SEG DISPLAY	DESCRIPTION
LED1	LED2	LED3	E464	IPM Over Current(O.C) Error
⊙	○	⊙		

Outdoor display

○	○	⊙	IPM Over Current(O.C) Error
---	---	---	-----------------------------

● LED ON ⊙ LED BLINKING ○ LED OFF

1. Checklist :

- 1) Is the IPM Shunt resistance value correct? Check the resistor is opened
- 2) Is the condition of surrounding temperature abnormal overload?
- 3) Is there any problem as like the temperature sensor separation or measurement value error?
- 4) Is the interphase resistance of compressor normal?

2. Troubleshooting procedure

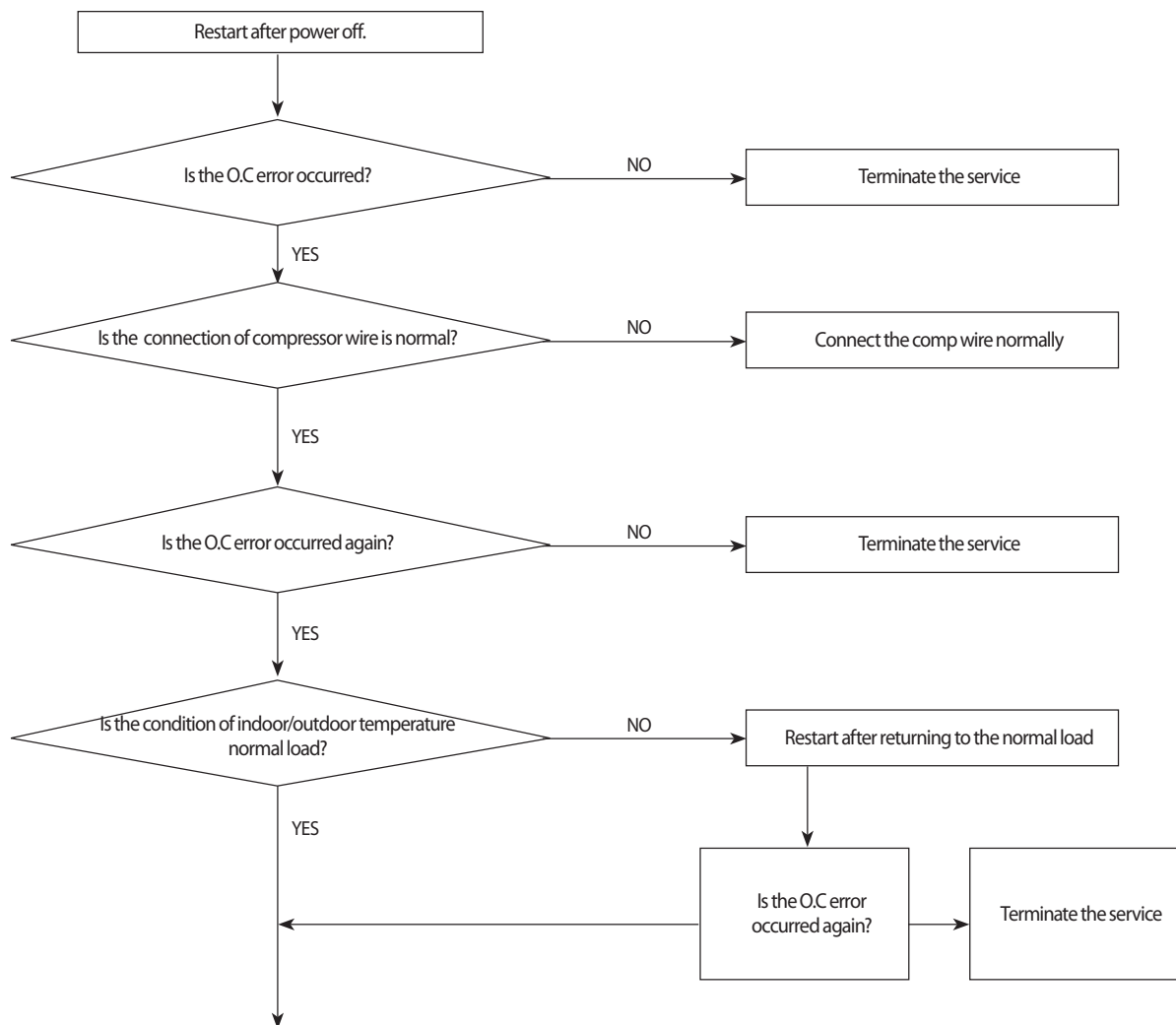

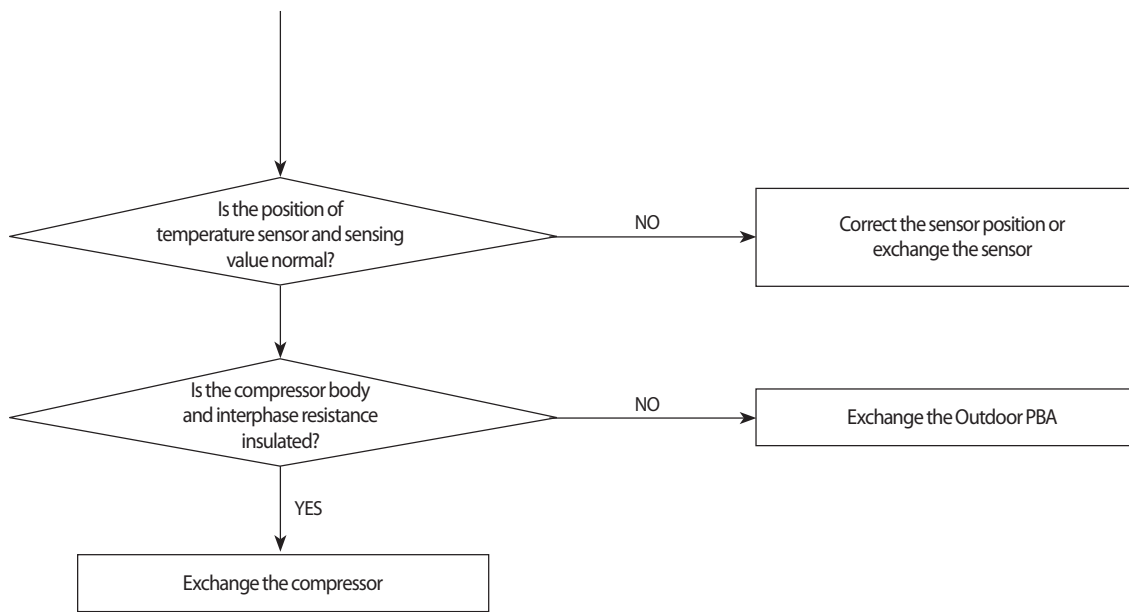

102-14 No power outdoor (Initial Diagnosis) (Not displayed)

1. Checklist :

- 1) Is input power normal?
- 2) Is AC power linked correctly? (L,N,E)
- 3) Is mis-wiring between communication wire and Power wire?
- 4) Is mis-wiring between Main PBA and SMPS PBA wire?
- 5) Is input voltage of SMPS AC in Main PBA (CN150) normal?
- 6) Is the voltage of SMPS DC in Main PBA (CN151,CN152) normal?

2. Troubleshooting procedure

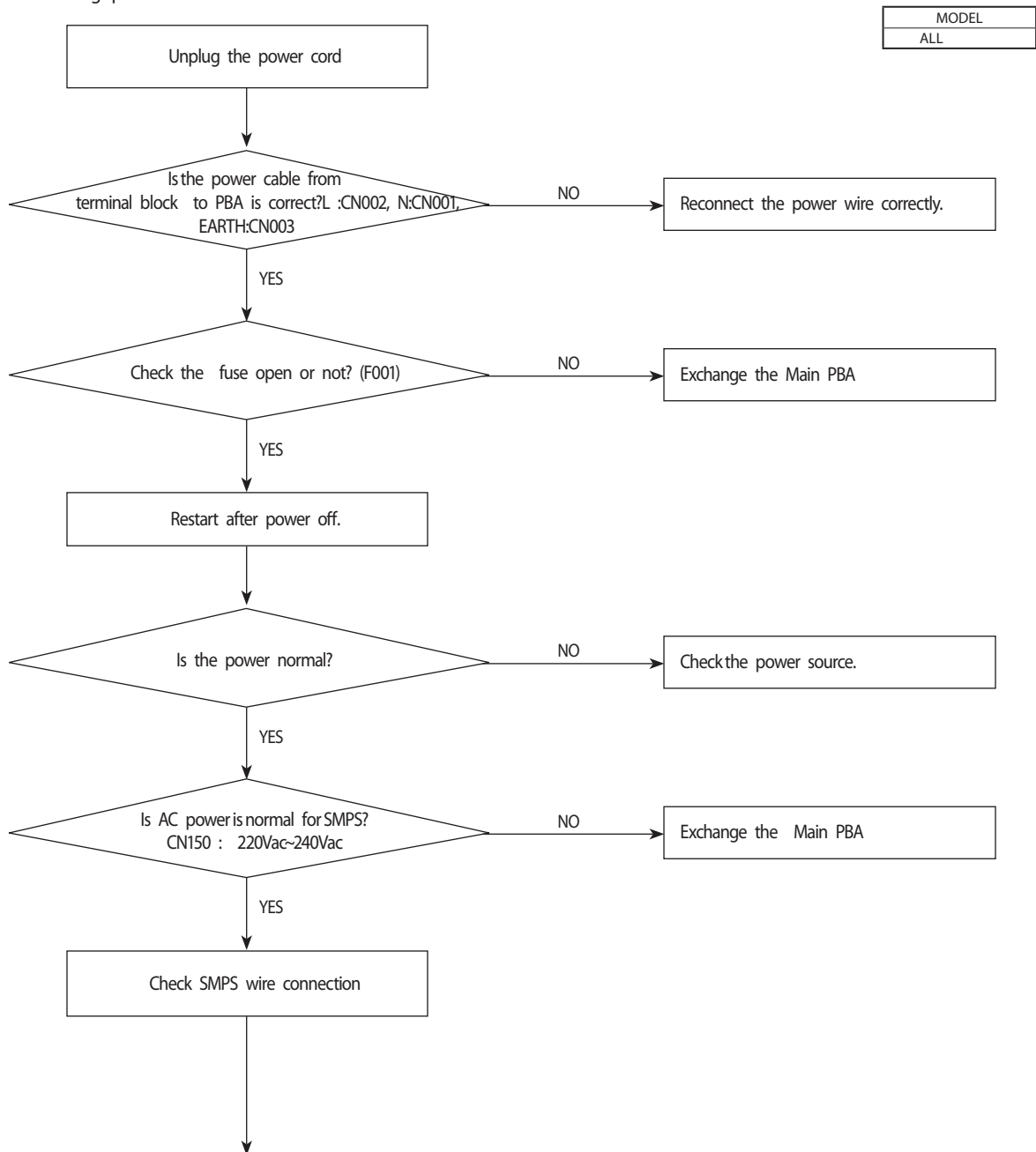

10-2-15 When the Up/Down, Left/Right, Grill louver motor does not operate (Initial Diagnosis) (Not displayed)

1. Checklist :

- 1) Is the input power voltage normal?
- 2) Is the Up/Down louver motor properly connected with the connector? (CN61, CN62, CN63)

2. Troubleshooting procedure

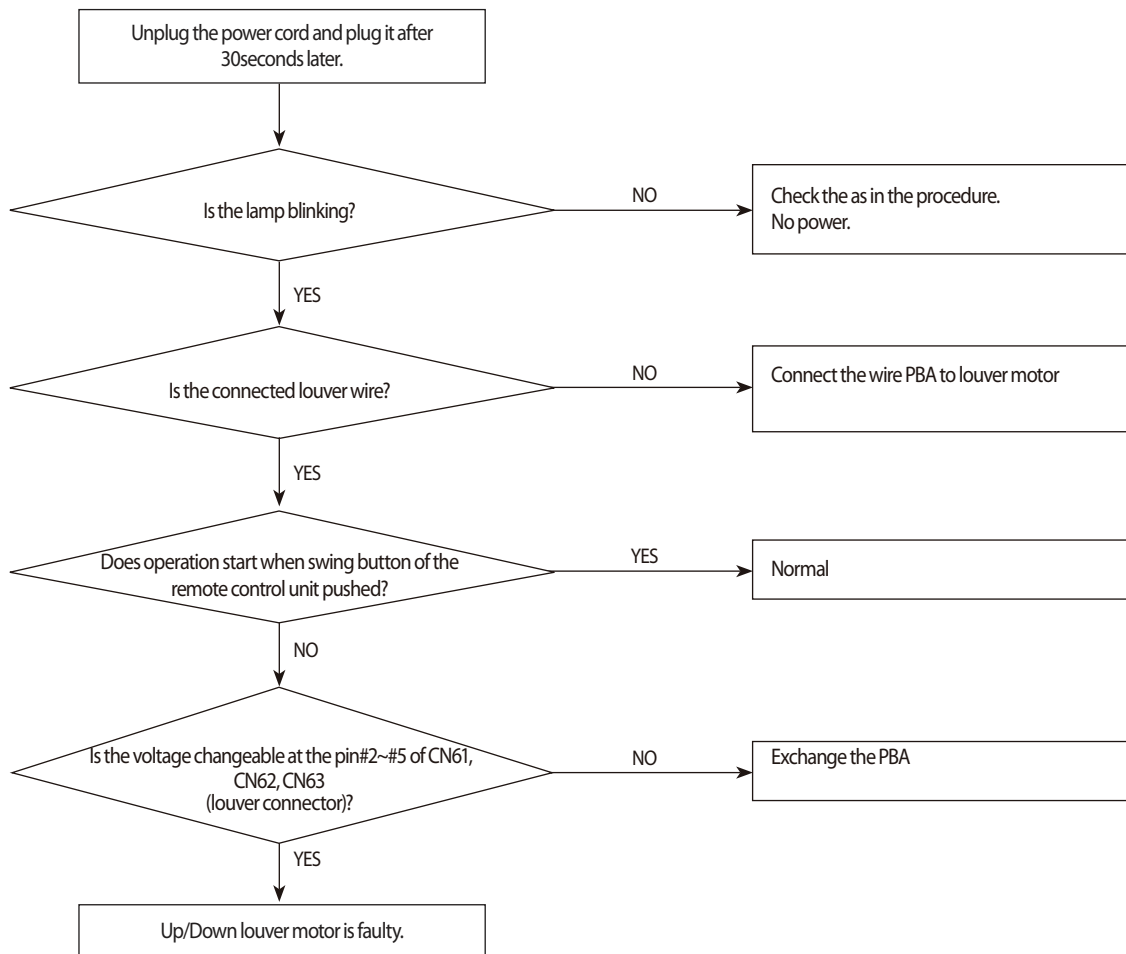

10-2-16 When the remote control is not receiving

1. Checklist :

- 1) Check if the connector was normally assembled.
- 2) Check the battery in remote control
- 3) All the lights out and check again : Change electronic typed to a fluorescent light
- 4) Put the set in operation and check the voltage of display PBA
- 5) Replace the display PBA

2. Troubleshooting procedure

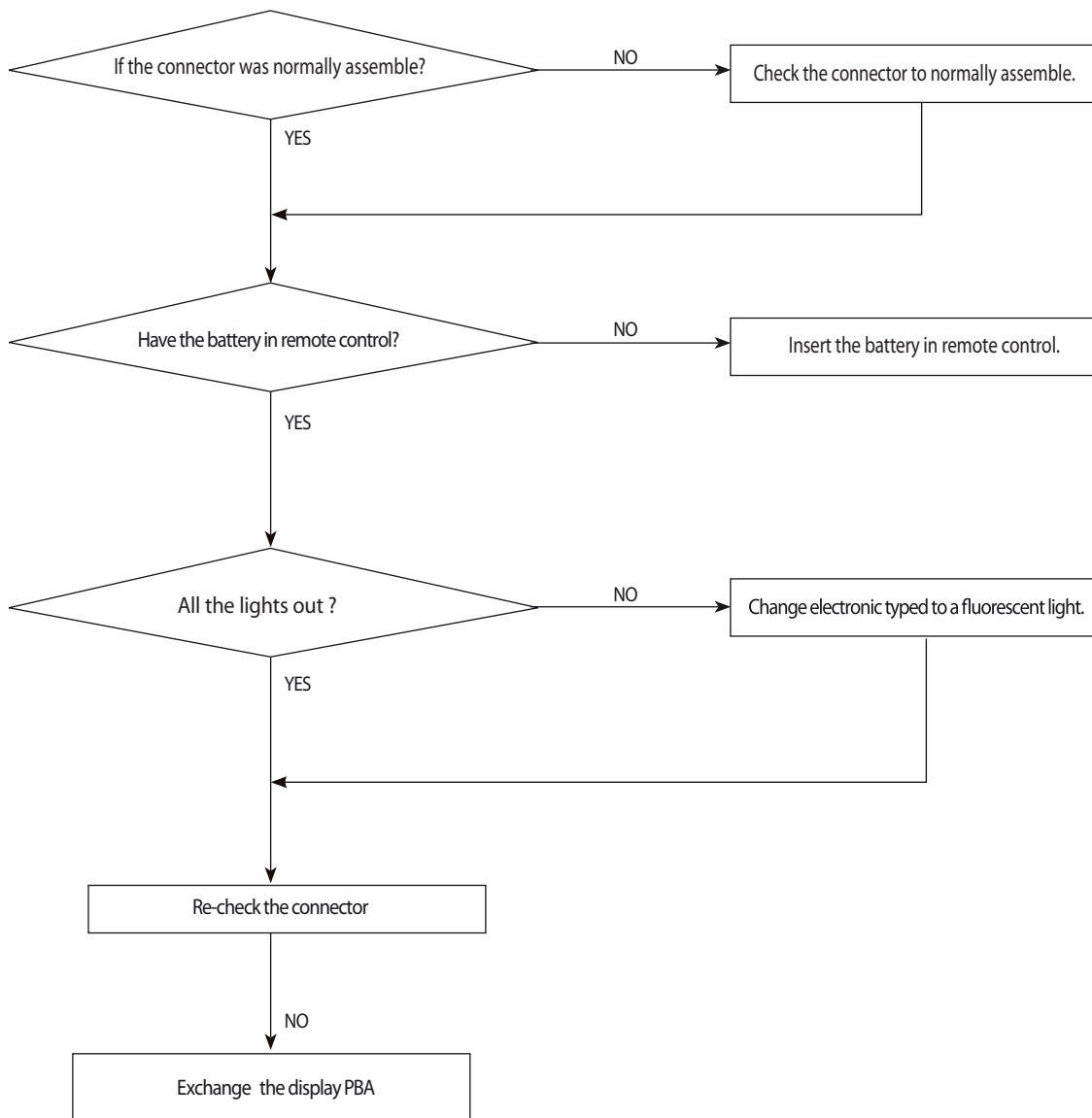

10-2-17 Smart Install error

1. Checklist :

- 1) Check the leakage region.(Use leakage detection liquid or soapy water)
- 2) When leakage region is found from service valve and piping connection flare nut part : After the related measures to check the refrigerant supplements and operation.
- 3) If the leakage region is pipe welding part : Weld leakage region after refrigerant gas release.(Brass parts should only apply)
- 4) If the leakage region is surface area (Heat exchanger or pipe welding region is not) : Replace parts.
- 5) Check the PBA Relay
 - Display of indoor unit : Ensure that the operating pilot lamp has been lighted.
 - Ensure that the Relay input voltage of indoor unit PBA is normally.(If the PBA is defective, replace)

2. When the air conditioner is in standby status, use the remote controller to start the Smart Install mode.

- 1) Press the [SET], [Mode], [Power] button simultaneously for 4 seconds.
 - Smart Install mode can be operated only with the supplied remote controller.
 - During the Smart install mode procedure, remote controller cannot be operated.

3. Troubleshooting procedure

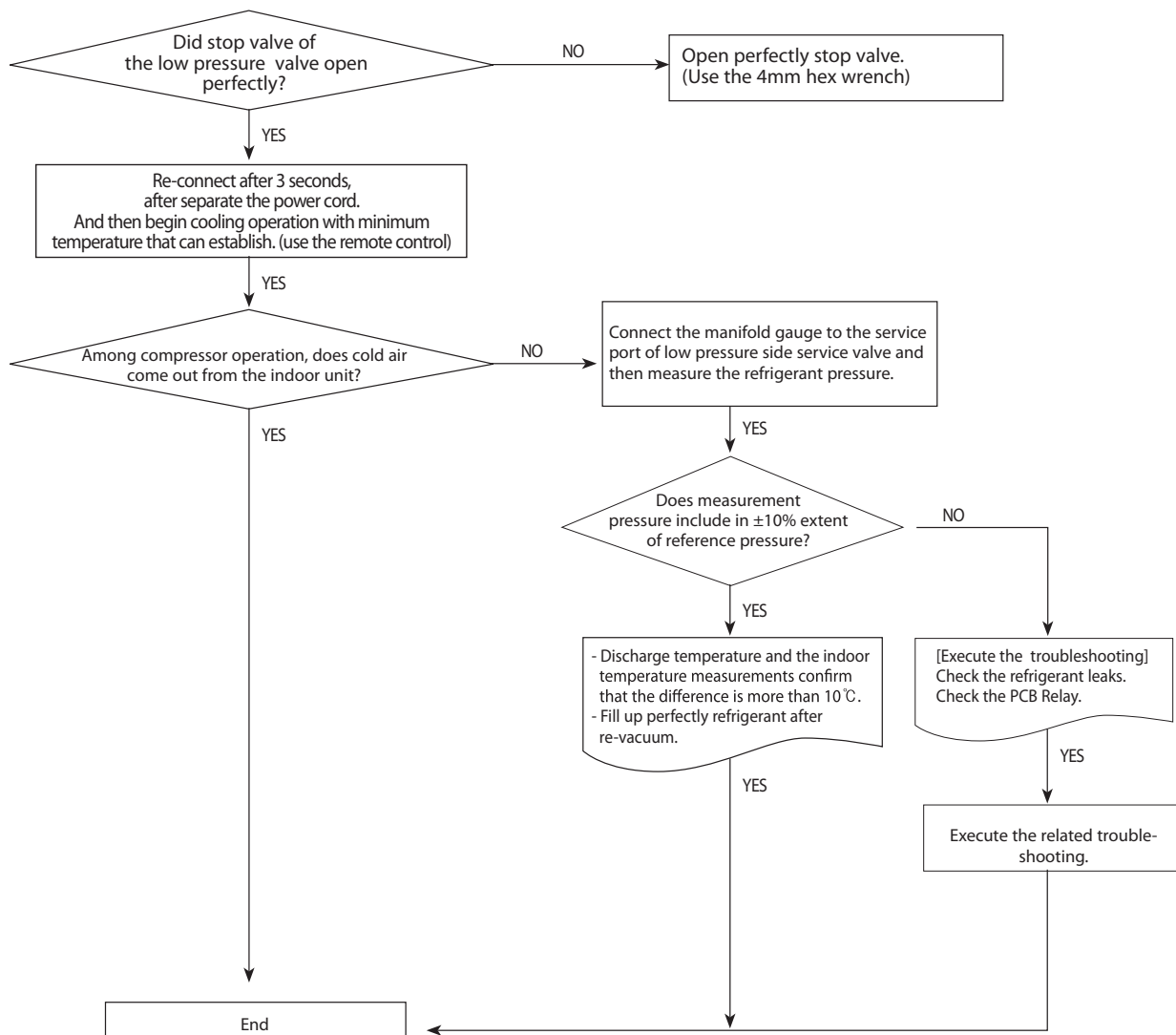

10-2-18 Outdoor OLP over temperature error (One way Inverter Only)

Indoor display

3-LED DISPLAY			DESCRIPTION
LED1	LED2	LED3	
●	○	○	No display about the outdoor condition

Outdoor display

○	○	●	Outdoor OLP over temperature error	E463
---	---	---	------------------------------------	------

1. Checklist :

- 1) Is the sensor placed correctly?
- 2) Check the service valve is closed
- 3) Check the compressor locking or gas leak

2. Troubleshooting procedure

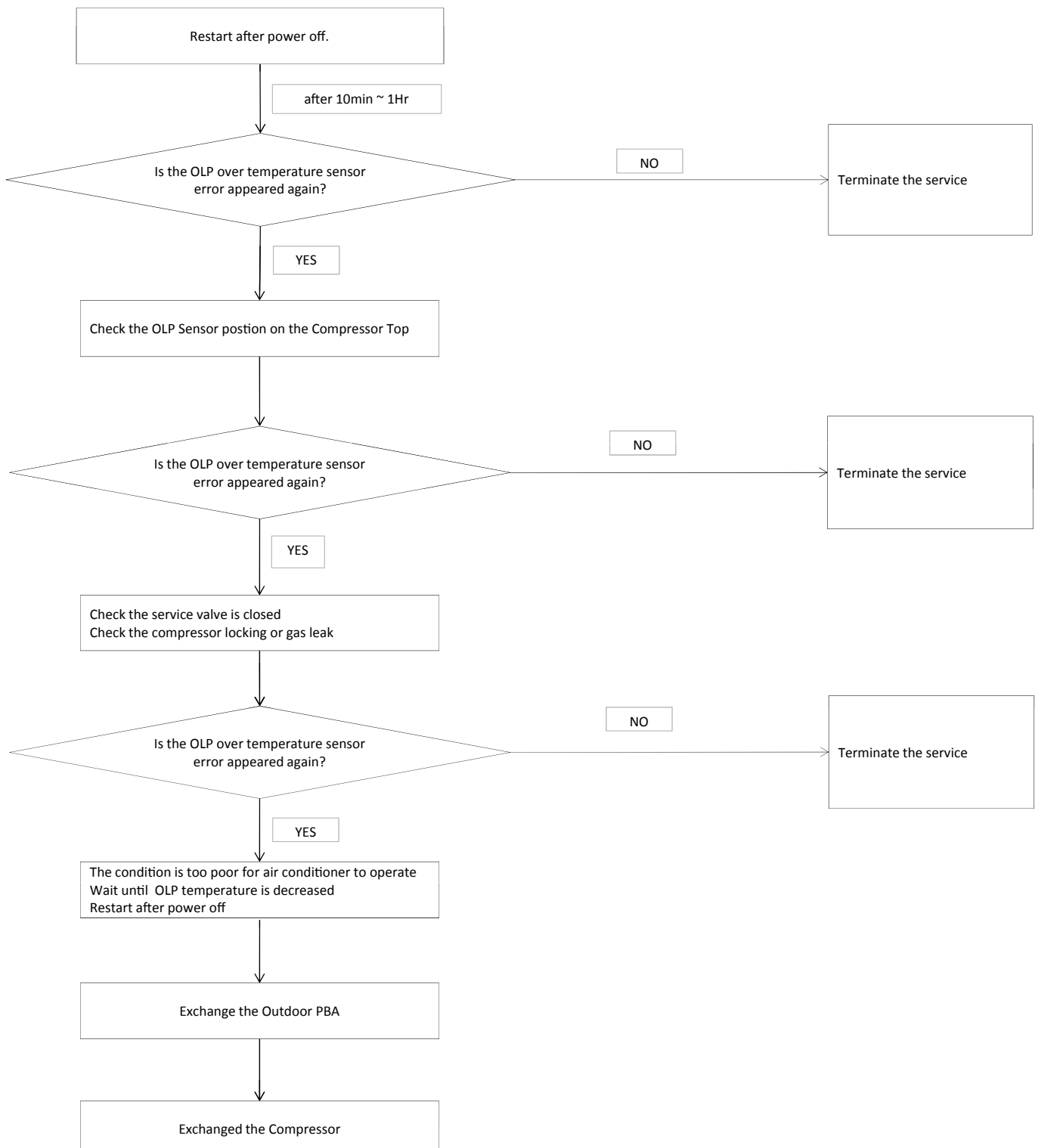

11. Block Diagram

11-1 Indoor unit

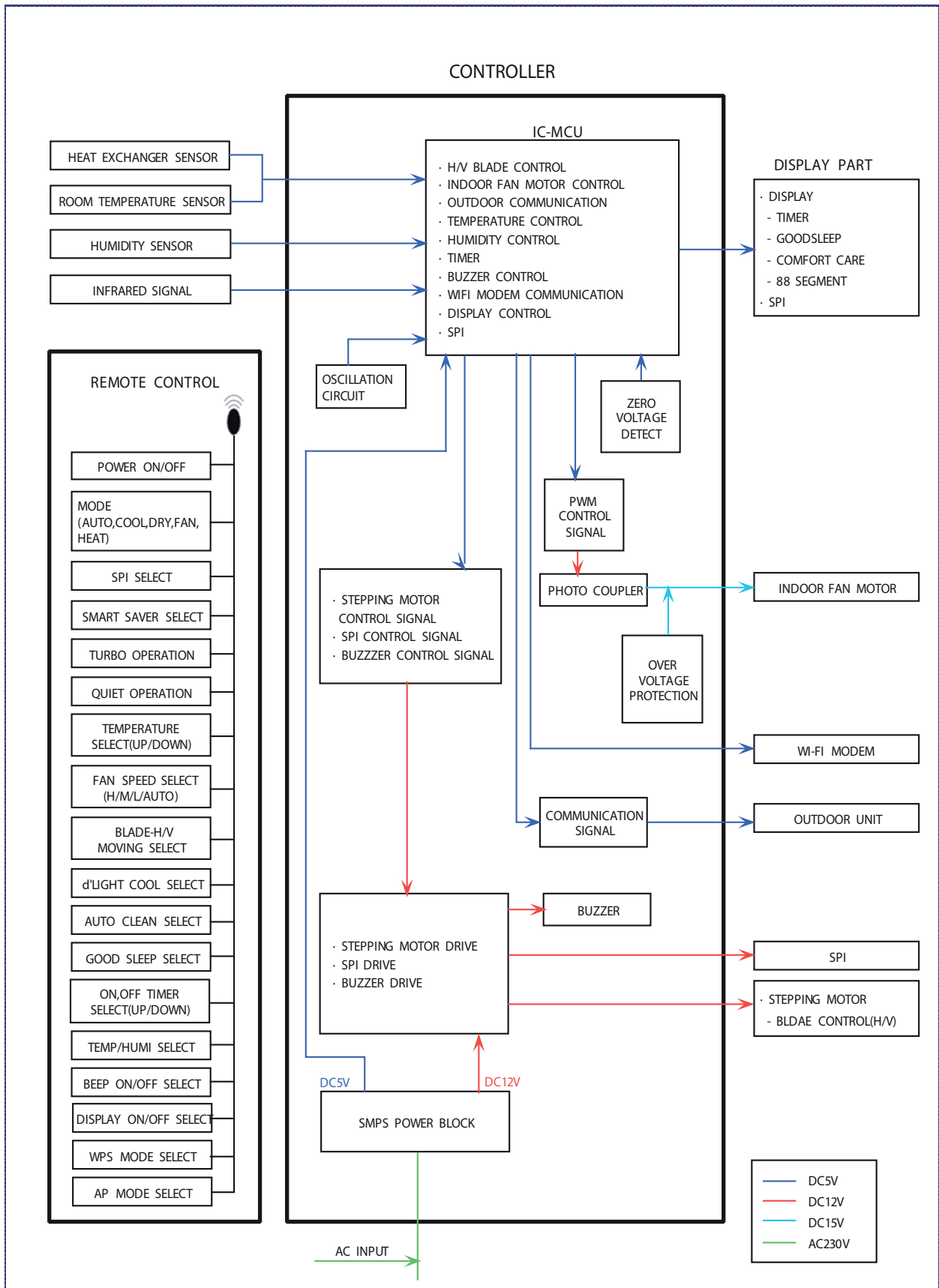

11-2 Outdoor unit

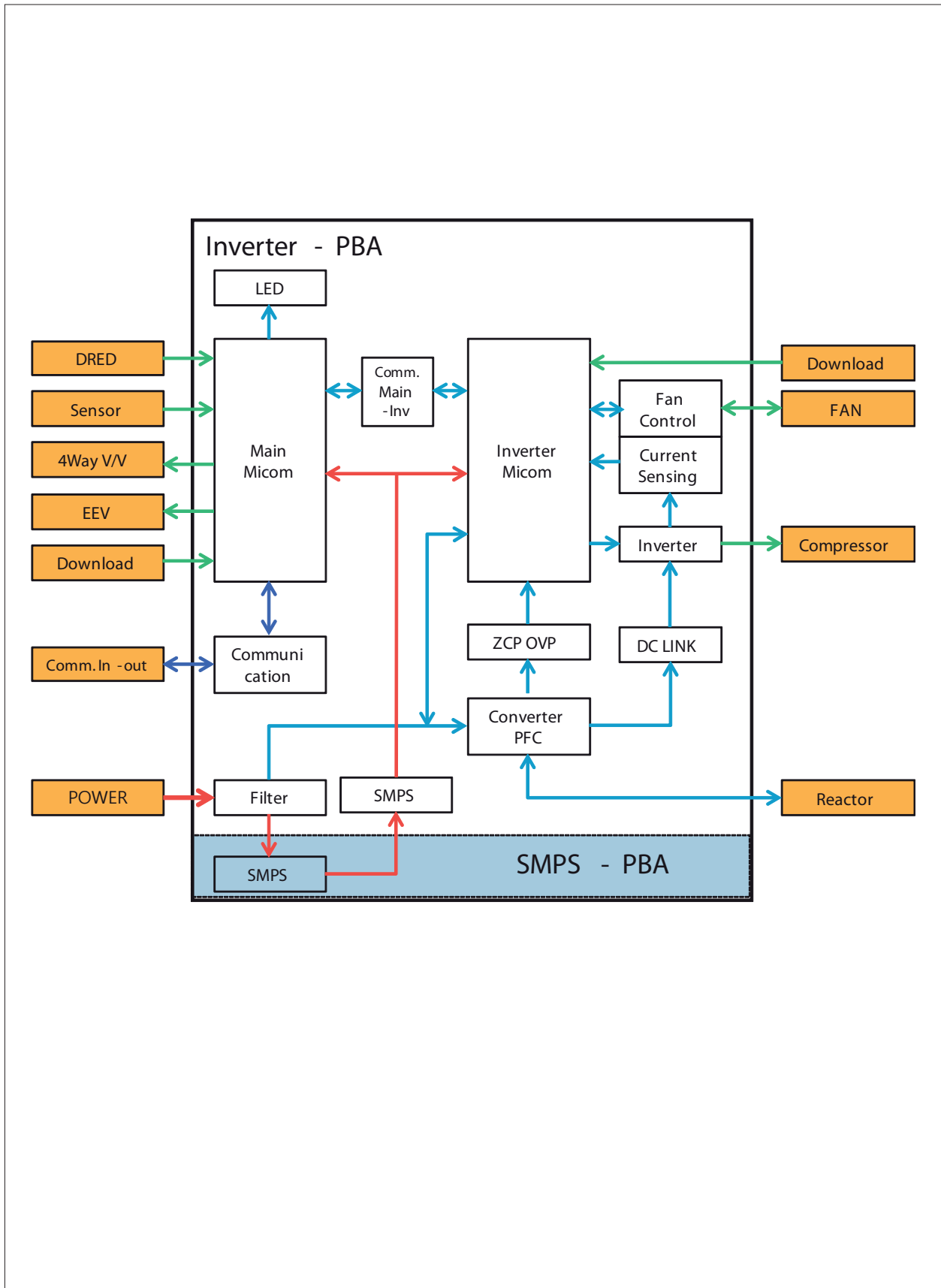

11-2-1 Pre-inspection Notices

1. Check if you pulled out the AC power plug when you eliminate the PCB or front panel
2. Don't hold the PCB side not impose excessive force on it to eliminate the PCB
3. Don't pull the lead wire but hold the whole housing to connect or disconnect a connector to the PCB
4. In case of outdoor PCB disassembly, check first the complete discharge of condenser after 1 minute power off

11-2-2 Inspection procedure

1. Check connector connection and peeling of PCB or bronze coating pattern when you think the PCB is broken
2. The PCB is composed of 3 parts
 - Indoor Main part : MICOM and surrounding circuit, relay, fan motor sensing and driving circuit, temperature sensing circuit power circuit of SMPS, buzzer circuit. Communication circuit
 - Display part : LED lamp, Switch, Remote-control module
 - Outdoor Main part : MICOM and surround circuit, fan motor sensing and driving circuit, compressor driving circuit power circuit of SMPS, PFC control circuit, 4way circuit, communication circuit, OPTION (EEV control circuit, temperature sensing circuit)

11-2-3 Indoor detailed inspection procedure

No	Procedure	Inspection Method	Cause
1	Plug out and pull the PCB out of the control box Check the PCB fuse	1) Is 1st fuse disconnected? 2) Is 2nd fuse disconnected?	. Over current . Indoor Fan motor short . AC part and pattern short of Indoor PBA
2	Supply power If the operating lamp twinkles at this time, the above 1)~3) have no relation	Check the power voltage	
		1) Is the BD71 input voltage 200Vac~240Vac?	. Power cord is fault, Fuse open, Wrong Power cable Wiring, AC part is faulty
		2) Is the voltage between both terminal of IC02 pin #1-#2 12Vdc?	. Switching Trans of Power circuit is faulty
3	Press the ON/OFF button 1. Fan speed(high) 2. Continuous Operation	3) Is the voltage between both terminal of IC02 pin #2-#3 5Vdc?	. Power circuit is faulty, Load short
		1) Is the voltage over AC 180V being imposed on terminal #3-#5 of fan motor connector (CN72)?	. Fan motor of the indoor is faulty
		2) The fan motor of the indoor unit doesn't run	. Fan motor connector(CN72) is faulty
		3) The power voltage between terminal #3-#5 of the connector(CN72) is 0V	. PBA is faulty

11-2-4 Outdoor detailed inspection procedure

No	Procedure	Inspection Method	Cause
1	Plug out and pull the PCB out of the control box Check the PCB fuse (Wait 3 minutes after power off)	1) Is 1st fuse disconnected?	. Over current . AC part and pattern short of Outdoor PBA
2	Check the Wiring	1) Is the Compressor wire connected clockwise? 2) Is the Reactor wire connected normal? 3) Is the Fan wire connected normal? 4) Is the 4way wire connected normal? 5) Is the sensor wire connected normal? 6) Is the EEV wire connected normal?	. Wrong assembly . Installation(service) condition is bad
3	"Supply power and operate the set (Use Remote-control, button in indoor set)"	Check the power voltage	
		1) Is the voltage between Terminal block L-N 200Vac~240Vac?	. Power cord is faulty, Wrong Power cable Wiring
		2) Is the C006 voltage 200Vac~240Vac?	. Fuse open . L,N,F1,F2 wire wrong wiring (Terminal Block-PBA)
		2) Is the CN150 voltage 200Vac~240Vac?	. Power circuit is faulty . Load short
		4) Is the PFC050(#26-#27) voltage 200Vac~240Vac after 3 minutes later?	. Fuse open . L,N,F1,F2 wire wrong wiring (Terminal Block-PBA) . PTC020 open . RY021, RY022 is faulty . Outdoor Micom(IC201) error
		5) Is the CE101 voltage 280Vdc~320dc after 3 minutes later?	. PFC050 is faulty . Reactor wire is wrong connection . Power circuit is faulty, Load short . BLDC Fan motor error
		6) Is the voltage CN151 #1-#2 voltage 15Vdc?	. Switching Trans of Power circuit is faulty . Load short
		7) Is the voltage CN152 #1-#2 voltage 12Vdc?	. Switching Trans of Power circuit is faulty . Load short
		8) Is the voltage CN151 #3-#2 voltage 5Vdc?	. Switching Trans of Power circuit is faulty . Load short
4	Check the LED lamp display	1) Normal : RED on, GRN blink, YEL off 2) Abnormal - All off : check no power - abnormal display : check error mode	. F1,F2 wire wrong wiring . Outdoor PBA is faulty

12. Reference Sheet

12-1 Low Refrigerant Pressure Distribution

Note : Please measure the refrigerant pressure after the air conditioner operates on testing cooling mode during more than 10 minutes.

- Indoor Temp. Variation : 20°C ~ 32°C
- Outdoor Temp. Variation : -5°C ~ 45°C

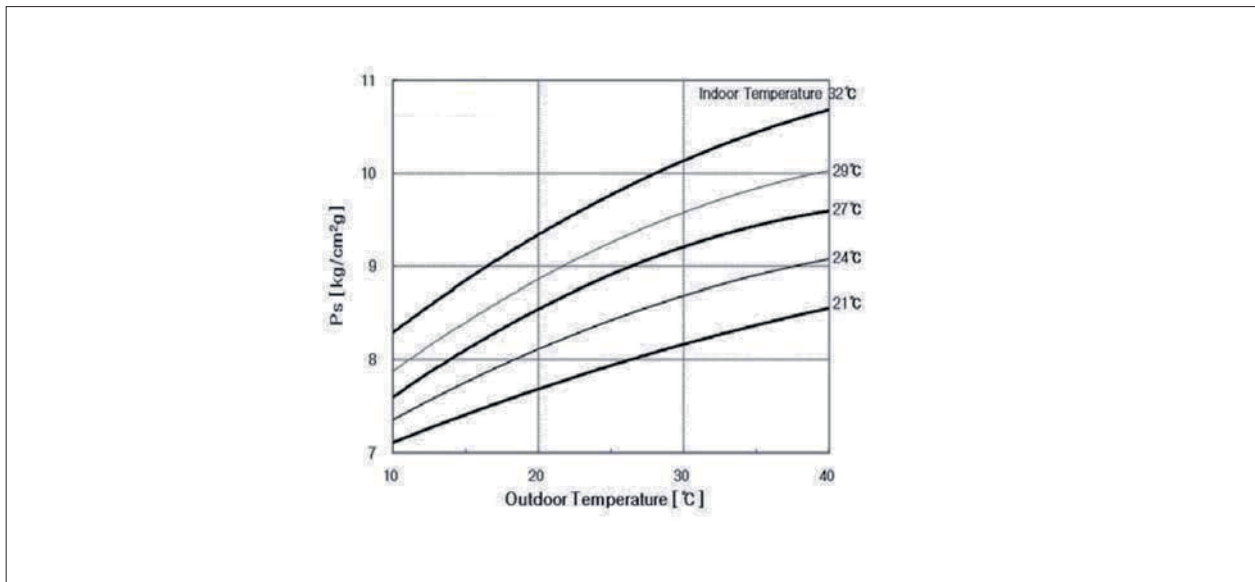

12-2 Pressure & Capacity mark

■ Power/Heat

W	cal/s	kcal/h	Btu/h	HP	kg.m/s	lb.m/s
1	0.23885	0.85985	3.4121	0.001341	0.10197	0.73756
4.1868	1	3.6	14.286	0.0056146	0.42693	3.088
1.163	0.27778	1	3.9683	0.0015596	0.11859	0.85778
0.29307	0.06999	0.252	1	3.9302×10 ⁻⁴	0.029885	0.21616
745.7	178.11	641.19	2,544.4	1	76.04	550
9.8067	2.3423	8.4322	33.462	0.013151	1	7.233
1.3558	0.32383	1.0658	4.6262	0.0018182	0.13826	1

12-3 Q & A for Non-trouble



Classification	Class	Description
Cooling	Q	The cooling is weak.
	A	When it is hot outside, its cooling capacity decreases due to the increase of the ambient temperature. When the dust filter gets blocked or warm outside air gets in, the cooling capacity will decrease. So, make sure to clean the dust filter frequently, prevent heat loss by closing the doors and insulate the cooling area by using curtains, blinds, shades or window tinting.
	Q	The cooling is good generally. But, it gets weak when it is considerably hot.
	A	It occurs when the outdoor unit is exposed to direct sun light and heat-up air is not ventilated well. So, set up a sunblind over the outdoor unit and keep stuff away from the unit to increase the ventilation. When the cooling capacity decreases during a heat wave, clean the heat exchanger of the outdoor unit or spray some cold water to the heat exchanger to increase the cooling capability.
	Q	The cooling is weak. Does it need refrigerant charging?
	A	It is not correct charging refrigerant regularly. Except that you have moved in several times or the connection pipes are broken, the refrigerant does not run low. So, when refrigerant is additionally charged, it could be costly and cause a product's failure. When the refrigerant leaks, all of it will escape in a short time resulting in cooling failure and no water coming out of the drain hose. So, if water comes out from the drain hose, it indicates the normal operation of the product and it does not need refrigerant charging.
	Q	It fails to do cooling.
Leakage	A	When the air conditioner is set to ventilation or the desired temperature is set higher than the current temperature, it fails to do cooling. In this case, select cooling or set the desired temperature lower.
	Q	It floods the floor.
	A	Place the drain hose properly. When it is not placed properly, the drain water would flow back flooding the floor. So, straighten out the drain hose for the water to be drained well.
	Q	Water drips at the drain connection (service valve) of the outdoor unit.
	A	When a glass bottle is taken out of the refrigerator, moisture gets condensed on its surface due to the temperature differences. The same principle applies to the air conditioner. When cold refrigerant goes through the copper tube, moisture gets condensed on the surface of the tube and the connection areas. To prevent the water condensation, the pipes are insulated. But, the connection areas of the outdoor unit are not insulated for the purpose of maintenance or repair, and water gets condensed due to the temperature differences and drips down. Generally, it evaporates right away. But, when it drips much during muggy days, put a water pan on the floor.
	Q	It leaks even though a drain pump is used.
Smells	A	It occurs when the drain pump is plugged out or it is out of order. Check the power of the drain pump and the position of the drain hose, and when the pump is faulty, contact the drain pump manufacturer. Samsung Electronics do not manufacture drain pumps. So, we are not able to correct the drain pump problems.
	Q	Whenever the air conditioner is turned on, it irritates my eyes and gives me a headache.
Smells	A	There are no components in the air conditioner irritating the eyes and sending out chemical smells. But, when the air conditioner is turned on, other smell sources are sucked into the air conditioner and get out of it. So find and root out the smell sources. Generally, it occurs at a interior renovated place, a pharmacy, a gasoline handling place, a tire shop, a second-hand book shop or an electronic component handling place, when its chemical or musty smells are sucked in and sent out, it can be misled that the air conditioner generates them.

Classification	Class	Description
Smells	Q	Whenever the air conditioner is turned on, it stinks.
	A	When are no components in the air conditioner sending out chemical smells. But, when the air conditioner is turned on, other smell sources are sucked into the air conditioner and get out of it. So, find and root out the smell sources. Generally, when the drain hose is taken out to the washing room or there are sources of smells such as a diaper bin, a shoe shelf or a socks bin, bad smells generate. Also, it occurs where glass cleaners or air fresheners are used; when they are sucked in interacting with dusts and moistures inside, bad smells generate. these kinds of organic materials noxious to human bodies. So, we recommend against the use of them.
	Q	Whenever the air conditioner is turned on, it smells sour.
	A	When the room is papered recently, its paste smells would be sucked inside. Also, when the air conditioner is installed in the study room of young boys loving sweat-generating activities such as the basketball, excessive sweats evaporate and get sucked into the air conditioner resulting in bad smells. So, find and root out problem or refresh the room frequently.
	Q	Whenever the air conditioner is turned on, it smells musty.
	A	It is due to the improper keeping of the product after its use. When keeping the product, dry up the inside with the operation of ventilation to prevent must. When the product is kept without drying up the inside with ventilation, mold would grow inside resulting in must. So, open the windows and switch on the ventilation function to get rid of the saturated smell inside.
	Q	Whenever the air conditioner is turned on, it sends out bad smells such as stale smells.
	A	It occurs generally when there are pet animals in the house. Their smells stay at the same place. But, when the air conditioner is turned on, the air gets circulated resulting in the circulation of the smells. So, find and root out the problem or refresh the room frequently.
	Q	It sends out bad smells.
A	When the air filter is filthy, it could send out bad smells. So, clean the filter and ventilate the room with the windows open while operating the ventilation function.	
Operation	Q	It won't start.
	A	There is a power failure or it is plugged out. Also, check if the power distribution panel is switched off.
	Q	It goes off during operation.
	A	When the hot air does not escape properly, it goes off during operation. it occurs when it does not ventilate properly because the outdoor unit is covered, the back of the outdoor unit is blocked by a cardboard or a plywood panel, and the front of the outdoor unit is blocked by the closed window or other obstacles. Clear the above obstacles from the outdoor unit.
	Q	It generally works properly. But, when it's considerably hot, it goes off during operation.
	A	It occurs when the outdoor unit is exposed to direct sunlight and the hot air does not escape properly. Set up a sun blind over the outdoor unit and clear the neighboring obstacles from the outdoor unit to provide good ventilation. When it goes off frequently during a heat wave, it would prevent the turn-off and increase the cooling capacity cleaning the outdoor unit or spraying some water to the heat exchanger.
	Q	The remote controller won't operate.
A	When the batteries run out or the transmitter or receiver of the remote controller is blocked by obstacles, change the batteries or keep the obstacles away from the controlling area. Also, the remote controller may not work under intensive light from a 3-wave length lamp or a neon sign due to the EMI. In this case, take the remote controller closer to the receiver.	

Classification	Class	Description
Installation	Q	Who installs the air conditioner? (Relocation/Re-installation)
	A	When relocating or re-installing the air conditioner, make sure to contact Samsung Electronics Service Center or Authorized Service Agent and have them to do the job. (If not, it could cause personal injury or product damage.) The cost for the relocation/re-installation of the air conditioner is subject to the customer's expense. There is a cost table. But, our service engineer needs to visit to total up the cost correctly. When you move in, make sure to contact Samsung Electronics Service Center or Authorized Service Agent in advance to streamline the process.
	Q	Is it possible to install the outdoor unit outside?
	A	It is possible to install it at a designated place in the apartment or on the rooftop nearby. But, it's illegal hanging an angle iron case with the outdoor unit in it outside the apartment. Also, it is illegal obstructing passers-by with the outdoor unit installed outside.
	Q	What can be done to install the outdoor unit facing the road because it is a commercial building?
	A	The following is an excerpt from building code going into effect from JUNE 1 st 2005. "The exhaust pipe of a cooling or ventilation facility installed in a building adjacent to the streets of commercial or residential areas shall be installed higher than 2 m to prevent the exhaust air from blowing directly to passers-by and the current facilities shall be corrected by MAY 31 st 2005." So, please install it higher than 2 m or not to blow the hot exhausting air directly to passers-by.
	Q	What about installing a windscreen during installation not to blow hot air directly to passers-by?
A	When the hot air from the front of the outdoor unit is blocked, the product's performance will be affected and it will fail to operate properly. So, keep it at least 300mm away from its surrounding walls and give it good ventilation.	

Cleaning at a Glance

Running Auto clean

- 1 Method 1: Press **Options (Clean 3sec)** button for 3 seconds or more.
Method 2: **Options (Clean 3sec)** → **<** **>** → **Select [Clean]** → **SET (°C-°F 3sec)**
• The indoor unit display shows :

- 2 The Auto clean function is activated.
- 3 When operation is off, auto clean starts for 10 min.
 - The indoor unit display shows cleaning progress (from 1 to 99%).
- 4 The air conditioner is automatically turned off.

To deactivate the Auto clean function

Method 1: Press the **Options (Clean 3sec)** button for 3 seconds or more.

Method 2: **Options (Clean 3sec)** → **<** **>** → **Select [Clean]** → **SET (°C-°F 3sec)**

To cancel the Auto clean operation

Press the **⏻** button twice within 20 seconds.

- NOTE**
- When the air conditioner is off, the Auto clean function starts immediately; when the air conditioner is in operation, the Auto clean function starts as soon as the air conditioner stops running.
 - If you starts a function while in the Auto clean operation, the Auto clean function is reset, and then is restarted when that function is stopped or completed.

Cleaning the indoor unit exterior and outdoor unit heat exterior

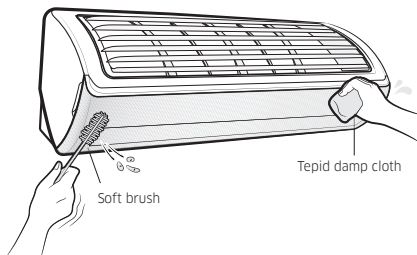

Before cleaning, be sure to turn off the equipment and disconnect the power plug.

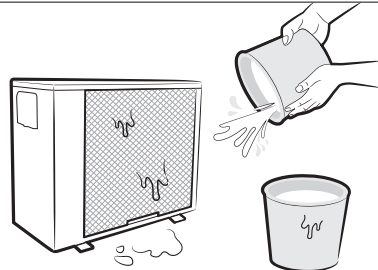

Spray water to clean the dust.

⚠ CAUTION

- Do not clean the display by using alkaline detergent.
- Do not use sulphuric acid, hydrochloric acid, or organic solvents (such as thinner, kerosene, and acetone) to clean the surfaces. Do not put any stickers on it as this can damage the surface of the air conditioner.
- When you clean and inspect the heat exchanger on the outdoor unit, contact the local service centre for help.

Cleaning the filter

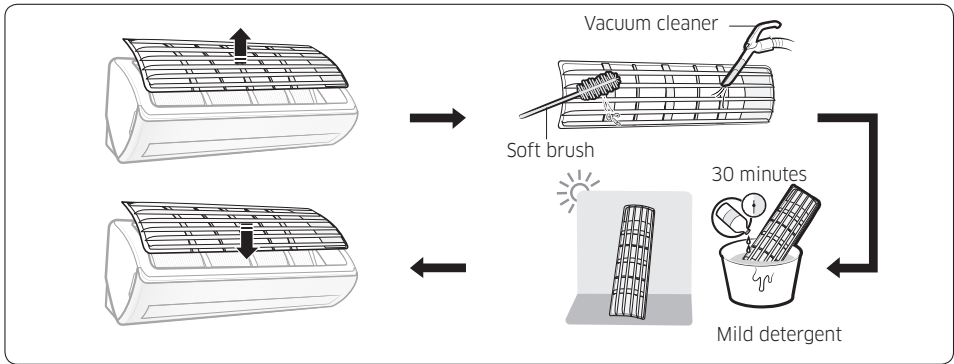

⚠ CAUTION

- Do not scrub the air filter with a brush or other cleaning utensil. This may damage the filter.
- Do not expose the air filter to direct sunlight when drying it.

📄 NOTE

- Clean the air filter every 2 weeks. Cleaning term may vary depending on the usage and environmental conditions.
- If the air filter dries in a humid area, it may produce offensive odours. Clean it again and dry it in a well-ventilated area.

Resetting the filter-cleaning reminder

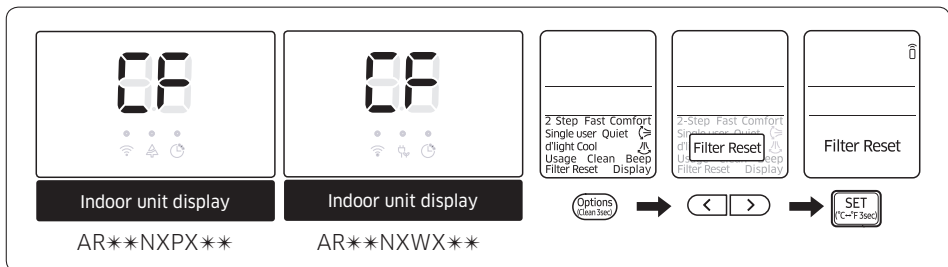

Tip on cleaning the wind-free panel

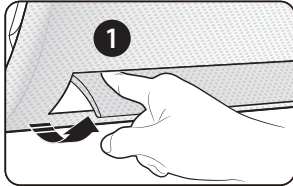

Gently push the air flow blade with your finger until it is open.

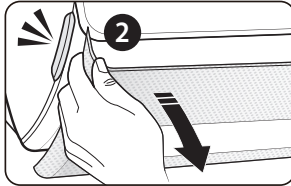

Hold and pull both sides of the wind-free panel until it is detached from the air conditioner.

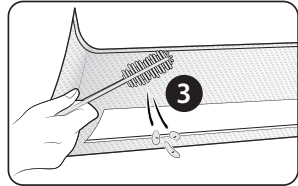

Remove the dust with a soft brush or vacuum cleaner.

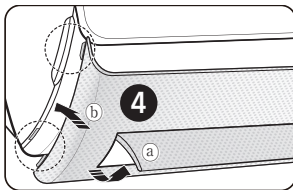

Gently push the air flow blade with your finger to open (a), then align and engage the protrusions (top left, top right, bottom left, bottom right) on the wind-free panel into the grooves on the front panel (b).

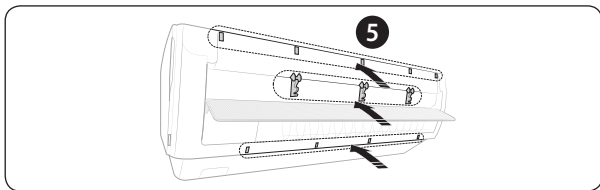

Push the 5 latches on top, 3 on center, and 4 on bottom with your hand.

CAUTION

- If you assemble the air flow blade without pushing it by hand, it may be obstructed by the wind-free panel and may not open when the air conditioner operates.

12-5 Installation of the product

- **IMPORTANT:** When installing the unit, always remember to connect first the refrigerant tubes, then the electrical lines. Always disassemble the electric lines before the refrigerant tubes.
- Upon receipt, inspect the product to verify that it has not been damaged during transport. If the product appears damaged, **DO NOT INSTALL** it and immediately report the damage to the carrier or retailer (if the installer or the authorised technician has collected the material from the retailer.)
- After completing the installation, always carry out a functional test and provide the instructions on how to operate the air conditioner to the user.
- Do not use the air conditioner in environments with hazardous substances or close to equipment that release free flames to avoid the occurrence of fires, explosions or injuries.
- Our units must be installed in compliance with the spaces indicated in the installation manual to ensure either accessibility from both sides or ability to perform routine maintenance and repairs. The units' components must be accessible and that can be disassembled in conditions of complete safety either for people or things. For this reason, where it is not observed as indicated into the Installation Manual, the cost necessary to reach and repair the unit (in safety, as required by current regulations in force) with slings, trucks, scaffolding or any other means of elevation won't be considered in-warranty and will be charged to end user.
- The outdoor unit shall be installed in an open space that is always ventilated.
- The local gas regulations shall be observed.
- To handle, purge, and dispose the refrigerant, or break into the refrigerant circuit, the worker should have a certificate from an industry-accredited authority.
- Do not install the indoor unit in the following areas:
 - Area filled with minerals, splashed oil, or steam. It will deteriorate plastic parts, causing failure or leakage.
 - Area that is close to heat sources.
 - Area that produces substances such as sulfuric gas, chlorine gas, acid, and alkali. It may cause corrosion of the pipings and brazed joints.
 - Area that can cause leakage of combustible gas and suspension of carbon fibers, flammable dust, or volatile flammables.
 - Area where refrigerant leaks and settles.
 - Area where animals may urinate on the product. Ammonia may be generated.
- Do not use the indoor unit for preservation of food items, plants, equipment, and art works. This may cause deterioration of their quality.
- Do not install the indoor unit if it has any drainage problem.
- When installing the outdoor unit at the seaside, make sure that it is not directly exposed to sea breeze. If you cannot find an adequate place free from direct sea breeze, construct a protection wall or a protective fence.
 - Install the outdoor unit in a place (such as near buildings etc.) where it can be protected from sea breeze. Failure to do so may cause a damage to the outdoor unit.

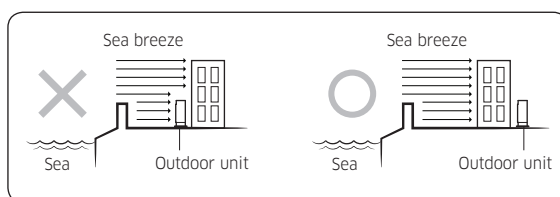

- If you cannot avoid installing the outdoor unit at the seaside, construct a protection wall around to block the sea breeze.

12-5 Installation of the product

- Construct a protection wall with a solid material such as concrete to block the sea breeze. Make sure that the height and the width of the wall are 1.5 times larger than the size of the outdoor unit. Also, secure a space larger than 600 mm between the protection wall and the outdoor unit for exhausted air to ventilate.

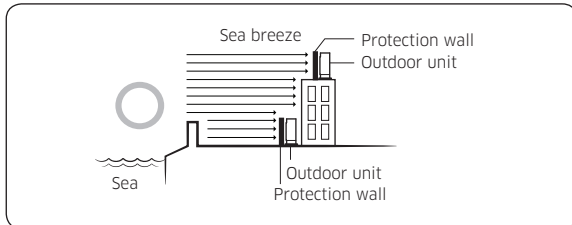

- Install the unit in a place where water can drain smoothly.
- If you have any difficulty finding installation location as prescribed above, contact your manufacturer for details.
- Be sure to clean the sea water and the dust on the heat exchanger of the outdoor unit and apply a corrosion inhibitor on it. (At least once in a year.)
- Installation of the outdoor unit
- While in installation or relocation of the product, do not mix the refrigerant with other gases including air or unspecified refrigerant. Failure to do so may cause pressure increase to result in rupture or injury.
- Do not cut or burn the refrigerant container or pipings.
- Use clean parts such as manifold gauge, vacuum pump, and charging hose for the refrigerant.
- Installation must be carried out by qualified personnel for handling the refrigerant. Additionally, reference the regulations and laws.
- Be careful not to let foreign substances (lubricating oil, refrigerant, water, etc.) enter the pipings. The application of oil or refrigerant deteriorates the pipings to result in drain leakage. For storage, securely seal their openings.
- When mechanical ventilation is required, ventilation openings shall be kept clear of obstruction.
- For disposal of the product, follow the local laws and regulations.
- Do not work in a confined place.
- The work area shall be blocked.
- The refrigerant pipings shall be installed in the position where there are no substances that may result in corrosion.
- The following checks shall be performed for installation:
 - The charging amount depends on the room size.
 - The ventilation devices and outlets are operating normally and are not obstructed.
 - Markings and signs on the equipment shall be visible and legible.
- Upon leakage of the refrigerant, ventilate the room. When the leaked refrigerant is exposed to flame, it may cause generation of toxic gases.
- Make sure that the work area is safe from flammable substances.
- To purge air in the refrigerant, be sure to use a vacuum pump.
- Note that the refrigerant has no odour.
- The units are not explosion proof so they must be installed with no risk of explosion.
- This product contains fluorinated gases that contribute to global greenhouse effect. Accordingly, do not vent gases into the atmosphere.

12-5 Installation of the product

- Because the working pressure for R32 is 1.6 times higher than that for R22, use exclusive pipings and tools specified. In case of replacing an R22 model with an R32 model, be sure to replace the conventional pipings and flare nuts with exclusive ones.
- The models that use the refrigerant R32 have a different thread diameter for the charging port to prevent charging failure. Therefore, check its diameter (1/2 inch) in advance.
- Servicing shall be performed as recommended by the manufacturer. In case other skilled persons are joined for servicing, it shall be carried out under supervision of the person who is competent in handling flammable refrigerants.
- For servicing the units containing flammable refrigerants, safety checks are required to minimise the risk of ignition.
- Servicing shall be performed following the controlled procedure to minimize the risk of flammable refrigerant or gases.
- Do not install where there is a risk of combustible gas leakage.
- Do not place heat sources.
- Be cautious not to generate a spark as follows:
 - Do not remove the fuses with power on.
 - Do not disconnect the power plug from the wall outlet with power on.
 - It is recommended to locate the outlet in a high position. Place the cords so that they are not tangled.
- If the indoor unit is not R32 compatible, an error signal appears and the unit will not operate.
- After installation, check for leakage. Toxic gas may be generated and if it comes into contact with an ignition source such as fan heater, stove, and cooker.cylinders, make sure that only the refrigerant recovery cylinders are used.

Preparation of fire extinguisher

- If a hot work is to be done, an appropriate fire extinguishing equipment should have been available.
- A dry powder or CO2 fire extinguisher shall be equipped near the charging area.

Ignition sources free

- The service engineers shall not use any ignition sources with the risk of fire or explosion.
- Potential ignition sources shall be kept away from the work area where the flammable refrigerant can possibly be released to the surrounding.
- The work area should be checked to ensure that there are no flammable hazards or ignition risks. The “No Smoking” sign shall be attached.
- Under no circumstances shall potential sources of ignition be used while in detection of leakage.
- Make sure that the seals or sealing materials have not degraded.
- Safe parts are the ones with which the worker can work in a flammable atmosphere. Other parts may result in ignition due to leakage.

Area ventilation

- Make sure that the work area is well ventilated before performing a hot work.

12-5 Installation of the product

- Ventilation shall be made even during the work.
- The ventilation should safely disperse any released gases and preferably expel them into the atmosphere.
- Ventilation shall be made even during the work.

Leakage detection methods





- The leakage detector shall be calibrated in a refrigerant-free area.
- Make sure that the detector is not a potential source of ignition.
- The leakage detector shall be set to the LFL (lower flammability limit).
- The use of detergents containing chlorine shall be avoided for cleaning because the chlorine may react with the refrigerant and corrode the pipings.
- If leakage is suspected, naked flames shall be removed.
- If a leakage is found while in brazing, the entire refrigerant shall be recovered from the product or isolated (e.g. using shut-off valves). It shall not be directly released to the environment. Oxygen free nitrogen (OFN) shall be used for purging the system before and during the brazing process.

Recovery

- When removing refrigerant from the system for servicing or decommissioning, it is recommended to remove the entire refrigerant.
- When transferring refrigerant into cylinders, make sure that only the refrigerant recovery cylinders are used.
- All cylinders used for the recovered refrigerant shall be labelled.
- Cylinders shall be equipped with pressure relief valves and shut-off valves in a proper order.
- Empty recovery cylinders shall be evacuated and cooled before recovery.
- The recovery system shall operate normally according to the specified instructions and shall be suitable for refrigerant recovery.
- In addition, the calibration scales shall operate normally.
- Hoses shall be equipped with leak-free disconnect couplings.
- Before starting the recovery, check for the status of the recovery system and sealing state. Consult with the manufacturer if suspected.
- The recovered refrigerant shall be returned to the supplier in the correct recovery cylinders with the Waste Transfer Note attached.
- Do not mix refrigerants in the recovery units or cylinders.
- If compressors or compressor oils are to be removed, make sure that they have been evacuated to the acceptable level to ensure that flammable refrigerant does not remain in the lubricant.
- The evacuation process shall be performed before sending the compressor to the suppliers.
- Only the electrical heating to the compressor body is allowed to accelerate the process.
- Oil shall be drained safely from the system.
- For installation with handling the refrigerant (R32), use dedicated tools and piping materials. Because the pressure of the refrigerant, R32 is approximately 1.6 times higher than that of R22, failure to use the dedicated tools and piping materials may cause rupture or injury. Furthermore, it may cause serious accidents such as water leakage, electric shock, or fire.
- Never install a motor-driven equipment to prevent ignition.

12-6 Optional: Extending the power cable

1 Prepare the following tools.

Tools	Spec	Shape
Crimping pliers	MH-14	
Connection sleeve (mm)	20xØ6.5 (HxOD)	
Insulation tape	Width 19 mm	
Contraction tube (mm)	70xØ8.0 (LxOD)	

2 As shown in the figure, peel off the shields from the rubber and wire of the power cable.

- Peel off 20 mm of cable shields from the pre-installed tube.

CAUTION

- For information about the power cable specifications for indoor and outdoor units, refer to the installation manual.
- After peeling off the tube wire, you must insert a contraction tube.

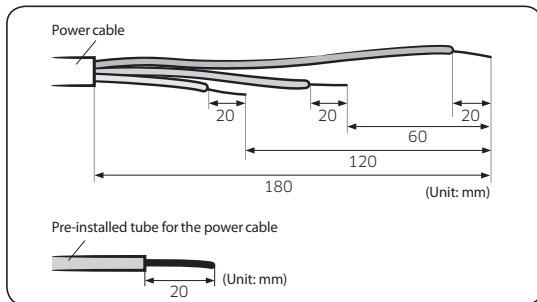

3 Insert both sides of core wire of the power cable into the connection sleeve.

- Method 1: Push the core wire into the sleeve from both sides.
- Method 2: Twist the wire cores together and push it into the sleeve.

Method 1

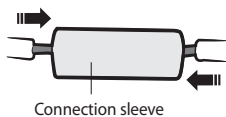

Method 2

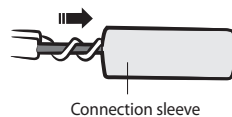

4 Using a crimping tool, compress the two points and flip it over and compress another two points in the same location.

- The compression dimension should be 8.0.

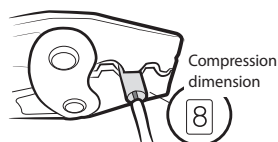

12-6 Optional: Extending the power cable

- After compressing it, pull both sides of the wire to make sure it is firmly pressed.

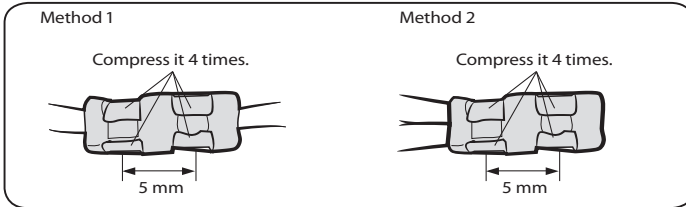

- 5 Wrap it with the insulation tape twice or more and position your contraction tube in the middle of the insulation tape. Three or more layers of insulation are required.

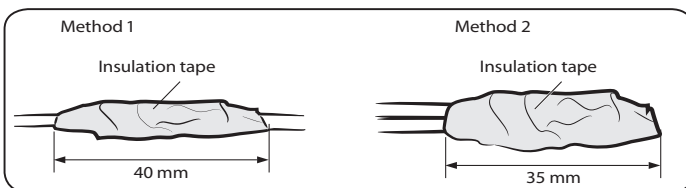

- 6 Apply heat to the contraction tube to contract it.

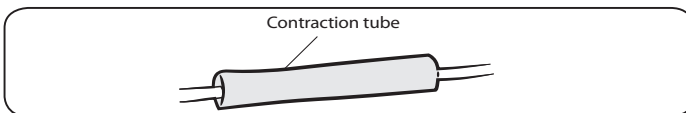

- 7 After tube contraction work is completed, wrap it with the insulation tape to finish.

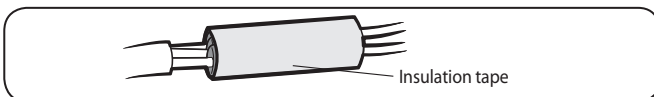

⚠ CAUTION



- Make sure that the connection parts are not exposed to outside.
- Be sure to use insulation tape and a contraction tube made of approved reinforced insulating materials that have the same level of withstand voltage with the power cable. (Comply with the local regulations on extensions.)

⚠ WARNING

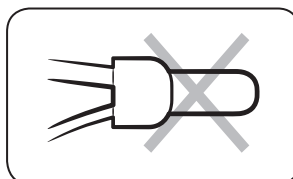
- In case of extending the electric wire, please DO NOT use a round-shaped pressing socket.
 - Incomplete wire connections can cause electric shock or a fire.



12-7 Pumping down for removing the product

- 1 Hold down the  (Power) button on the indoor unit for 5 seconds. Beep sounds immediately to indicate that the product is ready for pump down procedure.
- 2 Let the compressor run for more than 5 minutes.
- 3 Release the valve caps on High and Low pressure side.
- 4 Use L-wrench to close the valve on the high pressure side.
- 5 After approximately 1 minute, close the valve on the low pressure side.
- 6 Stop operation of the air conditioner by pressing the  (Power) button on the indoor unit or remote control.
- 7 Disconnect the pipes.



Remarks

Relocation of the air conditioner

- Refer to this procedure when the unit is relocated.
- Carry out the pump down procedure (refer to the details of 'pump down').
- Remove the power cord.
- Disconnect the assembly cable from the indoor and outdoor units.
- Remove the flare nut connecting the indoor unit and the pipe.
- At this time, cover the pipe of the indoor unit and the other pipe using a cap or vinyl plug to avoid foreign material entering.
- Disconnect the pipe connected to the outdoor unit.
At this time, cover the valve of the outdoor unit and the other pipe using a cap or vinyl plug to avoid foreign material entering.
- Make sure you do not bend the connection pipes in the middle and store together with the cables.
- Move the indoor and outdoor units to a new location.
- Remove the mounting plate for the indoor unit and move it to a new location.

12-7. Reference Sheet

Index for Model Name

Model Code

1st	2nd	3rd	4th	5th	6th	7th	8th	9th	10th	11th	12th	13th	14th
Project		Capacity		Sell	Feature		Series		Color		Unit	Export	
A	R	1	8	N	X	W	X	C	W	K	N/X	E	U

ITEM	1ST	2ND
RAC	A	R
FAC	A	F
WAC	A	W

Item	Reference	3TH	4TH
1	Export	1	0
2	Export	1	3
3	Export	1	8
4	Export	2	4
5	Export	3	0

Item	5TH
12Year	E
13Year	F
14Year	H
15Year	J
16Year	K
17Year	M
18Year	N

Item	6TH
INVERTER H/P	X
INVERTER C/O	Y

Item1	Item2	7TH
Export	The virus doctor (The India / Latin America A / PAC K besides)	S
Export	NO virus doctor (the India / Latin America A / PAC K besides)	F

Special instructions:
About AR**FSSSCUR/SA ,the 7TH is "S", but there is no virus doctor in these models.

9TH DIGIT		
Export	1st MODEL	A
Export	2nd	B
Export	3rd MODEL	C
Export	4th MODEL	D
Export	12thMODEL	L

Item 1	Item 2	Item 3	Item 4	8TH
Export	RAC	FMC FLG (Best)	1ST MODEL	F
Export	RAC	FMC DLX (Better)	1ST MODEL	D
Export	RAC	FMC STD (Good1)	1ST MODEL	S
Export	RAC	MC ENT (Good2)	1ST MODEL	N
Export	RAC	WIND-FREE	1ST MODEL	X

Division	Series	Project	Color Name	Division component	Sinkeolreo code (10TH,11TH)	Remark
A3050	F	Best	Twilight	Grille	WK	
	F	Best	TBD	Grille	TBD	
	D	Better	Twilight	Grille	WK	
	D	Better	TBD	Grille	TBD	
	S	Good1	Twilight	Grille	WK	Deco : Transparency
	S	Good1	Midnight Blue	Deco	UR	Grille : Twilight
	N	Good2	Twilight	Grille	WK	
	N	Good2	TBD	Grille	TBD	Grille : Metallic Gray

Item1	Item2	12TH
Export	SET	/
Export	IN	N
Export	OUT	X

Item	The existing code	The sales area	CIS Description	The integrated code (13TH,14TH)
1	EU	UNITED KINGDOM	XEU	EU

SAMSUNG

ELECTRONICS

GSPN (GLOBAL SERVICE PARTNER NETWORK)

Area	Web Site
North America	http://gspn3.samsungcsportal.com
Latin America	http://gspn3.samsungcsportal.com
CIS	http://gspn1.samsungcsportal.com
Europe	http://gspn1.samsungcsportal.com
China	http://china.samsungportal.com
Asia	http://gspn2.samsungcsportal.com
Middleeast & Africa	http://gspn1.samsungcsportal.com

This Service Manual is a property of Samsung Electronics Co., Ltd.
Any unauthorized use of Manual can be punished under applicable
International and/or domestic law.

© Samsung Electronics Co., Ltd. November 2017
Code No. AC-00045K_1