

TOSHIBA

Leading Innovation >>>

AIR CONDITIONER (SPLIT TYPE) Owner's Manual



1111056502-1

Indoor Unit

Model name:

High Wall Type

RAV-SM307KRTP-E
RAV-SM407KRTP-E

For commercial use



English

Original instruction

ADOPTION OF NEW REFRIGERANT

This Air Conditioner uses R410A an environmentally friendly refrigerant.

According to IEC 60335-1

This appliance is not intended for use by persons (including children) with reduced physical, sensory or mental capabilities, or lack of experience and knowledge, unless they have been given supervision or instruction concerning use of the appliance by a person responsible for their safety.

Children should be supervised to ensure that they do not play with the appliance.

According to EN 60335-1

This appliance can be used by children aged from 8 years and above and persons with reduced physical, sensory or mental capabilities or lack of experience and knowledge if they have been given supervision or instruction concerning use of the appliance in a safe way and understand the hazards involved. Children shall not play with the appliance. Cleaning and user maintenance shall not be made by children without supervision.

Contents

1	Precautions for safety	3
2	Accessory parts	5
3	Parts name	5
4	Wireless remote controller	6
4-1.	Parts name of remote controller	6
4-2.	Adjusting clock	8
4-3.	Handling the remote controller	8
4-4.	How to use remote controller	9
5	Wired remote controller	12
5-1.	Correct usage	14
5-2.	Timer operation	15
5-3.	Power saving mode	15
5-4.	Self clean operation mode	16
6	Limited operation by twin and group combination	16
7	Auto restart operation	17
8	How the air conditioner works	17
9	Hints for economical operation	18
10	TEMPORARY operation	18
11	Maintenance	18
12	Troubleshooting	20
13	Operations and performance	21
14	Installation	22
15	Specifications	22

Thank you for purchasing this Toshiba air conditioner.
 Please read carefully through these instructions that contain important information which complies with the "Machinery" Directive (Directive 2006 / 42 / EC), and ensure that you understand them.
 After reading these instructions, be sure to keep them in a safe place together with the Installation Manual supplied with your product.





Generic Denomination: Air Conditioner

Definition of Qualified Installer or Qualified Service Person

The air conditioner must be installed, maintained, repaired and removed by a qualified installer or qualified service person. When any of these jobs is to be done, ask a qualified installer or qualified service person to do them for you. A qualified installer or qualified service person is an agent who has the qualifications and knowledge described in the table below.

Agent	Qualifications and knowledge which the agent must have
Qualified installer	<ul style="list-style-type: none"> The qualified installer is a person who installs, maintains, relocates and removes the air conditioners made by Toshiba Carrier Corporation. He or she has been trained to install, maintain, relocate and remove the air conditioners made by Toshiba Carrier Corporation or, alternatively, he or she has been instructed in such operations by an individual or individuals who have been trained and is thus thoroughly acquainted with the knowledge related to these operations. The qualified installer who is allowed to do the electrical work involved in installation, relocation and removal has the qualifications pertaining to this electrical work as stipulated by the local laws and regulations, and he or she is a person who has been trained in matters relating to electrical work on the air conditioners made by Toshiba Carrier Corporation or, alternatively, he or she has been instructed in such matters by an individual or individuals who have been trained and is thus thoroughly acquainted with the knowledge related to this work. The qualified installer who is allowed to do the refrigerant handling and piping work involved in installation, relocation and removal has the qualifications pertaining to this refrigerant handling and piping work as stipulated by the local laws and regulations, and he or she is a person who has been trained in matters relating to refrigerant handling and piping work on the air conditioners made by Toshiba Carrier Corporation or, alternatively, he or she has been instructed in such matters by an individual or individuals who have been trained and is thus thoroughly acquainted with the knowledge related to this work. The qualified installer who is allowed to work at heights has been trained in matters relating to working at heights with the air conditioners made by Toshiba Carrier Corporation or, alternatively, he or she has been instructed in such matters by an individual or individuals who have been trained and is thus thoroughly acquainted with the knowledge related to this work.
Qualified service person	<ul style="list-style-type: none"> The qualified service person is a person who installs, repairs, maintains, relocates and removes the air conditioners made by Toshiba Carrier Corporation. He or she has been trained to install, repair, maintain, relocate and remove the air conditioners made by Toshiba Carrier Corporation or, alternatively, he or she has been instructed in such operations by an individual or individuals who have been trained and is thus thoroughly acquainted with the knowledge related to these operations. The qualified service person who is allowed to do the electrical work involved in installation, repair, relocation and removal has the qualifications pertaining to this electrical work as stipulated by the local laws and regulations, and he or she is a person who has been trained in matters relating to electrical work on the air conditioners made by Toshiba Carrier Corporation or, alternatively, he or she has been instructed in such matters by an individual or individuals who have been trained and is thus thoroughly acquainted with the knowledge related to this work. The qualified service person who is allowed to do the refrigerant handling and piping work involved in installation, repair, relocation and removal has the qualifications pertaining to this refrigerant handling and piping work as stipulated by the local laws and regulations, and he or she is a person who has been trained in matters relating to refrigerant handling and piping work on the air conditioners made by Toshiba Carrier Corporation or, alternatively, he or she has been instructed in such matters by an individual or individuals who have been trained and is thus thoroughly acquainted with the knowledge related to this work. The qualified service person who is allowed to work at heights has been trained in matters relating to working at heights with the air conditioners made by Toshiba Carrier Corporation or, alternatively, he or she has been instructed in such matters by an individual or individuals who have been trained and is thus thoroughly acquainted with the knowledge related to this work.

Warning indications on the air conditioner unit

Warning indication	Description		
 <table border="1"> <tr> <td>WARNING</td> </tr> <tr> <td>ELECTRICAL SHOCK HAZARD Disconnect all remote electric power supplies before servicing.</td> </tr> </table>	WARNING	ELECTRICAL SHOCK HAZARD Disconnect all remote electric power supplies before servicing.	WARNING ELECTRICAL SHOCK HAZARD Disconnect all remote electric power supplies before servicing.
WARNING			
ELECTRICAL SHOCK HAZARD Disconnect all remote electric power supplies before servicing.			
 <table border="1"> <tr> <td>WARNING</td> </tr> <tr> <td>Moving parts. Do not operate unit with grille removed. Stop the unit before the servicing.</td> </tr> </table>	WARNING	Moving parts. Do not operate unit with grille removed. Stop the unit before the servicing.	WARNING WARNING Moving parts. Do not operate unit with grille removed. Stop the unit before the servicing.
WARNING			
Moving parts. Do not operate unit with grille removed. Stop the unit before the servicing.			
 <table border="1"> <tr> <td>CAUTION</td> </tr> <tr> <td>High temperature parts. You might get burned when removing this panel.</td> </tr> </table>	CAUTION	High temperature parts. You might get burned when removing this panel.	CAUTION CAUTION High temperature parts. You might get burned when removing this panel.
CAUTION			
High temperature parts. You might get burned when removing this panel.			
 <table border="1"> <tr> <td>CAUTION</td> </tr> <tr> <td>Do not touch the aluminum fins of the unit. Doing so may result in injury.</td> </tr> </table>	CAUTION	Do not touch the aluminum fins of the unit. Doing so may result in injury.	CAUTION CAUTION Do not touch the aluminum fins of the unit. Doing so may result in injury.
CAUTION			
Do not touch the aluminum fins of the unit. Doing so may result in injury.			
 <table border="1"> <tr> <td>CAUTION</td> </tr> <tr> <td>BURST HAZARD Open the service valves before the operation, otherwise there might be the burst.</td> </tr> </table>	CAUTION	BURST HAZARD Open the service valves before the operation, otherwise there might be the burst.	CAUTION CAUTION BURST HAZARD Open the service valves before the operation, otherwise there might be the burst.
CAUTION			
BURST HAZARD Open the service valves before the operation, otherwise there might be the burst.			

1 Precautions for safety

The manufacturer shall not assume any liability for the damage caused by not observing the description of this manual.

WARNING

General

- Carefully read Owner's Manual before starting the air conditioner. There are many important things to keep in mind for daily operation.
- Ask for installation to be performed by the dealer or a professional. Only a qualified installer(*1) is able to install an air conditioner. If a non-qualified person installs an air conditioner, it may result in problems such as fire, electric shock, injury, water leakage, noise and vibration.
- Do not use any refrigerant different from the one specified for complement or replacement. Otherwise, abnormally high pressure may be generated in the refrigeration cycle, which may result in a failure or explosion of the product or an injury to your body.
- Places where the operation sound of the outdoor unit may cause a disturbance. (Especially at the boundary line with a neighbour, install the air conditioner while considering the noise.)

Transportation and storage

- To transport the air conditioner, wear shoes with protective toe caps, protective gloves, and other protective clothing.
- To transport the air conditioner, do not take hold of the bands around the packing carton. You may injure yourself if the bands should break.
- Before stacking the packing cartons for storage or transportation, heed the precautions written on the packing cartons. Failure to heed the precautions may cause the stack to collapse.
- The air conditioner must be transported in stable condition. If any part of the product broken, contact your dealer.
- When the air conditioner must be transported by hand, carry it by two or more people.

Installation

- Only a qualified installer(*1) or qualified service person(*1) is allowed to carry out the electrical work of the air conditioner. Under no circumstances must this work be done by an unqualified individual since failure to carry out the work properly may result in electric shocks and/or electrical leaks.
- After the installation work has been completed, have the installer explain about the circuit breaker positions. In the event that trouble has occurred in the air conditioner, set the circuit breaker to the OFF position, and contact a qualified service person(*1).
- If the unit is installed in a small room, take appropriate measures to prevent the refrigerant from exceeding the limit concentration even if it leaks. Consult the dealer from whom you purchased the air conditioner when you implement the measures. Accumulation of highly concentrated refrigerant may cause an oxygen deficiency accident.
- Do not install the air conditioner in a location that may be subject to a risk of exposure to a combustible gas. If a combustible gas leaks and becomes concentrated around the unit, a fire may occur.
- Use the company-specified products for the separately purchased parts. Use of non-specified products may result in fire, electric shock, water leakage or other trouble. Have the installation performed by a professional.
- Confirm that earthing is performed correctly.

Operation

- Before opening the front panel of the indoor unit or service panel of the outdoor unit, set the circuit breaker to the OFF position. Failure to set the circuit breaker to the OFF position may result in electric shocks through contact with the interior parts. Only a qualified installer(*1) or qualified service person(*1) is allowed to remove the front panel of the indoor unit or service panel of the outdoor unit and do the work required.
- Inside the air conditioner are high-voltage areas and rotating parts. Due to the danger of electric shocks or of your fingers or physical objects becoming trapped in the rotating parts, do not remove the front panel of the indoor unit or service panel of the outdoor unit. When work involving the removal of these parts is required, contact a qualified installer(*1) or a qualified service person(*1).
- Do not move or repair any unit by yourself. Since there is high voltage inside the unit, you may get electric shock when the cover and main unit is removed.
- Use of a stand more than 50 cm high to clean the filter of the indoor unit or to carry out other such jobs constitutes working at heights. Due to the danger of falling off the stand and injuring yourself while working at heights, this kind of work should not be done by unqualified individuals. When this kind of work must be carried out, do not do it yourself but ask a qualified installer(*1) or a qualified service person(*1) to do it for you.
- Do not touch the aluminum fin of the outdoor unit. You may injure yourself if you do so. If the fin must be touched, do not touch it yourself but contact a qualified installer(*1) or a qualified service person(*1).
- Do not climb onto or place objects on top of the outdoor unit. You may fall or the objects may fall off of the outdoor unit and result in injury.
- Do not place any combustion appliance in a place where it is directly exposed to the wind of air conditioner, otherwise it may cause imperfect combustion.
- When the air conditioner is operated with a combustion appliance in the same place, ventilate the room sufficiently. Poor ventilation causes oxygen shortage.
- When the air conditioner is used in a closed room, sufficiently ventilate the room. Poor ventilation causes oxygen shortage.
- Do not expose your body to cool air directly for a long time and do not cool yourself excessively. Doing so may result in deteriorated physical condition and ill health.
- Do not insert your finger or a stick into the air intake or discharge. Doing so may result in injury as the fan is rotating at high speed inside the unit.
- Consult the shop where you purchased the air conditioner if air conditioning (cooling and heating) is not performed properly as a refrigerant leakage may be the cause. Confirm the repair details with a qualified service person(*1) when the repair includes additional charging of the refrigerant.
- Stop running the air conditioner and turn off the breaker before cleaning. Otherwise, injury may result as the fan is rotating at high speed inside the unit.

Repairs

- If there is any kind of trouble (such as when an error display has appeared, there is a smell of burning, abnormal sounds are heard, the air conditioner fails to cool or heat or water is leaking) has occurred in the air conditioner, do not touch the air conditioner yourself but set the circuit breaker to the OFF position, and contact a qualified service person(*1). Take steps to ensure that the power will not be turned on (by marking "out of service" near the circuit breaker, for instance) until qualified service person(*1) arrives. Continuing to use the air conditioner in the trouble status may cause mechanical problems to escalate or result in electric shocks or other trouble.
- If the fan grille is damaged, do not approach the outdoor unit but set the circuit breaker to the OFF position, and contact a qualified service person(*1) to have the repairs done. Do not set the circuit breaker to the ON position until the repairs are completed.
- If there is a danger of the indoor unit's falling, do not approach the indoor unit but set the circuit breaker to the OFF position, and contact a qualified installer(*1) or a qualified service person(*1) to refit the unit. Do not set the circuit breaker to the ON position until the unit has been refitted.
- If there is a danger of the outdoor unit's toppling over, do not approach the outdoor unit but set the circuit breaker to the OFF position, and contact a qualified installer(*1) or a qualified service person(*1) to have the improvements or refitting done. Do not set the circuit breaker to the ON position until the improvements or refitting is completed.
- Do not customize the unit. Doing so may result in fire, electric shock or other trouble.

Relocation

- When the air conditioner is to be relocated, do not relocate it yourself but contact a qualified installer(*1) or a qualified service person(*1). Failure to relocate the air conditioner properly may result in electric shocks and/or a fire.

⚠ CAUTION

To disconnect the appliance from the mains supply.

- This appliance must be connected to the mains by means of a switch with a contact separation of at least 3 mm.

The installation fuse (all types can be sued) must be used for the power supply line of this air conditioner.

Installation

- Certainly lay the drain hose for perfect draining. Bad drainage may cause flooding in the house and getting furniture wet.
- Connect the air conditioner to an exclusive power supply of the rated voltage, otherwise the unit may break down or cause a fire.
- Confirm that the outdoor unit are fixed on the base. Otherwise, falling down of the units or other accidents may occur.









Operation

- Do not use this air conditioner for special purpose such as preserving food, precision instruments, art objects, breeding animals, car, vessel.
- Do not touch any switches with wet finger, otherwise you may get an electric shock.
- If the air conditioner will not be used for a considerably long time, turn off the main switch or the circuit breaker, for safety.
- To make the air conditioner operate in its original performance, operate it within the range of the operating temperature specified in the instructions. Otherwise it may cause a malfunction, or water leak from the unit.
- Prevent any liquid from falling into the remote controller. Do not spill juice, water or any kind of liquid.
- Do not wash the air conditioner. Doing so may result in electric shock.
- Check whether the installation base and other equipment have become deteriorated after being used for a long time. Leaving them such condition may result in the unit's falling down and causing injury.
- Do not leave flammable sprays or other flammable materials near the air conditioner, and do not spray flammable aerosol directly to the air conditioner. They may catch fire.
- Stop running the air conditioner and turn off the breaker before cleaning. Otherwise, injury may result as the fan is rotating at high speed inside the unit.
- Ask for cleaning of the air conditioner to be performed by the dealer. Cleaning the air conditioner in an improper manner may cause damage to plastic parts, insulation failure of electric parts and result in a malfunction. In the worst case, it may result in water leakage, electric shock, smoke emission and fire.
- Do not put a water container such as a vase on the unit. Water intrusion into the unit may occur and it may cause deterioration of electric insulation and result in electric shock.
- Do not wash air conditioners with pressure washers. Electric leakage may cause electric shocks or fires.

(*1) Refer to the "Definition of Qualified Installer or Qualified Service Person."

Information on the transportation, handling and storage of the carton

Examples of indication on the carton

Symbol	Description	Symbol	Description
	Keep dry		Do not drop
 FRAGILE	Fragile		Do not lay down
 11 cartons	Stacking height (12 cartons can be stacked in this case)		Do not walk on this carton
	This side up		Do not step
	Handle with care		

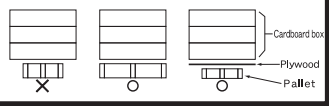
Other cautions	Description
 <p>Caution Injury possibility. Don't handle with packing band, or may get injured in case of broken band.</p>	<p>CAUTION Injury possibility. Don't handle with packing band, or may get injured in case of broken band.</p>
<p>Stacking notice.</p> <p>In case that cardboard boxes protrude out of pallet when stacking, lay a 10mm thick plywood over the pallet.</p> 	<p>Stacking notice. In case that cardboard boxes protrude out of pallet when stacking, lay a 10 mm thick plywood over the pallet.</p>

2 Accessory parts

Remote controller

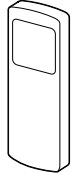

Remote controller holder



Batteries (two)



3 Parts name

Indoor unit

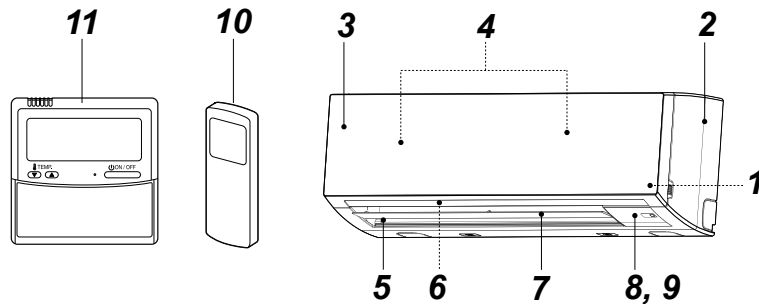

- | | |
|--|--|
| <p>1 Room temperature sensor</p> <p>2 Front panel</p> <p>3 Air intake grille</p> <p>4 Air filter</p> <p>5 Air discharge</p> | <p>6 Horizontal airflow louver</p> <p>7 Vertical airflow louver</p> <p>8 Display panel</p> <p>9 Infrared signal receiver</p> <p>10 Remote controller (wireless)</p> <p>11 Remote controller (wired, sold separately)</p> |
|--|--|

Names and functions of indicators and controls on indoor unit

Display panel

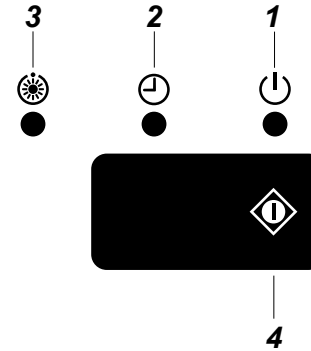

The operating conditions are indicated below.

- 1 OPERATION (Green)**
This lamp goes on during operation.
- 2 TIMER (Green)**
This lamp goes on while the timer reserved.

NOTE

In case of timer setting by wired remote controller, TIMER lamp does not light.
In case of group control, TIMER lamp goes on header unit only. (see "6 Limited operation by twin and group combination")

- 3 Preheat / Defrost (Orange)**
This lamp lights up when the power is turned on or right after heating operation starts or during defrost operation.

CAUTION

- **Disagreement in operation mode**
When the power is turned on for the first time after installation, the lamp lights up for approximately 5 minutes for setting of addresses of systems and units.
When the power is turned on the next time, the lamp lights up for approximately 1 minute.
While the above lamp is on, all the commands from the remote controller cannot be received. However, this is not a malfunction or failure.
- When local prohibition is set by the central control from other equipment, no signal is received even if the remote controller button is pressed. However, a signal of START/STOP button is accepted. (An alarm sound "pi" arises intermittently five times.)

4 TEMPORARY operation

- If you misplace or lose the wireless remote controller or its batteries are exhausted, push the button.
- See page 18.

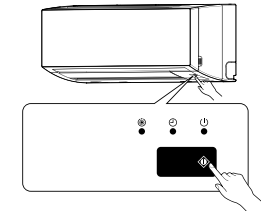

■ **Outdoor unit**
(The design varies depending on the outdoor unit. The following illustration shows an example.)

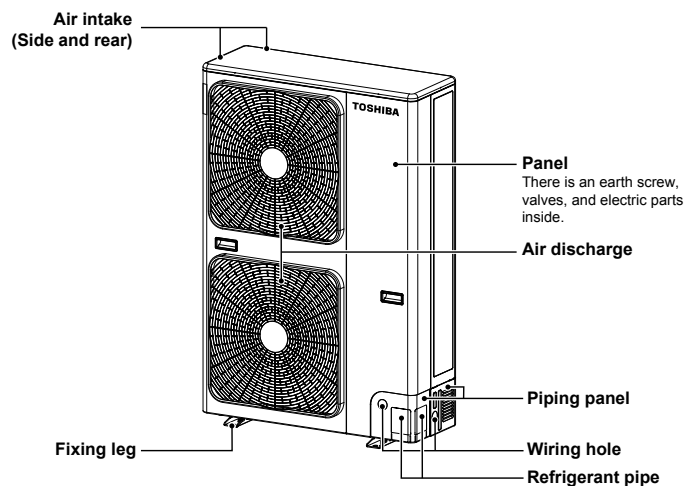

4 Wireless remote controller

4-1. Parts name of remote controller

■ Wireless remote controller and its functions

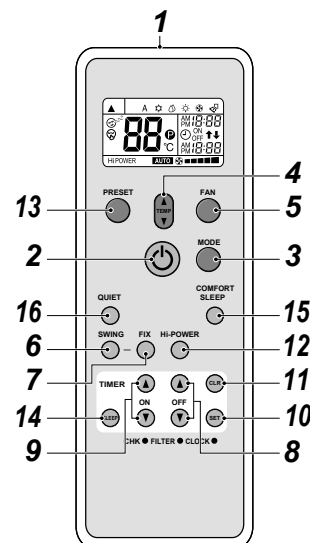

- 1 Infrared signal emitter**
Transmits a signal to the indoor unit.
- 2 START/STOP button**
Press the button to start operation.
(A receiving beep is heard.)
Press the button again to stop operation.
(A receiving beep is heard.)
If no receiving sound is heard from the indoor unit, press the button twice.
- 3 Mode select button (MODE)**
Press this button to select a mode.
Each time you press the button, a mode is selected in a sequence that goes from A : Auto changeover control, * : Cool, ∪ : Dry, ☀ : Heat, ⚙ : Fan only, and back to A. (A receiving beep is heard.)

- 4 Temperature button (⬆)**
⬆ The set temperature is increased up to 30 °C.
⬆ The set temperature is dropped down to 17 °C. (A receiving beep is heard.)

- 5 Fan speed button (FAN)**
Press this button to select fan speed. When you select AUTO, the fan speed is automatically adjusted according to the room temperature. You can also manually select the desired fan speed from among five settings.
(LOW ■, LOW* ■■, MED ■■■, MED* ■■■■, HIGH ■■■■■)
(A receiving beep is heard.)

- 6 Auto louver button (SWING)**
Press this button to swing the louver.
(A receiving beep is heard.)
Press the SWING button to stop the louver swinging.
(A receiving beep is heard.)

- 7 Set louver button (FIX)**
Press this button to adjust the airflow direction.
(A receiving beep is heard.) While this button is kept depressed, the receiving tone continuously sounds.

- 8 Off timer button (OFF)**
Press this button to set the OFF timer.

- 9 On timer button (ON)**
Press this button to set the ON timer.

- 10 Reserve button (SET)**
Press this button to reserve time settings.
(A receiving beep is heard.)

- 11 Cancel button (CLR)**
Press this button to cancel ON timer and OFF timer. (A receiving beep is heard.)

- 12 High power button (HI-POWER)**
Press this button to start the high power operation.
This function is not operated group control.

13 PRESET button

Press this button to change the operation mode to the preferred operation mode memorized previously. To memorize the operation mode, press this button for at least 3 seconds during the preferred operation mode.  is displayed and the operation mode is memorized.

14 SLEEP button

Press this button to start the OFF timer operation that automatically adjusts the room temperature and the fan speed. You can select the OFF timer time from four durations (1, 3, 5 or 9 hours).

15 COMFORT SLEEP button

Press this button to start the OFF timer operation that automatically adjusts the room temperature and the fan speed. You can select the OFF timer time from four durations (1, 3, 5 or 9 hours). During group control operation, the set temperature and the fan speed are not automatically adjusted. Only off timer function is activated.

16 QUIET button

Press this button to start quiet operation. Pressing this button again will restore normal operation.

Names and functions of indications on wireless remote controller

◆ Display

All indications, except for clock time indication, are indicated by pressing the START/STOP  button.

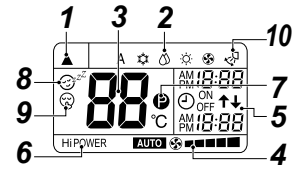





- In the illustration, all indications are indicated for explanation. During operation, only the relevant indications will be indicated on the remote controller.

1 Transmission mark

This transmission mark () indicates when the remote controller transmits signals to the indoor unit.







2 Mode display

Indicates the current operation mode. (A : Auto changeover control,  : Cool,  : Dry,  : Heat,  : Fan only)

3 Temperature display

Indicates the temperature setting (17 °C to 30 °C). When you set the operating mode to  : Fan only, no temperature setting is indicated.

4 FAN speed display

Indicates the selected fan speed. AUTO or one of five fan speed levels (LOW , LOW* , MED , MED* , HIGH ) can be indicated. Indicates **AUTO** when the operating mode is  : Dry.

5 TIMER and clock time display

The time set for timer operation or clock time is indicated. The present time is always indicated except for TIMER operation.

6 Hi POWER display

Indicates when the high power operation starts. Press the Hi-POWER button to start and press it again to stop the operation.

7 (PRESET) display

Indicated when memorizing the preferred operation mode or when it has been memorized. Also, this icon is indicated when the memorized preferred operation is displayed.

8 (COMFORT SLEEP) display

Indicated during the OFF timer operation that automatically adjusts the room temperature and the fan speed. Each time you press the COMFORT SLEEP button, the display changes in the sequence of 1h, 3h, 5h, and 9h.

9 (QUIET) display

Indicated during the quiet operation.

10 Swing display

Indicated during the swinging operation where the horizontal louver automatically moves up and down.

NOTE

When both wired remote controller and wireless remote controller are used, display on the screen of wireless remote controller may differ from the actual operation in some cases.

Preparation and check before use

◆ Loading batteries

1 Remove the battery cover.

2 Insert 2 new batteries (R03 [AAA]) following the (+) and (-) positions.

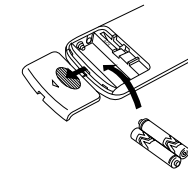

◆ Batteries

- To replace the batteries, use two new batteries (R03 [AAA]).
- In normal use, the batteries will last about one year.
- Replace the batteries if there is no receiving beep from the indoor unit or when the air conditioner cannot be operated using the remote controller.
- To avoid malfunctions by battery leakage, remove the batteries when not using the remote controller for more than one month.

4-2. Adjusting clock

◆ Setting the clock



Before you start operating the air conditioner, set the clock of the remote controller using the procedures given in this section. The clock panel on the remote controller will indicate the time regardless of whether the air conditioner is in use or not.

■ Initial setting

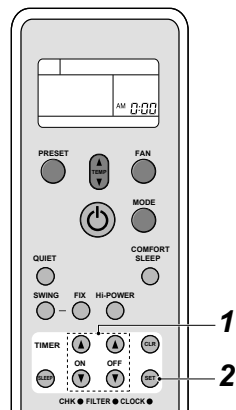
When batteries are inserted in the remote controller the clock panel will indicate AM 0:00 and will flash.



1 TIMER or button

Press the TIMER  or  button to set the current time.

Each press of the TIMER button changes the time in one minute steps.

Pressing the TIMER button continually changes the time in ten minute steps.

2 SET button

Press the SET  button.

The current time is indicated and the clock starts.

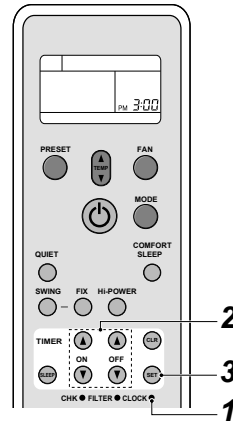

■ Clock adjusting



1 CLOCK button

Press the CLOCK  by tip of a pencil. The CLOCK display flashes.

2 TIMER or button

Press the TIMER  or  button to set the current time.

Each press of the TIMER button changes the time by one minute.

Pressing the TIMER button continually changes the time by ten minutes.

3 SET button

Press the SET  button.

The current time is indicated and the clock starts.

4-3. Handling the remote controller

⚠ CAUTION

- The air conditioner will not operate if curtains, doors or other materials block the signals from the remote controller to the indoor unit.
- Prevent any liquid from falling into the remote controller. Do not expose the remote controller to direct sunlight or heat.
- If the infrared signal receiver on the indoor unit is exposed to direct sunlight, the air conditioner may not function properly. Use curtains to prevent the sunlight from reaching the receiver.
- If the room using the air conditioner has fluorescent lighting with electronic starters, signals may not be properly received. If you are planning to use such fluorescent lamps, consult your local dealer.
- If other electrical appliances react to the remote controller move these appliances or consult your local dealer.

■ Location of the remote controller

- Keep the remote controller where its signals can reach the receiver of the indoor unit (a distance of 7 m is allowed).
- When you select the timer operation, the remote controller automatically transmits a signal to the indoor unit at the specified time. If you keep the remote controller in a position that hinders proper signal transmission, a time lag of up to 15 minutes may occur.

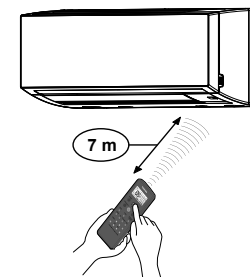

■ Remote controller holder

◆ Installing the remote controller holder

Before you actually install the remote controller holder on a wall or pillar, check whether the remote controller signals can be received by the indoor unit.

◆ Mounting and removing the remote controller

To mount the remote controller hold it parallel to the remote controller holder and push it in fully. To remove the remote controller slide the remote controller upwards and out from the holder.

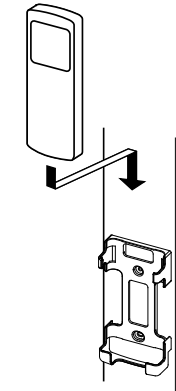

4-4. How to use remote controller

■ Cooling / heating / fan only operation

◆ Start

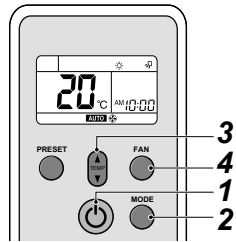

- 1 START/STOP button (⏻)**
Press this button to start the air conditioner.
- 2 Mode select button (MODE)**
Select Cool ❄️, Heat ☀️, or Fan only 🌀.
- 3 Temperature button (🌡️)**
Set the desired temperature.
When the air conditioner is in FAN ONLY operation, the temperature display is not indicated.
- 4 Fan speed button (FAN)**
Select one of **AUTO** ■, **LOW** ■■, **LOW*** ■■■, **MED** ■■■■, **MED*** ■■■■■, **HIGH** ■■■■■■.

- The (🟢) OPERATION lamp (green) on the display panel of the indoor unit goes on. And operation starts after approximately 3 minutes. (If you select FAN ONLY mode, the unit will start immediately.)
- The 🌀 : Fan only mode does not control temperature.
- Fan speed **AUTO** is the same as **HIGH** ■■■■■■. Therefore, perform only steps **1**, **2** and **4** to select this mode.

◆ Stop

START/STOP button (⏻)
Press this button again to stop the air conditioner.

■ Dry operation

◆ Start

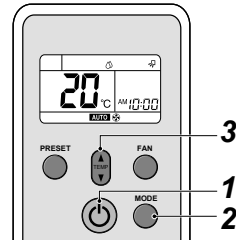

- 1 START/STOP button (⏻)**
Press this button to start the air conditioner.
- 2 Mode select button (MODE)**
Select DRY ☁️.
- 3 Temperature button (🌡️)**
Set the desired temperature.

- The fan speed display indicates **AUTO**
- The (🟢) OPERATION lamp (green) on the display panel of the indoor unit lights, and operation starts after approximately 3 minutes.

◆ Stop

START/STOP button (⏻)
Press this button again to stop the air conditioner.

■ Automatic operation (auto changeover)

◆ Start

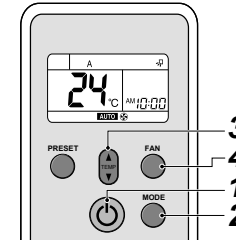

- 1 START/STOP button (⏻)**
Press this button to start the air conditioner.
- 2 Mode select button (MODE)**
Select A.
- 3 Temperature button (🌡️)**
Set the desired temperature.
- 4 Fan speed button (FAN)**
Select one of **AUTO** ■, **LOW** ■■, **LOW*** ■■■, **MED** ■■■■, **MED*** ■■■■■, **HIGH** ■■■■■■.

- The (🟢) OPERATION lamp (green) on the display panel of the indoor unit lights. The operating mode is selected in accordance with the room temperature and operation starts after approximately 3 minutes.
- If the "A" mode is uncomfortable, you can select the desired conditions manually.

◆ Stop

START/STOP button (⏻)
Press this button again to stop the air conditioner.

■ Timer operation

Use the wired remote controller for timer setting if it is also in use.

◆ ON timer and OFF timer

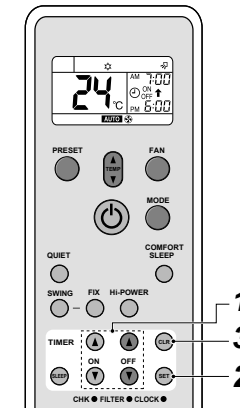

Setting TIMER

- 1 Push ON / OFF TIMER button (⏻ or ⏮) during operation.**
Press the ON or OFF TIMER buttons as required.
 - The previous timer setting is displayed and flashes along with ON / OFF timer display. Set the timer to the desired time. Each press of the TIMER button changes the time in ten minute steps. Pressing the TIMER button continually changes the time in one hour step.
- 2 SET (⏻) button**
Press the SET (⏻) button to set the timer. The timer time is indicated and the timer starts.

Cancelling TIMER

- 3 CLR (⏻) button**
Press the CLR (⏻) button to cancel the timer setting.

⚠ CAUTION

- When you select the timer operation, the remote controller automatically transmits the timer signal to the indoor unit at the specified time. Therefore, keep the remote controller in a location where it can transmit the signal to the indoor unit properly. Otherwise, the time lag of up to 15 minutes will occur.
- If you do not press the SET (SET) button within 30 seconds after setting the time, the setting will be cancelled.

Once you select the timer operation mode, the settings are saved in the remote controller. Thereafter, the air conditioner will start operating under the same conditions when you simply press the ON / OFF button of the remote controller.

If the clock display is flashing, you cannot set the timer. Follow the instructions in the section "Setting the clock" and then set the timer.

◆ Combined timer (Setting both ON and OFF timers simultaneously)

OFF timer → ON timer

(Operation → Stop → Operation)

This feature is useful when you want to stop the air conditioner after you go to sleep, and start it again in the morning when you wake up or you return home. Example:

To stop the air conditioner and start it again next morning.

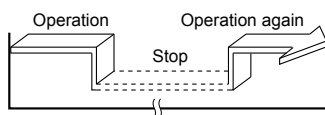

▼ Setting combined TIMER

- 1 Press the OFF TIMER (OFF) button to adjust the OFF timer.
- 2 Press the ON TIMER (ON) button to adjust the ON timer.
- 3 Press the SET (SET) button.

ON timer → OFF timer

(Stop → Operation → Stop)

You can use this setting to start the air conditioner when you wake up and stop it when you leave the house.

Example:

To start the air conditioner next morning and stop it.

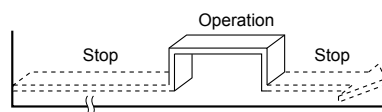

▼ Setting combined TIMER

- 1 Press the ON TIMER (ON) button to adjust the ON timer.
- 2 Press the OFF TIMER (OFF) button to adjust the OFF timer.
- 3 Press the SET (SET) button.

- Either ON or OFF timer function which is closer to the current time, is activated first.
- If the same time is set for both ON and OFF timers, no timer operation is performed. Also, the air conditioner may stop operating.

◆ Every day combined timer (setting both ON and OFF timer simultaneously and activate every day)

This feature is useful when you want to use combined timer at the same time every day.

▼ Setting combined TIMER

- 1 Press the ON TIMER (ON) button to adjust the ON timer.
- 2 Press the OFF TIMER (OFF) button to adjust the OFF timer.
- 3 Press the SET (SET) button.
- 4 After step 3, an arrow mark (↑ or ↓) flashes for about 3 seconds and during this flashing, press the SET (SET) button.

- During the every day timer is activating, both arrows (↑, ↓) are indicated.

◆ Cancel the timer operation

Press the CLR (CLR) button.

◆ Clock display

During the TIMER operation (ON-OFF, OFF-ON, OFF timer) clock display is disappeared so as to show the setting time. To see the present time, press SET button briefly and the present time is displayed about 3 seconds.

■ High power operation

◆ High power (Hi POWER)

The Hi POWER (high power operation) mode automatically controls room temperature, airflow and operation mode so that the room is quickly cooled in summer and warmed in winter.

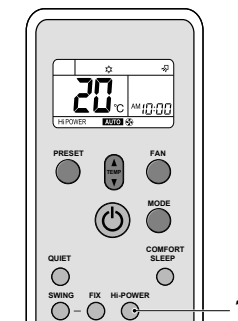

◆ Setting Hi POWER mode

1 Hi-POWER button

Press the Hi-POWER button after starting any operation. At the same time, the "Hi POWER" mark on the remote controller is indicated.

◆ Cancelling Hi POWER mode

1 Hi-POWER button

Press the Hi-POWER button once again. At the same time, the "Hi POWER" mark on the remote controller goes out.

⚠ CAUTION

- The Hi POWER mode cannot be activated in the DRY and FAN ONLY operation and when the ON TIMER operation is reserved.
- Hi POWER mode is not available for group control. When Hi POWER is transmitted to the Header indoor unit, the receiving sound is heard but the Hi POWER mode will not be performed. Please cancel the Hi POWER mode.

■ Quiet operation

The QUIET mode provides quiet operating status by automatically setting the fan speed to the lowest speed.

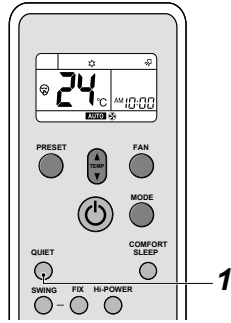

◆ Setting QUIET mode

1 QUIET button

Press the QUIET button after starting any operation. At the same time, the mark is indicated.

◆ Cancelling QUIET mode

1 QUIET button

Press the QUIET button once again.

At the same time, the mark on the remote controller disappears.

- When the QUIET mode is cancelled, the fan speed changes to AUTO. You can change it to your preferred speed.

⚠ CAUTION

The QUIET mode cannot be activated in the DRY operation.

NOTE

Under certain conditions, the quiet operation may not provide adequate cooling or heating due to the feature of quietness.

■ Preset operation

Set your preferred operation mode for future use. The setting is memorized by the unit for future operation (except airflow direction).

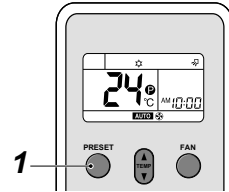

Select your preferred operation.

1 Press the PRESET button for 3 seconds to memorize the setting.

The mark is displayed.

When you press this button next time, the memorized operation mode will be enabled.

■ Comfort sleep operation

COMFORT SLEEP mode is a OFF timer operation with automatic temperature and fan speed adjustment.

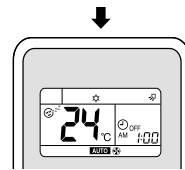
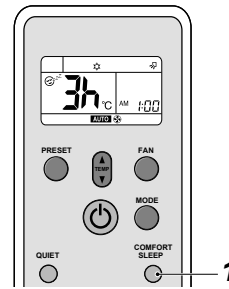

1 Press the COMFORT SLEEP button.

Select 1, 3, 5 or 9 hours for the OFF timer operation.

⚠ CAUTION

The COMFORT SLEEP mode is not enabled in the DRY or FAN ONLY operation.

NOTE

- For the cooling operation, the set temperature will automatically increase 1 degree / hour for 2 hours (maximum 2 degrees increase). For the heating operation, the set temperature will decrease.
- During group control operation, the set temperature and the fan speed are not automatically adjusted. Only off timer function is activated.

■ Sleep timer operation

To start the sleep timer (OFF timer) operation.

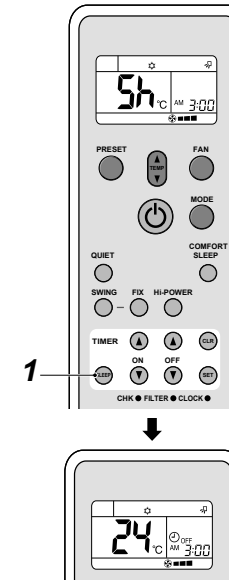

1 Press the SLEEP button.

Select 1, 3, 5 or 9 hours for the OFF timer operation.

■ Adjusting airflow direction

- Adjust the airflow direction properly. Otherwise, it might cause discomfort and make the room temperature uneven.
- Adjust the vertical airflow using the remote controller.
- Adjust the horizontal airflow manually.

◆ Adjust the vertical airflow

The air conditioner automatically adjusts the vertical airflow direction in accordance with the operating conditions when AUTO or A mode is selected.

To set the airflow direction you desire

Perform this function when the air conditioner is in operation.

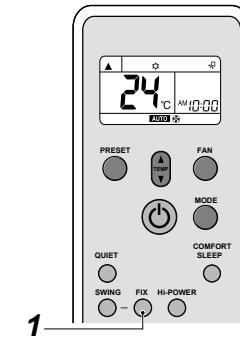
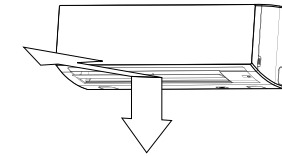

1 FIX button

Keep pressing or pressing briefly the FIX button on the remote controller to move the louver in the desired direction.

- In subsequent operations, the vertical airflow is automatically set in the direction to which you adjusted the louver using the FIX button.

NOTE

Operating angle of vertical airflow louver will be different during cooling, dry and heating operation.

To automatically swing the airflow direction

Perform this function when the air conditioner is in operation.

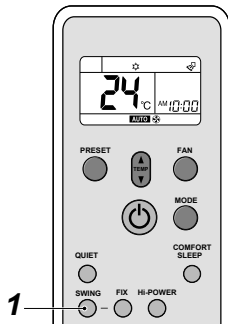
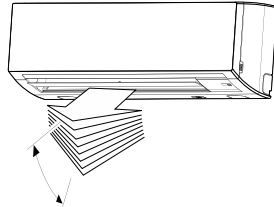

1 SWING button

Press the SWING button on the remote controller.

- To stop the function, press the SWING button.

CAUTION

- The FIX and SWING buttons will be disabled when the air conditioner is not in operation (including when the ON timer is set).
- Do not operate the air conditioner for long hours with the airflow direction set downward during the cooling or dry operation. Otherwise, condensation may occur on the surface of the vertical airflow louver and cause dew dripping.
- Do not move the vertical airflow louver manually. Always use the FIX button. If you move the louver manually, it may malfunction during operation. If the louver malfunctions, stop the air conditioner once, and restart.
- When the air conditioner is started immediately after it was stopped, the vertical airflow louver might not move for 10 seconds or so.
- Louver operation is limited when performing group control. (see page 16)

Adjust the horizontal airflow

Preparation

- Take hold of the lever on the horizontal airflow louver and move them to adjust the airflow direction as required.
- You can adjust the airflow at the left, and right locations of the louver.

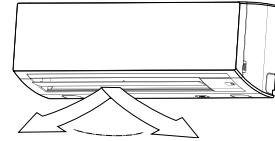

5 Wired remote controller

This remote controller can control the operation of up to 8 indoor units.

Display section

In the display illustration below all the icons are shown. When the unit is in operation, only relevant icons will be displayed.

- When the leak breaker is turned on at the first time, **SETTING** flashes on the display part of the remote controller.
- While this icon is flashing, the model is being automatically confirmed. Wait till **SETTING** icon has disappeared to use the remote controller.

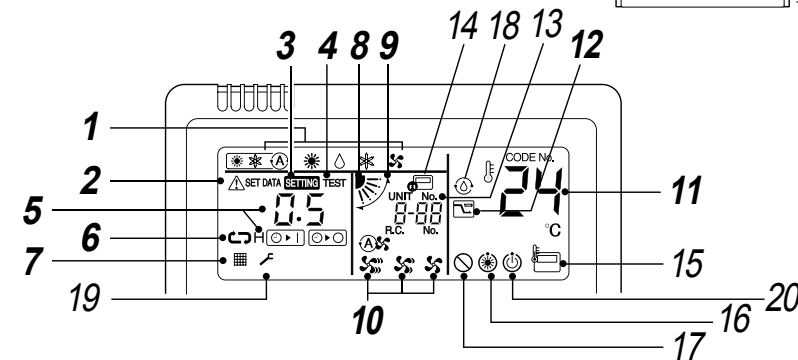
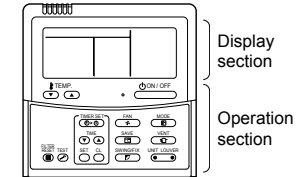

1 Operation mode

The selected operation mode is displayed.

2 Error display

Displayed while the protective device works or a error occurs.

3 SETTING display

Displayed during setup of the timer or other settings.

4 TEST run display

Displayed during a test run.

5 Timer display

When an error occurs, error code is displayed.

6 Timer mode display

The selected timer mode is displayed.

7 Filter display

Reminder to clean the air filter.

8 Louver position display

Displays louver position.

9 SWING display

Displayed during up / down movement of the louver.

10 Fan speed display

The selected fan speed mode is displayed.

(AUTO)	
(HIGH)	
(MED.)	
(LOW)	

11 Set temperature display

The selected set temperature is displayed.

12 Power saving mode display

Limits compressor speed (capacity) to save energy.

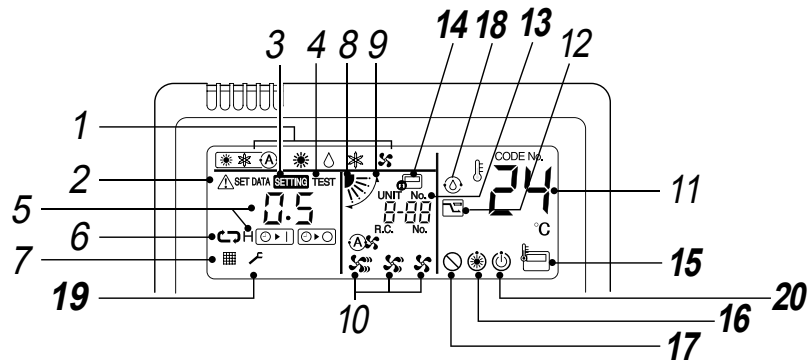

13 UNIT No. display

Displays the number of the indoor unit selected. Also displays error code of indoor and outdoor units.

14 Central control display

Displayed when the air conditioner is used under the central control in combination with a central control remote controller.

In case the remote controller is disabled by the central control system, flashes. The button operation is not accepted.

Even when ON / OFF, MODE, or TEMP. button is pushed, and the button operation is not accepted. (Settings made by the remote controller vary with the central control mode. For details, refer to the Owner's Manual of the central control remote controller.)

15 Remote controller sensor display

Displayed while the sensor of the remote controller is used.

16 Pre-heat display

Displayed when the heating mode is energized or defrost cycle is initiated. While this icon is displayed, the indoor fan stops.

17 No function display

Displayed when the function requested is not available on that model.

18 Self clean operation display

Displayed during self clean operation.

19 Service display

20 Operation ready display

This display appears on some models.

■ Operation section

Push each button to select a desired operation.

- The control saves commands in memory and after the initial setting, there is no need for any additional settings unless changes are desired. The air conditioner can be operated by pushing the button.

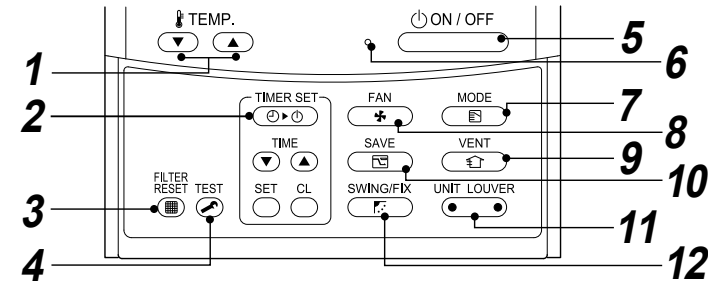

1 button (Temperature set button)

Adjusts the set point. Select the desired set point by pushing TEMP. or TEMP. .

2 button (Timer set button)

Use to setup the timer.

3 button (Filter reset button)

Resets " " display after cleaning filter.

4 button (Test button)

Use only for service. (During normal operation, do not use this button.)

5 button

When the button is pushed, the operation starts, and it stops by pushing the button again. When the operation has stopped, the operation lamp and all the displays disappear.

6 Operation lamp

Green light illuminates when unit is on. Although it flashes when the protection device is operated or an error occurs.

7 button (Operation mode button)

Selects desired operation mode.

8 button (Fan speed button)

Selects the desired Fan speed.

9 button (Ventilation button)

Use when a power ventilation kit (locally procured) is connected.

- If " " is displayed on the remote controller when this button is pushed, no vent kit connected.

10 button (Power save operation)

Use to initiate power saving mode.

11 button (Unit / Louver select button)

Selects a unit number (left) and louver number (right).

UNIT:

Selects an indoor unit when multiple indoor units are controlled with one remote controller.

LOUVER:

Selects a louver when setting louver lock or wind direction adjustment independently.

12 button (Swing / Louver direction button)

Selects automatic swing or setting the louver direction.

◆ OPTION:

Remote controller sensor

Usually the temperature sensor of the indoor unit senses the temperature. The temperature on the surrounding of the remote controller can also be sensed.

For details, contact the dealer from which you have purchased the air conditioner.

5-1. Correct usage

When the air conditioner is used for the first time or when the setting is changed, follow the steps below. Settings are saved in memory and are displayed anytime the unit is turned on by pushing the  button.

■ Preparation



- When the circuit breaker is turned on, the partition lines are displayed on the remote controller.
- * After the circuit breaker is turned on, the remote controller does not accept any commands for approx. 1 minute, this is not a failure.

REQUIREMENT

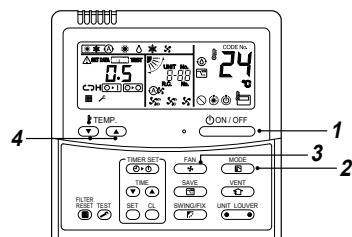



When the air conditioner is re-powered after it has not been used for a long period, turn on the circuit breaker at least 12 hours before starting the air conditioner.

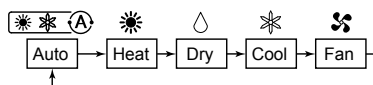

◆ Start

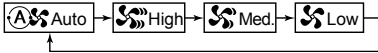
- 1 Push  button.**
The operation lamp illuminates, and the operation starts.
- 2 Select an operation mode with the “” button.**
One push of the button, and the display changes in the order shown below.



- 3 Select fan speed with “” button.**
One push of the button, and the display changes in the order shown below.
- 
- When fan is in “ AUTO”, fan speed is adjusted based on difference between set point and room temperature.
 - In heating operation, if the room temperature is not heated sufficiently with speed “ LOW” operation, select “ MED.” or “ HIGH” operation.

- The temperature sensor detects the return air temperature at the indoor unit, which differs from the room temperature depending on the installation condition.
Set point is a target of room temperature.
( “Auto” is not selectable in the Fan mode.)

- 4 Select the set point temperature by pushing the “TEMP. ” or “TEMP. ” buttons.**

◆ Stop

- 1 Push  button.**
The operation lamp goes off, and the operation stops.
In the COOL, DRY, or AUTO (cooling) mode, the fan runs for 10 minutes (or more) for dehydrating heat exchanger operation.

NOTE

Auto Changeover

- During Auto Mode, the unit selects the operating mode (cooling, heating or fan only) based on the user set point temperature.
- If the Auto mode is uncomfortable, the desired conditions can be selected manually.

Cooling

If there is a demand for cooling, unit will start approximately 1 minute after mode is selected.

Heating

- If there is a demand for heating, unit will start approximately 3 to 5 minutes after the mode is selected.
- After the heating operation has stopped, fan may continue to run for approx. 30 seconds.
- When the room temperature reaches the set temperature, the outdoor unit stops and the indoor unit fan runs at extremely low speed.
During defrost operation, the fan stops so that cool air is not discharged. (“” Pre-heat is displayed.)



When operation is restarted after stop

When the unit is restarted immediately after it was stopped, the unit can not start for approx. 3 minutes this is to protect the compressor.

■ 8 °C OPERATION (For object pre-heating) (The operation can be activated for SDI series 4 and DI series 4 only except connection with RAV-SM304AT or RAV-SM404AT)

The air conditioner can control the heating temperature to about 8 °C in the heating mode.
The 8 °C heating operation requires settings with the wired remote controller. Ask the installer or dealer for the settings according to the installation manual of the indoor unit.



Start

- 1 Set the displayed temperature to 18 °C in the heating mode by pushing TEMP.  button.**
- 2 Set the displayed temperature to 8 °C by pushing TEMP.  button for at least four seconds.**

Stop

- 1 Set the displayed temperature to 18 °C by pushing TEMP.  button.**
 - The air conditioner returns to the normal HEAT mode. Select a desired temperature and operation mode.

NOTE

- The discharged air temperature is lower than that in the normal heating operation.
- The room temperature may not be heated evenly depending on the remote controller installation location.
- The room temperature may not reach 8 °C depending on the room size or the installation conditions.
- Setting for fan speed is available during the 8 °C heating operation.
The 8 °C heating operation is cancelled in the following cases.
 - When operation is stopped with  button
 - When another operation mode is selected with  button
 - When temperature setting or operation mode is changed or operation is started / stopped by the wireless remote controller or the central control remote controller.
- When this operation mode is used, observe proper operating hours and we recommend that you ask service staff for periodic maintenance of the air conditioner.

5-2. Timer operation

Three timer modes are available: (Setting of up to 168 hours is enabled.)

- OFF timer : The unit stops when the set time is reached.
- Repeat OFF timer : The unit stops daily when the set time is reached.
- ON timer : The unit starts when the set time is reached.

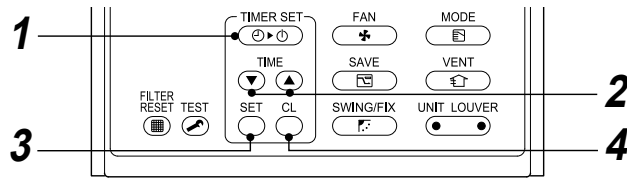

◆ Set

1 Push **TIMER SET** button.

The timer mode changes with every push of the button.

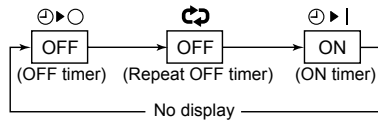

SETTING and timer display flashes.

2 Push **TIME** to select "set time".

- With every push of **TIME** button, the set time increases by 0.5 hr (30 minutes).
When a time more than 24 hours is set for timer operation, timer can be set in increments of 1 hr. The maximum set time is 168 hr (7 days). The remote controller displays the set time with time (between 0.5 and 23.5 hours) (*) or number of days and time (24 hours or more) (*) as shown below.
- With every push of **TIME** button, the set time decreases by 0.5 hr (30 minutes) (0.5 - 23.5 hours) or 1 hr (24 - 168 hours).

Example of remote controller display

- 23.5 hours (*)



- 34 hours (*)



Number of days Time

1d shows 1 day (24 hours).

10h shows 10 hours. (Total 34 hours)

3 Push **SET** button.

SETTING display disappears and time display goes on, and **ON** or **OFF** display flashes. (When ON timer is activated, time and ON timer **ON** are displays and other displays disappear.)

4 Cancel timer operation.

Push **UNIT LOUVER** button.
Timer display disappears.

NOTE

- When the operation stops after the timer reached the preset time, the Repeat OFF timer resumes the operation by pushing **ON/OFF** button and stops the operation after the time of the timer has reached the set time.
- When **UNIT LOUVER** is pushed while the OFF timer function of the air conditioner is active, the indication of the timer function disappears and then appears again after about 5 seconds. This is due to normal processing of the remote controller.

5-3. Power saving mode

The power saving mode saves energy by limiting the maximum current which will effect heating or cooling capacity that the unit can generate.

Push **SAVE** button during operation.

- The air conditioner enters power saving mode.
- **SAVE** appears on the display.

Power saving mode will stay in effect until it is cancelled.

To cancel the power saving mode, push **SAVE** button again.

- **SAVE** disappears.

■ To configure the power saving mode settings

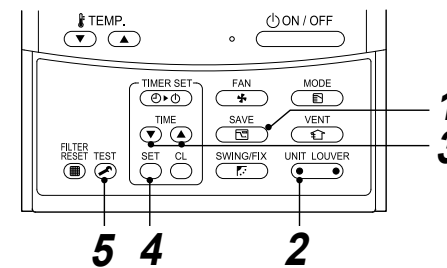

3 Push **TIME** buttons, to adjust the power saving mode setting.

- Each push of the button changes the power level by 1 % within the range from 100 % to 50 %.
- The factory default is 75 %.

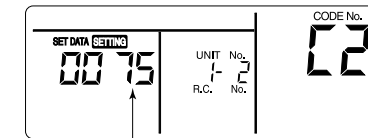

Setting of power level in power saving mode

1 Push **SAVE** button for at least four seconds when the air conditioner is not working.

SETTING symbol, and numbers flash.

2 Push **UNIT LOUVER** (left side of the button) to select an indoor unit to be set.

Each time the button is pushed, UNIT No. change as follows:



The fan of the selected unit runs.

4 Push **SET** button.

5 Push **TEST** button to complete the setting.

NOTE

- When other electric appliances are used at the same time, to avoid triggering the circuit breaker, power saving mode is recommended. Of course power saving mode can be used to save energy as well.
- Power saving mode consumes less energy, but may not heat / cool the room as much as normal mode. (The maximum current is limited to approximately 75 % (factory default) of the normal mode.)
- To adjust the power-save settings, see "To configure the power saving mode settings" in Power saving mode.
- Even when operation start / stop, operation mode change, or power reset is performed during the power saving mode, the power saving mode is retained until the next operation.

5-4. Self clean operation mode

This function is provided to dry the inside of the indoor unit by the FAN operation after running the cooling / dry / Auto (cooling) mode to keep the indoor unit clean.

- The self clean operation time varies with the cooling / dry / AUTO (cooling) operation time as follows.

Cooling / dry / AUTO (cooling) operation time	Self clean operation time
Less than 10 minutes	No self clean operation
10 minutes to less than 1 hour	1 hour
More than 1 hour	2 hours

- " " is displayed on the remote controller during self clean operation.

To stop self clean operation forcibly, push  button twice in succession.

CAUTION

- The fan continues to run even after  button is pushed to stop operation in some modes. This is normal because the self clean operation mode is in progress.
- The louvers open slightly and are directed horizontally during self clean operation, and they close when the self clean operation is completed.
- The operation lamp (LED) does not light during the self clean operation mode (function).
- The self clean operation mode (function) cannot clean the room or remove the already existing mold and dust inside the indoor unit.
- To cancel the self clean operation function, consult the dealer.

6 Limited operation by twin and group combination

NOTE

- Twin combination**
The combination where 2 indoor units are installed for 1 outdoor unit.
- Group combination**
Operate air conditioners in more than one system (such as single combination and twin combination) in same time.
- Header unit**
The representative unit during twin and group operation. Receive commands from remote controller and transmit the commands to follower units.
(The header unit is indoor unit that receives START / STOP signal from the wireless remote controller.)
- Follower unit**
Indoor units other than the header unit are called follower unit.

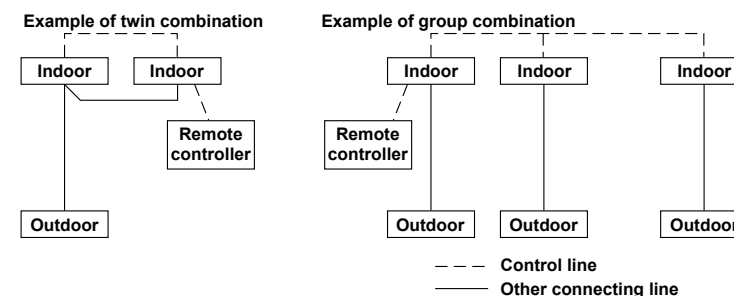

CAUTION

When using indoor unit in group control,

1. Hi POWER operation will not function.

When Hi POWER is transmitted from wireless remote controller the receiving sound will be heard from the indoor unit and display on the wireless remote controller will also change. However, the indoor unit does not operate Hi POWER operation. Restore the display on the wireless remote controller pushing Hi-POWER button.

2. COMFORT SLEEP

When COMFORT SLEEP is transmitted from wireless remote controller, the receiving sound will be heard from the indoor unit and the display on the wireless remote controller will also be changed as same as Hi POWER operation. However, the set temperature and the fan speed will not be automatically adjusted. Only off timer function is activated.

3. Units other than the Header unit cannot be operated with remote controller and the TEMPORARY operation.

When operating air conditioner with wireless remote controller transmission should be sent to the Header unit. Header and follower indoor units are decided through address setting upon installation. Follower unit will not receive any signals from wireless remote controller.

Air conditioner will not work even if the  button on the follower unit is pressed.

(Some Follower units may receive SWING and FIX, but these operations are performed only on the unit that received the signal.) (When wireless remote controller is used, only the Header unit receives SWING signal. If the SWING signal is transmitted to follower unit, the sound to refuse receiving signal (3 beeps) is heard and the follower unit does not receive the signal.)

For FIX operation, both Header and follower unit perform the operation by itself.

When wired remote controller is used, airflow direction can be changed on each unit by selecting the indoor unit.)

4. TIMER lamp lights up only on the Header unit.

When the timer is set with wired remote controller, even the TIMER lamp on the Header unit will not light up.

7 Auto restart operation

This air conditioner is equipped with an Automatic restarting facility which allows the air conditioner to resume the set operating conditions in the event of a supply power shutdown without the use of the remote controller.

The operation will resume without warning three minutes after the power is restored.

NOTE

The Auto Restart Operation is not set to work on shipment from the factory, and so it is necessary to set it to function as required.

◆ How to set the auto restart

To set the auto restart function, proceed as follows: The power supply to the unit must be on the function will not set if the power is off.

To enable the auto restart function, push the TEMPORARY button continually for more than 3 seconds, less than 10 seconds.

The air conditioner will acknowledge the setting and beep 2 times (first long, second short sound) and  lamp is flashing 5 seconds (5 Hz). The system will now restart automatically.

The above auto restart settings can be carried out:

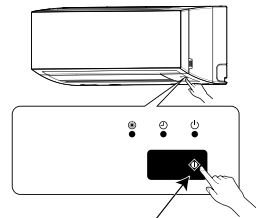

TEMPORARY button

◆ How to cancel the auto restart

To cancel the auto restart operation, proceed as follows:

Repeat the setting procedure: the air conditioner will acknowledge the instruction and beep 2 times (first long, second short sound).

The air conditioner will now require to be manually restarted with the remote controller after the main supply is turned off.

Cancellation is carried out:

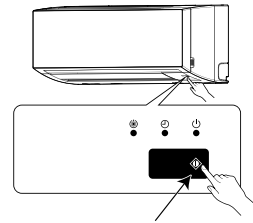

TEMPORARY button

8 How the air conditioner works

Automatic operation

- The air conditioner selects and operates in one of the operating modes of cooling, heating or fan only, depending on the room temperature and setting temperature.
- If the AUTO mode is uncomfortable, the desired conditions can be selected manually.

Hi POWER operation

When the Hi-POWER button is pushed during cooling, heating or AUTO operation, the air conditioner will start the following operation.

- Cooling operation
Performs the cooling operation at 1 °C lower than the setting temperature.
Only when the fan speed before the Hi POWER operation is not high, the fan speed will be increased.
- Heating operation
Performs the heating operation at 2 °C higher than the setting temperature.
Only when the fan speed before the Hi POWER operation is not high, the fan speed will be increased.

COMFORT SLEEP operation

When the COMFORT SLEEP button is pushed during cooling, heating, or AUTO operation, the air conditioner will start the OFF timer operation that automatically adjusts the room temperature and the fan speed (expect in DRY, FAN ONLY and TIMER mode).

You can select the OFF timer time from four durations (1, 3, 5 or 9 hours).

During group control operation, the set temperature and the fan speed are not automatically adjusted. Only off timer function is activated.

QUIET operation

When the QUIET button is pushed during cooling, heating, or AUTO operation, the air conditioner will start the following operation.

To operate super low fan speed for quiet operation (expect in DRY mode)

DRY operation

This operation is performed when the room temperature is higher than the set temperature.

The temperature is regulated while dehumidifying by repeated turning on and off of the cooling operation or fan only operation.

Increase of using wireless remote controller, the fan speed display will indicate AUTO and low speed will be used.

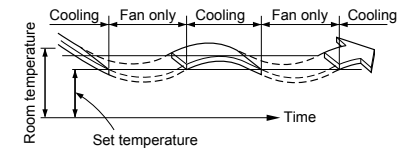

9 Hints for economical operation

■ Maintain room temperature at comfortable level

Clean air filters

The clogged air filters impairs the performance of the air conditioner.
Clean them once two weeks.

Do not open doors and windows more often than necessary

To keep cool or warm air in the room, do not open doors and windows more often than necessary.

Window curtains

In cooling, close the curtains to avoid direct sunlight.
In heating, close the curtains to keep the heat in.

Use the timer effectively

Set the timer for the desired operating time.

Get uniform circulation of room air

Adjust air flow direction for even circulation of room air.

10 TEMPORARY operation



In the following cases, the air conditioner can be operating without wireless remote controller with TEMPORARY operation button on the indoor unit.

- The battery in the wireless remote controller expired.
- A trouble occurred on the wireless remote controller.
- The wireless remote controller has been lost.

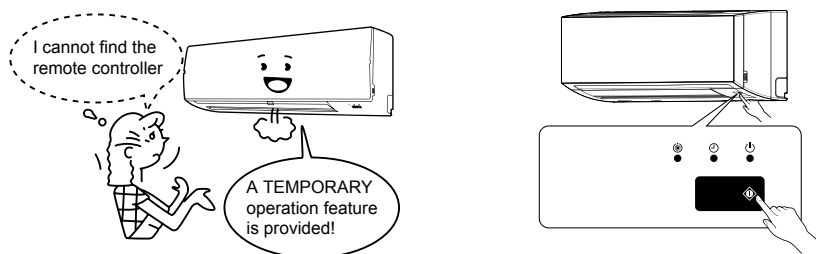
The operation mode is the one last selected. If you want to change it, turn the power off and then on, and push the TEMPORARY operation button again.



⚠ CAUTION

- If you cannot reach the  button by standing on a step-ladder which is lower than 50 cm, contact your dealer or qualified service person.
- Continuous pressing of the  button for 10 seconds and above will start the forced cooling operation. (This will impose burden on the air conditioner. Do not perform this for the purposes other than test run.) In this time all indicators of indoor unit go on.

11 Maintenance

⚠ WARNING

Before cleaning the air conditioner, to turn off the circuit breaker or main power switch.
After the cooling or dry auto (cooling) operation has finished, the self clean operation is performed and the fan starts running. Before cleaning the unit, stop the self clean operation forcibly and turn off the circuit breaker to avoid electric shock.
To clean the air filter and the air intake grille, do not remove them at the same time. You may touch the aluminum fin of the unit and result in injury.



Cleaning of indoor unit and remote controller

⚠ CAUTION

- Use a dry cloth to wipe the indoor unit and remote controller.
- A cloth dampened with cold water may be used on the indoor unit if it is very dirty.
- Do not use a damp cloth on the remote controller.
- Do not use a chemically-treated duster for wiping or leave such materials on the unit for long. It may damage or fade the surface of the unit.
- Do not use benzine, thinner, polishing powder, or similar solvents for cleaning.
These may cause the plastic surface to crack or deform.

Cleaning air filters

Clogged air filters will reduce the cooling and heating performance.

- 1 If  is displayed on the remote controller, clean the air filters.
- 2 When the cleaning of air filters has been completed, push  button.  disappears.

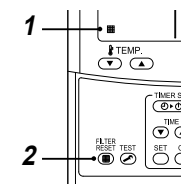

Check before operation

⚠ CAUTION

- Check that the air filters are installed.
- Check that the air discharge or intake of the outdoor unit is not blocked.

■ Cleaning the air filter

Clean the air filters every 2 weeks. If the air filters are covered with dust, the performance of the air conditioner will deteriorate.

Clean the air filters as often as possible.

- 1 Open the air intake grille.**
Lift the air intake grille up to the horizontal position.

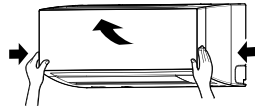

- 2 Take hold of the left and right handles of the air filter and lift it up slightly, then pull it downward to take it out from the filter holder.**

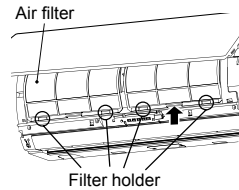

- 3 Use a vacuum cleaner to remove the dust from the filters or wash them with water.**
If you wash the air filters, dry them in the shade.

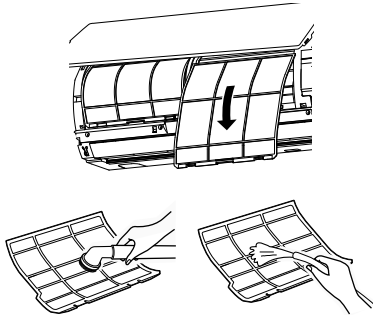

- 4 Insert the upper portion of air filter confirming to fit its right and left edges on the indoor unit until it is firmly set.**

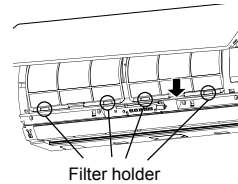
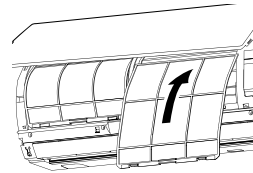

- 5 Close the air intake grille.**

■ Cleaning the air intake grille

- 1 Remove the air intake grille.**
Hold the two sides of the air intake grille and open upwards.



- 2 Wash it with water using a soft sponge or towel. (Do not use metallic scrubbing brush or other hard brushes.)**

- Use of such hard objects will cause scratches on the surface of the grille, and the metal coating to peel off.
- If very dirty, clean the air intake grille with a neutral detergent for kitchen use, and rinse it off with water.

- 3 Wipe out water from the air intake grille and dry it.**

- 4 Fit the left and right arms of the air intake grille to the shafts on the two sides of the air conditioner and push in completely.**

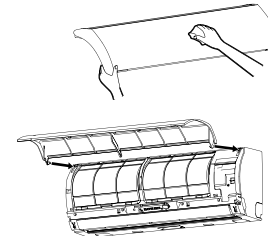

- 5 Check that the arm has been completely inserted and close the air intake grille.**
Push the arrow locations (four) at the bottom of the air intake grille to check whether the grille is completely closed.



◆ When not used for a long time

- 1 Perform the fan operation for a couple of hours to dry inside.**
- 2 Push  button on the remote controller to stop running, and turn off the circuit breaker.**
- 3 Clean the air filters and reinstall them.**

◆ Before the cooling season

Clean the drain pan
Contact the dealer where you purchased the product. (Drain does not work if the drain pan or vent is clogged.)

In some cases the drain may overflow and wet the wall or floor. Clean the drain pan before the cooling season.)

◆ Check periodically

- If the unit is used for a long time, parts may deteriorate and cause malfunction or bad drainage of dehumidified water depending on the heat, humidity, or dust.
- In addition to the usual maintenance, it is recommended that you have the unit checked and maintained by the dealer where you purchased it.

NOTE

For environmental conservation, it is strongly recommended that the indoor and outdoor units of the air conditioner in use be cleaned and maintained regularly to ensure efficient operation of the air conditioner.

When the air conditioner is operated for a long time, periodic maintenance (once a year) is recommended. Furthermore, regularly check the outdoor unit for rust and scratches, and remove them or apply rustproof treatment, if necessary.

As a general rule, when an indoor unit is operated for 8 hours or more daily, clean the indoor unit and outdoor unit at least once every 3 months. Ask a professional for this cleaning / maintenance work. Such maintenance can extend the life of the product though it involves the owner's expense.

Failure to clean the indoor and outdoor units regularly will result in poor performance, freezing, water leakage, and even compressor failure.

Maintenance List

Part	Unit	Check (visual / auditory)	Maintenance
Heat exchanger	Indoor / outdoor	Dust / dirt clogging, scratches	Wash the heat exchanger when it is clogged.
Fan motor	Indoor / outdoor	Sound	Take appropriate measures when abnormal sound is generated.
Filter	Indoor	Dust / dirt, breakage	<ul style="list-style-type: none"> Wash the filter with water when it is contaminated. Replace it when it is damaged.
Fan	Indoor	<ul style="list-style-type: none"> Vibration, balance Dust / dirt, appearance 	<ul style="list-style-type: none"> Replace the fan when vibration or balance is terrible. Brush or wash the fan when it is contaminated.
Air intake / discharge grilles	Indoor / outdoor	Dust / dirt, scratches	Fix or replace them when they are deformed or damaged.
Drain pan	Indoor	Dust / dirt clogging, drain contamination	Clean the drain pan and check the downward slope for smooth drainage.
Ornamental panel, louvers	Indoor	Dust / dirt, scratches	Wash them when they are contaminated or apply repair coating.
Exterior	Outdoor	<ul style="list-style-type: none"> Rust, peeling of insulator Peeling / lift of coat 	Apply repair coating.

12 Troubleshooting

Check the points described below before requesting repair.

		Symptom	Cause
It is not a malfunction.	Outdoor unit	• White, misty, cold air or water comes out	• The fan of the outdoor unit is automatically stopped and defrosting is performed.
		• Sometimes the noise of air leaking is heard.	• The solenoid valve works when defrosting starts or stops.
		• A noise is heard when the power is turned on.	• The outdoor unit is preparing for running.
	Indoor unit	• Sometimes a swishing is heard.	• When the unit starts running, during operation, or immediately after the unit stops running, a sound such as water flowing may be heard, or the operation sound may become louder for a couple of minutes immediately after the unit starts running. This is the sound of the refrigerant flowing or the dehumidifier draining.
		• A clacking sound is heard.	• This is a sound generated when the heat exchanger or other part expands and contracts slightly due to temperature change.
		• Discharged air smells unusual.	• Various smells from the walls, carpet, clothes, cigarette, cosmetics or other things adhere to the air conditioner.
• The fan continues running even after the unit operation is stopped.		• The fan keeps running to self clean the heat exchanger during drying.	
	• The unit does not run	<ul style="list-style-type: none"> Has a blackout occurred? Has the circuit breaker blown? Has the protective device been activated? (The operation indicator and ⏏ on the wired remote controller are blinking.) 	
Check again.	The room does not cool down or warm up.	<ul style="list-style-type: none"> Is the air intake or discharge of the outdoor unit clogged? Is a door or window open? Is the air filter clogged with dust? Is the air volume set to "LOW"? or is the operation mode set to "FAN"? Is the setup temperature appropriate? 	

If there is something unusual even after checking the above, stop running the unit, turn off the circuit breaker, and inform the dealer where you purchased the product of the product number and symptom. Do not attempt to repair the unit by yourself as doing so is dangerous. If the check indicator (E0 i, F0 i, H0 i) is displayed on the wired remote controller LCD, inform the dealer of its content as well.

If any of the following occur, stop running the unit immediately, turn off the circuit breaker, and contact the dealer where you purchased the product.

- The switch does not work properly.
- The circuit breaker often blows out.
- You unintentionally put a foreign object or water inside.
- The unit cannot be run even after the cause of the protective device activation is removed.
- Other unusual conditions are found.

Confirmation and check

When an error occurred in the air conditioner, an error code and indoor UNIT No. appear on the display part of the remote controller. The error code is only displayed during the operation. If the display disappears, operate the air conditioner according to the following "Confirmation of error log" for confirmation.

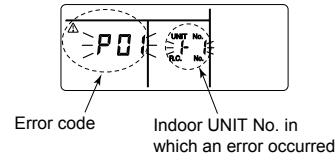

Confirmation of error log

When an error occurred on the air conditioner, the error log can be confirmed with the following procedure. (The error log is stored in memory up to 4 errors.) The log can be confirmed from both operating status and stop status.

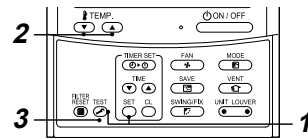

1 Push SET and TEST buttons simultaneously for 4 seconds or more, the following display appears.

- If Δ is displayed, the mode enters in the error log mode.
- [01: Order of error log] is displayed in CODE No..
 - [Error code] is displayed in CHECK.
 - [Indoor unit address in which an error occurred] is displayed in Unit No..

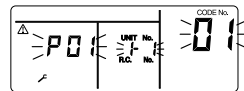

2 Every pushing of TEMP. button used to set temperature, the error log stored in memory is displayed in order. The numbers in CODE No. indicate CODE No. [01] (latest) → [04] (oldest).

REQUIREMENT

Do not push Δ button because all the error log of the indoor unit will be deleted.

3 After confirmation, push SET button to return to the usual display.

13 Operations and performance

Check before running

- Check whether the earth wire is cut or disconnected.
- Check whether the air filter is installed.
- Turn on the circuit breaker 12 hours or more before starting operation.

3 minutes protection function

3-minutes protection function prevents the air conditioner from starting for initial 3 minutes after the main power switch / circuit breaker is turned on for re-starting the air conditioner.

Power failure

Power failure during operation will stop the unit completely.

- To restart the operation, push the ON / OFF button on the remote controller.
- Lightning or a wireless car telephone operating nearby may cause the unit to malfunction. Turn off the main power switch or circuit breaker and then turn them on again. Push the ON / OFF button on the remote controller to restart.

Defrosting operation

If the outdoor unit is frosted during the heating operation, defrosting starts automatically (for approximately 2 to 10 minutes) to maintain the heating capacity.

- The fans in both indoor and outdoor units will stop during the defrosting operation.
- During the defrosting operation, the defrosted water will be drained from the bottom plate of the outdoor unit.

Heating capacity

In the heating operation, the heat is absorbed from the outside and brought into the room. This way of heating is called heat pump system. When the outside temperature is too low, it is recommended to use another heating apparatus in combination with the air conditioner.

Protective device

- Stops operation when the air-conditioner is overloaded.
- If the protective device is activated, the unit stops running, and the operation indicator and check indicator on the remote controller blink.

If the protective device is activated

- Turn off the circuit breaker and perform a checkup. Continued running may cause a malfunction.
- Check whether the air filter is installed. If not, the heat exchanger may be clogged with dust and water leakage may occur.

During cooling

- The air intake or discharge of the outdoor unit is clogged.
- Strong wind continuously blows against the discharge of the outdoor unit.

During heating

- The air filter is clogged with a large amount of dust.
- The air intake or discharge of the indoor unit is clogged.

Do not turn off the circuit breaker

- During the air-conditioning season, leave the circuit breaker turned on, and use the ON / OFF key on the remote controller.

Attention to snowfall and freeze on the outdoor unit

- In snowy areas, the air intake and air discharge of the outdoor unit are often covered with snow or frozen up. If snow or freeze on the outdoor unit is left as it is, it may cause machine failure or poor warming.
- In cold areas, pay attention to the drain hose so that it perfectly drains water without water remaining inside for freeze prevention. If water freezes in the drain hose or inside the outdoor unit, it may cause machine failure or poor warming.

▼ Air conditioner operating conditions

For proper performance, operate the air conditioner under the following temperature conditions:

Cooling operation	Outdoor temperature : -15 °C to 43 °C (Dry bulb temp.)
	Room temperature : 21 °C to 32 °C (Dry bulb temp.), 15 °C to 24 °C (Wet bulb temp.)
	[CAUTION] Room relative humidity – less than 80 %. If the air conditioner operates in excess of this figure, the surface of the air conditioner may cause dewing.
Heating operation	Outdoor temperature : -15 °C to 15 °C (Wet bulb temp.)
	Room temperature : 15 °C to 28 °C (Dry bulb temp.)

If air conditioner is used outside of the above conditions, safety protection may work.

14 Installation

◆ Do not install the air conditioner in the following places

- Do not install the air conditioner in any place within 1 m from a TV, stereo, or radio set. If the unit is installed in such place, noise transmitted from the air conditioner affects the operation of these appliances.
- Do not install the air conditioner near a high frequency appliance (such as sewing machine or massager for business use), otherwise the air conditioner may malfunction.
- Places where iron or other metal dust is present. If iron or other metal dust adheres to or collects on the interior of the air conditioner, it may spontaneously combust and start a fire.
- Do not install the air conditioner in a humid or oily place, or in a place where steam, soot, or corrosive gas is generated.
- Do not install the air conditioner in a salty place such as seaside area.
- Do not install the air conditioner in a place where a great deal of machine oil is used.
- Do not install the air conditioner in a place where it is usually exposed to strong wind such as in seaside area.
- Do not install the air conditioner in a place where sulfurous gas generated such as in a spa.
- Do not install the air conditioner in a vessel or mobile crane.
- Do not install the air conditioner in an acidic or alkaline atmosphere (in a hot-spring area or near a chemicals factory, or in a place subject to combustion emissions). Corrosion may be generated on the aluminum fin and copper pipe of the heat exchanger.
- Do not install the air conditioner near an obstacle (such as air vent, lighting equipment) that disturbs discharge air. (Turbulent airflow may reduce the performance or disable devices.)
- Do not use the air conditioner for special purposes such as preserving food, precision instruments, or art objects, or where breeding animals or growing plants are kept. (This may degrade the quality of preserved materials.)
- Do not install the air conditioner over an object that must not get wet. (Condensation may drop from the indoor unit at a humidity of 80 % or more or when the drain port is clogged.)
- Do not install the air conditioner in a place where an organic solvent is used.
- Do not install the air conditioner near a door or window subject to humid outside air. Condensation may form on the air conditioner.
- Do not install the air conditioner in a place where special spray is used frequently.

◆ Be careful with noise or vibrations

- Do not install the air conditioner in a place where noise by outdoor unit or hot air from its air discharge annoys your neighbours.
- Install the air conditioner on a solid and stable foundation so that it prevents transmission of resonating, operation noise and vibration.
- If one indoor unit is operating, some sound may be audible from other indoor units that are not operating.

15 Specifications

Model	Sound power level (dBA)		Weight (kg)
	Cooling	Heating	
RAV-SM307KRTP-E	*	*	10
RAV-SM407KRTP-E	*	*	10

* Under 70 dBA

Declaration of Conformity

Manufacturer: **TOSHIBA CARRIER (THAILAND) CO., LTD.**
144 / 9 Moo 5, Bangkadi Industrial Park, Tivanon Road, Tambol Bangkadi,
Amphur Muang, Pathumthani 12000, Thailand

Authorized Representative / TCF holder: Nick Ball
Toshiba EMEA Engineering Director
Toshiba Carrier UK Ltd.
Porsham Close, Belliver Industrial Estate,
PLYMOUTH, Devon, PL6 7DB.
United Kingdom

Hereby declares that the machinery described below:

Generic Denomination: Air Conditioner

Model / type: RAV-SM307KRTP-E
RAV-SM407KRTP-E

Commercial name: Digital Inverter Series Super Digital Inverter Series Air Conditioner

Complies with the provisions of the "Machinery" Directive (Directive 2006 / 42 / EC) and the regulations transposing into national law

Complies with the provisions of the following harmonized standard:
EN 378-2: 2008+A2:2012

NOTE

This declaration becomes invalid if technical or operational modifications are introduced without the manufacturer's consent.

Information according to EMC Directive 2004 / 108 / EC	
(Name of the manufacturer)	TOSHIBA CARRIER (THAILAND) CO., LTD.
(Address, city, country)	144 / 9 Moo 5, Bangkadi Industrial Park, Tivanon Road, Tambol Bangkadi, Amphur Muang, Pathumthani 12000, Thailand
(Name of the Importer / Distributor in EU)	Toshiba Carrier UK Ltd.
(Address, city, country)	Porsham Close, Belliver Industrial Estate, PLYMOUTH, Devon, PL6 7DB. United Kingdom

TOSHIBA CARRIER (THAILAND) CO.,LTD.

144 / 9 Moo 5, Bangkadi Industrial Park, Tivanon Road, Tambol Bangkadi, Amphur Muang, Pathumthani 12000, Thailand

1111056502-1