



IS-IR-WIFI-1 User Manual

Issue date: 03/2016
r1.4

 **Intesis Software S.L.**

© 2016 Intesis Software S.L. All rights reserved.

This document has been carefully written by Intesis Software SL. and a lot of effort has been made to ensure no errors or mistakes are present in the document. Intesis Software S.L. is not responsible for printing or clerical errors.

Information in this document is subject to change without notice. No part of this publication may be reproduced, stored in a retrieval system or transmitted in any form or any means electronic or mechanical, including photocopying and recording for any purpose other than the purchaser's personal use without the written permission of Intesis Software S.L.

Intesis Software S.L.
Milà i Fontanals, 1 bis
08700 Igualada
Spain

IntesisHome® is a trademark of Intesis Software SL. Third party product names or company names used in this document may be trademarks of their respective companies. Its use in this document is purely for information purposes only.

Table of contents

Welcome	3
About this document	3
1 Description	4
2 Before starting	5
3 Quick Start	6
4 Device installation	7
4.1 Wall mounted position	7
4.2 Desktop position	8
4.3 Power connection	9
4.4 Location selection	11
4.4.1 Using your Wireless Controller	12
4.4.2 Using Parrot Mode	13
4.4.3 IR wireless remote controller feedback	14
5 Wi-Fi configuration	15
6 IR configuration	16
6.1 Learning mode	16
6.2 Manual mode	17
7 Device registration	18
8 Operation modes	19
8.1 Standard operation: App and web control of the AC unit	19
8.2 Back up operation: control of the AC unit from the IH button	20
9 Control configuration	20
10 Advanced configuration	21
11 Calendar, Timers and Scenes	21
12 Anti-frost function	22
13 LED status summary	24
13.1 LED status during Wi-Fi configuration	24
13.2 LED status during IR configuration (learning mode)	24
13.3 LED status during working mode	24
14 Troubleshooting	26

Welcome

Welcome to IntesisHome, the new eco-friendly system that will allow you to control your Air Conditioning units through our web interface, Apple devices (iPhone, iPad and iPod) and even Android devices.

IntesisHome Universal device will offer you:

- Compatibility with most AC units with IR wireless remote controller.
- Control and monitor: On/Off Mode, Set Temp., Room Temp., Fan Speed, Vane Position.
- Power supply connection to EU, UK, US and AU plugs.
- Easy installation: On the wall or over the desktop.
- On/Off status and AC Mode LED indication.
- Automatic firmware updates.
- AC unit status and monitoring¹.
- Back up operation mode.

About this document

This document contains the basis of the IntesisHome Universal device (IS-IR-WIFI-1): what you need to use it, how to install it, user and device registration processes and a summary of the application interface. For more information (how to use it and related topics) you can consult the interface information tags, our website (www.intesishome.com) or the manufacturers' website.

¹ Depending on the IntesisHome device installation, you can receive the feedback offered by the IR wireless remote controller from the AC unit. This will help you in knowing the last status sent by the remote controller to the AC unit. Please notice that this feature is subject to proper IntesisHome device installation. Please, check section 4.4.3 for more information.

1 Description

The IntesisHome Universal device is an external module capable of connecting your Air Conditioning units into your Wi-Fi network in order to provide global connectivity and remote control applications through a friendly user interface.

The packaging includes:

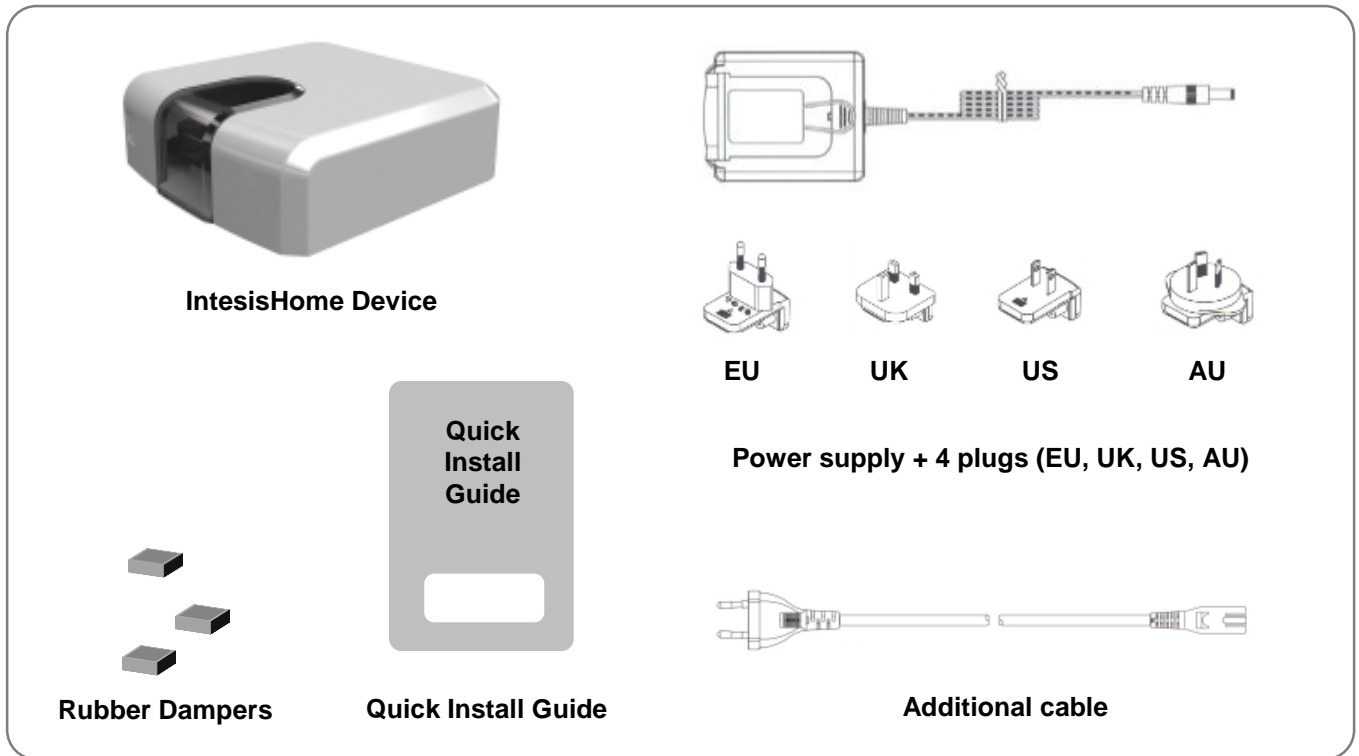

Figure 1-1 Package content

Regarding the device itself, it is composed by an IR interface, a signaling LED, an IH button and a Power connector.

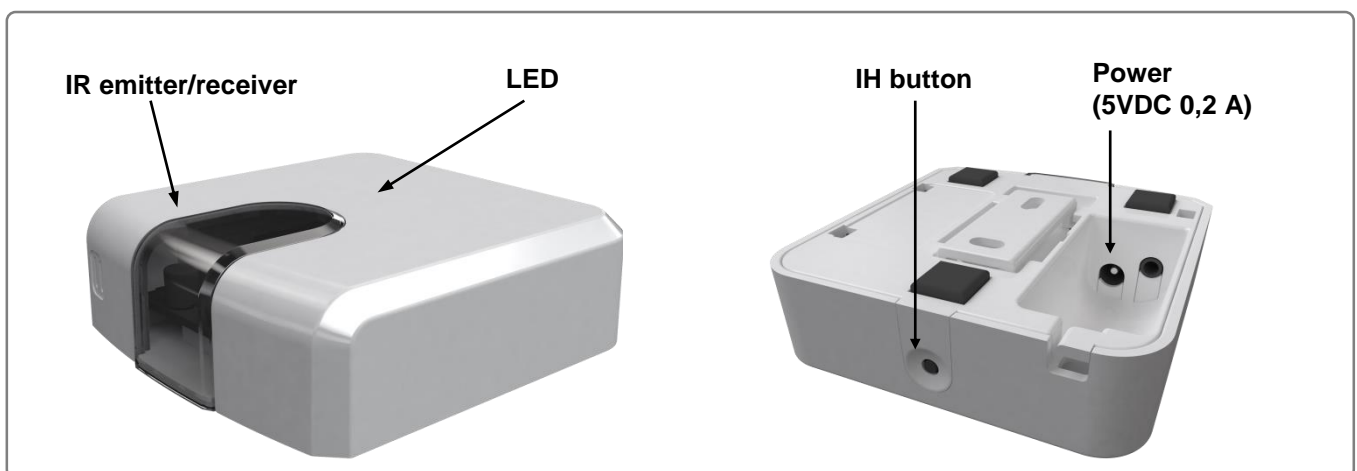

Figure 1-2 Device description

2 Before starting

Before starting the installation and configuration process please, make sure that you have:

- **IntesisHome device.**

Before start using IntesisHome you need to acquire and install (if you haven't done yet) an IntesisHome device².



Note: Make sure that you buy the right device. Remember that we have specific devices for each manufacturer and the universal one. Check the [How to buy section](#) to see which is the precise device you need.

- **Internet access.**





IntesisHome needs Internet connectivity during registration process and also during normal working mode.

Internet connectivity is needed for the use of the App or Web interface in the device location.

- **Device with Internet access and Wi-Fi connection.**

A device with access to Internet³ and Wi-Fi connection is needed (Desktop/laptop computer, Smartphone or Tablet).

Make sure that your device supports at least one of the following browsers and fulfills the minimum requirements:

	Minimum	Recommended
 Internet Explorer	9.0	9.0 or above
 Mozilla Firefox	10.0	10.0 or above
 Google Chrome	V8	V8 or above
 Safari	4.0	4.0 or above



Note: Users with older browser versions can experience some malfunctioning or misalignment of the images, icons and buttons of the control interface. Please update your browser to fit our minimum requirements.

² IntesisHome devices can be purchased in your usual air conditioner or heat pump reseller center.

³ Costs related with Internet access are not included in the IntesisHome price. Ask your Internet Service Provider about the associated costs of your Internet connection.

3 Quick Start

In order to start using our system you need to install the device, register it and own a user account. Next, there is a step by step guide to help you going through all this process.

1. Device installation

Place the IntesisHome Universal device in the final location and connect the power supply to the device.

More information about the installation process can be found in section 4.

2. Wi-Fi configuration

Once the device is installed and powered, please proceed with the Wi-Fi configuration. You can find more information about the Wi-Fi configuration process at

www.intesishome.com/docs/IntesisHome_DeviceConfig.pdf

3. IR configuration

In order to configure the IR part, please proceed as follows:

1. Push the IH button for 4 seconds. The LED will turn into white steady.
2. Pick up the IR wireless controller and push the On/Off button pointing to the IntesisHome universal device.

More information about the IR configuration process can be found in section 6.

4. Device registration

Follow bellow instructions to register your device:

1. Visit user.intesishome.com.
2. Create an account (in case you don't have it yet).
3. Visit the [settings/device/](#) section and click on add device.
4. Introduce the registration code (25 digit code on the manual sticker).
5. Select the widgets (functions) you want to use with your device.

More information about the device registration process can be found in section 7.

4 Device installation



CAUTION: To ensure regulatory compliance, use only the provided power supply.



IMPORTANT: Keep in mind that some furniture and materials (carpets, curtains, glass, metal...) may affect on the IR communication.



NOTE: The IntesisHome device has 2 IR emitters pointing at 2 different locations. Considering this and IR reflections, valid locations for the IntesisHome device may be many and very different depending on each installation. Check section 4.4 for more information.

As per the nature of the IR communication system and the IntesisHome device design, the IntesisHome device can be installed on a wall mounted position (Figure 4-1) or in a desktop position (Figure 4-2).

4.1 Wall mounted position

If you want to place the device attached to the wall, please consider any of the three options below (A, B or C).

In all cases, thanks to the IR technology, you can take advantage of IR signal rebounds and place the device in the best location you can imagine.

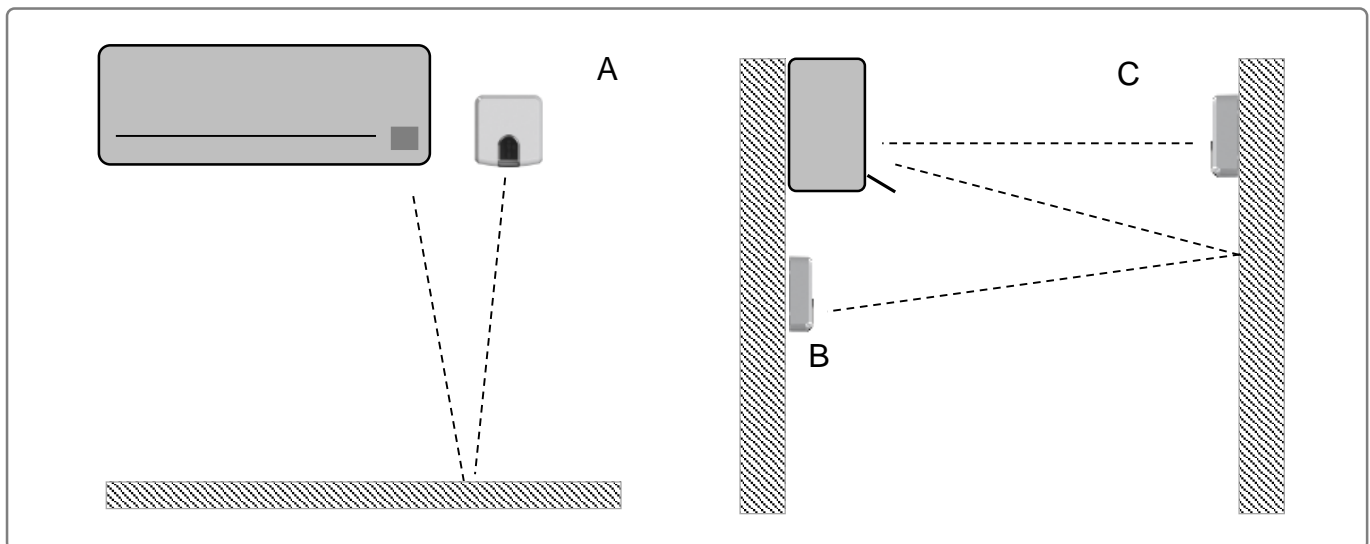

Figure 4-1 Wall mounted position options

Case A: Installed side-by-side with the AC unit. In that case, the signal will travel from the IntesisHome device to the AC unit taking advantage of the rebounds on the floor or other furniture present in the room.

Case B: Installed in front of the AC unit. In that case, the signal will travel from the IntesisHome device directly to the AC unit.

Case C: Installed below the AC unit. In that case, the signal will travel from the IntesisHome device to the AC unit taking advantage of the rebounds on the wall in front of it or other furniture present in the room.

4.2 Desktop position

If you want to place the device on your desktop or any other horizontal surface, please consider the sketch below. In this case, the signal will travel directly from the IntesisHome device to the AC unit.

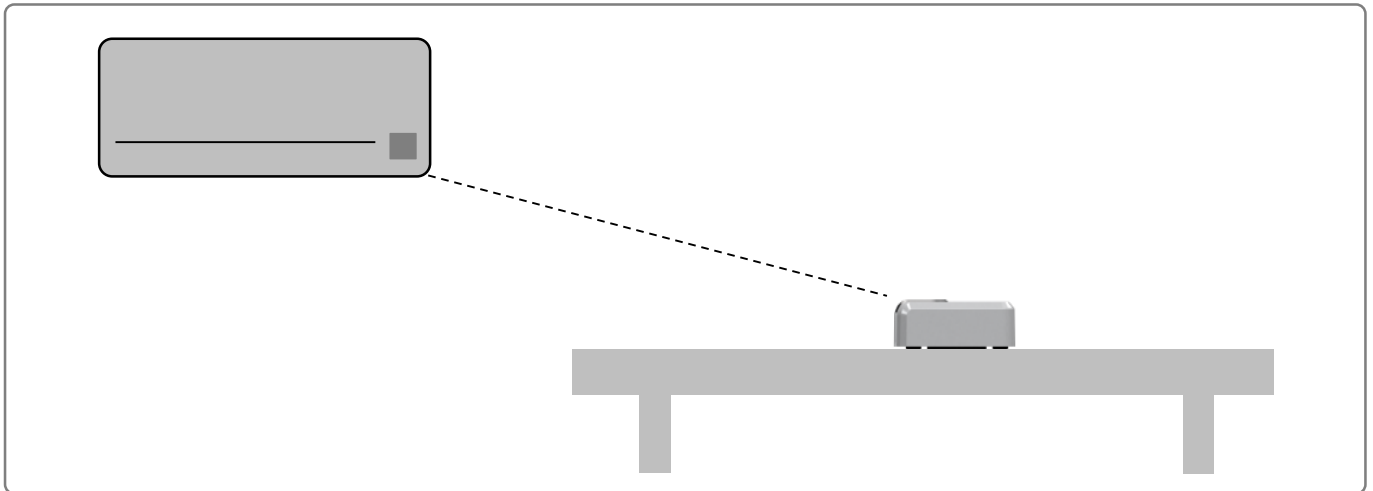

Figure 4-2 Desktop mounted position

In order not to produce marks or scratches on the surface and also to improve the device stability, you can use the rubber dumpers included in the package. Please, check Figure 4-3.

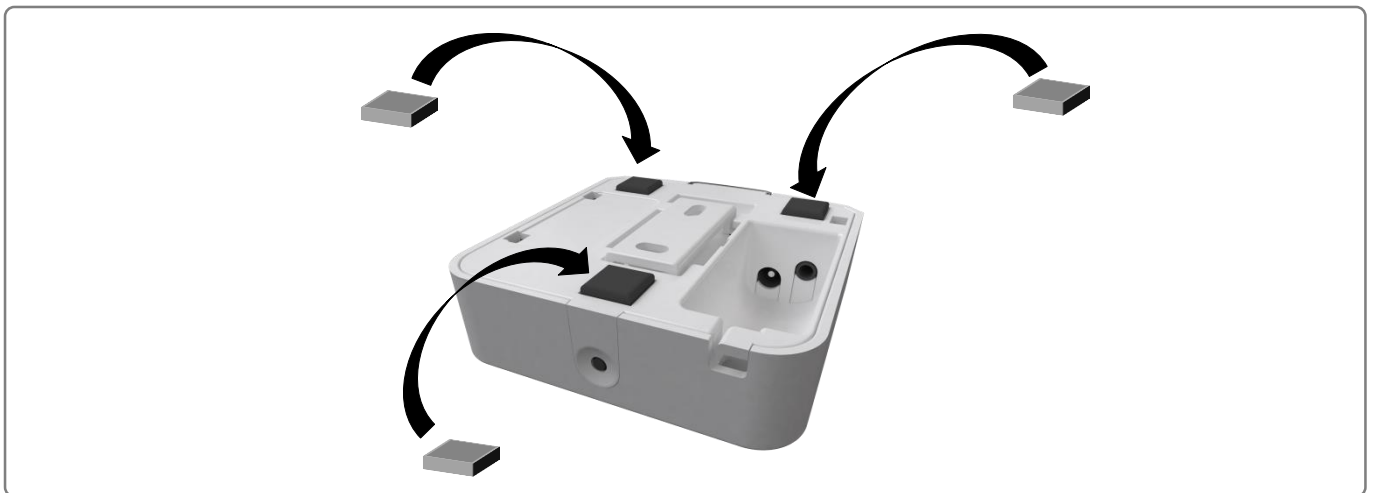

Figure 4-3 Rubber dumpers location

4.3 Power connection

The IntesisHome device comes with a 5V DC 0,2 A power supply to be connected to the device. We do also provide 4 different types of plugs to match your current location needs: European Union (EU), United Kingdom (UK), United States (US) and Australia (AU).

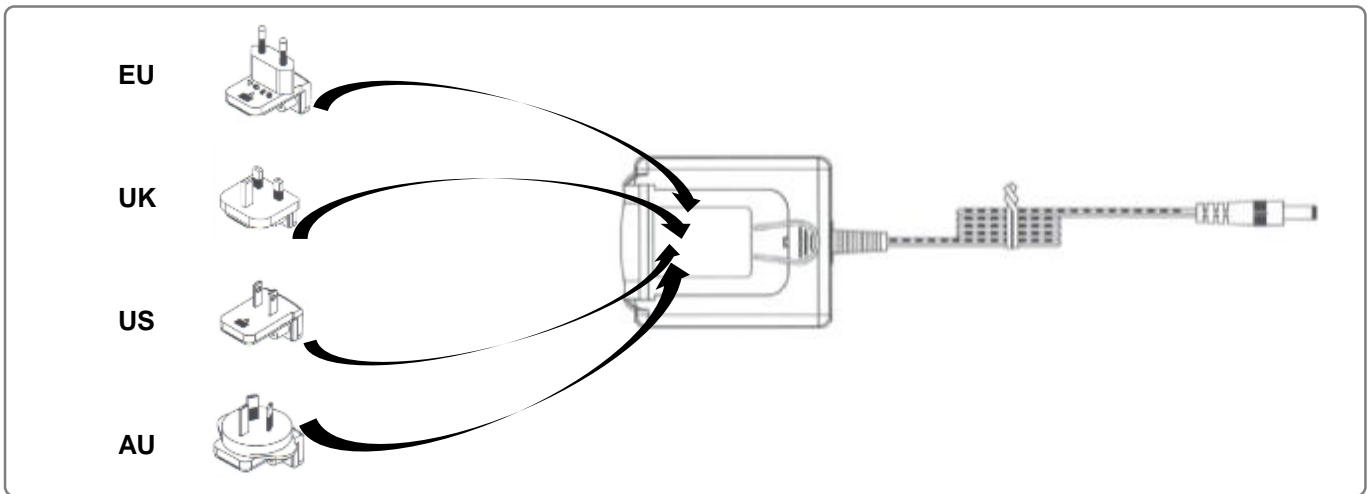

Figure 4-4 Power adaptor connection

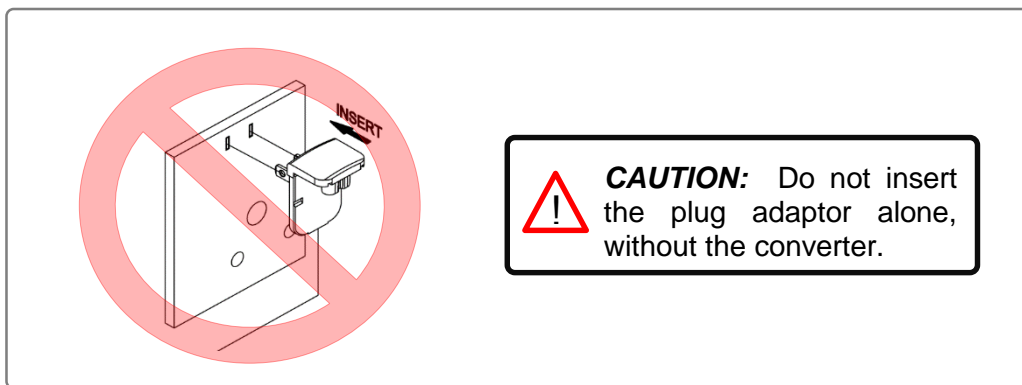

Figure 4-5 Warning

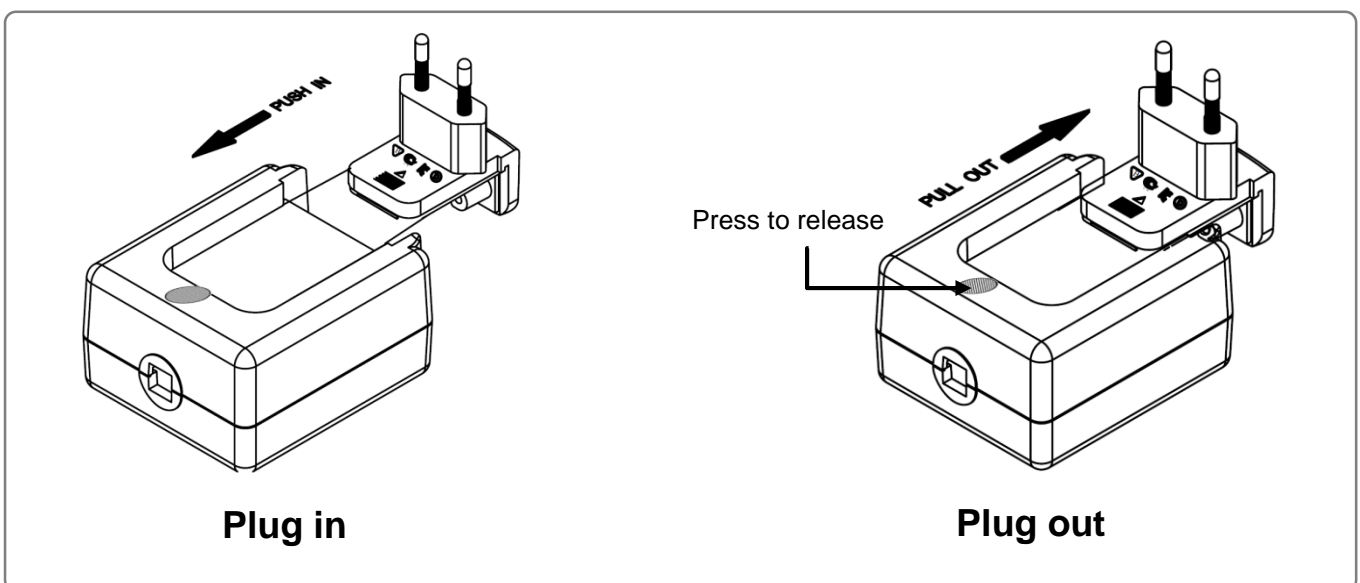

Figure 4-6 Plug-in – Plug-out instructions

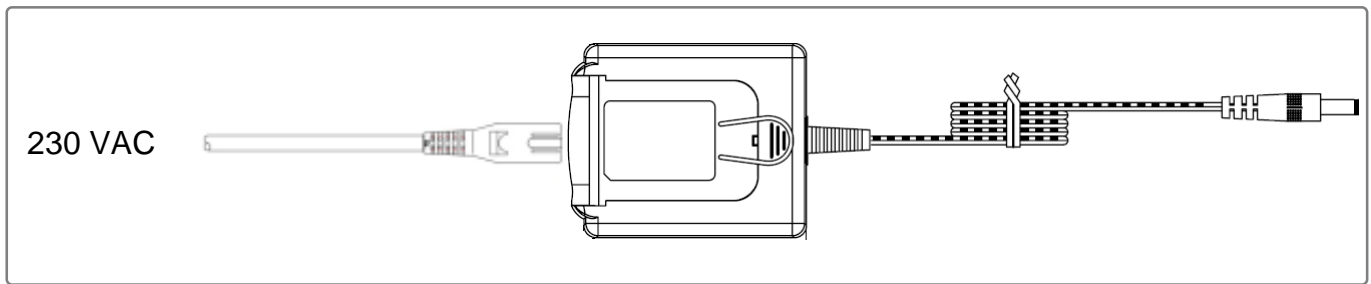

Figure 4-7 Additional cable connection

Along with the device, there is also an additional cable. One end may be connected to the power supply. First, remove the plug adaptor, you'll see that the power supply includes an IEC-60320 C8 standard connector and the cable uses an IEC-60320 C7 connector. Connect the other end of the cable to a 230VAC power source.

4.4 Location selection

Determining that the IntesisHome device will be working as expected in the installation location is an important stage. In order to determine the best location for your IntesisHome device, we offer you two possible options: use your Wireless Controller (the one of your AC unit) or use the special Parrot Mode.

When selecting the installation location, please keep in mind that the IntesisHome device has 2 IR emitters and 1 IR receiver. The 2 emitters increase the installation possibilities allowing many different suitable positions for the device location. On the other hand, the receiver offers the possibility to get the feedback from the IR wireless remote controller so the IntesisHome App status can be updated with that feedback.

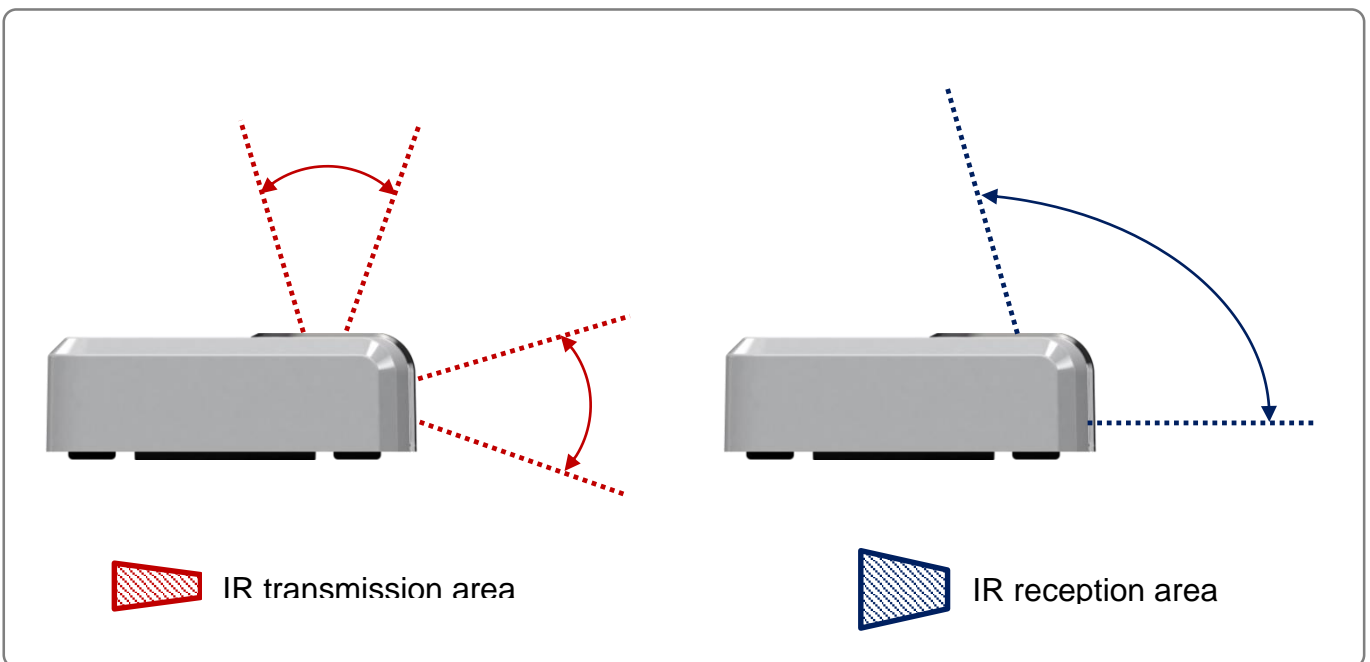

Figure 4-8 IR emitters and IR receiver location

4.4.1 Using your Wireless Controller

In order to determine if the desired location is suitable, please follow instructions next:

1. Pick up your Wireless Controller (the one from the AC unit).
2. Locate the Wireless Controller in the position you want to install the IntesisHome device.
3. Press the On/Off button of the Wireless Controller.
4. Check if you can control turn your AC unit On/Off from that position.
 - a. If yes, mostly you will be able to control your AC unit with the IntesisHome device from that position.
 - b. If no, try another location and repeat from step 3.

Remember that the IntesisHome device has 2 IR transmitters. Therefore, when using your IR wireless remote controller, please try both positions (horizontal and vertical). Check the figure below for more information.

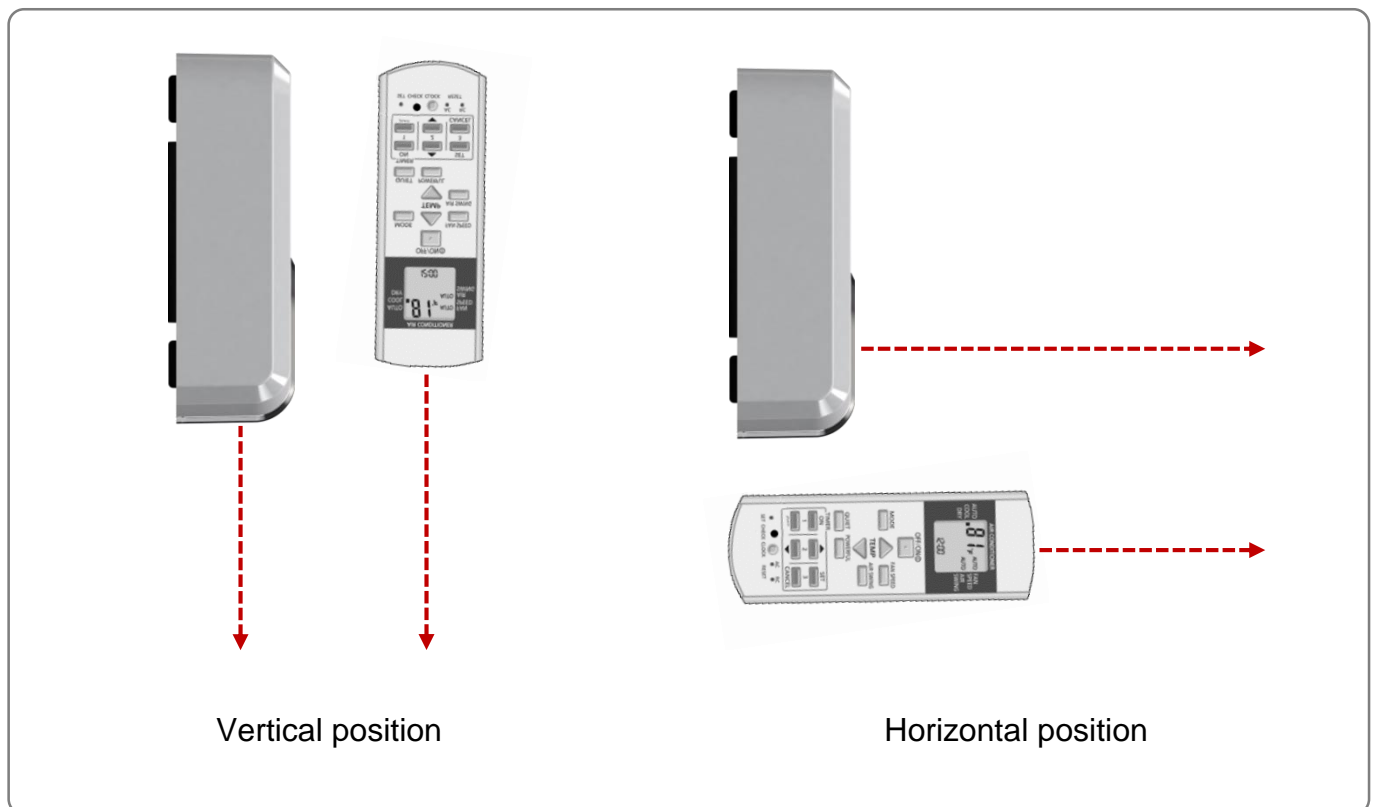

Figure 4-9 IR wireless remote controller positions to emulate IntesisHome device IR transmission.

4.4.2 Using Parrot Mode

The IntesisHome device includes a special mode (Parrot Mode) that will help you determining if the desired location is a good option or not. While this mode is active, the device will be sending constantly one command so you can check if in the desired location the AC system receives such signal and therefore is a good place to install the device.

In order to activate the Parrot Mode, please do as follows:

1. Power the IntesisHome device and wait for the LED to be green steady.
2. Click fast 3 consecutive times on the IH button.
3. Wait for the LED to start blinking in white.
4. Pick up the IR wireless controller of the AC system and press any function (On/Off preferably) pointing to the IntesisHome device.
5. Locate the IntesisHome device in the desired location and verify that the AC unit is receiving the command.
6. Click fast 3 consecutive times on the IH button to disable the Parrot Mode.



IMPORTANT: Parrot Mode is only available if the IntesisHome device is not Wi-Fi configured yet. If your IntesisHome device is already Wi-Fi configured and you want to use the Parrot Mode, please reset the device (pressing the IH button for 10 seconds). Remember that afterwards, you will need to configure the Wi-Fi parameters in the IntesisHome device again.

4.4.3 IR wireless remote controller feedback

The IntesisHome device includes an important feature: IR wireless remote controller feedback. Using this feature, you will be able to update the App status according to the last commands sent from the IR wireless remote controller to the AC unit.

This feature is enabled by default and you only need to consider where you place the IntesisHome device. In order to enjoy this feature, the IntesisHome device needs to receive the same IR signal the AC unit receives from the IR wireless remote controller. See an example on Figure 4-10.

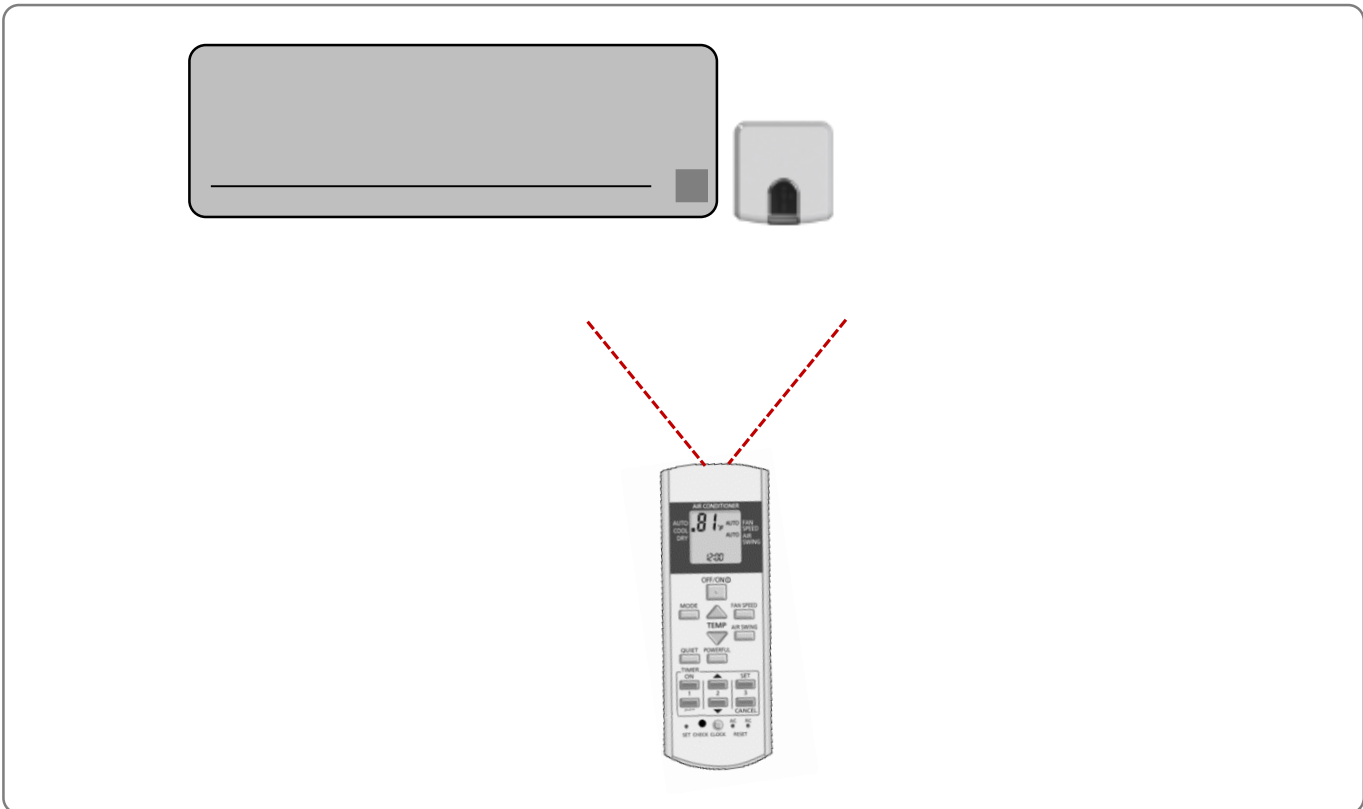



Figure 4-10 IR wireless remote controller feedback example

 **NOTE:** As per IR technology (IR ray reflections, basically) it is not necessary to point directly to the IntesisHome device to have this feedback.

5 Wi-Fi configuration

The IntesisHome device supports different Wi-Fi configuration modes:

- Auto (SSID visible networks)
- Manual (for non SSID visible networks)
- Advanced (for static IP configuration)
- WPS

In order to connect the IntesisHome device to your Access Point or Router, please proceed with the Wi-Fi configuration as follows:

1. Use a Wi-Fi device (smartphone, tablet, laptop or PC) to connect to our device.
2. Open a web browser and go to ihconfig.com
3. Follow the installation wizard.

You can find more information about the Wi-Fi configuration process at

www.intesishome.com/docs/IntesisHome_DeviceConfig.pdf

6 IR configuration



IMPORTANT: Before starting the IR configuration process, please check the compatibility list at www.intesishome.com/downloads/universal and make sure that you have the IntesisHome Universal Controller already connected to the Internet.

Once you have the IntesisHome device installed and Wi-Fi configured, you are ready to start the IR Configuration process. In order to configure the interface from the IR side, please use either the Learning mode (directly with your AC remote controller) or the Manual mode (using the user web interface).

6.1 Learning mode

Please, check that the LED device is Off and the IntesisHome device powered before starting this process.

In order to configure the IntesisHome device to start working with your AC unit using the IR, please do as follows:

1. Push the **IH button** for 4 seconds. The LED will turn into white steady.
2. Pick up the IR wireless controller of your AC unit and push the On/Off button pointing to the IntesisHome Universal device.



NOTE: Make sure that the AC unit is Off and the IR Wireless Controller is showing this Off status before pressing the On/Off button. In order to ensure the learning process, please **make sure you send an On command** from your IR Wireless controller.

- If the IntesisHome device LED starts blinking in Green.

The IR learning process has been successful.

- If the IntesisHome device LED starts blinking in Red.

Repeat the process from step 1 and check our compatibility list. If problem still persists, please visit our support section at www.intesishome.com/support

- If the IntesisHome device LED turns Off.

Repeat the process from step 1 and check that your IR wireless remote controller has batteries and that you are pointing directly to the IntesisHome Universal IR receiver.

6.2 Manual mode

If instead of using the IR remote controller of your AC unit, you want to use our web interface, please visit user.intesishome.com and follow instructions next:

1. Make sure that you have your IntesisHome device Wi-Fi configured.
2. Make sure that you have your IntesisHome device registered (see section 7).
3. Go to the *settings/device* section.
4. Press “manual mode” (Check Figure 6-1).

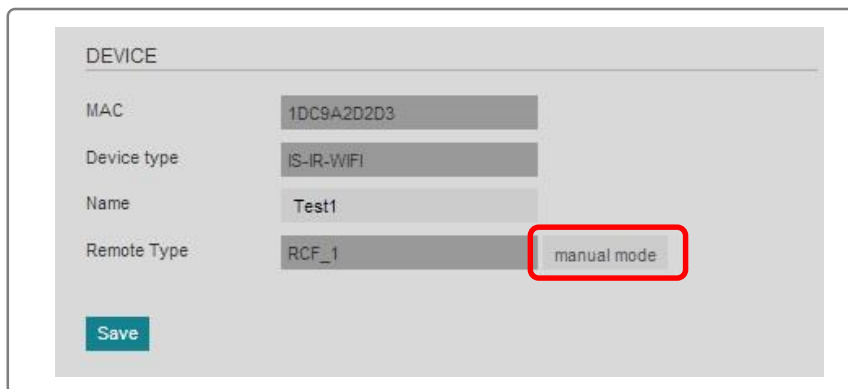

The screenshot shows a web form titled "DEVICE" with the following fields and values:

MAC	1DC9A2D2D3
Device type	IS-IR-WIFI
Name	Test1
Remote Type	RCF_1

Below the "Remote Type" field, there is a button labeled "manual mode" which is highlighted with a red rectangular box. A "Save" button is located at the bottom left of the form.

Figure 6-1 Manual mode activation

5. Select your AC unit brand and model (check Figure 6-2).

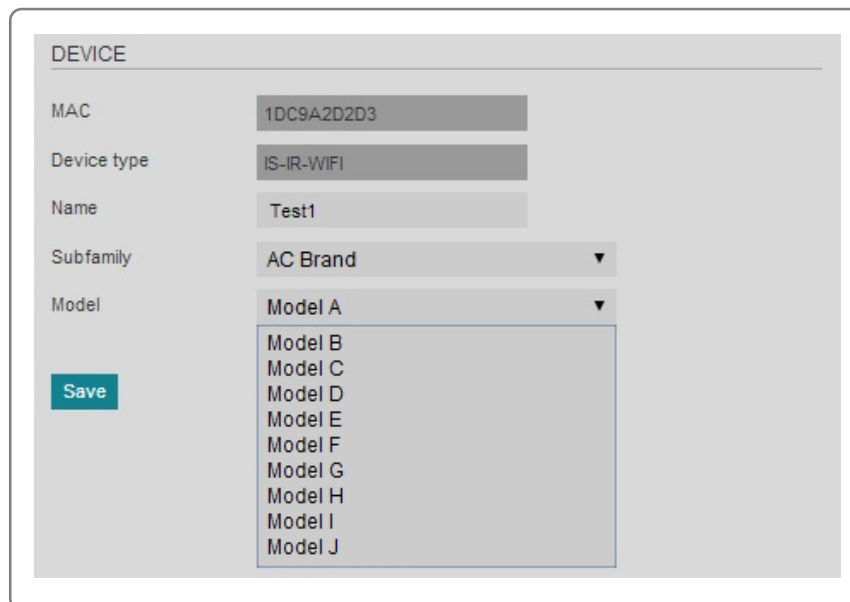

The screenshot shows the same "DEVICE" settings page as Figure 6-1, but with the "Subfamily" and "Model" dropdown menus open. The "Subfamily" dropdown is set to "AC Brand" and the "Model" dropdown is set to "Model A". The "Model" dropdown menu is expanded, showing a list of models from "Model A" to "Model J". A "Save" button is located at the bottom left of the form.

Figure 6-2 Brand and model selection

7 Device registration

After configuring the Wi-Fi connection and the IR communication, there is only one last step to be done: register your device.

Please, follow bellow instructions to register your device:

1. Visit user.intesishome.com.
2. Create an account (in case you don't have it yet).
3. Visit the settings/device/ section and click on add device.
4. Introduce the registration code (25 digit code on the manual sticker).
5. Select the widgets (functions) you want to use with your device.

You can find detailed information about the registration process on section 5 of the following manual

www.intesishome.com/docs/User-Manual-IntesisHome.pdf

8 Operation modes

The IntesisHome device can be operated in two different ways: standard operation (from the App or Web Interface) or back up operation (using the IH button).

8.1 Standard operation: App and web control of the AC unit.

This is the standard way to control the AC unit. Using our App or the control web interface, you will be able to control the AC unit in the same way you would do it using the IR remote controller.

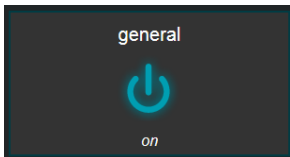

Turns the unit On/Off

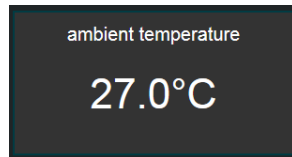

Shows the ambient temperature

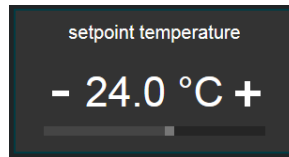

Sets the desired set point temperature

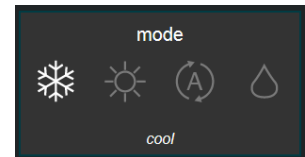

Sets the mode

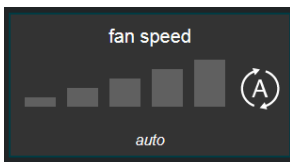

Sets the fan speed

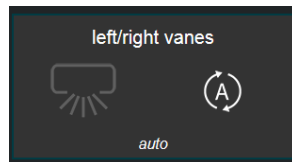

Sets the left/right vanes position

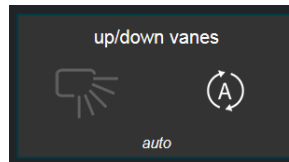

Sets the up/down vanes position



IMPORTANT: The ambient temperature is provided by an internal sensor located inside the IntesisHome device. Values provided by the IntesisHome device sensor may be used only as an estimation of the real ambient temperature not as a real measurement of the ambient temperature.



NOTE: Some of the widgets may not be present depending on the features of your AC unit. Please check your AC unit manual to get more information about the available features (fan speeds, left/right vanes, up/down vanes, modes and temperature ranges).

8.2 Back up operation: control of the AC unit from the IH button

Additionally, the IntesisHome device offers another important functionality. In case your Internet connection is not working and/or your IR remote controller is broken, you can set some commands to the AC unit pressing the **IH button**.

According to the current status of the AC unit, you can:

- **AC unit is Off**
 - If you click once on the **IH button**, the AC unit will turn On in Cool mode and a set point temperature of 25° C.
 - If you click twice on the **IH button**, the AC unit will turn On in Heat mode and a set point temperature of 21° C.
- **AC unit is On (in any mode)**
 - If you click once or twice on the **IH button**, the AC unit will turn Off.

9 Control configuration

At the **settings / device** section in the web interface (user.intesishome.com), users have the chance to select which widgets (icons) will be shown and in consequence which functions we want to control from the App (iOS and Android) or from the web (control section).

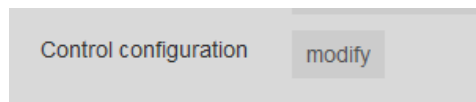

Clicking on the **modify** button, a pop-up window will appear letting us decide which modes will be configurable, the number of fan speeds, usage for the vertical and horizontal vanes...

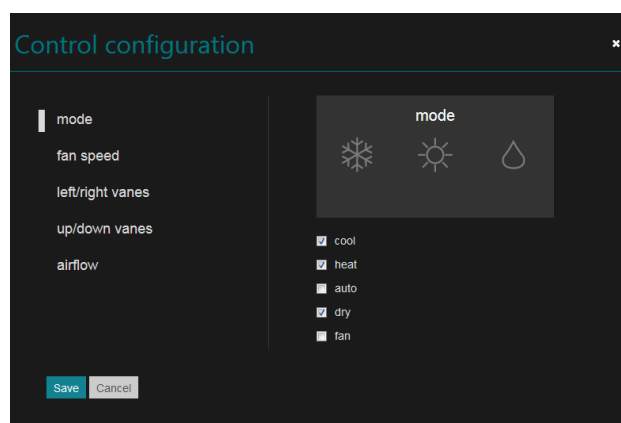

After setting all options as desired, it is important to keep in mind that the **save** button must be pressed to store our preferences.

It is also important to remember that some functions (modes, fan speed...) are directly related with the specific features of each AC unit. Therefore, it is important to keep in mind that the closest this selection is similar to reality the best the user experience would be.

10 Advanced configuration

On the settings / device section of the web interface (at user.intesishome.com), advanced configuration can be carried out. Advanced parameters that can be configured are:

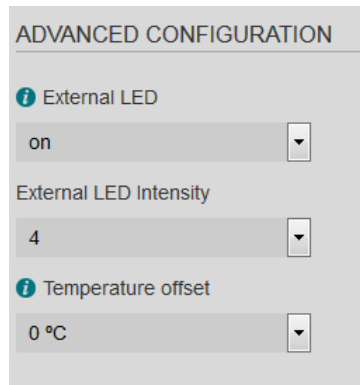

The screenshot shows a web interface titled "ADVANCED CONFIGURATION". It contains three settings, each with an information icon (i) and a dropdown menu:

- External LED:** The dropdown menu is set to "on".
- External LED Intensity:** The dropdown menu is set to "4".
- Temperature offset:** The dropdown menu is set to "0 °C".

- **External LED:** Determines if the IntesisHome device LED will be:
 - On:** On during Wi-Fi configuration, IR configuration and working mode (always On).
 - Off:** Off during Wi-Fi configuration, IR configuration and working mode (always Off).
 - Blinking only on change:** Blinking when commands are sent to the AC unit during working mode.
- **External LED intensity:** Determines the LED intensity. Values vary from 0 to 5.
- **Temperature offset:** Determines a temperature offset to be applied to the ambient temperature measured by the IntesisHome internal probe. Values vary from -3°C to +3°C.

11 Calendar, Timers and Scenes

The IntesisHome application offers you the opportunity to schedule some actions to be applied to the AC unit. This can be done basically using 3 different features of the IntesisHome application: Calendar, Timers and Scenes.

Please, check the IntesisHome user manual for more information about calendar and scenes at

www.intesishome.com/docs/User-Manual-IntesisHome.pdf

12 Anti-frost function

In order to prevent the indoor temperature reach freezing points, IntesisHome offers the possibility to set the set point temperature on a special set point. It can be enabled/disabled both: from the App (iOS and Android) and from the web interface.

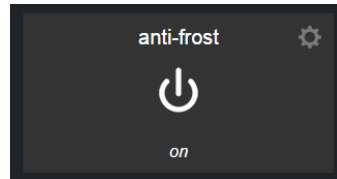

Turns the anti-frost function On/Off

This function can be configured **only** from the web interface, clicking on the gearwheel icon, allowing:

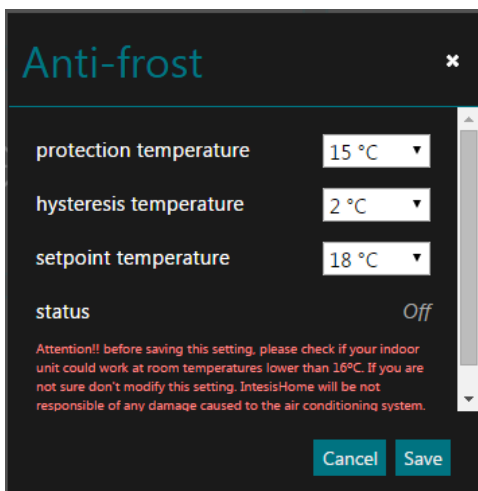

- **protection temperature:** Minimum temperature desired. Below that, the IntesisHome system will turn the AC unit on with the defined set point temperature. Protection temperature values may vary from 16°C to 10°C (16°C Default).
- **hysteresis temperature:** When the ambient temperature is higher than **protection temperature + hysteresis temperature**, the IntesisHome system will turn the AC unit Off. Hysteresis values may vary from 1°C to 5°C.
- **setpoint temperature:** Temperature to be set on the AC unit when ambient temperature is below the **protection temperature** and the AC unit is turned on. Set Point temperature values may vary from 18 to 30°C.
- **status:** Indicates if the AC unit is On/Off by anti-frost function.



NOTE: Fan switches to high speed automatically when the anti-frost function turns the AC unit On.

Check the figure next to see how the anti-frost system works:

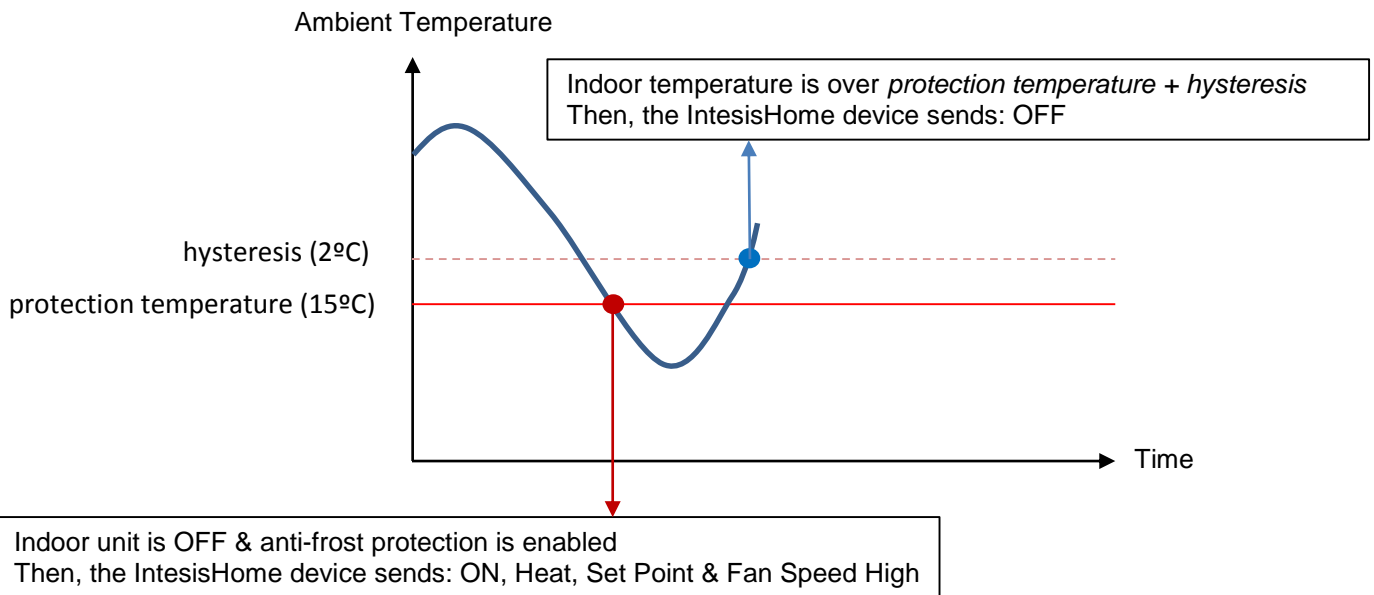

The anti-frost function includes also some protections such as:

- Automatic disabling if the AC unit is turned On manually.
- Keeps working even if Wi-Fi connection is lost.
- When operating, it re-sends the command to be applied each 10 minutes.
- When the anti-frost functions turns the AC unit On this will:
 - First sends **On - Heat - SetPoint** (the one configured) - **FanSpeed(MID)**
 - After 2 seconds it will send **On - Heat - SetPoint** (the one configured) - **FanSpeed(HIGH)**



IMPORTANT: Before changing the *protection temperature* below 16°C, please check if your indoor unit could work at indoor temperatures below 16° or check with the technical department of the AC manufacturer. **IntesisHome will be not responsible of any damage in the AC unit.**

13 LED status summary

According to the different stages where the device can work in, please find below the LED status summary for your guidance.

13.1 LED status during Wi-Fi configuration

LED Color (s)	Behavior	Description
Blue	Blinking	Performing WPS connection (up to 2 min)
Magenta	Blink	WPS connection error
White	Blinking	Identifying IntesisHome Device
Green	Steady	Not configured
Green	Blinking	Checking device configuration parameter values(up to 2 min)
Red	Blinking	Connecting to access point and server (up to 2 min)
Yellow	Blinking	Downloading configuration. Wait (up to 2 min)
Red - Green	Alternate blinking	Error Connecting to Access point or router. Try to connect again and make sure you write the correct password.
Yellow - Green	Alternate blinking	Server not reached. Check if there is Internet connectivity on your Access Point or router.

13.2 LED status during IR configuration (learning mode)

LED Color	Behavior	Description
White	Steady	Waiting customer pressing the On/Off button of the IR remote controller (up to 20 seconds)
Green	Blinking	The IR remote controller has been linked as expected with the IntesisHome device
Red	Blinking	The IR remote controller has NOT been linked as expected with the IntesisHome device

13.3 LED status during working mode

LED Color	Behavior	Description
Off		IntesisHome device not powered or IntesisHome device working and the AC unit is Off.
Blue	Steady	Indoor Unit ON working in Cool or Dry mode
Red		Indoor Unit ON working in Heat mode
Green		Indoor Unit ON working in Fan mode
Yellow		Indoor Unit ON working in Auto mode
Cyan		Indoor Unit working in anti-frost mode
Blue	3 blinks	Command received or sent during Cool or Dry mode
Red		Command received or sent during Heat mode
Green		Command received or sent during Fan mode

Yellow		Command received or sent during Auto mode
Cyan		Command sent during anti-frost mode
Red	Blinking	IntesisHome device trying to connect to the Internet

14 Troubleshooting

1. Can't connect the IntesisHome device to my Wi-Fi network

If you have problems connecting the IntesisHome device to the Wi-Fi network, please visit the connection section in our FAQ site to get more information about possible problems and solutions.

<http://www.intesishome.com/support/faq/>

2. Learning mode is not working (LED is blinking red after several attempts)

If the IntesisHome device blinks in red after pressing the On/Off button of your AC unit during the learning mode, please check our compatibility list at

www.intesishome.com/downloads/universal

3. Learning mode is not progressing (LED is only blinking in white)

If the IntesisHome device is blinking in white and is not passing to red or green blinking either, please check that the IR remote controller is in Off position before proceeding with the learning stage.

For any other problem or issue, please do not hesitate to visit our support site at <http://www.intesishome.com/support/faq/> or contact us using our contact form at www.intesishome.com/contact/