

TOSHIBA

AIR CONDITIONER (MULTI TYPE)

Installation Manual

R32

For commercial use

Outdoor Unit

Model name:

<Heat Pump Model>

MCY-MUG0401HSW-E

MCY-MUG0501HSW-E

MCY-MUG0601HSW-E

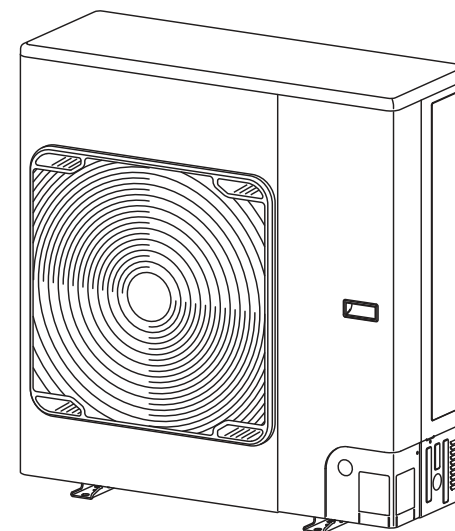

Original Instruction

Please read this Installation Manual carefully before installing the Air Conditioner.

- This Manual describes the installation method of the outdoor unit.
- For installation of the indoor unit, follow the Installation Manual attached to the indoor unit.

ADOPTION OF R32 REFRIGERANT

This air conditioner adopts the HFC refrigerant (R32) which does not destroy the ozone layer.

This outdoor unit is designed exclusively for use with R32 refrigerant. Be sure to use in combination with a R32 refrigerant indoor unit.

Contents

1	Precautions for safety	4
2	Precautions of equipment using R32 refrigerant	10
3	Accessory parts	22
4	Installation of R32 refrigerant air conditioner	22
5	Installation conditions	23
6	Refrigerant piping	26
7	Electric wiring	35
8	Address setting	38
9	Communication setting	41
10	Applicable control settings	46
11	Test run	47
12	Troubleshooting	50

Thank you for purchasing this Toshiba air conditioner.

Please read carefully through these instructions that contain important information which complies with the "Machinery" Directive (Directive 2006/42/EC), and ensure that you understand them.

After reading these instructions, be sure to keep them in a safe place together with the Owner's Manual and Installation Manual supplied with your product.

Generic Denomination: Air Conditioner

Definition of Qualified Installer or Qualified Service Person

The air conditioner must be installed, maintained, repaired and removed by a qualified installer or qualified service person. When any of these jobs is to be done, ask a qualified installer or qualified service person to do them.

A qualified installer or qualified service person is an agent who has the qualifications and knowledge described in the table below.

Agent	Qualifications and knowledge which the agent must have
Qualified installer (*1)	<ul style="list-style-type: none"> The qualified installer is a person who installs, maintains, relocates and removes the air conditioners made by Toshiba Carrier Air-conditioning Europe Sp. z o.o. He or she has been trained to install, maintain, relocate and remove the air conditioners made by Toshiba Carrier Air-conditioning Europe Sp. z o.o or, alternatively, he or she has been instructed in such operations by an individual or individuals who have been trained and is thus thoroughly acquainted with the knowledge related to these operations. The qualified installer who is allowed to do the electrical work involved in installation, relocation and removal has the qualifications pertaining to this electrical work as stipulated by the local laws and regulations, and he or she is a person who has been trained in matters relating to electrical work on the air conditioners made by Toshiba Carrier Air-conditioning Europe Sp. z o.o or, alternatively, he or she has been instructed in such matters by an individual or individuals who have been trained and is thus thoroughly acquainted with the knowledge related to this work. The qualified installer who is allowed to do the refrigerant handling and piping work involved in installation, relocation and removal has the qualifications pertaining to this refrigerant handling and piping work as stipulated by the local laws and regulations, and he or she is a person who has been trained in matters relating to refrigerant handling and piping work on the air conditioners made by Toshiba Carrier Air-conditioning Europe Sp. z o.o or, alternatively, he or she has been instructed in such matters by an individual or individuals who have been trained and is thus thoroughly acquainted with the knowledge related to this work. The qualified installer who is allowed to work at heights has been trained in matters relating to working at heights with the air conditioners made by Toshiba Carrier Air-conditioning Europe Sp. z o.o or, alternatively, he or she has been instructed in such matters by an individual or individuals who have been trained and is thus thoroughly acquainted with the knowledge related to this work.
Qualified service person (*1)	<ul style="list-style-type: none"> The qualified service person is a person who installs, repairs, maintains, relocates and removes the air conditioners made by Toshiba Carrier Air-conditioning Europe Sp. z o.o. He or she has been trained to install, repair, maintain, relocate and remove the air conditioners made by Toshiba Carrier Air-conditioning Europe Sp. z o.o or, alternatively, he or she has been instructed in such operations by an individual or individuals who have been trained and is thus thoroughly acquainted with the knowledge related to these operations. The qualified service person who is allowed to do the electrical work involved in installation, repair, relocation and removal has the qualifications pertaining to this electrical work as stipulated by the local laws and regulations, and he or she is a person who has been trained in matters relating to electrical work on the air conditioners made by Toshiba Carrier Air-conditioning Europe Sp. z o.o or, alternatively, he or she has been instructed in such matters by an individual or individuals who have been trained and is thus thoroughly acquainted with the knowledge related to this work. The qualified service person who is allowed to do the refrigerant handling and piping work involved in installation, repair, relocation and removal has the qualifications pertaining to this refrigerant handling and piping work as stipulated by the local laws and regulations, and he or she is a person who has been trained in matters relating to refrigerant handling and piping work on the air conditioners made by Toshiba Carrier Air-conditioning Europe Sp. z o.o or, alternatively, he or she has been instructed in such matters by an individual or individuals who have been trained and is thus thoroughly acquainted with the knowledge related to this work. The qualified service person who is allowed to work at heights has been trained in matters relating to working at heights with the air conditioners made by Toshiba Carrier Air-conditioning Europe Sp. z o.o or, alternatively, he or she has been instructed in such matters by an individual or individuals who have been trained and is thus thoroughly acquainted with the knowledge related to this work.

Definition of Protective Gear

When the air conditioner is to be transported, installed, maintained, repaired or removed, wear protective gloves and 'safety' work clothing.

In addition to such normal protective gear, wear the protective gear described below when undertaking the special work detailed in the table below.

Failure to wear the proper protective gear is dangerous because you will be more susceptible to injury, burns, electric shocks and other injuries.

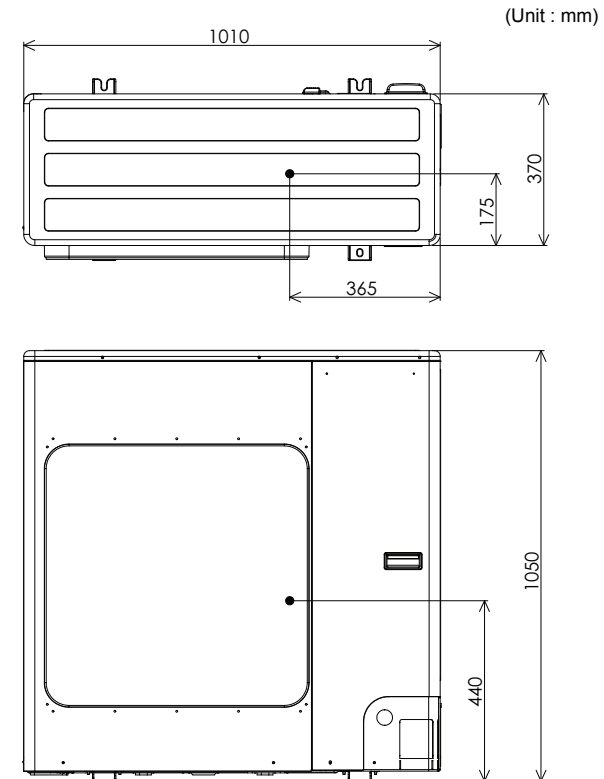

Work undertaken	Protective gear worn
All types of work	Protective gloves 'Safety' working clothing
Electrical-related work	Gloves to provide protection for electricians Insulating shoes Clothing to provide protection from electric shock
Work done at heights (50 cm or more)	Helmets for use in industry
Transportation of heavy objects	Shoes with additional protective toecap
Repair of outdoor unit	Gloves to provide protection for electricians

■ Center of Gravity









■ Warning indications on the air conditioner unit

These safety cautions describe important matters concerning safety to prevent injury to users or other people and damages to property. Please read through this manual after understanding the contents below (meanings of indications), and be sure to follow the description.

Indication	Meaning of Indication
 WARNING	Text set off in this manner indicates that failure to adhere to the directions in the warning could result in serious bodily harm (1) or loss of life if the product is handled improperly.
 CAUTION	Text set off in this manner indicates that failure to adhere to the directions in the caution could result in slight injury (2) or damage (3) to property if the product is handled improperly.

- 1: Serious bodily harm indicates loss of eyesight, injury, burns, electric shock, bone fracture, poisoning, and other injuries which leave aftereffect and require hospitalization or long-term treatment as an outpatient.
- 2: Slight injury indicates injury, burns, electric shock, and other injuries which do not require hospitalization or long-term treatment as an outpatient.
- 3: Damage to property indicates damage extending to buildings, household effects, domestic livestock, and pets.

Warning indication	Description		
 <table border="1"> <tr> <td>WARNING</td> </tr> <tr> <td>ELECTRICAL SHOCK HAZARD Disconnect all remote electric power supplies before servicing.</td> </tr> </table>	WARNING	ELECTRICAL SHOCK HAZARD Disconnect all remote electric power supplies before servicing.	WARNING ELECTRICAL SHOCK HAZARD Disconnect all remote electric power supplies before servicing.
WARNING			
ELECTRICAL SHOCK HAZARD Disconnect all remote electric power supplies before servicing.			
 <table border="1"> <tr> <td>WARNING</td> </tr> <tr> <td>Moving parts. Do not operate unit with grille removed. Stop the unit before the servicing.</td> </tr> </table>	WARNING	Moving parts. Do not operate unit with grille removed. Stop the unit before the servicing.	WARNING Moving parts. Do not operate unit with grille removed. Stop the unit before the servicing.
WARNING			
Moving parts. Do not operate unit with grille removed. Stop the unit before the servicing.			
 <table border="1"> <tr> <td>CAUTION</td> </tr> <tr> <td>High temperature parts. You might get burned when removing this panel.</td> </tr> </table>	CAUTION	High temperature parts. You might get burned when removing this panel.	CAUTION High temperature parts. You might get burned when removing this panel.
CAUTION			
High temperature parts. You might get burned when removing this panel.			
 <table border="1"> <tr> <td>CAUTION</td> </tr> <tr> <td>Do not touch the aluminum fins of the unit. Doing so may result in injury.</td> </tr> </table>	CAUTION	Do not touch the aluminum fins of the unit. Doing so may result in injury.	CAUTION Do not touch the aluminium fins of the unit. Doing so may result in injury.
CAUTION			
Do not touch the aluminum fins of the unit. Doing so may result in injury.			
 <table border="1"> <tr> <td>CAUTION</td> </tr> <tr> <td>Do not touch the aluminum fins of the unit. You might get burned.</td> </tr> </table>	CAUTION	Do not touch the aluminum fins of the unit. You might get burned.	CAUTION Do not touch the aluminum fins of the unit. You might get burned.
CAUTION			
Do not touch the aluminum fins of the unit. You might get burned.			
 <table border="1"> <tr> <td>CAUTION</td> </tr> <tr> <td>BURST HAZARD Open the service valves before the operation, otherwise there might be the burst.</td> </tr> </table>	CAUTION	BURST HAZARD Open the service valves before the operation, otherwise there might be the burst.	CAUTION BURST HAZARD Open the service valves before the operation, otherwise there might be the burst.
CAUTION			
BURST HAZARD Open the service valves before the operation, otherwise there might be the burst.			

1 Precautions for safety

The manufacturer shall not assume any liability for the damage caused by not observing the description of this manual.

WARNING

General

- Before starting to install the air conditioner, read through the Installation Manual carefully, and follow the instructions to install the air conditioner. Otherwise, falling down of the unit may occur, or the unit may cause noise, vibration or water leakage.
 - Only a qualified installer(*1) or qualified service person(*1) is allowed to do installation work. If installation is carried out by an unqualified individual, a fire, electric shocks, injury, water leakage, noise and/or vibration may result.
 - If using separately sold products, make sure to use Toshiba specified products only. Using unspecified products may cause fire, electric shock, water leak or other failure.
 - Do not use any refrigerant different from the one specified for complement or replacement. Otherwise, abnormally high pressure may be generated in the refrigeration cycle, which may result in a failure or explosion of the product or an injury to your body.
 - When transporting the air conditioner, use a forklift and when moving the air conditioner by hand, move the unit with 4 people.
 - Before opening the service panel of the outdoor unit, set the circuit breaker to the OFF position. Failure to set the circuit breaker to the OFF position may result in electric shocks through contact with the interior parts. Only a qualified installer (*1) or qualified service person(*1) is allowed to remove the service panel of the outdoor unit and do the work required.
- Before carrying out the installation, maintenance, repair or removal work, be sure to set the circuit breakers for both the indoor and outdoor units to the OFF position. Otherwise, electric shock may result.
 - Place a “Work in progress” sign near the circuit breaker while the installation, maintenance, repair or removal work is being carried out. There is a danger of electric shocks if the circuit breaker is set to ON by mistake.
 - Only a qualified installer(*1) or qualified service person(*1) is allowed to undertake work at heights using a stand of 50 cm or more or to remove the intake grille of the indoor unit to undertake work.
 - Wear protective gloves and safety work clothing during installation, servicing and removal.
 - Do not touch the aluminum fin of the outdoor unit. You may injure yourself if you do so. If the fin must be touched for some reason, first put on protective gloves and safety work clothing, and then proceed.
 - Do not climb onto or place objects on top of the outdoor unit. You may fall or the objects may fall off of the outdoor unit and result in injury.
 - When working at height, put a sign in place so that no-one will approach the work location before proceeding with the work. Parts or other objects may fall from above, possibly injuring a person below. Also, be sure that workers put on helmets.
 - When cleaning the filter or other parts of the outdoor unit, set the circuit breaker to OFF without fail, and place a “Work in progress” sign near the circuit breaker before proceeding with the work.
 - The refrigerant used by this air conditioner is the R32.

- Do not power other equipment such as vacuum pump from the outdoor unit. Doing so may cause a fire or a malfunction of the air conditioner.
- Do not disassemble, modify or move the product yourself. Doing so may cause fire, electric shock, injury or water leaks.
- This appliance is intended to be used by expert or trained users in shops, in light industry, or for commercial use by lay persons.
- We do not take any responsibility on the local design.

Selection of installation location

- Due to the use of the mildly flammable refrigerant R32, there are safety and legal installation conditions for installing equipment such as indoor units, Outdoor units, and Shut-off Valve units. Install each unit according to the section "Installation conditions for each equipment".
- Do not install in a location where flammable gas may leaks are possible. If the gas should leak and accumulate around the unit, it may ignite and cause a fire.
- When transporting the air conditioner, wear shoes with protective toe caps, protective gloves and other protective clothing.
- When transporting the air conditioner, do not take hold of the bands around the packing carton. You may injure yourself if the bands break.
- Install the indoor unit at least 2.5 m above the floor level since otherwise the users may injure themselves or receive electric shocks if they poke their fingers or other objects into the indoor unit while the air conditioner is running.
- Do not place any combustion appliance in a place where it is directly exposed to the wind of air conditioner, otherwise it may cause imperfect combustion.

- Do not install in location where operation sound of the outdoor unit may cause a disturbance. (Especially at the boundary line with a neighbor, install the air conditioner while considering the noise)

Installation

- Follow the instructions in the Installation Manual to install the air conditioner. Failure to follow these instructions may cause the product to fall down or topple over or give rise to noise, vibration, water leakage or other failure.
- The designated bolts (M10) and nuts (M10) for securing the outdoor unit must be used when installing the unit.
- Install the outdoor unit properly in a location that is durable enough to support the weight of the outdoor unit. Insufficient durability may cause the outdoor unit to fall, which may result in injury.
- Install the unit in the prescribed manner for protection against strong wind and earthquake. Incorrect installation may result in the unit falling down, or other accidents.
- Be sure to fix the screws back which have been removed for installation or other purposes.

Refrigerant piping

- Install the refrigerant pipe securely during the installation work before operating the air conditioner. If the compressor is operated with the valve open and without refrigerant pipe, the compressor sucks air and the refrigeration cycles is over pressurized, which may cause a injury.
- Tighten the flare nut with a torque wrench in the specified manner. Excessive tighten of the flare nut may cause a crack in the flare nut after a long period, which may result in refrigerant leakage.

- Ventilate the air if the refrigerant gas leaks during installation. If the leaked refrigerant gas comes into contact with fire, toxic gas may be produced.
- After the installation work, confirm that refrigerant gas does not leak. If refrigerant gas leaks into the room and flows near a fire source, such as a cooking range, noxious gas may be generated. For prevention, install according to the section “Installation conditions for each equipment”.
- When the air conditioner has been installed or relocated, follow the instructions in the Installation Manual and purge the air completely so that no gases other than the refrigerant will be mixed in the refrigerating cycle. Failure to purge the air completely may cause the air conditioner to malfunction.
- Nitrogen gas must be used for the airtight test.
- The charge hose must be connected in such a way that it is not slack.
- If refrigerant gas has leaked during the installation work, ventilate the room immediately. If the leaked refrigerant gas comes in contact with fire, noxious gas may be generated. For prevention, install according to the section “Precautions of equipment using R32”.

Electrical wiring

- Only a qualified installer(*1) or qualified service person(*1) is allowed to carry out the electrical work of the air conditioner. Under no circumstances must this work be done by an unqualified individual since failure to carry out the work properly may result in electric shocks and/or electrical leaks.
- When connecting the electrical wires, repairing the electrical parts or undertaking other electrical jobs, wear gloves to provide protection for electricians and from heat, insulating shoes and

clothing to provide protection from electric shocks. Failure to wear this protective gear may result in electric shocks.

- When executing address setting, test run, or troubleshooting through the checking window on the electrical control box, put on insulated heat-proof gloves, insulated shoes and other clothing to provide protection from electric shock. Otherwise you may receive an electric shock.
- Use wiring that meets the specifications in the Installation Manual and the stipulations in the local regulations and laws. Use of wiring which does not meet the specifications may give rise to electric shocks, electrical leakage, smoking and/or a fire.
- Check that the product is properly earthed. (grounding work) Incomplete earthing may cause electric shock.
- Do not connect the earth wire to a gas pipe, water pipe, lightning conductor, or a telephone earth wire.
- After completing the repair or relocation work, check that the ground wires are connected properly.
- Install a circuit breaker that meets the specifications in the installation manual and the stipulations in the local regulations and laws.
- Install the circuit breaker where it can be easily accessed by the agent.
- When installing the circuit breaker outdoors, install one which is designed to be used outdoors.
- Under no circumstances must the power cable be extended. Connection trouble in the places where the cable is extended may give rise to smoking and/or a fire.
- Electrical wiring work shall be conducted according to law and regulation in the community and installation manual. Failure to do so may result in electrocution or short circuit.

- Do not supply power from the power terminal block equipped on the outdoor unit to another outdoor unit. Capacity overflow may occur on the terminal block and may result in fire.
- When carrying out electric connection, use the wire specified in the Installation Manual and connect and fix the wires securely to prevent them applying external force to the terminals. Improper connection or fixing may result in fire.

Test run

- Before operating the air conditioner after having completed the work, check that the electrical control box cover of the indoor unit and service panel of the outdoor unit are closed, and set the circuit breaker to the ON position. You may receive an electric shock if the power is turned on without first conducting these checks.
- When you have noticed that some kind of trouble (such as when an error display has appeared, there is a smell of burning, abnormal sounds are heard, the air conditioner fails to cool or heat or water is leaking) has occurred in the air conditioner, do not touch the air conditioner yourself but set the circuit breaker to the OFF position, and contact a qualified service person. Take steps to ensure that the power will not be turned on (by marking "out of service" near the circuit breaker, for instance) until qualified service person arrives. Continuing to use the air conditioner in the trouble status may cause mechanical problems to escalate or result in electric shocks or other failure.
- After the work has finished, be sure to use an insulation tester set (500 V Megger) to check the resistance is 2 MΩ or more between the charge section and the non-charge metal section (Earth section). If the resistance value is low, a disaster such as a leak or electric shock is caused at user's side.

- Upon completion of the installation work, check for refrigerant leaks and check the insulation resistance and water drainage. Then conduct a test run to check that the air conditioner is operating properly.

Explanations given to user

- Upon completion of the installation work, tell the user where the circuit breaker is located. If the user does not know where the circuit breaker is, he or she will not be able to turn it off in the event that trouble has occurred in the air conditioner.
- If you have discovered that the fan grille is damaged, do not approach the outdoor unit but set the circuit breaker to the OFF position, and contact a qualified service person (*1) to have the repairs done. Do not set the circuit breaker to the ON position until the repairs are completed.
- After the installation work, follow the Owner's Manual to explain to the customer how to use and maintain the unit.

Relocation

- Only a qualified installer (*1) or qualified service person (*1) is allowed to relocate the air conditioner. It is dangerous for the air conditioner to be relocated by an unqualified individual since a fire, electric shocks, injury, water leakage, noise and/or vibration may result.
- When carrying out the pump-down work shut down the compressor before disconnecting the refrigerant pipe. Disconnecting the refrigerant pipe with the service valve left open and the compressor still operating will cause air or other gas to be sucked in, raising the pressure inside the refrigeration cycle to an abnormally high level, and possibly resulting in rupture, injury or other trouble.

- Never recover the refrigerant into the outdoor unit. Be sure to use a refrigerant recovery machine to recover the refrigerant when moving or repairing. It is impossible to recover the refrigerant into the outdoor unit. Refrigerant recovery into the outdoor unit may result in serious accidents such as explosion of the unit, injury or other accidents.

(*1) Refer to the “Definition of Qualified Installer or Qualified Service Person.”

CAUTION

This air conditioner adopts the HFC refrigerant (R32) which does not destroy the ozone layer.

- R32 refrigerant has a high working pressure and is apt to be affected by impurities such as water, oxidizing membrane, and oils. Therefore, during installation work, be careful that water, dust, previous refrigerant, refrigerating machine oil, or other substances do not enter the R32 refrigeration cycle.
- Special tools for R32 or R410A refrigerant are required for installation.
- For connecting pipes, use new and clean piping materials, and make sure that water and/or dust does not enter.

To disconnect the appliance from main power supply.

- This appliance must be connected to the main power supply by means of a switch with a contact separation of at least 3 mm.

Do not wash air conditioners with pressure washers.

- Electric leaks may cause electric shocks or fires.





Since the mildly flammable refrigerant R32 is used, for the installation conditions and safety precautions for indoor units, outdoor units, etc., refer to the following “Precautions for using R32 refrigerant” and do the installation works.

Precautions for using R32 refrigerant

Make sure installation, servicing, maintenance and repair comply with instructions from TOSHIBA and with applicable legislation (for example, national gas regulation) and are executed only by authorized people.

These safety cautions describe important matters concerning safety to prevent injury to users or other people and damages to property. Please read through this manual after understanding the contents below (meanings of indications), and be sure to follow the description;

MEANINGS OF SYMBOLS DISPLAYED ON THE UNIT

	<p>WARNING (Risk of fire)</p>	<p>This mark is for R32 refrigerant only. Refrigerant type is written on nameplate of outdoor unit. In case that refrigerant type is R32, this unit uses a flammable refrigerant. If refrigerant leaks and comes in contact with fire or heating part, it will create harmful gas and there is risk of fire.</p>
	<p>Read the OWNER’S MANUAL carefully before operation.</p>	
	<p>Service personnel are required to carefully read the OWNER’S MANUAL and INSTALLATION MANUAL before operation.</p>	
	<p>Further information is available in the OWNER’S MANUAL, INSTALLATION MANUAL, and the like.</p>	

WARNING

General

- Models that use refrigerant R32 and R410A have a different charging port thread diameter to prevent erroneous charging with refrigerant R22 and for safety
- Do not use means to accelerate the defrosting process or to clean, other than those recommended by the manufacturer.
- The appliance shall be stored in a room without continuously operating ignition sources.
(For example: open flames, an operating gas appliance or an operating electric heater.)
- Do not pierce or burn.
- Be aware that refrigerants may not contain an odor.
- The manufacturer may provide other suitable examples or may provide additional information about the refrigerant odor.

CAUTION

When a flammable refrigerant is used, all appliance shall be charged with refrigerant at the manufacturing location or charged on site as recommended by the manufacturer.

A part of an appliance that is charged on site, which requires brazing or welding in the installation shall not be shipped with a flammable refrigerant charge. Joints made in the installation between parts of the refrigerating system, with at least one part charged, shall be made in accordance with the following.

- A brazed, welded, or mechanical connection shall be made before opening the valves to permit refrigerant to flow between the refrigerating system parts. A vacuum valve shall be provided to evacuate the interconnecting pipe and/or any uncharged refrigerating system part.

- Refrigerant tubing shall be protected or enclosed to avoid damage. Flexible refrigerant connectors (such as connecting lines between the indoor and outdoor unit) that may be displaced during normal operations shall be protected against mechanical damage.
- Piping shall be protected from damage during installation, operation and maintenance.
- When installing piping in the occupied space, protect the piping from accidental damage.
- Check the piping as described in [8 Refrigerant piping] [Airtightness test].
- Wherever possible, protection, piping and fixtures shall be protected against the environment and weather resistance.
- You must prepare for long-term expansion and contraction of piping.
- Indoor equipment and plumbing must be safely installed and protected from accidental rupture of equipment or plumbing from events such as furniture movements or home renovations.

2 Precautions of equipment using R32 refrigerant

General (Installation space / area)

- The installation of pipe-work shall be kept to a minimum.
- Pipe-work shall be protected from physical damage.
- The compliance with national gas regulations shall be observed.
- The mechanical connections shall be accessible for maintenance purposes.
- In cases that require mechanical ventilation, ventilation openings shall be kept clear of obstruction.
- When disposing of the product is used, be based on national regulations with properly processed.
- The servicing shall be performed only as recommended by the manufacturer.
- Where the appliance using flammable refrigerants is installed, Be aware that;
 - The appliance shall be stored in a well-ventilated area where the room size corresponds to the room area as specified for operation.
 - The appliance shall be stored in a room without continuously operating open flames (for example an operating gas appliance) and ignition sources (for example an operating electric heater).
 - The appliance shall be stored so as to prevent mechanical damage from occurring.
- Equipment piping in the occupied space shall be installed in such a way to protect against accidental damage in operation and service.
- Precautions shall be taken to avoid excessive vibration or pulsation to refrigerating piping.
- Protection devices, piping and fittings shall be protected as far as possible against adverse environmental effects, for example, the danger of water collecting and freezing in relief pipes or the accumulation of dirt and debris.
- Provision shall be made for expansion and contraction of long runs of piping.
- Piping in refrigerating systems shall be so designed and installed to minimize the likelihood hydraulic shock damaging the system.
- Solenoid valves shall be correctly positioned in the piping to avoid hydraulic shock.
- Install the system according to this IM and avoid the likelihood hydraulic shock damaging the system.
- Solenoid valves shall not block in liquid refrigerant unless adequate relief is provided to the refrigerant system low pressure side.
- Install the system according to this Installation Manual so that it does not shut off in the liquid refrigerant.
- Steel pipes and components shall be protected against corrosion with a rustproof coating before applying any insulation.
- Flexible pipe elements shall be protected against mechanical damage, excessive stress by torsion, or other forces. They should be checked for mechanical damage annually.
- The indoor equipment and pipes shall be securely mounted and guarded such that accidental rupture of equipment cannot occur from such events as moving furniture or reconstruction activities.
- Where safety shut off valves are specified, the minimum room area may be determined based on the maximum amount of refrigerant that can be leaked as determined in Installation Manual.
- Where safety shut off valves are specified, the location of the valve in the refrigerating system relative to the occupied spaces shall be as described Installation Manual.
- When installing the system that uses flammable refrigerant in a non-ventilated space, it shall be installed in the large space or with safety equipment as designated below, so as to prevent the refrigerant from staying and causing a fire or explosion by the refrigerant leak.

- Field-made refrigerant joints indoors shall be tightness tested. The test method shall have a sensitivity of 5 grams per year of refrigerant or better under a pressure of at least 0,25 times the maximum allowable pressure. No leak shall be detected.
- The total refrigerant charge in the system cannot exceed the requirements for minimum floor area of the smallest room that is served. For minimum floor area requirements for indoor units, see the Installation and Owner's Manual of the outdoor unit.
- When connecting to an outdoor unit of the R32 refrigerant and using a leak detector, always turn on the power of the indoor unit after installation except during service in order to detect refrigerant leakage and take safety measures.
- Precautions shall be taken to avoid excessive vibration or pulsation to refrigerating piping.
- Only mechanical fittings can be used. (Example: Brazing + Flare connection)
- Refrigerating systems shall use only permanent joints indoors except for site-made joints directly connecting the indoor unit to the refrigerant piping, or factory made mechanical joints in compliance with ISO 14903.

Unventilated area

- The appliance shall be stored so as to prevent mechanical damage from occurring.

Information on servicing

1. Check to the area

- Prior to beginning work on systems containing flammable refrigerants, safety checks are necessary to ensure that risk of ignition is minimized. For repair to the refrigerating system, the precautions in item 2 to 6 shall be complied with prior to conducting work on the system.

2. Work procedure

- Work shall be undertaken under a controlled procedure so as to minimize the risk of a flammable gas or vapor being present while the work is being performed.
- When connecting to an outdoor unit of R32 refrigerant and using a leak detector, the fan may automatically operate even if the air conditioner is stopped when a refrigerant leak is detected. Be careful not to get injured by the fan.
- All installers and others working in the local area shall be instructed on the nature of work being carried out. Work in confined spaces shall be avoided..

3. General work area

- All maintenance staff and others working in the local area shall be instructed on the nature of work being carried out.
- Work in confined spaces shall be avoided.
- The area around the workspace shall be sectioned off.
- Ensure that the conditions within the area have been made safe by control of flammable material.
- Only equipment approved by the manufacturer shall be used for duct work.

4. Checking for presence of refrigerant

- If any hot work is to be conducted on the refrigeration equipment prior to and during work, to ensure the technician is aware of potentially flammable atmospheres.
- Ensure that the leak detection equipment being used is suitable for use with all applicable refrigerants, i.e. non sparking, adequately sealed or intrinsically safe.

5. Presence of fire extinguisher

- If any hot work is to be conducted on the refrigeration equipment or any associated parts, appropriate fire extinguishing equipment shall be available on hand.
- Have a dry powder or CO₂ fire extinguisher adjacent to the charging area.

6. No ignition sources

- No person carrying out work in relation to a refrigeration system which involves exposing any pipe work shall use any sources of ignition in such a manner that it may lead to the risk of fire or explosion.
- All possible ignition sources including cigarette smoking, should be kept sufficiently far away from the site of installation, repairing, removing and disposal, during which refrigerant can possibly be released to the surrounding space.

- Prior to work taking place, the area around the equipment is to be surveyed to make sure that there are no flammable hazards or ignition risks. "No Smoking" signs shall be displayed.
- Make sure that the exhaust port of the vacuum pump is not close to the ignition source and that ventilation is possible.

7. Ventilated area

- Ensure that the area is in the open or that it is adequately ventilated before breaking into the system or conducting any hot work.
- A degree of ventilation shall continue during the period that the work is carried out.
- The ventilation should safely disperse any released refrigerant and preferably expel it externally into the atmosphere.

8. Checks to the refrigeration equipment

- Where electrical components are being changed, installer shall be fit for the purpose and to the correct specification.
- At all times the manufacturer's maintenance and service guidelines shall be followed. If in doubt consult the manufacturer's technical department for assistance.
- The following checks shall be applied to installations using flammable refrigerants.
 - The charge size is in accordance with the room size within which the refrigerant containing parts are installed.
 - The ventilation machinery and outlets are operating adequately and are not obstructed.
 - If an indirect refrigerating circuit is being used, the secondary circuit shall be checked for the presence of refrigerant.
 - Marking to the equipment continues to be visible and legible. Markings and signs that are illegible shall be corrected.
 - Refrigeration pipe or components are installed in a position where they are unlikely to be exposed to any substance which may corrode refrigerant containing components, unless the components are constructed of materials which are inherently resistant to being corroded or are suitably protected against being so corroded.

9. Checks to electrical devices

- Repair and maintenance to electrical components shall include initial safety checks and component inspection procedures.
- If a fault exists that could compromise safety, then no electrical supply shall be connected to the circuit until it is satisfactorily dealt with.
- If the fault cannot be corrected immediately but it is necessary to continue operation, an adequate temporary solution shall be used. This shall be reported to the owner of the equipment so all parties are advised.
- Initial safety checks shall include:
 - That capacitors are discharged to avoid possibility of sparking.
 - That there no live electrical components and wiring are exposed while charging, recovering or purging the system.
 - That there is continuity of earth bonding.

10. Repairs to sealed components

- During repairs to sealed components, all electrical supplies shall be disconnected from the equipment being worked upon prior to any removal of sealed covers, etc.
- If it is absolutely necessary to have an electrical supply to equipment during servicing, then a permanently operating form of leak detection shall be located at the most critical point toward of a potentially hazardous situation.
- Particular attention shall be paid to the following to ensure that by working on electrical components, the casing is not altered in such a way that the level of protection is affected.
- This shall include damage to cables, excessive number of connections, terminals not made to original specification, damage to seals, incorrect fitting of glands, etc.
- Ensure that apparatus is mounted securely.
- Ensure that seals or sealing materials have not degraded to the point that they no longer serve the purpose of preventing the ingress of flammable atmospheres.
- Replacement parts shall be in accordance with the manufacturer's specifications.

NOTE

The use of silicon sealant may inhibit the effectiveness of some types of leak detection equipment. Intrinsically safe components do not have to be isolated prior to working on them.

11. Repair to intrinsically safe components

- Do not apply any permanent inductive or capacitance loads to the circuit without ensuring that this will not exceed the permissible voltage and current permitted for the equipment in use.
- Intrinsically safe components are the only types that can be worked on while live in the presence of a flammable atmosphere.
- The test apparatus shall be at the correct rating.
- Replace components only with parts specified by the manufacturer.
- Other parts may result in the ignition of refrigerant in the atmosphere from a leak.

12. Cabling

- Check that cabling will not be subject to wear, corrosion, excessive pressure, vibration, sharp edges or any other adverse environmental effects.
- Check shall also take into account the effects of aging or continual vibration from sources such as compressors or fans.

13. Detection of flammable refrigerants

- Under no circumstances shall potential sources of ignition be used in the searching for or detection of refrigerant leaks.
- A halide torch (or any other detector using a naked flame) shall not be used.
- Electronic leak detectors may be used to detect refrigerant leaks but, in the case of flammable refrigerants, the sensitivity may not be adequate, or may need re-calibration. (Detection equipment shall be calibrated in a refrigerant-free area.)
- Ensure that the detector is not a potential source of ignition and is suitable for the refrigerant used.
- Leak detection equipment shall be set at a percentage of the LFL of the refrigerant and shall be calibrated to the refrigerant employed and the appropriate percentage of gas (25% maximum) is confirmed.
- Leak detection fluids are also suitable for use with most refrigerants but the use of detergents containing chlorine shall be avoided as the chlorine may react with the refrigerant and corrode containing chlorine.
- If a leak is suspected, all naked flames shall be removed / extinguished.
- If a leakage of refrigerant is found which requires brazing, all of the refrigerant shall be recovered from the system, or isolated (by means of shut off valves) in a part of the system remote from the leak.

14. Leak detection methods

- Electronic leak detectors shall be used to detect flammable refrigerants leak, but the sensitivity may not be adequate, or may need re-calibration. (Detection equipment shall be calibrated in a refrigerant-free area.)
- Ensure that the detector is not a potential source of ignition and is suitable for the refrigerant used.
- Leak detection equipment shall be set at a percentage of the LFL of the refrigerant and shall be calibrated to the refrigerant employed and the appropriate percentage of gas (25% maximum) is confirmed.
- Leak detection fluids are suitable for use with most refrigerants but the use of detergents containing chlorine shall be avoided as the chlorine may react with the refrigerant and corrode the copper pipework.
- If a leak is suspected, all naked flames shall be removed / extinguished.
- If a leakage of refrigerant is found which requires brazing, all of the refrigerant shall be recovered from the system, or isolated (by means of shut off valves) in a part of the system remote from the leak.
- Oxygen free nitrogen (OFN) shall then be purged through the system both before and during the brazing process.

15. Removal and evacuation

- When breaking into the refrigerant circuit to make repairs or for any other purpose, Conventional procedures shall be used. However, it is important that best practice is followed since flammability is a consideration. The following procedure shall be adhered to:
 - remove refrigerant
 - purge the circuit with inert gas;
 - evacuate;

- purge again with inert gas;
- open the circuit by cutting or brazing;
- The refrigerant charge shall be recovered into the correct recovery cylinders.
- The system shall be "Flushed" with OFN to render the unit safe.
- This process may need to be repeated several times.
- Compressed air or oxygen shall not be used for purging refrigerant systems.
- Flushing shall be achieved by breaking the vacuum in the system with OFN and continuing to fill until the working pressure is achieved, then venting to atmosphere, and finally pulling down to a vacuum.
- This process shall be repeated until no refrigerant is within the system.
- When the final OFN charge is used, the system shall be vented down to atmospheric pressure to enable work to take place.
- This operation is absolutely vital if brazing operations on the pipe work are to take place.
- Ensure that the outlet for the vacuum pump is not close to any ignition sources and that ventilation available.

16. Charging procedures

- In addition to conventional charging procedures, the following requirements shall be followed.
 - Ensure that contamination of different refrigerants does not occur when using charging equipment.
 - Hoses or lines shall be as short as possible to minimize the amount of refrigerant contained in them.
 - Cylinders shall be kept upright.
 - Ensure that the refrigeration system is earthed prior to charging the system with refrigerant.
 - Label the system when charging is complete (if not already).
 - Extreme care shall be taken not to overfill the refrigeration system.
- Prior to recharging the system, it shall be pressure-tested with the appropriate purging gas.
- The system shall be leak tested on completion of charging but prior to commissioning.
- A follow up leak test shall be carried out prior to leaving the site.

17. Decommissioning

- Before carrying out this procedure, it is essential that the technician is completely familiar with the equipment and all its details.
- It is recommended good practice that all refrigerants are recovered safely.
- Prior to the task being carried out, an oil and refrigerant sample shall be taken in case analysis is required to reuse of reclaimed refrigerant.
- It is essential that electrical power is available before the task is commenced.
 - a) Become familiar with the equipment and its operation.
 - b) Isolate system electrically.
 - c) Before attempting the procedure ensure that:
 - Mechanical handling equipment is available, if required, for handling refrigerant cylinders;
 - All personal protective equipment is available and being used correctly;
 - The recovery process is supervised at all times by a competent person;
 - Recovery equipment and cylinders conform to the appropriate standards
 - d) Pump down refrigerant system, if possible.
 - e) If a vacuum is not possible, make a manifold so that refrigerant can be removed from various parts of the system.
 - f) Make sure that cylinder is situated on the scales before recovery takes place.
 - g) Start the recovery machine and operate in accordance with manufacturer's instructions.
 - h) Do not overfill cylinders. (No more than 80% volume liquid charge.)
 - i) Do not exceed the maximum working pressure of the cylinder, even temporarily.
 - j) When the cylinders have been filled correctly and the process completed, make sure that the cylinders and the equipment are removed from site promptly and all isolation valves on the equipment are closed off.
 - k) Recovered refrigerant shall not be charged into another refrigeration system unless it has been cleaned and checked.

18. Labelling

- Equipment shall be labelled stating that it has been decommissioned and emptied of refrigerant.
- The label shall be dated and signed.
- Ensure that there are labels on the equipment stating the equipment contains flammable refrigerant.

19. Recovery

- When removing refrigerant from a system, either for servicing or decommissioning, it is recommended good practice that all refrigerants are removed safely.
- When transferring refrigerant into cylinders, ensure that only appropriate refrigerant recovery cylinders are employed.
- Ensure that the correct number of cylinders for holding the total system charge are available.
- All cylinders to be used are designated for the recovered refrigerant and labelled for that refrigerant (i.e. special cylinders for the recovery of refrigerant).
- Cylinders shall be complete with pressure-relief valve and associated shut-off valves in good working order.
- Empty recovery cylinders are evacuated and, if possible, cooled before recovery occurs.
- The recovery equipment shall be in good working order with a set of instructions concerning the equipment that is at hand and shall be suitable for the recovery of all appropriated refrigerants.
- In addition, a set of calibrated weighing scales shall be available and in good working order.
- Hoses shall be complete with leak-free disconnect couplings and in good condition.
- Before using the recovery machine, check that it is in satisfactory working order, has been properly maintained and that any associated electrical components are sealed to prevent ignition in the event of a refrigerant release.
- Consult manufacturer if in doubt.
- The recovered refrigerant shall be returned to the refrigerant supplier in the correct recovery cylinder, and the relevant waste transfer note arranged.
- Do not mix refrigerants in recovery units and especially not in cylinders.
- If compressors or compressor oils are to be removed, ensure that they have been evacuated to an acceptable level to make certain that flammable refrigerant does not remain within the lubricant.
- The evacuation process shall be carried out prior to returning the compressor to the suppliers.
- Only electric heating to the compressor body shall be employed to accelerate this process.
- When oil is drained from a system, it shall be carried out safely.
- Do not use the unit until it is confirmed that the portion from which the refrigerant leaked is repaired.
- When installing, relocating, or servicing the air conditioner, use only the specified refrigerant (R32) to charge the refrigerant lines. Do not mix it with any other refrigerant and do not allow air to remain in the lines.

(1) Installation conditions for each requirement

- To comply with the requirements of enhanced tightness refrigerating systems of IEC 60335-2-40, the system is equipped with Shut-off Valve unit, Leak Detector and Battery kit. And each systems have the appropriate safety systems in according to the system specifications. In case the requirements of this manual are followed, no additional safety measures are needed.
- Follow the installation requirements below to ensure that the complete system is compliant to legislation.
- If you have any questions, please contact the dealer where you purchased the product.
- Depending on the conditions, safety measures (optional parts) may be required.
- System compliance has been completed to IEC60335-2-40 Ed6. If EN378 compliance is required please refer separately to EN378 for guidance.

1) Installation conditions for each requirement

- Please observe the following warning and install according to "4. Installation of R32 refrigerant air conditioner".

⚠ WARNING

Basically the outdoor unit has to be installed in outdoor area.
 The outdoor unit has to be installed at least one side of 4 sides surrounding the unit open.
 When installing indoors such as in a machine room, it shall be installed in accordance with IEC60335-2-40.
 For other installation conditions, please contact the dealer where you purchased the product.

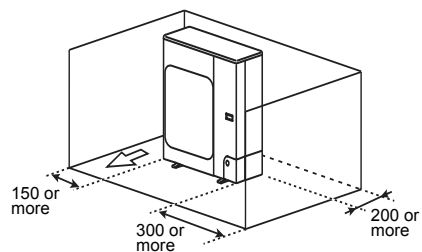

2) Indoor unit installation

For the installation of the indoor unit, refer to the installation manual attached to the indoor unit.
 For the indoor unit installation of R32 air conditioning system, check the following before installing.

⚠ WARNING

- Appliance shall be installed, operated and stored in a room with a floor area larger than minimum floor area $[A_{min}] m^2$.
- For appliances using R32 refrigerant connected via an air duct system to one or more rooms, No auxiliary devices, which may be a potential ignition source, shall be installed in the duct work. (example: hot surfaces with a temperature exceeding 700°C and electric switching device)
- The supply and return air shall be directly ducted to the space. Open areas such as false ceilings shall not be used as a return air duct;
- There shall be no operating ignition sources (example: open flames, an operating gas appliance or an operating electric heater) in case the floor area is less than the minimum floor area A (m²).
 For the applicable floor area and minimum floor area $[A_{min}]$, refer to [1] to [5] below.
- Piping shall be installed according to the instruction in "6 Refrigerant piping". $[A_{min}]$ is determined by the length of the connection pipe, types of indoor unit, etc.

[1] [Confirmation of installation space and floor area]

- Make sure that each indoor unit meet the installation height and floor area specified by indoor unit type and the total system refrigerant amount.
- Please refer to the numerical values of line A and line B in the graphs below.

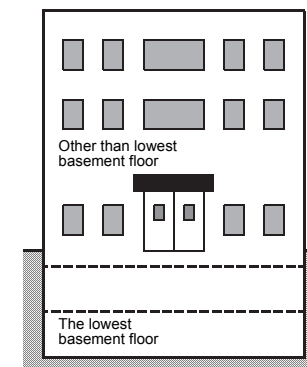
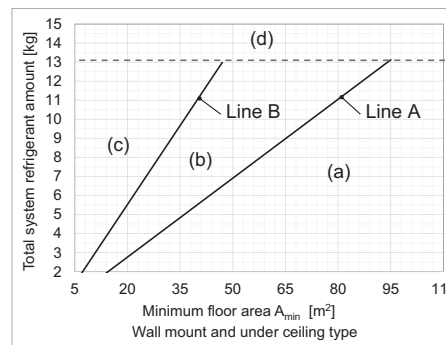
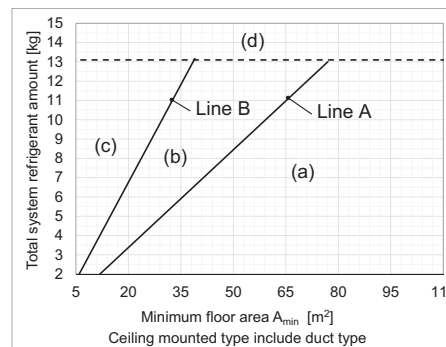

	Other than the lowest basement floor	The lowest floor of the basement	LFL threshold
Area (a)	No safety measured required.	No safety measured required.	A large space of LFL/4 or less.
Area (b)	Leak detector required.	Leak detector and safety shut-off valve required.	A large space of LFL/4 - LFL/2.
Area (c)	Leak detector and safety shut-off valve required.	Installation not permitted.	A narrow space of LFL/2 or more.
Area (d)	Installation not permitted.	Installation not permitted.	Maximum allowable total refrigerant amount determined from LFL

■ Line A

Minimum floor area A _{min} [m ²]	Total system refrigerant [kg]	
	Ceiling mounted type (include duct type)	Wall mount and under ceiling type
5	0.84	0.69
6	1.01	0.82
7	1.18	0.96
8	1.35	1.10
9	1.51	1.24
10	1.68	1.38
11	1.85	1.51
12	2.02	1.65
13	2.19	1.79
14	2.36	1.93
15	2.53	2.07
16	2.70	2.21
17	2.87	2.34
18	3.03	2.48
19	3.20	2.62
20	3.37	2.76
21	3.54	2.90
22	3.71	3.03
23	3.88	3.17
24	4.05	3.31
25	4.22	3.45
26	4.39	3.59
27	4.55	3.73
28	4.72	3.86
29	4.89	4.00
30	5.06	4.14
31	5.23	4.28
32	5.40	4.42
33	5.57	4.55
34	5.74	4.69
35	5.90	4.83
36	6.07	4.97
37	6.24	5.11
38	6.41	5.24
39	6.58	5.38
40	6.75	5.52
41	6.92	5.66
42	7.09	5.80
43	7.26	5.94
44	7.42	6.07
45	7.59	6.21
46	7.76	6.35
47	7.93	6.49
48	8.10	6.63
49	8.27	6.76
50	8.44	6.90
55	9.28	7.59
60	10.13	8.28
65	10.97	8.97
70	11.81	9.67
75	12.66	10.36
80	-	11.05
85	-	11.74
90	-	12.43
95	-	-

■ Line B

Minimum floor area A _{min} [m ²]	Total system refrigerant [kg]	
	Ceiling mounted type (include duct type)	Wall mount and under ceiling type
5	1.68	1.38
6	2.02	1.65
7	2.36	1.93
8	2.70	2.21
9	3.03	2.48
10	3.37	2.76
11	3.71	3.03
12	4.05	3.31
13	4.39	3.59
14	4.72	3.86
15	5.06	4.14
16	5.40	4.42
17	5.74	4.69
18	6.07	4.97
19	6.41	5.24
20	6.75	5.52
21	7.09	5.80
22	7.42	6.07
23	7.76	6.35
24	8.10	6.63
25	8.44	6.90
26	8.78	7.18
27	9.11	7.46
28	9.45	7.73
29	9.79	8.01
30	10.13	8.28
31	10.46	8.56
32	10.80	8.84
33	11.14	9.11
34	11.48	9.39
35	11.81	9.67
36	12.15	9.94
37	12.49	10.22
38	12.83	10.49
39	-	10.77
40	-	11.05
41	-	11.32
42	-	11.60
43	-	11.88
44	-	12.15
45	-	12.43
46	-	12.70
47	-	-
48	-	-
49	-	-
50	-	-
55	-	-
60	-	-
65	-	-
70	-	-
75	-	-
80	-	-
85	-	-
90	-	-
95	-	-

⚠ WARNING

- The total amount of refrigerant in the system must be less than or equal to the maximum allowable total amount of refrigerant.
The maximum allowable amount of refrigerant = 13.1 [kg].
- Keep the installation height according to the indoor unit type.
 - Ceiling-mounted unit (include Duct type.): 2.2 m or more.
 - Wall-mounted and under ceiling unit : 1.8 m or more.
 But install the indoor unit at least 2.5 m above the floor level since otherwise the users may injure themselves or receive electric shocks if they poke their fingers or other objects into the indoor unit while the air conditioner is running.

NOTE

- The maximum total amount of refrigerant allowed depends on the area of the room the system serves and the room on the lowest floor of the basement.
- Please confirm that the condition for total system refrigerant amount is satisfied for [5]
[To determine the limit on the amount of additional refrigerant].

If the installation becomes impossible in the condition of [1], redesign the system again.

[2] [Safety measures]

This unit is equipped with Leak Detectors and Shut-off Valve units for safety.
For each indoor unit, the number of safety devices varies depending on the installation floor, total system refrigerant amount, indoor unit installation height, and LFL value.
It's not necessary to install the safety devices when the air conditioning system is installed in a large space of LFL/4 or less.(each indoor room, outdoor area)

LD : Leak Detector
SV : Shut-off Valve units

Area	Safety system	Safety measures		Safety system operation	subsequent status
(a)	No safety measures	0 pc.	-	No safety system operation.	Not applicable
(a)(b)	Leak Detector only.	1 pc.	LD	When a leak is detected, operation stops.	Operation cannot be continued.
(a)(b)(c)	Pump-down operation.	2 pcs.	LD or SV unit	When a leak is detected, a system does Refrigerant recovery to outdoor unit by pump-down operation and closes all safety shut-off valves. After that, all systems stop.	Operation cannot be continued. (Refrigerant system will be locked.)
(a)(b)(c)	Individual shut-off	2 pcs.	LD or SV unit	When a leak is detected, safety shut-off valves close only for the indoor units which refrigerant is leaked. After that, all systems stop.	Operation cannot be continued only for the indoor units which refrigerant is detected. Other indoor units can continue to operate.

⚠ WARNING

- For Leak Detector to function, the unit shall be powered on at all times after installation, except during service.
- If LFL area is (c), install Battery kit in each applicable Shut-off Valve unit. They can shut-off the refrigerant by Battery kits even in the event of a power failure. (Make sure there are no leaks before use as charging may not be in time during a continuous system power off.)

NOTE

- If there are multiple indoor units with different safety systems in refrigerant system, safety system behaviors may be different in each indoor unit.

(Installation patterns for each safety measure)

The table below shows installation example of safety measures for each safety system.

Position where Leak Detector and Shut-off Valve unit can be installed is determined by room area, combination, indoor unit type and capacity, etc.

For details, refer to [3] [Leak Detector installation] and [4] [Shut-off Valve installation].

[Each safety system and installation example]

Indoor DN CODE No [107]	Installation example	Case
[00]		<ul style="list-style-type: none"> • When installing in a room corresponding to area (a), set the CODE No. [107] to [00]. No additional safety measures are required.
[01] or [02]		<ul style="list-style-type: none"> • When installing in a room corresponding to area (c), set the CODE No. [107] to [01] or [02]. • Be sure to install Leak Detector. • Be sure to connect the Shut-off Valve unit and install the battery unit. • When the CODE No. [107] is set to [01], the entire system will be stopped when refrigerant leakage is detected. • When the CODE No. [107] is set to [02], the corresponding indoor unit will be stopped when refrigerant leakage is detected (other indoor units can continue operation). • The position where the Shut-off Valve unit can be installed is different according to the setting of the CODE No. [107] ([01] or [02]).

Indoor DN CODE No [107]	Installation example	Case
[03]		<ul style="list-style-type: none"> • When the CODE No. [107] is set to [03] by area (b), the entire system stops when refrigerant leakage is detected. • Be sure to install Leak Detectors. This setting can only be used in rooms that fall under area (b).

a : Outdoor unit, b : Indoor unit, c : Leak Detector, d : Shut-off Valve unit, e : Battery kit

[3] [Leak Detector installation]

See Installation Manual included in Leak Detector for information on installing Leak Detector.

The Leak Detector implements have safety measures to light up in red and to sound a buzzer, that will warn in case of a refrigerant leak.

For the leak detector installation of R32 air conditioning system, check the following before installing.

⚠ WARNING

- Leak Detector used as a safety device for the air conditioning system shall be used the specified Toshiba optional product.
- Leak Detector installation shall be complied with the following requirements.
 1. Leak detector shall be installed in each room that requires a safety measure.
 2. The installation position shall be determined by the type and height of the indoor unit and the presence or the absence of obstacles between the indoor unit and Leak Detector.
- Leak Detector shall be installed outside the indoor unit within a height of 300 mm from the floor.
- Leak Detector shall be located within 10 m horizontal distance in line sight of the unit and on a wall within the room in which the unit is installed, or 7 m, if not in line sight of the unit, and on a wall within the room in which the unit is installed. The distance from the unit to Leak Detector shall be measured as the shortest horizontal unobstructed path between the unit and the nearest Leak Detector.
- The alarm shall always be 15 dB(A) louder than the room background noise. Leak Detector can generate a 65 dB(A) alarm. (Sound pressure level, measured at a distance of 1 m from the alarm.)
 If the surrounding environment is noisy in a particular room, we recommend that you use an external alarm (by local power supply) in that room.
 Leak Detector has output terminals to external ventilation and an external alarm.
 When taking safety measures using external ventilation or an external alarm, install according to the installation manual for Leak Detector.

[Installation positions of Leak Detector]

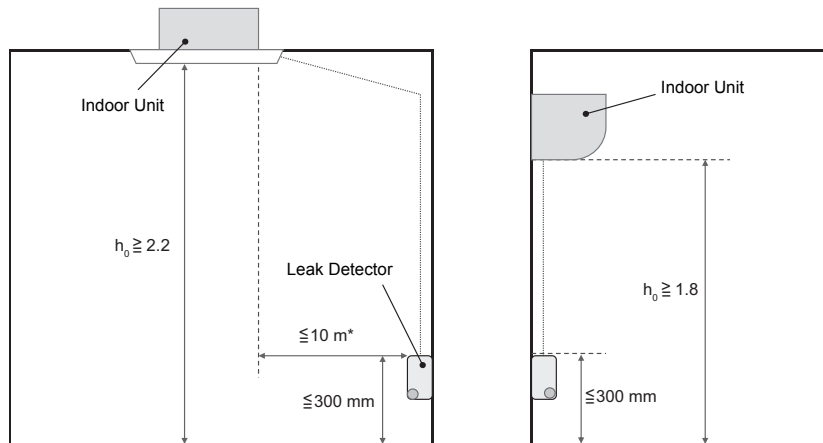

* It must be placed within a horizontal distance of 10 meters and on the wall in the room where the indoor unit is installed.
 However, when it does not enter the field of view on a straight line from Leak Detector, it is within 7 m at the shortest horizontal distance without obstacles and installed on the wall in the room where the indoor unit is installed.

NOTE

Leak Detector generates visual and auditory warnings.

[The examples for safety device installations]

The location of Leak Detector varies depending on the safety system and the room.

	Incorrect	Correct	Case
1			<ul style="list-style-type: none"> Install Leak Detector in same room as the connected indoor unit.
2			<ul style="list-style-type: none"> Group setting of indoor unit across Shut-off Valve unit is not possible
3			<ul style="list-style-type: none"> Only one Leak Detector can be connected to indoor units with a group setting.
4			<ul style="list-style-type: none"> Multiple Leak Detectors cannot be connected to one indoor unit.

a : Outdoor unit, b : Indoor unit, c : Leak Detector, d : Shut-off Valve unit, e : Battery kit

[4] [Shut-off valve unit installation]

For Shut-off Valve unit installation, see Installation Manual included in Shut-off Valve unit. The position where Shut-off Valve unit can be installed differs depending on the indoor unit, the setting of safety measures (pump down or individual shut-off), etc.

The installation position shall be determined according to the following.

If a Shut-off Valve unit is to be used as a safety measure, a Battery kit must be installed. For details, refer to the installation manual of Shut-off Valve unit.

■ Recovery by pump down (Set up the indoor DN CODE No. [107] to 1)

The allowable installation position differs depending on the length of the total connecting pipe.

- ◆ The total connection pipe length on the downstream side of Shut-off Valve unit is 10m.

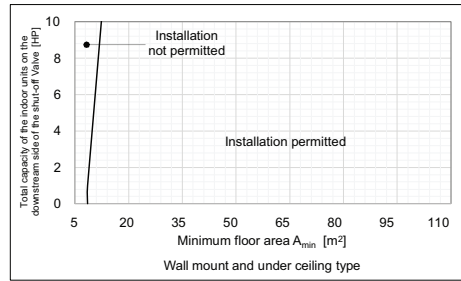
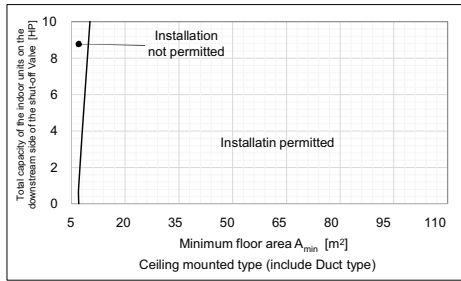

- ◆ The connection pipe length on the downstream side of the Shut-off Valve is 50m.

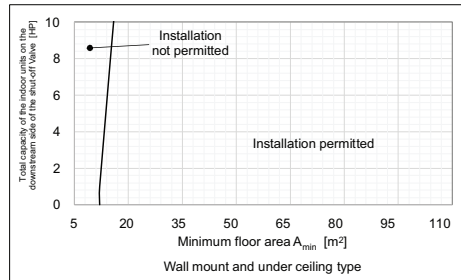
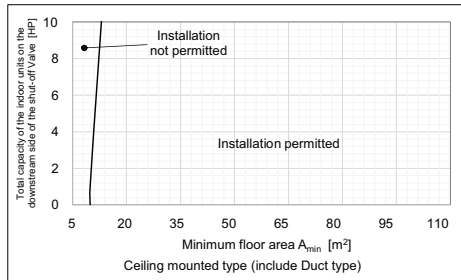

- ◆ The connection pipe length on the downstream side of the Shut-off Valve is 100m.

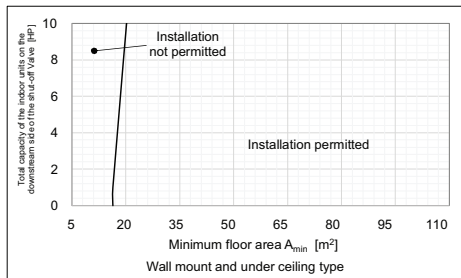
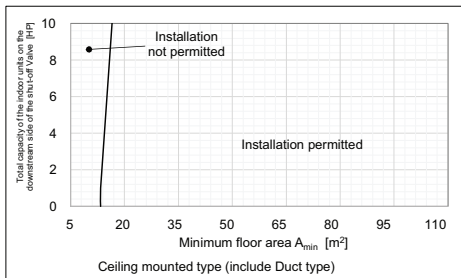

- ◆ The connection pipe length on the downstream side of the Shut-off Valve is 150m.

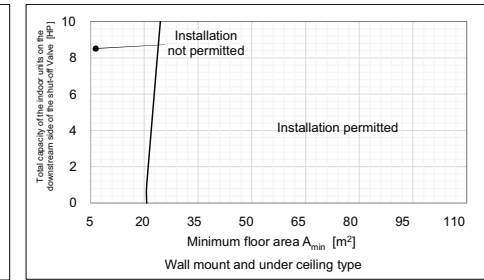
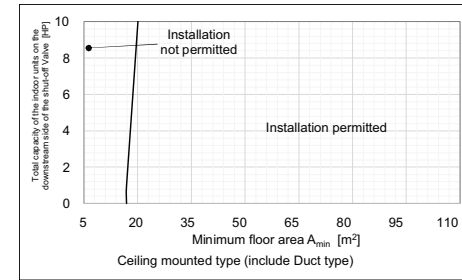

- ◆ The connection pipe length on the downstream side of the Shut-off Valve is 200m.

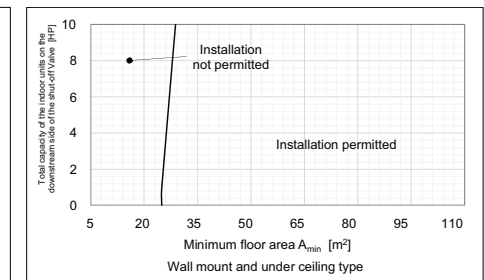
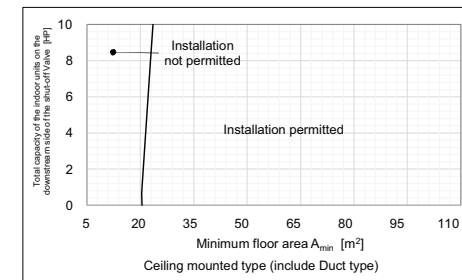

- ◆ The connection pipe length on the downstream side of the Shut-off Valve is 300m.

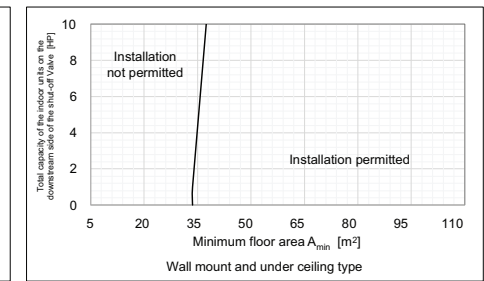
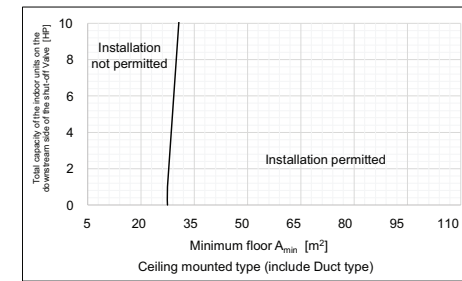

■ Installation position of Shut-off valve unit in case of recovery by pump down

◆ Ceiling mounted type (include Duct type)

Minimum floor area A_{min} [m ²]	Total connectable pipe length to the downstream side of Shut-off Valve unit [m]						
	Total capacity of indoor units on the downstream side of Shut-off Valve unit [HP]						
	1 HP*	2 HP	3 HP	4 HP	5 HP	6 HP	7.8 HP
5	-	-	-	-	-	-	-
6	-	-	-	-	-	-	-
7	9.6	4.6	-	-	-	-	-
8	23.7	18.8	13.8	8.8	3.8	-	-
9	37.9	32.9	28.0	23.0	18.0	13.0	4.0
10	52.1	47.1	42.1	37.1	32.2	27.2	18.2
11	66.3	61.3	56.3	51.3	46.3	41.4	32.4
12	80.5	75.5	70.5	65.5	60.5	55.5	46.6
13	94.6	89.7	84.7	79.7	74.7	69.7	60.7
14	108.8	103.8	98.8	93.9	88.9	83.9	74.9
15	123.0	118.0	113.0	108.0	103.0	98.1	89.1
16	137.2	132.2	127.2	122.2	117.2	112.2	103.3
17	151.3	146.4	141.4	136.4	131.4	126.4	117.4
18	165.5	160.5	155.6	150.6	145.6	140.6	131.6
19	179.7	174.7	169.7	164.7	159.8	154.8	145.8
20	193.9	188.9	183.9	178.9	173.9	169.0	160.0
21	208.1	203.1	198.1	193.1	188.1	183.1	174.2
22	222.2	217.3	212.3	207.3	202.3	197.3	188.3
23	236.4	231.4	226.4	221.5	216.5	211.5	202.5
24	250.6	245.6	240.6	235.6	230.6	225.7	216.7
25	264.8	259.8	254.8	249.8	244.8	239.8	230.8
26	278.9	274.0	269.0	264.0	259.0	254.0	245.0
27	293.1	288.1	283.2	278.2	273.2	268.2	259.2
28	300.0	300.0	297.3	292.3	287.4	282.4	273.4
29	300.0	300.0	300.0	300.0	300.0	296.6	287.6
30	300.0	300.0	300.0	300.0	300.0	300.0	300.0
31	300.0	300.0	300.0	300.0	300.0	300.0	300.0
32	300.0	300.0	300.0	300.0	300.0	300.0	300.0
33	300.0	300.0	300.0	300.0	300.0	300.0	300.0
34	300.0	300.0	300.0	300.0	300.0	300.0	300.0
35	300.0	300.0	300.0	300.0	300.0	300.0	300.0
36	300.0	300.0	300.0	300.0	300.0	300.0	300.0
37-110	300.0	300.0	300.0	300.0	300.0	300.0	300.0

* Including less than 1HP

◆ Wall mount and under ceiling type

Minimum floor area A_{min} [m ²]	Total connectable pipe length to the downstream side of Shut-off Valve unit [m]						
	Total capacity of indoor units on the downstream side of Shut-off Valve unit [HP]						
	1 HP*	2 HP	3 HP	4 HP	5 HP	6 HP	7.8 HP
5	-	-	-	-	-	-	-
6	-	-	-	-	-	-	-
7	-	-	-	-	-	-	-
8	3.1	-	-	-	-	-	-
9	14.7	9.7	4.8	-	-	-	-
10	26.3	21.3	16.4	11.4	6.4	1.4	-
11	37.9	32.9	28.0	23.0	18.0	13.0	4.0
12	49.5	44.5	39.6	34.6	29.6	24.6	15.6
13	61.1	56.1	51.2	46.2	41.2	36.2	27.2
14	72.7	67.7	62.8	57.8	52.8	47.8	38.8
15	84.3	79.3	74.4	69.4	64.4	59.4	50.4
16	95.9	90.9	86.0	81.0	76.0	71.0	62.0
17	107.5	102.5	97.6	92.6	87.6	82.6	73.6
18	119.1	114.1	109.2	104.2	99.2	94.2	85.2
19	130.7	125.7	120.8	115.8	110.8	105.8	96.8
20	142.3	137.3	132.4	127.4	122.4	117.4	108.4
21	153.9	148.9	144.0	139.0	134.0	129.0	120.0
22	165.5	160.5	155.6	150.6	145.6	140.6	131.6
23	177.1	172.1	167.2	162.2	157.2	152.2	143.2
24	188.7	183.7	178.8	173.8	168.8	163.8	154.8
25	200.3	195.3	190.4	185.4	180.4	175.4	166.4
26	211.9	206.9	202.0	197.0	192.0	187.0	178.0
27	223.5	218.5	213.6	208.6	203.6	198.6	189.6
28	235.1	230.1	225.2	220.2	215.2	210.2	201.2
29	246.7	241.7	236.8	231.8	226.8	221.8	212.8
30	258.3	253.3	248.4	243.4	238.4	233.4	224.4
31	269.9	264.9	260.0	255.0	250.0	245.0	236.0
32	281.5	276.5	271.6	266.6	261.6	256.6	247.6
33	293.1	288.1	283.2	278.2	273.2	268.2	259.2
34	300.0	299.7	294.8	289.8	284.8	279.8	270.8
35	300.0	300.0	300.0	300.0	296.4	291.4	282.4
36	300.0	300.0	300.0	300.0	300.0	300.0	294.0
37-110	300.0	300.0	300.0	300.0	300.0	300.0	300.0

* Including less than 1HP

■ Individual shut-off (Set up the indoor DN CODE No. [107] to 2)

The allowable installation position differs depending on the length of the total connecting pipe.

◆ The total connection pipe length on the downstream side of Shut-off Valve unit is 10m.

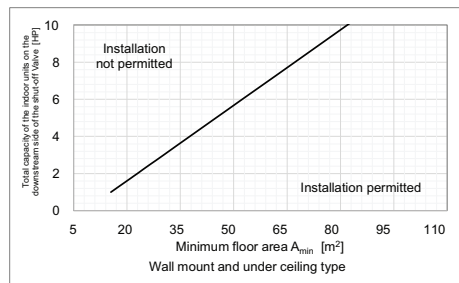
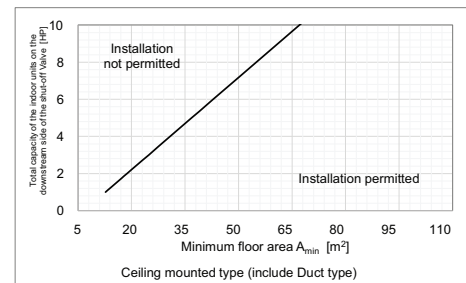

■ Installation position of Shut-off Valve unit in case of individual shut-off

◆ Ceiling mounted type (include Duct type)

Minimum floor area A_{min} [m ²]	Connectable pipe length to the downstream side of Shut-off Valve [m]						
	Total capacity of indoor units on the downstream side of Shut-off Valve [HP]						
	1 HP*	2 HP	3 HP	4 HP	5 HP	6 HP	7.8 HP
5	-	-	-	-	-	-	-
6	-	-	-	-	-	-	-
7	-	-	-	-	-	-	-
8	-	-	-	-	-	-	-
9	-	-	-	-	-	-	-
10	2.6	-	-	-	-	-	-
11	5.3	-	-	-	-	-	-
12	8.0	-	-	-	-	-	-
13	10.8	-	-	-	-	-	-
14	13.5	-	-	-	-	-	-
15	16.2	-	-	-	-	-	-
16	18.9	2.5	-	-	-	-	-
17	21.7	5.2	-	-	-	-	-
18	24.4	7.9	-	-	-	-	-
19	27.1	10.7	-	-	-	-	-
20	29.8	13.4	-	-	-	-	-
21	32.6	16.1	-	-	-	-	-
22	35.3	18.8	2.4	-	-	-	-
23	38.0	21.6	5.1	-	-	-	-
24	40.7	24.3	7.8	-	-	-	-
25	43.5	27.0	10.6	-	-	-	-
26	46.2	29.7	13.3	-	-	-	-
27	48.9	32.4	16.0	-	-	-	-
28	51.6	35.2	18.7	2.3	-	-	-
29	54.3	37.9	21.4	5.0	-	-	-
30	57.1	40.6	24.2	7.7	-	-	-
31	59.8	43.3	26.9	10.4	-	-	-
32	62.5	46.1	29.6	13.2	-	-	-
33	65.2	48.8	32.3	15.9	-	-	-
34	68.0	51.5	35.1	18.6	2.2	-	-
35	70.7	54.2	37.8	21.3	4.9	-	-
36	73.4	57.0	40.5	24.1	7.6	-	-
37	76.1	59.7	43.2	26.8	10.3	-	-
38	78.9	62.4	46.0	29.5	13.1	-	-
39	81.6	65.1	48.7	32.2	15.8	-	-
40	84.3	67.8	51.4	34.9	18.5	2.0	-
41	87.0	70.6	54.1	37.7	21.2	4.8	-
42	89.7	73.3	56.8	40.4	23.9	7.5	-
43	92.5	76.0	59.6	43.1	26.7	10.2	-
44	95.2	78.7	62.3	45.8	29.4	12.9	-
45	97.9	81.5	65.0	48.6	32.1	15.7	-
46	100.6	84.2	67.7	51.3	34.8	18.4	-
47	103.4	86.9	70.5	54.0	37.6	21.1	-
48	106.1	89.6	73.2	56.7	40.3	23.8	-
49	108.8	92.4	75.9	59.5	43.0	26.6	-
50	111.5	95.1	78.6	62.2	45.7	29.3	-
55	125.1	108.7	92.2	75.8	59.3	42.9	13.3
60	138.8	122.3	105.9	89.4	73.0	56.5	26.9
65	152.4	135.9	119.5	103.0	86.6	70.1	40.5
70	166.0	149.5	133.1	116.6	100.2	83.7	54.1
75	179.6	163.2	146.7	130.3	113.8	97.4	67.7
80	193.2	176.8	160.3	143.9	127.4	111.0	81.4
85	206.8	190.4	173.9	157.5	141.0	124.6	95.0
90	220.5	204.0	187.6	171.1	154.7	138.2	108.6
95	234.1	217.6	201.2	184.7	168.3	151.8	122.2
100	247.7	231.2	214.8	198.3	181.9	165.4	135.8
110	274.9	258.5	242.0	225.6	209.1	192.7	163.1

* Including less than 1HP

◆ Wall mount and under ceiling type

Minimum floor area A_{min} [m ²]	Connectable pipe length to the downstream side of Shut-off Valve [m]						
	Total capacity of indoor units on the downstream side of Shut-off Valve [HP]						
	1 HP*	2 HP	4 HP	5 HP	6 HP	7.8 HP	
5	-	-	-	-	-	-	
6	-	-	-	-	-	-	
7	-	-	-	-	-	-	
8	-	-	-	-	-	-	
9	-	-	-	-	-	-	
10	-	-	-	-	-	-	
11	-	-	-	-	-	-	
12	2.1	-	-	-	-	-	
13	4.3	-	-	-	-	-	
14	6.6	-	-	-	-	-	
15	8.8	-	-	-	-	-	
16	11.0	-	-	-	-	-	
17	13.2	-	-	-	-	-	
18	15.5	-	-	-	-	-	
19	17.7	1.3	-	-	-	-	
20	19.9	3.5	-	-	-	-	
21	22.2	5.7	-	-	-	-	
22	24.4	7.9	-	-	-	-	
23	26.6	10.2	-	-	-	-	
24	28.8	12.4	-	-	-	-	
25	31.1	14.6	0.4	-	-	-	
26	33.3	16.9	2.6	-	-	-	
27	35.5	19.1	4.9	-	-	-	
28	37.8	21.3	7.1	-	-	-	
29	40.0	23.5	9.3	-	-	-	
30	42.2	25.8	11.5	-	-	-	
31	44.4	28.0	13.8	-	-	-	
32	46.7	30.2	16.0	-	-	-	
33	48.9	32.4	18.2	-	-	-	
34	51.1	34.7	20.5	1.8	-	-	
35	53.4	36.9	22.7	4.0	-	-	
36	55.6	39.1	24.9	6.2	-	-	
37	57.8	41.4	27.1	8.5	-	-	
38	60.0	43.6	29.4	10.7	-	-	
39	62.3	45.8	31.6	12.9	-	-	
40	64.5	48.0	33.8	15.1	-	-	
41	66.7	50.3	36.0	17.4	0.9	-	
42	69.0	52.5	38.3	19.6	3.1	-	

Shut-off Valve unit Installation

When Shut-off Valve unit is installed, the allowable installation position differs depending on the total amount of refrigerant. The installation position shall be determined according to the following formula.

$$\diamond L_{\phi 9.52} + L_{\phi 6.35} / 3 \geq (m_c - 8) \times 14$$

$L_{\phi 9.52}$: Total length of $\phi 9.52$ liquid pipe between outdoor unit and Shut-off valve unit or indoor unit. [m]

$L_{\phi 6.35}$: Total length of $\phi 6.35$ liquid pipe between 1st branching section and Shut-off Valve unit or indoor unit. [m]

m_c : Total amount of refrigerant [kg]

*If the calculation indicates negative, replace it as 0.

Example: 060 type

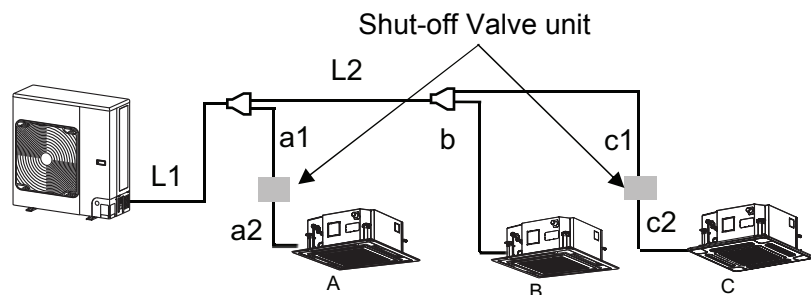

Liquid Pipe	
L1	9.52
L2	9.52
a1	9.52
a2	9.52
b	6.35
c1	6.35
c2	6.35

Indoor unit	
A	MMU-UP 0241HP*
B	MMU-UP0181HP*
C	MMU-UP0071MH*

$$L_{\phi 9.52} = L1 + L2 + a1$$

$$L_{\phi 6.35} = b + c1$$

* Notice that liquid pipe [b] is included.

[5] [To determine the limit on the amount of additional refrigerant]

Determine the smallest room area to calculate the total allowable refrigerant charge limit in the system. The area of the smallest room being served by the system is decided in the following contents to determine the maximum allowable total charge of the system.

- (1) The area of a room can be determined by projecting walls, doors and partitions onto the floor and calculating from the enclosed area.
- (2) Spaces connected by only false ceilings, ductwork, or similar connections shall not be considered a single space.
- (3) If the partition between 2 rooms on the same floor meets certain requirements then the rooms are considered as one room and the areas of the rooms may be added up. In this way, it is possible to increase the A_{min} value used to calculate the maximum allowed charge.

One of the following 2 requirements shall be met to add up room areas.

- 1) A room on the same floor, connected by a permanent opening that extends to the floor, and is intended for people to pass through, and can be considered as a single room.
- 2) Rooms on the same floor that are connected by openings that meet the following conditions can be considered as one room.

The opening shall consist of two parts to allow air circulation.

- $A_{min}(a) + A_{min}(b) \geq m_c / (0.25 \times LFL \times H) = m_c / 0.04605 \text{ (m}^2\text{)}$
- $Anv_{min} > 0.0123 \text{ [m}^2\text{]}$

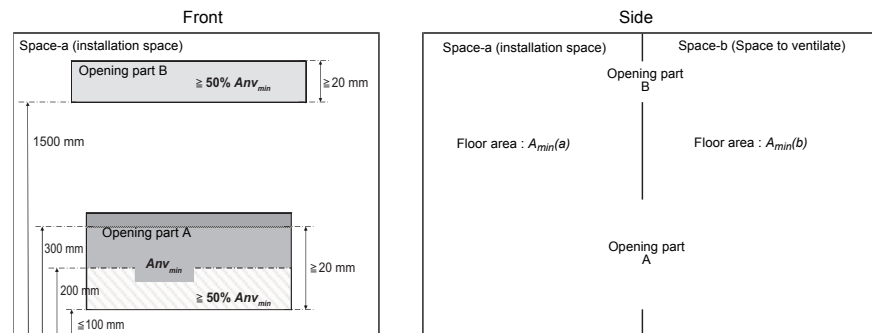

the opening can't be connected to the outdoors.

the opening can't be closed.

the lower opening shall be $\geq 0.012 \text{ m}^2$ (minimum opening area for natural ventilation [Anv_{min}]).

Areas of openings greater than 300 mm from the floor are not included in the calculation when determining Anv_{min} .

50% of Anv_{min} or more is less than 200 mm from the floor.

the bottom of the bottom opening is 100 mm or less from the floor the height of the opening is $\geq 20 \text{ mm}$.

For the upper opening :

the opening can't be connected to the outdoors.

the opening can't be closed.

the upper opening shall be $\geq 0.006 \text{ m}^2$ (50% of Anv_{min}).

The bottom of the upper opening shall be at least 1500 mm from the floor.

the height of the opening is $\geq 20 \text{ mm}$.

Note) The requirements for the upper opening can be met by a drop ceiling, ventilation ducts, or similar arrangements that provide airflow between connected rooms.

- (4) Connect both the air inlet and outlet directly to the same room.
- (5) Do not use a space such as a false ceiling as the air inlet or the outlet of the duct.
- (6) There shall be no auxiliary device (for example, an electric switch device whose surface is 700°C) that can be a potential ignition source in the duct work.
- (7) Only equipment approved by the manufacturer shall be used for duct work.

CAUTION

For appliances connected via an air duct system to one or more rooms using an A2L refrigerant



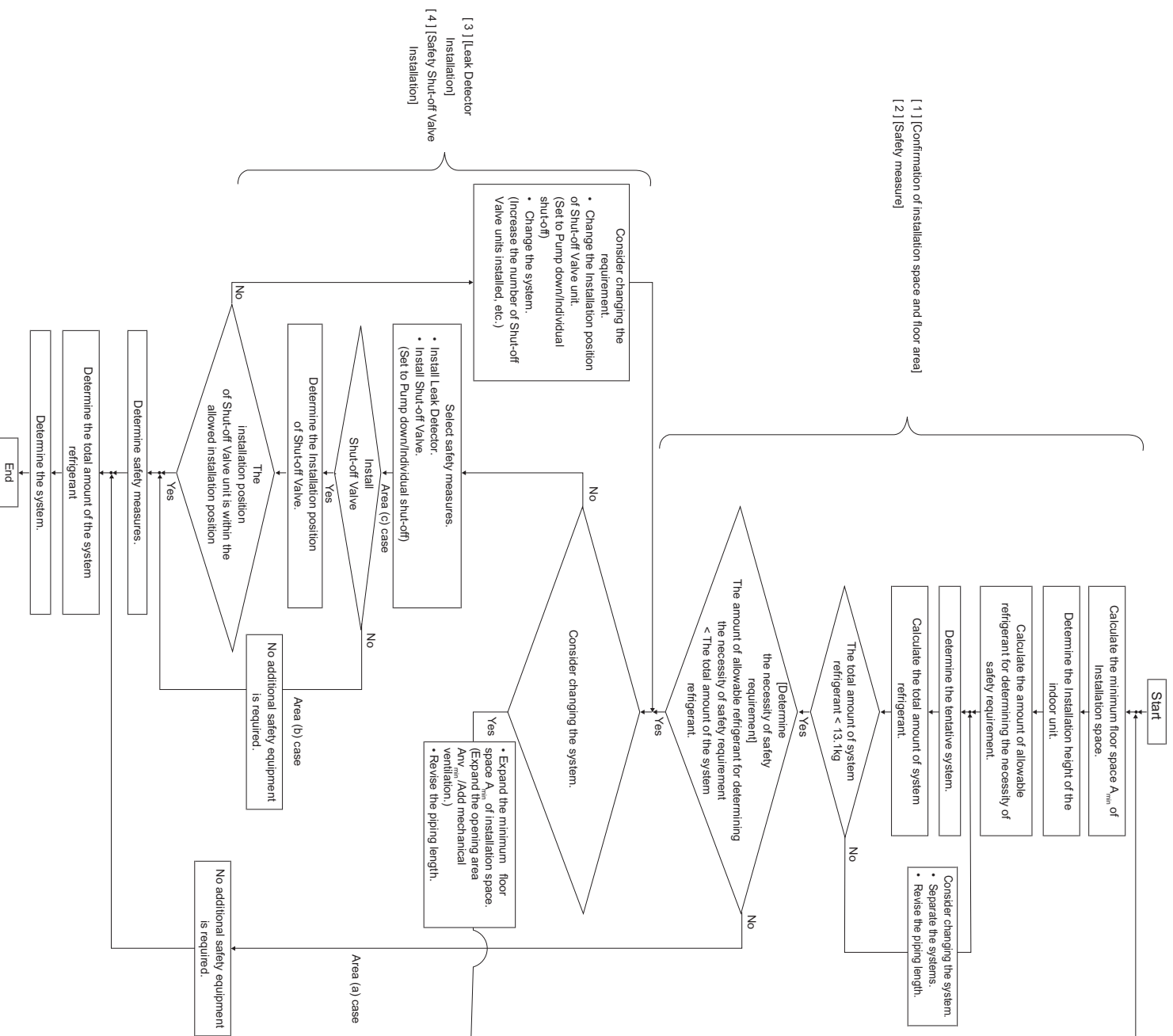

- which include a separate section with refrigerant containing components except pipes (e.g. compressors, condensers), and
 - which are isolated from the airflow and located in a room smaller than minimum floor area [A_{min}] then IEC60335-2-40 Clause GG.4 (ventilated enclosure) can be applied, where the required ventilation can be provided by the ventilation system.
- That section shall have an opening to the outdoor or indoor air-stream to be able to ventilate the refrigerant to an area in compliance with Annex GG.
-

Safety measure selection flow

Based on the installation conditions calculated above, determine the installation specifications according to the following safety measure selection flow.



3 Accessory parts

Part name	Q'ty	Shape	Usage
Owner's Manual	1		Hand this directly to the customer
Installation Manual	1		Hand this directly to the customer
CD-ROM	1	-	Owner's Manual and Installation Manual in other languages
WEEE Manual WEEE Waste electrical and electronic equipment	1		Hand this directly to the customer
F-Gas label	1		A label that describes the amount of refrigerant
Protection sheet	1		Seal to protect the F-gas label
Cable tie	2	-	Fix the power and communication lines

* For other languages that do not appear in this Installation Manual, please refer to the enclosed CD-ROM.

4 Installation of R32 refrigerant air conditioner

CAUTION

R32 refrigerant air conditioner installation

• This air conditioner adopts the HFC refrigerant (R32) which does not destroy ozone layer.

Therefore, during installation work, make sure that water, dust, former refrigerant, or refrigerant oil does not enter the R32 refrigerant air conditioner cycle. To prevent mixing of refrigerant or refrigerant oil, the sizes of connecting sections of charge port on the main unit and installation tools are different from those of the conventional refrigerant units. Accordingly, special tools are required for the R32 or R410A refrigerant units. For connecting pipes, use new and clean piping materials with high pressure fittings made for the R32 or R410A only, so that water and/or dust does not enter.













■ Required tools/equipment and precautions for use

Prepare the tools and equipment listed in the following table before starting the installation work. Newly prepared tools and equipment must be used exclusively.

Symbol

 : Conventional tools (R32 or R410A)

 : Prepared newly (Use for R32 only)

Tools / equipment	Use	How to use tools / equipment
Gauge manifold	Vacuuming, charging refrigerant and operation check	 Conventional tools (R32 or R410A)
Charging hose		 Conventional tools (R32 or R410A)
Charging cylinder	Cannot be used	Unusable (Use the Refrigerant charging balance.)
Gas leak detector	Charging refrigerant	 Prepared newly (Use for R32 only)
Vacuum pump	Vacuum drying	 Conventional tools (R32 or R410A) Usable if the backflow prevention adapter is installed.
Vacuum pump with backflow prevention function	Vacuum drying	 Conventional tools (R32 or R410A)
Flare tool	Flare machining of pipes	 Conventional tools (R32 or R410A)
Bender	Bending pipes	 Conventional tools (R32 or R410A)
Refrigerant recovery equipment	Refrigerant recovery	 Conventional tools (R32 or R410A)
Torque wrench	Tightening flare nut	 Conventional tools (R32 or R410A)
Pipe cutter	Cutting pipes	 Conventional tools (R32 or R410A)
Refrigerant cylinder	Charging refrigerant	 Prepared newly (Use for R32 only)
Brazing machine and nitrogen cylinder	Brazing pipes	 Conventional tools (R32 or R410A)
Electronic refrigerant charging scale	Charging refrigerant	 Conventional tools (R32 or R410A)

EN

5 Installation conditions

■ Before installation

Be sure to prepare to the following items before installation.

◆ Airtight test

- 1 Before starting an airtight test, further tighten the spindle valves on the gas and liquid sides.
- 2 Pressurize the pipe with nitrogen gas charged from the service port to the design pressure to conduct an airtight test.
- 3 After the airtight test is completed, evacuate the nitrogen gas.

◆ Air purge

- To purge air, use a vacuum pump.
- Do not use refrigerant charged in the outdoor unit to purge air. (The air purge refrigerant is not contained in the outdoor unit.)

◆ Electrical wiring

Be sure to fix the power wires, system interconnecting wires and remote controller wires with clamps so that they do not come into contact with the cabinet, etc.

◆ Earthing

WARNING

Make sure that proper earthing is provided.

Improper earthing may cause an electric shock. For details on how to check earthing, contact the dealer who installed the air conditioner or a professional installation company.

- Proper earthing can prevent charging of electricity on the outdoor unit surface due to the presence of a high frequency in the frequency converter (inverter) of the outdoor unit, as well as prevent electric shock. If the outdoor unit is not properly earthed, you may be exposed to an electric shock.
- **Be sure to connect the earth wire (grounding work).**
Incomplete earthing can cause an electric shock.
Do not connect earth wires to gas pipes, water pipes, lightning rods or earth wires for telephone wires.

◆ Test run

Turn on the leakage breaker at least 12 hours before starting a test run to protect the compressor.

CAUTION

Incorrect installation work may result in a malfunction or complaints from customers.

■ Installation location

WARNING

Install the outdoor unit properly in a location that is durable enough to support the weight of the outdoor unit.
Insufficient durability may cause the outdoor unit to fall, which may result in injury.
Pay special attention when installing the unit onto a wall surface.

CAUTION

Do not install the outdoor unit in a location that is subject to combustible gas leaks.
Accumulation of combustible gas around the outdoor unit may cause a fire.

Install the outdoor unit in a location that meets the following conditions after the customer's consent is obtained.

- A well-ventilated location free from obstacles near the air intake and air discharge
- A location that is not exposed to rain or direct sunlight
- A location that does not increase the operating noise or vibration of the outdoor unit
- A location that does not produce any drainage problems from discharged water

Do not install the outdoor unit in the following locations.

- A location with a saline atmosphere (coastal area) or one that is full of sulfide gas (hot-spring area) (Special maintenance is required.)
- A location subject to oil, vapor, oily smoke, or corrosive gases
- A location in which organic solvent is used
- Places where iron or other metal dust is present. If iron or other metal dust adheres to or collects on the interior of the air conditioner, it may spontaneously combust and start a fire.
- A location where high-frequency equipment (including inverter equipment, private power generator, medical equipment, and communication equipment) is used
(Installation in such a location may cause malfunction of the air conditioner, abnormal control or problems due to noise from such equipment.)
- A location in which the discharged air of the outdoor unit blows against the window of a neighboring house
- A location where the operating noise of the outdoor unit is transmitted
- When the outdoor unit is installed in an elevated position, be sure to secure its fixing leg.
- A location in which drain water poses any problems.
- When collectively draining discharged water completely, use a drain pan.

CAUTION

1. Install the outdoor unit in a location where the discharge air is not blocked.
2. When an outdoor unit is installed in a location that is always exposed to strong winds like a coast or on the high stories of a building, secure normal fan operation by using a duct or wind shield.
3. When installing the outdoor unit in a location that is constantly exposed to strong winds such as on the upper stairs or rooftop of a building, apply the wind-proofing measures referred to in the following examples.
 - 1) Install the unit so that its discharge port faces the wall of the building. Keep a distance 500 mm or more between the unit and wall surface.

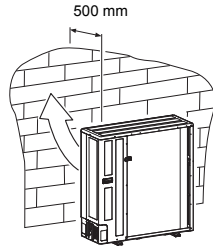

- 2) Consider the wind direction during the operational season of the air conditioner, and install the unit so that the discharge port is set at a right angle relative to the wind direction.

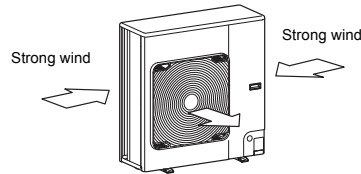

4. When installing the unit in an area where snowfalls may be heavy, take steps to prevent the unit from being adversely affected by the fallen or accumulated snow.
 - Either make the foundation higher or install a stand (which is high enough to ensure that the unit will be above the fallen or accumulated snow) and place the unit on it.
 - Attach a snow shield (locally procured).

<Example>

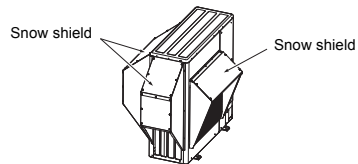

Necessary space for installation

Be sure to observe the necessary space for installation

Installation the outdoor unit in a well-ventilated location.

Failure to do so may cause short-circuit (intake of discharge air) or performance deterioration due to locations around the outdoor unit.

Single unit installation

When there is an obstacle on the back side
(Front, sides, and top are free)

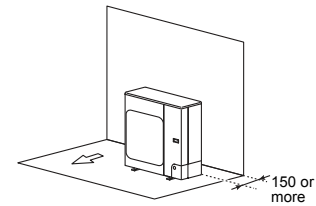

When there is an obstacle on the front side
(Back, sides, and top are free)

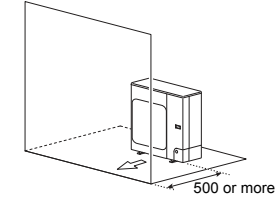

When there are obstacles on the front and back sides
(Sides and top are free)

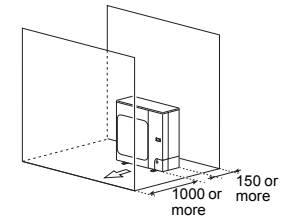

When there are obstacles on the top and front sides
(Back and sides are free)

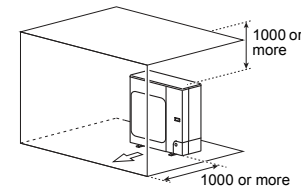

When there are obstacles on the back and top sides
(Front and sides are free)

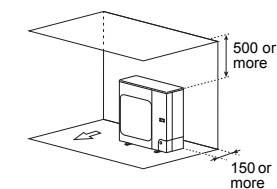

When there are obstacles on the back and sides
(Front and top are free)
* The height of the obstacle should be lower than that of the outdoor unit.

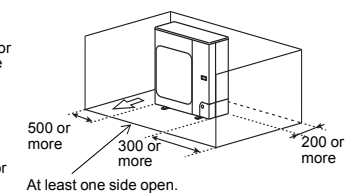

Serial unit installation

* When the outdoor temperature is high, the cooling capability may be decreased because of an equipment protection operation.

When there is an obstacle on the back side
(Front, sides, and top are free)

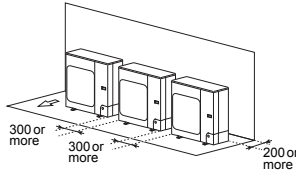

When there are obstacles on the back and top sides
(Front and sides are free)

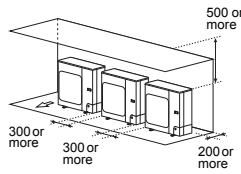

When there is an obstacle on the front side
(Back, sides, and top are free)

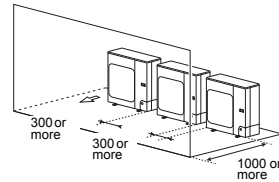

When there are obstacles on the back and sides
(Front and top are free)

* The height of the obstacle should be lower than that of the outdoor unit.

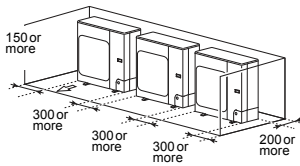

When there are obstacles on the front and back sides
(Sides and top are free)

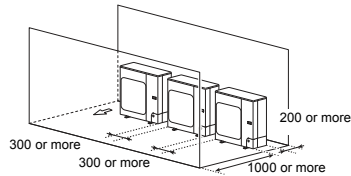

Single unit multiple-row installation
(Top and both sides are free)

* The height of the obstacle should be lower than that of the outdoor unit.

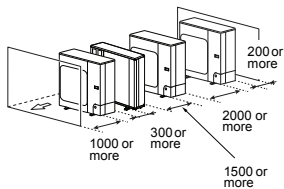

Multiple unit multiple-row installation
(Top, both sides, and front are free)

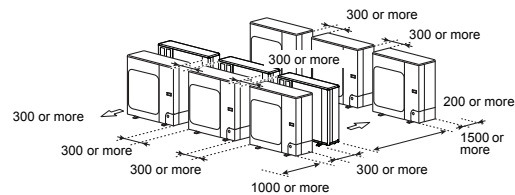

Installation of outdoor unit

- Before installation, check the strength and horizontalness of the base so that abnormal sounds do not emanate.
- According to the following base diagram, fix the base firmly with the anchor bolts.
(Anchor bolt, nut: M10 x 4 pairs)

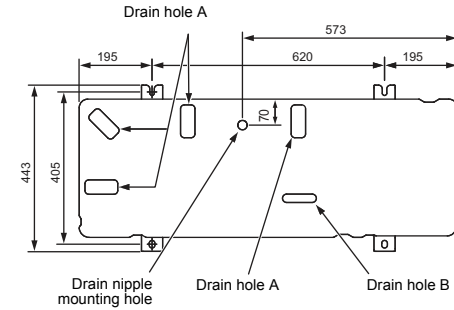

- As shown in the figure below, install vibration-proof rubber pads to directly support the bottom surface of the fixing leg.
- * When installing the foundation for an outdoor unit with downward piping, consider the piping work.

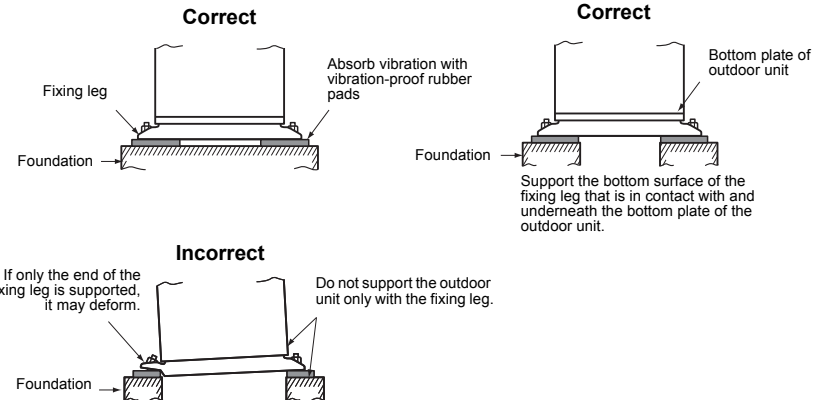

Set the out margin of the anchor bolt to 15 mm or less.

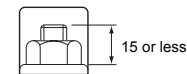

CAUTION

- Carry out the installation work by following the prescribed procedure to make provision against the shaking of the unit caused by strong winds, earthquakes, etc.
- Failure to carry out the installation work as prescribed may lead to the unit tipping over, in turn causing an accident.

When water is to be drained through the drain hose, attach the following drain nipple and waterproof rubber cap (Optional accessory), and use the drain hose (Inner diameter: 16 mm) sold on the market. Also seal knockout hole and the screws securely with silicone material, etc., to prevent water from leaking.

Some conditions may cause dewing or dripping of water.

When collectively draining discharged water completely, use a drain pan.

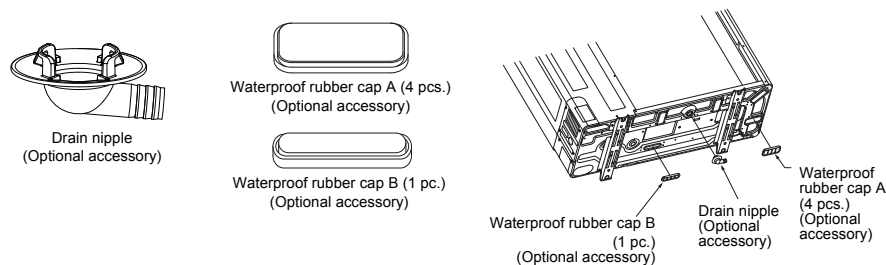

For reference

If a heating operation is to be continuously performed for a long time under the condition that the outdoor temperature is 0 °C or lower, draining defrosted water may be difficult due to the bottom plate freezing, resulting in trouble with the cabinet or fan.

It is recommended to procure an anti-freeze heater locally in order to safely install the air conditioner. For details, contact the dealer.

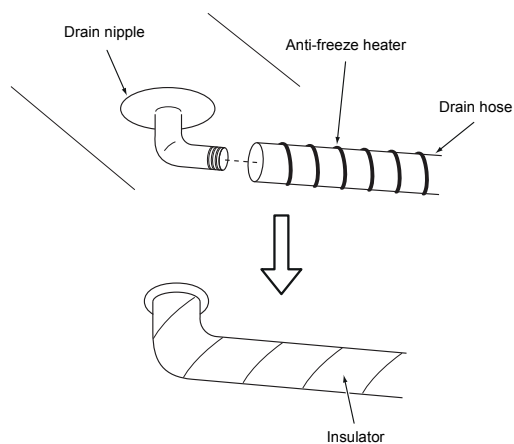

6 Refrigerant piping

CAUTION

Do NOT turn on power to Shut-off Valve units until following work is completed. If power turned off after turned it on, valves of the Shut-off Valve units will close and there is risk of air entering the refrigerant piping.

- Connection of refrigerant pipe
- Airtightness test
- Vacuum drying
- Adding refrigerant

If power turned on before the work is completed, keep power on while working.

Removing service panel

- Remove the screws at 3 locations and slide the service panel down. Next, detach the right-side claws followed by left-side claws to remove the service panel.

When doing this, pulling the service panel towards the front could damage the claws.

When attaching the service panel, attach the left claws followed by the right claws and lift the service panel upwards and secure it with screws in the 3 locations.

- The indoor/outdoor connecting pipes can be connected in 4 directions. Take off the knockout part of the pipe cover through which pipes or wires will pass through the base plate.

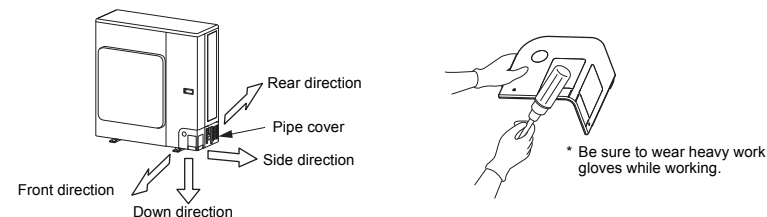
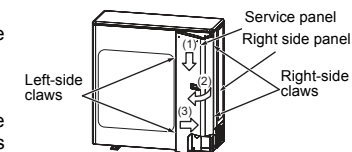

Knockout of pipe cover

- Detach the pipe cover and tap on the knockout section a few times with the shank of a screwdriver. A knockout hole can easily be punched.
- After punching out the knockout hole, remove burrs from the hole and guard material around the passage hole to protect wires and pipes. Be sure to attach the pipe covers after pipes have been connected. Cut the slits under the pipe covers to facilitate the installation. After connecting the pipes, be sure to mount the pipe cover. The pipe cover is easily mounted by cutting off the slit at the lower part of the pipe cover.

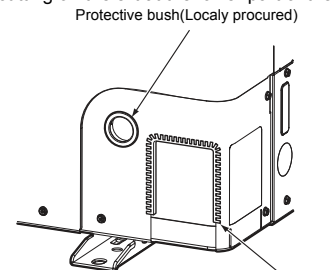

- * Attach the guard material securely so that it does not come loose.

Remove dust and moisture inside the connecting pipes

- For connecting pipes, use new and clean piping materials so that water or dust does not enter.

Refrigerant piping connection

CAUTION

Take note of these 4 important points below for piping work

1. Keep dust and moisture away from inside the connecting pipes.
2. Tightly connect the connection between pipes and the unit.
3. Evacuate the air in the connecting pipes using a VACUUM PUMP.
4. Check for gas leaks at connection points.

Flaring

1. Cut the pipe with a pipe cutter.

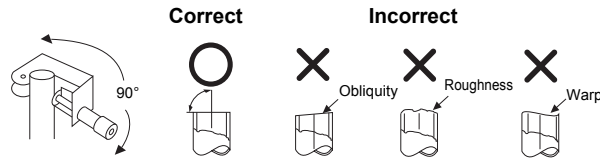

2. Remove the burr inside of the pipe.

When removing the burr, be careful so that chips do not fall into the pipe.

3. Remove the flare nuts attached to the outdoor / indoor unit, then insert them into each of the pipes.

4. Flare the pipes.

See the following table for the projection margin (A) and flaring size (B).

*The conventional tools can be used by adjusting the projection margin of the copper pipe.

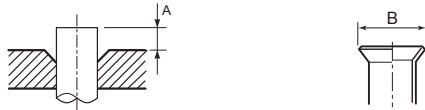

Pipe		A		B	Flare Nut		
Outside diameter	Thickness	Rigid (clutch type) R32 or R410A tool	Conventional (wing nut type) tool	Width across flat	Tighten torque		
mm	mm	mm	mm		N·m	kgf·m	
6.35	0.8	0 to 0.5	1.0 to 1.5	9.9	17	14 to 18	1.4 to 1.8
9.52	0.8	0 to 0.5	1.0 to 1.5	13.2	22	33 to 42	3.3 to 4.2
12.70	0.8	0 to 0.5	1.0 to 1.5	16.6	26	50 to 62	5.0 to 6.2
15.88	1.0	0 to 0.5	1.0 to 1.5	19.7	29	68 to 82	6.8 to 8.2

REQUIREMENT

- For a brazing work of the refrigerant pipes, be sure to use nitrogen gas in order to prevent oxidation of the inside of the pipes; otherwise clogging of the refrigerating cycle due to oxidized scale may occur.
- Use clean and new pipes for the refrigerant pipes and perform piping work so that water or dust does not contaminate the refrigerant.

* Remove all flux after brazing.

- Be sure to use a double spanner to loosen or tighten the flare nut. If a single spanner is used, the required level of tightening cannot be obtained. Tighten the flare nut with the specified torque.
- Do not apply refrigerant oil to the surface of the flare.

Coupling size of brazed pipe

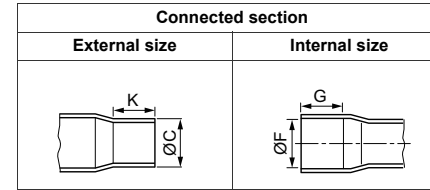

(Unit: mm)

Standard outer dia. of connected copper pipe	Connected section				Oval value	Min. thickness of coupling
	External size	Internal size	Min. depth of insertion			
	Standard outer dia. (Allowable difference)		K	G		
	C	F				
6.35	6.35 (±0.03)	6.45 (+0.04/-0.02)	7	6	0.06 or less	0.50
9.52	9.52 (±0.03)	9.62 (+0.04/-0.02)	8	7	0.08 or less	0.60
12.70	12.70 (±0.03)	12.81 (+0.04/-0.02)	9	8	0.10 or less	0.70
15.88	15.88 (±0.03)	16.00 (+0.04/-0.02)	9	8	0.13 or less	0.80

■ Selection of pipe materials and size

◆ Selection of pipe material

Material: Phosphorus deoxidation seam-less pipe

Minimum wall thickness for R32 application

Table 1

Soft	Half Hard or Hard	OD (Inch)	OD (mm)	Minimum wall thickness (mm)
OK	OK	1/4"	6.35	0.80
OK	OK	3/8"	9.52	0.80
OK	OK	1/2"	12.70	0.80
OK	OK	5/8"	15.88	1.00

◆ Capacity code of indoor and outdoor units

- For the indoor unit, the capacity code is decided at each capacity rank.
- The capacity codes of the outdoor units are decided at each capacity rank.
The maximum No. of connectable indoor unit and the total value of capacity codes of the indoor units are also decided.

Table 2

Indoor unit capacity type	Capacity code	
	Equivalent to HP	Equivalent to capacity
003 type	0.3	0.9
005 type	0.6	1.7
007 type	0.8	2.2
008 type	0.9	2.5
009 type	1.0	2.8
010 type	1.1	3.2
012 type	1.25	3.6
014 type	1.5	4.0
015 type	1.7	4.5
017 type	1.85	5.0
018 type	2.0	5.6
020 type	2.25	6.3
024 type	2.5	7.1
027 type	3.0	8.0
030 type	3.2	9.0
034 type	3.6	10.0
036 type	4.0	11.2
042 type	4.5	12.5
048 type	5.0	14.0
056 type	6.0	16.0

Table 3

Outdoor unit capacity type	Capacity code		No. of connectable indoor units	Total capacity code of connectable indoor units	
	Equivalent to HP	Equivalent to capacity [kW]		Min. (HP)	Max. (HP)
0401 type	4	12.1	2 to 8	3.2	5.2
0501 type	5	14.0	2 to 10	4.0	6.5
0601 type	6	15.5	2 to 13	4.8	7.8

When only 003 type (0.3HP) indoor units are connected, refer to the table below.

Table 4

Outdoor unit capacity type	Capacity code		No. of connectable indoor units	Total capacity code of connectable indoor units	
	Equivalent to HP	Equivalent to capacity [kW]		Min. (HP)	Max. (HP)
0401 type	4	12.1	4 to 8	1.2	2.4
0501 type	5	14.0	4 to 10	1.2	3.0
0601 type	6	15.5	4 to 13	1.2	3.9

■ Selection of refrigerant piping

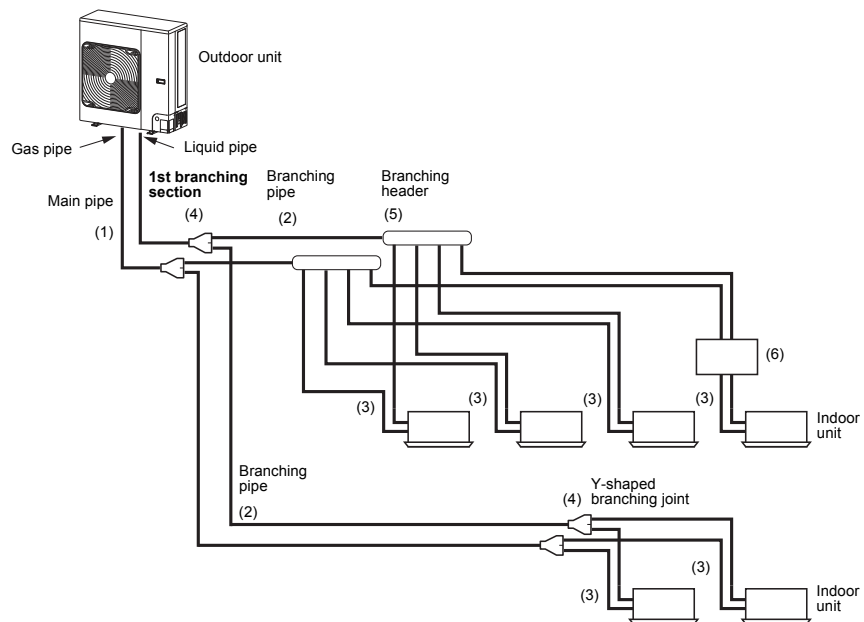

No.	Piping parts	Name	Selection of pipe size				
(4)	Branching section	Y-shaped branching joint	Selection of branching section (Y-shaped branching joint)				
					Model name		
			Y-shape branching joint	RBM-BY55E			
(5)	Branching section	Branching header	Selection of branching section (Branching header)				
					Model name		
			Branching header*1	For 4 branches	RBM-HY1043E		
				For 8 branches	RBM-HY1083E		
* A capacity code of up to a maximum of 6.0 HP is connectable to one line after branching from the header.							
(6)	Shut-off Valve unit	Shut-off Valve unit	Selection of Shut-off Valve unit				
			Total capacity code of indoor units at downstream side	Model name	Gas pipe	Liquid pipe	Maximum number of connectable indoor units
			Below 4.0	RBM-SV1121HUPE	12.70	9.52	6
			4.0 or more	RBM-SV1801HUPE	15.88	9.52	10

No.	Piping parts	Name	Selection of pipe size (Unit: mm)				Remarks		
(1)	Outdoor unit ↓ 1st branching section	Main pipe	Connecting pipe size of outdoor unit				Same as connecting pipe size of the outdoor unit.		
			Out door unit capacity type	Gas pipe	Liquid pipe				
						0401 type		15.88	9.52
						0501 type		15.88	9.52
0601 type	15.88	9.52							
(2)	Branching section ↓ Branching section	Branching pipe	Pipe size between branching sections				Pipe size differs based on the total capacity code value of indoor units at the downstream side. If the total value exceeds the capacity code of the outdoor unit, apply the capacity code of the outdoor unit. (See Table 1 and 2.)		
			Total capacity codes of indoor units at downstream side		Gas pipe	Liquid pipe			
			Equivalent to HP	Equivalent to capacity [kW]					
			Below 2.4	Below 6.6	12.70	9.52			
			2.4 or more	6.6 or more	15.88	9.52			
* When exceed the main pipe size, use the same size as the main pipe.									
(3)	Branching section ↓ Indoor unit	Indoor unit connecting pipe	Connecting pipe size of indoor unit						
			Capacity type	Gas pipe	Liquid pipe				
						003 to 012 type		9.52	6.35
						014 to 018 type		12.70	6.35
020 to 056 type	15.88	9.52							

■ Selection of refrigerant piping for quiet place (with PMV Kit)

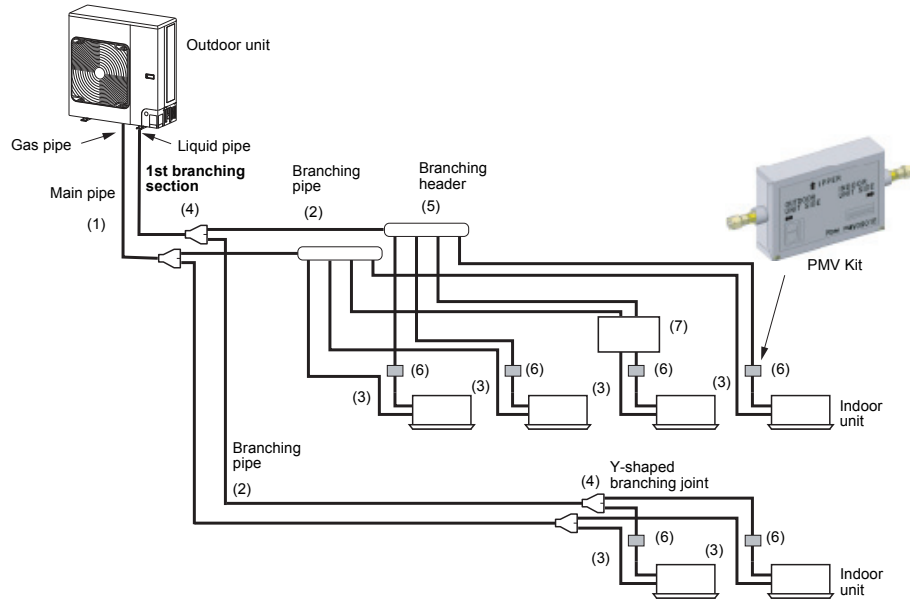

No.	Piping parts	Name	Selection of pipe size (Unit: mm)	Remarks		
(1)	Outdoor unit ↓ 1st branching section	Main pipe	Connecting pipe size of outdoor unit			
			Out door unit capacity type	Gas pipe	Liquid pipe	
			0401 type	15.88	9.52	
			0501 type	15.88	9.52	
			0601 type	15.88	9.52	
(2)	Branching section ↓ Branching section	Branching pipe	Pipe size between branching sections			
			Total capacity codes of indoor units at downstream side		Gas pipe	Liquid pipe
			Equivalent to HP	Equivalent to capacity [kW]		
			Below 2.4	Below 6.6	12.70	9.52
2.4 or more	6.6 or more	15.88	9.52			
* When exceed the main pipe size, use the same size as the main pipe.						
(3)	Branching section ↓ Indoor unit	Indoor unit connecting pipe	Connecting pipe size of indoor unit			
			Capacity type	Gas pipe	Liquid pipe	
			003 to 012 type	9.52	6.35	
			014 to 018 type	12.70	6.35	
			020 to 056 type	15.88	9.52	

No.	Piping parts	Name	Selection of pipe size				
(4)	Branching section	Y-shaped branching joint	Selection of branching section (Y-shaped branching joint)				
				Model name			
			Y-shape branching joint	RBM-BY55E			
(5)	Branching section	Branching header	Selection of branching section (Branching header)				
				Model name			
			Branching header*1	For 4 branches RBM-HY1043E For 8 branches RBM-HY1083E			
* A capacity code of up to a maximum of 6.0 HP is connectable to one line after branching from the header.							
(6)	PMV Kit	PMV Kit	Selection of PMV Kit				
			Capacity rank	Model name			
			003 to 014 type	RBM-PMV0361U-E			
			015 to 034 type	RBM-PMV0901U-E			
PMV kit can be connected less than 034 type indoor unit.							
(7)	Shut-off Valve unit	Shut-off Valve unit	Selection of Shut-off Valve unit				
			Total capacity code of indoor units at downstream side	Model name	Gas pipe	Liquid pipe	Maximum number of connectable indoor units
			Below 4.0	RBM-SV1121HUPE	12.70	9.52	6
			4.0 or more	RBM-SV1801HUPE	15.88	9.52	10

◆ Allowable length / height difference of refrigerant piping

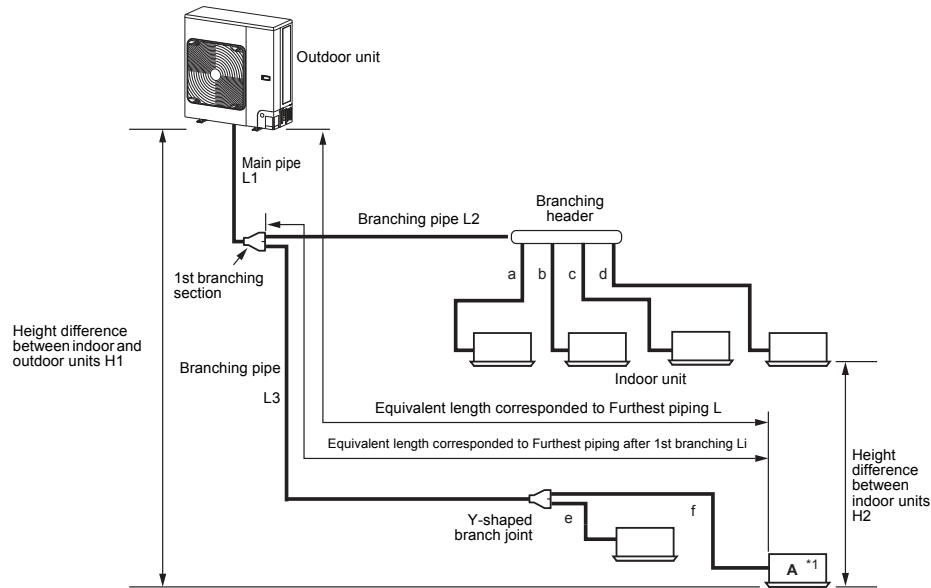

		Allowable value	Pipes
Piping Length	Total extension of pipe (liquid pipe, real length)	300 m	$L1 + L2 + L3 + a + b + c + d + e + f$
	Furthest piping length L (*1)	Real length	120 m
		Equivalent length	150 m
	Max. equivalent length of main pipe	80 m	L1
	Max. equivalent length of furthest piping from 1st branching Li (*1)	40 m	$L3 + f$
Height Difference	Height between indoor and outdoor units H1	Upper outdoor unit	50 m
		Lower outdoor unit	40 m
	Height between indoor units H2	15 m	—

*1: Furthest indoor unit from 1st branch to be named "A".

◆ Allowable length / height difference of refrigerant piping for quiet places (with PMV Kit)

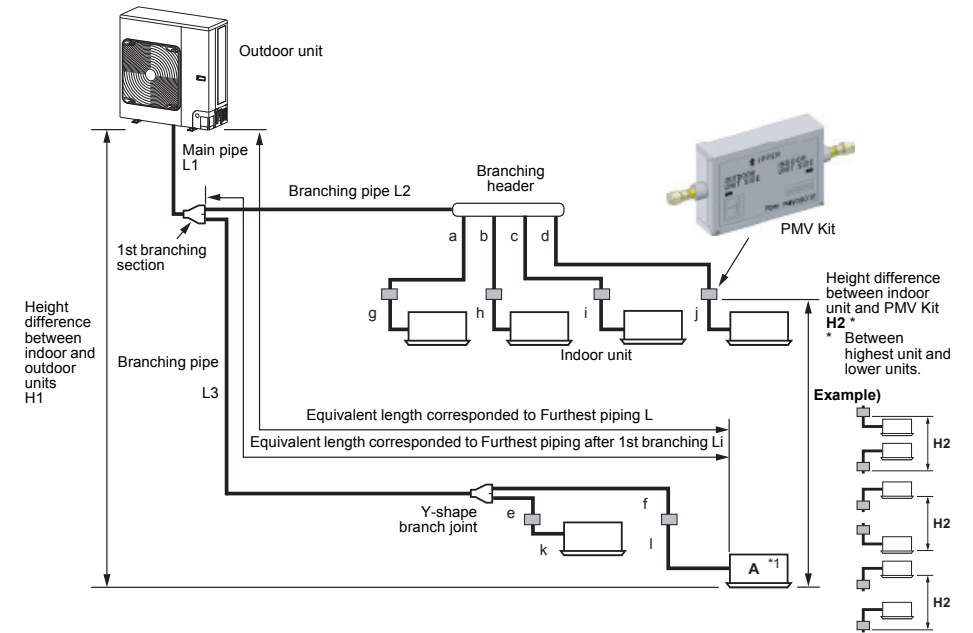

		Allowable value	Pipes
Piping Length	Total extension of pipe (Liquid pipe, real length)	250 m	$L1 + L2 + L3 + a + b + c + d + e + f + g + h + i + j + k + l$
	Furthest piping length L (*1)	Real length	100 m
		Equivalent length	130 m
	Max. real length of main pipe	70 m	L1
	Max. equivalent length of furthest piping from 1st branching Li (*1)	30 m	$L3 + f + i$
	Max. equivalent length of indoor unit connecting pipe	15 m	$a + g, b + h, c + i, d + j, e + k, f + l$
Real length between PMV KIT and indoor unit	2 m or more Below 10 m	g, h, i, j, k, l	
Height Difference	Height between indoor and outdoor units H1	Upper outdoor unit	50 m
		Lower outdoor unit	40 m
	Height between indoor unit and PMV kit H2	15 m	—

*1: Furthest indoor unit from 1st branch to be named "A".

NOTE

Do not connect two or more indoor units to one PMV Kit. Arrange one indoor unit and one PMV Kit set to 1 by 1.

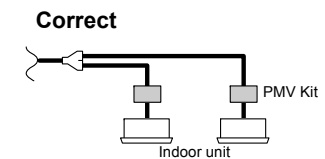
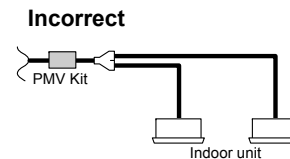

■ Airtight test

Before starting an airtight test, further tighten the spindle valves on the gas side and liquid side. Pressurize the pipe with nitrogen gas charged from the service port to the design pressure to conduct the airtight test.

After the airtight test is completed, evacuate the nitrogen gas.

- Apply pressure from the service ports of the packed valves at liquid side and gas side.
- An air tight test can be only performed to the service ports at liquid side and gas side of the outdoor unit.
- Close fully valves at liquid side and gas side. As there is possibility that nitrogen gas enters in the refrigerant cycle, re-tighten the valve rods before applying pressure.
- For each refrigerant line, apply pressure gradually with steps at liquid side and gas side.

Apply pressure to liquid side and gas side.

REQUIREMENT

Do not use "Oxygen", "Flammable gas" and "Noxious gas" in an airtight test.

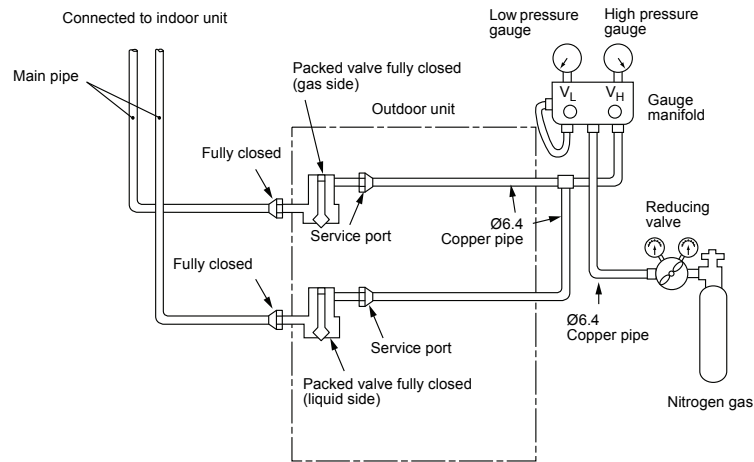

To detect a gross leakage

1. Apply pressure 0.3 MPa (3.0 kg / cm²G) for 3 minutes or more.
2. Apply pressure 1.5 MPa (15 kg / cm²G) for 3 minutes or more.

To detect a slow leakage

3. Apply pressure 4.15 MPa (42.3 kg / cm²G) for approx. 24 hours.

- Check pressure down.
No pressure down: Accepted
Pressure down: Check the leaked position.

NOTE

However, if the environmental temperature changes from the moment of applying pressure to 24 hours after that, the pressure will change by about 0.01 MPa (0.1 kg / cm²G) per 1 °C. Consider the pressure change when checking the test result.

REQUIREMENT

When pressure decrease is detected in steps 1-3, check the leakage at the connecting points. Check the leakage using a foaming agent or other measures and seal the leak with re-brazing, flare retightening or other methods. After sealing, execute an airtight test again.

■ Air purge

NOTE

For the air purge at installation time (Discharge of air in connecting pipes), use "Vacuum pump method" from viewpoint of the protection of the earths environment.

- For protection of the earths environment, do not discharge the refrigerant gas in the air.
- Eliminate the remaining air (nitrogen gas, etc.) in the unit by using a vacuum pump.
If gas remains, performance and reliability of the unit may be reduced.

After the airtight test, discharge nitrogen gas. Then connect the gauge manifold to the service ports at liquid side and gas side, and connect the vacuum pump as shown in the following figure.

Perform vacuuming for liquid side and gas side.

- Perform vacuuming from both liquid side and gas side.
- Use a vacuum pump with counter-flow preventive function so that oil in the pump does not back up in the pipe of the air conditioner when the pump has been stopped. (If oil in the vacuum pump enters in to the air conditioner an error may occur in the refrigeration cycle.)

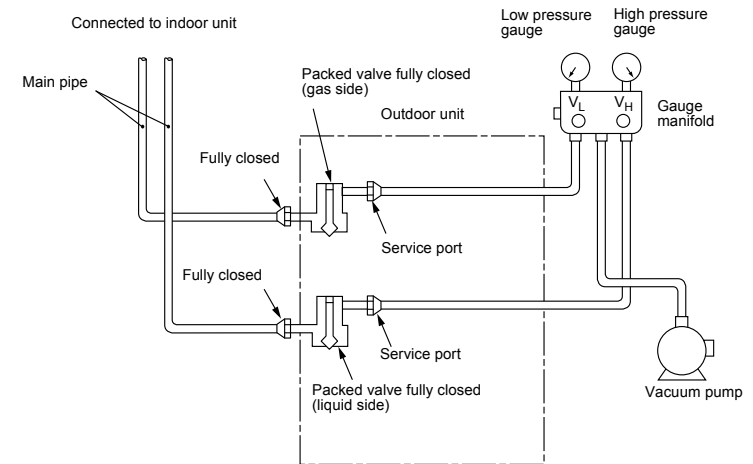

- Use a vacuum pump that has a high vacuum (below -100.7kPa (-755mmHg)) and a large exhaust gas amount (over 40 L / minute).
- Perform vacuuming for 2 or 3 hours though time differs due to pipe length.
In this time, check all valves at liquid and gas sides are fully closed.
- If vacuuming valve amount is not decreased to below -100.7kPa even after vacuuming for 2 hours or more, continue vacuuming for 1 hour or more.
If -100.7kPa or less cannot be obtained by 3 hours or more vacuuming, detect and repair the leak.
- When the vacuuming valve has reached -100.7kPa or less after vacuuming for 2 hours or more, close valves VL and VH on the gauge manifold fully. Stop the vacuum pump, leave it as it is for 1 hour and then check the vacuum does not change. If it does change then there may be a leak within the system.
- After the above procedure for vacuuming has finished, exchange the vacuum pump with a refrigerant cylinder and advance to the additional charging of refrigerant.

■ Adding refrigerant

After finishing vacuuming, exchange the vacuum pump with a refrigerant canister and start additional charging of refrigerant.

Calculation of additional refrigerant charge amount

Default refrigerant amount does not include the refrigerant for pipes at the local site.

For refrigerant to be charged in pipes at the local site, calculate the amount and charge it additionally.

NOTE

If the additional refrigerant amount calculation indicates negative, use the air conditioner without adding or reducing refrigerant.

Outdoor unit type	MUG0401	MUG0501	MUG0601
Pre-Charged amount (kg)	2.4		

$$\text{Additional refrigerant charge amount at local site} = \left\{ \begin{matrix} \text{Real length of liquid pipe} \times \text{Additional refrigerant charge amount per 1 m liquid pipe (Table 1)} \\ + \text{Corrective amount of refrigerant depending on the indoor units (Table 2)} \\ + \text{Compensation by outdoor HP (Table 3)} \end{matrix} \right\} \times 0.9$$

Table 1

Liquid pipe dia. (mm)	6.35	9.52
Additional refrigerant amount / 1 m liquid pipe (kg / m)	0.025	0.055

Table 2

		Capacity rank	003	005	007	008	009	011	012	013	015	017	018	020	024	027	030	034	036	042	048	056
		Capacity code (Equivalent to HP)	0.3	0.6	0.8	0.9	1.0	1.1	1.25	1.5	1.7	1.85	2.0	2.25	2.5	3.0	3.2	3.6	4.0	4.5	5.0	6.0
Indoor unit model name	4-way cassette	MMU-UP****H*	-	-	-	-	0.4	-	0.4	-	1.2	-	1.2	-	1.2	1.2	1.2	-	1.2	-	1.2	1.2
		MMU-UP****HP*	-	-	-	-	0.4	-	0.4	-	0.8	-	0.8	-	0.8	0.8	0.8	0.8	1.2	1.2	1.2	1.2
		MMU-UP****MH*	-	0.3	0.4	-	0.4	-	0.4	-	0.6	-	0.6	-	-	-	-	-	-	-	-	-
	2-way cassette	MMU-UP****WH*	-	-	0.4	-	0.4	-	0.4	-	0.5	-	0.7	-	0.7	0.7	0.7	-	1.1	-	1.1	1.1
		MMU-UP****YH*	0.4	0.4	0.4	-	0.4	-	0.4	-	0.4	-	0.4	-	0.5	0.5	-	-	-	-	-	-
		MMU-UP****SH*	-	-	-	-	-	-	-	-	0.5	-	0.5	-	0.6	-	-	-	-	-	-	-
	Duct	MMD-UP****BH*	-	0.5	0.5	-	0.5	-	0.5	-	0.5	-	0.5	-	0.7	0.7	0.7	0.7	1.1	1.1	1.1	1.1
		MMD-UP****SPH*	0.3	0.3	0.4	0.4	0.4	0.4	0.4	0.4	0.5	0.5	0.5	0.7	0.7	0.7	-	-	-	-	-	-
		MMD-UP****H*	-	-	-	-	-	-	-	-	-	-	0.7	-	0.7	0.7	-	-	1.1	-	1.1	1.1
	Under-ceiling	MMC-UP****H*	-	-	-	-	-	-	-	-	-	-	0.6	-	0.6	0.8	0.8	-	1.2	-	1.2	1.2
		MMK-UP****H*	0.3	0.3	0.3	-	0.3	-	0.3	-	0.7	-	0.7	-	0.7	0.9	0.9	-	0.9	-	-	-
	High wall	MMK-UP****DH*	-	0.3	0.3	-	0.3	-	0.3	-	0.4	-	0.4	-	-	-	-	-	-	-	-	-

Table 3

Outdoor unit type	MUG0401	MUG0501	MUG0601
Compensation by outdoor HP (kg)	- 1.6	- 1.6	- 1.6

Example: (060 type)

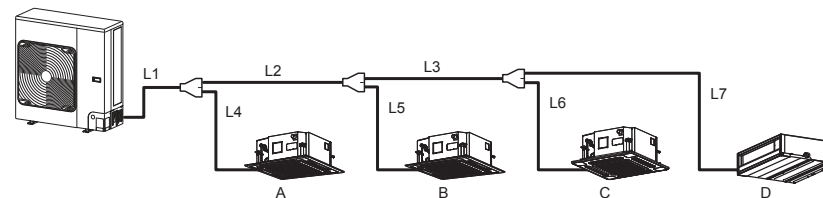

L1	Ø9.52: 10 m	L2	Ø9.52: 10 m	L3	Ø9.52: 5 m	L4	Ø9.52: 3 m
L5	Ø6.35: 3 m	L6	Ø6.35: 4 m	L7	Ø6.35: 5 m		
A	MMU-UP0241HP*	B	MMU-UP0181HP*	C	MMU-UP0071MH*	D	MMD-UP0071SPH*

Additional charge amount R (kg)

$$\begin{aligned} &= \{(Lx \times 0.025 \text{ kg/m}) + (Ly \times 0.055 \text{ kg/m}) + (a + b + c + d) + (- 1.6 \text{ kg})\} \times 0.9 \\ &= \{(12 \text{ m} \times 0.025 \text{ kg/m}) + (28 \text{ m} \times 0.055 \text{ kg/m}) + (0.8 \text{ kg} + 0.8 \text{ kg} + 0.4 \text{ kg} + 0.4 \text{ kg}) + (- 1.6 \text{ kg})\} \times 0.9 \end{aligned}$$

Lx: Real total length of liquid pipe diameter 6.35 mm (m)

Ly: Real total length of liquid pipe diameter 9.52 mm (m)

a: Corrective amount of refrigerant depending on the unit A (kg)

b: Corrective amount of refrigerant depending on the unit B (kg)

c: Corrective amount of refrigerant depending on the unit C (kg)

d: Corrective amount of refrigerant depending on the unit D (kg)

Charging of refrigerant

- Keeping the valve of the outdoor unit closed, be sure to charge the liquid refrigerant into the service port at the liquid side.
- If the specified amount of refrigerant cannot be charged, fully open the valves of the outdoor unit at liquid and gas sides, operate the air conditioner in COOL mode, and then charge refrigerant into service port at the gas side. In this time, choke the refrigerant slightly by operating the valve of the canister to charge liquid refrigerant.
- The liquid refrigerant may be charged suddenly, therefore be sure to charge refrigerant gradually.

Calculation total amount of refrigerant

REQUIREMENT

The total amount of refrigerant in the system shall be less than or equal to the limit. When exceeding the limit, please redesign the system.

Total amount of refrigerant =
Pre-Charged refrigerant amount + Additional refrigerant charge amount at local site
Limit on the total amount of refrigerant: 13.1kg

■ Full opening of the valve

Open the valves of the outdoor unit fully.
 Liquid pipe: 4 mm using a hexagonal wrench, fully open the valve rods.
 Gas pipe: 5 mm using a hexagonal wrench, fully open the valve rods.

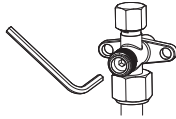

■ Heat insulation for pipe

- Apply heat insulation of pipe separately at the liquid and gas sides.
- Be sure to use thermal insulator resistant up to 120 °C or higher for pipes at the gas side.

■ Finishing after connecting pipes

- After piping connection work has been finished, cover the opening of the piping / wiring panel with the piping cover, or fill silicon or putty into the space between the pipes.
- In case of drawing-out the pipes downward or sideward, also close the openings of the base plate and the side plate.
- Under the opened condition, a problem may be caused due to the entering of water or dust.

When using the piping cover

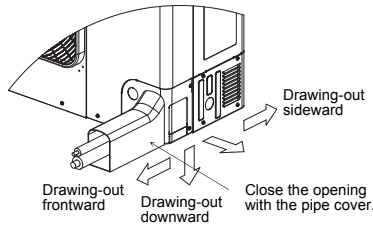

When not using the piping cover

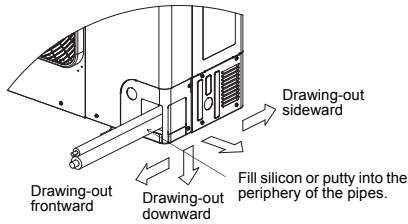

Pipe holding bracket

Attach pipe holding brackets following the table below.

Diameter of pipe (mm)	Interval
Ø19.05 or less	2 m

■ To fix the fluorinated greenhouse gases label

This product contains fluorinated greenhouse gases.
 Do not vent gases into the atmosphere.

Contains fluorinated greenhouse gases	
• Chemical Name of Gas	R32
• Global Warming Potential (GWP) of Gas	675

⚠ CAUTION

1. Stick the enclosed refrigerant label adjacent to the service ports for charging or recovering location and where possible adjacent to existing nameplates or product information label.
2. Clearly write the charged refrigerant quantity on the refrigerant label using indelible ink. Then, place the included transparent protective sheet over the label to prevent the writing from rubbing off.
3. Prevent emission of the contained fluorinated greenhouse gas. Ensure that the fluorinated greenhouse gas is never vented to the atmosphere during installation, service or disposal. When any leakage of the contained fluorinated greenhouse gas is detected, the leak shall be stopped and repaired as soon as possible.
4. Only qualified service personnel are allowed to access and service this product.
5. Any handling of the fluorinated greenhouse gas in this product, such as when moving the product or recharging the gas, shall comply under (EU) Regulation No. 517/2014 on certain fluorinated greenhouse gases and any relevant local legislation.
6. Periodical inspections for refrigerant leaks may be required depending on European or local legislation.
7. Contact dealers, installers, etc., for any questions..

Fill in the label as follows:

Refrigerant Label

Contains fluorinated greenhouse gases.

① Pre-charged refrigerant at factory [kg], specified in the nameplate.

② Additional charge on installation site [kg].

③ Total quantity of refrigerant in tonnes CO₂ equivalent.

Caution: Write out charge amount ①, ②, ①+② and ③ by indelible means on installation site.

R32 GWP:675

① = kg

② = kg

①+② = kg

③ = t

Pre-charged refrigerant at factory [kg], specified in the nameplate

Additional charge on installation site [kg]

GWP × kg
1000

7 Electric wiring

⚠ WARNING

The appliance shall be installed in accordance with national wiring regulations. Capacity shortages of the power circuit or an incomplete installation may cause an electric shock or fire.

⚠ CAUTION

- Perform wiring of power supply complying with the rules and regulations of the local electric company.
- Do not connect 220 V – 240 V power to the terminal blocks for control cables (Uv,Uh); otherwise, the unit may break down.
- Be sure that electric wiring does not come into contact with high-temperature parts of piping; otherwise, the coating of cables may melt and cause an accident.
- After connecting wires to the terminal block, take off the traps and fix the wires with cord clamps.
- Do not conduct power to indoor units until airtightness test, vacuum drying and adding refrigerant finish. In case that conducting power before doing them, conduct power during doing them to keep PMV in safety shut-off unit open.
- For the wiring of power to indoor units and that between indoor and outdoor units, follow the instructions in the installation manual of each indoor unit.

◆ Power wiring selection

MCA: Minimum Circuit Amps
MOCP: Maximum Overcurrent Protection (Amps)

Model	Power Supply	MCA (A)	MOCP (A)
	Nominal Voltage, Phase and frequency		
MUG0401*	1 ~ 50 Hz 220 V – 240 V	23.5	32.0
MUG0501*		26.5	32.0
MUG0601*		28.0	32.0

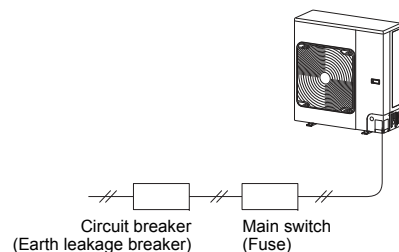

■ Communication line

Only TU2C-LINK models (U series) can be connected to this outdoor unit. It is not allowed to connect TCC-LINK models (other than U series). For details of communication type, refer to the following table.

Communication type and model names

Communication type	TU2C-LINK (U series and future models)	TCC-LINK (Other than U series)
Outdoor unit	MMY-MUP**** MCY-MUG**** ↑ This letter indicates U series model	Other than U series MMY-MAP**** MCY-MAP****
Indoor unit	MMY-UP**** ↑ This letter indicates U series model	Other than U series MM* -AP****
Wired remote controller	RBC-A**U**** ↑ This letter indicates U series model	Other than U series
Wireless remote controller kit & receiver unit	RBC-AXU**** ↑ This letter indicates U series model	Other than U series

■ Specifications for communication wiring

◆ Design of communication wiring

Summary of communication wiring

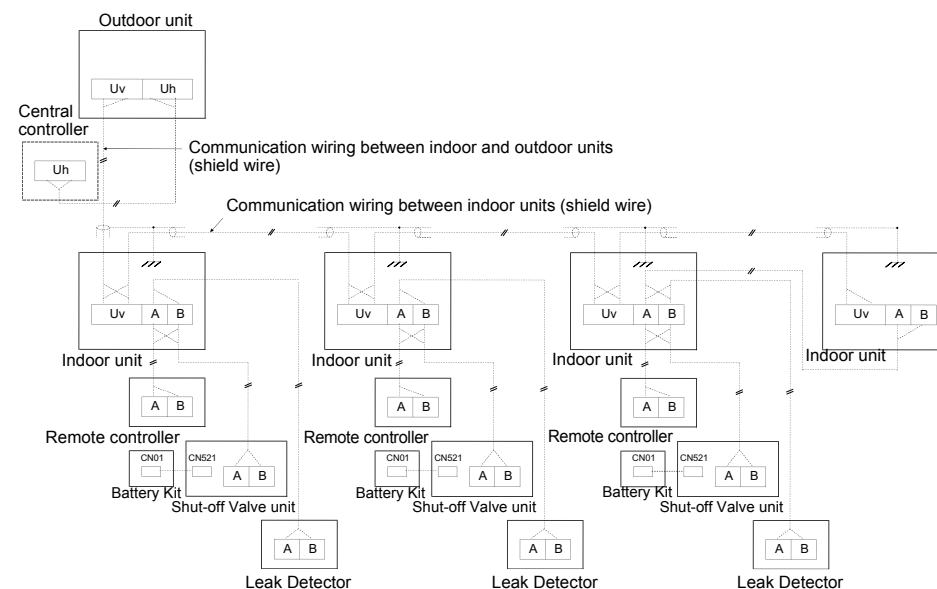

- Communication wiring and central control wiring use 2-core non-polarity wires. Use 2-core shield wires to prevent noise trouble.
- Connecting the closed end terminal of shield wire. (Connected to all connecting sections in each unit)
- Use 2-core non-polarity wire for remote controller, Shut-off Valve unit, Leak Detector and wiring of group control. (A, B terminals)

Keep the rule of below tables about size and length of communication wiring.

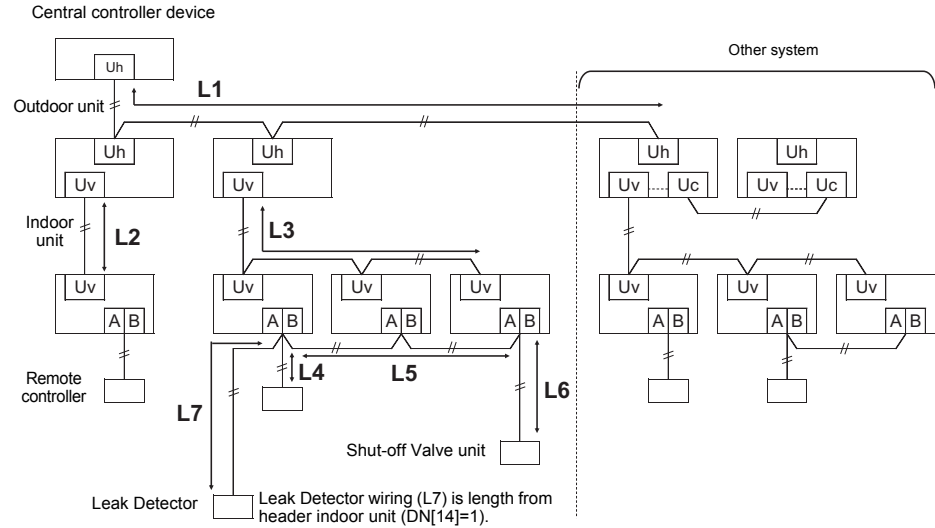

Table-1 Uv line (L2+L3)

Wiring	2-core, non-polarity
Type	Shield wire
Size / Length *1	1.0 to 1.5 mm ² : Up to 1000 m

*For communication wiring specification for other system, refer to the Installation Manual attached to the outdoor unit to be connected.

Table-2 Uh line (L1)

Wiring	2-core, non-polarity
Type	Shield wire
Size / Length	1.0 to 1.5 mm ² : Up to 1000 m 2.0 mm ² : Up to 2000 m

Table-3 Remote controller wiring, Shut-off Valve unit wiring, Leak Detector wiring

Wire	2-core
Size	0.5 mm ² to 2.0 mm ²
Length	<ul style="list-style-type: none"> Up to 300 m (L4+L5+L6+L7) Up to 400 m in case of wireless remote controller in group control. Up to 200 m total length of communication wiring between indoor units and Shut-off Valve unit. (L5+6) Up to 300 m. (L4) Up to 100 m. (L7)

*For Remote controller wiring, refer to the Installation Manual attached to the Remote controller to be connected.

- U (v, h, c) line means of control wiring.
- Uv line: Between indoor and outdoor units.
- Uh line: Central control line.
- Uc line: Between outdoor and outdoor units.

* For communication wiring specification for Shut-off Valve unit and Leak Detector, refer to the Installation Manual attached to each equipment.

◆ Group control through a remote controller

Group control of multiple indoor units (8 or 9 units) through a single remote controller

For the group connections without Shut-off Valve units:

It is up to 9 units.

Max. number of connectable Leak Detector and Remote Controller is up to 2 units

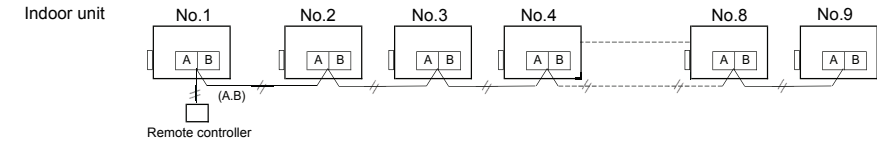

For the group connections with a Shut-off Valve unit:

It is up to 8 units.

Max. number of connectable Leak Detector and Remote Controller is up to 2 units

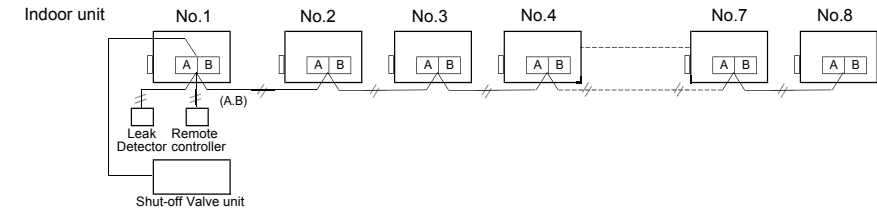

■ Connection of power wires and communication wires

Remove knockouts on the piping / wiring panel on the front of the unit or the panel on the bottom to get the power and communication wires through the holes. After punching out the knockout hole, remove burrs from the hole and then install guard materials around the passage hole to protect wires and pipes.

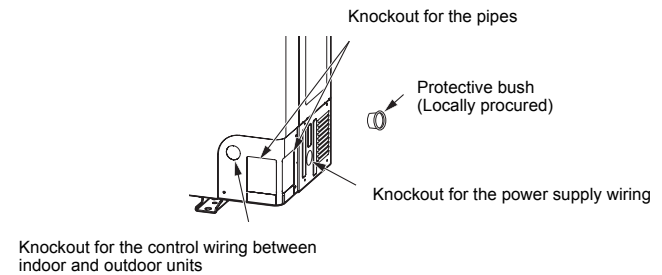

NOTE

Separate the power wire and communication wires.

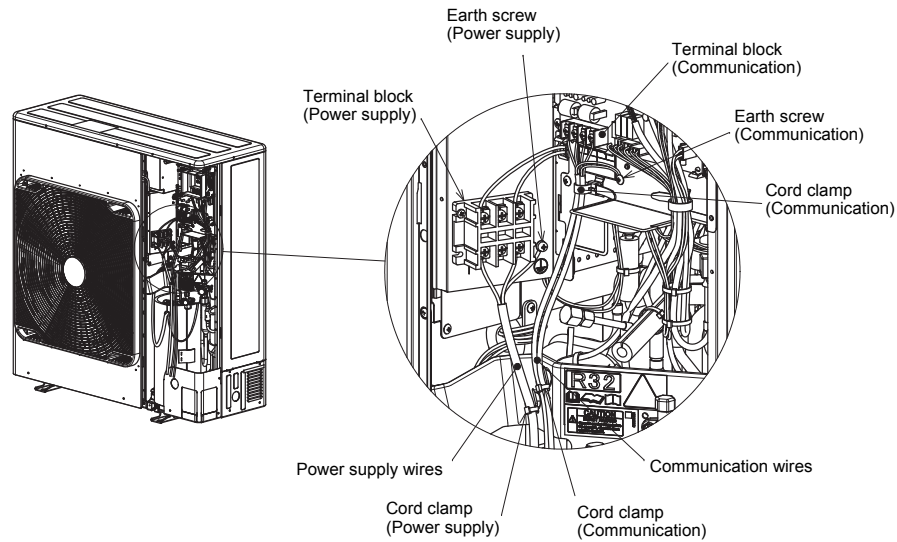

◆ Fix cable by cable tie

Fix each wire tightly to the valve fixing plate with the cable specified below. Measure the diameter of the wire to be fixed, and fasten the wire with the supplied cable tie. Cut off the tie surplus portion (A) of the cable tie so that length A of the surplus portion of the tie satisfies the following expression :

$A = L1 - L2$
 A: Minimum length of surplus portion of cable tie (mm)
 L1 : Cable tie length (183mm for T50R-HSW)
 L2: Circumferential length of wire (mm), Diameter of wire $D \times \pi$

Cable tie specifications

Model	Material	Flame retardant grade	Manufacturer
T50R-HSW	Nylon 66	UL94V-2	Hellermann Tyton

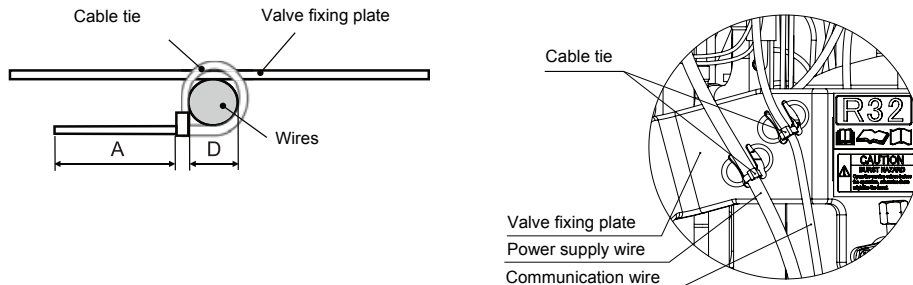

◆ Power supply wire connection

1. Insert the power supply wire through the cutout on the side of the electrical control box and connect the power supply wire to the power supply terminal block and the earth wire to the earth screw. After that, fix the power supply wire with the Cable tie.
2. Use round-type crimping terminals for power connection. Also, apply insulating sleeves to the crimping parts. Use a driver of appropriate size to fix the terminal screws.

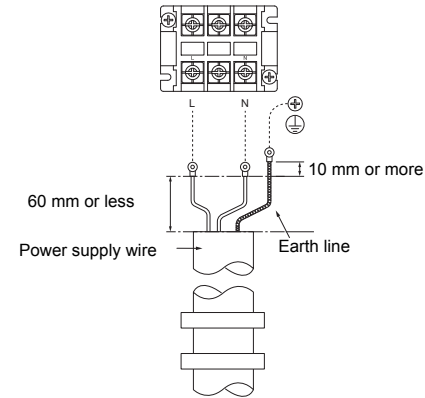

Wire size*
4.0 mm ²

* Design 60245 IEC66

Screw size and tightening torque

	Screw size	Tightening torque (N•m)
Power supply terminal	M6	2.5 to 3.0
Earth screw	M6	2.5 to 3.0

◆ Communication wire connection

Connect the communication wires to the communication wire terminals from under the electrical control box.

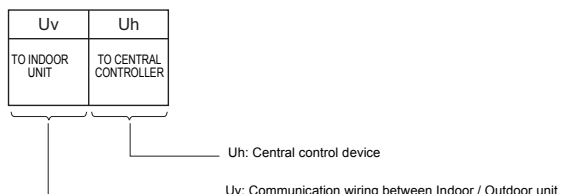
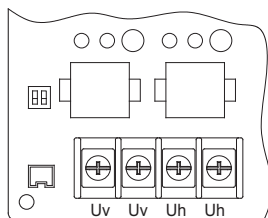

Screw size and tightening torque

	Screw size	Tightening torque (N•m)
Communication wire terminal	M4	1.2 to 1.4

■ Regulation of harmonic currents

This equipment complies with IEC 61000-3-12 provided that the short-circuit power S_{sc} is greater than or equal to $S_{sc}^{(*)}$ at the interface point between the user's supply and the public system. It is the responsibility of the installer or user of the equipment to ensure, by consultation with the distribution network operator if necessary, that the equipment is connected only to a supply with a short-circuit power S_{sc} greater than or equal to $S_{sc}^{(*)}$.

Furthermore, when similar equipment or other equipment which may cause harmonic current emissions are to be connected to the same interface point with this equipment, to reduce the risk of possible problems which may be caused from addition of those harmonic current emissions, it is recommended to make sure that the short-circuit power S_{sc} at the interface point is greater than the sum of the minimum S_{sc} required by all the equipment which will be connected to the interface point.

$S_{sc}^{(*)}$

Model	S_{sc} (kVA)
MCY-MUG0401HSW-E MCY-MUG0501HSW-E MCY-MUG0601HSW-E	731

This unit complies with EN 61000-3-11.

However, the impedance of the power supply system to be connected to the unit at the incoming power point must be less than the Z_{max} given below.

In order to meet this condition, consult with the supply authority as required.

$Z_{max} = 0.325 (\Omega)$

In addition, it is recommended that voltage drops occurring during the unit's operation in the area at the power input shall be around 3.3% of the nominal power-supply voltage or less.

8 Address setting

On this unit, it is required to set the addresses of the indoor units before starting air conditioning. Set the addresses following the steps below.

⚠ CAUTION

- Be sure to complete the electric wiring before setting the addresses.
- If you turn on the outdoor unit before turning on the indoor units, the CODE No. [L08] is indicated on the 7-segment display on the interface P.C. board of the outdoor unit until the indoor units are turned on. This is not a malfunction.
- It may take up to ten minutes (normally about five minutes) to address one refrigerant line automatically.
- Settings on the outdoor unit are required for automatic addressing. (Address setting is not started simply by turning on the power.)
- Running the unit is not required for address setting.

1. Follow the steps below to set the DIP switch on the outdoor unit interface P.C. board.

1-1.Outdoor unit setting

Interface P.C. board on the outdoor unit

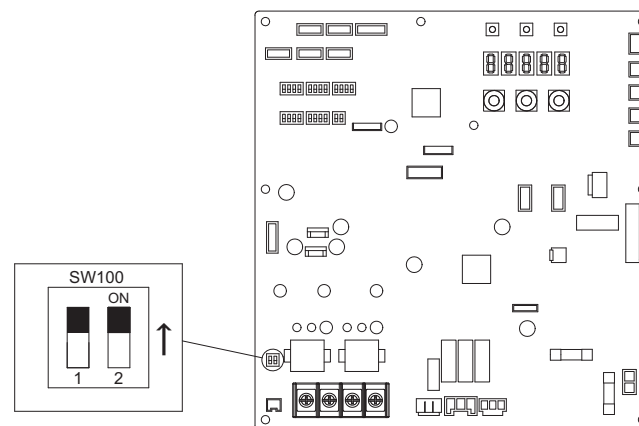

1-2.Line (system) address setting

For the central control among two or more refrigerant lines or group control among two or more refrigerant lines, set the line (system) address.

(Example)	Controlling a single refrigerant line centrally	Controlling 2 or more refrigerant lines centrally
System wiring diagram		
Line (system) address setting	No	Set the address

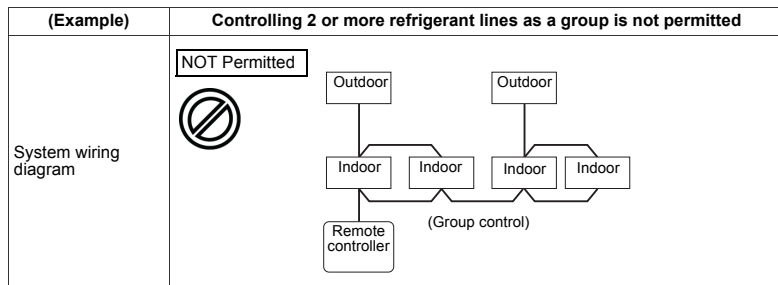

(1) Set a line (system) address for each system using SW101 and 102 on the interface P.C. board on the outdoor unit of each system.
(Factory default : Address 1)

NOTE

Be sure to set a unique address on each system. Do not use a same address as another system (refrigerant line) or a custom side.

Interface P.C. board on the outdoor unit

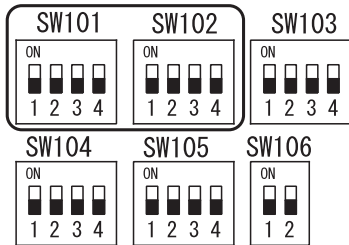

Switch settings for a line (system) address on the interface P.C. board on the outdoor unit

(○: switch ON, X: switch OFF)

Line (system)	SW101				SW102			
	1	2	3	4	1	2	3	4
1	-	X	X	X	X	X	X	X
2	-	X	X	X	X	X	X	○
3	-	X	X	X	X	X	○	X
4	-	X	X	X	X	X	○	○
5	-	X	X	X	X	○	X	X
6	-	X	X	X	X	○	○	○
7	-	X	X	X	X	○	○	X
8	-	X	X	X	X	○	○	○
9	-	X	X	X	○	X	X	X
10	-	X	X	X	○	X	X	○
11	-	X	X	X	○	X	○	X
12	-	X	X	X	○	X	○	○
13	-	X	X	X	○	○	X	X
14	-	X	X	X	○	○	X	○
15	-	X	X	X	○	○	○	X
16	-	X	X	X	○	○	○	○

Line (system)	SW101				SW102			
	1	2	3	4	1	2	3	4
17	-	X	X	○	X	X	X	X
18	-	X	X	○	X	X	X	○
19	-	X	X	○	X	X	○	X
20	-	X	X	○	X	X	○	○
21	-	X	X	○	X	○	X	X
22	-	X	X	○	X	○	X	○
23	-	X	X	○	X	○	○	X
24	-	X	X	○	X	○	○	○
25	-	X	X	○	○	X	X	X
26	-	X	X	○	○	X	X	○
27	-	X	X	○	○	X	○	X
28	-	X	X	○	○	X	○	○

(2) Turn on DIP switch 1 of SW100 on the header outdoor unit interface P.C board of the lowest system address number.

Switch setting (setting example when controlling 2 or more refrigerant lines centrally)

Outdoor units (setting manually)

*The items in bold font must be set manually.

Outdoor unit's interface P.C. board	Outdoor unit	Outdoor unit	Outdoor unit	Factory default
SW101, 102 (line (system) address)	1	2	3	1
DIP switch 1 of SW100 (Terminator of central control line)	ON	Set to OFF after setting addresses.	Set to OFF after setting addresses.	ON

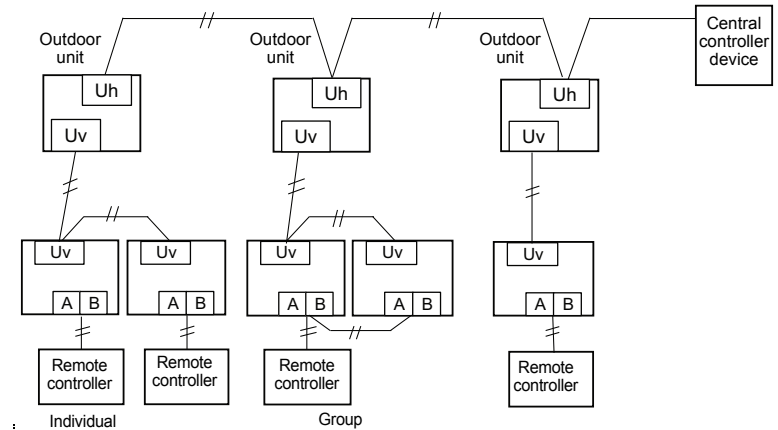

Indoor units (automatic setting)

Line (system) address	1	1	2	2	3
Indoor unit address	1	2	1	2	1
Group address	0	0	1	1	0

2. Follow the steps below to set the address

REQUIREMENT

- High voltage parts exist in the electrical control box.
If you set addresses on an outdoor unit, operate the unit through the access door as shown in the illustration below to avoid electric shock. Do not remove the cover of electrical control box.

- Turn on indoor units first, and then turn on outdoor units.
- About 1 minute after turning the power on, confirm that the 7-segment display on the interface P.C. board of the outdoor unit indicates **U. 1. Err (U. 1. flash)** and **L08** alternately at 1 second intervals.
- Push SW06 to start the automatic address setting.
(It may take up to 10 minutes (normally about 5 minutes) to complete one line's setting.)
- The 7-segment display indicates **Auto 1 → Auto 2 → Auto 3**.
The setting is complete when the display changes to **U. 1. --- (U. 1. flash)** or **U. 1. --- (U. 1. light)**.
- Repeat steps 2 to 4 for other refrigerant lines.
- Set the central control address.
(For the setting of the central control address, refer to the installation manuals of the central control devices.)

Interface P.C. board on the outdoor unit

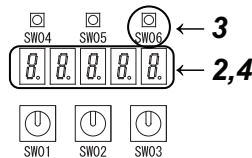

REQUIREMENT

If an indoor unit incompatible with R32 refrigerant is connected, "L02" is displayed. If "L02" is displayed, please check whether the connected indoor unit is compatible with A2L refrigerant.

Changing the indoor unit address using a remote controller

To change an indoor unit address using a wired remote controller.

Remote controller model name : RBC-ASCU11-E

- The method to change the address of an individual indoor unit (the indoor unit is paired with a wired remote controller one-tone), or an indoor unit in a group. (The method is available when the addresses have already been set automatically.)

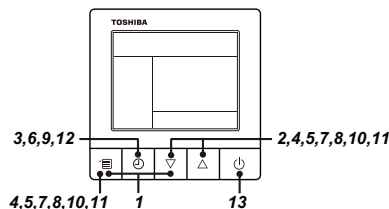

(Execute it while the units are stopped.)

- Push and hold menu button and [▽] setting button simultaneously for 10 seconds or more.
(If 2 or more indoor units are controlled in a group, the first indicated UNIT No. is that of the head unit.)
- Each time [▽] [△] setting button is pushed, indoor unit numbers in the group control change cyclically. Select the indoor unit to change settings for. (The fan and louvers of the selected indoor unit are activated.)
(The fan of the selected indoor unit is turned on.)
- Push the Timer off button.
- Push the menu button to make Code No. flash. Change Code No. [12] with [▽] [△] setting button.
- Push the menu button to make Set data [***] flash. Push the [▽] [△] buttons repeatedly to change the value indicated in the SET DATA section to that you want.
- Push the Timer off button.
(When the display changes from [--] to Set data [***] flashing, the setup is completed.)
<Indoor unit address>
- Push the menu button to make Code No. flash. Change Code No. [13] with [▽] [△] setting button.
- Push the menu button to make Set data [***] flash. Push the [▽] [△] buttons repeatedly to change the value indicated in the SET DATA section to that you want.
- Push the Timer off button.
(When the display changes from [--] to Set data [***] flashing, the setup is completed.)
<Indoor unit address>
- Push the menu button to make Code No. flash. Change Code No. [14] with [▽] [△] setting button.
- Push the menu button to make Set data [***] flash. Push the [▽] [△] buttons repeatedly to change the value indicated in the SET DATA section to that you want.

Individual:	0000	} In case of group control
Header unit:	0001	
Follower unit:	0002	

- Push the Timer off button.
(When the display changes from [--] to Set data [***] flashing, the setup is completed.)
- When all the settings have been completed, push ON/OFF button to determine the settings.
SETTING flashes and then the display content disappears and the air conditioner enters the normal stop mode. (The remote controller is unavailable while SETTING is flashing.)
- To change settings of another indoor unit, repeat from Procedure 1

NOTE

- The Code No. [E04] (Indoor / outdoor communication trouble) will appear if line (system) addresses are mistakenly set.
- If you set addresses to indoor units in 2 or more refrigerate lines manually using the remote controller and will control them centrally, set the outdoor unit of each line as below.
 - Set a system address for the outdoor unit of each line with SW101 and 102 of their interface P.C. boards.
 - Turn on DIP switch 1 of SW100 on the outdoor unit interface P.C. board of the lowest system address number.
 - After finishing all the settings above, set the address of the central control devices. (For the setting of the central control address, refer to the installation manuals of the central control devices.)

■ Resetting the address (Resetting to the factory default (address undecided))

Method 1

Clearing each address separately using a wired remote controller.

Set the system address, indoor unit address and group address to "00Un" using a wired remote controller.
(For the setting procedure, refer to the address setting procedures using the wired remote controller on the previous pages.)

Method 2

Clearing all the indoor unit addresses on a refrigerate line at once from the outdoor unit.

- 1** Turn off the indoor and outdoor units of the refrigerant line to reset to the factory default and set the outdoor unit of the line as below.
- 2** Turn on the indoor and outdoor units of the refrigerant line for which you want to initialize the addresses. About one minute after turning on the power, confirm that the 7-segment display on the outdoor unit indicates "U.1. - - -" and operate the interface P.C. board on the outdoor unit of the refrigerant line as follows.

SW01	SW02	SW03	SW04	Clearable addresses
2	1	2	Confirm that the 7-segment display indicates "A.d.buS" and turn SW04 ON for more than five seconds.	System / indoor unit / group address
2	2	2	Confirm that the 7-segment display indicates "A.d.nEt" and turn SW04 ON for more than five seconds.	Central control address

- 3** Confirm that the 7-segment display indicates "A.d. c.L." and set SW01, SW02 and SW03 to 1, 1, 1 respectively.
- 4** After finished clearing the address successfully, "U.1.Err" and "L08" appear alternatively at 1 second intervals on the 7-segment display.
- 5** Set the addresses again after finishing the clearance.

9 Communication setting

This product needs setting TU2C-LINK communication after the address setting. Follow the procedure below for the communication setting. TCC-LINK communication has been set as the factory default.

CAUTION

- Be sure to complete the electric wiring before setting the addresses.
- It may take approximately 1 to 3 minutes to address one refrigerant line.
- Settings on the outdoor unit are required for communication setting.
(Communication setting is not started simply by turning on the power.)
- If outdoor units for which communication setting has already been made are connected, the setting cannot be made correctly.
In this case, reset the communication setting and perform the setting again.
- If "L02" is displayed after Communication setting, an indoor unit incompatible with R32 refrigerant is connected.
In this case check whether the connected indoor unit is compatible with R32 refrigerant.

■ Communication setting

- 1** Turn on indoor units first, and then turn on outdoor units.
- 2** Set the rotary switch of the interface P.C. board on the outdoor unit to SW01= [2], SW02= [16] and SW03= [2].
- 3** The 7-segment display switches between "c.c. b p s" and "c.c. 0" at 1-second intervals.
- 4** Push and hold SW04 for more than 5 seconds.
- 5** The 7-segment display flashes "c.c.i n".
- 6** The 7-segment display switches between "c.c. i n" and "c.c. * * *" at 1-second intervals.
The number of connected indoor unit is displayed in [* * *], so if it is correct, proceed to " 7 ". In parentheses are the measures to be taken when the number of indoor units is different. (When the number of the connected indoor units differs from the number of indoor units displayed on the 7-segment display, clear the communication type setting to eliminate the cause. To clear the communication type setting, push and hold the SW05 for 5 seconds or more. The 7-segment display flashes "c.c.r S t".
After a while, the 7-segment display switches between "c.c. b p s" and "c.c. 0".
Set the rotary switch back to SW01 to [1], SW02 to [1] and SW03 to [1].)
- 7** Push and hold SW06 for more than 5 seconds.
- 8** The 7-segment display flashes "c.c.b p s".
After that, the setting is complete when the 7-segment display changes to "c.c F i n".
(If the 7-segment display changes to "c.c. E r r ", try again.)
When either a TU2C-LINK incompatible device or indoor unit incompatible with R32 refrigerant is connected, "L02" will be displayed for 30 minutes. If "L02" is displayed, please check whether the connected device is a device compatible with TU2C-LINK or A2L refrigerant.
- 9** After a while, the 7-segment display switches between "c.c. b p s" and "c.c. 1" at 1-second intervals.
When a TCC-LINK compatible device is connected, "L02" is displayed. If "L02" is displayed, please check whether the connected device is a device compatible with TU2C-LINK.

- 10** Set the rotary switch on the interface P.C. board of the outdoor unit back to SW01= [1], SW02= [1], SW03= [1].

7-segment display		Communication type
[A] [c.c.] [c.c.]	[B] [b p s] [1]	TU2C-LINK (U series and future models)

Interface P.C. board on the outdoor unit

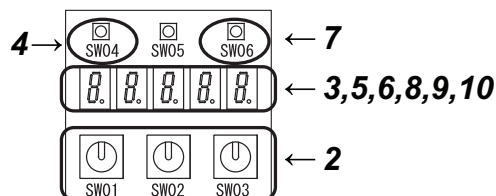

■ Resetting the communication (Return to factory default)

- 1 Turn off indoor units first, and then turn off outdoor units.
- 2 Set SW106-2 on the interface P.C. board of the outdoor unit to ON.
- 3 Turn on outdoor units first, and then turn on indoor units.
(Turn on the outdoor unit, and then 20 seconds or more later, turn on the indoor units.)
- 4 The 7-segment display indication “- r s t.-”. Check all the units have turned on more than approx. 1 minute. Turn off all the indoor and outdoor units.
- 5 Set SW106-2 on the interface P.C. board of the outdoor unit to OFF.

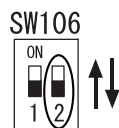

■ Setting when connecting indoor units to Shut-off Valve unit, and when connecting safety equipment

[Cautions to connection of indoor unit]

- When connecting the indoor units to Shut-off Valve unit, it is necessary to set up indoor DN CODE No.. Be sure to set up indoor DN CODE No. after setup of address.
- When connecting the indoor units to Shut-off Valve unit, it is possible to connect with multiple groups and connect individually.
- Even if no additional safety equipment is required, be sure to set safety measures (Indoor DN CODE No. [107]).

[Connection rules]

- Shut-off Valve unit are allowed in the system.
- Simultaneous connection of 2 or more Shut-off Valve units to the same indoor unit is not allowed.
- Group settings across Shut-off Valve units are not allowed.

[Setting rules]

- The safety measures for indoor units set in the group shall be the same. (Allow mixing in the system.)
- Only one Leak Detector is used in a group.

■ How to set up the indoor DN CODE No. [FE] (Shut-off Valve unit address)

- As for every Shut-off Valve unit, set up indoor DN CODE No. “FE” within the range of 1~128. This CODE No. should not be duplicate in one system.

- 1 Push and hold menu button and [▽] setting button simultaneously for 10 seconds or more.
(If 2 or more indoor units are controlled in a group, the first indicated UNIT No. is that of the head unit.)
- 2 Each time [▽] [△] setting button is pushed, indoor unit numbers in the group control change cyclically. Select the indoor unit to change settings for. (The fan and louvers of the selected indoor unit are activated.) (The fan of the selected indoor unit is turned on.)
- 3 Push the Timer off button.
- 4 Push the menu button to make Code No. flash. Change Code No. [FE] with [▽] [△] setting button.
- 5 Push the menu button to make Set data [***] flash. Push the [▽] [△] buttons repeatedly to change the value indicated in the SET DATA section to that you want.
- 6 Push the Timer off button. (When the display changes from [- -] to Set data [***] flashing, the setup is completed.)
- 7 When all the settings have been completed, push ON/OFF button to determine the settings. “SETTING” flashes and then the display content disappears and the air conditioner enters the normal stop mode. (The remote controller is unavailable while “SETTING” is flashing.)

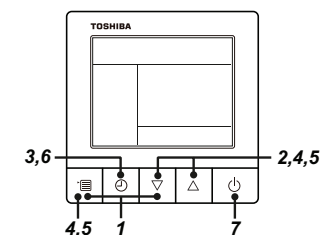

(Execute it while the units are stopped.)

■ How to set up the indoor DN CODE No. [107] (Safety measures)

- It is necessary to set up safety measures.
- If the settings and actual connections are different, the system will not be able to operate. The 7-segment display on the interface P.C. board of outdoor unit indicates "L13 (Safety measures setting mismatch)" or "L14 (Safety measures non-conformity)".

- 0 : No safety equipment is required
- 1 : Pump-down operation
- 2 : Individual shut-off operation
- 3 : Only Leak Detector

- 1 Push and hold menu button and [▽] setting button simultaneously for 10 seconds or more. (If 2 or more indoor units are controlled in a group, the first indicated UNIT No. is that of the head unit.)
- 2 Each time [▽] [△] setting button is pushed, indoor unit numbers in the group control change cyclically. Select the indoor unit to change settings for. (The fan and louvers of the selected indoor unit are activated.) (The fan of the selected indoor unit is turned on.)
- 3 Push the Timer off button.
- 4 Push the menu button to make Code No. flash. Change Code No. [107] with [▽] [△] setting button.
- 5 Push the menu button to make Set data [****] flash. Push the [▽] [△] buttons repeatedly to change the value indicated in the SET DATA section to that you want.
- 6 Push the Timer off button. (When the display changes from [- -] to Set data [****] flashing, the setup is completed.)
- 7 When all the settings have been completed, push ON/OFF button to determine the settings. "SETTING" flashes and then the display content disappears and the air conditioner enters the normal stop mode. (The remote controller is unavailable while "SETTING" is flashing.)

■ How to set up the indoor DN CODE No. [108] (Circulation flow operation mode of the indoor unit)

- It is necessary to set whether or not the indoor unit is in circulation flow operation when refrigerant leakage is detected.
- If the CODE No. [107] sets to 2 (Individual shut-off operation), circulation flow operation is not performed even if the CODE No. [108] sets to 0.

0 : Circulation flow operation
1 : Not circulation flow operation

- 1 Push and hold menu button and [▽] setting button simultaneously for 10 seconds or more. (If 2 or more indoor units are controlled in a group, the first indicated UNIT No. is that of the head unit.)
- 2 Each time [▽] [△] setting button is pushed, indoor unit numbers in the group control change cyclically. Select the indoor unit to change settings for. (The fan and louvers of the selected indoor unit are activated.) (The fan of the selected indoor unit is turned on.)
- 3 Push the Timer off button.
- 4 Push the menu button to make Code No. flash. Change Code No. [108] with [▽] [△] setting button.
- 5 Push the menu button to make Set data [****] flash. Push the [▽] [△] buttons repeatedly to change the value indicated in the SET DATA section to that you want.
- 6 Push the Timer off button. (When the display changes from [- -] to Set data [****] flashing, the setup is completed.)
- 7 When all the settings have been completed, push ON/OFF button to determine the settings. "SETTING" flashes and then the display content disappears and the air conditioner enters the normal stop mode. (The remote controller is unavailable while "SETTING" is flashing.)

◆ [Set up example]

- [14] : Group address
0 : Individual
1 : Header unit
2 : Follower unit
- [FE] : Shut-off Valve unit address
• Should not be duplicate in one system.
• Factory default : Un
- [107] : Safety measures
0 : No safety equipment is required
1 : Pump-down operation
2 : Individual shut-off operation
3 : Only Leak Detector
- [108] : Circulation flow operation mode of the indoor unit
0 : Circulation flow operation
1 : Not circulation flow operation

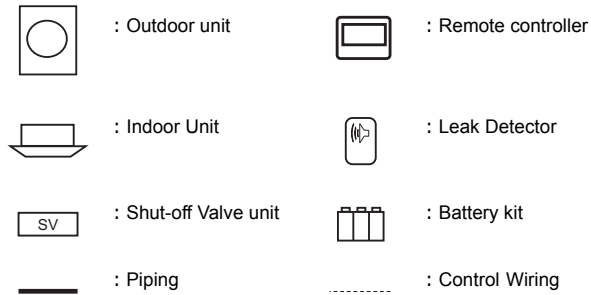

1. In case of connecting no safety equipment.

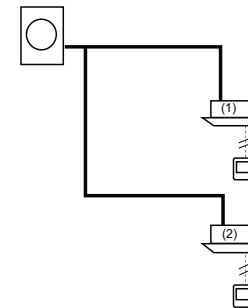

Indoor unit	(1)	(2)	
[14]	0	0	
[FE]	Un	Un	It is not necessary to set up.
[107]	0	0	
[108]	0	0	It is not necessary to set up.

2. In case of connecting Leak Detectors to each indoor units.

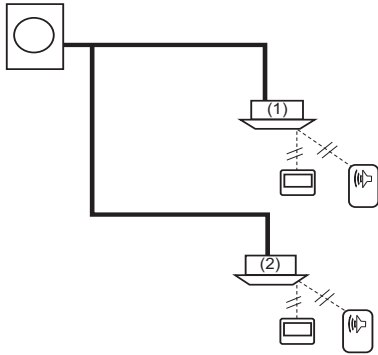

Indoor unit	(1)	(2)
[14]	0	0
[FE]	Un	Un
[107]	3	3
[108]	0	0

It is not necessary to set up.

3. In case of connecting one indoor unit and Lead Detector to Shut-off Valve unit.

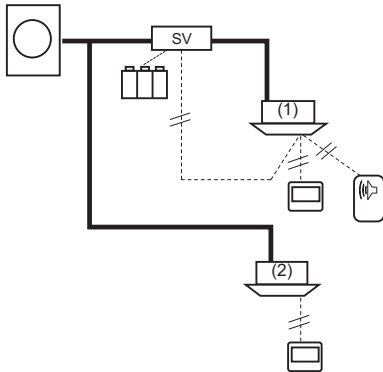

Indoor unit	(1)	(2)
[14]	0	0
[FE]	1	Un
[107]	1 or 2	0
[108]	0 or 1*	0

*When you set up CODE No. "107" to 2, please set up CODE No. "108" to 1.

4. In case of connecting one group operation of indoor units and one indoor unit to no safety equipment and two remote controller.

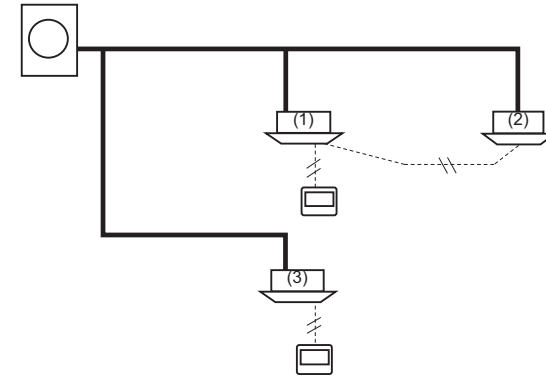

Indoor unit	(1)	(2)	(3)
[14]	1	2	0
[FE]	Un	Un	Un
[107]	0	0	0
[108]	0	0	0

It is not necessary to set up.

It is not necessary to set up.

5. In case of connecting each indoor units and Leak Detectors to Shut-off Valve unit.

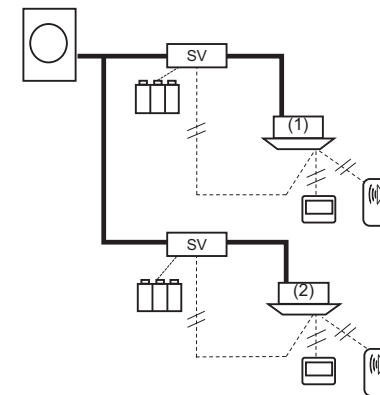

Indoor unit	(1)	(2)
[14]	0	0
[FE]	1	2
[107]	1 or 2	1 or 2
[108]	0 or 1*	0 or 1*

*When you set up CODE No. "107" to 2, please set up CODE No. "108" to 1.

6. In case of connecting one group operation of indoor units and Leak Detectors to Shut-off Valve unit.

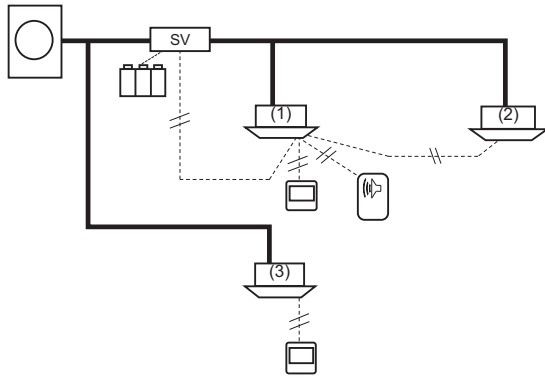

Indoor unit	(1)	(2)	(3)
[14]	1	2	0
[FE]	1	1	Un
[107]	1 or 2	1 or 2	0
[108]	0 or 1*	0 or 1*	0

*1: Code No. "FE" is necessary set up same No. in (1) and (2).

*2: When you set up CODE No. "107" to 2, please set up CODE No. "108" to 1.

Incorrect connection

1. Only one leak Detector can be connected to indoor units with a group setting.

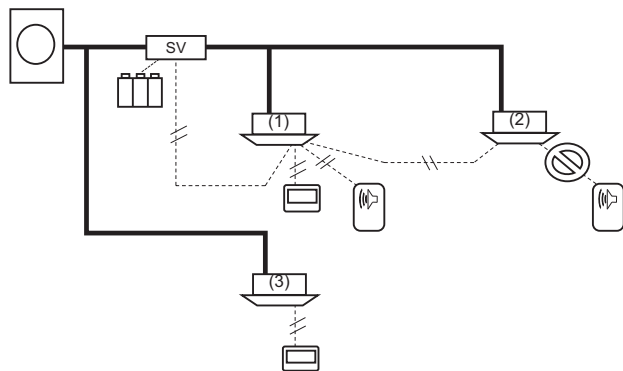

Incorrect connection

2. Group setting of indoor units across Shut-off Valve unit is not possible.

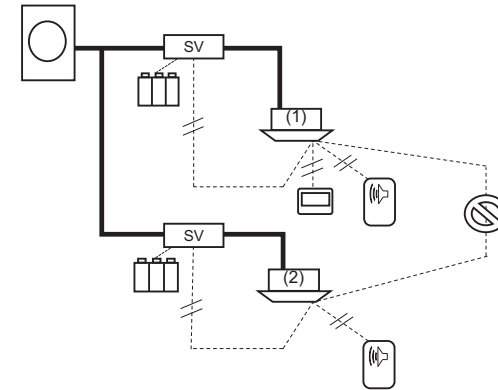

10 Applicable control settings

When connecting an optional P.C. board (sold separately) for outdoor units, it is necessary to change the settings of the outdoor unit.

All are set to [Standard (factory setting)] at the time of shipment, so change the settings of the outdoor unit as necessary.

The settings can be changed by operating the switches on the interface board.

In the TU2C-Link communication system, it can also be done by operating the wired remote controller.

◆ Applicable controls setup

(settings at the site)

Basic procedure

Be sure to stop the air conditioner before making settings.

(Change the setup while the air conditioner is not working.)

⚠ CAUTION

Set only the Code No. shown in the following table: Do NOT set any other Code No.

If a Code No. not listed is set, it may not be possible to operate the air conditioner or other trouble with the product may result.

When switching settings from the interface P.C. board of the outdoor unit

- 1 Set the rotary switch of the interface P.C. board on the outdoor unit to SW01= [9], SW02= [1] and SW03= [1].
- 2 The 7-segment display shows “d n.S E t”.
- 3 When SW04 is pressed, the 7-segment display switches to “d n.0 0 1” and the outdoor unit code NO. [001] is displayed.
- 4 Change outdoor unit code NO.[****] with SW05 or SW06. Push SW05 to advance the code. Push and hold SW05 to advance in 5 steps. Push SW06 to return the code. Push and hold SW05 to return in 5 steps.
- 5 When SW04 is Pushed, the 7-segment display blinks “d.***” and the setting data [****] being set is displayed.
- 6 Change setting data [****] with SW05 or SW06. Push SW05 to advance the data. Press SW06 to return the setting data.
- 7 Push and hold SW04 for more than 2 seconds. When the flashing stops and remain lit on the display, the setting is complete. (To return to the item code setting after completing the setting, or to return to the item code setting without setting, press SW04 once.)
- 8 Set the rotary switch on the interface P.C. board of the outdoor unit back to SW01= [1], SW02= [1], SW03= [1].
- 9 Reset the power of the outdoor unit (power off for one minute or more) .

Interface P.C. board of unit

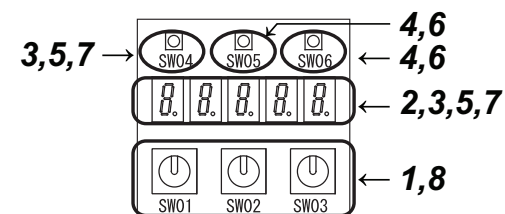

When switching from the wired remote controller (RBC-ASCU11-E)

Basic procedure

Be sure to stop the air conditioner before making settings.

(Change the setup while the air conditioner is not working.)

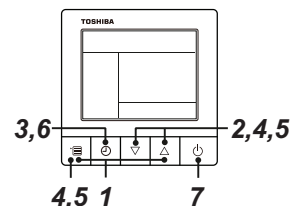

- 1 Push and hold menu button and [Δ] setting button simultaneously for 10 seconds or more.
 - After a while, the display flashes as shown in the figure. ALL is displayed as indoor unit numbers during initial communication immediately after the power has been turned on.

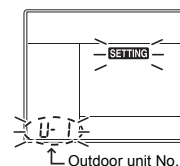

- 2 Each time [▽] [Δ] setting button is pushed, outdoor unit numbers in the group control change cyclically. Select the outdoor unit to change settings for.
 - After a while, the display flashes as shown in the figure. ALL is displayed as indoor unit numbers during initial communication immediately after the power has been turned on

- 3 Push Timer off button to confirm the selected outdoor unit.

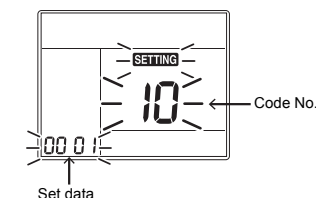

- 4 Push the menu button to make Code No. [**] flash. Change Code No. [**] with [▽] [Δ] setting button.
- 5 Push the menu button to make Set data [****] flash. Change Set data [****] with [▽] [Δ] setting button.
- 6 Push Timer off button to complete the set up.
 - To change other settings of the selected outdoor unit, repeat from Procedure 4.
- 7 When all the settings have been completed, push ON/OFF button to finish the settings. (Return to the normal mode)
 - SETTING flashes and then the display content disappears and the air conditioner enters the normal stop mode. (The remote controller is unavailable while SETTING is flashing.)
 - To change settings of another outdoor unit, repeat from Procedure 1.

11 Test run

■ Before test run

"Confirm that the value of the refrigerant pipe of the outdoor unit is OPEN.

- Before turning on the power, confirm that the resistance between the terminal block of power supply and the earth is more than 1MΩ using a 500V Mega ohm meter.
Do not run the unit if it is less than 1MΩ."

⚠ CAUTION

- To save the compressor when it is activated, turn on the power at least 12 hour before starting.

Interface PC board

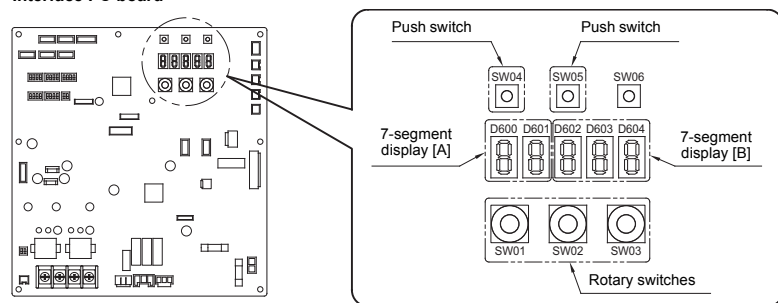

■ Methods of test run for safety equipment

◆ When connecting Shut-off Valve unit, perform the following detailed inspection mode.

The detailed inspection mode is performed on the interface PC board of the outdoor unit.

Detailed inspection mode is completed in about 30 minutes.

<Detailed inspection mode start operation>

- 1 Set the rotary switch on the interface board of the outdoor unit to SW01=[2], SW02=[15], SW03=[16].

7-segment display	
[A]	[B]
[FS]	[]

- 2 Push SW04 for at least 5 seconds

7-segment display	
[A]	[B]
[FS]	[CH]

If the detailed inspection mode successfully completes, the following will be displayed.

7-segment display	
[A]	[B]
[FS]	[--]

If there is an incorrect electrical wiring, incorrect piping connection, incorrect indication, etc., the following will be displayed. If there are multiple indoor units with errors, push SW06 to change the address display of the indoor unit. (If there is only one indoor unit with an error, the display remains the same.)

7-segment display	
[A]	[B]
[FS]	[Err] ↔ [#]
The indication changes every 0.5 second.	

: Address of error indoor unit

If [Err] is indicated on 7-segment display, execute cooling/heating test run for each indoor unit and check cool/hot air is blowing. Also, check the piping connections, wiring connections, and settings again.

If there is no problem after checking again, the system is normal.

When you modify piping connections, wiring connections, or settings, execute detailed inspection mode again. Please contact a qualified service person if there is any trouble during test run.

*[Err] may be indicated even if there is no problem.

- When the temperature difference is large between in each indoor unit.
- When the Shut-off Valve unit is connected to the main pipe from the outdoor unit.

<Detailed inspection mode start operation>

- 1 Return the rotary switch on the interface board of the outdoor unit to SW01=[1], SW02=[1], and SW03=[1].

7-segment display	
[A]	[B]
[U1]	[]

◆ When using a Leak Detector, perform the following simple inspection mode.

- The simple inspection mode is performed with Leak Detector.
- The simple inspection mode should be performed for each Leak Detector.
- If you run a simple inspection mode while normal operation, normal operation is suspended and simple inspection mode is started.
- The simple inspection mode can be performed during the detailed inspection mode. (Detailed inspection mode operation does not stop.)

<Simple inspection mode start operation>

- 1 Push the reset switch on the refrigerant Leak Detector for at least 5 seconds. (Please use a precision screwdriver, etc.)

7-segment display	
[A]	[B]
[Sd]	[CH]

It is not displayed during detailed inspection mode.

The refrigerant leak detector works. (For the operation of Leak Detector, refer to the operating instructions of Leak Detector.)

If the simple inspection mode operates normally, the following is displayed.

(It is not displayed during detailed inspection mode.)

7-segment display	
[A]	[B]
[Sd]	[--]

If there is a disconnection, etc., the following display will be displayed.

7-segment display	
[A]	[B]
[Sd]	[Err]

If you see an error, check the wiring connection again.

<Simple inspection mode end operation>

- 1 Push the alarm stop switch on Leak Detector for at least 5 seconds.

7-segment display	
[A]	[B]
[U1]	[]

◆ If "there is no" shut-off Valve unit, perform "Test run for air conditioner".

■ Methods of cooling / heating test run for the air conditioner

◆ When executing a test run using a remote controller

Operate the system normally to check the running condition using the wired remote controller. Follow the instructions in the supplied owner's manual when operating the unit.

If you use a wireless remote controller for operations, follow the instructions in the installation manual supplied with the indoor unit.

To execute a test run forcibly under the condition that the thermostat automatically turns the unit off due to the indoor temperature, follow the procedure below.

The forcible test run will automatically stop after 60 minutes to prevent continuous forcible running and return to normal running.

⚠ CAUTION

Do not use forcible running except for a test run as it overloads the unit.

Wired remote controller

Be sure to stop the air conditioner before making settings.
(Change the setup while the air conditioner is not working.)

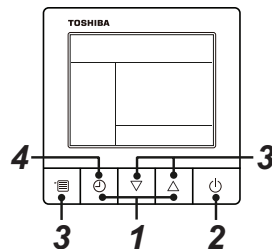

- 1 Push and hold Timer off button and [Δ] setting button simultaneously for 10 seconds or more. [TEST] is displayed on the display part and the test run is permitted.

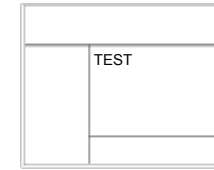

- 2 Push ON/OFF button.

- 3 Push menu button to select the operation mode. Select [Cool] or [Heat] with [▽] [Δ] setting button, and then push menu button (three times) again to determine the operation mode.

- Do not run the air conditioner in a mode other than [Cool] or [Heat].
- The temperature setting function does not work during test run.
- The check code is displayed as usual.

- 4 After the test run, push Timer off button to stop a test run.

([TEST] disappears on the display and the air conditioner enters the normal mode.)

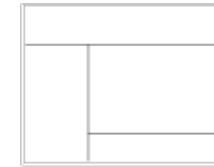

◆ When executing a test run using the interface P.C. board on the outdoor unit

You can execute a test run by operating switches on the interface P.C. board of the outdoor unit.

"Individual test run", which tests each indoor unit separately, and "corrective test run", which tests all the indoor units connected, are available.

<Individual test run>

▼ Starting operation

- 1 Set the running mode to "COOL" or "HEAT" on the remote controller of the indoor unit to be tested.

(The unit will run in the current mode unless you set the mode otherwise.)

7-segment display	
[A]	[B]
[U1]	[]

2 Set the rotary switches on the interface P.C. board of the outdoor unit: SW01 to [16], SW02 and SW03 to the address of the indoor unit to be tested.

SW02	SW03	Indoor unit address	
1 to 16	1	1 to 16	Set number of SW02
1 to 16	2	17 to 32	Set number of SW02 + 16
1 to 16	3	33 to 48	Set number of SW02 + 32
1 to 16	4	49 to 64	Set number of SW02 + 48

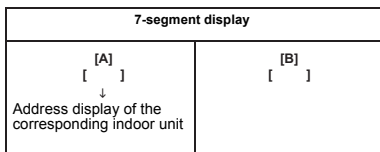

3 Push and hold SW04 for more than 10 seconds.

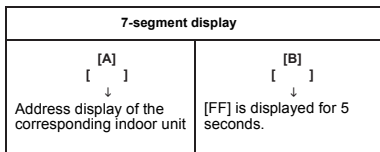

NOTE

- The running mode follows the mode setting on the remote controller of the target indoor unit.
- You cannot change the temperature setting during the test run.
- Errors are detected as usual.
- The unit does not perform test run for 3 minutes after turning the power on or stopping running.

▼ Finishing operation

1 Push and hold SW05 for more than 2 seconds.

2 Set the rotary switches on the interface P.C. board of the outdoor unit back: SW01 to [1], SW02 to [1] and SW03 to [1].

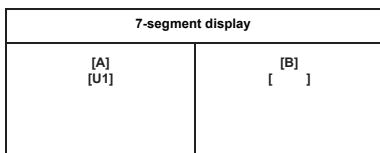

<Corrective test run>

▼ Start operation

1 Set the rotary switches on the interface P.C. board of the outdoor unit as below.
When in "COOL" mode: SW01=[2], SW02=[5], SW03=[1].
When in "HEAT" mode: SW01=[2], SW02=[6], SW03=[1].

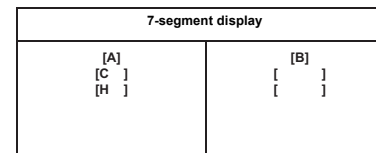

2 Push and hold SW04 for more than 2 seconds.

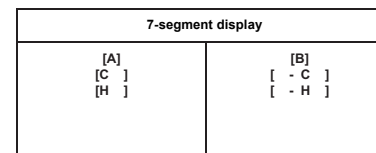

NOTE

- You cannot change the temperature setting during the test run.
- Errors are detected as usual.
- The unit does not perform test run for 3 minutes after turning the power on or stopping running.

▼ Stop operation

1 Set the rotary switches on the interface P.C. board of the outdoor unit back: SW01 to [1], SW02 to [1] and SW03 to [1].

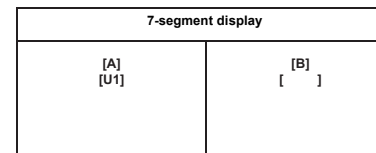

Interface PC board

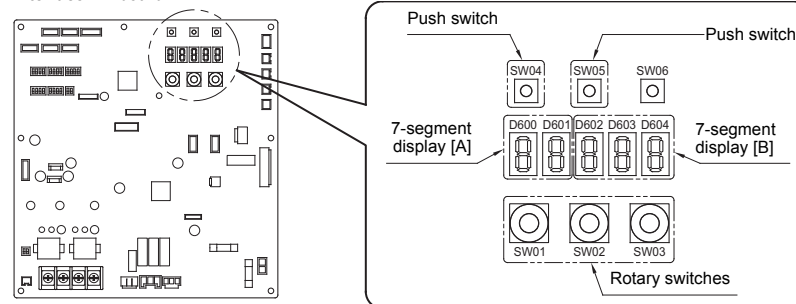

12 Troubleshooting

In addition to the CODE No. on the remote controller of an indoor unit, you can diagnose failure type of an outdoor unit by checking the 7-segment display on the interface P.C. board.

Use the function for various checks.

Set every dip switch to OFF after checking.

7-Segment display and check code

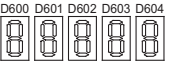
Rotary switch setting value			Indication	7-segment LED	
SW01	SW02	SW03			
1	1	1	Outdoor unit check code	Display contents	[U.1Err] ⇄ [○○○△△] Display alternately every 2 seconds ○○○: Check code △△: Sub code

* If a check code has an sub code, the display indicates the check code for three seconds and the sub code for one second alternately.

Check code (indicated on the 7-segment display on the outdoor unit)

Indicated when SW01 = [1], SW02 = [1], and SW03 = [1].

Check code		Check code name
Indication on 7-segment display on the outdoor unit		
	Sub code	
E06	Number of indoor unit which received normally	Decrease of number of indoor units No indoor unit with a terminating resistor set
E07	—	Indoor / Outdoor communication circuit trouble
E08	Duplicated indoor addresses	Duplication of indoor addresses
E12	01 : Communication between indoor and outdoor	Automatic address start trouble
E15	—	No indoor unit during automatic address setting
E16	00: Capacity over 01 or more : No. of connected units	Capacity over / Too many indoor units connected
E20	01: Other line outdoor connected 02: Other line indoor connected	Other line connected during automatic address setting
E31	IPDU quantity information*1	IPDU communication trouble
	80	Communication trouble between MCU and sub MCU
F04	—	TD sensor trouble
F06	—	TE sensor trouble
F07	01: TL1 sensor	TL1 sensor trouble
F08	—	TO sensor trouble
F12	01: TS1 sensor	TS1 sensor trouble
F13	1*	TH sensor (Board installed) trouble
F15	—	Outdoor temp. sensor miswiring (TE, TL1)
F16	—	Outdoor pressure sensor miswiring (Pd, Ps)
F23	—	Ps sensor trouble
F24	—	Pd sensor trouble
F31	—	I/F EEPROM trouble
H01	1*	Compressor breakdown
H02	1*	Compressor trouble (Lock)
H03	1*	Current detective circuit system trouble
H04	—	Compressor trouble (Overheat)

H06	—	Low-pressure protective operation
H17	1*	Compressor trouble (Out of sync)
J30	Detected indoor addresses	Refrigerant leak detection
L02	Detected indoor addresses	Model mismatch of indoor and outdoor unit
L04	—	Outdoor system address duplicated
L06	Number of indoor units with priority	Duplication of indoor units with priority
L08	—	Indoor unit address / Group address unset
L10	—	Outdoor unit capacity unset
L11	Detected indoor address	Unsuitable safety device connected
L13	Detected indoor address	Mismatch of safety device settings
L14	Detected indoor address	Safety device nonconformity
L29	IPDU quantity information *1	IPDU quantity trouble
L30	Detected indoor address	External interlock of indoor unit
P03	—	Discharge temp TD trouble
P04	1*	High-pressure switch trouble
P05	00	Power detection trouble
	1*	Compressor Vdc trouble
	E (: Fan motor number)	Fan motor Vdc trouble
P07	—	Heat sink overheat trouble
P10	Detected indoor address	Indoor overflow trouble
P11	—	Outdoor unit heat exchanger freezing trouble
P13	—	Outdoor unit liquid back detection trouble
P14	01 : Outdoor unit service valve is close	Other refrigerant cycle protection
P15	01 : TS1 condition 02 : TD condition	Gas leak detection
P19	—	4-way valve operation trouble
P20	—	High-pressure protective operation
P22	*0 : Elemental device short *1 : Position detective circuit trouble *3 : Fan motor lock trouble *4 : Motor current trouble *5 : Synchronize, step out trouble (* : Fan motor number)	Outdoor unit fan trouble
P26	1*	Compressor IPM short protection trouble
P29	1*	Compressor position detective circuit trouble

*1 IPDU number information
01 : Compressor
08 : Fan
09 : Compressor and Fan

WARNINGS ON REFRIGERANT LEAKAGE

Check of Concentration Limit

The room in which the air conditioner is to be installed requires a design that in the event of refrigerant gas leaking out, its concentration will not exceed a set limit.

The refrigerant R32, which is used in the air conditioner is safe, without the toxicity or combustibility of ammonia, and is not restricted by laws to be imposed which protect the ozone layer. However, since it contains more than air, it poses the risk of suffocation if its concentration should rise excessively. Suffocation from leakage of R32 is almost non-existent. However with recent increase in the number of high concentration buildings, the installation of multi air conditioner systems is on the increase because of the need for effective use of floor space, individual control, energy conservation etc.

Most importantly, the multi air conditioner system is able to hold a large amount of refrigerant compared with conventional individual air conditioners. If a single unit of the multi conditioner system is to be installed in a small room, select a suitable mode and installation procedure so that if the refrigerant accidentally leaks out, its concentration does not reach the limit (and in the event of an emergency, measures can be made before injury can occur).

In a room where the concentration may exceed the limit imposed by the local regulation, create an opening with adjacent rooms, or install mechanical ventilation or isolation, combined with a gas leak detection device, which complies with the local regulatory requirements.

The concentration calculation method is as given below.

$$\frac{\text{Total amount of refrigerant (kg)}}{\text{Min. volume of the indoor unit installed room (m}^3\text{)}} \leq \text{Concentration limit (kg/m}^3\text{)}$$

Refrigerant Concentration Limit shall be in accordance with local regulations.

▼ NOTE 1

If there are 2 or more refrigerating systems in a single refrigerating device, the amounts of refrigerant should be as charged in each independent device.

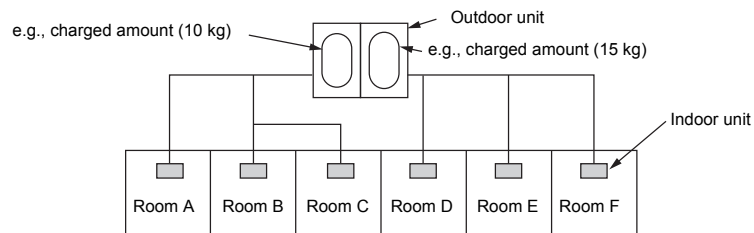

For the amount of charge in this example:

The possible amount of leaked refrigerant gas in rooms A, B and C is 10 kg.

The possible amount of leaked refrigerant gas in rooms D, E and F is 15 kg.

Important

▼ NOTE 2

The standards for minimum room volume are as follows.

- 1) No partition (shaded portion)

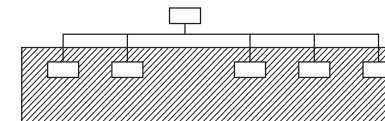

- 2) When there is an effective opening with the adjacent room for ventilation of leaking refrigerant gas (opening without a door, or an opening 0.15% or larger than the respective floor spaces at the top or bottom of the door).

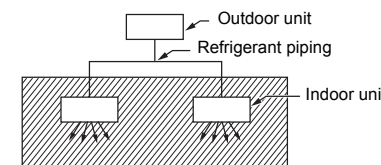

- 3) If an indoor unit is installed in each partitioned room and the refrigerant piping is interconnected, the smallest room of course becomes the object. But when a mechanical ventilation is installed interlocked with a gas leakage detector in the smallest room where the density limit is exceeded, the volume of the next smallest room becomes the object.

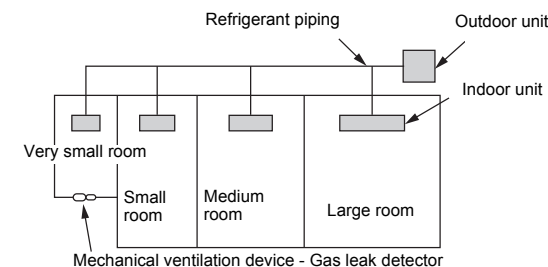

Toshiba Carrier Air-Conditioning Europe Sp. z o.o.

ul. Gdańska 131, 62-200 Gniezno, Poland

2H30250101
(2H30251001)