

TOSHIBA

AIR CONDITIONER (MULTI TYPE)

Owner's Manual

R32

For commercial use

Outdoor Unit

Model name:

<Heat Recovery and Heat Pump Compatible Model>

MMY-SUG0801MT8P-E

MMY-SUG1001MT8P-E

MMY-SUG1201MT8P-E

MMY-SUG1401MT8P-E

MMY-SUG1601MT8P-E

MMY-SUG1801MT8P-E

MMY-SUG2001MT8P-E

MMY-SUG2201MT8P-E

MMY-SUG2401MT8P-E

MMY-SUG0801MT8JP-E

MMY-SUG1001MT8JP-E

MMY-SUG1201MT8JP-E

MMY-SUG1401MT8JP-E

MMY-SUG1601MT8JP-E

MMY-SUG1801MT8JP-E

MMY-SUG2001MT8JP-E

MMY-SUG2201MT8JP-E

MMY-SUG2401MT8JP-E

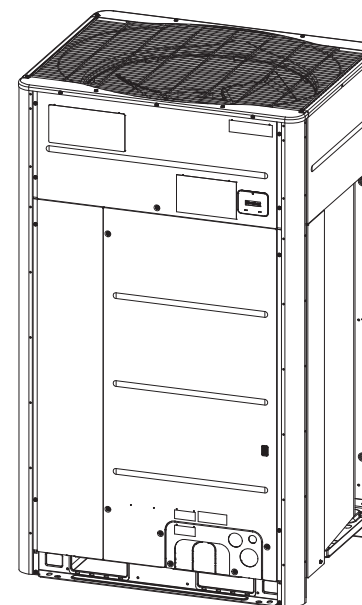

Original instruction

Thank you very much for purchasing TOSHIBA Air Conditioner.
 Please read this owner's manual carefully before using your Air Conditioner.

- Be sure to obtain the "Owner's manual" and "Installation manual" from constructor (or dealer).
- Request to constructor or dealer
- Please clearly explain the contents of the Owner's manual and hand over it.

ADOPTION OF R32 REFRIGERANT

This Air Conditioner has adopted a refrigerant HFC (R32) which does not destroy the ozone layer.

This appliance can be used by children aged from 8 years and above and persons with reduced physical, sensory or mental capabilities or lack of experience and knowledge if they have been given supervision or instruction concerning use of the appliance in a safe way and understand the hazards involved. Children shall not play with the appliance. Cleaning and user maintenance shall not be made by children without supervision.

Contents

1	Precautions for safety	3
2	Part names	7
3	Part names and functions of the remote controller	9
4	Operation	10
5	OFF timer operation	11
6	Louver direction	11
7	Installation	13
8	Notes on operations and performance	13
9	Tips for energy saving and comfortable performance	14
10	Maintenance	15
11	When the following symptoms are found	16
12	Specifications	17
13	Notice code	18

Thank you for purchasing this Toshiba air conditioner.
 Please read carefully through these instructions that important information which complies with the Machinery Directive (Directive 2006/42/EC), and ensure that you understand them.
 After reading these instructions, be sure to keep them in a safe place together with the Owner's Manual and Installation Manual supplied with your product.

Generic Denomination: Air Conditioner

Definition of Qualified Installer or Qualified Service Person

The air conditioner must be installed, maintained, repaired and removed by a qualified installer or qualified service person. When any of these jobs is to be done, ask a qualified installer or qualified service person to do them. A qualified installer or qualified service person is an agent who has the qualifications and knowledge described in the table below.



Agent	Qualifications and knowledge which the agent must have
Qualified installer (*1)	<ul style="list-style-type: none"> • The qualified installer is a person who installs, maintains, relocates and removes the air conditioners made by Toshiba Carrier Corporation. He or she has been trained to install, maintain, relocate and remove the air conditioners made by Toshiba Carrier Corporation or, alternatively, he or she has been instructed in such operations by an individual or individuals who have been trained and is thus thoroughly acquainted with the knowledge related to these operations. • The qualified installer who is allowed to do the electrical work involved in installation, relocation and removal has the qualifications pertaining to this electrical work as stipulated by the local laws and regulations, and he or she is a person who has been trained in matters relating to electrical work on the air conditioners made by Toshiba Carrier Corporation or, alternatively, he or she has been instructed in such matters by an individual or individuals who have been trained and is thus thoroughly acquainted with the knowledge related to this work. • The qualified installer who is allowed to do the refrigerant handling and piping work involved in installation, relocation and removal has the qualifications pertaining to this refrigerant handling and piping work as stipulated by the local laws and regulations, and he or she is a person who has been trained in matters relating to refrigerant handling and piping work on the air conditioners made by Toshiba Carrier Corporation or, alternatively, he or she has been instructed in such matters by an individual or individuals who have been trained and is thus thoroughly acquainted with the knowledge related to this work. • The qualified installer who is allowed to work at heights has been trained in matters relating to working at heights with the air conditioners made by Toshiba Carrier Corporation or, alternatively, he or she has been instructed in such matters by an individual or individuals who have been trained and is thus thoroughly acquainted with the knowledge related to this work.
Qualified service person (*1)	<ul style="list-style-type: none"> • The qualified service person is a person who installs, repairs, maintains, relocates and removes the air conditioners made by Toshiba Carrier Corporation. He or she has been trained to install, repair, maintain, relocate and remove the air conditioners made by Toshiba Carrier Corporation or, alternatively, he or she has been instructed in such operations by an individual or individuals who have been trained and is thus thoroughly acquainted with the knowledge related to these operations. • The qualified service person who is allowed to do the electrical work involved in installation, repair, relocation and removal has the qualifications pertaining to this electrical work as stipulated by the local laws and regulations, and he or she is a person who has been trained in matters relating to electrical work on the air conditioners made by Toshiba Carrier Corporation or, alternatively, he or she has been instructed in such matters by an individual or individuals who have been trained and is thus thoroughly acquainted with the knowledge related to this work. • The qualified service person who is allowed to do the refrigerant handling and piping work involved in installation, repair, relocation and removal has the qualifications pertaining to this refrigerant handling and piping work as stipulated by the local laws and regulations, and he or she is a person who has been trained in matters relating to refrigerant handling and piping work on the air conditioners made by Toshiba Carrier Corporation or, alternatively, he or she has been instructed in such matters by an individual or individuals who have been trained and is thus thoroughly acquainted with the knowledge related to this work. • The qualified service person who is allowed to work at heights has been trained in matters relating to working at heights with the air conditioners made by Toshiba Carrier Corporation or, alternatively, he or she has been instructed in such matters by an individual or individuals who have been trained and is thus thoroughly acquainted with the knowledge related to this work.

Definition of protective gear

When the air conditioner is to be transported, installed, maintained, repaired or removed, wear protective gloves and "Safety" work clothing.
 In addition to such normal protective gear, wear the protective gear described below when undertaking the special work detailed in the table below.
 Failure to wear the proper protective gear is dangerous because you will be more susceptible to injury, burns, electric shocks and other injuries.

Work undertaken	Protective gear worn
All types of work	Protective gloves "Safety" working clothing
Electrical-related work	Gloves to provide protection for electricians Insulating shoes Clothing to provide protection from electric shock
Work done at heights (50 cm or more)	Helmets for use in industry
Transportation of heavy objects	Shoes with additional protective toecap
Repair of outdoor unit	Gloves to provide protection for electricians

These safety cautions describe important matters concerning safety to prevent injury to users or other people and damages to property. Please read through this manual after understanding the contents below (meanings of indications), and be sure to follow the description.





Indication	Meaning of Indication
 WARNING	Text set off in this manner indicates that failure to adhere to the directions in the warning could result in serious bodily harm (1) or loss of life if the product is handled improperly.
 CAUTION	Text set off in this manner indicates that failure to adhere to the directions in the caution could result in slight injury (2) or damage (3) to property if the product is handled improperly.

- 1: Serious bodily harm indicates loss of eyesight, injury, burns, electric shock, bone fracture, poisoning, and other injuries which leave aftereffect and require hospitalization or long-term treatment as an outpatient.
- 2: Slight injury indicates injury, burns, electric shock, and other injuries which do not require hospitalization or long-term treatment as an outpatient.
- 3: Damage to property indicates damage extending to buildings, household effects, domestic livestock, and pets.







Precautions for using R32 refrigerant

These safety cautions describe important matters concerning safety to prevent injury to users or other people and damages to property. Please read through this manual after understanding the contents below (meanings of indications), and be sure to follow the description;
 Meanings of symbols displayed on the unit

MEANINGS OF SYMBOLS DISPLAYED ON THE UNIT

	WARNING (Risk of fire)	This mark is for R32 refrigerant only. Refrigerant type is written on nameplate of outdoor unit. In case that refrigerant type is R32, this unit uses a flammable refrigerant. If refrigerant leaks and comes in contact with fire or heating part, it will create harmful gas and there is risk of fire.
		Read the OWNER'S MANUAL carefully before operation.
		Service personnel are required to carefully read the OWNER'S MANUAL and INSTALLATION MANUAL before operation.
		Further information is available in the OWNER'S MANUAL, INSTALLATION MANUAL, and the like.

Warning indications on the air conditioner unit

Warning indication	Description
 WARNING ELECTRICAL SHOCK HAZARD Disconnect all remote electric power supplies before servicing.	WARNING ELECTRICAL SHOCK HAZARD Disconnect all remote electric power supplies before servicing.
 WARNING Moving parts. Do not operate unit with grille removed. Stop the unit before the servicing.	WARNING Moving parts. Do not operate unit with grille removed. Stop the unit before the servicing.
 CAUTION High temperature parts. You might get burned when removing this panel.	CAUTION High temperature parts. You might get burned when removing this panel.
 CAUTION Do not touch the aluminum fins of the unit. Doing so may result in injury.	CAUTION Do not touch the aluminium fins of the unit. Doing so may result in injury.
 CAUTION BURST HAZARD Open the service valves before the operation, otherwise there might be the burst.	CAUTION BURST HAZARD Open the service valves before the operation, otherwise there might be the burst.
 CAUTION Do not climb onto the fan guard. Doing so may result in injury.	CAUTION Do not climb onto the fan guard. Doing so may result in injury.

1 Precautions for safety

The manufacturer shall not assume any liability for the damage caused by not observing the description of this manual.

WARNING

General

- Carefully read Owner's Manual before starting the air conditioner. There are many important things to keep in mind for daily operation.
- Ask for installation to be performed by the dealer or a professional. Only a qualified installer (*1) is able to install an air conditioner. If a non-qualified person installs an air conditioner, it may result in problems such as fire, electric shock, injury, water leakage, noise and vibration.
- Do not use any refrigerant different from the one specified for complement or replacement. Otherwise, abnormally high pressure may be generated in the refrigeration cycle, which may result in a failure or explosion of the product or an injury to your body.
- Do not install outdoor units where the operation sound may cause a disturbance.
- This appliance is intended to be used by expert or trained users in shops, in light industry, or for commercial use by lay persons.

Transportation and storage

- When transporting the air conditioner, wear shoes with protective toe caps, protective gloves, and other protective clothing.
- When transporting the air conditioner, do not take hold of the bands around the packing carton. You may injure yourself if the bands should break.
- When stacking the packing cartons for storage or transportation, heed the precautions written on the packing cartons. Failure to heed the precautions may cause the stack to collapse.
- You shall ensure that the air conditioner is transported in stable condition. If you find any part of the product broken, contact your dealer.

- The appliance shall be stored in a room without continuously operating ignition sources (for example: open flames, an operating gas appliance or an operating electric heater).
- Do not pierce or burn.
- Be aware that refrigerants may not contain an odour.

Installation

- Only a qualified installer(*1) or qualified service person(*1) is allowed to carry out the electrical work of the air conditioner. Under no circumstances must this work be done by an unqualified individual since failure to carry out the work properly may result in electric shocks and/or electrical leaks.
- After the installation work has been completed, have the installer explain about the circuit breaker positions. In the event that error has occurred in the air conditioner, set the circuit breaker to the OFF position, and contact a service person.
- This product uses R32 refrigerant which is A2L. Please refer to the installation manual for the size of the room that can be installed. Depending on the conditions, safety equipment must be installed. When implementing measures, please consult the dealer who purchased the air conditioner.
- Do not install the air conditioner in a location that may be subject to a risk of exposure to a combustible gas. If a combustible gas leaks and becomes concentrated around the unit, a fire may occur.
- Be sure to use the company-specified products for the separately purchased parts. Use of non-specified products may result in fire, electric shock, water leakage, etc. Have the installation performed by a professional.
- Confirm that earthing is performed correctly.

Operation

- When a refrigerant leak detector is installed, for refrigerant leak detector to be effective, the unit must be electrically powered at all times after installation, other than when servicing.
- Before opening the intake grille of the indoor unit or service panel of the outdoor unit, set the circuit breaker to the OFF position. Failure to set the circuit breaker to the OFF position may result in electric shocks through contact with the interior parts. Only a qualified installer (*1) or qualified service person (*1) is allowed to remove the intake grille of the indoor unit or service panel of the outdoor unit and do the work required.
- Inside the air conditioner are high-voltage areas and rotating parts. Due to the danger of electric shocks or of your fingers or physical objects becoming trapped in the rotating parts, do not remove the intake grille of the indoor unit or service panel of the outdoor unit. When work involving the removal of these parts is required, contact a qualified installer or a qualified service person.
- Do not move or repair any unit by yourself. Since there is high voltage inside the unit, you may get electric shock when removing the cover and main unit.
- Use of a stand more than 50 cm high to clean the filter of the indoor unit or to carry out other such jobs constitutes working at heights. Due to the danger of falling off the stand and injuring yourself while working at heights, this kind of work should not be done by unqualified individuals. When this kind of work must be carried out, do not do it yourself but ask a qualified installer or a qualified service person to do it for you.
- Do not touch the aluminum fin of the outdoor unit. You may injure yourself if you do so. If the fin must be touched, do not touch it yourself but contact a qualified installer or a qualified service person.
- Do not climb onto or place objects on top of the outdoor unit. You may fall or the objects may fall off of the outdoor unit and result in injury.

- Do not place any combustion appliance in a place where it is directly exposed to the wind of air conditioner, otherwise it may cause imperfect combustion.
- When the air conditioner is operated with a combustion appliance in the same place, be careful of ventilation to let fresh air enter the room. Poor ventilation causes oxygen shortage.
- When the air conditioner is used in a closed room, be careful of sufficient ventilation of the room. Poor ventilation causes oxygen shortage.
- Do not expose your body to cool air directly for a long time and do not cool yourself excessively. Doing so may result in deteriorated physical condition and ill health.
- Never insert your finger or a stick into the air intake or discharge. Doing so may result injury as the fan is rotating at high speed inside the unit.
- Consult the shop where you purchased the air conditioner if air conditioning (cooling and heating) is not performed properly as a refrigerant leakage may be the cause. Confirm the repair details with a qualified service person(*1) when the repair includes additional charging of the refrigerant.
- Be sure to stop running the air conditioner and turn off the breaker before cleaning. Otherwise, injury may result as the fan is rotating at high speed inside the unit.
- Do not use means to accelerate the defrosting process or to clean, other than those recommended by the manufacturer.
- If check codes “J29” or “J31” appear on the remote controller LCD (Liquid Crystal Display), replace Leak Detector or Refrigerant sensor module (service part). Contact the dealer where you purchased the air conditioner to replace Leak Detector or Refrigerant sensor module (service part). Continuing to use the air conditioner in the status above may cause a fire in case refrigerant leak occurs.
- Do not use combustion appliances near the air conditioner if there is the risk of R32 refrigerant leak.

- When there is the risk of R32 refrigerant leak, do not use a combustion appliance near the air conditioner. Check codes “J30” appear on the remote controller LCD when a refrigerant leak is detected. Then, depending on the installation conditions, the indoor unit fan will automatically operate even if the air conditioner is not operating, and it will not turn off even if you pushed the ON/OFF button the circuit breaker, and contact the dealer where you purchased the product.

Repairs

- When you have noticed that some kind of error (such as when an error display has appeared, there is a smell of burning, abnormal sounds are heard, the air conditioner fails to cool or heat or water is leaking) has occurred in the air conditioner, do not touch the air conditioner yourself but set the circuit breaker to the OFF position, and contact a qualified service person. Take steps to ensure that the power will not be turned on (by marking “out of service” near the circuit breaker, for instance) until qualified service person arrives. Continuing to use the air conditioner in the error status may cause mechanical problems to escalate or result in electric shocks, etc.
- Do not turn off the power immediately when the alarm buzzer on the leak detector rings. The safety measures may not work properly. Contact your service representative.
- If you have discovered that the fan grille is damaged, do not approach the outdoor unit but set the circuit breaker to the OFF position, and contact a qualified service person to have the repairs done. Do not set the circuit breaker to the ON position until the repairs are completed.
- If you have discovered that there is a danger of the indoor unit’s falling, do not approach the indoor unit but set the circuit breaker to the OFF position, and contact a qualified installer or a qualified service person to refit the unit. Do not set the circuit breaker to the ON position until the unit has been refitted.

- If you have discovered that there is a danger of the outdoor unit’s toppling over, do not approach the outdoor unit but set the circuit breaker to the OFF position, and contact a qualified installer or a qualified service person to have the improvements or refitting done. Do not set the circuit breaker to the ON position until the improvements or refitting is completed.
- Do not customize the unit. Doing so may result in fire, electric shock, etc.

Relocation

- When the air conditioner is to be relocated, do not relocate it yourself but contact a qualified installer or a qualified service person. Failure to relocate the air conditioner properly may result in electric shocks and/or a fire.

(*1) Refer to the “Definition of Qualified Installer or Qualified Service Person.”

⚠ CAUTION

To disconnect the appliance from the main supply

- This appliance must be connected to the mains by means of a switch with a contact separation of at least 3 mm.

Installation

- Certainly lay the drain hose for perfect draining. Bad drainage may cause flooding in the house and getting furniture wet.
- Make sure to connect the air conditioner to an exclusive power supply of the rated voltage, otherwise the unit may break down or cause a fire.
- Confirm that the outdoor unit are fixed on the base. Otherwise, falling down of the units or other accidents may occur.
- Do not install the air conditioner in place where steam is generated, or in place near the humidifier etc. Dew may form in the parts built in the unit, causing trouble of the unit.

Operation

- Do not use this air conditioner for special purpose such as preserving food, precision instruments, art objects, breeding animals, car, vessel, etc.
- Do not touch any switches with wet finger, otherwise you may get an electric shock.
- This unit is equipped with electrically powered safety measures. To be effective, the unit must be electrically powered at all times after installation, other than when servicing.
- To make the air conditioner operate in its original performance, operate it within the range of the operating temperature specified in the instructions. Otherwise it may cause a malfunction, or water leak from the unit.
- Prevent any liquid from falling into the remote controller and the leak detector. Do not spill juice, water or any kind of liquid.
- Do not wash the air conditioner. Doing so may result in electric shock.
- Check whether the installation base and other equipment have become deteriorated after being used for a long time. Leaving them such condition may result in the unit's falling down and causing injury.
- Do not leave flammable sprays or other flammable materials near the air conditioner, and do not spray flammable aerosol directly to the air conditioner. They may catch fire.
- Be sure to stop running the air conditioner and turn off the breaker before cleaning. Otherwise, injury may result as the fan is rotating at high speed inside the unit.
- Do not put a water container such as a vase on the unit. Water intrusion into the unit may occur and it may cause deterioration of electric insulation and result in electric shock.
- Ask for cleaning of the air conditioner to be performed by the dealer. Cleaning the air conditioner in an improper manner may cause damage to plastic parts, insulation failure of electric parts, etc. and result in a malfunction. In the worst case, it may result in water leakage, electric shock, smoke emission and fire.

- Do not wash air conditioners with pressure washers. Electric leaks may cause electric shocks or fires.
 - Do not install the air conditioner in a place where smoke, chemical agent, or organic solvent is present. Do not use gas equipment using combustion gas (LPG etc.) such as propane, butane, or methane, an insecticide, or sprays or paints containing siloxane, near the indoor unit. Leak Detector works mistakenly, causing air conditioner not to operate.
 - Be careful of indoor unit fan operation when the circuit breaker is turned on. If Leak Detector works, a fan automatically under certain installation condition even when the air conditioner not operated, be careful not to be injured.
 - When changing the floor plan or partition, the floor area should be at least the minimum floor area described in the outdoor unit Installation Manual.
 - Replace Leak Detector if ten years have passed after an air conditioner had been installed. Contact the dealer where you purchased the air conditioner to replace the Leak Detector. It may exceed its life of the product.
-

■ Connectable indoor units

Model type	Model Name
4-Way Cassette	MMU-UP****H*
Compact 4-Way Cassette	MMU-UP****MH*
2-Way Cassette	MMU-UP****WH*
1-Way Cassette	MMU-UP****YH*
	MMU-UP****SH*
Concealed Duct, Standard	MMD-UP****BH*
Concealed Duct, High Static Pressure	MMD-UP****H*
Slim Duct	MMD-UP****SPH*
Under Ceiling	MMC-UP****H*
Fresh Air Intake	MMD-UP****HFP*
	* For details on these models, read the owner's manuals that come with the indoor units.
High-Wall	MMK-UP****H*
	* For details on these models, read the owner's manuals that come with the indoor units.
PMV Less High-Wall	MMK-UP****HPL*
	* For details on these models, read the owner's manuals that come with the indoor units.
Hot Water Module	MMW-UP****LQ*
	* For details on these models, read the owner's manuals that come with the indoor units.

2 Part names

■ Outdoor unit

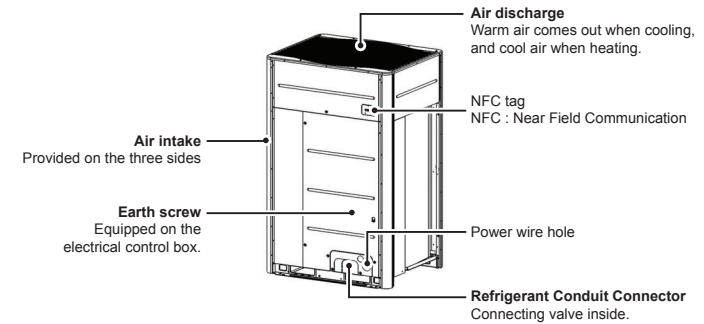

■ Indoor unit

◆ 4-Way Cassette Type

MMU-UP****H*

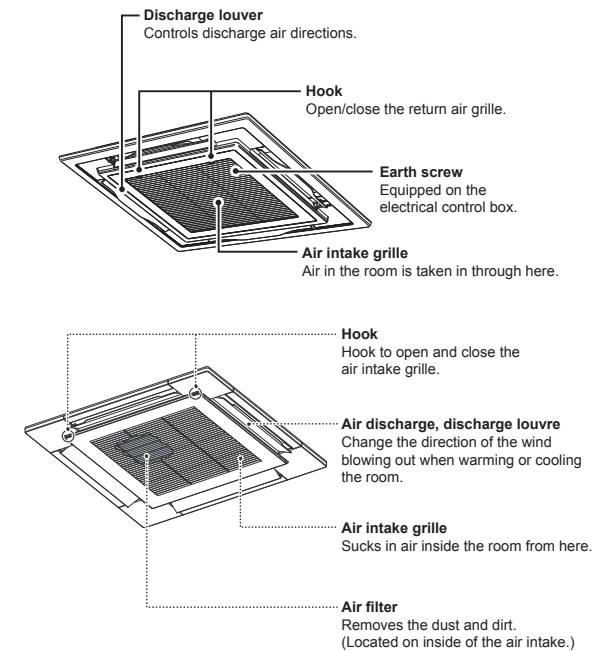

◆ Compact 4-Way cassette Type

MMU-UP***MH*

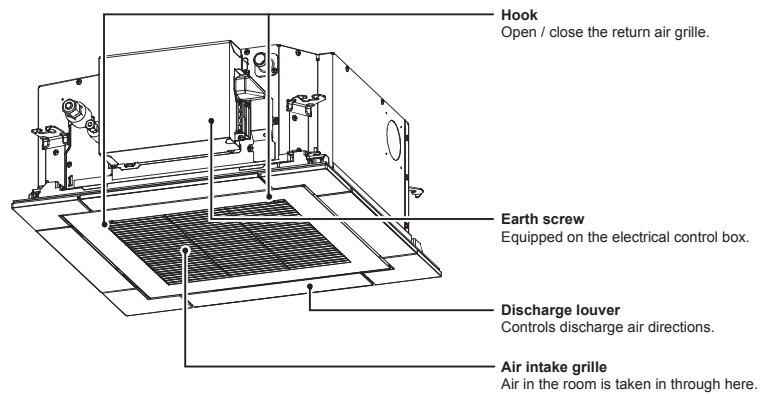

◆ 2-way Cassette Type

MMU-UP***WH*

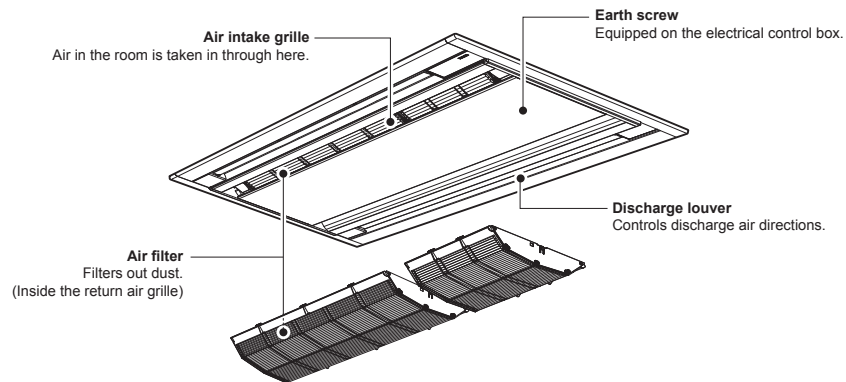

◆ 1-way Cassette Type

MMU-UP***YH*

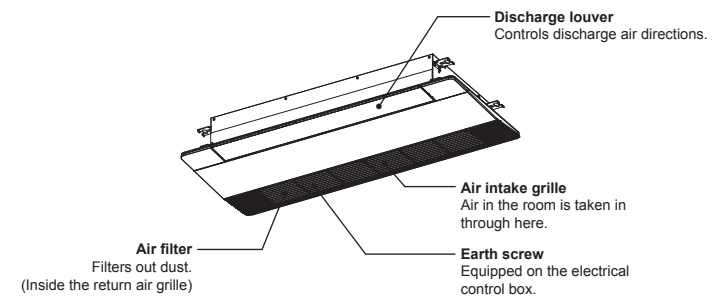

MMU-UP***SH*

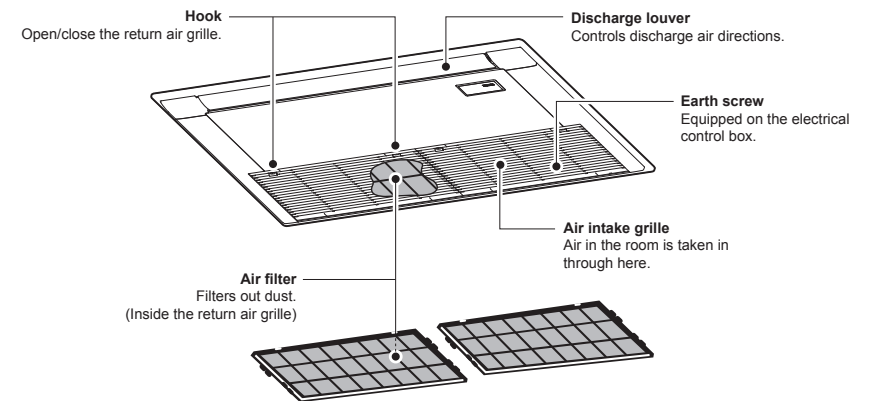

◆ Concealed Duct Standard Type

MMD-UP***BH*

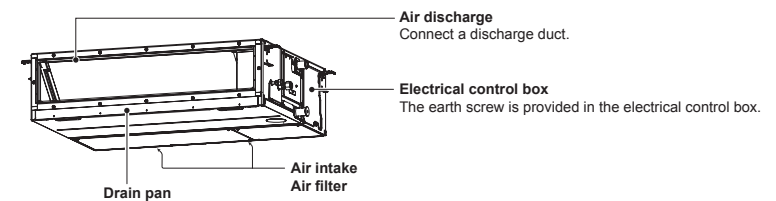

◆ Concealed Duct High Static Pressure Type

MMD-UP018*H* - MMU-UP056*H*

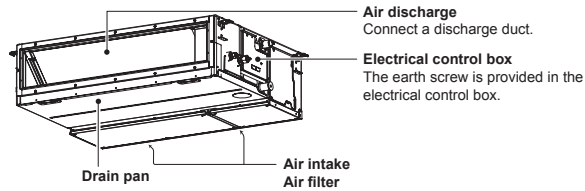

MMD-UP072*H* - MMU-UP096*H*

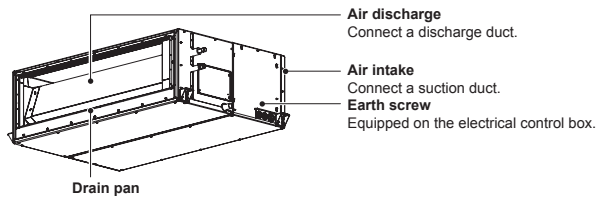

◆ Slim Duct Type

MMD-UP****SPH*

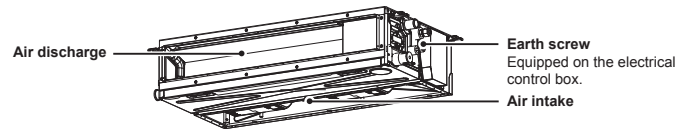

◆ Under Ceiling Type

MMC-UP****H*

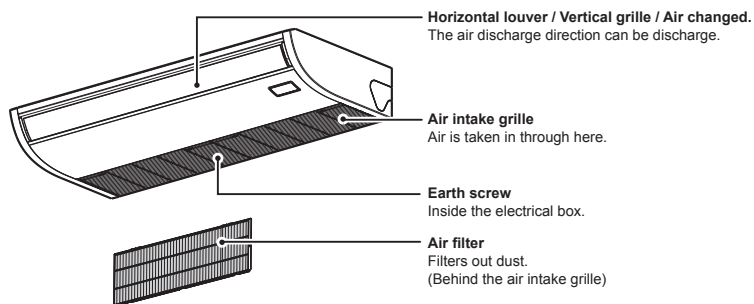

3 Part names and functions of the remote controller

Remote controller model name : RBC-ASCU11-E

LCD backlight lights for 15 seconds during remote controller operation.
All indicators are displayed in the display example below.
Actually, only the selected options will be displayed.

■ Operations

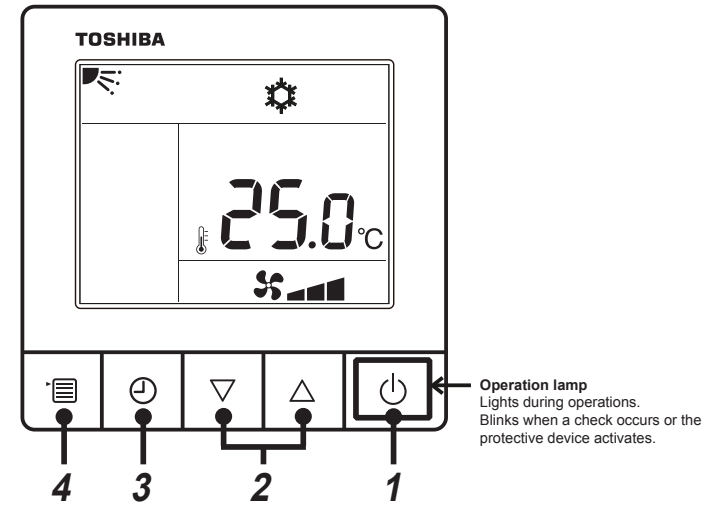

- 1 ON/OFF button**
Turns on the unit when pushed, and turns off when pushed again.
- 2 Setting button**
Sets setting temperature at the normal mode.
Changes each setting at the Operation mode, the Fan speed mode or the Wind direction mode.
- 3 OFF timer button**
Setting the OFF timer.
- 4 Menu button**
Selects the Operation mode select, the Fan speed select or the Wind direction select.
Each time you push the button, indicator is displayed as followings.
• The Fan speed select or the Wind direction select is not displayed depending on indoor unit models.

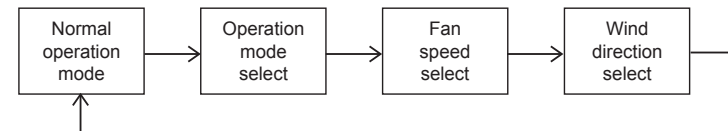

■ Indicators

All icons on the display are shown for this explanation. Operations are not accepted when "SETTING" is flashing.

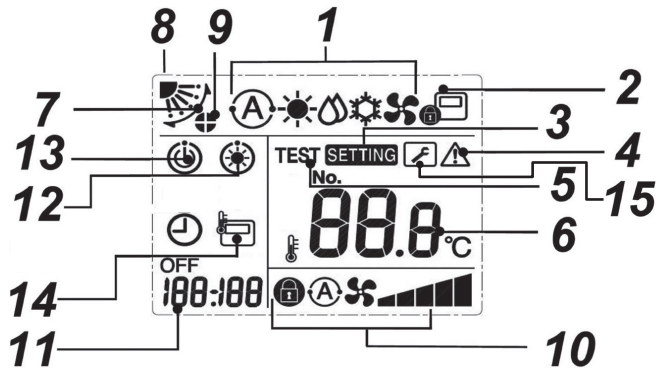

- 1 Operation mode indicator**
Indicates the operation mode selected.
- 2 Central control indicator**
Displayed when the air conditioner is controlled centrally and used with central control devices such as the central remote controller. If the use of the remote controller is prohibited by the central control, the icon blinks when the ON/OFF, MODE, or TEMP. button on the remote controller is pushed, and the buttons do not function. (Settings that can be configured on the remote controller differ depending on the mode of the central control. For details, read the Owner's Manual of the central remote controller.)
- 3 Setting indicator**
Indicates that the model is being checked automatically after a breaker is thrown or some other occurrence.
- 4 Service indicator**
Displayed while the protective device works or a check occurs.
- 5 Test run indicator**
Displayed during test run.
- 6 Temperature setting indicator**
The selected set temperature is displayed.
- 7 Swing indicator**
Displayed during up/down movement of the louver.
- 8 Louver position indicator**
Indicates the louver position.
- 9 Louver lock indicator**
Displayed when there is a louver-locked unit. (4-way cassette type and Compact 4-way cassette Type only.)
- 10 Fan speed indicator**
Indicates the selected fan speed
Auto
Low
Low +
Med.
Med. +
High
Fix
- 11 OFF timer indicator**
When a trouble occurs, a check code is displayed.
- 12 Pre-heat indicator**
Displayed when the heating mode is energized or defrost cycle is initiated. While this indication is displayed, the indoor fan stops or operate in fan mode.
- 13 Operation standby indicator**
Indicates that the Super Modular Multi System cannot cool if a different indoor unit is heating or cannot heat if one is cooling; and that the Super Heat Recovery Multi cannot heat or cool because the outside temperature is outside the operating range.
- 14 Remote controller sensor indicator**
Displayed while the sensor of the remote controller is used.
- 15 Notice display**
Displayed while notice code occurs.

4 Operation

When you use the air conditioner for the first time or change the settings, follow the procedures below. From next time, pushing the ON/OFF button starts running of the air conditioner with the chosen settings.

■ Standby

Operations are not accepted when "SETTING" is blinking.

REQUIREMENT

- Keep the power switch turned on during use.
- When you resume using the air conditioner after a long period of disuse, turn on the power switch at least 12 hours before starting running.
- When the power is turned on, it takes about 1 minute before the remote controller becomes operable. This is not a malfunction.

■ Running operation

Some operation modes are not available depending on the type of indoor unit.

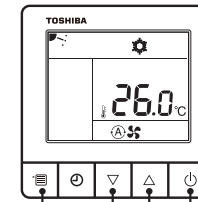

Menu button Setting button ON/OFF button

- 1 ON/OFF button**
Push this button to light the operation lamp and start operations.
When heating
 - The heated air comes out after a 3 to 5 minutes of pre-heating with the indoor fan kept turned off.
- 2 Select the operation mode**
Push the Menu button several times to select the operation mode.
 - The current operation mode flashes. Each time you push the setting button, the operation mode and its icon change in the following order:
- 3 Select the fan speed**
Push the Menu button several times to select the fan speed mode.
 - The current fan speed indicator flashes. Each time you push the setting button, the fan speed mode and its indication change in the following order:
 - A selectable fan speed differs depending on indoor units to be connected.
 - "Auto" cannot be selected at the Fan mode.
 - "Auto" is displayed for models capable of the fan speed setting.
 - If you do not push any button for 30s, the fan speed mode finishes.
 - If you do not push any button for 30s, the operation mode finishes.
- 4 Select the temperature**
Push the setting button to adjust the temperature.
 - The temperature setting range is 18.0°C to 29.0°C.
 - The temperature can be set in steps of 0.5°C.

[Heat recovery type]

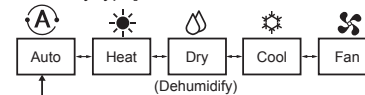

[Heat pump type]

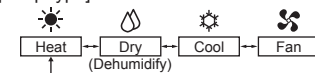

- "Auto" can only be displayed for the heat recovery type.
- With the Concealed Duct High Static Pressure Type, "Dry" is not available.
- If you do not push any button for 30s, the operation mode finishes.

NOTE

When cooling
Running starts in approximately 1 minute.

When heating

- The air conditioner may continue running in the fan operation for about 30 seconds after stopping heating.
- The heated air comes out after a 3 to 5 minutes of pre-heating with the indoor fan kept turned off. (The pre-heat indicator "⊕" is displayed on the remote controller.)

The temperature sensor detects the return air temperature at the indoor unit, which may slightly differ from the actual room temperature depending on installation condition. Set temperature is a target of room temperature.

5 OFF timer operation

OFF timer : The indoor unit stops when the set time is reached.

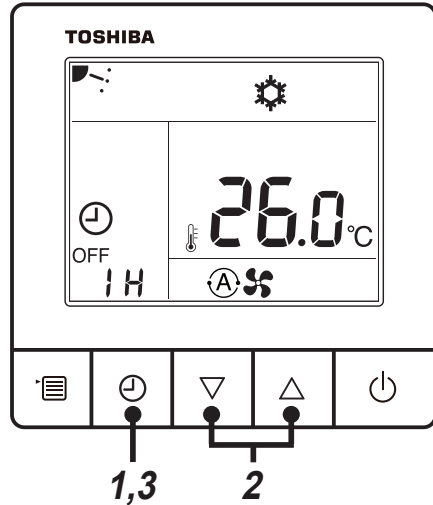

1 OFF timer button

Push the OFF timer button during air conditioning operation.

- “OFF” and “OFF” light and “SETTING” and timer indicator flash.

2 Select the OFF timer time

Push the setting button to set the time.

- The OFF timer time can be set to 0.5h (30 min), 1h, 2h, ... up to 24h.
- If you do not push any button for 30s, the OFF timer setting will be cancelled.

3 Push the OFF timer button

“SETTING” disappears, the timer indicator changes from flashing to lighting, and the OFF timer starts.

- The timer indicator on the OFF timer operation is displayed with countdown.

■ Cancelling the timer

1 Push the OFF timer button.

The timer indicator disappears.

NOTE

- Even if air conditioning is turned on or off with the ON/OFF button during OFF timer operation, the OFF timer operation continues.

6 Louver direction

NOTE

To improve the cooling / heating performance, change the louver angle for each operation.

The characteristics of air: Cool air falls, and warm air rises.

⚠ CAUTION

Point the louver horizontally during cooling

If pointing downward for cooling, dew may form on the surface of the air discharge or louver and may drop down.

NOTE

- If pointing horizontally for cooling, dew may form on the surface of the cabinet or louver and may drop down.
- If pointing horizontally for heating, the room temperature may be uneven.
- Do not handle the louver manually.
- Doing so may cause a failure.
- Use the remote controller to adjust the angle.

◆ To set the louver direction and auto swing

1 Push the Menu button several times and select the wind direction mode to blink the wind direction.

Then, push the setting button several times to display the louver direction as shown in the figure below.

- If you do not push any button for 30s, the wind direction mode finishes.

▼ For heating

The louver can be adjusted to six steps.

Point the louver downward. If not pointing downward, hot air may not reach the floor.

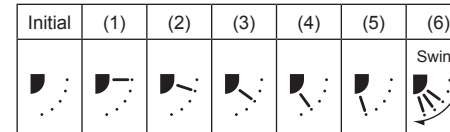

Operation mode	Available directions
HEAT, FAN,	(1) ⇄ (2) ⇄ (3) ⇄ (4) ⇄ (5) ⇄ (6)

▼ For cooling

The louver can be adjusted to four steps.

Point the louver horizontally. If pointing downward, dew may form on the surface of the air discharge port and may drop down.

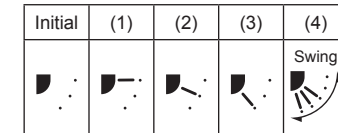

Operation mode	Available directions
COOL, DRY,	(1) ⇄ (2) ⇄ (3) ⇄ (4)

▼ For fan

The louver can be adjusted to six steps.

Select a wind direction.

■ Auto swing

The SWING indicator is displayed and the louver begins swinging.

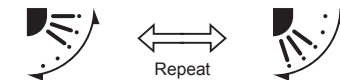

■ 4-way cassette type

▼ When cooling

Point the louver horizontally.

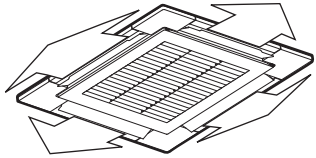

▼ When heating

Point the louver downward.

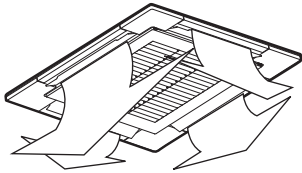

- The louver automatically closes when running is stopped.
- In pre-heating mode, the louver points upward. The swing indication appears on the remote controller even in pre-heating mode, but the actual swing starts only after pre-heating is complete.

■ 2-way cassette type

▼ When cooling

Point the louver horizontally to send cool air across the entire room.

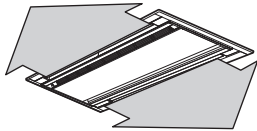

▼ When heating

Point the louver downward to send heated air to the floor.

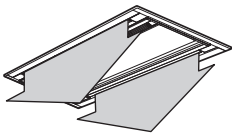

■ 1-way cassette type (SH series)

▼ When cooling

Point the louver horizontally to send cool air across the entire room.

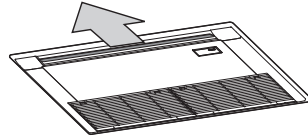

▼ When heating

Point the louver downward to send heated air to the floor.

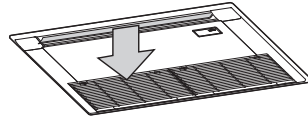

- The louver automatically closes when running is stopped.
- In pre-heating mode, the louver points upward. The swing indication appears on the remote controller even in pre-heating mode, but the actual swing starts only after pre-heating is complete.

■ Under ceiling type

Vertical adjustment

▼ When cooling

Point the louver horizontally to send cool air across the entire room.

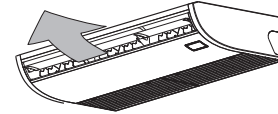

▼ When heating

Point the louver downward to send heated air to the floor.

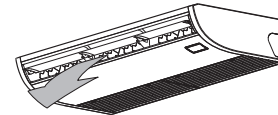

- The louver automatically closes when running is stopped.
- In pre-heating mode, the louver points upward. The swing indication appears on the remote controller even in pre-heating mode, but the actual swing starts only after pre-heating is complete.

Horizontal air flow adjustment

To change the horizontal air flow direction, point the vertical louvers inside the horizontal louver in your preferred direction.

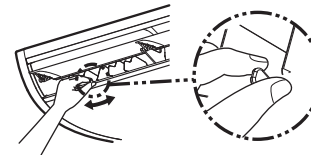

NOTE

- When the horizontal louver is pointing downward in COOL mode, water droplets may form on the surface of the cabinet or louver and drop down.
- When the horizontal louver is pointing horizontally in HEAT mode, the air may not warm up the room evenly.

7 Installation

■ Location

- Avoid installing near machines emitting high frequency waves.
 - Not suitable for chemical plants such as liquefied carbon dioxide refrigerant plants.
 - Do not install the air conditioner in locations where iron or other metal dust is present. If iron or other metal dust adheres to or collects on the interior of the air conditioner, it may spontaneously combust and start a fire.
 - A failure may occur in certain locations such as the following:
 - Areas with large amount of oil droplets (including machine oil) or vapors
 - Salty areas near oceans, etc.
 - Hot springs emitting sulfidizing gas, etc.
 - Heavily acidic or alkaline places. (e.g. place disinfection solution is frequently sprayed at)
- Special maintenance or parts are required for use in the above places. For details, contact the dealer where you purchased the product.
- Leave an enough space around the air intake and discharge of the outdoor unit so that the ventilation is not restricted.
 - Avoid places where strong wind may blow against the air intake and discharge of the outdoor unit.
 - Attach a snow stand, snow hood, etc. to the outdoor unit for use in snowfall areas. For details, contact the dealer where you purchased the product.
 - Make sure drain water from the outdoor unit is emitted into places with good drainage.
 - Make sure the air filter is attached to the indoor unit. If not, dust may accumulate on the heat exchanger or other parts in the air conditioner and cause a water leak.
 - Keep a distance of at least 1 m between the air conditioner / remote controller and a TV or radio. Failure to observe this precaution may cause visual disturbance or noise.
 - Leave a distance of at least 1.5 m between the air discharge and a fire alarm. If this precaution is not observed, the alarm may not work properly or detect fire in case of fire.
 - This model uses R32 refrigerant, and the floor area and ventilation specifications are stipulated by law to ensure safety. If you want to change the layout of the room, the partition, the ventilation port or the ventilation equipment, please consult your dealer.

■ Be careful of operation sounds

- Locate the unit in a place secure enough so that the sounds and vibrations do not increase.
- If something is placed near the air discharge of the outdoor unit, noise may increase.
- Be careful not to disturb your neighbors with cool / warm air or noise coming from the air discharge of the outdoor unit.

8 Notes on operations and performance

■ Check before operation

- Turn on the power switch at least 12 hours before starting operation.
- Make sure the earth wire is securely connected.
- Make sure the air filter is attached to the indoor unit.

■ Heating performance

- A heat pump system, which gathers outside heat and emits it into a room, is used for heating. When the outside air temperature falls, the heating capacity of the unit is reduced.
- When the outside temperature is low, it is recommended that you also use other heating equipment.

■ Defrosting during heating

- If frost falls on the outdoor unit during heating, defrosting is automatically performed (for approximately 2 - 10 minutes) to increase the heating effect.
- The fan of the indoor unit is stopped during defrosting.

■ 3-minute protection

The outdoor unit will not operate for approximately 3 minutes after the air conditioner has been immediately restarted after stopping, or the power switch has been turned on. This is to protect the system.

■ Power failure

- In the case of a power failure, all operations stop.
- To resume operations, push the ON / OFF button.

■ Fan rotation of a stopped indoor unit

- While other indoor units operate, the fans on indoor units in stand-by mode rotate for several minutes approximately once per one hour to protect the machines.

■ Protective device (High pressure switch)

The high pressure switch stops the air conditioner automatically when excessive load is applied to the air conditioner.

If the protective device activates, the unit's running stops and the operation lamp blinks. When the protective device activates, the  indicator and the check code are displayed on the remote controller.

The protective device may activate in the following cases:

During cooling

- When the air intake or air discharge of the outdoor unit is blocked.
- When strong wind blows continuously against the air discharge of the outdoor unit.

During heating

- When dust or dirt is excessively adhered to the air filter of the indoor unit.
- When the air discharge of the indoor unit is blocked.

NOTE

When the protective device activates, turn off the power switch, remove the cause, and then restart running.

■ Cooling / Heating operations

- When the outdoor temperature goes out of the operable range, cooling or heating operation may not be performed in order to protect the equipment. In this case, “⊕” goes on.
- If the outside temperature decreases during operation, the fan of the outdoor unit may stop.

■ Characteristics of heating

- Air does not come out immediately after heating starts. Heated air comes out after 3 to 5 minutes (depending on the room/outside temperatures), after the indoor heat exchanger warms up.
- When the outside temperature increases, the outdoor unit may stop.
- While an indoor unit is running in the heating mode, the outdoor unit supplies refrigerant to the other indoor units which are not running. There, noise may come from the other indoor units or the exterior of them may become warm.
- If the Fan operation is performed while the Heat operation is performed in another room, the fan does not run.

■ Prohibition of NFC function (NFC tag)

NFC communications is enabled at the time of shipping from the factory, but it is possible to disable the test run with a smart phone.

Please consult dealer from where you purchased it for more details.

■ Caution for indoor units using R32 refrigerant.

- This unit is equipped with safety measures that use a power supply. After installation, the unit shall always be powered on, except during service.
- When the option product "leak detector" detects the leakage of refrigerant, "J30" is displayed on the remote controller, and the fan of the indoor unit is operated to prevent the refrigerant from staying, and even if the ON / OFF operation button on the remote controller is pressed. Will not stop. In such a case, ventilate the room without turning off the power and contact the store immediately. Also, do not use burning appliances such as stoves.
- Don't use gas equipments (propane, methane, etc.) that uses flammable gas, pesticides, flammable gas such as hair spray (LPG, etc.), and spray used siloxane, drugs, chemicals, and paints etc. near a leak detector, since it may cause false detection of refrigerant leakage.

9 Tips for energy saving and comfortable performance

To save energy and perform comfortable cooling and heating

Clean the air filter often

- A clogged air filter lowers the cooling / heating performance.

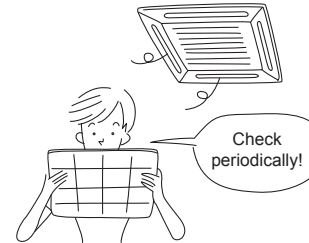

Do not cool / heat too much

⚠ WARNING

Do not expose your body to cool air directly for a long time and do not cool yourself excessively. Doing so may result in deteriorated physical condition and ill health.

- Cooling / Heating too much is bad for your health. In particular, take care with handicapped / old people and children.



Close windows and doors

- Do not let cooled / heated air escape from the room.

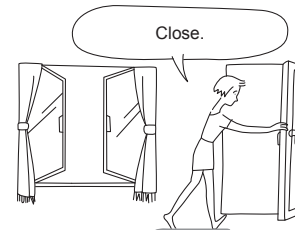

Cool / Heat the room evenly

- Adjust the air direction with the louver. Exposing yourself to blowing air directly for a long time is bad for your health.

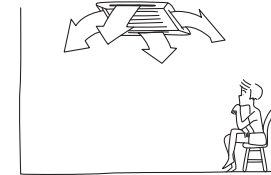

Air conditioner operating conditions

For proper performance, operate the air conditioner under the following temperature conditions:

Cooling operation	Outdoor temperature	: -15°C to 50°C (Dry-bulb temp.)
	Room temperature	
Heating operation	Outdoor temperature	: -25°C to 15.5°C (Wet-bulb temp.)
	Room temperature	

[CAUTION] Room relative humidity: less than 80%. If the air conditioner operates in excess of this figure, the surface of the air conditioner may cause dewing.

If air conditioner is used outside of the above conditions, safety protection may operate.

10 Maintenance

WARNING

For daily maintenance including Air Filter cleaning, make sure to ask the qualified service person particularly following models;

- 4-way cassette type
- Compact 4-way cassette type
- 2-way cassette type
- 1-way cassette type
- Under ceiling type
- Concealed duct standard type
- Concealed duct high static type
- Fresh air intake type
- Slim duct type
- Hot water module type

CAUTION

Do not push buttons with wet hands. Doing so may result in electric shock.

Cleaning the air filters

- When the filter indicator is displayed on the remote controller, clean the air filters.
- Ask qualified service person to clean the filters for the models listed in the warning on the top of this chapter.
- Clogged filters may lower the cooling and heating performance.

■ Cleaning the indoor unit and remote controller

- Ask qualified service person to clean the indoor units for the models listed in the warning on the top of this chapter.
- Wipe with a dry, soft cloth. Do not use acidic or alkaline detergents.
- If heavily stained, wipe off dirt with a cloth soaked in lukewarm water. (Do not use water to wipe the remote controller)
- Do not use benzine, thinner, scouring powder, chemical cloth, etc. as those may cause deformation or breakage.



■ If unused for over a month

- Leave the fan on for half a day or so to dry the inside.
- Turn off the main power switch.
- Clean the air filter and then attach it.
- Turn on the power again. (In case of R32 refrigerant model)

■ Periodic inspection

- After being used for a long period of time, the parts may deteriorate or malfunction, or the drainage may worsen, due to heat, moisture, dust, or general usage.
- In addition to the maintenance, it is recommended that you have a inspection (charges apply) performed by the dealer where you purchased the unit, etc.

CAUTION

- **Perform high-pressure cleaning for the heat exchanger.**
If commercially available detergent (strong alkaline or acid cleaning agent) is used, the surface treatment of the heat exchanger will deteriorate, which may degrade the self cleaning performance. For details, contact our sales department or the dealer where you purchased the unit.

■ Before the cooling season

Ask a qualified service person to clean the drain pan

CAUTION

Clean the drain pan
Without cleaning, the drain pan may be filled with waste, and water may overflow onto the ceiling or floor.

If you do not plan to use the unit for more than 1 month

- (1) Operate "Fan" mode.
Run the fan for about half a day to dry the inside fully.
- (2) Stop the air conditioner.
- (3) Turn off the main power switch.
(R410A refrigerant model)
Turn on the main power switch.
(R32 refrigerant model)

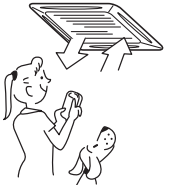

Checks before operation

- (1) Check that the air filters are installed.
- (2) Check that the air discharge or intake is not blocked.
- (3) Turn on the main power switch.

11 When the following symptoms are found

Check the points described below before asking repair servicing.

Symptom	Cause
<p>Outdoor unit</p> <ul style="list-style-type: none"> White misty cold air or water is out. Sometimes, noise of air leak is heard. "Swish" sound is heard sometimes. Slight clacking sound is heard. Discharge air smells. 	<ul style="list-style-type: none"> Fan of the outdoor unit stops automatically and performs defrost operation. Solenoid valve works when defrost operation starts or finishes. When the operation has started, during the operation, or immediately after the operation has stopped, a sound such as water flows may be heard, and the operation sound may become larger for 2 or 3 minutes immediately after the operation has started. They are flowing sound of refrigerant or draining sound of dehumidifier. This is sound generated when heat exchanger, etc. expand and contract slightly due to change of temperature. Various smell such as one of wall, carpet, clothes, cigarette, or cosmetics adhere to the air conditioner. Is outdoor temperature out of operation temperature range?
<p>Indoor unit</p> <ul style="list-style-type: none"> "Ⓞ" indication is lit. "Ⓜ" indication is lit. "Ⓢ" indication is lit. Sound or cool air is output from the stand by indoor unit. When power of the air conditioner is turned on, "Ticktock" sound is heard. LCD blurs when it is touched. Fan and louvers of the indoor unit moves when the unit is not operated. 	<ul style="list-style-type: none"> When cooling operation cannot be performed because another indoor unit performs heating operation. (Heat pump only) When the manager of the air conditioner has fixed the operation to COOL or HEAT, and an operation contrary to the setup operation is performed. When stopping the fan to prevent cool air blow at starting heating. Since refrigerant is flowed temporarily to prevent stay of oil or refrigerant in the stand by indoor unit, sound of flowing refrigerant, may be heard or white steam when other indoor unit operates in Heat mode, and cold air in Cool mode may be blow-out. Sound is generated when the expansion valve operates when power has been turned on. LCD may temporarily blur by static electricity. Intermittent operation of the fan with louvers open is sometimes carried out for the refrigerant recovery control of unoperated unit.
Stops automatically.	<ul style="list-style-type: none"> Is the timer "OFF"?
Does not operate.	<ul style="list-style-type: none"> Is it a power failure? Is the power switch turned off? Is the power fuse or breaker blown? Has the protective device operated? (The operation lamp goes on.) Is the timer "ON"? (The operation lamp goes on.) Are Cool and Heat selected simultaneously? (Heat pump only) ("Ⓞ" indication is lit on the display of the remote controller.) Is outdoor temperature out of operation temperature range?
Air is not cooled or warmed sufficiently.	<ul style="list-style-type: none"> Is the air intake or air discharge of the outdoor unit obstructed? Are any door or window open? Is the air filter clogged with dust? Is discharge louver of the indoor unit set at appropriate position? Is air selection set to "Low" "Med", and is the operation mode set to "Fan"? Is the setup temp. the appropriate temperature? Are Cool and Heat selected simultaneously? (Heat pump only) ("Ⓞ" indication is lit on the display of the remote controller.) Is outdoor temperature out of operation temperature range?

It is not a failure.

Check again.

⚠ CAUTION

If any of the following conditions occur, turn off the main power supply switch and immediately contact the dealer:

- Switch operation does not work properly.
- The main power fuse often blows out, or the circuit breaker is often activated.
- A foreign matter or water fall inside the air conditioner.
- When the air conditioner does not operate even after the cause of the protective device activation has been removed.
- Any other unusual conditions are observed.

■ Confirmation and check

If a problem occurs with the air conditioner, the OFF timer indicator alternately shows the check code and the indoor UNIT No. in which the problem occurred.

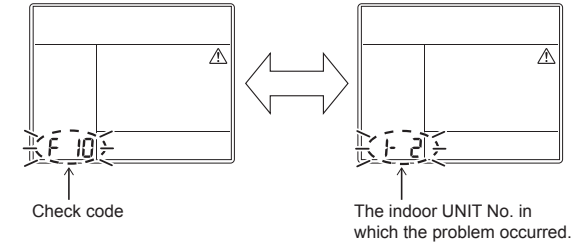

■ Troubleshooting history and confirmation

You can check the troubleshooting history with the following procedure if a problem occurs with the air conditioner. (The troubleshooting history records up to 4 incidents.)

You can check it during operation or when operation is stopped.

- If you check the troubleshooting history during OFF timer operation, the OFF timer will be canceled.

Procedure	Description of operation
1	<p>Push the OFF timer button for over 10 seconds and the indicators appear as an image indicating the troubleshooting history mode has been entered. If [Service check] is displayed, the mode enters in the troubleshooting history mode.</p> <ul style="list-style-type: none"> [01: Order of troubleshooting history] appears in the temperature indicator. The OFF timer indicator alternately shows the [check code] and the [indoor UNIT No.] in which the problem occurred.
2	<p>Each time the setting button is pushed, the recorded troubleshooting history is displayed in sequence. The troubleshooting history appears in order from [01] (newest) to [04] (oldest).</p> <p>⚠ CAUTION</p> <p>In the troubleshooting history mode, DO NOT push the Menu button for over 10 seconds, doing so deletes the entire troubleshooting history of the indoor unit.</p>
3	<p>After you have finished checking, push the ON/OFF button to return to the regular mode.</p> <ul style="list-style-type: none"> If the air conditioner is operating, it remains operated even after the ON/OFF button has been pushed. To stop its operation, push the ON/OFF button again.

■ When the Leak Detector buzzer sounds

If the sensor detects refrigerant leakage, Alarm lamp blinks and buzzer sounds a warning sound.
 Push this button to stop warning sound.
 (Even if the buzzer sound is released, Alarm lamp will not be released.)

■ Procedure stopping buzzer

The alarm can be stopped by pressing the alarm lamp button for at least 2 seconds, after buzzer sounds 1 minute.

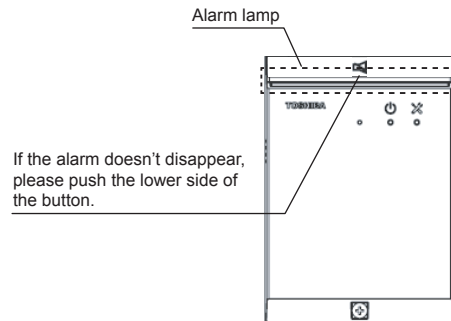

■ Warning in Operations

WARNING

- When a gas alarm occurs, immediately ventilate the area and evacuate from the room.
 Also contact the manager of the facility and the Qualified service parson.
- Do NOT turn off main power of Leak Detector.

12 Specifications

Model	Sound power level (dBA)		Weight (kg)
	Cooling	Heating	
MMY-SUG0801MT8P-E MMY-SUG0801MT8JP-E	74	77	232
MMY-SUG1001MT8P-E MMY-SUG1001MT8JP-E	75	78	232
MMY-SUG1201MT8P-E MMY-SUG1201MT8JP-E	79	82	232
MMY-SUG1401MT8P-E MMY-SUG1401MT8JP-E	79	84	232
MMY-SUG1601MT8P-E MMY-SUG1601MT8JP-E	83	87	329
MMY-SUG1801MT8P-E MMY-SUG1801MT8JP-E	84	89	329
MMY-SUG2001MT8P-E MMY-SUG2001MT8JP-E	85	89	361
MMY-SUG2201MT8P-E MMY-SUG2201MT8JP-E	86	90	361
MMY-SUG2401MT8P-E MMY-SUG2401MT8JP-E	86	91	361

Product information of ecodesign requirements. (Regulation (EU) 2016/2281)
<http://ecodesign.toshiba-airconditioning.eu/en>

13 Notice code

- Notice code is a function only in TC2U-Link communication.
- When the outdoor or indoor unit detects its conditions requiring caution or maintenance, this function notices you to check your units with the spanner mark (Notice code mark) on the wired remote controller or central controller display.
- Even while the notice code mark is displayed, the air conditioner can operate normally.
- A maximum of 5 notice codes can be issued simultaneously in one system (line).

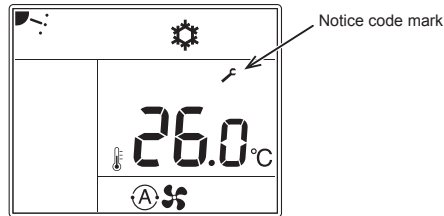

■ How to check Notice CODE No.

- 1** Stop the operation of the air conditioner and push the Menu button and OFF timer button at the same time for 10 seconds or more.
- 2** The unit number of the indoor unit is displayed at the bottom left of the screen. Change it with the [▽] [△] setting button and push the OFF timer button to confirm.
- 3** The history number is displayed in the center of the screen, and the Notice CODE No. is displayed in the lower left. [▽] [△] You can switch the history with the setting button (a maximum of 5 notice codes).
- 4** Push the ON / OFF button to return to the operation stop screen.

■ Notice code list

Notice CODE No.	Item	Content
203	Flow Selector unit battery dead	The battery kit connected to the Flow Selector unit has reached the end of its life.
204	Leak detector life advance display	The leak detector will soon reach the end of its life.

Declaration of Conformity

Manufacturer: **Toshiba Carrier (Thailand) Co., Ltd.**
144 / 9 Moo 5, Bangkadi Industrial Park, Tivanon Road, Tambol Bangkadi, Amphur Muang, Pathumthani 12000, Thailand

TCF holder: TOSHIBA CARRIER EUROPE S.A.S
Route de Thil 01120 Montluel FRANCE

Hereby declares that the machinery described below:

Generic Denomination: Air Conditioner

Model / type: MMY-SUG0801MT8P-E, MMY-SUG1001MT8P-E, MMY-SUG1201MT8P-E
MMY-SUG1401MT8P-E, MMY-SUG1601MT8P-E, MMY-SUG1801MT8P-E
MMY-SUG2001MT8P-E, MMY-SUG2201MT8P-E, MMY-SUG2401MT8P-E

MMY-SUG0801MT8JP-E, MMY-SUG1001MT8JP-E, MMY-SUG1201MT8JP-E
MMY-SUG1401MT8JP-E, MMY-SUG1601MT8JP-E, MMY-SUG1801MT8JP-E
MMY-SUG2001MT8JP-E, MMY-SUG2201MT8JP-E, MMY-SUG2401MT8JP-E

Commercial name: Super Heat Recovery Multi Air Conditioner

Complies with the provisions of the Machinery Directive (Directive 2006/42/EC) and the regulations transposing into national law

Complies with the provisions of the following harmonized standard:
EN 378-2: 2016

NOTE

This declaration becomes invalid if technical or operational modifications are introduced without the manufacturer's consent.

Declaration of Conformity

Manufacturer: **Toshiba Carrier (Thailand) Co., Ltd.**
144 / 9 Moo 5, Bangkadi Industrial Park, Tivanon Road, Tambol Bangkadi,
Amphur Muang, Pathumthani 12000, Thailand

TCF holder: TOSHIBA CARRIER UK Ltd.
Porsham Close Belliver Industrial Estate Roloorough Plymouth
Devon PL6 7DB United Kingdom

Hereby declares that the machinery described below:

Generic Denomination: Air Conditioner

Model / type: MMY-SUG0801MT8P-E, MMY-SUG1001MT8P-E, MMY-SUG1201MT8P-E
MMY-SUG1401MT8P-E, MMY-SUG1601MT8P-E, MMY-SUG1801MT8P-E
MMY-SUG2001MT8P-E, MMY-SUG2201MT8P-E, MMY-SUG2401MT8P-E

MMY-SUG0801MT8JP-E, MMY-SUG1001MT8JP-E, MMY-SUG1201MT8JP-E
MMY-SUG1401MT8JP-E, MMY-SUG1601MT8JP-E, MMY-SUG1801MT8JP-E
MMY-SUG2001MT8JP-E, MMY-SUG2201MT8JP-E, MMY-SUG2401MT8JP-E

Commercial name: Super Heat Recovery Multi Air Conditioner

Complies with the provisions of the Supply of Machinery (Safety) Regulations 2008

Complies with the provisions of the following harmonized standard:

EN 378-2: 2016

NOTE

This declaration becomes invalid if technical or operational modifications are introduced without the manufacturer's consent.



Toshiba Carrier (Thailand) Co., Ltd.

144 / 9 Moo 5, Bangkadi Industrial Park, Tivanon Road, Tambol Bangkadi, Amphur Muang, Pathumthani 12000, Thailand

1140102201