

TOSHIBA



EB99847501

AIR CONDITIONER (SPLIT TYPE) Installation Manual

R32

For commercial use

Indoor Unit

Model name:

<4-way Cassette type>

RAV-HM561UT-E

RAV-HM801UT-E

RAV-HM1101UT-E

RAV-HM1401UT-E

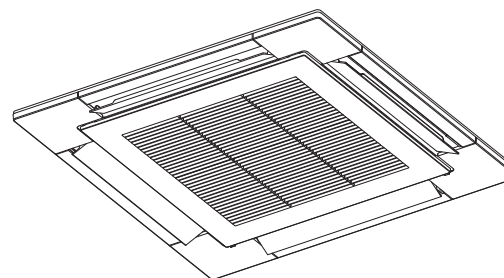

Original instruction

Please read this Installation Manual carefully before installing the Air Conditioner.

- This Manual describes the installation method of the indoor unit.
- For installation of the outdoor unit, follow the Installation Manual attached to the outdoor unit.

ADOPTION OF R32 REFRIGERANT

This Air Conditioner has adopted a refrigerant HFC (R32) which does not destroy the ozone layer.
This indoor unit is for the R32 refrigerant. Be sure to combine with an outdoor unit for the R32 refrigerant.

Product information of ecodesign requirements. (Regulation (EU) 2016/2281)
<http://ecodesign.toshiba-airconditioning.eu/en>

Contents

1	Precautions for safety	3
1	Précautions relatives à la sécurité	8
1	Sicherheitshinweise	13
1	Precauzioni per la sicurezza	18
1	Precauciones de seguridad	23
1	Precauções de segurança	28
1	Voorzorgen voor de veiligheid	33
1	Προφυλάξεις ασφαλείας	38
1	Правила техники безопасности	43
2	Accessory parts	47
3	Selection of installation place	47
4	Installation	49
5	Drain piping	51
6	Refrigerant piping	53
7	Electrical connection	54
8	Applicable controls	58
9	Test run	62
10	Maintenance	64
11	Troubleshooting	65

Thank you for purchasing this Toshiba air conditioner.

Please read carefully through these instructions that contain important information which complies with the "Machinery Directive 2006 / 42 / EC", and ensure that you understand them.

After completing the installation work, hand over this Installation Manual and the Owner's Manual to the user, and ask the user to keep them in a safe place for future reference.

Generic denomination: Air conditioner

Definition of qualified installer or qualified service person

The air conditioner must be installed, maintained, repaired and removed by a qualified installer or qualified service person. When any of these jobs is to be done, ask a qualified installer or qualified service person to do them.

A qualified installer or qualified service person is an agent who has the qualifications and knowledge described in the table below.

Agent	Qualifications and knowledge which the agent must have
Qualified installer (*1)	<ul style="list-style-type: none"> The qualified installer is a person who installs, maintains, relocates and removes the air conditioners made by Toshiba Carrier Corporation. He or she has been trained to install, maintain, relocate and remove the air conditioners made by Toshiba Carrier Corporation or, alternatively, he or she has been instructed in such operations by an individual or individuals who have been trained and is thus thoroughly acquainted with the knowledge related to these operations. The qualified installer who is allowed to do the electrical work involved in installation, relocation and removal has the qualifications pertaining to this electrical work as stipulated by the local laws and regulations, and he or she is a person who has been trained in matters relating to electrical work on the air conditioners made by Toshiba Carrier Corporation or, alternatively, he or she has been instructed in such matters by an individual or individuals who have been trained and is thus thoroughly acquainted with the knowledge related to this work. The qualified installer who is allowed to do the refrigerant handling and piping work involved in installation, relocation and removal has the qualifications pertaining to this refrigerant handling and piping work as stipulated by the local laws and regulations, and he or she is a person who has been trained in matters relating to refrigerant handling and piping work on the air conditioners made by Toshiba Carrier Corporation or, alternatively, he or she has been instructed in such matters by an individual or individuals who have been trained and is thus thoroughly acquainted with the knowledge related to this work. The qualified installer who is allowed to work at heights has been trained in matters relating to working at heights with the air conditioners made by Toshiba Carrier Corporation or, alternatively, he or she has been instructed in such matters by an individual or individuals who have been trained and is thus thoroughly acquainted with the knowledge related to this work.
Qualified service person (*1)	<ul style="list-style-type: none"> The qualified service person is a person who installs, repairs, maintains, relocates and removes the air conditioners made by Toshiba Carrier Corporation. He or she has been trained to install, repair, maintain, relocate and remove the air conditioners made by Toshiba Carrier Corporation or, alternatively, he or she has been instructed in such operations by an individual or individuals who have been trained and is thus thoroughly acquainted with the knowledge related to these operations. The qualified service person who is allowed to do the electrical work involved in installation, repair, relocation and removal has the qualifications pertaining to this electrical work as stipulated by the local laws and regulations, and he or she is a person who has been trained in matters relating to electrical work on the air conditioners made by Toshiba Carrier Corporation or, alternatively, he or she has been instructed in such matters by an individual or individuals who have been trained and is thus thoroughly acquainted with the knowledge related to this work. The qualified service person who is allowed to do the refrigerant handling and piping work involved in installation, repair, relocation and removal has the qualifications pertaining to this refrigerant handling and piping work as stipulated by the local laws and regulations, and he or she is a person who has been trained in matters relating to refrigerant handling and piping work on the air conditioners made by Toshiba Carrier Corporation or, alternatively, he or she has been instructed in such matters by an individual or individuals who have been trained and is thus thoroughly acquainted with the knowledge related to this work. The qualified service person who is allowed to work at heights has been trained in matters relating to working at heights with the air conditioners made by Toshiba Carrier Corporation or, alternatively, he or she has been instructed in such matters by an individual or individuals who have been trained and is thus thoroughly acquainted with the knowledge related to this work.

Definition of protective gear

When the air conditioner is to be transported, installed, maintained, repaired or removed, wear protective gloves and 'safety' work clothing.



In addition to such normal protective gear, wear the protective gear described below when undertaking the special work detailed in the table below.

Failure to wear the proper protective gear is dangerous because you will be more susceptible to injury, burns, electric shocks and other injuries.

Work undertaken	Protective gear worn
All types of work	Protective gloves 'Safety' working clothing
Electrical-related work	Clothing to provide protection from electric shock Insulating shoes Gloves to provide protection from electric shock
Work done at heights (50 cm or more)	Helmets for use in industry
Transportation of heavy objects	Shoes with additional protective toe cap
Repair of outdoor unit	Gloves to provide protection for electricians

Meanings of symbols displayed on the air conditioner





These safety cautions describe important matters concerning safety to prevent injury to users or other people and damages to property. Please read through this manual after understanding the contents below (meanings of indications), and be sure to follow the description.

Indication	Meaning of Indication
 WARNING	Text set off in this manner indicates that failure to adhere to the directions in the warning could result in serious bodily harm (*1) or loss of life if the product is handled improperly.
 CAUTION	Text set off in this manner indicates that failure to adhere to the directions in the caution could result in slight injury (*2) or damage (*3) to property if the product is handled improperly.





*1: Serious bodily harm indicates loss of eyesight, injury, burns, electric shock, bone fracture, poisoning, and other injuries which leave aftereffect and require hospitalization or long-term treatment as an outpatient.

*2: Slight injury indicates injury, burns, electric shock, and other injuries which do not require hospitalization or long-term treatment as an outpatient.

*3: Damage to property indicates damage extending to buildings, household effects, domestic livestock, and pets.

	WARNING (Risk of fire)
	Read the OWNER'S MANUAL carefully before operation.
	Service personnel are required to carefully read the OWNER'S MANUAL and INSTALLATION MANUAL before operation.
	Further information is available in the OWNER'S MANUAL, INSTALLATION MANUAL, and the like.

Warning indications on the air conditioner unit

Warning indication		Description
 <p>WARNING ELECTRICAL SHOCK HAZARD Disconnect all remote electric power supplies before servicing.</p>	<p>WARNING ELECTRICAL SHOCK HAZARD Disconnect all remote electric power supplies before servicing.</p>	
 <p>WARNING Moving parts. Do not operate unit with grille removed. Stop the unit before the servicing.</p>	<p>WARNING Moving parts. Do not operate unit with grille removed. Stop the unit before the servicing.</p>	
 <p>CAUTION High temperature parts. You might get burned when removing this panel.</p>	<p>CAUTION High temperature parts. You might get burned when removing this panel.</p>	
 <p>CAUTION Do not touch the aluminum fins of the unit. Doing so may result in injury.</p>	<p>CAUTION Do not touch the aluminum fins of the unit. Doing so may result in injury.</p>	
 <p>CAUTION BURST HAZARD Open the service valves before the operation, otherwise there might be the burst.</p>	<p>CAUTION BURST HAZARD Open the service valves before the operation, otherwise there might be the burst.</p>	

1 Precautions for safety

The manufacturer shall not assume any liability for the damage caused by not observing the description of this manual.

WARNING

General

- Before starting to install the air conditioner, read through the Installation Manual carefully, and follow its instructions to install the air conditioner.
- Only a qualified installer or service person is allowed to do installation work. Inappropriate installation may result in water leakage, electric shock or fire.
- Do not use any refrigerant different from the one specified for complement or replacement. Otherwise, abnormally high pressure may be generated in the refrigeration cycle, which may result in a failure or explosion of the product or an injury to your body.
- Before opening the intake grille of the indoor unit or service panel of the outdoor unit, set the circuit breaker to the OFF position. Failure to set the circuit breaker to the OFF position may result in electric shocks through contact with the interior parts. Only a Qualified installer (*1) or Qualified service person (*1) is allowed to remove the intake grille of the indoor unit or service panel of the outdoor unit and do the work required.
- Before carrying out the installation, maintenance, repair or removal work, set the circuit breaker to the OFF position. Otherwise, electric shocks may result.
- Place a “Work in progress” sign near the circuit breaker while the installation, maintenance, repair or removal work is being carried out. There is a danger of electric shocks if the circuit breaker is set to ON by mistake.
- Only a Qualified installer (*1) or Qualified service person (*1) is allowed to undertake work at heights using a stand of 50 cm or more or to remove the intake grille of the indoor unit to undertake work.
- Wear protective gloves and safety work clothing during installation, servicing and removal.
- Do not touch the aluminum fin of the unit. You may injure yourself if you do so. If the fin must be touched for some reason, first put on protective gloves and safety work clothing, and then proceed.

- When work is performed at heights, use a ladder which complies with the ISO 14122 standard, and follow the procedure in the ladder's instructions. Also wear a helmet for use in industry as protective gear to undertake the work.
- Before cleaning the filter or other parts of the outdoor unit, set the circuit breaker to OFF without fail, and place a "Work in progress" sign near the circuit breaker before proceeding with the work.
- Before working at heights, put a sign in place so that no-one will approach the work location, before proceeding with the work. Parts and other objects may fall from above, possibly injuring a person below. While carrying out the work, wear a helmet for protection from falling objects.
- The refrigerant used by this air conditioner is the R32.
- The air conditioner must be transported in stable condition. If any part of the product is broken, contact the dealer.
- When the air conditioner must be transported by hand, carry it by two or more people.
- Servicing shall be performed only as recommended by the manufacturer. Do not move or repair any unit by yourself. There is high voltage inside the unit. You may get electric shock when removing the cover and main unit.
- This appliance is intended to be used by expert or trained users in shops, in light industry, or for commercial use by lay persons.

Selection of installation location

- When the air conditioner is installed in a small room, provide appropriate measures to ensure that the concentration of refrigerant leakage occur in the room does not exceed the critical level.
- Do not install in a location where flammable gas leaks are possible. If the gas leak and accumulate around the unit, it may ignite and cause a fire.
- To transport the air conditioner, wear shoes with additional protective toe caps.
- To transport the air conditioner, do not take hold of the bands around the packing carton. You may injure yourself if the bands should break.
- Install the indoor unit at least 2.5 m above the floor level since otherwise the users may injure themselves or receive electric shocks if they poke their fingers or other objects into the indoor unit while the air conditioner is running.
- Do not place any combustion appliance in a place where it is directly exposed to the wind of air conditioner, otherwise it may cause imperfect combustion.

- Appliance and pipe-work shall be installed, operated and stored in a room with a floor area larger than $A_{\min} \text{ m}^2$.
How to get $A_{\min} \text{ m}^2$: $A_{\min} = (M / (2.5 \times 0.22759 \times h_0))^2$
M is the refrigerant charge amount in appliance in **kg**;
 h_0 is the installation height of the appliance in **m**:
0.6 m for floor standing / 1.8 m for wall mounted / 1.0 m for window mounted / 2.2 m for ceiling mounted.
For detail, refer to Installation Manual of the outdoor unit.

Installation

- When the indoor unit is to be suspended, the designated hanging bolts (M10 or W3/8) and nuts (M10 or W3/8) must be used.
- Install the air conditioner securely in a location where the base can sustain the weight adequately. If the strength is not enough, the unit may fall down resulting in injury.
- Follow the instructions in the Installation Manual to install the air conditioner. Failure to follow these instructions may cause the product to fall down or topple over or give rise to noise, vibration, water leakage or other trouble.
- Carry out the specified installation work to guard against the possibility of high winds and earthquake. If the air conditioner is not installed appropriately, a unit may topple over or fall down, causing an accident.
- If refrigerant gas has leaked during the installation work, ventilate the room immediately. If the leaked refrigerant gas comes in contact with fire, noxious gas may generate.
- Use forklift to carry in the air conditioner units and use winch or hoist at installation of them.

Refrigerant piping

- Install the refrigerant pipe securely during the installation work before operating the air conditioner. If the compressor is operated with the valve open and without refrigerant pipe, the compressor sucks air and the refrigeration cycles is over pressurized, which may cause an injury.
- Tighten the flare nut with a torque wrench in the specified manner. Excessive tighten of the flare nut may cause a crack in the flare nut after a long period, which may result in refrigerant leakage.
- After the installation work, confirm that refrigerant gas does not leak. If refrigerant gas leaks into the room and flows near a fire source, such as a cooking range, noxious gas may be generated.

- When the air conditioner has been installed or relocated, follow the instructions in the Installation Manual and purge the air completely so that no gases other than the refrigerant will be mixed in the refrigerating cycle. Failure to purge the air completely may cause the air conditioner to malfunction.
- Nitrogen gas must be used for the airtight test.
- The charge hose must be connected in such a way that it is not slack.

Electrical wiring

- Only a Qualified installer (*1) or Qualified service person (*1) is allowed to carry out the electrical work of the air conditioner. Under no circumstances must this work be done by an unqualified individual since failure to carry out the work properly may result in electric shocks and/or electrical leaks.
- To connect the electrical wires, repair the electrical parts or undertake other electrical jobs, wear gloves to provide protection for electricians, insulating shoes and clothing to provide protection from electric shocks. Failure to wear this protective gear may result in electric shocks.
- Use wiring that meets the specifications in the Installation Manual and the stipulations in the local regulations and laws. Use of wiring which does not meet the specifications may give rise to electric shocks, electrical leakage, smoking and/or a fire.
- Connect earth wire. (Grounding work)
Incomplete earthing causes an electric shock.
- Do not connect earth wires to gas pipes, water pipes, and lightning conductor or telephone earth wires.
- After completing the repair or relocation work, check that the earth wires are connected properly.
- Install a circuit breaker that meets the specifications in the Installation Manual and the stipulations in the local regulations and laws.
- Install the circuit breaker where it can be easily accessed by the agent.
- When installing the circuit breaker outdoors, install one which is designed to be used outdoors.
- Under no circumstances, the power supply wire or the indoor and outdoor connecting wire must not be connected in the middle (Connection using a solderless terminal etc.)
Connection trouble in the places where the wire is connected in the middle may give rise to smoking and/or a fire.

- Electrical wiring work shall be conducted according to law and regulation in the community and Installation Manual.
Failure to do so may result in electrocution or short circuit.

Test run

- Before operating the air conditioner after having completed the work, check that the electrical control box cover of the indoor unit and service panel of the outdoor unit are closed, and set the circuit breaker to the ON position. You may receive an electric shock if the power is turned on without first conducting these checks.
- If there is any kind of trouble (such as check code display has appeared, smell of burning, abnormal sounds, the air conditioner fails to cool or heat or water is leaking) has occurred in the air conditioner, do not touch the air conditioner yourself but set the circuit breaker to the OFF position, and contact a qualified service person. Take steps to ensure that the power will not be turned on (by marking "out of service" near the circuit breaker, for instance) until qualified service person arrives. Continuing to use the air conditioner in the trouble status may cause mechanical problems to escalate or result in electric shocks or other trouble.
- After the work has finished, use an insulation tester set (500 V Megger) to check the resistance is 1 MΩ or more between the charge section and the non-charge metal section (Earth section). If the resistance value is low, a disaster such as a leak or electric shock is caused at user's side.
- Upon completion of the installation work, check for refrigerant leaks and check the insulation resistance and water drainage. Then conduct a test run to check that the air conditioner is operating properly.

Explanations given to user

- Upon completion of the installation work, tell the user where the circuit breaker is located. If the user does not know where the circuit breaker is, he or she will not be able to turn it off in the event that trouble has occurred in the air conditioner.
- After the installation work, follow the Owner's Manual to explain to the customer how to use and maintain the unit.

Relocation

- Only a Qualified installer (*1) or Qualified service person (*1) is allowed to relocate the air conditioner. It is dangerous for the air conditioner to be relocated by an unqualified individual since a fire, electric shocks, injury, water leakage, noise and/or vibration may result.
- When carrying out the pump-down work shut down the compressor before disconnecting the refrigerant pipe. Disconnecting the refrigerant pipe with the service valve left open and the compressor still operating will cause air or other gas to be sucked in, raising the pressure inside the refrigeration cycle to an abnormally high level, and possibly resulting in rupture, injury or other trouble.

(*1) Refer to the "Definition of qualified installer or qualified service person".

CAUTION

This Air Conditioner has adopted a refrigerant HFC (R32) which does not destroy the ozone layer.

- As the R32 refrigerant is easily affected by impurities such as moisture, oxidized film, oil, etc., due to the high pressure, be careful not to allow the moisture, dirt, existing refrigerant, refrigerating machine oil, etc., to get mixed up in the refrigeration cycle during the installation work.
 - A special tool for the R32 refrigerant is required for installation.
 - Use a new and clean piping materials for the connecting pipe so that moisture and dirt are not mixed together during the installation work.
 - When using existing pipes, follow the Installation Manual enclosed with the outdoor unit.
-

Merci d'avoir acheté ce climatiseur de Toshiba.

Lisez attentivement ces instructions qui contiennent des informations importantes concernant la conformité à la « Directive Machines 2006/42/EC » et assurez-vous de les comprendre.

Une fois l'installation terminée, confiez à l'utilisateur le présent manuel d'installation et le manuel du propriétaire et demandez-lui de les ranger, afin qu'il les ait à disposition en cas de besoin.

Dénomination générique : Climatiseur

Définition d'un installateur qualifié ou d'un technicien d'entretien qualifié

Le climatiseur doit être installé, entretenu, réparé et enlevé par un installateur qualifié ou une personne d'entretien qualifiée. Lorsqu'une de ces opérations doit être effectuée, demandez à un installateur qualifié ou un technicien d'entretien qualifié de les exécuter.

Un installateur qualifié ou un technicien d'entretien qualifié est un agent qui a les qualifications et les connaissances décrites dans le tableau ci-dessous.

Agent	Qualifications et connaissances que l'agent doit posséder
Installateur qualifié (*1)	<ul style="list-style-type: none"> L'installateur qualifié est une personne qui installe, entretient, déplace et enlève les climatiseurs fabriqués par Toshiba Carrier Corporation. Il a été formé pour installer, entretenir, déplacer et enlever les climatiseurs fabriqués par Toshiba Carrier Corporation ou, alternativement, il a reçu des consignes concernant de telles opérations d'une ou de plusieurs personnes qui ont été formées. Par conséquent, il maîtrise très bien les connaissances relatives à ces opérations. L'installateur qualifié qui est autorisé à effectuer un travail électrique compris dans l'installation, le déplacement et l'enlèvement possède les qualifications nécessaires à ce travail électrique conformément aux réglementations et à la législation locales. De plus, il a été formé pour résoudre les problèmes relatifs au travail électrique sur les climatiseurs fabriqués par Toshiba Carrier Corporation ou, alternativement, il a reçu des consignes dans de tels domaines d'une ou de plusieurs personnes qui ont été formées. Par conséquent, il maîtrise très bien les connaissances relatives à ce travail. L'installateur qualifié qui est autorisé à manipuler du réfrigérant et à réaliser un travail de raccordement compris dans l'installation, le déplacement et l'enlèvement possède les qualifications nécessaires à cette manipulation de réfrigérant et ce travail de raccordement conformément aux réglementations et à la législation locales. De plus, il a été formé pour s'occuper des problèmes relatifs à la manipulation de réfrigérant et de travail de raccordement sur les climatiseurs fabriqués par Toshiba Carrier Corporation ou, alternativement, il a reçu des consignes dans de tels domaines d'une ou de plusieurs personnes qui ont été formées. Par conséquent, il maîtrise très bien les connaissances relatives à ce travail. L'installateur qualifié qui est autorisé à travailler en hauteur a été formé aux domaines relatifs au travail en hauteur avec les climatiseurs fabriqués par Toshiba Carrier Corporation ou, alternativement, il a reçu des consignes dans de tels domaines d'une ou de plusieurs personnes qui ont été formées. Par conséquent, il maîtrise très bien les connaissances relatives à ce travail.
Technicien d'entretien qualifié (*1)	<ul style="list-style-type: none"> Le technicien d'entretien qualifié est une personne qui installe, répare, entretient, déplace et enlève les climatiseurs fabriqués par Toshiba Carrier Corporation. Il a été formé pour installer, réparer, entretenir, déplacer et enlever les climatiseurs fabriqués par Toshiba Carrier Corporation ou, alternativement, il a reçu des consignes concernant de telles opérations d'une ou de plusieurs personnes qui ont été formées. Par conséquent, il maîtrise très bien les connaissances relatives à ces opérations. Le technicien d'entretien qualifié qui est autorisé à effectuer un travail électrique compris dans l'installation, la réparation, le déplacement et l'enlèvement possède les qualifications nécessaires à ce travail électrique conformément aux réglementations et à la législation locales. De plus, il a été formé pour résoudre les problèmes relatifs au travail électrique sur les climatiseurs fabriqués par Toshiba Carrier Corporation ou, alternativement, il a reçu des consignes dans de tels domaines d'une ou de plusieurs personnes qui ont été formées. Par conséquent, il maîtrise très bien les connaissances relatives à ce travail. Le technicien d'entretien qualifié qui est autorisé à manipuler du réfrigérant et à réaliser un travail de raccordement compris dans l'installation, la réparation, le déplacement et l'enlèvement possède les qualifications nécessaires à cette manipulation de réfrigérant et ce travail de raccordement conformément aux réglementations et à la législation locales. De plus, il a été formé pour s'occuper des problèmes relatifs à la manipulation de réfrigérant et de travail de raccordement sur les climatiseurs fabriqués par Toshiba Carrier Corporation ou, alternativement, il a reçu des consignes dans de tels domaines d'une ou de plusieurs personnes qui ont été formées. Par conséquent, il maîtrise très bien les connaissances relatives à ce travail. Le technicien d'entretien qualifié qui est autorisé à travailler en hauteur a été formé aux domaines relatifs au travail en hauteur avec les climatiseurs fabriqués par Toshiba Carrier Corporation ou, alternativement, il a reçu des consignes dans de tels domaines d'une ou de plusieurs personnes qui ont été formées. Par conséquent, il maîtrise très bien les connaissances relatives à ce travail.

Définition de l'équipement de protection

Lorsque le climatiseur doit être transporté, installé, entretenu, réparé ou enlevé, portez des gants de protection et des vêtements de travail de « sécurité ».



En plus de cette tenue de protection normale, portez la tenue de protection décrite ci-dessous lorsque vous entreprenez les travaux spéciaux détaillés dans le tableau ci-dessous.

Ne pas porter la tenue de protection adéquate est dangereux car vous serez plus susceptible d'être blessé, brûlé, de subir un choc électrique ou d'autres blessures.





Travaux entrepris	Équipement de protection porté
Tous les types de travaux	Gants de protection Vêtement de travail de « sécurité »
Travaux électriques	Vêtement protégeant d'une décharge électrique Chaussures isolantes Gants protégeant des décharges électriques
Travail effectué en hauteur (50 cm ou plus)	Casques utilisés dans l'industrie
Transport d'objets lourds	Chaussures avec des bouts renforcés de protection
Réparation d'unité extérieure	Gants de protection pour électricien

■ Signification des symboles affichés sur le climatiseur





Ces précautions de sécurité mentionnent divers points importants pour prévenir les accidents corporels et les dommages aux équipements. Veuillez lire ce manuel après avoir pris connaissance des informations ci-dessous (significations des indications) et assurez-vous de suivre leurs descriptions.

Indication	Signification des indications
 AVERTISSEMENT	Le texte placé de cette manière indique que ne pas suivre les directives de l'avertissement pourrait entraîner de graves blessures corporelles (*1) ou la mort si le produit n'est pas manipulé correctement.
 ATTENTION	Le texte marqué de cette manière indique que le non-respect des directives de la précaution pourrait entraîner de graves blessures corporelles (*2) ou des dommages sur le produit (*3) si celui-ci n'est pas manipulé correctement.

- *1: On entend par grave blessure corporelle une perte de la vue, des blessures, des brûlures, un choc électrique, une fracture, un empoisonnement et d'autres blessures qui laissent des séquelles et requièrent une hospitalisation ou un traitement de longue durée en tant que patient externe.
- *2: On entend par blessure corporelle, toute blessure, brûlure, tout choc électrique ou autre blessure qui nécessitent une hospitalisation ou un traitement de longue durée en tant que patient externe.
- *3: On entend par dommages sur le bien tout endommagement s'étendant aux bâtiments, aux effets mobiliers, aux animaux d'élevage et aux animaux domestiques.

	AVERTISSEMENT (Risque d'incendie)
	Lisez le MANUEL D'UTILISATION attentivement avant l'utilisation.
	Le personnel d'entretien est tenu de lire attentivement le MANUEL D'UTILISATION et le MANUEL D'INSTALLATION avant l'utilisation.
	Des informations supplémentaires sont disponibles dans le MANUEL D'UTILISATION, le MANUEL D'INSTALLATION et autres manuels similaires.

Avertissements apposés sur le climatiseur

Indication d'avertissement	Description
 <p>WARNING ELECTRICAL SHOCK HAZARD Disconnect all remote electric power supplies before servicing.</p>	<p>AVERTISSEMENT RISQUE DE DECHARGE ELECTRIQUE Débranchez toutes les alimentations électriques distantes avant l'entretien.</p>
 <p>WARNING Moving parts. Do not operate unit with grille removed. Stop the unit before the servicing.</p>	<p>AVERTISSEMENT Pièces mobiles. Ne faites pas fonctionner l'unité avec la grille déposée. Arrêtez l'unité avant l'entretien.</p>
 <p>CAUTION High temperature parts. You might get burned when removing this panel.</p>	<p>ATTENTION Pièces à haute température. Vous pourriez vous brûler en déposant ce panneau.</p>
 <p>CAUTION Do not touch the aluminum fins of the unit. Doing so may result in injury.</p>	<p>ATTENTION Ne touchez pas les palmes en aluminium de l'unité. Vous pourriez vous blesser.</p>
 <p>CAUTION BURST HAZARD Open the service valves before the operation, otherwise there might be the burst.</p>	<p>ATTENTION RISQUE D'EXPLOSION Ouvrez les soupapes de service avant l'opération, sinon un éclatement pourrait se produire.</p>

1 Précautions relatives à la sécurité

Le fabricant ne peut être tenu responsable pour tout dommage causé par le non-respect des instructions et descriptions de ce manuel.

AVERTISSEMENT

Généralités

- Avant d'installer le climatiseur, lisez attentivement le Manuel d'installation et suivez les instructions pour installer le climatiseur.
- Seul un installateur qualifié ou une personne d'entretien est autorisé à procéder à l'installation. Une installation inadéquate peut se solder par une fuite d'eau, une électrocution ou un incendie.
- N'utilisez aucun autre réfrigérant que celui spécifié pour tout rajout ou remplacement. Sinon, une haute pression anormale pourrait être générée dans le circuit de réfrigération, qui pourrait entraîner une panne ou une explosion du produit ou même des blessures corporelles.
- Avant d'ouvrir la grille d'entrée d'air de l'unité intérieure ou du panneau de service de l'unité extérieure, réglez le disjoncteur sur la position OFF. Ne pas régler le disjoncteur sur la position OFF peut donner lieu à des chocs électriques par le biais d'un contact avec les pièces intérieures. Seul un installateur qualifié(*1) ou une personne d'entretien qualifiée(*1) est autorisé à enlever la grille d'entrée d'air de l'unité intérieure ou le panneau de service de l'unité extérieure et à effectuer le travail requis.
- Avant de procéder à l'installation, à l'entretien, à la réparation ou à la dépose, réglez le coupe-circuit en position OFF. Dans le cas contraire, cela peut entraîner des chocs électriques.
- Placez un panneau indicateur « Travail en cours » à proximité du coupe-circuit pendant l'installation, l'entretien, la réparation ou la dépose. Un danger de décharge électrique est possible si le coupe-circuit est réglé sur ON par erreur.
- Seul un installateur qualifié (*1) ou une personne d'entretien qualifiée (*1) est autorisé à entreprendre un travail en hauteur à l'aide d'un pied de 50 cm minimum pour déposer la grille d'entrée d'air de l'unité intérieure pour entreprendre le travail.
- Portez des gants de protection ainsi que des vêtements de travail de sécurité pendant l'installation, l'entretien et la dépose.
- Ne touchez pas la palme en aluminium de l'unité. Vous risquez de vous blesser dans le cas contraire. Si vous devez toucher la palme pour une raison ou une autre, mettez d'abord des gants de protection et des vêtements de travail de sécurité, ensuite, procédez à l'opération.

- Lors de la réalisation d'un travail en hauteur, utilisez une échelle conforme à la norme ISO 14122 et suivez la procédure associée aux instructions de l'échelle. Portez également un casque de protection pour une utilisation dans l'industrie comme tenue de protection pour entreprendre le travail.
- Avant le nettoyage du filtre ou d'autres pièces de l'unité extérieure, réglez le coupe-circuit sur OFF sans faute, et placez un panneau indicateur « Travail en cours » à proximité du coupe-circuit avec de commencer le travail.
- Avant de travailler en hauteur, placez un panneau indicateur afin que personne ne s'approche du lieu de travail. Des pièces et d'autres objets risquent de tomber du haut, pouvant blesser une personne se trouvant en dessous. Pendant toute la durée de la tâche, portez un casque, afin d'être protégé en cas de chute d'objets.
- Le frigorigène utilisé par ce climatiseur est le R32.
- Le climatiseur doit être transporté dans des conditions stables. Si une pièce était endommagée, contactez le revendeur.
- Si le climatiseur doit être transporté à la main, faites appel à plusieurs personnes.
- L'entretien ne doit être effectué que selon les recommandations du fabricant. Ne déplacez ni ne réparez l'unité vous-même. L'intérieur de l'unité est sous haute tension. Vous risqueriez une décharge électrique en enlevant le couvercle et l'unité principale.
- Cet appareil est destiné à être utilisé par des utilisateurs experts ou spécialement formés dans des ateliers, dans l'industrie légère, ou pour une utilisation commerciale par des non-spécialistes.

Sélection du lieu d'installation

- Si le climatiseur est installé dans une petite pièce, prenez les mesures qui s'imposent pour que, en cas de fuite, la teneur en réfrigérant ne dépasse pas le seuil critique.
- N'installez pas cet appareil dans un endroit où des fuites de gaz inflammable sont possibles. En cas de fuite du gaz et d'accumulation à proximité du climatiseur, un incendie peut se déclarer.
- Lors du transport du climatiseur, portez des chaussures à coquilles de protection supplémentaires.
- Lors du transport du climatiseur, n'agrippez pas les bandes du carton d'emballage. Vous risquez de vous blesser si les bandes se brisent.
- Installez l'unité intérieure à au moins 2,5 m au-dessus du niveau du sol, dans le cas contraire, les utilisateurs peuvent se blesser ou recevoir des chocs électriques s'ils frappent de leurs doigts ou d'autres objets dans l'unité intérieure alors que le climatiseur fonctionne.
- Ne placez aucun appareil à combustion dans un endroit exposé directement au souffle du climatiseur, faute de quoi sa combustion risquerait d'être défectueuse.

- L'appareil et les tuyauteries doivent être installés, utilisés et stockés dans une pièce dont la surface de plancher est supérieure à $A_{\min} \text{ m}^2$. Comment obtenir $A_{\min} \text{ m}^2$: $A_{\min} = (M / (2,5 \times 0,22759 \times h_0))^2$
M est la quantité de charge de frigorigène dans l'appareil exprimée en kg ;
 h_0 est la hauteur d'installation de l'appareil en m :
0,6 m pour montage au sol / 1,8 m pour montage mural / 1,0 m pour montage sur fenêtre / 2,2 m pour montage au plafond.
Pour plus de détails, référez-vous au manuel d'installation de l'unité extérieure.

Installation

- Lorsque l'unité intérieure doit être suspendue, les boulons (M10 ou W3/8) et les écrous (M10 ou W3/8) de suspension désignés doivent être utilisés.
- Installez soigneusement le climatiseur sur une base capable de le supporter. Si l'endroit n'est pas assez résistant, l'unité peut tomber et provoquer des blessures.
- Suivez les instructions du Manuel d'installation pour installer le climatiseur. Le non-respect de ces instructions peut entraîner la chute ou le basculement de l'appareil, voire engendrer du bruit, des vibrations, une fuite d'eau, etc.
- Effectuez l'installation spécifiée pour protéger le climatiseur contre un tremblement de terre ou des vents violents. S'il n'est pas correctement monté, le climatiseur risque de tomber ou de basculer, ce qui peut entraîner un accident.
- Si le gaz réfrigérant a fui durant l'installation, aérez immédiatement la pièce. Si le gaz réfrigérant qui a fui entre en contact avec le feu, un gaz nocif peut se dégager.
- Utilisez un chariot élévateur pour porter le climatiseur. Pour le monter, utilisez un treuil ou un monte-charge.

Tuyaux de réfrigérant

- Fixez solidement le tuyau de réfrigérant pendant l'installation, avant de faire fonctionner le climatiseur. Si le compresseur est utilisé avec la vanne ouverte et sans que le tuyau de réfrigérant ne soit connecté, le compresseur aspire l'air et le circuit de réfrigération est alors en surpression. Dans ce cas, les tuyaux risquent de blesser quelqu'un.
- Serrez l'écrou évasé avec une clé dynamométrique de la manière spécifiée. Si vous appliquez un couple excessif, l'écrou risque, après un certain temps, de se casser et de provoquer une fuite de réfrigérant.
- Après l'installation, assurez-vous que le gaz réfrigérant ne fuit pas. Si le gaz réfrigérant fuit dans la pièce et s'écoule à proximité d'une source inflammable, telle qu'une cuisinière, un gaz nocif peut se dégager.

- Lorsque le climatiseur a été installé ou déplacé, suivez les instructions du Manuel d'installation et purgez la totalité de l'air de sorte qu'aucun gaz autre que le fluide frigorigène ne soit mélangé dans le circuit de réfrigération. Ne pas purger complètement l'air peut entraîner un dysfonctionnement du climatiseur.
- De l'azote gazeux doit être utilisé pour le test d'étanchéité à l'air.
- Le tuyau de remplissage doit être raccordé de telle manière qu'il ne soit pas lâche.

Raccordement électrique

- Seul un installateur qualifié(*1) ou une personne d'entretien qualifiée(*1) est autorisé à réaliser le travail électrique sur le climatiseur. En aucun cas, ce travail ne doit être effectué par une personne non qualifiée étant donné que si le travail n'est pas correctement effectué, des décharges électriques et/ou des fuites électriques peuvent survenir.
- Lors du raccordement des câbles électriques, de la réparation des pièces électriques ou de l'exécution d'autres travaux électriques, portez des gants pour vous protéger du courant, ainsi que des chaussures et des vêtements isolants pour vous protéger de chocs électriques. Ne pas porter cette tenue de protection peut entraîner des chocs électriques.
- Utilisez un câblage respectant les spécifications du Manuel d'installation et les dispositions des réglementations et de la législation locales. L'utilisation d'un câblage n'étant pas conforme aux spécifications peut donner lieu à des décharges électriques, une dispersion électrique, de la fumée et/ou un incendie.
- Branchez le fil de terre. (Mise à la terre)
Une mise à la terre incomplète peut provoquer une décharge électrique.
- Ne raccordez pas les fils de terre à des conduites de gaz, des conduites d'eau, du parafoudre ou des fils de terre pour câbles téléphoniques.
- Après avoir terminé le travail de réparation ou de déplacement, assurez-vous que le fil de terre est correctement raccordé.
- Installez un coupe-circuit respectant les spécifications du manuel d'installation et les dispositions des réglementations et de la législation locales.
- Installez le coupe-circuit là où il peut facilement être accessible par l'agent.
- Lors de l'installation du disjoncteur à l'extérieur, installez-en un qui soit conçu pour l'extérieur.
- En aucun cas le câble d'alimentation électrique ou le câble de connexion intérieur et extérieur ne doivent pas être connectés au milieu (connexion à l'aide d'une borne sans soudure etc.)
Des problèmes de raccordement dans des endroits où le câble est connecté au milieu peuvent entraîner de la fumée et/ou un incendie.

- Le travail de câblage électrique doit être conduit conformément à la législation et à la réglementation locales et au manuel d'installation. Dans le cas contraire, une électrocution ou un court-circuit peut survenir.

Essai de fonctionnement

- Avant de faire fonctionner le climatiseur après avoir terminé le travail, assurez-vous que le couvercle du boîtier de commandes électriques de l'unité intérieure et du panneau de service de l'unité extérieure sont fermés. Réglez ensuite le coupe-circuit sur la position ON. Vous pouvez recevoir une décharge électrique si l'alimentation est activée sans avoir d'abord effectué ces vérifications.
- En cas de problème au niveau du climatiseur (comme en cas d'erreur de code, d'odeur de brûlé ou de sons anormaux, lorsque le climatiseur ne parvient pas à refroidir ou à réchauffer l'air ou en cas de fuite d'eau), ne touchez pas le climatiseur vous-même et réglez le disjoncteur sur la position OFF, puis contactez une personne d'entretien qualifiée. Prenez des mesures pour garantir que l'alimentation ne sera pas branchée (en indiquant « hors service » près du disjoncteur, par exemple) jusqu'à ce que la personne d'entretien qualifiée arrive. Continuer à utiliser le climatiseur alors qu'il présente un problème peut entraîner des problèmes mécaniques ou donner lieu à des chocs électriques et autres pannes.
- Une fois le travail terminé, utilisez un contrôleur d'isolement (mégohmmètre de 500 V) afin de vérifier que la résistance est de 1 MΩ minimum entre la section de charge et la section métallique sans charge (Section terre). Si la valeur de résistance est faible, une catastrophe telle qu'une fuite ou une décharge électrique se produit sur le côté utilisateur.
- A l'issue du travail d'installation, vérifiez qu'il n'y a pas de fuites de fluide frigorigène et vérifiez la résistance d'isolation ainsi que l'évacuation d'eau. Ensuite, effectuez un essai de fonctionnement afin de vous assurer que le climatiseur fonctionne correctement.

Explications données à l'utilisateur

- A l'issue du travail d'installation, dites à l'utilisateur où se trouve le coupe-circuit. Si l'utilisateur ne sait pas où se trouve le coupe-circuit, il ou elle ne sera pas capable de le désactiver au cas où un problème surviendrait au niveau du climatiseur.
- Après le travail d'installation, reportez-vous au Mode d'emploi pour expliquer au client comment utiliser l'unité et effectuer son entretien.

Réinstallation

- Seul un installateur qualifié (*1) ou une personne d'entretien qualifiée (*1) est autorisé à déplacer le climatiseur. Déplacer le climatiseur par une personne non qualifiée représente un danger étant donné qu'un incendie, une décharge électrique, des blessures, des fuites d'eau, des parasites et/ou des vibrations risquent de se produire.
- Lors de la réalisation du travail de pompage, coupez le compresseur avant de débrancher le tuyau de réfrigérant. Débrancher le tuyau de réfrigérant alors que la vanne d'entretien est restée ouverte et que le compresseur fonctionne encore peut entraîner une aspiration de l'air ou d'autre gaz, faisant augmenter la pression à l'intérieure du circuit de réfrigération à un niveau anormalement élevé, et pouvant donner lieu à un éclatement, un dommage ou d'autres problèmes.

(*1) Reportez-vous à la section « Définition d'un installateur qualifié ou d'un technicien d'entretien qualifié ».

ATTENTION

Ce climatiseur utilise un frigorigène HFC (R32) qui ne détruit pas la couche d'ozone.

- Le frigorigène R32 est facilement affecté par les impuretés telles que l'humidité, un film oxydé, l'huile, etc., en raison d'une pression élevée, c'est pourquoi il faut faire attention de ne pas laisser l'humidité, la poussière, l'huile de la machine frigorifique, le frigorigène existant, etc., se mélanger au cycle de réfrigération pendant les travaux d'installation.
- Un outil spécial pour le réfrigérant R32 est nécessaire pour l'installation.
- Utilisez un matériau de tuyauterie neuf et propre pour le tuyau de raccordement afin que l'humidité et la saleté ne se mélangent pas pendant les travaux d'installation.
- Lors de l'utilisation de tuyaux existants, suivez les instructions d'installation indiquées dans le manuel d'installation fourni avec l'unité extérieure.

Vielen Dank, dass Sie sich für ein Klimagerät von Toshiba entschieden haben.
Bitte lesen Sie diese Anleitung, die wichtige Informationen gemäß der „Maschinenrichtlinie 2006/42/EC“ enthält, aufmerksam durch und stellen Sie sicher, dass Sie diese verstanden haben.
Übergeben Sie nach dem Abschluss der Installationsarbeiten dieses Installationshandbuch und die Bedienungsanleitung dem Benutzer und bitten Sie ihn, diese zu Informationszwecken an einem sicheren Ort aufzubewahren.

Allgemeine Bezeichnung: Klimaanlage

Definition der Bezeichnungen „Qualifizierter Installateur“ oder „Qualifizierter Servicetechniker“

Die Klimaanlage muss von einem qualifizierten Installateur oder einem qualifizierten Servicetechniker installiert, gewartet, repariert und entsorgt werden. Wenn eine dieser Aufgaben erledigt werden muss, beauftragen Sie einen qualifizierten Installateur oder einen qualifizierten Servicetechniker damit.

Ein qualifizierter Installateur oder ein qualifizierter Servicetechniker ist ein Auftragnehmer, der über die Qualifikationen und das Fachwissen verfügt, welche in der untenstehenden Tabelle genannt sind.

Auftragnehmer	Qualifikationen und Fachwissen, über welche der Auftragnehmer verfügen muss
Qualifizierter Installateur (*1)	<ul style="list-style-type: none"> Der Installationsfachmann ist eine Person, die Klimageräte der Toshiba Carrier Corporation einbaut, wartet, umzieht und ausbaut. Die Person ist im Einbau und in der Wartung sowie im Umzug und Ausbau von Klimageräten der Toshiba Carrier Corporation geschult oder wurde von einer geschulten Person oder geschulten Personen unterwiesen und verfügt aufgrund dessen über gründliche Kenntnisse, die sie zur Ausführung dieser Arbeiten befähigt. Der Installationsfachmann, dem es erlaubt ist, Elektroarbeiten im Zuge des Einbaus, Umzugs oder Ausbaus auszuführen, verfügt über die jeweils gesetzlich vorgeschriebene Qualifikation zur Ausführung von Elektroarbeiten und ist eine Person, die im Zusammenhang mit Elektroarbeiten an Klimageräten der Toshiba Carrier Corporation geschult ist oder in diesem Zusammenhang von einer geschulten Person oder geschulten Personen unterwiesen wurde, so dass sie über gründliche Kenntnisse verfügt, die sie zur Ausführung dieser Arbeiten befähigt. Der Installationsfachmann, dem es erlaubt ist, Kältemittel- oder rohrtechnische Arbeiten im Zuge des Einbaus, Umzugs oder Ausbaus auszuführen, verfügt über die jeweils gesetzlich vorgeschriebene Qualifikation zur Ausführung von Kältemittel- und rohrtechnischen Arbeiten und ist eine Person, die im Zusammenhang mit Kältemittel- und rohrtechnischen Arbeiten an Klimageräten der Toshiba Carrier Corporation geschult ist oder in diesem Zusammenhang von einer geschulten Person oder geschulten Personen unterwiesen wurde, so dass sie über gründliche Kenntnisse verfügt, die sie zur Ausführung dieser Arbeiten befähigt. Der Installationsfachmann, dem es erlaubt ist, Arbeiten in der Höhe auszuführen, ist im Zusammenhang mit Arbeiten in der Höhe an Klimageräten der Toshiba Carrier Corporation geschult oder wurde in diesem Zusammenhang von einer geschulten Person oder geschulten Personen unterwiesen und verfügt aufgrund dessen über gründliche Kenntnisse, die ihn zur Ausführung dieser Arbeiten befähigt.
Qualifizierter Servicetechniker (*1)	<ul style="list-style-type: none"> Der Installationsfachmann ist eine Person, die Klimageräte der Toshiba Carrier Corporation repariert, einbaut, wartet, umzieht und ausbaut. Die Person ist im Einbau und in der Reparatur und Wartung sowie im Umzug und Ausbau von Klimageräten der Toshiba Carrier Corporation geschult oder wurde von einer geschulten Person oder geschulten Personen unterwiesen und verfügt aufgrund dessen über gründliche Kenntnisse, die sie zur Ausführung dieser Arbeiten befähigt. Der Installationsfachmann, dem es erlaubt ist, Elektroarbeiten im Zuge des Einbaus, der Reparatur, des Umzugs oder Ausbaus auszuführen, verfügt über die jeweils gesetzlich vorgeschriebene Qualifikation zur Ausführung von Elektroarbeiten und ist eine Person, die im Zusammenhang mit Elektroarbeiten an Klimageräten der Toshiba Carrier Corporation geschult ist oder in diesem Zusammenhang von einer geschulten Person oder geschulten Personen unterwiesen wurde, so dass sie über gründliche Kenntnisse verfügt, die sie zur Ausführung dieser Arbeiten befähigt. Der Installationsfachmann, dem es erlaubt ist, Kältemittel- oder rohrtechnische Arbeiten im Zuge des Einbaus, der Reparatur, des Umzugs oder Ausbaus auszuführen, verfügt über die jeweils gesetzlich vorgeschriebene Qualifikation zur Ausführung von Kältemittel- und rohrtechnischen Arbeiten und ist eine Person, die im Zusammenhang mit Kältemittel- und rohrtechnischen Arbeiten an Klimageräten der Toshiba Carrier Corporation geschult ist oder in diesem Zusammenhang von einer geschulten Person oder geschulten Personen unterwiesen wurde, so dass sie über gründliche Kenntnisse verfügt, die sie zur Ausführung dieser Arbeiten befähigt. Der Installationsfachmann, dem es erlaubt ist, Arbeiten in der Höhe auszuführen, ist im Zusammenhang mit Arbeiten in der Höhe an Klimageräten der Toshiba Carrier Corporation geschult oder wurde in diesem Zusammenhang von einer geschulten Person oder geschulten Personen unterwiesen und verfügt aufgrund dessen über gründliche Kenntnisse, die ihn zur Ausführung dieser Arbeiten befähigt.

Definitionen zur Schutzkleidung

Bei Transport, Einbau, Wartung, Reparatur und Ausbau des Klimageräts sind Schutzhandschuhe und Sicherheitsarbeitskleidung zu tragen.



Neben dieser normalen Schutzausrüstung wird für die in der Tabelle unten aufgeführten Spezialarbeiten die jeweils genannte Schutzausrüstung benötigt.

Wer auf die korrekte Schutzausrüstung verzichtet, geht ein hohes Risiko ein, denn die Ausrüstung schützt vor Verletzungen, Verbrennungen, Stromschlag und anderen Gefahren.





Arbeitsaufgabe	Zu tragende Schutzkleidung
Alle Arten von Arbeiten	Schutzhandschuhe Sicherheitsarbeitskleidung
Elektroarbeiten	Schutzkleidung gegen Stromschläge Isolierschuhe Handschuhe, die Schutz vor Stromschlägen bieten
Arbeiten in der Höhe (50 cm und höher)	Industrie-Schutzhelme
Transport schwerer Gegenstände	Schuhe mit Zehenschutzkappen
Reparatur des Außengeräts	Isolierhandschuhe zum Schutz vor Stromschlägen

■ Bedeutungen der auf der Klimaanlage angezeigten Symbole





Diese Vorsichtsmaßregeln zur Sicherheit beschreiben wichtige Fragen zur Sicherheit, um Verletzungen an Benutzern und anderen Personen, ebenso wie Sachschäden zu vermeiden. Bitte lesen Sie dieses Handbuch gründlich durch, nachdem Sie sich mit den untenstehenden Inhalten vertraut gemacht haben (den Bedeutungen der Anzeigen), und folgen Sie immer der Beschreibung.

Anzeige	Bedeutung der Anzeige
 WARNUNG	Auf diese Weise gekennzeichnete Text weist darauf hin, dass die Nichteinhaltung der Anweisungen in der Warnung zu schweren Körperverletzungen (*1), möglicherweise mit Todesfolge, führen kann, wenn das Produkt nicht ordnungsgemäß verwendet wird.
 VORSICHT	Auf diese Weise gekennzeichnete Text weist darauf hin, dass die Nichteinhaltung der Anweisungen in der Warnung zu schweren Körperverletzungen (*2) oder Sachschäden (*3) führen kann, wenn das Produkt nicht ordnungsgemäß verwendet wird.

- *1: Schwere Körperverletzung beinhaltet Verlust der Sehkraft, Verletzungen, Verbrennungen, Stromschlag, Knochenbrüche, Vergiftungen und andere Verletzungen, die Nachwirkungen hinterlassen und Krankenhausaufenthalt oder lange ambulante Behandlung erfordern.
*2: Leichte Körperverletzung beinhaltet Verletzungen, Verbrennungen, Stromschlag und andere Verletzungen, die keinen Krankenhausaufenthalt bzw. keine langfristige ambulante Behandlung erfordern.
*3: Sachschäden beinhaltet Schäden an Gebäuden, Hausrat, Nutztieren und Haustieren.

	WARNUNG (Feuergefahr)
	Lesen Sie die BEDIENUNGSANLEITUNG gründlich durch, bevor Sie das Gerät in Betrieb nehmen.
	Das Servicepersonal muss die BEDIENUNGSANLEITUNG und die INSTALLATIONSANLEITUNG gründlich durchlesen, bevor es das Gerät in Betrieb nimmt.
	Ausführliche Informationen finden Sie in der BEDIENUNGSANLEITUNG , INSTALLATIONSANLEITUNG usw.

Warnhinweise an der Klimaanlage

Warnanzeige	Beschreibung
 <p>WARNING ELECTRICAL SHOCK HAZARD Disconnect all remote electric power supplies before servicing.</p>	<p>WARNUNG GEFAHR EINES ELEKTRISCHEN SCHLAGS Trennen Sie alle fernen Stromversorgungsquellen vom Netz, bevor Sie Wartungsarbeiten ausführen.</p>
 <p>WARNING Moving parts. Do not operate unit with grille removed. Stop the unit before the servicing.</p>	<p>WARNUNG Bewegliche Teile. Bedienen Sie nicht das Gerät, wenn das Gitter entfernt wurde. Stoppen Sie das Gerät, bevor Sie es warten.</p>
 <p>CAUTION High temperature parts. You might get burned when removing this panel.</p>	<p>VORSICHT Teile mit hohen Temperaturen. Es besteht die Gefahr, dass Sie sich verbrennen, wenn Sie diese Abdeckung entfernen.</p>
 <p>CAUTION Do not touch the aluminum fins of the unit. Doing so may result in injury.</p>	<p>VORSICHT Die Aluminiumlamellen des Geräts nicht berühren. Dies kann zu Verletzungen führen.</p>
 <p>CAUTION BURST HAZARD Open the service valves before the operation, otherwise there might be the burst.</p>	<p>VORSICHT EXPLOSIONSGEFAHR! Öffnen Sie vor dem Arbeitsgang die Versorgungsventile, da es anderenfalls zu einer Explosion kommen kann.</p>

1 Sicherheitshinweise

Der Hersteller haftet nicht für Schäden, die durch ein Missachten der in diesem Handbuch enthaltenen Hinweise verursacht werden.

WARNUNG

Allgemeines

- Bevor Sie mit der Installation der Klimaanlage beginnen, lesen Sie das Installationshandbuch sorgfältig durch und befolgen Sie die darin enthaltenen Anweisungen zum Installieren der Klimaanlage.
- Die Installationsarbeiten dürfen nur von qualifiziertem Installations- oder Servicepersonal durchgeführt werden. Durch eine nicht fachgerechte Installation kann es zu Wasserschäden, Stromschlägen oder sogar zu Bränden kommen.
- Verwenden Sie ausschließlich das zur Ergänzung oder als Ersatz angegebene Kühlmittel. Andernfalls kann im Kühlkreislauf ein abnormal hoher Druck entstehen, der eine Fehlfunktion oder Explosion des Produkts oder Verletzungen zur Folge haben kann.
- Bevor Sie das Einlassgitter des Innengerätes oder das Wartungspaneel des Außengeräts öffnen, stellen Sie den Schutzschalter auf die Position OFF (aus). Sollten Sie diesen Hinweis nicht beachten, kann es durch Kontakt mit den Innenteilen zu einem Stromschlag kommen. Nur ein qualifizierter Installateur (*1) oder ein qualifizierter Servicetechniker (*1) darf das Einlassgitter des Innengeräts oder das Wartungspaneel des Außengeräts entfernen und die erforderlichen Arbeiten ausführen.
- Bevor Sie mit den Installations-, Wartungs-, Reparatur- oder Deinstallationsarbeiten beginnen, schalten Sie den Hauptschalter in die Stellung AUS (OFF). Anderenfalls kann es zu elektrischen Schlägen kommen.
- Stellen Sie ein Warnschild in der Nähe des Hauptschalters auf, während die Installation, Wartung, Reparatur oder Demontage durchgeführt wird. Es besteht die Gefahr von Stromschlägen, wenn der Schutzschalter aus Versehen auf ON (ein) gestellt wird.
- Nur ein qualifizierter Installateur (*1) oder ein qualifizierter Servicetechniker (*1) darf Höhenarbeiten unter Verwendung eines 50 cm hohen oder noch höheren Ständers ausführen oder das Einlassgitter des Innengeräts entfernen und die erforderlichen Arbeiten ausführen.
- Tragen Sie bei Installation, Wartung und Entsorgung Schutzhandschuhe und Arbeitsschutzbekleidung.
- Die Aluminiumlamelle des Geräts nicht berühren. Anderenfalls können Sie sich verletzen. Wenn die Rippen aus einem bestimmten Grund berührt werden muss, ziehen Sie zuerst Schutzhandschuhe und Arbeitsschutzbekleidung an, bevor Sie diese Arbeiten ausführen.

- Wenn Sie Höhenarbeiten ausführen, verwenden Sie eine Leiter gemäß ISO-Norm 14122 und befolgen Sie die in der Anleitung der Leiter aufgeführten Anweisungen. Tragen Sie als Schutzkleidung beim Ausführen der Arbeiten außerdem einen Industrie-Schutzhelm.
- Bevor Sie den Filter oder andere Teile des Außengeräts reinigen, stellen Sie unbedingt den Schutzschalter auf OFF (aus), und befestigen Sie ein Schild „Laufende Arbeiten“ neben dem Schutzschalter, bevor Sie die Arbeiten ausführen.
- Bevor Sie Höhenarbeiten ausführen, stellen Sie ein Warnschild auf, damit sich niemand dem Arbeitsbereich nähert. Teile und andere Gegenstände können von oben herunterfallen und u. U. unten befindliche Personen verletzen. Tragen Sie während der Arbeit einen Helm zum Schutz vor herabfallenden Objekten.
- Das in dieser Klimaanlage verwendete Kältemittel ist R32.
- Die Klimaanlage muss in einem stabilen Zustand transportiert werden. Setzen Sie sich mit Ihrem Fachhändler in Verbindung, falls Sie feststellen sollten, dass ein Teil des Produkts defekt ist.
- Falls die Klimaanlage von Hand transportiert wird, muss von mindestens zwei Personen getragen werden.
- Die Wartung darf nur gemäß den Empfehlungen des Herstellers durchgeführt werden. Versuchen Sie unter keinen Umständen, eines der Geräte selbst auszubauen bzw. instand zu setzen. Im Geräteinneren liegt Hochspannung an. Beim Ausbau von Abdeckung und Hauptgerät besteht elektrische Berühungsgefahr.
- Dieses Gerät ist für die Nutzung durch einem Experten oder geschulte Anwender in Geschäften, in der leichten Industrie oder für Laien bei der gewerblichen Nutzung bestimmt.

Auswahl des Installationsortes

- Wenn Sie die Klimaanlage in einem kleinen Raum installieren, treffen Sie entsprechende Vorkehrungen, damit es in dem Raum bei einem Leck nicht zu einer übermäßigen Konzentration von Kühlmitteldämpfen kommt.
- Nehmen Sie keine Installation an einem Ort vor, an dem der Austritt entflammbarer Gase möglich sein könnte. Wenn entflammbares Gas austritt und sich um das Gerät herum ansammelt, könnte es sich entzünden und einen Brand verursachen.
- Tragen Sie beim Transportieren der Klimaanlage Schuhe mit Zehenschutzkappen.
- Halten Sie die Klimaanlage beim Tragen nicht an den Bändern des Verpackungskartons fest. Anderenfalls können Sie sich verletzen, wenn die Bänder reißen.
- Installieren Sie das Innengerät mindestens 2,5 m über dem Boden, da sich Personen anderenfalls verletzen oder Stromschläge erleiden können, falls sie ihre Finger oder andere Gegenstände in das Innengerät stecken, während die Klimaanlage läuft.
- Stellen Sie keine Verbrennungsvorrichtung an Orten auf, wo sie direkt dem Wind der Klimaanlage ausgesetzt ist, da anderenfalls eine unvollständige Verbrennung die Folge ist.

- Das Gerät und die Rohrleitungen sind in einem Raum zu installieren, zu betreiben und zu lagern, dessen Raumfläche größer als $A_{\min} \text{ m}^2$ ist. So berechnen Sie $A_{\min} \text{ m}^2$: $A_{\min} = (M / (2,5 \times 0,22759 \times h_0))^2$
M ist die Füllmenge des Kältemittels im Gerät in **kg**;
 h_0 ist die Installationshöhe des Geräts in **m**:
0,6 m bei Aufstellung auf dem Fußboden / 1,8 m bei Montage an einer Wand / 1,0 m bei Montage an einem Fenster / 2,2 m bei Montage an der Decke.
Ausführliche Informationen finden Sie in der Installationsanleitung des Außengeräts.

Installation

- Wenn das Innengerät aufgehängt werden soll, müssen die angegebenen Hängeschrauben (M10 oder W3/8) und Muttern (M10 oder W3/8) verwendet werden.
- Installieren Sie die Klimaanlage sicher an einer Stelle, die für das Gewicht des Geräts geeignet ist. Ist der Boden nicht widerstandsfähig genug, kann das Gerät umkippen und Verletzungen verursachen.
- Installieren Sie die Klimaanlage entsprechend den Anweisungen im Installationshandbuch. Bei Missachtung dieser Anweisungen kann das Gerät hinunterfallen, umkippen oder Geräusche, Vibrationen, Wasseraustritte oder andere Probleme verursachen.
- Falls Sie in einem windanfälligen oder erdbebengefährdeten Gebiet leben, achten Sie bei der Installation auf eine entsprechende Auslegung der Befestigung. Wenn die Klimaanlage nicht ordnungsgemäß installiert wird, kann das Gerät umkippen oder hinunterfallen und so einen Unfall verursachen.
- Ist während der Installation Kühlmittel ausgetreten, lüften Sie den Raum umgehend. Kommen Kühlmitteldämpfe in Kontakt mit Feuer, können sich gesundheitsschädliche Gase bilden.
- Verwenden Sie für den Transport der Klimaanlage einen Gabelstapler sowie eine Winde oder einen Flaschenzug bei der Installation.

Kühlmittleitungen

- Überprüfen Sie die sichere Installation der Kühlmittleitung, bevor Sie die Klimaanlage in Betrieb nehmen. Falls der Kompressor bei geöffnetem Ventil und ohne Kühlmittelrohr betrieben wird, saugt er Luft ein und der Gasdruck im Kühlkreislauf wird extrem hoch, was zu einer Verletzung führen kann.
- Ziehen Sie die Bördelmutter mit einem Drehmomentschlüssel wie angegeben fest. Übermäßiges Festziehen der Bördelmutter kann nach längerer Zeit zu Rissen in der Bördelmutter führen, wodurch Kühlmittel auslaufen kann.
- Vergewissern Sie sich daher nach der Installation noch einmal, dass kein Kühlmittel austreten kann. Wenn Kühlmittelgase austreten und in einen Raum mit einem Herd oder Ofen gelangen, kann es bei einer offenen Flamme zur Bildung von gesundheitsschädlichen Gasen kommen.

- Wenn die Klimaanlage installiert oder umgesetzt wurde, führen Sie gemäß den Anweisungen im Installationshandbuch eine vollständige Luftspülung aus, so dass lediglich das Kühlmittel im Kühlkreislauf gemischt wird. Wird keine vollständige Luftspülung ausgeführt, können Fehlfunktionen der Klimaanlage auftreten.
- Für die Luftdichtepfung muss Stickstoff verwendet werden.
- Der Zuleitungsschlauch muss so angeschlossen werden, dass er nicht durchhängt.

Elektrische Verdrahtung

- Nur ein qualifizierter Installateur (*1) oder ein qualifizierter Servicetechniker (*1) darf Elektroarbeiten an der Klimaanlage ausführen. Unter keinen Umständen dürfen diese Arbeiten von unqualifizierten Mitarbeitern ausgeführt werden, da eine nicht sachgemäße Ausführung der Arbeit zu elektrischen Schlägen und/oder Kriechströmen führen kann.
- Tragen Sie beim Anschließen von elektrischen Drähten, Reparieren von elektrischen Teilen oder Ausführen anderer Elektroarbeiten Isolierhandschuhe zum Schutz vor Stromschlägen, isolierendes Schuhwerk sowie Arbeitsschutzkleidung zum Schutz vor Stromschlägen. Falls keine Schutzkleidung getragen wird, kann es zu elektrischen Schlägen kommen.
- Beachten Sie beim Legen von elektrischen Leitungen die Spezifikationen im Installationshandbuch sowie die Bestimmungen der lokalen Gesetze und die Rechtsvorschriften. Bei Verwendung von Kabeln, die die Spezifikationen nicht erfüllen, kann es zu Stromschlägen, Kriechströmen, Rauchentwicklungen und/oder Bränden kommen.
- Schließen Sie den Erdungsdraht an. (Erdungsarbeiten)
Eine ungenügende Erdung kann einen Stromschlag verursachen.
- Schließen Sie die Erdungskabel nie an Gas- oder Wasserleitungen, Blitzableiter oder Erdungskabel von Telefonkabeln an.
- Prüfen Sie nach Abschluss der Reparatur- oder Umsetzungsarbeiten, ob die Erdungsleiter korrekt angeschlossen sind.
- Installieren Sie einen Schutzschalter, der die Spezifikationen im Installationshandbuch sowie die Bestimmungen der lokalen Gesetze und die Rechtsvorschriften erfüllt.
- Bringen Sie den Schutzschalter an einem Ort an, wo er vom Bediener problemlos erreicht werden kann.
- Wenn der Schutzschalter im Freien installiert werden soll, verwenden Sie einen Outdoor-Schutzschalter.
- Unter keinen Umständen darf die Stromleitung oder die Anschlussleitung des Innengeräts und Außengeräts in der Mitte angeschlossen werden (Anschluss an einem lötfreien Anschluss usw.)
Ein Anschlussfehler, der dadurch entsteht, dass die Leitung in der Mitte angeschlossen wurde, kann zu Rauchbildung und/oder einem Brand führen.

- Alle elektrischen Arbeiten sind nach geltender Vorschrift und unter Beachtung der Installationsanleitung auszuführen.
Es besteht Stromschlag- und Kurzschlussgefahr.

Testlauf

- Stellen Sie vor der Inbetriebnahme der Klimaanlage sicher, dass die Abdeckung des Stromkastens am Raumgerät und das Wartungsbedienfeld des Außengeräts geschlossen sind und der Schutzschalter auf die Position ON (EIN) eingestellt ist. Sie können einen elektrischen Schlag erleiden, falls der Strom eingeschaltet wird, ohne dass Sie vorher diese Prüfungen durchgeführt haben.
- Falls Probleme mit der Klimaanlage auftreten (z. B. ein Fehler wird angezeigt, es riecht verbrannt, ungewöhnliche Geräusche sind zu hören, die Klimaanlage kühlt bzw. heizt nicht oder Wasser läuft aus), suchen Sie nicht selbst nach der Ursache, sondern stellen Sie den Schutzschalter auf die Position OFF (aus) und wenden Sie sich an einen Servicetechniker. Stellen Sie sicher, dass der Strom nicht wieder eingeschaltet wird (indem Sie beispielsweise den Schutzschalter durch „außer Betrieb“ kennzeichnen), bis ein qualifizierter Servicetechniker eintrifft. Die weitere Verwendung der Klimaanlage in fehlerhaftem Zustand kann zur Verschlimmerung der mechanischen Probleme oder zu elektrischen Schlägen und anderen Problemen führen.
- Nachdem die Arbeiten abgeschlossen wurden, überprüfen Sie mit einem Isolationsprüfgerät (500 V Megger-Tester), dass der Widerstand zwischen dem geladenen Teil und dem nichtgeladenen Metallteil (Erdungsbereich) 1 MΩ oder mehr beträgt. Falls der Widerstandswert zu niedrig ist, können an der Benutzerseite Kriechströme oder Stromschläge verursacht werden.
- Stellen Sie nach Abschluss der Installationsarbeiten sicher, dass kein Kühlmittel ausläuft, und prüfen Sie Isolierwiderstand sowie Wasserableitung. Führen Sie danach einen Testlauf durch, um sicherzustellen, dass die Klimaanlage ordnungsgemäß funktioniert.

Dem Benutzer mitzuteilende Informationen

- Teilen Sie dem Benutzer nach Abschluss der Installationsarbeiten mit, wo sich der Schutzschalter befindet. Sollte der Benutzer nicht wissen, wo sich der Schutzschalter befindet, kann er diesen nicht ausschalten, falls Probleme mit der Klimaanlage auftreten.
- Nach Abschluss der Installationsarbeiten erläutern Sie dem Kunden die Verwendung und Wartung des Geräts entsprechend dem Benutzerhandbuch.

Umsetzung

- Nur ein qualifizierter Installateur (*1) oder ein qualifizierter Servicetechniker (*1) darf die Klimaanlage umsetzen. Es ist gefährlich, wenn die Klimaanlage durch einen nicht qualifizierten Benutzer umgesetzt wird, da es zu Bränden, elektrischen Schlägen, Verletzungen, Wasseraustritten, Geräuschen und/oder Vibrationen kommen kann.
- Schließen Sie beim Durchführen der Abpumparbeiten zuerst den Kompressor, bevor Sie das Kühlmittelrohr trennen. Wenn die Kältemittelleitung bei offenem Wartungsventil abgetrennt wird und der Kompressor noch läuft, werden Luft oder andere Gase angesaugt. Der Druck im Kältemittelkreislauf steigt, und es besteht die Gefahr eines Leitungsbruchs und dementsprechend die Gefahr von Verletzungen und anderen Störungen.

(*1) Siehe „Definition der Bezeichnungen „Qualifizierter Installateur“ oder „Qualifizierter Servicetechniker““.

VORSICHT

Diese Klimaanlage verwendet ein HFC-Kältemittel (R32), das die Ozonschicht nicht angreift.

- Da das R32-Kältemittel aufgrund des hohen Drucks leicht durch Verunreinigungen wie zum Beispiel Feuchtigkeit, einer Oxidationsschicht, Öl usw. in Mitleidenschaft gezogen wird, achten Sie sorgfältig darauf, dass bei den Installationsarbeiten keine Feuchtigkeit, Schmutz, verbrauchtes Kältemittel, Kältemaschinenöl usw. in den Kältemittelkreislauf eindringt.
 - Für die Installation ist ein Spezialwerkzeug für das Kältemittel R32 erforderlich.
 - Verwenden Sie für das Anschließen der Rohre neue und saubere Leitungen, sodass das Kältemittel während der Installationsarbeiten nicht mit Wasser und Schmutz verunreinigt wird.
 - Wenn Sie die vorhandenen Leitungen verwenden, befolgen Sie die dem Außengerät beigefügte Installationsanleitung.
-

Grazie per aver acquistato questo condizionatore d'aria Toshiba.

Leggere attentamente queste istruzioni, che contengono informazioni importanti di conformità con la "Direttiva macchinari 2006/42/EC", e assicurarsi di averle comprese.

Al termine dell'installazione, consegnare al cliente il Manuale d'installazione e il Manuale dell'utente raccomandandogli di conservarli per qualsiasi esigenza futura.

Denominazione generica: Condizionatore d'aria

Definizione di installatore qualificato o tecnico dell'assistenza qualificato

Il condizionatore d'aria deve essere installato, sottoposto a manutenzione, riparato e rimosso da un installatore qualificato o da un tecnico dell'assistenza qualificato. Quando deve essere eseguito uno di questi lavori, rivolgersi a un installatore qualificato o a un tecnico di assistenza qualificato per svolgerli.

Un installatore qualificato o un tecnico dell'assistenza qualificato è un agente che dispone delle qualifiche e dell'esperienza descritti nella tabella seguente.

Agente	Qualifiche ed esperienza di cui deve disporre l'agente
Installatore qualificato (*1)	<ul style="list-style-type: none"> L'installatore qualificato è una persona che installa, effettua la manutenzione, sposta e rimuove i condizionatori d'aria costruiti da Toshiba Carrier Corporation. Ha ricevuto la formazione necessaria per installare, mantenere, spostare e rimuovere i condizionatori d'aria costruiti da Toshiba Carrier Corporation o, in alternativa, è stato addestrato da uno o più individui in possesso della necessaria formazione, ed è pertanto idoneo a svolgere tali operazioni. L'installatore qualificato autorizzato a eseguire i lavori elettrici richiesti per l'installazione, il trasferimento e la rimozione del condizionatore d'aria possiede le qualifiche necessarie per svolgere tali compiti, come stabilito dalle leggi e dai regolamenti locali; è stato addestrato a lavorare sui condizionatori d'aria direttamente da Toshiba Carrier Corporation o da uno o più individui in possesso della necessaria formazione ed è pertanto idoneo a svolgere tale lavoro. L'installatore qualificato autorizzato a eseguire i lavori di gestione del refrigerante e di posa dei tubi richiesti per l'installazione, il trasferimento e la rimozione del condizionatore d'aria possiede le qualifiche necessarie per svolgere tali compiti, come stabilito dalle leggi e dai regolamenti locali; è stato addestrato a lavorare a svolgere i lavori di gestione del refrigerante e di posa dei tubi direttamente da Toshiba Carrier Corporation o da uno o più individui in possesso della necessaria formazione ed è pertanto idoneo a svolgere tale lavoro. L'installatore qualificato autorizzato a svolgere lavori in altezza ha ricevuto la formazione necessaria per effettuare tali lavori con i condizionatori d'aria costruiti da Toshiba Carrier Corporation o, in alternativa, è stato addestrato da uno o più individui in possesso della necessaria formazione, ed è pertanto idoneo a svolgere tali operazioni.
Tecnico dell'assistenza qualificato (*1)	<ul style="list-style-type: none"> Il tecnico dell'assistenza qualificato è una persona che installa, effettua la riparazione e la manutenzione, sposta e rimuove i condizionatori d'aria costruiti da Toshiba Carrier Corporation. Ha ricevuto la formazione necessaria per installare, riparare, mantenere, spostare e rimuovere i condizionatori d'aria costruiti da Toshiba Carrier Corporation o, in alternativa, è stato addestrato da uno o più individui in possesso della necessaria formazione, ed è pertanto idoneo a svolgere tali operazioni. Il tecnico dell'assistenza qualificato autorizzato a eseguire i lavori elettrici richiesti per l'installazione, la riparazione, il trasferimento e la rimozione del condizionatore d'aria possiede le qualifiche necessarie per svolgere tali compiti, come stabilito dalle leggi e dai regolamenti locali; è stato addestrato a lavorare sui condizionatori d'aria direttamente da Toshiba Carrier Corporation o da uno o più individui in possesso della necessaria formazione ed è pertanto idoneo a svolgere tale lavoro. Il tecnico dell'assistenza qualificato autorizzato a eseguire i lavori di gestione del refrigerante e di posa dei tubi richiesti per l'installazione, la riparazione, il trasferimento e la rimozione del condizionatore d'aria possiede le qualifiche necessarie per svolgere tali compiti, come stabilito dalle leggi e dai regolamenti locali; è stato addestrato a lavorare a svolgere i lavori di gestione del refrigerante e di posa dei tubi direttamente da Toshiba Carrier Corporation o da uno o più individui in possesso della necessaria formazione ed è pertanto idoneo a svolgere tale lavoro. Il tecnico dell'assistenza qualificato autorizzato a svolgere lavori in altezza ha ricevuto la formazione necessaria per effettuare tali lavori con i condizionatori d'aria costruiti da Toshiba Carrier Corporation o, in alternativa, è stato addestrato da uno o più individui in possesso della necessaria formazione, ed è pertanto idoneo a svolgere tali operazioni.

Definizione di attrezzatura protettiva

Prima di procedere alle operazioni di trasporto, installazione, manutenzione, riparazione o rimozione del condizionatore d'aria è necessario indossare sempre guanti e abbigliamento protettivi.



In aggiunta ai normali dispositivi di protezione, indossare i dispositivi di protezione descritti di seguito, prima di procedere all'esecuzione dei lavori speciali elencati nella tabella sottostante.

La mancata osservanza di questa indicazione espone l'operatore al rischio di lesioni, ustioni, elettrocuzione, ecc.





Lavoro intrapreso	Attrezzatura protettiva indossata
Tutti i tipi di lavori	Guanti protettivi Abbigliamento protettivo da lavoro
Lavori elettrici	Abbigliamento per la protezione da elettrocuzione Scarpe isolanti Guanti di protezione da scosse elettriche
Lavori in altezza (50 cm o più)	Elmetti per uso industriale
Trasporto di oggetti pesanti	Scarpe con calotte protettive aggiuntive per le dita
Riparazione dell'unità esterna	Guanti di protezione per elettricisti

■ Significati dei simboli visualizzati sul condizionatore d'aria





Le avvertenze per la sicurezza di seguito illustrate forniscono istruzioni importanti per prevenire lesioni alle persone e il danneggiamento delle cose. Si raccomanda di leggere il manuale solo dopo avere ben compreso tali avvertenze (testi).

Indicazione	Significato delle indicazioni
 AVVERTENZA	I richiami abbinati a questo simbolo indicano che la mancata osservanza delle istruzioni ad esso abbinato potrebbe divenire causa di lesioni personali gravi (*1) o anche fatali.
 ATTENZIONE	I richiami abbinati a questo simbolo indicano che la mancata osservanza delle istruzioni ad esso abbinato potrebbe divenire causa di lievi lesioni personali (*2) o di danni delle cose (*3).

*1: Con "lesioni personali gravi" s'intendono la perdita della vista, lesioni fisiche in generale, ustioni, scosse elettriche, fratture ossee, avvelenamento nonché altri effetti durevolmente nocivi per la salute e la necessità di ricovero ospedaliero o di terapia di lungo termine.
 *2: Con "lievi lesioni personali" s'intendono le ustioni, le scosse elettriche e le altre lesioni fisiche generali che non richiedono ricovero ospedaliero né terapie di lungo termine.
 *3: Con "danni alle cose" s'intendono il danneggiamento degli edifici o dell'arredamento e/o dotazione dell'abitazione nonché gli effetti nocivi sugli animali domestici e non.

	AVVERTENZA (rischio di incendio)
	Leggere attentamente il MANUALE DELL'UTENTE prima dell'uso.
	Il personale addetto alla manutenzione è tenuto a leggere attentamente il MANUALE DELL'UTENTE e il MANUALE DI INSTALLAZIONE prima del funzionamento.
	Per maggiori informazioni consultare il MANUALE DELL'UTENTE, il MANUALE D'INSTALLAZIONE e simili.

Indicazioni di avvertimento sul condizionatore d'aria

Indicazione di avvertimento	Descrizione
 <p>WARNING ELECTRICAL SHOCK HAZARD Disconnect all remote electric power supplies before servicing.</p>	<p>AVVERTENZA PERICOLO DI SCOSSA ELETTRICA Scollegare tutte le fonti di alimentazione elettrica remote, prima di sottoporre a interventi di assistenza.</p>
 <p>WARNING Moving parts. Do not operate unit with grille removed. Stop the unit before the servicing.</p>	<p>AVVERTENZA Parti mobili. Non far funzionare l'unità con la griglia rimossa. Arrestare l'unità prima di sottoporla ad assistenza.</p>
 <p>CAUTION High temperature parts. You might get burned when removing this panel.</p>	<p>ATTENZIONE Parti ad alta temperatura. Quando si rimuove questo pannello sussiste il pericolo di ustione.</p>
 <p>CAUTION Do not touch the aluminum fins of the unit. Doing so may result in injury.</p>	<p>ATTENZIONE Non toccare le alette in alluminio dell'unità. In caso contrario, si potrebbero provocare lesioni personali.</p>
 <p>CAUTION BURST HAZARD Open the service valves before the operation, otherwise there might be the burst.</p>	<p>ATTENZIONE PERICOLO DI SCOPPIO Aprire le valvole di servizio prima dell'operazione; in caso contrario, si potrebbe verificare uno scoppio.</p>

1 Precauzioni per la sicurezza

Il produttore non si assume alcuna responsabilità per i danni causati dalla mancata osservazione delle descrizioni del presente manuale.

AVVERTENZA

Generali

- Prima d'iniziare l'installazione del condizionatore si raccomanda di leggere con attenzione il manuale d'installazione e di osservarne scrupolosamente ogni istruzione ivi fornita.
- Solo un installatore qualificato o un tecnico dell'assistenza qualificato sono autorizzati a installare l'unità. Se l'installazione non è stata eseguita correttamente si possono infatti verificare perdite d'acqua, scosse elettriche o un incendio.
- Per rabbocchi o sostituzioni, non utilizzare refrigeranti diversi da quello indicato. In caso contrario nel ciclo di refrigerazione si può generare una pressione eccessiva, che può generare guasti, esplosione del prodotto o lesioni personali.
- Prima di aprire la griglia della presa d'aria dell'unità interna o il pannello di servizio dell'unità esterna, impostare l'interruttore automatico sulla posizione OFF (spento). La mancata impostazione dell'interruttore automatico sulla posizione OFF (spento) potrebbe provocare scosse elettriche attraverso il contatto con le parti interne. Solo un installatore qualificato (*1) o un tecnico dell'assistenza qualificato (*1) sono autorizzati a rimuovere la griglia della presa d'aria dell'unità interna o il pannello di servizio dell'unità esterna e a svolgere il lavoro richiesto.
- Prima di effettuare i lavori di installazione, manutenzione, riparazione o rimozione, impostare l'interruttore sulla posizione OFF. In caso contrario, si potrebbero causare scosse elettriche.
- Sistemare un cartello con l'indicazione "Lavori in corso" in prossimità dell'interruttore automatico durante l'esecuzione di lavori di installazione, manutenzione, riparazione o rimozione. Qualora l'interruttore automatico sia impostato su ON (acceso) per errore, sussiste il pericolo di scosse elettriche.
- Solo un installatore qualificato (*1) o un tecnico dell'assistenza qualificato (*1) sono autorizzati a svolgere lavori in altezza utilizzando un supporto di altezza pari o superiore a 50 cm per rimuovere la griglia della presa d'aria dell'unità interna al fine dello svolgimento dei lavori.
- Durante l'installazione, la manutenzione e la rimozione, indossare guanti di protezione e indumenti da lavoro di sicurezza.
- Non toccare l'aletta in alluminio dell'unità. In caso contrario, si potrebbero provocare lesioni personali. Qualora sia necessario toccare l'aletta per qualche motivo, indossare prima guanti di protezione e indumenti da lavoro di sicurezza, quindi procedere.

- Quando si lavora in altezza, utilizzare una scala conforme allo standard ISO 14122, e attenersi alla procedura indicata nelle sue istruzioni. Inoltre, indossare un elmetto per uso industriale come attrezzatura di protezione per intraprendere il lavoro.
- Prima di pulire il filtro o altre parti dell'unità esterna, impostare l'interruttore sulla posizione OFF (spento) e sistemare un cartello con l'indicazione "Lavori in corso" in prossimità dell'interruttore, prima di iniziare il lavoro.
- Prima di lavorare in altezza, sistemare un cartello in modo che nessuno si avvicini alla sede dei lavori, prima di procedere con i lavori. Parti e altri oggetti potrebbero cadere dall'alto, con la possibilità di provocare lesioni personali a chi si trovi sotto. Mentre si effettuano i lavori, indossare un casco per proteggersi dalla caduta di oggetti.
- Il refrigerante utilizzato da questo condizionatore d'aria è R32.
- Il condizionatore deve essere trasportato in condizioni stabili. Qualora una parte qualsiasi non sia integra si raccomanda di rivolgersi immediatamente al rivenditore.
- Se il condizionatore deve essere trasportato manualmente, l'operazione deve essere effettuata da due o più persone.
- La manutenzione deve essere eseguita solo come consigliato dal produttore. Non tentare di spostare o riparare l'unità da soli. L'unità contiene componenti ad alta tensione. La rimozione del coperchio e dell'unità centrale potrebbe esporre al rischio di elettrocuzione.
- Questo apparecchio è destinato all'uso da parte di utenti esperti o addestrati all'interno di negozi del settore o per uso commerciale da parte di utenti comuni.

Selezione della sede di installazione

- Se il condizionatore deve essere installato in un locale piccolo è necessario evitare che in caso di perdite il gas refrigerante raggiunga una concentrazione critica.
- Non installare le unità in un luogo soggetto a possibili fughe di gas infiammabili. Qualora dovessero raggiungere una concentrazione elevata attorno ad esse potrebbero infatti causare un incendio.
- Per trasportare il condizionatore d'aria, indossare scarpe con calotte protettive aggiuntive per le dita.
- Quando si trasporta il condizionatore d'aria, non afferrare le fascette che circondano la scatola di imballaggio. Qualora le fascette si rompano, si potrebbero subire lesioni personali.
- Installare l'unità interna ad almeno 2,5 metri di altezza dal pavimento, poiché, in caso contrario, gli utenti potrebbero subire lesioni personali o scosse elettriche qualora urtino con le dita o altri oggetti l'unità interna mentre il condizionatore d'aria è in funzione.

- Non collocare apparecchi a combustione di alcun genere in luoghi che siano direttamente esposti al flusso d'aria prodotto dal condizionatore d'aria; in caso contrario, il condizionatore potrebbe provocare una combustione imperfetta.
- L'apparecchio e i tubi devono essere installati, fatti funzionare e immagazzinati in un locale con una superficie più grande di A_{\min} m².
Come ottenere A_{\min} m²: $A_{\min} = (M / (2,5 \times 0,22759 \times h_0))^2$
M è la quantità di carica del refrigerante nell'apparecchio in **kg**;
 h_0 è l'altezza di installazione dell'apparecchio in **m**:
0,6 m per installazione a pavimento/1,8 m per installazione a parete/1,0 m per installazione a finestra/2,2 m per installazione a soffitto.
Per i dettagli, fare riferimento al Manuale di installazione dell'unità esterna.

Installazione

- Quando si deve montare in sospensione l'unità interna, è necessario utilizzare i bulloni di sospensione (M10 o W3/8) e i relativi dadi (M10 o W3/8) specificati.
- Il condizionatore deve essere installato in un punto in grado di sostenerne adeguatamente il peso. Qualora la resistenza non sia sufficiente, l'unità potrebbe cadere e provocare lesioni personali.
- Attenersi alle istruzioni nel Manuale di installazione per installare il condizionatore d'aria. La mancata osservanza di queste istruzioni potrebbe infatti causare la caduta o il ribaltamento delle unità, nonché divenire causa di rumore, vibrazioni, fuoriuscite d'acqua o altri problemi.
- Effettuare l'installazione considerando l'eventuale possibilità di vento forte o di terremoti. Se il condizionatore non è installato correttamente, un'unità può ribaltarsi o cadere, causando un incidente.
- Se durante l'installazione si verifica una fuga del gas refrigerante occorre ventilare subito l'ambiente. A contatto con fiamme libere il gas refrigerante s'incendia generando sostanze nocive.
- Utilizzare un carrello elevatore per trasportare le unità del condizionatore e per la loro installazione utilizzare un argano o un paranco.

Tubi del liquido refrigerante

- Installare il tubo del refrigerante stabilmente durante i lavori di installazione, prima di mettere in funzione il condizionatore d'aria. Se il compressore viene messo in funzione con la valvola aperta e senza il tubo del refrigerante, il compressore aspira aria e il circuito di refrigerazione raggiunge una pressione eccessiva, con la possibilità di causare lesioni personali.
- Serrare il dado svasato con una chiave torsionometrica come illustrato. Un serraggio eccessivo del dado svasato potrebbe causare delle spaccature nel lungo periodo, il che potrebbe provocare perdite di refrigerante.

- Una volta completata l'installazione è quindi di estrema importanza verificare che non vi siano perdite. Qualora si verifichi una perdita di gas refrigerante nella stanza e il gas entri in contatto con una sorgente di fiamme, per esempio un fornello di cucina, si potrebbero generare gas tossici.
- Quando il condizionatore d'aria è stato installato o trasferito, attenersi alle istruzioni nel Manuale di installazione e spurgare completamente l'aria in modo che nessun altro gas si mescoli al refrigerante nel circuito di refrigerazione. Qualora non si effettui lo spurgo completo dell'aria, si potrebbe provocare un malfunzionamento del condizionatore d'aria.
- Per la prova di tenuta dell'aria è necessario utilizzare gas di azoto.
- Il tubo flessibile di carico deve essere collegato in modo tale da non essere lasco.

Cavi elettrici

- Solo un installatore qualificato (*1) o un tecnico dell'assistenza qualificato (*1) sono autorizzati a eseguire i lavori sull'impianto elettrico per il condizionatore d'aria. In nessuna circostanza tali lavori devono essere effettuati da una persona non qualificata, poiché un'esecuzione non appropriata dei lavori potrebbe provocare scosse elettriche e/o dispersioni di corrente.
- Per evitare di ricevere scosse elettriche, prima di eseguire collegamenti elettrici, riparare parti elettriche o condurre altre attività sull'impianto elettrico si raccomanda d'indossare guanti per elettricisti e scarpe e indumenti isolanti. Qualora non si indossino queste attrezzature protettive, si potrebbero provocare scosse elettriche.
- Utilizzare cablaggi che soddisfino le specifiche nel Manuale di installazione e le direttive delle norme e nelle leggi locali. L'uso di cablaggi che non soddisfino le specifiche potrebbe provocare scosse elettriche, dispersioni di corrente, fumo e/o un incendio.
- Collegare il cavo di terra. (cablaggio di messa a terra)
Una messa a terra incompleta causa scosse elettriche.
- Non collegare i cavi di messa a terra a tubi del gas, tubi dell'acqua, conduttori dei parafulmini o a cavi di messa a terra per cablaggi telefonici.
- Dopo aver completato i lavori di riparazione o di trasferimento, verificare che i cavi elettrici di messa a terra siano collegati correttamente.
- Installare un interruttore automatico che soddisfi le specifiche nel Manuale di installazione e le direttive delle norme e delle leggi locali.
- Installare l'interruttore automatico in una sede che sia facilmente accessibile dall'agente.
- Quando si installa l'interruttore automatico all'aperto, installarne uno progettato per l'uso per esterno.

- In nessuna circostanza, il cavo di alimentazione o il cavo di collegamento dell'unità interna ed esterna deve essere collegato nel mezzo (collegamento usando un terminale senza saldature, ecc.) Eventuali guasti al collegamento nelle sedi in cui il cavo è collegato nel mezzo possono provocare fumo e/o un incendio.
- I lavori di cablaggio elettrico devono essere effettuati in conformità alle normative vigenti e al manuale di installazione. La mancata osservanza di questa indicazione espone al rischio di elettrocuzione o cortocircuito.

Prova di funzionamento

- Prima di avviare il condizionatore dopo averne completato l'installazione, verificare che il coperchio della scatola elettrica di controllo dell'unità interna e il pannello di servizio dell'unità esterna siano chiusi e che l'interruttore di sicurezza automatico sia inserito. Qualora si accenda l'unità senza aver prima eseguito questi controlli, si potrebbe subire una scossa elettrica.
- Se si nota il verificarsi di un problema di qualche tipo con il condizionatore d'aria (ad esempio è stato visualizzato un codice di controllo, si sente odore di bruciato, si sentono suoni anomali, il condizionatore d'aria non raffredda o non riscalda, oppure è presente una perdita d'acqua), non toccare da soli il condizionatore d'aria, ma impostare l'interruttore automatico sulla posizione OFF (spento) e contattare un tecnico dell'assistenza qualificato. Adottare delle misure per assicurare che l'unità non venga accesa (ad esempio scrivendo "fuori servizio" in prossimità dell'interruttore automatico) fino all'arrivo di un tecnico dell'assistenza qualificato. L'uso continuato del condizionatore in questa condizione anomala potrebbe divenire causa di problemi meccanici, generare scosse elettriche o causare altri problemi.
- Al termine del lavoro, utilizzare un misuratore di isolamento (Megger 500 V) per controllare che la resistenza sia 1 MΩ tra la sezione sotto carico elettrico e la sezione di metallo che non è sotto carico elettrico (sezione di terra). Qualora il valore di resistenza sia basso, potrebbe verificarsi un grave problema, quale una dispersione o una scossa elettrica, dal lato dell'utente.
- Al completamento del lavoro di installazione, controllare eventuali perdite di refrigerante e controllare la resistenza di isolamento e lo scarico dell'acqua. Quindi, eseguire un funzionamento di prova per controllare che il condizionatore d'aria funzioni correttamente.

Spiegazioni fornite all'utente

- Al completamento del lavoro di installazione, comunicare all'utente dove sia situato l'interruttore automatico. Qualora l'utente non sappia dove si trovi l'interruttore automatico, non sarà in grado di disattivarlo, nell'eventualità che si verifichi un problema con il condizionatore d'aria.
- Al termine del lavoro di installazione, seguire il Manuale del proprietario per spiegare al cliente come utilizzare e sottoporre a manutenzione l'unità.

Trasferimento

- Solo un installatore qualificato (*1) o un tecnico dell'assistenza qualificato (*1) sono autorizzati a trasferire il condizionatore d'aria. È pericoloso far trasferire il condizionatore d'aria da una persona non qualificata, in quanto si potrebbero provocare incendi, scosse elettriche, lesioni personali, perdite d'acqua, rumori e/o vibrazioni.
- Quando si eseguono lavori di svuotamento del refrigerante (Pump-down), spegnere il compressore prima di scollegare il tubo del refrigerante. Eseguendo questo scollegamento con la valvola di servizio aperta e il compressore in funzione si causerebbe l'aspirazione dell'aria o di altri gas eventualmente presenti nell'atmosfera, elevando in tal modo la pressione interna al circuito refrigerante a un livello eccessivamente alto con possibili rotture, lesioni personali o problemi di funzionamento.

(*1) Consultare la "Definizione di installatore qualificato o tecnico dell'assistenza qualificato".

ATTENZIONE

Questo condizionatore ha adottato un refrigerante HFC (R32) che non distrugge lo strato di ozono.

- Dato che il refrigerante R32 è facilmente influenzato da impurità, come umidità, patina ossidata, olio, ecc., a causa dell'alta pressione, fare attenzione a non permettere che umidità, sporco, refrigerante esistente, olio refrigerante per macchina, ecc., si mescolino nel ciclo del refrigerante durante il lavoro di installazione.
- Per l'installazione è richiesto un utensile speciale per il refrigerante R32.
- Utilizzare materiali di tubazione nuovi e puliti per il tubo di collegamento, in modo che umidità e sporco non vengano mescolati insieme durante il lavoro di installazione.
- Quando si utilizzano tubazioni esistenti, seguire il manuale di installazione in dotazione con l'unità esterna.

Gracias por haber adquirido este aparato de aire acondicionado Toshiba.

Lea atenta y completamente estas instrucciones que contienen información importante conforme a la "Directiva 2006/42/CE relativa a las máquinas" y asegúrese de entenderlas bien.

Tras completar el trabajo de instalación, entregue al usuario este Manual de instalación y el Manual del propietario, y pida al usuario que los guarde en un lugar seguro para que le sirvan de referencia en el futuro.

Denominación genérica: Acondicionador de aire

Definición de instalador cualificado o persona de servicio cualificada

El aparato de aire acondicionado deberá ser instalado, mantenido, reparado y desechado por un instalador cualificado o por una persona de servicio cualificada. Cuando tenga que hacer cualquiera de estos trabajos, solicite a un instalador cualificado o a una persona de servicio cualificada que los haga.

Un instalador cualificado o una persona de servicio cualificada es un agente con las cualificaciones y conocimientos descritos en la tabla de abajo.

Agente	Cualificaciones y conocimientos que debe tener el agente
Instalador cualificado (*1)	<ul style="list-style-type: none"> El instalador cualificado es una persona que se dedica a la instalación, mantenimiento, traslado y retirada de los aparatos de aire acondicionado fabricados por Toshiba Carrier Corporation. Dicha persona habrá recibido formación relativa a la instalación, mantenimiento, traslado y retirada de aparatos de aire acondicionado fabricados por Toshiba Carrier Corporation, o, de otro modo, habrá sido instruido en dichas operaciones por otra u otras personas que hayan recibido formación en la materia y que por tanto posean amplios conocimientos relativos a dichas operaciones. El instalador cualificado que esté autorizado para realizar los trabajos eléctricos propios de la instalación, traslado y retirada poseerá las cualificaciones relativas a dichos trabajos eléctricos, de conformidad con la legislación local vigente, y habrá recibido formación relativa a las tareas eléctricas a realizar en los aparatos de aire acondicionado fabricados por Toshiba Carrier Corporation, o, de otro modo, habrá sido instruido en dichas tareas por otra u otras personas que hayan recibido formación en la materia y que por tanto posean amplios conocimientos relativos a dichas operaciones. El instalador cualificado que esté autorizado para realizar los trabajos de canalización y manejo del refrigerante propios de la instalación, traslado y retirada poseerá las cualificaciones relativas a dichos trabajos de canalización y manejo del refrigerante, de conformidad con la legislación local vigente, y habrá recibido formación relativa a las tareas de canalización y uso del refrigerante a realizar en los aparatos de aire acondicionado fabricados por Toshiba Carrier Corporation, o, de otro modo, habrá sido instruido en dichas tareas por otra u otras personas que hayan recibido formación en la materia y que por tanto posean amplios conocimientos relativos a dichas operaciones. El instalador cualificado que esté autorizado para trabajar en alturas habrá recibido formación relativa a la realización de trabajos en altura con los aparatos de aire acondicionado fabricados por Toshiba Carrier Corporation, o, de otro modo, habrá sido instruido en dichas tareas por otra u otras personas que hayan recibido formación en la materia y que por tanto posean amplios conocimientos relativos a dichos trabajos.
Persona de servicio cualificada (*1)	<ul style="list-style-type: none"> La persona de servicio cualificada es una persona que se dedica a la instalación, reparación, mantenimiento, traslado y retirada de los aparatos de aire acondicionado fabricados por Toshiba Carrier Corporation. Dicha persona habrá recibido formación relativa a la instalación, reparación, mantenimiento, traslado y retirada de aparatos de aire acondicionado fabricados por Toshiba Carrier Corporation, o, de otro modo, habrá sido instruido en dichas operaciones por otra u otras personas que hayan recibido formación en la materia y que por tanto posean amplios conocimientos relativos a dichas operaciones. La persona de servicio cualificada que esté autorizada para realizar los trabajos eléctricos propios de la instalación, reparación, traslado y retirada poseerá las cualificaciones relativas a dichos trabajos eléctricos, de conformidad con la legislación local vigente, y habrá recibido formación relativa a las tareas eléctricas a realizar en los aparatos de aire acondicionado fabricados por Toshiba Carrier Corporation, o, de otro modo, habrá sido instruido en dichas tareas por otra u otras personas que hayan recibido formación en la materia y que por tanto posean amplios conocimientos relativos a dichas operaciones. La persona de servicio cualificada que esté autorizada para realizar los trabajos de canalización y manejo del refrigerante propios de la instalación, reparación, traslado y retirada poseerá las cualificaciones relativas a dichos trabajos de canalización y manejo del refrigerante, de conformidad con la legislación local vigente, y habrá recibido formación relativa a las tareas de canalización y uso del refrigerante a realizar en los aparatos de aire acondicionado fabricados por Toshiba Carrier Corporation, o, de otro modo, habrá sido instruido en dichas tareas por otra u otras personas que hayan recibido formación en la materia y que por tanto posean amplios conocimientos relativos a dichas operaciones. La persona de servicio cualificada que esté autorizada para trabajar en alturas habrá recibido formación relativa a la realización de trabajos en altura con los aparatos de aire acondicionado fabricados por Toshiba Carrier Corporation, o, de otro modo, habrá sido instruido en dichas tareas por otra u otras personas que hayan recibido formación en la materia y que por tanto posean amplios conocimientos relativos a dichos trabajos.

Definición del equipo de protección

Cuando vaya a proceder al traslado, instalación, mantenimiento, reparación o retirada del aparato de aire acondicionado, utilice guantes protectores y ropa de trabajo de "seguridad".



Además de este equipo protector habitual, utilice el equipo protector que se describe a continuación cuando emprenda las operaciones especiales que se detallan en la tabla siguiente.

De no utilizar el equipo protector adecuado, incurrirá en cierto riesgo personal ya que estará más expuesto a sufrir heridas, quemaduras, descargas eléctricas y demás lesiones.

Trabajo realizado	Equipo de protección usado
Todo tipo de trabajos	Guantes de protección Ropa de trabajo de "seguridad"
Trabajo relacionado con equipos eléctricos	Ropa que ofrezca protección contra descargas eléctricas Calzado aislante Guantes de protección contra descargas eléctricas
Trabajos en altura (50 cm o más)	Cascos de seguridad de uso industrial
Transporte de objetos pesados	Zapatos con protección adicional en las punteras
Reparación de la unidad exterior	Guantes para protegerse de las descargas eléctricas

■ Significado de los símbolos visualizados en el aparato de aire acondicionado





Estas precauciones de seguridad describen aspectos importantes relacionados con la seguridad para evitar lesiones a los usuarios o a terceros y daños materiales. Por favor lea este manual después de comprender el siguiente contenido (significado de las indicaciones) y asegúrese de observar las descripciones.

Indicación	Significado de las indicaciones
 ADVERTENCIA	El texto que se resalta de esta forma indica que el no cumplimiento de las instrucciones en la advertencia podría provocar lesiones personales muy graves (*1) o la muerte si el producto se manipula indebidamente.
 PRECAUCIÓN	El texto que se resalta de esta forma indica que el no cumplimiento de las instrucciones en la precaución podría provocar lesiones leves (*2) o daños (*3) a la propiedad si el producto se manipula indebidamente.





*1: Las lesiones personales muy incluyen: pérdida de la vista, heridas, quemaduras, electrocución, fracturas, envenenamiento y otras lesiones que dejan secuelas y requieren hospitalización o tratamientos ambulatorios prolongados.

*2: Las lesiones leves incluyen: heridas, quemaduras, electrocución u otras lesiones que no requieren hospitalización ni tratamiento ambulatorio prolongado.

*3: Daño a la propiedad indica daños a edificios, elementos del hogar, ganado doméstico o mascotas.

	ADVERTENCIA (Riesgo de incendio)
	Lea atentamente el MANUAL DEL PROPIETARIO antes de la operación.
	El personal de servicio debe leer detenidamente el MANUAL DEL PROPIETARIO y el MANUAL DE INSTALACIÓN antes de la operación.
	Podrá encontrar más información en el MANUAL DEL PROPIETARIO, MANUAL DE INSTALACIÓN, etc.

Advertencias en cuanto a la unidad de aire acondicionado

Indicación de advertencia		Descripción
	<p>WARNING</p> <p>ELECTRICAL SHOCK HAZARD Disconnect all remote electric power supplies before servicing.</p>	<p>ADVERTENCIA</p> <p>PELIGRO DE DESCARGA ELÉCTRICA Desconecte todos los suministros eléctricos remotos antes de hacer reparaciones.</p>
	<p>WARNING</p> <p>Moving parts. Do not operate unit with grille removed. Stop the unit before the servicing.</p>	<p>ADVERTENCIA</p> <p>Piezas móviles. No utilice la unidad con la rejilla retirada. Pare la unidad antes de hacer reparaciones.</p>
	<p>CAUTION</p> <p>High temperature parts. You might get burned when removing this panel.</p>	<p>PRECAUCIÓN</p> <p>Piezas de alta temperatura. Al retirar este panel podría quemarse.</p>
	<p>CAUTION</p> <p>Do not touch the aluminum fins of the unit. Doing so may result in injury.</p>	<p>PRECAUCIÓN</p> <p>No toque las aletas de aluminio del aparato. De lo contrario, podrían producirse lesiones personales.</p>
	<p>CAUTION</p> <p>BURST HAZARD Open the service valves before the operation, otherwise there might be the burst.</p>	<p>PRECAUCIÓN</p> <p>PELIGRO DE ROTURA Abra las válvulas de servicio antes de la operación, de lo contrario podrían producirse roturas.</p>

1 Precauciones de seguridad

El fabricante no se hará responsable de ningún daño producido por no seguir las descripciones de este manual.

ADVERTENCIA

Generalidades

- Antes de empezar a instalar el acondicionador de aire, lea atentamente el manual de instalación y siga sus instrucciones para instalarlo.
- Solo un instalador cualificado o una persona de mantenimiento cualificada tiene permiso para realizar los trabajos de instalación. La instalación incorrecta puede provocar fugas de agua, descargas eléctricas o incendios.
- No utilice ningún refrigerante aparte del que se especifica para complementar o sustituir. De lo contrario, se podría generar una presión anormalmente alta en el ciclo de refrigeración, lo que podría resultar en un fallo o explosión del producto así como en lesiones personales.
- Antes de abrir la rejilla de admisión de la unidad interior o el panel de servicio de la unidad exterior, ponga el disyuntor en la posición OFF. Si no se pone el disyuntor en la posición OFF se puede producir una descarga eléctrica al tomar las piezas interiores. Sólo un instalador cualificado (*1) o una persona de servicio cualificada (*1) tiene permitido retirar la rejilla de admisión de la unidad interior o el panel de servicio de la unidad exterior y hacer el trabajo necesario.
- Antes de realizar la instalación, el mantenimiento, la reparación o la desinstalación, coloque el disyuntor en la posición de apagado (OFF). De lo contrario se pueden producir descargas eléctricas.
- Ponga un aviso que diga "Trabajo en curso" cerca del disyuntor mientras se realiza el trabajo de instalación, mantenimiento, reparación o desecho. Si el disyuntor se pone en ON por error existe el peligro de que se produzcan descargas eléctricas.
- Sólo un instalador cualificado (*1) o una persona de servicio cualificada (*1) tiene permiso para realizar trabajos en lugares altos usando una base de 50 cm o más o para quitar la rejilla de admisión de la unidad interior para realizar otros trabajos.
- Póngase guantes de protección y ropa de trabajo segura durante la instalación, reparación y desecho.
- No toque las aletas de aluminio del aparato. Si lo hace puede lesionarse usted mismo. Si la aleta tiene que tocarse por alguna razón, póngase primero guantes de protección y ropa de trabajo segura, y luego empiece a trabajar.

- Cuando el trabajo se efectúe en lugares altos, use una escalera que cumpla con la norma ISO 14122, y siga las instrucciones de la escalera. Póngase también un casco de uso industrial como equipo de protección para hacer el trabajo.
- Antes de limpiar el filtro u otras partes de la unidad exterior, desconecte sin falta el disyuntor y ponga un aviso que diga “Trabajo en curso” cerca del mismo mientras se realiza el trabajo.
- Cuando trabaje en un lugar alto, antes de empezar a trabajar, ponga un aviso para que nadie se acerque al lugar de trabajo. Desde la parte superior podrían caer piezas y otros objetos que causarían lesiones a las personas situadas debajo. Mientras lleve a cabo el trabajo, póngase un casco para protegerse de los objetos que pudieran caer.
- El refrigerante usado por este aparato de aire acondicionado es el R32.
- El aparato de aire acondicionado deberá transportarse de forma que esté estable. Si alguna pieza del producto estuviera rota, póngase en contacto con el distribuidor.
- Cuando el aparato de aire acondicionado se deba transportar a mano, deben moverlo dos o más personas.
- El servicio debe ser realizado únicamente según lo recomendado por el fabricante. No mueva ni repare ninguna unidad usted mismo. La unidad contiene alto voltaje en su interior. Podría recibir una descarga eléctrica al retirar la cubierta y la unidad principal.
- El uso de este aparato está destinado a personal especializado o a usuarios con formación para tiendas e industria ligera, o a un uso comercial para el público en general.

Selección del lugar de instalación

- Si se instala el acondicionador de aire en una habitación pequeña, tome las medidas necesarias para asegurar que la concentración de refrigerante en la habitación no supere niveles perjudiciales en el caso de que se produzca una fuga.
- No instale el producto en lugares donde puedan existir fugas de gases inflamables. Si existiera una fuga y se acumulara gas alrededor de la unidad, podría encenderse y provocar un incendio.
- Cuando transporte el aparato de aire acondicionado, póngase zapatos con protección adicional en las punteras.
- Cuando transporte el aparato de aire acondicionado, no lo tome por las bandas de alrededor del cartón de embalaje. Usted podría lesionarse si se rompieran las bandas.
- Instale la unidad interior a 2,5 m como mínimo por encima del nivel del suelo, ya que de lo contrario los usuarios podrían lesionarse o recibir descargas eléctricas si meten sus dedos u otros objetos en la unidad interior mientras funciona el aparato de aire acondicionado.

- No ponga ningún aparato de combustión en un lugar expuesto directamente al aire procedente del aparato de aire acondicionado, de lo contrario, la combustión no sería perfecta.
- El aparato y las tuberías deben ser instalados, operados y almacenados en una habitación con más de A_{\min} m² de suelo.
Cómo lograr A_{\min} m²: $A_{\min} = (M / (2,5 \times 0,22759 \times h_0))^2$
M es la cantidad de carga de refrigerante en el aparato en **kg**;
 h_0 es la altura de instalación del aparato en **m**:
0,6 m para la instalación en suelo/1,8 m para la instalación en pared/1,0 m para la instalación en ventana/2,2 m para la instalación en techo.
Para obtener más información, consulte el Manual de instalación de la unidad exterior.

Instalación

- Cuando la unidad interior vaya a instalarse suspendida deberán usarse los pernos para colgar (M10 ó W3/8) y las tuercas (M10 ó W3/8) que han sido designados.
- Instale de forma segura el aparato de aire acondicionado, sobre una base que pueda soportar adecuadamente su peso. Si la resistencia no es suficiente, la unidad puede caerse y causar lesiones.
- Siga las instrucciones del manual de instalación para instalar el aparato de aire acondicionado. Si no se cumplen estas instrucciones, el producto podría caerse o volcarse, así como producir ruido, vibraciones, fugas de agua u otras complicaciones.
- Lleve a cabo los trabajos de instalación especificados para proteger el aparato frente a la posibilidad de fuertes vientos y terremotos. Si el aparato de aire acondicionado no está instalado de forma apropiada, una unidad podría caerse o volcarse, lo que causaría un accidente.
- Si se producen fugas de gas refrigerante durante la instalación, ventile inmediatamente la habitación. Si el gas refrigerante liberado durante la fuga entrara en contacto con el fuego, pueden generarse gases tóxicos.
- Utilice una carretilla elevadora para mover las unidades de aire acondicionado y un cabestrante o una grúa para instalarlas.

Tubería del refrigerante

- Instale firmemente el tubo del refrigerante durante los trabajos de instalación antes de poner en funcionamiento el aparato de aire acondicionado. Si el compresor funciona con su válvula abierta y sin tubo de refrigerante, el compresor succionará aire y los ciclos de refrigeración tendrán una presión excesiva, lo que puede causar lesiones.
- Apriete la tuerca abocinada con una llave de ajuste dinamométrica como se indica. Un apriete excesivo de tuerca abocinada puede causar grietas en la misma después de pasar mucho tiempo, lo que podría causar fugas de refrigerante.

- Tras la instalación, asegúrese de que no existen fugas de gas refrigerante. Si se produce una fuga de gas refrigerante en la habitación y hay una fuente de fuego próxima, como una cocina, podría generarse gas nocivo.
- Cuando el aparato de aire acondicionado haya sido instalado o recolocado, siga las instrucciones del manual de instalación y purgue completamente el aire para que no se mezclen otros gases que no sean el refrigerante en el ciclo de refrigeración. Si el aire no se purga completamente puede que el aparato de aire acondicionado funcione mal.
- Para la prueba de hermeticidad al aire deberá usarse nitrógeno.
- La manguera de carga deberá conectarse de forma que no esté floja.

Cableado eléctrico

- Sólo un instalador cualificado (*1) o una persona de servicio cualificada (*1) tiene permitido realizar el trabajo eléctrico del aparato de aire acondicionado. Este trabajo no deberá hacerlo, bajo ninguna circunstancia, un individuo que no esté cualificado, porque si el trabajo se hace mal, existe el peligro de que se produzcan descargas eléctricas y/o fugas eléctricas.
- Para conectar los cables eléctricos, reparar los componentes eléctricos o realizar otros trabajos con equipos eléctricos, póngase guantes y ropa para protegerse de las descargas eléctricas, así como zapatos aislantes. Si no se pone este equipo de protección puede recibir descargas eléctricas.
- Use cables que cumplan con las especificaciones del manual de instalación y las estipulaciones de las normas y leyes locales. El uso de cables que no cumplen con las especificaciones puede dar origen a descargas eléctricas, fugas eléctricas, humo y/o incendios.
- Conecte el cable de tierra. (Masa)
Una conexión a tierra incompleta provocará descargas eléctricas.
- No conecte los cables de tierra a tubos de gas o agua, a pararrayos ni a cables de tierra para cables telefónicos.
- Después de completar el trabajo de reparación y recolocación, verifique que los cables de tierra estén bien conectados.
- Instale un disyuntor que cumpla con las especificaciones del manual de instalación y con las estipulaciones de las normas y las leyes locales.
- Instale el disyuntor donde el agente pueda tener acceso a él fácilmente.
- Cuando instale el disyuntor en el exterior, instale uno diseñado para ser usado en exteriores.

- Bajo ninguna circunstancia se deben conectar el cable del suministro de alimentación o el cable de conexión interior y exterior por el medio (conexión mediante un terminal sin soldadura, etc.)
Los problemas de conexión en lugares donde el cable se conecta por el medio podrían generar humo y/o un incendio.
- El cableado eléctrico deberá realizarse de conformidad con la legislación local vigente y el Manual de instalación.
No se ser así, podría producirse una electrocución o un cortocircuito.

Prueba de funcionamiento

- Antes de utilizar el aparato de aire acondicionado después de completar el trabajo de instalación, verifique que las cubiertas de los cuadros eléctricos de la unidad interior y del panel de servicio de la unidad exterior estén cerradas, y ponga el disyuntor en la posición ON. Si conecta la alimentación sin realizar primero estas verificaciones puede recibir una descarga eléctrica.
- Si surge cualquier problema (por ejemplo, si aparece un código de comprobación en la pantalla, huele a quemado, se producen sonidos anormales, la unidad no enfría o no calienta o se produce una fuga de agua) con la unidad de aire acondicionado, no la toque usted mismo; coloque el disyuntor en la posición de apagado (OFF) y póngase en contacto con personal de servicio cualificado. Tome medidas (poniendo un aviso de “fuera de servicio” cerca del disyuntor, por ejemplo) para asegurar que la alimentación no se conecte antes de que llegue la persona de servicio cualificada. Si se continúa utilizando la unidad de aire acondicionado con la anomalía, los problemas mecánicos podrían generar otras complicaciones o provocar descargas eléctricas u otro tipo de problemas.
- Después de terminar el trabajo, utilice el verificador de aislamiento (megóhmetro de 500 V) para verificar que la resistencia sea de 1 MΩ o más entre la sección de carga y la sección de metal de no carga (sección de tierra). Si el valor de la resistencia es bajo, esto se debe a un fallo como, por ejemplo, una fuga o una descarga eléctrica en el lado del usuario.
- Al completar el trabajo de instalación, verifique que no haya fugas de refrigerante, y también la resistencia del aislamiento y el drenaje de agua. Luego haga una prueba de funcionamiento para verificar si el aparato de aire acondicionado funciona correctamente.

Explicaciones para dar al usuario

- Al finalizar el trabajo de instalación dígame al usuario dónde está situado el disyuntor. Si el usuario no sabe dónde está el disyuntor, él o ella no podrán desconectar la alimentación en el caso de que se produzca un fallo en el aparato de aire acondicionado.
- Después de hacer el trabajo de instalación, siga las indicaciones del manual del propietario para explicar al cliente cómo usar y mantener la unidad.

Recolocación

- Sólo un instalador cualificado (*1) o una persona de servicio cualificada (*1) tiene permiso para recolocar el aparato de aire acondicionado. Es peligroso para el aparato de aire acondicionado que sea recolocado por un individuo no cualificado, porque se puede producir un incendio, descargas eléctricas, lesiones, fugas de agua, ruido y/o vibración.
- Cuando realice trabajos de bombeo de vacío, cierre el compresor antes de desconectar el tubo del refrigerante. Si se desconecta el tubo de refrigerante con la válvula de mantenimiento abierta y el compresor aún en marcha, se aspirará aire u otro gas, elevando la presión dentro del ciclo de refrigeración a niveles anómalamente altos, lo que podrá provocar roturas, lesiones u otros problemas.

(*1) Consulte la "Definición de instalador cualificado o persona de servicio cualificada".

PRECAUCIÓN

Este aparato de aire acondicionado incorpora el refrigerante HFC (R32) respetuoso con la capa de ozono.

- Puesto que el refrigerante R32 se ve afectado fácilmente por impurezas tales como la humedad, películas de óxido, aceite, etc., debido a la alta presión, tenga cuidado para no permitir que la humedad, la suciedad, el refrigerante existente, el aceite de la máquina de refrigeración, etc., se mezclen en el ciclo de refrigeración durante las tareas de instalación.
- Se necesita una herramienta especial para el refrigerante R32 para la instalación.
- Use materiales de tubería nuevos y limpios para la tubería de conexión de modo que la humedad y la suciedad no se mezclen durante las tareas de instalación.
- Al usar las tuberías existentes, siga el manual de instalación adjunto con la unidad exterior.

Obrigado por ter adquirido este ar condicionado da Toshiba.

Por favor, leia cuidadosamente estas instruções que contêm informações importantes em conformidade com a "Diretiva da Maquinaria 2006/42/CE", e certifique-se de que as compreende.

Depois de concluir o trabalho de instalação, entregue este Manual de Instalação e o Manual do Proprietário fornecido ao utilizador, e peça ao utilizador para guardá-los num lugar seguro para futuras consultas.

Denominação genérica: Ar condicionado

Definição de instalador qualificado ou de técnico de assistência qualificado

O ar condicionado deve ser instalado, mantido, reparado e eliminado por um instalador qualificado ou um técnico de assistência qualificado. Quando for necessário efetuar qualquer um destes trabalhos, peça a um instalador qualificado ou a um técnico de assistência qualificado para os efetuar.

Um instalador qualificado ou um técnico de assistência qualificado é um agente com as qualificações e os conhecimentos descritos na tabela abaixo.

Agente	Qualificações e conhecimentos necessários do agente
Instalador qualificado (*1)	<ul style="list-style-type: none"> O instalador qualificado é uma pessoa que instala, dá manutenção a, muda de lugar e remove os ares condicionados fabricados pela Toshiba Carrier Corporation. Esta pessoa deve ter formação para instalar, dar manutenção a, mudar de lugar e remover sistemas de ar condicionado fabricados pela Toshiba Carrier Corporation ou, como alternativa, deve ter sido instruída nessas operações por parte de indivíduos com a formação devida e, portanto, que adquiriram todo o conhecimento relacionado com estas operações. O instalador qualificado que tem permissão para levar a cabo as ligações eléctricas envolvidas na instalação, deslocação e remoção tem as qualificações necessárias para realizar essas tarefas conforme estipulado pelas leis e regulamentos locais, sendo uma pessoa que fez formação nas matérias relacionadas com trabalho eléctrico nos sistemas de ar condicionado fabricados pela Toshiba Carrier Corporation ou, como alternativa, que foi instruída nessas matérias por parte de indivíduos com a formação devida e, portanto, que adquiriram todo o conhecimento relacionado com este trabalho. O instalador qualificado que tem permissão para realizar as tarefas de manuseamento do refrigerante e de instalação das tubagens envolvidas na instalação, deslocação e remoção dos aparelhos tem as qualificações necessárias para o manuseamento do refrigerante e a instalação das tubagens conforme estipulado pelas leis e regulamentos locais, sendo uma pessoa que fez formação nas matérias relacionadas com o manuseamento de refrigerante e a instalação de tubagens nos sistemas de ar condicionado fabricados pela Toshiba Carrier Corporation ou, como alternativa, que foi instruída nessas matérias por parte de indivíduos com a formação devida e, portanto, que adquiriram todo o conhecimento relacionado com estas tarefas. O instalador qualificado, a quem é permitido trabalhar em altura, foi formado em matérias relacionadas com o trabalho em altura com sistemas de ar condicionado fabricados pela Toshiba Carrier Corporation ou, como alternativa, foi instruído nessas matérias por indivíduos com a formação devida e, portanto, que adquiriram todo o conhecimento relacionado com este trabalho.
Técnico de assistência qualificado (*1)	<ul style="list-style-type: none"> O técnico de assistência qualificado é uma pessoa que instala, repara, dá manutenção a, muda de lugar e remove os sistemas de ar condicionado fabricados pela Toshiba Carrier Corporation. Esta pessoa deve ter formação para instalar, reparar, dar manutenção a, mudar de lugar e remover sistemas de ar condicionado fabricados pela Toshiba Carrier Corporation ou, como alternativa, deve ter sido instruída nessas operações por parte de indivíduos com a formação devida e, portanto, que adquiriram todo o conhecimento relacionado com estas operações. O técnico de assistência qualificado que tem permissão para levar a cabo as ligações eléctricas envolvidas na instalação, deslocação e remoção tem as qualificações necessárias para realizar essas tarefas conforme estipulado pelas leis e regulamentos locais, sendo uma pessoa que fez formação nas matérias relacionadas com trabalho eléctrico nos sistemas de ar condicionado fabricados pela Toshiba Carrier Corporation ou, como alternativa, que foi instruída nessas matérias por parte de indivíduos com a formação devida e, portanto, que adquiriram todo o conhecimento relacionado com este trabalho. O técnico de assistência qualificado que tem permissão para realizar as tarefas de manuseamento do refrigerante e de instalação das tubagens envolvidas na instalação, reparação, deslocação e remoção dos aparelhos tem as qualificações necessárias para o manuseamento do refrigerante e a instalação das tubagens conforme estipulado pelas leis e regulamentos locais, sendo uma pessoa que fez formação nas matérias relacionadas com o manuseamento de refrigerante e a instalação de tubagens nos sistemas de ar condicionado fabricados pela Toshiba Carrier Corporation ou, como alternativa, que foi instruída nessas matérias por parte de indivíduos com a formação devida e, portanto, que adquiriram todo o conhecimento relacionado com estas tarefas. O técnico de assistência qualificado, a quem é permitido trabalhar em altura, foi formado em matérias relacionadas com o trabalho em altura com sistemas de ar condicionado fabricados pela Toshiba Carrier Corporation ou, como alternativa, foi instruído nessas matérias por indivíduos com a formação devida e, portanto, que adquiriram todo o conhecimento relacionado com este trabalho.

Definição do equipamento de protecção

Aquando do transporte, instalação, manutenção, reparação ou remoção do ar condicionado, use luvas e vestuário de protecção.



Além do equipamento de protecção normal, use o equipamento de protecção descrito abaixo, se levar a cabo os trabalhos especiais detalhados na tabela abaixo.

É perigoso não usar o equipamento de protecção adequado porque fica mais suscetível a sofrer lesões, queimaduras, choques eléctricos e outros ferimentos.





Trabalho efectuado	Equipamento de protecção usado
Todos os tipos de trabalhos	Luvas de protecção Vestuário de protecção
Trabalho eléctrico	Vestuário que proteja contra choques eléctricos Sapatos isoladores Luvas para proporcionar protecção contra choques eléctricos
Trabalhos em altura (50 cm ou mais)	Capacetes industriais
Transporte de objectos pesados	Sapatos com protecção adicional para os dedos dos pés
Reparação da unidade exterior	Luvas para proteger electricistas

■ Significado dos símbolos exibidos no aparelho de ar condicionado





Estas precauções de segurança descrevem assuntos importantes sobre a segurança para prevenir ferimentos aos utilizadores ou outras pessoas, e danos à propriedade. Leia atentamente este manual depois de compreender bem o conteúdo abaixo (significados das indicações), e certifique-se de seguir as instruções.

Indicação	Significado das indicações
 AVISO	O texto que aparece nestas indicações indica que a não observação das instruções na advertência poderia provocar sérias lesões físicas (*1) ou a morte se o produto for manipulado inadequadamente.
 ATENÇÃO	O texto que aparece nestas indicações indica que a não observação das instruções na advertência poderia provocar lesões ligeiras (*2) ou danos (*3) à propriedade se o produto for manipulado inadequadamente.

*1: Sérias lesões físicas indicam a perda da visão, ferimentos corporais, queimaduras, choque eléctrico, fratura, intoxicação e outras lesões que deixam efeitos secundários e requerem a hospitalização ou tratamento ambulatorial prolongado.
 *2: Lesões ligeiras indicam ferimentos corporais, queimaduras, choque eléctrico e outras lesões que não requerem hospitalização ou tratamento ambulatorial prolongado.
 *3: Danos à propriedade indicam danos causados a prédios, objetos de uso doméstico e bens móveis, gado e animais domésticos.

	AVISO (Risco de incêndio)
	Leia cuidadosamente o MANUAL DO PROPRIETÁRIO antes do funcionamento.
	Os técnicos de assistência devem ler cuidadosamente o MANUAL DO PROPRIETÁRIO e o MANUAL DE INSTALAÇÃO antes da operação.
	Está disponível mais informação no MANUAL DO PROPRIETÁRIO, MANUAL DE INSTALAÇÃO e semelhantes.

Indicações de aviso sobre o ar condicionado

Indicação de aviso	Descrição
 <p>WARNING ELECTRICAL SHOCK HAZARD Disconnect all remote electric power supplies before servicing.</p>	<p>AVISO PERIGO DE CHOQUE ELÉCTRICO Desligue todas as fontes de alimentação eléctrica remotas antes de uma operação de assistência.</p>
 <p>WARNING Moving parts. Do not operate unit with grille removed. Stop the unit before the servicing.</p>	<p>AVISO Peças rotativas. Não utilize a unidade com a grelha retirada. Pare a unidade antes de uma operação de assistência.</p>
 <p>CAUTION High temperature parts. You might get burned when removing this panel.</p>	<p>ATENÇÃO Peças com elevadas temperaturas. Pode queimar-se quando retirar este painel.</p>
 <p>CAUTION Do not touch the aluminum fins of the unit. Doing so may result in injury.</p>	<p>ATENÇÃO Não toque nas barbatanas de alumínio da unidade. Caso contrário, poderá ferir-se.</p>
 <p>CAUTION BURST HAZARD Open the service valves before the operation, otherwise there might be the burst.</p>	<p>ATENÇÃO PERIGO DE EXPLOSÃO Abra as válvulas de serviço antes de utilizar o equipamento, caso contrário, pode ocorrer uma explosão.</p>

1 Precauções de segurança

O fabricante não assumirá nenhuma responsabilidade por danos causados pela não observação das descrições dadas neste manual.

AVISO

Geral

- Antes de instalar o ar condicionado, leia cuidadosamente o Manual de Instalação e siga as instruções fornecidas para instalar o ar condicionado.
- Apenas um instalador qualificado ou um técnico de assistência qualificado pode efectuar o trabalho de instalação. A instalação incorrecta pode provocar fugas de água, choques eléctricos ou incêndio.
- Não utilize um refrigerante diferente do especificado para complementação ou substituição. Caso contrário, uma pressão anormalmente alta pode ser gerada no ciclo de refrigeração, o que pode resultar numa falha ou explosão do produto ou em ferimentos pessoais.
- Antes de abrir a grelha de entrada da unidade interior ou painel de serviço da unidade exterior, coloque o disjuntor eléctrico na posição OFF. A não colocação do disjuntor eléctrico na posição OFF pode provocar choques eléctricos devido ao contacto com as peças internas. Apenas um instalador qualificado (*1) ou um técnico de assistência qualificado (*1) pode retirar a grelha de entrada da unidade interior ou o painel de serviço da unidade exterior e efectuar os trabalhos necessários.
- Antes de efectuar o trabalho de instalação, manutenção, reparação ou de eliminação, coloque o disjuntor eléctrico na posição OFF. Caso contrário, podem ocorrer choques eléctricos.
- Coloque um sinal "Trabalho em progresso" junto ao disjuntor eléctrico durante a realização de trabalhos de instalação, manutenção, reparação ou eliminação. Existe um perigo de choques eléctricos se colocar o disjuntor eléctrico na posição ON por engano.
- Apenas um instalador qualificado (*1) ou um técnico de assistência qualificado (*1) pode efectuar o trabalho em altura com um suporte de 50 cm ou mais, ou retirar a grelha de entrada da unidade interior para efectuar o trabalho.
- Use luvas de protecção e vestuário de trabalho de segurança durante a instalação, a assistência e a eliminação.
- Não toque na barbatana de alumínio da unidade. Pode ferir-se, se o fizer. Se for necessário tocar na palheta por algum motivo, coloque primeiro as luvas de protecção e o vestuário de trabalho de segurança e, em seguida, prossiga.

- Quando trabalhar em altura, utilize uma escada em conformidade com a norma ISO 14122 e efectue o procedimento descrito nas instruções da escada. Use também um capacete industrial como equipamento de protecção para efectuar o trabalho.
- Antes de limpar o filtro ou outras peças da unidade exterior, não se esqueça de colocar o disjuntor eléctrico na posição OFF e um sinal “Trabalho em progresso” junto ao disjuntor eléctrico antes de continuar o trabalho.
- Antes de trabalhar em altura, coloque um sinal no local para que ninguém se aproxime do local de trabalho antes de continuar com o trabalho. As peças e outros objectos podem cair da parte superior, ferindo possivelmente uma pessoa que esteja por baixo. Enquanto realiza o trabalho, utilize um capacete para protecção contra a queda de objectos.
- O refrigerante utilizado por este aparelho de ar condicionado é o R32.
- O aparelho de ar condicionado deve ser transportado numa condição estável. Se encontrar qualquer parte do produto quebrada, contacte o seu revendedor.
- Se o aparelho de ar condicionado tiver que ser transportado manualmente, duas ou mais pessoas devem carregá-lo.
- A manutenção deve ser executada apenas como recomendado pelo fabricante. Não mova ou repare qualquer unidade. Há tensão alta no interior da unidade. Pode sofrer um choque eléctrico quando retirar a tampa e a unidade principal.
- Este aparelho destina-se à utilização por parte de especialistas ou utilizadores com formação em oficinas, em indústria ligeira ou para uso comercial por leigos.

Seleção do local de instalação

- Quando o aparelho de ar condicionado for instalado em um ambiente pequeno, providencie medidas apropriadas para assegurar que a concentração de fuga do refrigerante que possa ocorrer no ambiente não exceda o nível crítico.
- Não instale num local onde gases inflamáveis possam vaziar. Se algum gás vaziar e acumular-se ao redor da unidade, o mesmo pode inflamar e causar um incêndio.
- Para transportar o ar condicionado, use sapatos com protecções adicionais para os dedos dos pés.
- Para transportar o ar condicionado, não segure nas faixas existentes à volta da embalagem de cartão. Pode ferir-se, se as faixas se partirem.
- Instale a unidade interior a pelo menos 2,5 m acima do nível do chão, caso contrário, os utilizadores podem ferir-se ou sofrerem choques eléctricos se tocarem com os dedos ou outros objectos na unidade interior com o ar condicionado em funcionamento.
- Não coloque nenhum aparelho de combustão num local exposto directamente ao vento do ar condicionado, caso contrário, pode provocar uma combustão imperfeita.

- O aparelho e as tubulações devem ser instalados, operados e armazenados em uma sala com uma área de piso superior a $A_{\min} \text{ m}^2$. Como obter $A_{\min} \text{ m}^2$: $A_{\min} = (M / (2,5 \times 0,22759 \times h_0))^2$
M é a quantidade de carga de refrigerante no aparelho em **kg**;
 h_0 é a altura de instalação do aparelho em **m**:
0,6 m para colocação no piso / 1,8 m para montagem na parede / 1,0 m para montagem na janela / 2,2 m para montagem no teto.
Para obter detalhes, consulte o Manual de instalação da unidade exterior.

Instalação

- Quando suspender a unidade interior, tem de utilizar as porcas (M10 ou W3/8) e os parafusos de fixação (M10 ou W3/8).
- Instale o aparelho de ar condicionado firmemente num lugar onde a base possa suportar o peso adequadamente. Se a força não for suficiente, a unidade pode cair e provocar lesões.
- Siga as instruções fornecidas no Manual de Instalação para instalar o ar condicionado. O incumprimento destas instruções pode provocar a queda do produto ou produzir ruído, vibração, vazamento de água ou outros problemas.
- Realize o trabalho de instalação especificado para a protecção adequada contra a possibilidade de ventos fortes e terremotos. Se o aparelho de ar condicionado não for instalado adequadamente, uma unidade pode tombar ou cair, provocando um acidente.
- Se o gás refrigerante vaziar durante o trabalho de instalação, ventile o ambiente imediatamente. Se o gás refrigerante vazado entrar em contacto com fogo, poderá ser gerado um gás nocivo.
- Utilize uma empilhadora para transportar as unidades do aparelho de ar condicionado e utilize um guincho ou guindaste para sua instalação.

Tubagem do refrigerante

- Instale correctamente o tubo de refrigeração durante a instalação antes de colocar o ar condicionado em funcionamento. Se operar o compressor com a válvula aberta e sem o tubo de refrigerante, o compressor aspira ar e o ciclo de refrigeração é sobrepressurizado, o que poderá provocar uma lesão.
- Aperte a porca de alargamento com uma chave dinamométrica e da forma especificada. O aperto excessivo da porca de alargamento pode provocar uma racha na porca de alargamento após um longo período, que pode resultar na fuga de refrigerante.
- Após o trabalho de instalação, confirme que não haja nenhuma fuga do gás refrigerante. Se houver uma fuga de gás refrigerante para o compartimento que entre em contacto com uma chama, por exemplo, no caso de um fogão, poderá gerar gás tóxico.

- Quando instalar ou mudar o ar condicionado, siga as instruções fornecidas no Manual de Instalação e elimine o ar completamente para que nenhum gás para além do refrigerante seja misturado no ciclo de refrigeração. A não eliminação completa do ar pode provocar uma avaria no ar condicionado.
- Tem de utilizar gás de nitrogénio para o teste de impermeabilidade.
- Tem de ligar o tubo de carga para que não exista nenhuma folga.

Cablagem eléctrica

- Apenas um instalador qualificado (*1) ou um técnico de assistência qualificado (*1) pode efectuar o trabalho eléctrico do ar condicionado. Este trabalho não deve ser efectuado por uma pessoa não qualificada em nenhuma circunstância porque um trabalho executado incorrectamente pode resultar em choques eléctricos e/ou fugas eléctricas.
- Para ligar os fios eléctricos, reparar peças eléctricas ou efectuar outros trabalhos eléctricos, utilize luvas para proteger os electricistas, sapatos isoladores e vestuário para proteger contra choques eléctricos. A não utilização deste equipamento de protecção pode resultar em choques eléctricos.
- Utilize cablagens que cumpram as especificações fornecidas no Manual de Instalação e as condições nas leis e regulamentos locais. A utilização de cablagens que não cumpram as especificações pode originar choques eléctricos, fugas eléctricas, fumo e/ou um incêndio.
- Conecte o cabo de terra. (fio de terra)
Uma ligação à terra incompleta pode causar choque eléctrico.
- Não conecte os cabos de terra a tubos de gás, tubos de água, pára-raios ou fios de terra de telefone.
- Depois de concluir o trabalho de reparação ou mudança, verifique se os fios de terra estão ligados correctamente.
- Instale um disjuntor eléctrico que cumpra as especificações fornecidas no manual de instalação e as condições nas leis e regulamentos locais.
- Instale o disjuntor eléctrico num local de fácil acesso ao agente.
- Quando instalar um disjuntor eléctrico no exterior, instale um disjuntor concebido para utilizar no exterior.
- O cabo de fornecimento de energia ou o cabo de conexão da unidade interior e exterior não devem ser conectados no meio sob nenhuma circunstância (Conexão usando um terminal sem solda etc.)
O problema da ligação em locais em que o cabo é conectado no meio pode originar fumo e/ou um incêndio.

- O trabalho de ligação de cabos e fios eléctricos deve ser feito em conformidade com as leis e regulamentos da comunidade em questão e com o manual de instalação.
Se assim não for, o resultado pode ser electrocussão ou curto-circuito.

Teste de funcionamento

- Antes de utilizar o ar condicionado após a conclusão do trabalho, verifique se a tampa da caixa de controlo eléctrico da unidade interior e o painel de serviço da unidade exterior estão fechados e, em seguida, coloque o disjuntor de circuito na posição ON. Pode sofrer um choque eléctrico se ligar a corrente eléctrica sem efectuar primeiro estas verificações.
- Quando detetar algum tipo de problema (como, por exemplo, quando aparecer uma indicação de erro, cheiro a queimado, sons anormais, o ar condicionado não arrefecer ou aquecer, ou existir uma fuga de água) no aparelho de ar condicionado, não toque no ar condicionado, mas coloque o disjuntor eléctrico na posição desligada (OFF) e contacte um técnico de assistência qualificado. Tome as medidas necessárias para garantir que a corrente eléctrica não será ligada (através da colocação do aviso “fora de serviço” junto ao disjuntor de serviço, por exemplo) até chegar o técnico de assistência qualificado. Se continuar a utilizar o ar condicionado com problemas, pode aumentar a ocorrência de problemas mecânicos e provocar choques eléctricos ou outros problemas.
- Depois de terminar o trabalho, certifique-se de que utiliza um aparelho de verificação do isolamento (megaohmímetro de 500 V) para verificar se a resistência é 1 M Ω ou mais entre a secção de carga e a secção metálica sem carga (Secção de ligação à terra). Se o valor da resistência for baixo, ocorre uma fuga ou um choque eléctrico no lado do utilizador.
- Depois de concluir o trabalho de instalação, verifique se existem fugas de refrigerante, a resistência do isolamento e a drenagem de água. Realize um teste para verificar se o ar condicionado está a funcionar correctamente.

Explicações fornecidas ao utilizador

- Depois de concluir o trabalho de instalação, indique o local de instalação do disjuntor eléctrico ao utilizador. Se o utilizador não souber a localização do disjuntor eléctrico, não será capaz de o desligar no caso de ocorrer um problema no ar condicionado.
- Depois de concluir o trabalho de instalação, utilize o Manual do Proprietário para explicar ao cliente como utilizar e manter a unidade.

Mudança

- Apenas um instalador qualificado (*1) ou um técnico de assistência qualificado (*1) pode mudar o ar condicionado. É perigoso o ar condicionado ser mudado por uma pessoa não qualificada porque pode ocorrer um incêndio, choques eléctricos, lesões, fugas de água, ruídos e/ou vibrações.
- Quando efectuar o trabalho de bombagem, encerre o compressor antes de desligar o tubo de refrigerante. Se desconectar o tubo do refrigerante com a válvula de serviço ainda aberta e o compressor ainda em funcionamento, faz com que o ar ou outros gases sejam aspirados, aumentando a pressão interna do ciclo de refrigeração para um nível anormalmente elevado, podendo causar a ruptura, lesões ou outros problemas.

(*1) Consulte “Definição de instalador qualificado ou de técnico de assistência qualificado”.

ATENÇÃO

Este ar condicionado adotou um refrigerante HFC (R32) que não destrói a camada de ozono.

- Como o refrigerante R32 é facilmente afetado por impurezas, como humidade, película oxidada, óleo, etc., devido à alta pressão, tenha cuidado para não permitir que humidade, sujidade, refrigerante existente, óleo da máquina de refrigeração, etc. se misturem no ciclo de refrigeração durante o trabalho de instalação.
- É necessária uma ferramenta especial para o líquido refrigerante R32 para a instalação.
- Use materiais de tubulação para o tubo de conexão novos e limpos, de modo que a humidade e sujidade não se misturem durante o trabalho de instalação.
- Quando usar tubos existentes, siga o manual de instalação fornecido com a unidade exterior.

Hartelijk dank voor uw aankoop van deze Toshiba-airconditioner.

Lees deze instructies aandachtig door, want ze bevatten belangrijke informatie overeenkomstig de vereisten van de "Machinerichtlijn 2006/42/EG", en zorg dat u alles volledig begrijpt.

Geef na het installeren deze installatiehandleiding en de gebruikershandleiding aan de klant en vraag hem/haar de documentatie ter referentie op een veilige plaats te bewaren.

Algemene beschrijving: Airconditioner

Definitie van bevoegd installateur of bevoegd onderhoudsmonteur

De airconditioner moet worden geïnstalleerd, onderhouden, gerepareerd en uiteindelijk weggedaan door een bevoegd installateur of bevoegd onderhoudsmonteur. Wanneer een van deze taken verricht moet worden, verzoekt u dan een bevoegd installateur of bevoegd onderhoudsmonteur om dit te doen.

Een bevoegd installateur of bevoegd onderhoudsmonteur is een persoon die beschikt over de kennis en bevoegdheden die staan vermeld in de onderstaande tabel.

Persoon	Kennis en competenties waarover de persoon moet beschikken
Bevoegd installateur (*1)	<ul style="list-style-type: none"> De bevoegde installateur is een persoon die door Toshiba Carrier Corporation gemaakte airconditioners installeert, onderhoudt, verplaatst en verwijdert. Hij of zij is opgeleid om door Toshiba Carrier Corporation gemaakte airconditioners te installeren, onderhouden, verplaatsen en verwijderen. Deze persoon kan ook iemand zijn die in dergelijke taken is geïnstrueerd door een persoon of personen die zijn opgeleid en heeft dus voldoende kennis voor deze taken. De bevoegde installateur die bevoegd is om het elektrische gedeelte van de installatie, verplaatsing en verwijdering op zich te nemen beschikt over de kwalificaties voor deze elektrische werkzaamheden zoals voorzien in plaatselijke wetten en regelgeving. Deze persoon is opgeleid voor werkzaamheden aan het elektrische systeem van de airconditioners gemaakt door Toshiba Carrier Corporation. Deze persoon kan ook iemand zijn die in dergelijke taken is geïnstrueerd door een persoon of personen die zijn opgeleid en heeft dus voldoende kennis voor dit soort werk. De bevoegde installateur die bevoegd is om het koel- en leidingenwerk van de installatie, verplaatsing en verwijdering op zich te nemen beschikt over de kwalificaties voor deze koel- en leidingenwerkzaamheden zoals voorzien in plaatselijke wetten en regelgeving. Deze persoon is opgeleid voor koel- en leidingenwerkzaamheden aan de airconditioners gemaakt door Toshiba Carrier Corporation. Deze persoon kan ook iemand zijn die in dergelijke taken is geïnstrueerd door een persoon of personen die zijn opgeleid en heeft dus voldoende kennis voor dit soort werk. De bevoegde installateur die bevoegd is om op hoogte te werken is opgeleid om op hoogten te werken met airconditioners gemaakt door Toshiba Carrier Corporation. Deze persoon kan ook iemand zijn die in dergelijke taken is geïnstrueerd door een persoon of personen die zijn opgeleid en heeft dus voldoende kennis voor dit soort werk.
Bevoegd onderhouds-monteur (*1)	<ul style="list-style-type: none"> De bevoegde onderhoudsmonteur is een persoon die door Toshiba Carrier Corporation gemaakte airconditioners installeert, repareert, onderhoudt, verplaatst en verwijdert. Hij of zij is opgeleid om door Toshiba Carrier Corporation gemaakte airconditioners te installeren, repareren, onderhouden, verplaatsen en verwijderen. Deze persoon kan ook iemand zijn die in dergelijke taken is geïnstrueerd door een persoon of personen die zijn opgeleid en heeft dus voldoende kennis voor deze taken. De bevoegde onderhoudsmonteur die bevoegd is om het elektrische gedeelte van de installatie, reparatie, verplaatsing en verwijdering op zich te nemen beschikt over de kwalificaties voor deze elektrische werkzaamheden zoals voorzien in plaatselijke wetten en regelgeving. Deze persoon is opgeleid voor werkzaamheden aan het elektrische systeem van de airconditioners gemaakt door Toshiba Carrier Corporation. Deze persoon kan ook iemand zijn die in dergelijke taken is geïnstrueerd door een persoon of personen die zijn opgeleid en heeft dus voldoende kennis voor dit soort werk. De bevoegde onderhoudsmonteur die bevoegd is om het koel- en leidingenwerk van de installatie, reparatie, verplaatsing en verwijdering op zich te nemen beschikt over de kwalificaties voor deze koel- en leidingenwerkzaamheden zoals voorzien in plaatselijke wetten en regelgeving. Deze persoon is opgeleid voor koel- en leidingenwerkzaamheden aan de airconditioners gemaakt door Toshiba Carrier Corporation. Deze persoon kan ook iemand zijn die in dergelijke taken is geïnstrueerd door een persoon of personen die zijn opgeleid en heeft dus voldoende kennis voor dit soort werk. De bevoegde onderhoudsmonteur die bevoegd is om op hoogte te werken is opgeleid om op hoogten te werken met airconditioners gemaakt door Toshiba Carrier Corporation. Deze persoon kan ook iemand zijn die in dergelijke taken is geïnstrueerd door een persoon of personen die zijn opgeleid en heeft dus voldoende kennis voor dit soort werk.

Definitie van beschermende kleding

Wanneer de airconditioner wordt vervoerd, geïnstalleerd, onderhouden, gerepareerd of verwijderd, draag beschermende handschoenen en veiligheidswerkleding.



Draag naast dergelijke normale beschermende kleding de hieronder beschreven beschermende uitrusting bij het uitvoeren van speciale taken zoals aangegeven in onderstaande tabel.

Niet dragen van de juiste beschermende uitrusting is gevaarlijk, omdat u dan meer blootstaat aan letsel, brandwonden, elektrische schokken en andere verwondingen.

Te verrichten werkzaamheden	Beschermende kleding
Alle soorten werk	Werkhandschoenen Veiligheidswerkleding
Elektrische werkzaamheden	Beschermende kleding tegen elektrische schokken Isolerende schoenen Beschermende handschoenen tegen elektrische schokken
Werk uitgevoerd op hoogte (50 cm of meer)	Veiligheidshelm voor industrieel gebruik
Vervoer van zware voorwerpen	Schoenen met verstevigde neuzen
Reparatie van buiteneenheden	Handschoenen die bescherming bieden tegen elektriciteit

■ Betekenis van symbolen weergegeven op de airconditioner





Deze veiligheidsvoorzorgen geven belangrijke informatie over de veiligheid en het voorkomen van lichamelijk letsel van u en andere personen en het voorkomen van beschadiging van eigendommen. Lees deze handleiding goed door nadat u de volgende aanwijzingen (betekenis van aanduidingen) heeft gelezen en begrepen en volg de aanwijzingen beslist op.

Aanduiding	Betekenis van aanduidingen
 WAARSCHUWING	De op deze wijze beschreven aanwijzingen geven aan dat het niet opvolgen van de waarschuwing kan leiden tot ernstig lichamelijk letsel (*1) met mogelijk dodelijke afloop indien het apparaat onjuist wordt gebruikt.
 VOORZICHTIG	De op deze wijze beschreven aanwijzingen geven aan dat het niet opvolgen van de voorzorgen kan leiden tot licht lichamelijk letsel (*2) of beschadiging (*3) van eigendommen indien het apparaat onjuist wordt gebruikt.

- *1: Ernstig lichamelijk letsel staat voor gezichtsverlies, verwondingen, brandwonden, elektrische schokken, botbreuken, vergiftiging en ander letsel met blijvende gevolgen waarvoor ziekenhuisbehandeling of langdurige ambulante behandeling vereist is.
*2: Licht lichamelijk letsel staat voor verwondingen, brandwonden, elektrische schokken en ander letsel waarvoor geen ziekenhuisbehandeling of langdurige ambulante behandeling vereist is.
*3: Beschadiging van eigendommen staat voor schade aan gebouwen, huishoudelijke goederen, en verwonding van vee en huisdieren.

	WAARSCHUWING (Brandgevaar)
	Lees de GEBRUIKERSHANDLEIDING zorgvuldig voordat u de apparatuur bedient.
	Servicepersoneel moet voor gebruik aandachtig de GEBRUIKERSHANDLEIDING en INSTALLATIEHANDLEIDING lezen.
	Verdere informatie vindt u in de GEBRUIKERSHANDLEIDING, INSTALLATIEHANDLEIDING, enz.

Waarschuwingsaanduidingen op de airconditioner

Waarschuwingsaanduiding	Beschrijving
 <p>WARNING ELECTRICAL SHOCK HAZARD Disconnect all remote electric power supplies before servicing.</p>	<p>WAARSCHUWING GEVAAR VOOR ELEKTRISCHE SCHOK Verbreek alle externe stroomvoorzieningsaansluitingen alvorens enig onderhoud te verrichten.</p>
 <p>WARNING Moving parts. Do not operate unit with grille removed. Stop the unit before the servicing.</p>	<p>WAARSCHUWING Bewegende delen. Schakel het apparaat niet in wanneer het voorrooster is verwijderd. Stop de werking van het apparaat alvorens enig onderhoud te verrichten.</p>
 <p>CAUTION High temperature parts. You might get burned when removing this panel.</p>	<p>VOORZICHTIG Delen met hoge temperaturen. Bij het verwijderen van dit paneel is bestaan de kans dat u zich brandt.</p>
 <p>CAUTION Do not touch the aluminum fins of the unit. Doing so may result in injury.</p>	<p>VOORZICHTIG De aluminium vinnen van de unit niet aanraken. Dat zou tot ernstige verwondingen kunnen leiden.</p>
 <p>CAUTION BURST HAZARD Open the service valves before the operation, otherwise there might be the burst.</p>	<p>VOORZICHTIG GEVAAR VOOR UITBARSTING Open voor enige ingreep eerst de veiligheidskleppen, anders kan er een uitbarsting volgen.</p>

1 Voorzorgen voor de veiligheid

De fabrikant is niet aansprakelijk voor schade ten gevolge van het niet opvolgen van aanwijzingen in deze handleiding.

WAARSCHUWING

Algemeen

- Alvorens u begint met het installeren van de airconditioner, moet u de installatiehandleiding aandachtig doorlezen. Volg beslist alle gegeven aanwijzingen voor het installeren van de airconditioner op.
- Het installeren mag alleen door een gekwalificeerde installateur of onderhoudsmonteur worden uitgevoerd. Een foute installatie resulteert mogelijk in waterlekkage, elektrische schokken of brand.
- Gebruik voor het bijvullen of vervangen geen ander koelmiddel dan het gespecificeerde middel. Er wordt anders namelijk mogelijk abnormale hoge druk in de koelcyclus opgebouwd met een onjuiste werking, ontploffing of lichamelijk letsel als gevolg.
- Voordat u het inlaatrooster van de binneneenheid of het onderhoudspaneel van de buiteneenheid opent, zet u eerst de stroomonderbreker in de OFF-stand. Als u verzuimt de stroomonderbreker in de OFF-stand te zetten, loopt u de kans op een elektrische schok bij aanraken van de inwendige onderdelen. Alleen een bevoegd installateur (*1) of een bevoegd onderhoudsmonteur (*1) mag het inlaatrooster van de binneneenheid of het onderhoudspaneel van de buitenunit verwijderen en het vereiste werk verrichten.
- Alvorens u begint met installeren, onderhoud, reparaties of het verwijderen, zet u eerst de circuitonderbreker in de OFF-stand. Anders loopt u de kans een elektrische schok te krijgen.
- Plaats een bordje "werk in uitvoering" bij de stroomonderbreker tijdens het installeren, onderhoud, reparatiewerk of werk voor afdanken van het apparaat. Als iemand per vergissing de stroomonderbreker in de ON-stand zet, loopt u de kans een elektrische schok te krijgen.
- Alleen een bevoegd installateur (*1) of een bevoegd onderhoudsmonteur (*1) mag werkzaamheden op hoogte verrichten met een trapje van 50 cm of meer, of het inlaatrooster van de binneneenheid verwijderen om werk te verrichten.
- Draag tijdens het installeren, onderhoud en afdanken van het apparaat altijd werkhandschoenen en veiligheidskleding.
- De aluminium vin van de unit niet aanraken. Anders zou u zich er aan kunnen verwonden. Als het nodig is de koelvin aan te raken, trekt u eerst werkhandschoenen en beschermende kleding aan en begint u dan pas met het werk.

- Gebruik voor het werken op hoogte een ladder die voldoet aan de ISO 14122-norm en volg de aanwijzingen in de handleiding van de ladder. Draag tevens een helm voor industrieel gebruik ter bescherming voordat u aan het werk gaat.
- Voor schoonmaken van het filter of andere onderdelen van de buiteneenheid zet u altijd eerst de stroomonderbreker in de OFF-stand en plaatst u een bordje “werk in uitvoering” bij de stroomonderbreker voordat u aan het werk gaat.
- Bij het werken op hoogte dient u voordat u start een waarschuwbord te plaatsen zodat niemand uw werkplek te dicht nadert. Anders zouden voorbijgangers gewond kunnen raken door vallende onderdelen en andere voorwerpen. Draag tijdens het uitvoeren een helm ter bescherming tegen mogelijk vallende onderdelen.
- Het koelmiddel dat wordt gebruikt in deze airconditioner is R32.
- De airconditioner moet stabiel worden getransporteerd. Neem direct contact op met de plaats van aankoop indien onderdelen beschadigd zijn.
- Draag de airconditioner altijd met minimaal 2 personen indien deze met de hand moet worden verplaatst.
- Onderhoud mag uitsluitend worden uitgevoerd zoals aanbevolen door de fabrikant. Verplaats of herstel het apparaat niet zelf. De binnenkant van de unit staat onder hoge spanning. U kunt bij het verwijderen van het deksel en de hoofdunit een elektrische schok krijgen.
- Dit toestel moet worden gebruikt door experts of opgeleide gebruikers in winkels, de lichte industrie of voor commercieel gebruik door leken.

Keuze van de installatieplaats

- Indien de airconditioner in een kleine ruimte wordt geplaatst, neem dan maatregelen om te verzekeren dat lekkend koelmiddel in de ruimte niet de limiet kan overschrijden.
- Installeer niet op plaatsen waar ontvlambaar gas kan lekken. Lekkend gas zou namelijk rond de unit op kunnen hopen, worden ontstoken en brand veroorzaken.
- Bij het vervoeren van de airconditioner dient u schoeisel met verstevigde neuzen te dragen.
- Bij het vervoeren van de airconditioner mag u die niet optillen aan de banden rond de verpakkingendoos. Als de banden zouden breken, loopt u de kans op verwondingen.
- Installeer de binneneenheid tenminste 2,5 m boven de vloer, anders zouden gebruikers letsel of een elektrische schok kunnen oplopen als ze hun vingers of iets anders in de binneneenheid steken terwijl de airconditioner werkt.

- Zet geen verbrandingsapparaat op een plaats waar het in de directe luchtstroom van de airconditioner staat, anders kan er onvolledige verbranding plaatsvinden.
- Toestel en leidingwerk moeten worden geïnstalleerd, bediend en opgeslagen in een ruimte met een vloeroppervlak groter dan $A_{\min} \text{ m}^2$. Hoe verkrijgt u $A_{\min} \text{ m}^2$: $A_{\min} = (M/(2,5 \times 0,22759 \times h_0))^2$
M is de ladingshoeveelheid van het koelmiddel in het apparaat in **kg**;
 h_0 is de installatiehoogte van het apparaat in **m**:
0,6 m voor vloerstaand/1,8 m voor wandmontage/1,0 m voor raammontage/2,2 m voor plafondmontage.
Voor meer informatie, zie de installatiehandleiding van de buitenunit.

Installeren

- Wanneer de binneneenheid moet worden opgehangen, gebruikt u de daarvoor bestemde ophangbouten (M10 of W3/8) en moeren (M10 of W3/8).
- Installeer de airconditioner goed op een plaats die stevig genoeg voor het gewicht van de unit is. Als het ophangpunt niet stevig genoeg is, kan het apparaat vallen, hetgeen letsel kan veroorzaken.
- Bij het installeren van de airconditioner volgt u de aanwijzingen in de installatiehandleiding. De unit zou kunnen vallen, kantelen of extra ruis, trillingen, waterlekage en andere problemen veroorzaken indien u deze aanwijzingen niet opvolgt.
- Voer de vereiste installatie-werkzaamheden uit ter bescherming tegen wind, storm en aardbevingen. De airconditioner kan vallen en ernstige ongelukken veroorzaken indien deze fout is geïnstalleerd.
- Ventileer de ruimte direct indien er tijdens het installeren koelmiddel lekt. Indien lekkend koelmiddel in contact met vuur komt, komt mogelijk giftig gas vrij.
- Gebruik een vorkheftruck voor het verplaatsen van de airconditioner-units en een takel of dergelijk geschikt voorwerp voor het installeren.

Koelmiddelleiding

- Monteer tijdens de installatiewerkzaamheden de koelmiddelleiding nauwkeurig voordat de airconditioner wordt bediend. Als de compressor wordt bediend met de klep open en zonder koelmiddelbuis, zuigt de compressor lucht aan en ontstaat er overdruk in het koelsysteem, hetgeen kan leiden tot verwondingen.
- Draai de flensmoer met een momentsleutel aan op de voorgeschreven manier. Als de flensmoer al te krachtig wordt aangedraaid, kan de moer een tijd later barsten, waardoor koelmiddel kan gaan lekken.

- Controleer na het installeren dat er geen koelmiddel lekt. Wanneer ontsnapt gasvormig koelmiddel in de buurt of in contact komt met open vuur, zoals bij een gasfornuis, kunnen giftige gassen worden gevormd.
- Na het installeren of verplaatsen van de airconditioner volgt u de aanwijzingen in de installatiehandleiding voor het volledig ontluichten van de leidingen, zodat er in het koelsysteem geen ander gas overblijft dan alleen het koelmiddel. Bij onvolledig ontluichten kan de airconditioner niet goed functioneren.
- Gebruik stikstofgas voor de test op luchtdichtheid.
- De oplaadslang moet zo worden aangesloten dat deze niet slap hangt.

Elektrische bedrading

- Alleen een bevoegd installateur (*1) of een bevoegd onderhoudsmonteur (*1) mag elektrische werkzaamheden aan de airconditioner verrichten. Onder geen voorwaarde mag dit werk worden verricht door een onbevoegde, aangezien fouten of vergissingen kunnen leiden tot elektrische schokken en/of kortsluiting of lekstroom.
- Bij het aansluiten van de stroomdraden, het repareren van elektrische onderdelen of het verrichten van andere elektrische werkzaamheden dient u handschoenen te dragen ter bescherming tegen elektrische stroom en isolerend schoeisel en kleding die bescherming biedt tegen elektrische schokken. Als u dergelijke beschermende kleding niet draagt, loopt u de kans op elektrische schokken.
- Gebruik bedrading die voldoet aan de specificaties in de installatiehandleiding en de ter plaatse geldende voorschriften en wetten. Het gebruik van bedrading die niet voldoet aan de specificaties kan resulteren in elektrische schokken, kortsluiting en lekstroom, rookontwikkeling en/of brandgevaar.
- Verbind een aardedraad. (aardaansluitingen)
Een onvolledige aarding kan een elektrische schok veroorzaken.
- Sluit aardedraden niet aan op gasleidingen, waterleidingen, bliksemafleiders of aardkabels voor telefoons.
- Na het voltooiën van de verplaatsing of het reparatiewerk dient u te controleren of de aardleidingen naar behoren zijn aangesloten.
- Installeer een stroomonderbreker die voldoet aan de specificaties in de installatiehandleiding en de ter plaatse geldende voorschriften en wetten.
- Installeer de stroomonderbreker op een plaats waar die goed toegankelijk is voor de gebruiker.
- Als u de stroomonderbreker buitenshuis aanbrengt, let dan goed op dat het een specifiek voor buitengebruik geschikt type is.

- In geen geval moet de voedingsdraad of de binnen- en buitenverbindingkabel in het midden worden aangesloten (verbinding met behulp van soldeervrije aansluiting, enz.)
Aansluitprobleem op de plaatsen waar de kabel in het midden is aangesloten, kan tot rookontwikkeling en/of brandgevaar leiden.
- Werkzaamheden met elektrische bedrading moeten altijd worden uitgevoerd in overeenstemming met de plaatselijke regelgeving, wetten en de installatiehandleiding.
Doet u dit niet, dan kan dat leiden tot elektrocutie of kortsluiting.

Testen

- Nadat u de werkzaamheden hebt voltooid dient u voor het inschakelen van de airconditioner eerst te controleren of de afdekking van de elektrabox van de binnenunit en het onderhoudspaneel van de buitenunit zijn gesloten en de circuitonderbreker op ON (in de AAN-stand) is gezet. Als u de stroom inschakelt zonder eerst deze punten te controleren, kunt u een elektrische schok krijgen.
- Indien er iets mis is met de airconditioner (wanneer u een foutmelding ziet of een brandlucht ruikt, vreemde geluiden hoort of wanneer de airconditioner niet koelt of verwarmt, of wanneer er water uit lekt), raak dan de airconditioner niet aan, maar zet de schakelaar in de OFF-stand en neem contact op met een bevoegd onderhoudsmonteur. Neem de nodige maatregelen om te voorkomen dat het apparaat wordt ingeschakeld (schrijf bijvoorbeeld “defect” dichtbij de stroomonderbreker e.d.) totdat de bevoegde onderhoudsmonteur arriveert. Het voortzetten van het gebruik van de airconditioner terwijl er iets mis mee is, kan leiden tot ernstige mechanische defecten, elektrische schokken en andere problemen.
- Nadat het werk is voltooid, dient u met een isolatietester (500 V Megger) te controleren of de weerstand 1 MΩ of meer bedraagt tussen de stroomvoerende delen en het niet-stroomvoerende metalen deel (aardingsdeel). Als de weerstandswaarde te gering is, kan er kortsluiting, lekstroom of een elektrische schok optreden aan de gebruikerskant.
- Na voltooiing van het installatiewerk controleert u of er geen koelmiddel lekt, of de waterafvoer in orde is en controleert u de weerstand van de isolatie. Vervolgens laat u de airconditioner proefdraaien, om te zien of het apparaat goed werkt.

Uitleg aan de gebruiker

- Na voltooiing van het installatiewerk vertelt u de gebruiker waar de stroomonderbreker zich bevindt. Als de gebruiker niet weet waar de stroomonderbreker zit, kan hij of zij de airconditioner niet uitschakelen wanneer er zich een storing voordoet in de werking.
- Na voltooiing van het installatiewerk vertelt u aan de hand van de gebruikershandleiding de gebruiker hoe het apparaat te bedienen en te onderhouden.

Elders opstellen

- Alleen een bevoegd installateur (*1) of een bevoegd onderhoudsmonteur (*1) mag de airconditioner verplaatsen. Het is gevaarlijk als een onbevoegde de airconditioner verplaatst, aangezien dat kan leiden tot gevaar voor brand, elektrische schokken, verwondingen, waterlekage, bijgeluiden en/of trillingen.
- Bij uitvoeren van werkzaamheden wanneer de pomp gestopt is, schakelt u eerst de compressor uit voordat u de koelmiddelbuis losmaakt. Wanneer u de koelmiddelleiding loskoppelt met de onderhoudsklep open en de compressor in bedrijf, wordt lucht en gas opgezogen waardoor de druk binnen de koelcyclus te hoog oploopt, wat mogelijk kan leiden tot barsten, letsel of andere problemen.

(*1) Zie "Definitie van bevoegd installateur of bevoegd onderhoudsmonteur".

VOORZICHTIG

Deze airconditioner werkt met het HFC-koelmiddel (R32) dat de ozonlaag niet aantast.

- Aangezien het R32-koelmiddel gemakkelijk wordt beïnvloed door verontreinigingen zoals vocht, geoxideerde film, olie, enz., vanwege de hoge druk, moet u ervoor zorgen dat vocht, vuil, bestaand koelmiddel, koelmachineolie, enz. niet vermengd raken in de koelcyclus tijdens de installatiewerkzaamheden.
 - Een speciaal gereedschap voor het R32-koelmiddel is vereist voor de installatie.
 - Gebruik nieuw en schoon leidingmateriaal voor de verbindingspijp zodat vocht en vuil tijdens de installatiewerkzaamheden niet met elkaar worden vermengd.
 - Wanneer u bestaande leidingen gebruikt, volg dan de installatiehandleiding die bij de buitenunit is geleverd.
-

Σας ευχαριστούμε για την αγορά του συγκεκριμένου κλιματιστικού της Toshiba.
 Διαβάστε προσεκτικά αυτές τις οδηγίες που περιλαμβάνουν σημαντικές πληροφορίες και συμμορφώνονται προς την «Οδηγία περί μηχανημάτων 2006/42/ΕΚ» και βεβαιωθείτε ότι τις κατανοείτε.
 Μετά την ολοκλήρωση της εργασίας εγκατάστασης, παραδώστε το παρόν Εγχειρίδιο εγκατάστασης και το Εγχειρίδιο κατόχου στον χρήστη και υποδείξτε του να το φυλάξει σε ασφαλές σημείο για όποτε το χρειαστεί στο μέλλον.

Γενική ονομασία: Κλιματιστικό

Ορισμός ειδικευμένου εγκαταστάτη ή ειδικευμένου τεχνικού σέρβις

Απαιτείται εγκατάσταση, συντήρηση, επισκευή και απόρριψη του κλιματιστικού από εξειδικευμένο εγκαταστάτη ή εξειδικευμένο τεχνικό σέρβις. Όταν απαιτείται εκτέλεση οποιασδήποτε από τις συγκεκριμένες εργασίες, αναθέστε την εκτέλεσή της σε εξειδικευμένο εγκαταστάτη ή εξειδικευμένο τεχνικό σέρβις.
 Ο ειδικευμένος εγκαταστάτης ή ειδικευμένος τεχνικός σέρβις είναι αντιπρόσωπος ο οποίος διαθέτει τα προσόντα και τις γνώσεις που περιγράφονται στον παρακάτω πίνακα.

Αντιπρόσωπος	Προσόντα και γνώσεις που απαιτείται να διαθέτει ο αντιπρόσωπος
Ειδικευμένος εγκαταστάτης (*1)	<ul style="list-style-type: none"> Ο ειδικευμένος εγκαταστάτης είναι ο τεχνικός που εκτελεί εργασίες εγκατάστασης, συντήρησης, μετεγκατάστασης και αφαίρεσης των κλιματιστικών που κατασκευάζει η Toshiba Carrier Corporation. Έχει καταρτιστεί για την εγκατάσταση, τη συντήρηση, τη μετεγκατάσταση και την αφαίρεση των κλιματιστικών που κατασκευάζει η Toshiba Carrier Corporation ή, εναλλακτικά, του έχουν δοθεί οι ανάλογες οδηγίες από ειδικά καταρτισμένο τεχνικό οπότε γνωρίζει καλά ό,τι έχει σχέση με τις εν λόγω εργασίες. Ο ειδικευμένος εγκαταστάτης που επιτρέπεται να κάνει όσες ηλεκτρολογικές εργασίες έχουν σχέση με την εγκατάσταση, τη μετεγκατάσταση και την αφαίρεση διαθέτει τα προσόντα που απαιτούνται για τις εν λόγω εργασίες όπως καθορίζεται από τους τοπικούς νόμους και κανονισμούς και έχει καταρτιστεί για θέματα που αφορούν τις ηλεκτρολογικές εργασίες σε κλιματιστικά τα οποία κατασκευάζονται από την Toshiba Carrier Corporation ή, εναλλακτικά, του έχουν δοθεί οι ανάλογες οδηγίες από ειδικά καταρτισμένο τεχνικό οπότε γνωρίζει καλά ό,τι έχει σχέση με τις εν λόγω εργασίες. Ο ειδικευμένος εγκαταστάτης που επιτρέπεται να χειρίζεται το ψυκτικό και να εκτελεί τις εργασίες σωλήνωσης που έχουν σχέση με την εγκατάσταση, τη μετεγκατάσταση και την αφαίρεση διαθέτει τα προσόντα που απαιτούνται για τις εν λόγω εργασίες όπως καθορίζεται από τους τοπικούς νόμους και κανονισμούς και έχει καταρτιστεί για θέματα που αφορούν τις εργασίες χειρισμού του ψυκτικού και τις εργασίες σωλήνωσης σε κλιματιστικά τα οποία κατασκευάζονται από την Toshiba Carrier Corporation ή, εναλλακτικά, του έχουν δοθεί οι ανάλογες οδηγίες από ειδικά καταρτισμένο τεχνικό οπότε γνωρίζει καλά ό,τι έχει σχέση με τις εν λόγω εργασίες. Ο ειδικευμένος εγκαταστάτης που επιτρέπεται να εργάζεται σε ψηλά σημεία έχει καταρτιστεί για θέματα που αφορούν τις εργασίες αυτές σε κλιματιστικά τα οποία κατασκευάζονται από την Toshiba Carrier Corporation ή, εναλλακτικά, του έχουν δοθεί οι ανάλογες οδηγίες από ειδικά καταρτισμένο τεχνικό οπότε γνωρίζει καλά ό,τι έχει σχέση με τις εν λόγω εργασίες.
Ειδικευμένος τεχνικός σέρβις (*1)	<ul style="list-style-type: none"> Ο ειδικευμένος τεχνικός σέρβις είναι αυτός που εκτελεί εργασίες εγκατάστασης, επισκευών, συντήρησης, μετεγκατάστασης και αφαίρεσης των κλιματιστικών τα οποία κατασκευάζει η Toshiba Carrier Corporation. Έχει καταρτιστεί για την εγκατάσταση, την επισκευή, τη συντήρηση, τη μετεγκατάσταση και την αφαίρεση των κλιματιστικών που κατασκευάζει η Toshiba Carrier Corporation ή, εναλλακτικά, του έχουν δοθεί οι ανάλογες οδηγίες από ειδικά καταρτισμένο τεχνικό οπότε γνωρίζει καλά ό,τι έχει σχέση με τις εν λόγω εργασίες. Ο ειδικευμένος τεχνικός σέρβις που επιτρέπεται να κάνει όσες ηλεκτρολογικές εργασίες έχουν σχέση με την εγκατάσταση, την επισκευή, τη μετεγκατάσταση και την αφαίρεση διαθέτει τα προσόντα που απαιτούνται για τις εν λόγω εργασίες όπως καθορίζεται από τους τοπικούς νόμους και κανονισμούς και έχει καταρτιστεί για θέματα που αφορούν τις ηλεκτρολογικές εργασίες σε κλιματιστικά τα οποία κατασκευάζονται από την Toshiba Carrier Corporation ή, εναλλακτικά, του έχουν δοθεί οι ανάλογες οδηγίες από ειδικά καταρτισμένο τεχνικό οπότε γνωρίζει καλά ό,τι έχει σχέση με τις εν λόγω εργασίες. Ο ειδικευμένος τεχνικός σέρβις που επιτρέπεται να χειρίζεται το ψυκτικό και να εκτελεί τις εργασίες σωλήνωσης που έχουν σχέση με την εγκατάσταση, την επισκευή, τη μετεγκατάσταση και την αφαίρεση διαθέτει τα προσόντα που απαιτούνται για τις εν λόγω εργασίες όπως καθορίζεται από τους τοπικούς νόμους και κανονισμούς και έχει καταρτιστεί για θέματα που αφορούν τις εργασίες χειρισμού του ψυκτικού και τις εργασίες σωλήνωσης σε κλιματιστικά τα οποία κατασκευάζονται από την Toshiba Carrier Corporation ή, εναλλακτικά, του έχουν δοθεί οι ανάλογες οδηγίες από ειδικά καταρτισμένο τεχνικό οπότε γνωρίζει καλά ό,τι έχει σχέση με τις εν λόγω εργασίες. Ο ειδικευμένος τεχνικός σέρβις που επιτρέπεται να εργάζεται σε ψηλά σημεία έχει καταρτιστεί για θέματα που αφορούν τις εργασίες αυτές σε κλιματιστικά τα οποία κατασκευάζονται από την Toshiba Carrier Corporation ή, εναλλακτικά, του έχουν δοθεί οι ανάλογες οδηγίες από ειδικά καταρτισμένο τεχνικό οπότε γνωρίζει καλά ό,τι έχει σχέση με τις εν λόγω εργασίες.



Ορισμός εξοπλισμού προστασίας

Κατά τη μεταφορά, την εγκατάσταση, τη συντήρηση, την επισκευή ή την αφαίρεση του κλιματιστικού πρέπει να φοράτε προστατευτικά γάντια και προστατευτική στολή εργασίας.
 Κατά την εκτέλεση των ειδικών εργασιών που περιγράφονται αναλυτικά στον παρακάτω πίνακα εκτός από τον συνήθη προστατευτικό εξοπλισμό, πρέπει να φοράτε και αυτόν που περιγράφεται παρακάτω.
 Αν παραλείψετε να φορέσετε τον σωστό προστατευτικό εξοπλισμό, θέτετε τον εαυτό σας σε κίνδυνο καθώς θα είστε πιο ευάλωτοι σε τραυματισμούς, εγκαύματα, ηλεκτροπληξία και άλλους τραυματισμούς.





Εκτελούμενη εργασία	Χρήση εξοπλισμού προστασίας
Κάθε τύπος εργασίας	Προστατευτικά γάντια Προστατευτική στολή εργασίας
Ηλεκτρολογικές εργασίες	Ρουχισμός που παρέχει προστασία από ηλεκτροπληξία Μονωμένα παπούτσια Γάντια που παρέχουν προστασία από ηλεκτροπληξία
Εργασία σε ψηλά σημεία (άνω των 50 εκατοστών)	Κράνη βιομηχανικής χρήσης
Μεταφορά βαρέων αντικειμένων	Υποδήματα με πρόσθετη προστασία στα δάχτυλα
Επισκευή εξωτερικής μονάδας	Προστατευτικά γάντια ηλεκτρολόγων

■ Σημασίες των συμβόλων που εμφανίζονται στο κλιματιστικό





Οι συγκεκριμένες προφυλάξεις ασφάλειας περιγράφουν σημαντικά ζητήματα που αφορούν θέματα ασφάλειας προς αποφυγή τραυματισμού των χρηστών και άλλων ατόμων και πρόκλησης υλικών ζημιών. Διαβάστε όλο το παρόν εγχειρίδιο αφού κατανοήσετε το παρακάτω περιεχόμενο (τις επεξηγήσεις των ενδείξεων) και φροντίστε να ακολουθήσετε κάθε περιγραφή.

Ένδειξη	Επεξήγηση ενδείξεων
 ΠΡΟΕΙΔΟΠΟΙΗΣΗ	Το κείμενο που επισημαίνεται με τον τρόπο αυτό υποδεικνύει ότι σε περίπτωση μη τήρησης των οδηγιών που παρατίθενται με την ένδειξη «Προειδοποίηση» υπάρχει κίνδυνος σοβαρής σωματικής βλάβης (*1) ή θανάσιμου τραυματισμού αν δεν χειριστείτε το προϊόν με τον ενδεδειγμένο τρόπο.
 ΠΡΟΣΟΧΗ	Το κείμενο που επισημαίνεται με τον τρόπο αυτό υποδεικνύει ότι σε περίπτωση μη τήρησης των οδηγιών που παρατίθενται με την ένδειξη «Προσοχή» υπάρχει κίνδυνος ελαφρού τραυματισμού (*2) ή υλικής ζημιάς (*3) αν δεν χειριστείτε το προϊόν με τον ενδεδειγμένο τρόπο.

*1: Ο όρος «σοβαρή σωματική βλάβη» σημαίνει απώλεια όρασης, τραυματισμό, εγκαύματα, ηλεκτροπληξία, κάταγμα, δηλητηρίαση και άλλους τραυματισμούς που έχουν συνέπειες και απαιτούν νοσοκομειακή περίθαλψη ή μακροχρόνια θεραπεία εκτός νοσοκομείου.
 *2: Ο όρος «ελαφρύς τραυματισμός» σημαίνει τραυματισμό, εγκαύματα, ηλεκτροπληξία και άλλους τραυματισμούς που δεν απαιτούν νοσοκομειακή περίθαλψη ούτε μακροχρόνια θεραπεία εκτός νοσοκομείου.
 *3: Ο όρος «υλική ζημιά» σημαίνει ζημιά σε κτήρια και επιπτώσεις σε νοικοκυριά, οικόσται ζώα και κατοικίδια.

	ΠΡΟΕΙΔΟΠΟΙΗΣΗ (Κίνδυνος πυρκαγιάς)
	Διαβάστε το ΕΓΧΕΙΡΙΔΙΟ ΚΑΤΟΧΟΥ προσεκτικά πριν από τη λειτουργία.
	Το προσωπικό του σέρβις απαιτείται να διαβάσει προσεκτικά το ΕΓΧΕΙΡΙΔΙΟ ΚΑΤΟΧΟΥ και το ΕΓΧΕΙΡΙΔΙΟ ΕΓΚΑΤΑΣΤΑΣΗΣ πριν από τη λειτουργία.
	Περισσότερες πληροφορίες είναι διαθέσιμες στο ΕΓΧΕΙΡΙΔΙΟ ΚΑΤΟΧΟΥ και το ΕΓΧΕΙΡΙΔΙΟ ΕΓΚΑΤΑΣΤΑΣΗΣ, και τα παρόμοια.

Προειδοποιητικές ενδείξεις στην κλιματιστική μονάδα

Προειδοποιητική ένδειξη	Περιγραφή
 <p>WARNING ELECTRICAL SHOCK HAZARD Disconnect all remote electric power supplies before servicing.</p>	<p>ΠΡΟΕΙΔΟΠΟΙΗΣΗ ΚΙΝΔΥΝΟΣ ΗΛΕΚΤΡΟΠΛΗΞΙΑΣ Αποσυνδέστε όλες τις απομακρυσμένες παροχές ηλεκτρικής τροφοδοσίας πριν από τη διενέργεια σέρβις.</p>
 <p>WARNING Moving parts. Do not operate unit with grille removed. Stop the unit before the servicing.</p>	<p>ΠΡΟΕΙΔΟΠΟΙΗΣΗ Κινούμενα μέρη. Μην θέσετε τη μονάδα σε λειτουργία, εάν έχετε αφαιρέσει τη γρίλια. Διακόψτε τη λειτουργία της μονάδας πριν από τη διενέργεια σέρβις.</p>
 <p>CAUTION High temperature parts. You might get burned when removing this panel.</p>	<p>ΠΡΟΣΟΧΗ Μέρη με υψηλή θερμοκρασία. Ενδέχεται να υποστείτε έγκαυμα κατά την αφαίρεση αυτού του πίνακα.</p>
 <p>CAUTION Do not touch the aluminum fins of the unit. Doing so may result in injury.</p>	<p>ΠΡΟΣΟΧΗ Μην ακουμπάτε τα πτερύγια αλουμινίου της μονάδας. Η μη συμμόρφωση ενδέχεται να προκαλέσει τραυματισμό.</p>
 <p>CAUTION BURST HAZARD Open the service valves before the operation, otherwise there might be the burst.</p>	<p>ΠΡΟΣΟΧΗ ΚΙΝΔΥΝΟΣ ΕΚΡΗΞΗΣ Ανοίξτε τις βαλβίδες σέρβις πριν από τη λειτουργία, διαφορετικά ενδέχεται να προκληθεί έκρηξη.</p>

1 Προφυλάξεις ασφαλείας

Ο κατασκευαστής δεν αναλαμβάνει ευθύνη για τυχόν βλάβες ή/και προκληθούν από αμέλεια συμμόρφωσης με τα όσα περιγράφονται στο παρόν εγχειρίδιο.

ΠΡΟΕΙΔΟΠΟΙΗΣΗ

Γενικά

- Πριν ξεκινήσετε με την εγκατάσταση του κλιματιστικού, διαβάστε με προσοχή το Εγχειρίδιο εγκατάστασης και ακολουθήστε τις οδηγίες για την εγκατάσταση του κλιματιστικού.
- Οι εργασίες εγκατάστασης επιτρέπεται να πραγματοποιηθούν μόνο από εξειδικευμένο εγκαταστάτη ή εξειδικευμένο τεχνικό σέρβις. Η λανθασμένη εγκατάσταση μπορεί να οδηγήσει σε διαρροές νερού, ηλεκτροπληξία ή πυρκαγιά.
- Μην χρησιμοποιείτε ψυκτικό άλλο από το προβλεπόμενο, για συμπλήρωση ή αντικατάσταση. Διαφορετικά, ενδέχεται να αναπτυχθεί αντικανονικά υψηλή πίεση στον ψυκτικό κύκλο, κάτι που ενδέχεται να επιφέρει βλάβη του προϊόντος ή έκρηξη ή σωματικό τραυματισμό σας.
- Πριν ανοίξετε τη γρίλια εισαγωγής της εσωτερικής μονάδας ή του πίνακα σέρβις της εξωτερικής μονάδας, θέστε τον αυτόματο διακόπτη κυκλώματος στη θέση OFF. Εάν δεν θέσετε τον αυτόματο διακόπτη κυκλώματος στη θέση OFF ενδέχεται να προκληθεί ηλεκτροπληξία λόγω τυχαίας επαφής με τα εξαρτήματα στο εσωτερικό της μονάδας. Η αφαίρεση της γρίλιας εισαγωγής της εσωτερικής μονάδας ή του πίνακα σέρβις της εξωτερικής μονάδας και η εκτέλεση των απαιτούμενων εργασιών επιτρέπεται να γίνουν μόνο από ειδικευμένο εγκαταστάτη (*1) ή ειδικευμένο τεχνικό σέρβις (*1).
- Πριν από την εκτέλεση εργασιών εγκατάστασης, συντήρησης, επισκευών ή αφαίρεσης, θέστε τον αυτόματο διακόπτη κυκλώματος στη θέση OFF. Διαφορετικά, ενδέχεται να προκληθεί ηλεκτροπληξία.
- Αναρτήστε πινακίδα με την ένδειξη «Εκτελούνται εργασίες» κοντά στον αυτόματο διακόπτη κυκλώματος ενόσω εκτελούνται εργασίες εγκατάστασης, συντήρησης, επισκευής ή απόρριψης. Υπάρχει κίνδυνος πρόκλησης ηλεκτροπληξίας, εάν ο αυτόματος διακόπτης κυκλώματος τεθεί στη θέση ON τυχαία.
- Μόνον ειδικευμένος εγκαταστάτης (*1) ή ειδικευμένος τεχνικός σέρβις (*1) επιτρέπεται να αναλαμβάνει την εκτέλεση εργασιών σε ψηλά σημεία χρησιμοποιώντας βάση στήριξης ύψους τουλάχιστον 50 εκατοστών ή να αφαιρεί τη γρίλια εισαγωγής της εσωτερικής μονάδας για την εκτέλεση εργασιών.
- Να φοράτε γάντια προστασίας και ρουχισμό για την ασφάλεια κατά την εργασία, όταν εκτελείτε εργασίες εγκατάστασης, σέρβις και απόρριψης.
- Μην αγγίζετε τα αλουμινένια πτερύγια της μονάδας. Ενδέχεται να τραυματιστείτε εάν το πράξετε. Εάν απαιτείται να αγγίξετε το πτερύγιο για οποιοδήποτε λόγο, φορέστε πρώτα γάντια προστασίας και ρουχισμό για την ασφάλεια κατά την εργασία και τότε μόνον προχωρήστε.

- Όταν εκτελείται εργασία σε ύψος, χρησιμοποιείτε σκάλα σύμφωνη με το πρότυπο ISO 14122, και ακολουθήστε τη διαδικασία η οποία αναφέρεται στις οδηγίες της σκάλας. Να φοράτε επίσης, κράνος βιομηχανικής χρήσης ως εξοπλισμό προστασίας πριν από την εκτέλεση της εργασίας.
- Πριν από τον καθαρισμό του φίλτρου ή άλλων μερών της εξωτερικής μονάδας, τοποθετήστε οπωσδήποτε τον αυτόματο διακόπτη στο OFF, και τοποθετήστε μία πινακίδα «Εκτελούνται εργασίες» κοντά στον αυτόματο διακόπτη προτού προχωρήσετε με την εργασία.
- Πριν από εργασία σε μεγάλο ύψος, τοποθετήστε μία πινακίδα έτσι ώστε κανείς να μην πλησιάσει το χώρο εργασίας, προτού προχωρήσετε με την εργασία σας. Εξαρτήματα και άλλα αντικείμενα ενδέχεται να υποστούν πτώση, τραυματίζοντας ενδεχομένως κάποιο άτομο το οποίο βρίσκεται από κάτω. Κατά την εκτέλεση των εργασιών, να φοράτε κράνος για την προστασία σας έναντι πτώσης αντικειμένων.
- Το ψυκτικό υγρό το οποίο χρησιμοποιείται στο συγκεκριμένο κλιματιστικό είναι τύπου R32.
- Το κλιματιστικό μηχανήμα θα πρέπει να μεταφέρεται σε συνθήκες ευστάθειας. Εάν οποιοδήποτε κομμάτι του προϊόντος είναι σπασμένο, επικοινωνήστε με τον αντιπρόσωπο.
- Όταν είναι απαραίτητο το κλιματιστικό να μεταφερθεί με τα χέρια, θα πρέπει να το μεταφέρουν δύο ή περισσότερα άτομα.
- Η συντήρηση πρέπει να πραγματοποιείται μόνο όπως συνιστάται από τον κατασκευαστή. Μη μετακινείτε ή επισκευάζετε οποιαδήποτε μονάδα μόνοι σας. Υπάρχει υψηλή τάση στο εσωτερικό της μονάδας. Μπορεί να σας προκαλέσει ηλεκτροπληξία όταν αφαιρέσετε το κάλυμμα και την κεντρική μονάδα.
- Η συγκεκριμένη συσκευή προορίζεται για χρήση από έμπειρους ή καταρτισμένους χρήστες στον κλάδο της ελαφράς βιομηχανίας ή για εμπορική χρήση από μη ειδικούς.

Επιλογή θέσης εγκατάστασης

- Όταν το κλιματιστικό είναι τοποθετημένο σε μικρό δωμάτιο, λάβετε τα κατάλληλα μέτρα προκειμένου να εξασφαλιστεί ότι η συγκέντρωση διαρροής ψυκτικού στο δωμάτιο δεν υπερβαίνει το κρίσιμο επίπεδο.
- Μην τοποθετείτε το μηχανήμα σε χώρο όπου υπάρχει πιθανότητα διαρροών εύφλεκτων αερίων. Εάν διαρρέει αέριο το οποίο και συσσωρεύεται γύρω από τη μονάδα, υπάρχει κίνδυνος να αναφλεγεί και να προκληθεί πυρκαγιά.
- Για να μεταφέρετε το κλιματιστικό μηχανήμα, να φοράτε υποδήματα με μεταλλικά καλύμματα στις μύτες.
- Για να μεταφέρετε το κλιματιστικό μηχανήμα, μην το κρατάτε από τα τσέρκια που υπάρχουν γύρω από το χαρτοκιβώτιο της συσκευασίας του. Ενδέχεται να τραυματιστείτε, εάν οι ταινίες σπάσουν.
- Εγκαταστήστε την εσωτερική μονάδα σε ύψος 2,5 m τουλάχιστον πάνω από το δάπεδο, διότι διαφορετικά οι χρήστες ενδέχεται να τραυματιστούν ή να υποστούν ηλεκτροπληξία σε περίπτωση που εισάγουν τα δάκτυλά τους ή άλλα αντικείμενα στο εσωτερικό της εσωτερικής μονάδας ενώ το κλιματιστικό βρίσκεται σε λειτουργία.
- Μην τοποθετείτε συσκευή καύσης σε σημείο το οποίο εκτίθεται απευθείας στη ροή αέρα του κλιματιστικού, ενδέχεται να προκληθεί ατελής καύση.

- Η συσκευή και οι σωληνώσεις πρέπει να εγκαθίστανται, να λειτουργούν και να αποθηκεύονται σε δωμάτιο με επιφάνεια δαπέδου μεγαλύτερη από $A_{\min} \text{ m}^2$.
Πώς να έχετε $A_{\min} \text{ m}^2$: $A_{\min} = (M / (2,5 \times 0,22759 \times h_0))^2$
M είναι η ποσότητα πλήρωσης ψυκτικού στη συσκευή σε **kg**.
 h_0 είναι το ύψος εγκατάστασης της συσκευής σε **m**:
0,6 m για όρθια στο δάπεδο/1,8 m για τοποθέτηση σε τοίχο/1,0 m για τοποθέτηση σε παράθυρο/2,2 m για τοποθέτηση σε οροφή.
Για λεπτομέρειες, ανατρέξτε στο Εγχειρίδιο Εγκατάστασης της εξωτερικής μονάδας.

Εγκατάσταση

- Όταν η εσωτερική μονάδα προορίζεται για ανάρτηση, απαιτείται η χρήση των κοχλιών ανάρτησης (M10 ή W3/8) και των περικοχλίων (M10 ή W3/8) αποκλειστικής χρήσης.
- Εγκαταστήστε το κλιματιστικό μηχανήμα με ασφάλεια, σε σημείο όπου η βάση του να μπορεί να στηρίξει επαρκώς το βάρος του. Εάν τα σημεία αυτά δεν διαθέτουν επαρκή αντοχή, η μονάδα ενδέχεται να υποστεί πτώση και να προκαλέσει τραυματισμό.
- Ακολουθήστε τις οδηγίες που αναγράφονται στο Εγχειρίδιο Εγκατάστασης για να εγκαταστήσετε το κλιματιστικό. Αμέλεια συμμόρφωσης με αυτές τις οδηγίες μπορεί να προκαλέσει πτώση ή ανατροπή του προϊόντος ή να αναπτύσσονται θόρυβος, κραδασμοί, διαρροή νερού ή άλλα προβλήματα.
- Πραγματοποιήστε την προβλεπόμενη εργασία εγκατάστασης έτσι ώστε ο εξοπλισμός να αντέχει σε πιθανούς ισχυρούς ανέμους ή σεισμό. Εάν το κλιματιστικό μηχανήμα δεν εγκατασταθεί σωστά, μπορεί κάποια μονάδα να ανατραπεί ή να πέσει από ύψος, με αποτέλεσμα την πρόκληση ατυχήματος.
- Σε περίπτωση διαρροής του ψυκτικού αερίου κατά τη διάρκεια των εργασιών εγκατάστασης, αερίστε τον χώρο αμέσως. Εάν το ψυκτικό αέριο που διαρρέει έρθει σε επαφή με φωτιά, υπάρχει η πιθανότητα έκλυσης δύσσομου αερίου.
- Χρησιμοποιείτε περονοφόρο ανυψωτικό μηχανήμα για να μεταφέρετε τα τμήματα του κλιματιστικού μηχανήματος και χρησιμοποιείτε βαρούλκο ή παλάγκο για την εγκατάστασή τους.

Σωλήνωση ψυκτικού

- Εγκαταστήστε το σωλήνα ψυκτικού με ασφάλεια στη διάρκεια της εργασίας εγκατάστασης πριν θέσετε σε λειτουργία το κλιματιστικό. Εάν ο συμπιεστής λειτουργήσει με τη βαλβίδα ανοιχτή και χωρίς σωλήνα ψυκτικού υγρού, ο συμπιεστής αναρροφά αέρα και ο κύκλος ψύξης υπερσυμπιέζεται, πράγμα το οποίο ενδέχεται να προκαλέσει τραυματισμό.
- Σφίξτε το ρακόρ με ένα ροπόκλειδο ακολουθώντας τον καθορισμένο τρόπο. Τυχόν υπερβολικό σφίξιμο του ρακόρ ενδέχεται να προκαλέσει ράγισμα του ρακόρ μετά από μακρό χρονικό διάστημα, πράγμα το οποίο ενδέχεται να καταλήξει σε διαρροή ψυκτικού υγρού.
- Μετά τις εργασίες εγκατάστασης, βεβαιωθείτε ότι δεν υπάρχει διαρροή του ψυκτικού αερίου. Τυχόν διαρροή του ψυκτικού αερίου στο χώρο και κίνησή του κοντά σε πηγή φωτιάς, όπως εστία κουζίνας, ενδέχεται να δημιουργήσει επιβλαβείς αναθυμιάσεις.

- Μόλις ολοκληρωθεί η εγκατάσταση ή η αλλαγή θέσης του κλιματιστικού, ακολουθήστε τις οδηγίες που αναγράφονται στο Εγχειρίδιο Εγκατάστασης για πλήρη εξαέρωση, ώστε στον κύκλο ψύξης να μην αναμιγνύονται άλλα αέρια εκτός του ψυκτικού υγρού. Εάν δεν πραγματοποιήσετε πλήρη εξαέρωση, ενδέχεται να προκληθεί δυσλειτουργία του κλιματιστικού.
- Απαιτείται η χρήση αερίου αζώτου για τη δοκιμή στεγανότητας.
- Ο σωλήνας πλήρωσης πρέπει να συνδεθεί με τρόπο ώστε να μην παρουσιάζει χαλαρότητα.

Ηλεκτρική καλωδίωση

- Η εκτέλεση των ηλεκτρολογικών εργασιών στο κλιματιστικό επιτρέπεται μόνο από ειδικευμένο εγκαταστάτη (*1) ή ειδικευμένο τεχνικό σέρβις (*1). Σε καμία περίπτωση δεν επιτρέπεται η εκτέλεση των εν λόγω εργασιών από ανειδίκευτο άτομο, επειδή τυχόν μη κατάλληλη εκτέλεση των εργασιών ενδέχεται να καταλήξει σε ηλεκτροπληξία ή/και διαρροές ρεύματος.
- Κατά τη σύνδεση των ηλεκτρικών καλωδίων, την επισκευή των ηλεκτρικών εξαρτημάτων ή την εκτέλεση άλλων ηλεκτρολογικών εργασιών, να φοράτε γάντια προστασίας κατά της ηλεκτροπληξίας, υποδήματα με μόνωση και ρουχισμό προστασίας από ηλεκτροπληξία. Η μη χρήση του συγκεκριμένου εξοπλισμού προστασίας ενδέχεται να καταλήξει σε ηλεκτροπληξία.
- Να χρησιμοποιείτε καλωδιώσεις οι οποίες πληρούν τις προδιαγραφές του Εγχειριδίου Εγκατάστασης και τις απαιτήσεις των τοπικών κανονισμών και νομοθεσίας. Η χρήση καλωδιώσεων οι οποίες δεν πληρούν τις προδιαγραφές ενδέχεται να προκαλέσει ηλεκτροπληξία, διαρροές ρεύματος, καπνό ή/και πυρκαγιά.
- Συνδέστε το καλώδιο γείωσης. (εργασία γείωσης)
Η ατελής γείωση μπορεί να οδηγήσει σε ηλεκτροπληξία.
- Μη συνδέετε τα καλώδια γείωσης με σωλήνες φυσικού αερίου, σωλήνες νερού και την κάθοδο του αντικεραυνικού συστήματος ή τους αγωγούς γείωσης του τηλεφώνου.
- Μετά την ολοκλήρωση της εργασίας επισκευής ή μετεγκατάστασης, βεβαιωθείτε ότι οι αγωγοί γείωσης έχουν συνδεθεί σωστά.
- Φροντίστε για την εγκατάσταση αυτόματου διακόπτη κυκλώματος ο οποίος πληροί τις προδιαγραφές του Εγχειριδίου Εγκατάστασης και τις απαιτήσεις των τοπικών κανονισμών και νομοθεσίας.
- Εγκαταστήστε τον αυτόματο διακόπτη κυκλώματος σε σημείο όπου θα διευκολύνεται η πρόσβασή του από τον αντιπρόσωπο.
- Οπότε χρειαστεί να εγκαταστήσετε τον διακόπτη κυκλώματος σε εξωτερικό χώρο, φροντίστε να είναι σχεδιασμένος για την εν λόγω χρήση.
- Σε καμία περίπτωση, το καλώδιο τροφοδοσίας ή το καλώδιο σύνδεσης της εσωτερικής και της εξωτερικής μονάδας δεν πρέπει να συνδεθεί στη μέση (Σύνδεση με χρήση ακροδέκτη χωρίς συγκόλληση κλπ.)
Τυχόν προβλήματα σύνδεσης στα σημεία, όπου το καλώδιο συνδέεται στη μέση, ενδέχεται να προκαλέσουν καπνό ή/και πυρκαγιά.

- Οι εργασίες ηλεκτρικής καλωδίωσης πρέπει να εκτελούνται σύμφωνα με τους νόμους και κανονισμούς της κοινότητας και το εγχειρίδιο εγκατάστασης.
Διαφορετικά μπορεί να προκληθεί ηλεκτροπληξία ή βραχυκύκλωμα.

Δοκιμαστική λειτουργία

- Μόλις ολοκληρωθούν οι εργασίες και πριν θέσετε το κλιματιστικό σε λειτουργία, βεβαιωθείτε ότι το κάλυμμα του ηλεκτρικού κουτιού της εσωτερικής μονάδας και ο πίνακας σέρβις της εξωτερικής μονάδας είναι κλειστά και θέστε τον αυτόματο διακόπτη κυκλώματος στη θέση ΟΝ. Εάν δεν πραγματοποιήσετε αυτούς τους ελέγχους, ενδέχεται να υποστείτε ηλεκτροπληξία σε περίπτωση που ενεργοποιηθεί η τροφοδοσία.
- Αν έχει παρουσιαστεί πρόβλημα οιοδήποτε είδους στο κλιματιστικό (π.χ. ένδειξη σφάλματος, οσμή καμένου, ασυνήθιστοι θόρυβοι, αποτυχία ψύξης ή θέρμανσης ή διαρροή νερού), μην αγγίζετε το κλιματιστικό αλλά φέρτε τον διακόπτη κυκλώματος στη θέση OFF και επικοινωνήστε με ειδικευμένο τεχνικό. Λάβετε μέτρα, ώστε να μην είναι εφικτή η ενεργοποίηση της παροχής ρεύματος (αναρτώντας μια πινακίδα με την ένδειξη «εκτός λειτουργίας» κοντά στον αυτόματο διακόπτη κυκλώματος, για παράδειγμα), έως ότου να φθάσει ο εξειδικευμένος τεχνικός σέρβις. Εάν συνεχίζετε να χρησιμοποιείτε το κλιματιστικό μηχάνημα παρόλο που παρουσιάζει πρόβλημα, ενδέχεται τα μηχανικά προβλήματά του να επιδεινωθούν ή να προκληθεί ηλεκτροπληξία κλπ.
- Μόλις ολοκληρωθούν οι εργασίες, χρησιμοποιήστε κατάλληλη συσκευή για τον έλεγχο της μόνωσης (500 V Megger) για να ελέγξετε εάν η αντίσταση είναι 1 ΜΩ ή περισσότερο μεταξύ ηλεκτροφόρου τμήματος και μη ηλεκτροφόρου μεταλλικού τμήματος (τμήμα γείωσης). Εάν η τιμή αντίστασης είναι χαμηλή, θα προκληθεί σοβαρή ζημιά στην πλευρά του χρήστη, όπως διαρροή ρεύματος ή ηλεκτροπληξία.
- Μόλις ολοκληρωθούν οι εργασίες εγκατάστασης, ελέγξτε για διαρροές ψυκτικού υγρού, την αντίσταση μόνωσης και την αποστράγγιση νερού. Στη συνέχεια, εκτελέστε δοκιμαστική λειτουργία ώστε να ελεγχθεί ότι το κλιματιστικό λειτουργεί κανονικά.

Επεξηγήσεις που παρέχονται στο χρήστη

- Μόλις ολοκληρωθούν οι εργασίες εγκατάστασης, ενημερώστε το χρήστη για τη θέση του αυτόματου διακόπτη κυκλώματος. Εάν ο χρήστης δεν γνωρίζει που βρίσκεται ο αυτόματος διακόπτης κυκλώματος, δεν θα μπορεί να τον απενεργοποιήσει σε περίπτωση που παρουσιαστεί κάποιο πρόβλημα στο κλιματιστικό.
- Μόλις ολοκληρωθούν οι εργασίες εγκατάστασης, ακολουθήστε τις οδηγίες που αναγράφονται στο εγχειρίδιο κατόχου, για να εξηγήσετε στον πελάτη τον τρόπο χρήσης και συντήρησης της μονάδας.

Αλλαγή θέσης

- Η μετεγκατάσταση του κλιματιστικού επιτρέπεται να εκτελείται μόνον από ειδικευμένο εγκαταστάτη (*1) ή ειδικευμένο τεχνικό σέρβις (*1). Σε περίπτωση εγκατάστασης του κλιματιστικού από ανειδίκευτο άτομο, υπάρχει μεγάλος κίνδυνος να προκληθεί πυρκαγιά, ηλεκτροπληξία, τραυματισμός, διαρροή νερού, θόρυβος ή/και κραδασμοί.
- Κατά την εργασία περισυλλογής ψυκτικού υγρού, διακόψτε τη λειτουργία του συμπιεστή πριν από την αποσύνδεση του σωλήνα ψυκτικού υγρού. Η αποσύνδεση του σωλήνα ψυκτικού ενώ η βαλβίδα συντήρησης είναι ανοικτή και ο συμπιεστής λειτουργεί, θα προκαλέσει την αναρρόφηση αέρα ή άλλου αερίου, την αύξηση της πίεσης στο εσωτερικό του κύκλου ψύξης σε μη φυσιολογικά υψηλά επίπεδα και μπορεί πιθανώς να προκληθεί ρήξη, τραυματισμός ή άλλη βλάβη.

(*1) Ανατρέξτε στην ενότητα «Ορισμός ειδικευμένου εγκαταστάτη ή ειδικευμένου τεχνικού σέρβις».

ΠΡΟΣΟΧΗ

Στο συγκεκριμένο Κλιματιστικό έχει υιοθετηθεί η χρήση ψυκτικού HFC (R32) που δεν καταστρέφει τη στιβάδα του όζοντος.

- Καθώς το ψυκτικό R32 επηρεάζεται εύκολα από ακαθαρσίες όπως υγρασία, οξειδωμένο φιλμ, λάδι κλπ., λόγω της υψηλής πίεσης, προσέξτε να μην επιτραπεί η ανάμιξη υγρασίας, ακαθαρσιών, υπάρχοντος ψυκτικού, ψυκτικού ελαίου κλπ. κατά τη διάρκεια των εργασιών εγκατάστασης.
- Για την εγκατάσταση απαιτείται ειδικό εργαλείο για το ψυκτικό R32.
- Χρησιμοποιήστε ένα νέο και καθαρό υλικό σωληνώσεων για τον σωλήνα σύνδεσης, έτσι ώστε η υγρασία και οι ακαθαρσίες να μην αναμιγνύονται μαζί κατά τη διάρκεια των εργασιών εγκατάστασης.
- Όταν χρησιμοποιείτε τις υπάρχουσες σωληνώσεις, ακολουθείτε το εγχειρίδιο εγκατάστασης που παρέχεται μαζί με την εξωτερική μονάδα.

Благодарим вас за приобретение кондиционера Toshiba. Внимательно прочтите данные инструкции, так как в них содержится важная информация, соответствующая директиве «Механическое оборудование 2006/42/ЕС», и убедитесь, что они вам понятны. После завершения установки передайте пользователю это руководство по установке и руководство пользователя и попросите пользователя хранить эти материалы в надежном месте для использования в будущем.

Общее обозначение: кондиционер воздуха

Определение квалифицированного монтажника или квалифицированного специалиста по обслуживанию

Этот кондиционер должен устанавливаться, обслуживаться, ремонтироваться и демонтироваться квалифицированным монтажником или квалифицированным специалистом по обслуживанию. Каждый раз, когда вам нужно будет проделать какую-либо из этих операций, обращайтесь к квалифицированному монтажнику или специалисту по обслуживанию. Квалифицированный монтажник или квалифицированный специалист по обслуживанию — это лицо, имеющее квалификацию и знания, указанные в таблице ниже.

Лицо	Необходимые квалификация и знания
Квалифицированный монтажник (*1)	<ul style="list-style-type: none"> Квалифицированный монтажник — это лицо, которое устанавливает, обслуживает, перемещает и демонтирует кондиционеры производства компании Toshiba Carrier Corporation. Это лицо прошло обучение операциям установки, технического обслуживания, переустановки и демонтажа кондиционеров производства компании Toshiba Carrier Corporation либо получило инструктаж по выполнению таких операций от лица или лиц, прошедших необходимое обучение и знакомых с указанными операциями во всех деталях. Квалифицированный монтажник, допущенный к выполнению необходимых электротехнических работ при установке, переустановке и демонтаже, имеет соответствующую этим работам квалификацию, предусмотренную местным законодательством и нормативами, и представляет собой лицо, обученное вопросам выполнения электротехнических работ, связанных с кондиционерами производства компании Toshiba Carrier Corporation, либо получившее инструктаж по таким вопросам от лица или лиц, прошедших необходимое обучение и знакомых с указанными работами во всех деталях. Квалифицированный монтажник, допущенный к выполнению необходимых работ с хладагентом и прокладке трубок хладагента при установке, переустановке и демонтаже, имеет соответствующую этим работам квалификацию, предусмотренную местным законодательством и нормативами, и представляет собой лицо, обученное вопросам прокладки трубок хладагента и обращения с хладагентом, связанным с кондиционерами производства компании Toshiba Carrier Corporation, либо получившее инструктаж по таким вопросам от лица или лиц, прошедших необходимое обучение и знакомых с указанными работами во всех деталях. Квалифицированный монтажник, допущенный к выполнению высотных работ, прошел обучение по вопросам высотных работ с кондиционерами производства компании Toshiba Carrier Corporation либо получил инструктаж по таким вопросам от лица или лиц, прошедших необходимое обучение и знакомых с указанными работами во всех деталях.
Квалифицированный специалист по обслуживанию (*1)	<ul style="list-style-type: none"> Квалифицированный специалист по обслуживанию — это лицо, которое устанавливает, ремонтирует, обслуживает, перемещает и демонтирует кондиционеры производства компании Toshiba Carrier Corporation. Это лицо прошло обучение операциям установки, ремонта, технического обслуживания, переустановки и демонтажа кондиционеров производства компании Toshiba Carrier Corporation либо получило инструктаж по выполнению таких операций от лица или лиц, прошедших необходимое обучение и знакомых с указанными операциями во всех деталях. Квалифицированный специалист по обслуживанию, допущенный к выполнению необходимых электротехнических работ при установке, ремонте, переустановке и демонтаже, имеет соответствующую этим работам квалификацию, предусмотренную местным законодательством и нормативами, и представляет собой лицо, обученное вопросам выполнения электротехнических работ, связанных с кондиционерами производства компании Toshiba Carrier Corporation, либо получившее инструктаж по таким вопросам от лица или лиц, прошедших необходимое обучение и знакомых с указанными работами во всех деталях. Квалифицированный специалист по обслуживанию, допущенный к выполнению необходимых работ с хладагентом и прокладке трубок хладагента при установке, переустановке и демонтаже, имеет соответствующую этим работам квалификацию, предусмотренную местным законодательством и нормативами, и представляет собой лицо, обученное вопросам прокладки трубок хладагента и обращения с хладагентом, связанным с кондиционерами производства компании Toshiba Carrier Corporation, либо получившее инструктаж по таким вопросам от лица или лиц, прошедших необходимое обучение и знакомых с указанными работами во всех деталях. Квалифицированный специалист по обслуживанию, допущенный к выполнению высотных работ, прошел обучение по вопросам высотных работ с кондиционерами производства компании Toshiba Carrier Corporation либо получил инструктаж по таким вопросам от лица или лиц, прошедших необходимое обучение и знакомых с указанными работами во всех деталях.



Определение средств индивидуальной защиты

При перевозке, установке, техническом обслуживании, ремонте или демонтаже кондиционера следует носить защитные перчатки и спецодежду. В дополнение к обычным средствам индивидуальной защиты при выполнении специальных работ, перечисленных в таблице ниже, нужно пользоваться указанными ниже средствами индивидуальной защиты. Если не используются надлежащие средства индивидуальной защиты, возрастает опасность получения травм, ожогов, поражения электрическим током и других повреждений.





Выполняемая работа	Необходимые средства индивидуальной защиты
Все типы работы	Защитные перчатки Защитная рабочая спецодежда
Работы, связанные с электричеством	Одежда, обеспечивающая защиту от удара электрическим током Изоляционные ботинки Перчатки, обеспечивающие защиту от поражения электрическим током
Работы, выполняемые на высоте (50 см или выше)	Промышленная каска
Переноска тяжелых предметов	Ботинки с дополнительным защитным носком
Ремонт наружных блоков	Защитные перчатки для электриков

Значения символов, отображаемых на кондиционере





Данные меры предосторожности касаются важных вопросов обеспечения безопасности для предотвращения травм пользователей и прочих лиц, а также материального ущерба. Перед прочтением данного руководства уясните приведенную ниже информацию (значение условных обозначений) и неукоснительно соблюдайте описанные меры.

Индикация	Значение обозначения
 ПРЕДОСТЕРЕЖЕНИЕ	Такое обозначение текста указывает на то, что несоблюдение приведенных указаний и ненадлежащее обращение с изделием могут привести к получению тяжелого телесного повреждения (*1) или гибели.
 ВНИМАНИЕ	Такое обозначение текста указывает на то, что несоблюдение приведенных указаний и ненадлежащее обращение с изделием могут привести к получению незначительной травмы (*2) или нанесению материального ущерба (*3).

*1: Под тяжелыми телесными повреждениями подразумеваются потеря зрения, травмы, ожоги, поражения электрическим током, переломы костей, отравления и другие повреждения, после которых остаются последствия и требуются госпитализация или долгосрочное амбулаторное лечение.
*2: Под незначительными травмами подразумеваются травмы, ожоги, поражения электрическим током и другие повреждения, после которых не требуется госпитализация или долгосрочное амбулаторное лечение.
*3: Под материальным ущербом подразумевается ущерб, наносимый зданиям, домашнему имуществу, домашнему скоту и домашним животным.

	ПРЕДОСТЕРЕЖЕНИЕ (Опасность пожара)
	Перед эксплуатацией внимательно прочитайте РУКОВОДСТВО ПОЛЬЗОВАТЕЛЯ.
	Перед эксплуатацией обслуживающий персонал должен внимательно прочитать РУКОВОДСТВО ПОЛЬЗОВАТЕЛЯ и ИНСТРУКЦИЮ ПО УСТАНОВКЕ.
	Дополнительная информация доступна в РУКОВОДСТВЕ ПОЛЬЗОВАТЕЛЯ, ИНСТРУКЦИИ ПО УСТАНОВКЕ и тому подобных документах.

Предостерегающие указания на кондиционере

Предупреждающий символ	Описание
 <p>WARNING ELECTRICAL SHOCK HAZARD Disconnect all remote electric power supplies before servicing.</p>	<p>ПРЕДОСТЕРЕЖЕНИЕ</p> <p>ОПАСНОСТЬ ПОРАЖЕНИЯ ЭЛЕКТРИЧЕСКИМ ТОКОМ Перед выполнением обслуживания нужно отключить все внешние источники электроэнергии.</p>
 <p>WARNING Moving parts. Do not operate unit with grille removed. Stop the unit before the servicing.</p>	<p>ПРЕДОСТЕРЕЖЕНИЕ</p> <p>Движущиеся части. Запрещается работать на устройстве при движущейся решетке. Перед обслуживанием устройство нужно остановить.</p>
 <p>CAUTION High temperature parts. You might get burned when removing this panel.</p>	<p>ВНИМАНИЕ</p> <p>Горячие детали. При снятии этой панели можно получить ожог.</p>
 <p>CAUTION Do not touch the aluminum fins of the unit. Doing so may result in injury.</p>	<p>ВНИМАНИЕ</p> <p>Не касайтесь алюминиевого оребрения на устройстве. Это может привести к травме.</p>
 <p>CAUTION BURST HAZARD Open the service valves before the operation, otherwise there might be the burst.</p>	<p>ВНИМАНИЕ</p> <p>ОПАСНОСТЬ РАЗРЫВА Откройте клапаны обслуживания перед началом работы, иначе может произойти разрыв.</p>

1 Правила техники безопасности

Производитель не несет ответственности за ущерб, вызванный несоблюдением инструкций, приведенных в данном руководстве.

ПРЕДОСТЕРЕЖЕНИЕ

Общие меры предосторожности

- Прежде чем приступить к установке кондиционера, внимательно прочтите Руководство по установке и в процессе работы соблюдайте изложенные в нем инструкции.
- Выполнение работы по установке разрешается только квалифицированному монтажнику или квалифицированному специалисту по обслуживанию. Неправильная установка может привести к утечке воды, поражению электрическим током или воспламенению.
- Запрещается использовать для пополнения или замены хладагент, отличный от указанного. В противном случае в контуре охлаждения может образоваться аномально высокое давление, что может привести к поломке или взрыву изделия, а также вызвать травмы.
- Прежде чем снимать решетку на воздухозаборнике внутреннего блока или на служебной панели наружного блока, установленного вне помещения, установите сетевой выключатель в положение OFF (ВЫКЛ). Если сетевой выключатель не установить в положение OFF (ВЫКЛ), можно получить удар электрическим током при контакте с внутренними узлами кондиционера. Снимать решетку воздухозаборника внутреннего блока или служебную панель наружного блока и выполнять необходимые работы разрешается только квалифицированным монтажникам (*1) или квалифицированным специалистам по обслуживанию (*1).
- Перед выполнением работ по установке, техническому обслуживанию, ремонту или демонтажу необходимо перевести сетевой выключатель в положение OFF (ВЫКЛ). В противном случае может произойти поражение электрическим током.
- На время выполнения работ по установке, обслуживанию, ремонту или перемещению кондиционера рядом с сетевым выключателем следует поместить знак «Ведутся работы». Если кто-либо по ошибке установит выключатель в положение ON (ВКЛ), возможно поражение работающего электрическим током.
- Работать на подставке высотой 50 см или более и снимать решетку воздухозаборника внутреннего блока для выполнения работ разрешается только квалифицированному монтажнику (*1) или квалифицированному специалисту по обслуживанию (*1).
- При ремонте, обслуживании и перемещении следует пользоваться защитными перчатками и спецодеждой.
- Не прикасайтесь к алюминиевому оребрению на устройстве. В противном случае можно получить травму. Если нужно зачехлить оребрение, сначала наденьте защитные перчатки и спецодежду, а затем продолжайте работу.

- При работе на высоте необходимо пользоваться лестницей, отвечающей требованиям стандарта ISO 14122, и следовать указаниям, содержащимся в инструкции по работе с лестницами. При выполнении работ также нужно надевать каску принятого в промышленности образца.
- Перед очисткой фильтров или других узлов наружного блока нужно надежно установить сетевой выключатель в положение OFF (ВЫКЛ) и до начала работ выставить рядом с ним знак «Ведутся работы».
- До начала выполнения высотных работ нужно выставить предупреждающий знак, чтобы никто не приближался к зоне проведения работ. Сверху могут упасть детали или другие предметы, и нанести травму людям, находящимся внизу. Во время выполнения работы необходимо надеть каску для защиты головы от падающих предметов.
- В данном кондиционере используется хладагент R32.
- При перевозке кондиционер должен находиться в устойчивом положении. В случае повреждения какой-либо части изделия обратитесь к дилеру.
- Переноску кондиционера должны осуществлять не менее двух человек.
- Обслуживание должно выполняться только в соответствии с рекомендациями производителя. Не перемещайте и не выполняйте ремонт устройств самостоятельно. Внутри устройства находятся компоненты под высоким напряжением. Снятие крышки или основного устройства может привести к поражению электрическим током.
- Прибор предназначен для использования специалистами или обученными пользователями в магазинах, в легкой промышленности, а также для коммерческого использования неспециалистами.

Выбор места установки

- При установке кондиционера в небольшом помещении необходимо принять надлежащие меры, чтобы не допустить превышения предельной концентрации хладагента даже в случае его утечки.
- Запрещается устанавливать изделие в месте, где возможны утечки горючего газа. В случае утечки газа и концентрации его вокруг блока газ может воспламениться и стать причиной пожара.
- При транспортировке кондиционера необходимо надевать ботинки с дополнительным защитным носком.
- При транспортировке кондиционера не беритесь за обвязку вокруг картонной упаковки. Если обвязка лопнет, вы можете получить травму.
- В помещении кондиционер следует устанавливать на высоте не менее 2,5 м от пола, так как в противном случае пользователи могут получить удар электрическим током или травмировать себя, если их пальцы или другие предметы попадут внутрь работающего кондиционера.

- Нельзя устанавливать какие-либо отопительные приборы в местах, где на них будет непосредственно попадать воздушный поток от кондиционера, так как это может приводить к неполному сгоранию.
- Прибор и трубы необходимо устанавливать, эксплуатировать и хранить в помещении с общей площадью более $A_{\text{мин.}} \text{ м}^2$.
Как получить $A_{\text{мин.}} \text{ м}^2$: $A_{\text{мин.}} = (M / (2,5 \times 0,22759 \times v_0))^2$
M представляет собой количество хладагента в приборе в кг;
 v_0 – высота установки прибора в м:
0,6 м для напольной установки / 1,8 м для настенного монтажа / 1,0 м для оконного монтажа / 2,2 м для потолочного монтажа.
Подробную информацию см. в руководстве по установке наружного блока.

Установка

- Для подвешивания внутреннего блока нужно использовать специально предназначенные для этого подвесные болты (M10 или W3/8) и гайки (M10 или W3/8).
- Кондиционер следует надежно устанавливать в месте, способном выдержать его вес. Если прочности недостаточно, то блок может упасть, нанеся травму.
- При установке кондиционера следуйте указаниям руководства по установке. Несоблюдение этих инструкций может привести к падению или опрокидыванию изделия, появлению шума, вибрации, утечки воды и другим поломкам.
- При установке примите меры для защиты от сильного ветра и землетрясений. В случае ненадлежащей установки кондиционера блок может упасть или опрокинуться и стать причиной несчастного случая.
- В случае утечки хладагента во время монтажных работ, немедленно проветрите помещение. При контакте хладагента с огнем может образоваться токсичный газ.
- Перевозить блоки кондиционера следует с помощью вилочного погрузчика, а поднимать на месте установки с помощью подъемника или лебедки.

Трубопровод хладагента

- Перед началом эксплуатации кондиционера надежно смонтируйте и закрепите трубопровод. Если компрессор работает с открытым клапаном и без трубопровода, компрессор засасывает воздух и в контуре охлаждения давление поднимается выше нормы, что может привести к травмированию окружающих.
- Затягивайте конусную гайку динамометрическим ключом с заданным моментом. Чрезмерная затяжка конусной гайки может привести к тому, что со временем на ней образуется трещина, которая может привести к утечке хладагента.

- По окончании монтажных работ убедитесь в отсутствии утечек хладагента. Утечка хладагента и формирование его потока в непосредственной близости от источников огня, например, кухонной плиты, может приводить к образованию токсичного газа.
- При установке и переустановке кондиционера соблюдайте инструкции, приведенные в руководстве по установке, и выдувайте весь воздух из контура хладагента, чтобы в нем не могли смешиваться никакие другие газы, кроме хладагента. Если не удалить воздух полностью, это может привести к неисправностям в работе кондиционера.
- Для проверки на герметичность пользуйтесь азотом.
- Загрузочный шланг нужно подсоединять так, чтобы в нем нигде не было слабину.

Электропроводка

- Проводить электротехнические работы с кондиционером разрешается только квалифицированному монтажнику (*1) или квалифицированному специалисту по обслуживанию (*1). Ни при каких обстоятельствах эти работы нельзя поручать неквалифицированным лицам, иначе при неправильном выполнении работ возможны поражения электрическим током и/или утечка электроэнергии.
- При подключении электропроводки, ремонте электрических узлов или выполнении других электротехнических работ нужно надевать защитные перчатки для электриков, изолирующие ботинки и одежду, чтобы защититься от поражения электрическим током. Если этого не сделать, возможно поражение электрическим током.
- Используйте электропроводку, которая отвечает техническим характеристикам, приведенным в данном руководстве по установке, а также местным нормативам и требованиям законодательства. Использование электропроводки, не отвечающей техническим требованиям, может привести к поражению электрическим током, утечкам электроэнергии, задымлению и/или пожару.
- Подключите провод заземления. (Работы по заземлению) Невыполнение заземления может стать причиной поражения электрическим током.
- Не подсоединяйте провода заземления к газопроводным и водопроводным трубам, громоотводам и проводам заземления для телефонных проводов.
- По окончании ремонтных работ или работ по переустановке кондиционера убедитесь, что провода заземления правильно подсоединены.
- Пользуйтесь сетевыми выключателями, которые отвечают техническим характеристикам, приведенным в данном руководстве по установке, а также местным нормативам и требованиям законодательства.
- Устанавливать сетевой выключатель нужно так, чтобы обслуживающее лицо могло легко до него добраться.
- При установке наружных сетевых выключателей нужно использовать такие их типы, которые предназначены для установки вне помещений.

- Ни при каких обстоятельствах не следует подключать силовой кабель или соединительный провод внутреннего и наружного блоков посередине (подключение с помощью разъемной клеммы и т. д.). Нарушение соединения в местах подключения провода посередине может вызвать задымление и/или пожар.
- Работы по прокладке электропроводки должны выполняться в соответствии с законодательством и нормативами, принятыми в данной стране, и отвечать требованиям руководства по установке. В противном случае возможно поражение электрическим током или короткое замыкание.

Пробный пуск

- Перед тем как запускать кондиционер после окончания работ на нем, проверьте, что крышка электрического блока управления внутреннего блока и служебная панель наружного блока закрыты, и установите автоматический выключатель в положение ON (ВКЛ). Если этого не проверить, можно получить удар электрическим током.
- Если возникли какие-либо неполадки в работе кондиционера (например, отобразился код проверки, появился запах гари, слышны странные звуки, кондиционер не охлаждает или не нагревает воздух, подтекает вода), не прикасайтесь к кондиционеру, переведите его сетевой выключатель в положение OFF (ВЫКЛ.) и вызовите квалифицированного специалиста по обслуживанию. До прибытия квалифицированного специалиста по обслуживанию позаботьтесь о том, чтобы электропитание кондиционера не могло быть случайно включено (например, поставьте знак «Не работает» рядом с сетевым выключателем). Продолжение эксплуатации неисправного кондиционера может привести к усугублению механических проблем и стать причиной поражения электрическим током и поломок.
- По окончании работ воспользуйтесь устройством для проверки изоляции (мегаомметром на 500 В) для проверки того, что сопротивление между участком под напряжением и участком не под напряжением (заземлением) равно 1 МОм или более. Если сопротивление мало, это значит, что на стороне пользователя произошла утечка электричества или пробой.
- По завершении установочных работ проверьте, нет ли утечек хладагента, проверьте сопротивление изоляции и слив воды. Затем проведите рабочее испытание, чтобы удостовериться в правильной работе кондиционера.

Пояснения для пользователя

- По завершении установочных работ покажите пользователю, где находится сетевой выключатель. Если пользователь не знает расположения сетевого выключателя, он не сможет выключить его в случае проблем с кондиционером.
- По окончании установочных работ объясните заказчику, как эксплуатировать устройство и ухаживать за ним с помощью руководством по эксплуатации.

Переустановка на другое место

- Переустанавливать кондиционер разрешается только квалифицированному монтажнику (*1) или квалифицированному специалисту по обслуживанию (*1). В результате переустановки кондиционера неквалифицированным лицом возможны пожар, поражение электрическим током, травмы, утечка воды, шум и/или вибрация.
- При выполнении сливных работ нужно остановить компрессор до того, как отключать контур хладагента. Отсоединение трубы хладагента при открытом рабочем клапане и все еще работающем компрессоре приведет к подсосу воздуха или другого газа., в результате чего давление в холодильном цикле достигнет ненормально высокого уровня, что может привести к разрыву контура, травме и другим проблемам.











(*1) См. раздел «Определение квалифицированного монтажника или квалифицированного специалиста по обслуживанию».

ВНИМАНИЕ

В данном кондиционере используется хладагент на основе ГФУ (R32), не разрушающий озоновый слой.

- Поскольку на хладагент R32 легко воздействуют примеси, такие как влага, окисленная пленка, масло и т. д., из-за высокого давления, будьте осторожны, чтобы не допустить попадания влаги, грязи, имеющегося хладагента, масла в холодильных машинах и т. д. в контур охлаждения во время монтажных работ.
 - Для установки необходим специальный инструмент для хладагента R32.
 - Используйте новые и чистые трубопроводные материалы для соединения труб, чтобы в процессе монтажа не смешивались влага и грязь.
 - При использовании имеющихся труб следуйте руководству по установке, прилагаемому к наружному блоку.
-

2 Accessory parts

Part name	Qty	Shape	Usage
Owner's Manual	1		(Hand over to customers) (For other languages that do not appear in this Owner's Manual, please refer to the enclosed CD-ROM.)
Installation Manual	1	This manual	(Hand over to customers) (For other languages that do not appear in this Installation Manual, please refer to the enclosed CD-ROM.)
CD-ROM	1	—	Owner's Manual and Installation Manual
Heat insulating pipe	2		For heat insulation of the pipe connecting section
Installation pattern	1	—	For checking of ceiling opening and the main unit position
Installation gauge	2		For positioning of the ceiling position (To be used with the installation pattern)
Heat insulator	1		For heat insulation of drain connecting section
Eccentric washer	4		For unit hanging
Washer	4		For unit hanging
Hose band	1		For connecting drain pipe
Flexible hose	1		For adjusting core-out of drain pipe
Heat insulator	1		For sealing wiring connection port (for HM56 type)
Seal material	2		For sealing wiring connection port (for HM80, HM110, HM140 type)
Banding band	4		For securing heat insulating pipe

■ Separate sold parts

The Ceiling panel and remote controller are sold separately. For the installation of these products, follow the Installation Manuals supplied with them.

3 Selection of installation place

WARNING

- **Install the air conditioner securely in a location where the base can sustain the weight adequately.**
If the strength is not enough, the unit may fall down resulting in injury.
- **Install the air conditioner at a height 2.5 m or more from the floor.**
If you insert your hands or others directly into the unit while the air conditioner operates, it is dangerous because you may contact with revolving fan or active electricity.

CAUTION

- **Do not install in a location where flammable gas may leaks are possible.**
If the gas leak and accumulate around the unit, it may ignite and cause a fire.

Upon approval of the customer, install the air conditioner in a place that satisfies the following conditions.

- Place where the unit can be installed horizontally.
- Place where a sufficient servicing space can be ensured for safety maintenance and check.
- Place where drained water will not cause any problem.

Avoid installing in the following places.

- Place exposed to air with high salt content (seaside area), or place exposed to large quantities of sulfide gas (hot spring).
(The unit should be used in these places, special protective measures are needed.)
- A restaurant kitchen where a lot of oil is used or place near machines in a factory (Oil adhering to the heat exchanger and resin part (turbo fan) in the indoor unit may reduce the performance, generate mist or dew drop, or deform or damage resin parts.)
- Places where iron or other metal dust is present. If iron or other metal dust adheres to or collects on the interior of the air conditioner, it may spontaneously combust and start a fire.
- Place where organic solvent is used nearby.
- Place close to a machine generating high frequency.
- Place where the discharged air blows directly into the window of the neighbor house. (Outdoor unit)
- Place where noise of the outdoor unit is easily transmitted.
(When the outdoor unit is installed on the boundary with the neighbor, pay due attention to the level of noise.)
- Place with poor ventilation. (Before air duct work, check whether value of fan speed, static pressure and duct resistance are correct.)
- Do not use the air conditioner for special purposes such as preserving food, precision instruments, or art objects, or where breeding animals or growing plants are kept. (This may degrade the quality of preserved materials.)
- Place where any of high-frequency appliances (including inverter devices, private power generators, medical equipment, and communication equipment) and inverter-type fluorescent light is installed.
(A malfunction of the air conditioner, abnormal control, or problems due to noise to such appliances / equipment may occur.)
- When the wireless remote controller is used in a room equipped with an inverter-type fluorescent light or at a place exposed to direct sunlight, signals from the remote controller may not be received correctly.
- Place where organic solvent is used.
- Place near a door or window exposed to humid outside air (Dew drop may form.).
- Place where special spray is used frequently.

■ Installation space

Ensure there is sufficient space to install the unit and to perform maintenance work as and when required. Keep 15 mm or more for clearance between top plate of the indoor unit and the ceiling surface.

Unit: mm

Model RAV-	A mm
HM56 type	271 or more
HM80, HM110, HM140 type	334 or more

<When taking in fresh air>

- When using a flange sold separately to take in fresh air, place the check port on the flange side.

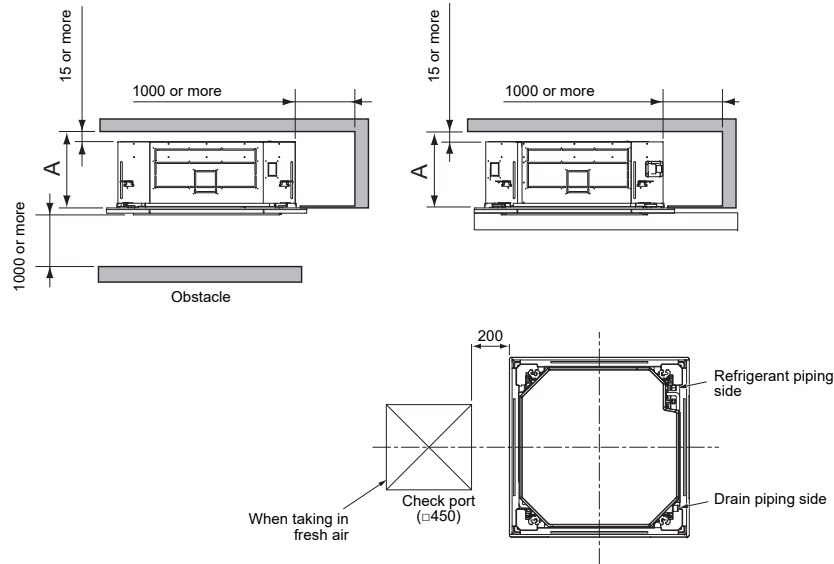

■ Selection of installation place

Continual operation of the indoor unit under high-humidity conditions as described below, dew may condense and water may drop.

Especially, high-humidity atmosphere (dew point temperature: 23°C or more) may generate dew inside the ceiling.

- Unit is installed inside the ceiling with slated roof.
- Unit is installed at a location using inside of the ceiling as fresh air intake path.
- Kitchen

REQUIREMENT

When the humidity inside the ceiling seems to be higher than 80%, attach a heat insulator to the side (top) surface of the indoor unit. (Use a heat insulator with a thickness of 10 mm or more.)

■ Ceiling height

Unit: m

Model RAV-	Installable ceiling height
HM56, HM80 type	Up to 3.8
HM110, HM140 type	Up to 4.6

When the height of the ceiling exceeds the distance of the item Standard / 4-way in below table, the warm air is difficult to reach the floor.

It is necessary to change the setup value of the high ceiling setting or discharge direction.

▼ Height list of ceiling possible to be installed

Unit: m

Model RAV-	HM56			HM80			HM110, HM140			Setup of high ceiling Setup data
	4-way	3-way	2-way	4-way	3-way	2-way	4-way	3-way	2-way	
Standard (Factory default)	2.8	3.2	3.5	3.0	3.3	3.6	3.9	4.2	4.5	0000
High ceiling (1)	3.2	3.5	3.8	3.3	3.5	3.8	4.2	4.4	4.6	0001
High ceiling (3)	3.5	3.8	—	3.6	3.8	—	4.5	4.6	—	0003

REQUIREMENT

- When using the air conditioner with 2-way / 3-way discharge system, a strong wind blows directly if the ceiling height is lower than the standard. Therefore, change the setting switch according to height of the ceiling.
- When high ceiling (1) or (3) is used with 4-way blowing, a draft is easily recognized due to drop of discharge temperature.

The lighting time of the filter sign (notification of filter cleaning) on the remote controller can be changed according to installation conditions.

When it is difficult to obtain satisfactory heating due to location place of the indoor unit or the structure of the room, the detection temperature of heating can be raised.

Refer to "8. Applicable controls" in this manual for the setting procedure.

■ Discharge direction

As shown in the figure below, air discharge directions can be selected according to the shape of the room and the location of the indoor unit installation.

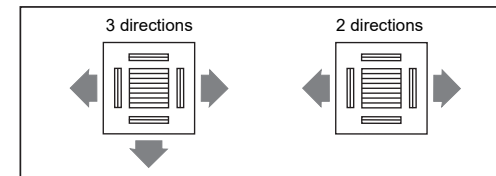

Use an Air discharge direction kit (sold separately) to change discharge directions.

This needs to be set with the wired remote controller during installation.

Discharge directions are limited. Follow the Installation Manual supplied with the Air discharge direction kit.

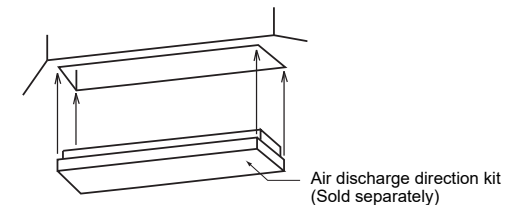

4 Installation

External view

Unit: mm

REQUIREMENT

Strictly comply with the following rules to prevent damage of the indoor units and human injury.

- Do not put any heavy article on the indoor unit. (Even units are packaged)
- Carry in the indoor unit as it is packaged if possible. If carrying in the indoor unit unpacked by necessity, use buffering cloth or other soft cloth to not damage the unit.
- To move the indoor unit, hold the hooking metals (4 positions) only. Do not apply force to the other parts (refrigerant pipe, drain pan, foamed parts, or resin parts).
- Carry the package by two or more persons, and do not bundle it with plastic band at positions other than specified.

Model RAV-	A	B	C
HM56 type	6.4	12.7	256
HM80 type	9.5	15.9	319
HM110 type	9.5	15.9	319
HM140 type	9.5	15.9	319

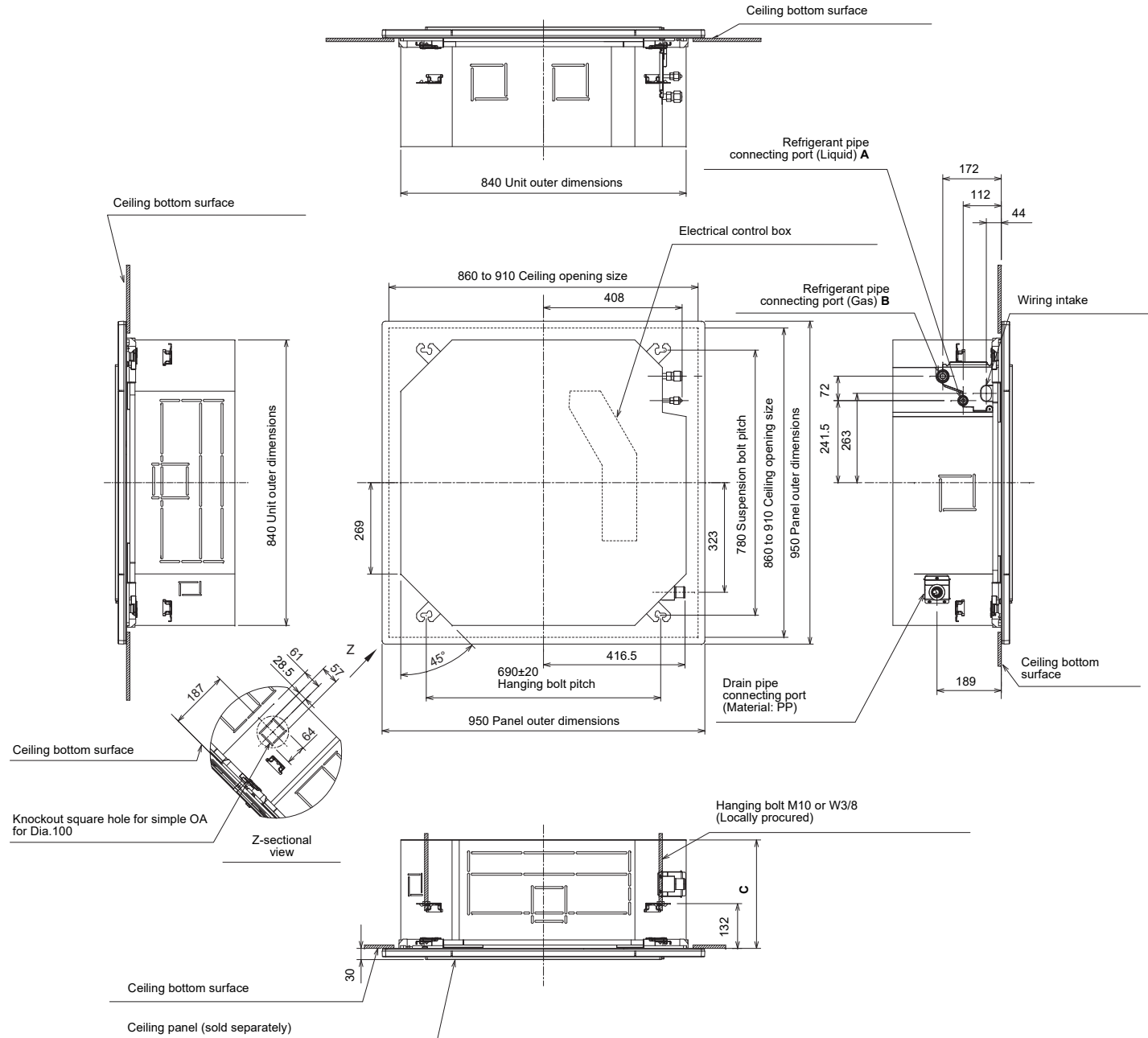

■ Opening a ceiling and installation of hanging bolts

- Consider the piping / wiring after the unit is hung to determine the location of the indoor unit installation and orientation.
- After the location of the indoor unit installation has been determined, open the ceiling and install hanging bolts.
- The dimensions of the ceiling opening and hanging bolt pitches are given in the outline drawing and the attached installation pattern.
- When a ceiling already exists, lay the drain pipe, refrigerant pipe, control wires, and remote controller wires to their connection locations before hanging the indoor unit.

Procure hanging bolts and nuts for installing the indoor unit (these are not supplied).

Hanging bolt	M10 or W3/8	4 pieces
Nut	M10 or W3/8	12 pieces

Using the installation pattern (accessory)

The installation pattern is provided inside the packaging cap.

<For existing ceiling>

Use the installation pattern positioning a ceiling opening and hanging bolts.

<For new ceiling>

Use the installation pattern to position the ceiling opening when a ceiling is hanged.

- After the hanging bolts have been installed, install the indoor unit.
- After loosening the panel mounting screws of the indoor unit, hook them on the four holes in the installation pattern.
- When hanging a ceiling, open the ceiling along the outside dimensions of the installation pattern.

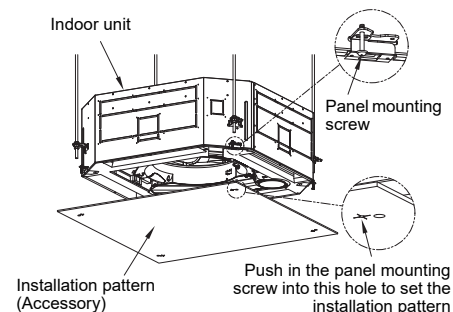

Treatment of ceiling









The ceiling differs according to structure of building. For details, consult your constructor or interior finish contractor.

In the process after the ceiling board has been removed, it is important to reinforce ceiling foundation (frame) and to keep horizontal level of installed ceiling correctly in order to prevent vibration of ceiling board.

- Cut and remove the ceiling foundation.
- Reinforce the cut surface of ceiling foundation, and add ceiling foundation for fixing the end of ceiling board.

Installation of hanging bolt

Use M10 hanging bolts (4 pcs, locally procured). Matching to the existing structure, set pitch according to size in the unit external view as shown below.

New concrete slab	
Install the bolts with insert brackets or anchor bolts.	
	
(Blade type bracket)	(Slide type bracket)
	
Anchor bolt	Pipe hanging anchor bolt
* Rubber	
Steel frame structure	
Use existing angles or install new support angles.	
	
Hanging bolt	Support angle
Existing concrete slab	
Use a hole-in anchors, hole-in plugs, or a hole-in bolts.	
	

Installation of ceiling opening and hanging bolt

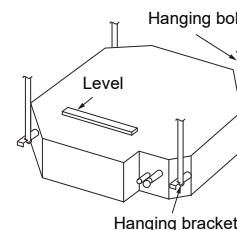

- Attach a nut (locally procured) and the washer (accessory) to each hanging bolt.
- Insert a washer on both sides of the T groove of the hanging bracket of the indoor unit, and hang the indoor unit.
- Check that the four sides of the indoor unit are level using a level gauge (levelness: 5 mm or less).
- Detach the installation gauge (accessory) from the installation pattern.
- Using the installation gauge, check and adjust the positional relation between the indoor unit and the ceiling opening (1) (10 - 35 mm: 4 sides) and the hanging-up height (2) (12 - 17 mm: 4 corners). (How to use the installation gauge is printed on the gauge.)

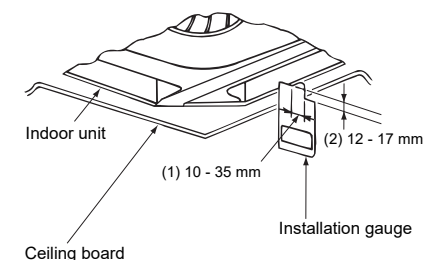
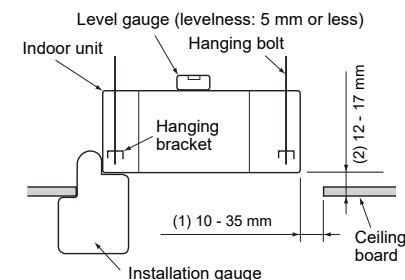
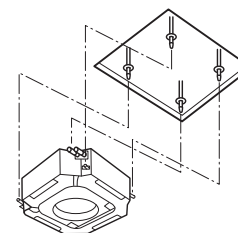
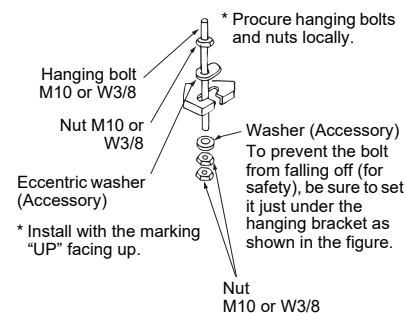

CAUTION

Before installation of the indoor unit, remove the tape that holds the fan and bell mouth. Running the unit without removing the tape may damage the fan motor.

■ Installation of ceiling panel (Sold separately)

Install the ceiling panel according to Installation Manual attached with it after piping / wiring work has completed.

Check that installation of indoor unit and ceiling opening part is correct, and then install it.

REQUIREMENT

- Joint the connecting sections of ceiling panel, ceiling surface, ceiling panel and indoor unit closely. Any gap between them will cause air leakage and the generate condensation or water leakage.
- Remove the adjust corner caps at the four corners of the ceiling panel, and then install the ceiling panel onto the indoor unit.
Also, check that the claws are securely fit when returning the adjust corner caps to its original position.
- * Improper fitting of the claws may cause water leakage.

■ Installation of wired remote controller (Sold separately)

For installation of the wired remote controller, follow the Installation Manual attached with the remote controller.

- Pull out the remote controller cord together with the refrigerant pipe or drain pipe.
Pass the remote controller cord through upper side of the refrigerant pipe and drain pipe.
- Do not leave the remote controller at a place exposed to the direct sunlight and near a stove.

■ Installation of wireless remote controller (Sold separately)

The signal receiving unit of indoor unit can receive a signal by distance within approx. 7 m. Based upon it, determine a place where the remote controller is operated and the installation place.

- Operate the remote controller, confirm that the indoor unit receives a signal surely, and then install it.
- Keep 1 m or more from the devices such as television.
(Disturbance of image or noise may generate.)
- To prevent a malfunction and reception failure of the remote controller, select a place where it is not influenced by a fluorescent light, equipment (Electronic whiteboard etc.) emitting infrared rays, or direct sunlight.
- Switching the setting (A-B selection) of the wireless remote controllers and the signal receiving unit enables two indoor units installed in a room to be respectively operated using two wireless remote controllers.

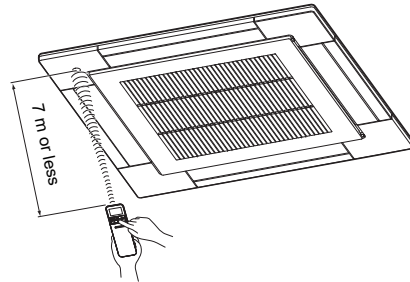

5 Drain piping

⚠ CAUTION

Following the Installation Manual, perform the drain piping work so that water is properly drained, and apply a heat insulation so as not to cause a dew drop.
Inappropriate piping work may result in water leakage in the room and wet of furniture.

■ Piping / Heat insulating material

Require the following materials for piping and heat insulating at site.

Piping	Hard polyvinyl chloride pipe socket for VP25
	Hard vinyl chloride pipe VP25 (Outer diameter: 32 mm)
Heat insulator	Foam polyethylene: Thickness 10 mm or more

■ Flexible hose

Use the attached flexible hose to adjust center discrepancy of the hard vinyl chloride pipe or to adjust the angle.

- Do not use the flexible hose as stretched, or do not deform it more extent than that in the following figure.
- Be sure to fix the soft end of the flexible hose with the attached hose band.
- Use the flexible hose on a horizontal level.

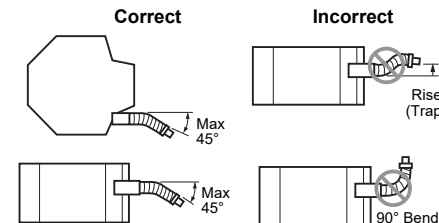

REQUIREMENT

- Perform heat insulation of the drain pipes of the indoor unit.
- Perform heat insulation of the connecting part with the indoor unit.
An incomplete heat insulation causes dew drop.
- Set the drain pipe with downward slope (1/100 or more), and do not make swelling or trap on the piping. It may cause an abnormal sound.
- For length of the traversing drain pipe, restrict to 20 m or less.
In case of a long pipe, provide support brackets with interval of 1.5 - 2 m in order to prevent waving.

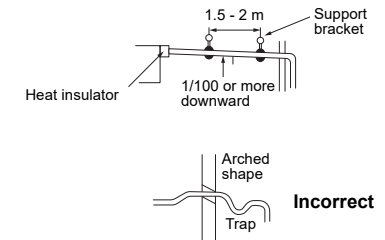

- Set the collective piping as shown in the below figure.

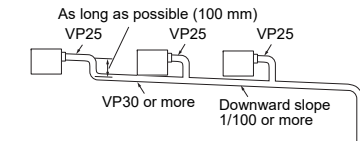

- Do not apply force to the connecting part of the drain pipe.
- The hard vinyl-chloride pipe cannot be directly connected to the drain pipe connecting port of the indoor unit.
For connection with the drain pipe connecting port, fix the attached flexible hose with the hose band, otherwise a damage or water leak is caused on the drain pipe connecting port.

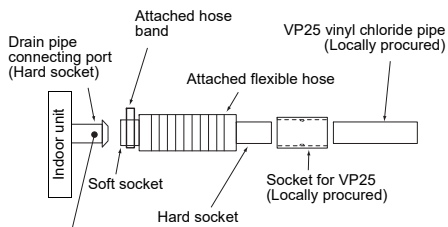

Adhesive inhibited:

Use the attached flexible hose and hose band for connecting the drain hose to the clear drain socket. If applying the adhesive, socket will be damaged and cause water leakage.

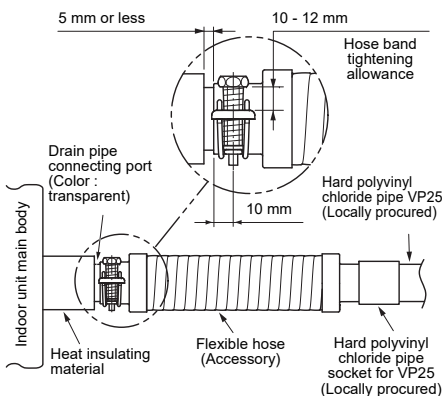

■ Connecting drain pipe

- Connect a hard socket (locally procured) to the hard socket of the attached supplied flexible hose.
- Connect a drain pipe (locally procured) to the connected hard socket.

REQUIREMENT

- Connect hard vinyl chloride pipes securely using an adhesive for vinyl chloride to avoid water leakage.
- It takes some time until the adhesive is dried and hardened (refer to the manual of the adhesive). Do not apply stress to the joint with the drain pipe during this time period.

■ Drain up

When a down-gradient cannot be secured for the drainpipe, drain-up piping is possible.

- The height of the drain pipe must be 850 mm or less from the bottom of the ceiling.
- Take the drain pipe out of the drain pipe joint with the indoor unit in 300 mm or less, and bend up the pipe vertically.
- Immediately after the pipe is bent up vertically, lay the pipe making a down-gradient.
- Set downward grading immediately after raising up vertically.

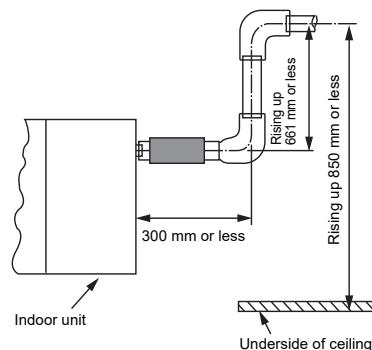

■ Check the draining

In the test run, check that water drain is properly performed and water does not leak from the connecting part of the pipes.

Check that there are no abnormal motor sounds from the drain pump as well.

Check draining also when installed in heating period. By using a pitcher or hose, pour water (1500 - 2000 cc) into the discharge port before installation of the ceiling panel.

Pour water gradually so that water does not spread on the motor of the drain pump.

⚠ CAUTION

Pour water gently so that it does not spread around inside the indoor unit, which may cause a malfunction.

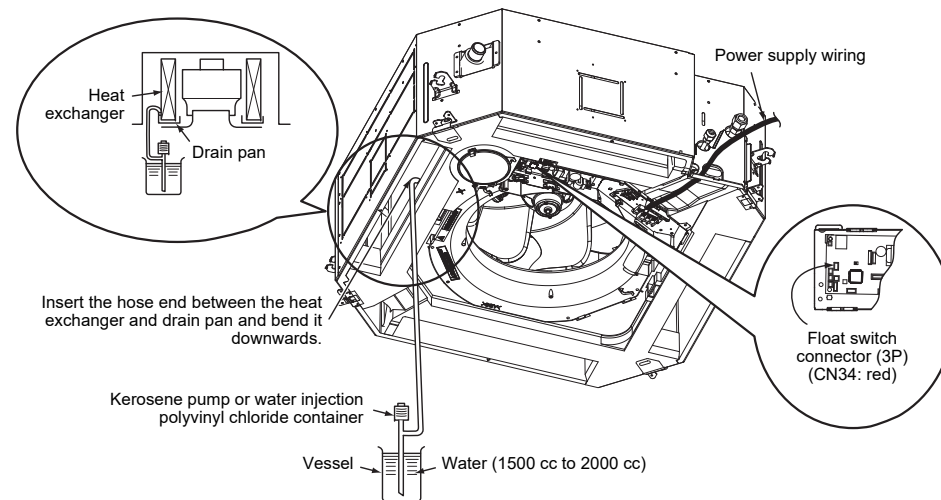

- After the electric work has finished, pour water during COOL mode operation.
- If the electric work has not yet finished, pull out the float switch connector (CN34: Red) from the electrical control box, and check draining by plugging the single phase 220 - 240 V power to the terminal blocks ① and ②.

If doing so, the drain pump motor operates. (Never apply 220-240 V to Ⓐ or Ⓑ, otherwise a trouble of P.C. board occurs.)

- Test water drain while checking the operation sound of the drain pump motor.

(If the operation sound changes from continuous sound to intermittent sound, water is normally drained.)

After the check, the drain pump motor runs, connecting the float switch connector. (In case of check by pulling out the float switch connector, be sure to return the connector to the original position.)

■ Perform heat insulating

- As shown in the figure, cover the flexible hose and hose band with the attached heat insulator up to the bottom of the indoor unit without gap.
- Cover the drain pipe seamlessly with a heat insulator to be procured locally so that it overlaps with the attached heat insulator of the drain connecting section.

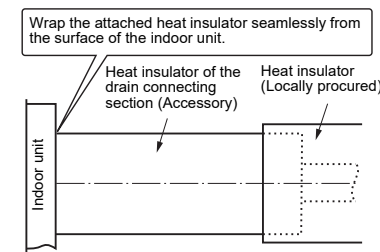

- * Direct the slits and seams of the heat insulator upward to avoid water leakage.

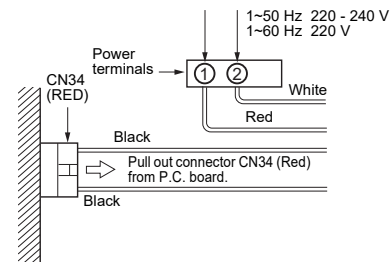

6 Refrigerant piping

CAUTION

Use flare nuts that are included with the unit. Using different flare nuts may cause refrigerant gas leakage.

Refrigerant piping

Use the following item for the refrigerant piping.

Material: Seamless phosphorous deoxidized copper pipe.

6.35, 9.52, 12.7 Wall thickness 0.8 mm or more
15.88 Wall thickness 1.0 mm or more

REQUIREMENT

When the refrigerant pipe is long, provide support brackets at intervals of 2.5 - 3 m to clamp the refrigerant pipe. Otherwise, abnormal sound may be generated.

CAUTION

IMPORTANT 4 POINTS FOR PIPING WORK

1. Reusable mechanical connectors and flared joints are not allowed indoors. When mechanical connectors are reused indoors, sealing parts shall be renewed. When flared joints are reused indoors, the flare part shall be re-fabricated.
2. Tight connection (between pipes and unit)
3. Evacuate the air in the connecting pipes by using VACUUM PUMP.
4. Check the gas leakage. (Connected points)

Pipe size

Model name	RAV-	HM56 type	HM80, HM110, HM140 type
Pipe size	Gas side	12.7 mm	15.9 mm
	Liquid side	6.4 mm	9.5 mm

Permissible piping length and height difference

They vary according to the outdoor unit.

For details, refer to the Installation Manual attached to the outdoor unit.

Flaring

- Cut the pipe with a pipe cutter. Remove burrs completely. Remaining burrs may cause gas leakage.
- Insert a flare nut into the pipe, and flare the pipe. As the flaring sizes of R32 or R410A differ from those of refrigerant R22, the flare tools newly manufactured for R32 or R410A are recommended. However, the conventional tools can be used by adjusting projection margin of the copper pipe.

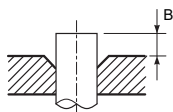

Projection margin in flaring: B (Unit: mm)

Rigid (Clutch type)

Outside diameter size	R32 or R410A tool used	Conventional tool used
6.4, 9.5	0 - 0.5	1.0 - 1.5
12.7, 15.9		

Flaring dia. meter size: A (Unit: mm)

Outside diameter size	A ⁺⁰ _{-0.4}
6.4	9.1
9.5	13.2
12.7	16.6
15.9	19.7

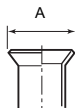

CAUTION

- Do not scratch the inner surface of the flared part when removing burrs.
- Flare processing under the condition of scratches on the inner surface of flare processing part will cause refrigerant gas leak.
- Check that the flared part is not scratched, deformed, stepped, or flattened, and that there are no chips adhered or other problems, after flare processing.
- Do not apply refrigerating machine oil to the flare surface.

Tightening connection

CAUTION

Do not apply excessive torque. Otherwise, the nut may crack depending on the conditions.

Unit: N•m

Outside diameter size	Tightening torque
6.4 mm	14 - 18
9.5 mm	34 - 42
12.7 mm	49 - 61
15.9 mm	68 - 82

Tightening torque of flare pipe connections
 Incorrect connections may cause not only a gas leak, but also a trouble of the refrigeration cycle.

Align the centers of the connecting pipes and tighten the flare nut as far as possible with your fingers. Then tighten the nut with a spanner and torque wrench as shown in the figure.

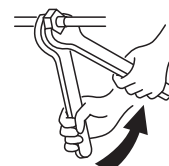

Work using two spanner

REQUIREMENT

Tightening with an excessive torque may crack the nut depending on installation conditions. Tighten the nut within the specified tightening torque.

Evacuation

Perform vacuuming from the charge port of valve of the outdoor unit by using a vacuum pump.

For details, follow to the Installation Manual attached to the outdoor unit.

- Do not use the refrigerant sealed in the outdoor unit for evacuation.

REQUIREMENT

For the tools such as charge hose, use those manufactured exclusively for R32 or R410A.

Refrigerant amount to be added

For addition of the refrigerant, add refrigerant "R32" referring to the attached Installation Manual of outdoor unit.

Use a scale to charge the refrigerant of specified amount.

REQUIREMENT

- Charging an excessive or too little amount of refrigerant causes a trouble of the compressor. Charge the refrigerant of specified amount.
- A personnel who charged the refrigerant should write down the pipe length and the added refrigerant amount in the F-GAS label of the outdoor unit. It is necessary to fix the compressor and refrigeration cycle malfunction.

Open the valve fully

Open the valve of the outdoor unit fully. A 4 mm-hexagonal wrench is required for opening the valve.

For details, refer to the Installation Manual attached to the outdoor unit.

Gas leak check

Check with a leak detector or soap water whether gas leaks or not, from the pipe connecting section or cap of the valve.

REQUIREMENT

Use a leak detector manufactured exclusively for HFC refrigerant (R32, R410A, R134a).

Heat insulation process

Apply heat insulation for the pipes separately at liquid side and gas side.

- For the heat insulation to the pipes at gas side, use the material with heat-resisting temperature 120°C or higher.
- Apply the attached heat insulation to the pipe connecting section of the indoor unit securely without gap.

REQUIREMENT

- Apply the heat insulation to the pipe connecting section of the indoor unit securely up to the root without exposure of the pipe. (The pipe exposed to the outside causes water leak.)
- Wrap heat insulator with its slits facing up (ceiling side).

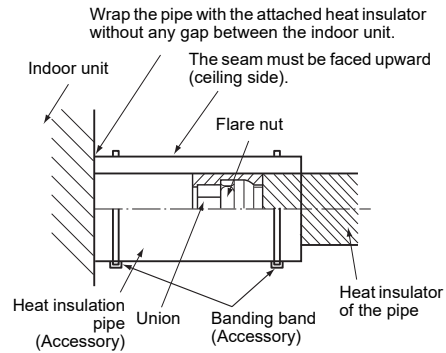

7 Electrical connection

⚠ WARNING

- **Use the specified wires for wiring connect the terminals. Securely fix them to prevent external forces applied to the terminals from affecting the terminals.**
Incomplete connection or fixation may cause a fire or other trouble.
- **Connect earth wire. (grounding work)**
Incomplete earthing cause an electric shock.
Do not connect earth wires to gas pipes, water pipes, lightning conductor or telephone earth wires.
- **Appliance shall be installed in accordance with national wiring regulations.**
Capacity shortage of power circuit or incomplete installation may cause an electric shock or a fire.
- **Under no circumstances, the power supply wire or the indoor and outdoor connecting wire must not be connected in the middle (Connection using a solderless terminal etc.)**
Connection trouble in the places where the wire is connected in the middle may give rise to smoking and/or a fire.

⚠ CAUTION

- For power supply specifications, follow the Installation Manual of outdoor unit.
 - Do not connect 220 – 240 V power to the terminal blocks (Ⓐ, Ⓑ) for control wiring. Otherwise, the system will fail.
 - Do not damage or scratch the conductive core and inner insulator of power and system interconnection wires during peeling them.
 - Perform the electric wiring so that it does not come to contact with the high-temperature part of the pipe. The coating may melt resulting in an accident.
- Do not turn on the power of the indoor unit until vacuuming of the refrigerant pipes completes.

■ Wiring specifications

Indoor / Outdoor connecting wires specifications

Indoor unit power supplied from outdoor unit

- The outdoor unit power supply patterns vary on models.

Indoor unit power supply	1~50 Hz 220 - 240 V 1~60 Hz 220 V
--------------------------	--------------------------------------

Indoor / Outdoor connecting wires*	4 × 1.5 mm ² or more (H07 RN-F or 60245 IEC 66)*	Up to 70 m
------------------------------------	---	------------

*Number of wire × wire size

*Including earth line

Remote controller wiring

Remote controller wiring, remote controller inter-unit wiring	Wire size: 2 × 0.5 to 2.0 mm ²	
Total wire length of remote controller wiring and remote controller inter-unit wiring = L + L1 + L2 + ... Ln	In case of wired type only	Up to 500 m
	2 remote controllers	Up to 300 m
Total wire length of remote controller inter-unit wiring = L1 + L2 + ... Ln	In case of wireless type included	Up to 400 m
		Up to 200 m

* The remote controller wiring length differs depending on the remote controller used. For details, refer to the Installation Manual attached to the remote controller.

⚠ CAUTION

The remote controller wire and Indoor / Outdoor connecting wires cannot be parallel to contact each other and cannot be stored in the same conduits. If doing so, a trouble may be caused on the control system due to noise or other factor.

■ Communication type

TU2C-Link can be used with these models.

If the indoor unit and the connected remote controller / remote sensor are all TU2C-Link models, TU2C-Link communication will be performed automatically.

For details of communication type, refer to the following table.

Communication type and model names

Communication type	TU2C-Link	TCC-Link
Indoor unit	RAV-HM *** series model	Other than RAV-HM *** series
Wired remote controller	RBC-A **U*** ↑ This letter indicates U series model.	Other than U series
Wireless remote controller kit & receiver unit	RBC-AXU*** ↑ This letter indicates U series model.	Other than U series
Remote sensor	TCB-TC **U*** ↑ This letter indicates U series model.	Other than U series

⚠ CAUTION

In the following cases, change the communication type to TCC-Link with the wired remote controller by referring to the procedure of Communication type procedure of "8. Applicable controls" for normal operation.

- When performing group control in combination with the indoor unit dedicated to TCC-Link (other than RAV-HM *** series).
- When connecting to the central control device dedicated to TCC-Link.

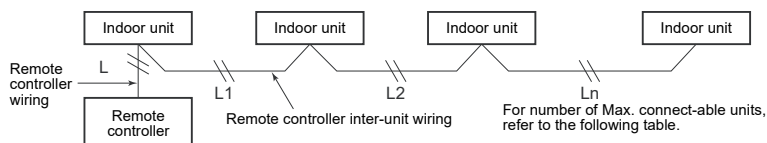

Max. number of connect-able indoor units, and communication type

Indoor unit	Unit type			
	RAV-HM ***	RAV-HM ***	*	*
Remote controller	U series	*	U series	*
Remote sensor				
Communication type	TU2C-Link	TCC-Link		
Max. number of connect-able units	16	8		

*: Other than RAV-HM *** and U series

■ Wiring between indoor unit and outdoor unit

1. Figure below shows the wiring connections between the indoor and outdoor units and between the indoor units and remote controller. The wires indicated by the broken lines or dot-and-dash lines are provided at the locally.
2. Refer to the both indoor and outdoor unit wiring diagrams.
3. The power of the indoor unit is supplied from the outdoor unit.

Wiring diagram

Single system

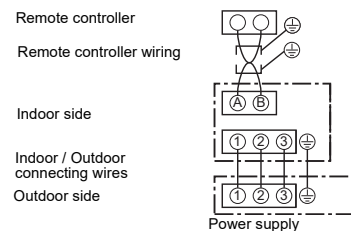

Simultaneous twin system

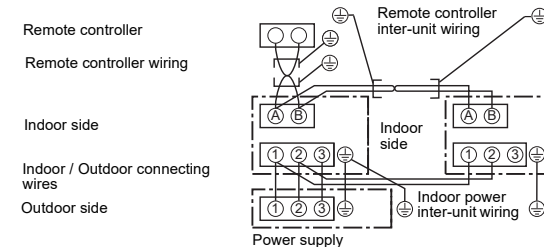

* Use 2-core shield wire (MVVS 0.5 to 2.0 mm² or more) for the remote controller wiring in the simultaneous twin systems to prevent noise problems. Connect both ends of the shield wire to earth leads.

* Connect earth wires for each indoor unit in the simultaneous twin systems.

■ Wiring connection

REQUIREMENT

- Connect the wires matching the terminal numbers. Incorrect connection causes a trouble.
- Route the wire through the wire connection port of the indoor unit.
- The low-voltage circuit is provided for the control wire and remote controller wire. (Do not connect the high-voltage circuit.)

HM56 type

1. Remove screw A for the fixation of the electrical control box cover and loosened screw B. Slide the cover inside so that the hook part can be removed (The electrical control box cover remain being hooked on the hinge.).
2. Connect the Indoor / Outdoor connecting wires and remote controller wiring to the terminal board of the electrical control box.
3. Tighten the screws of the terminal board securely, and fix the wires with the cord clamp attached to the electrical control box. (Do not apply tension to the connecting section of the terminal board.)
4. Seal the wiring connecting port with the attached heat insulation material. (Otherwise, this may result in condensation.)
5. Attach the cover of the electrical control box without pinching the wires. (Mount the cover after wiring the ceiling panel.)

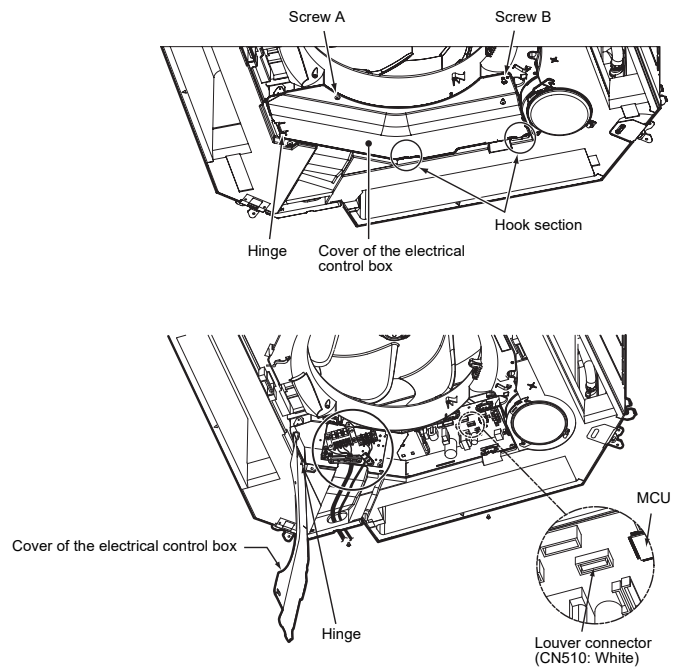

▼ Heat insulation of wiring connecting port

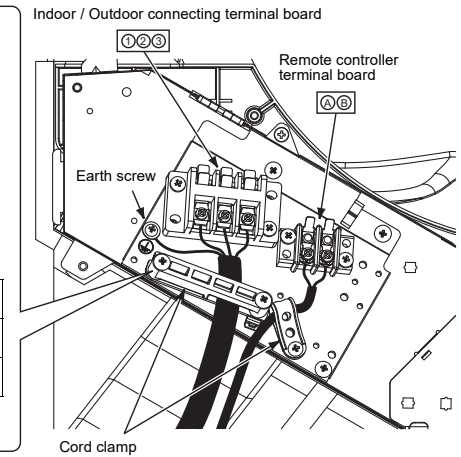
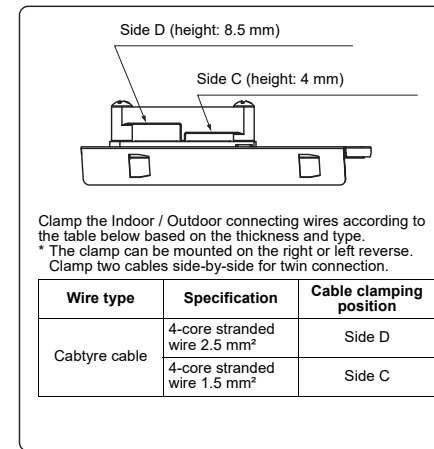
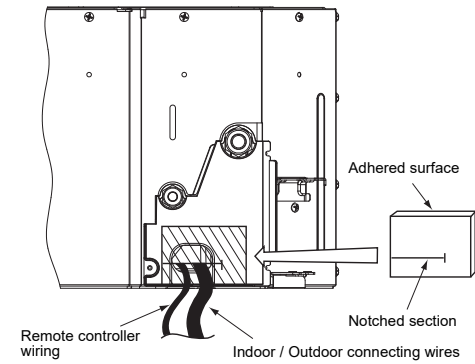

HM80, HM110, HM140 type

1. Remove screw A for the fixation of the electrical control box cover and loosened screw B. Slide the cover inside so that the hook part can be removed (The electrical control box cover remain being hooked on the hinge.)
2. Remove the wiring cover mounting screws (2 locations), and a wiring cover is removed.
3. Connect the Indoor / Outdoor connecting wires and remote controller wiring to the terminal board of the electrical control box.
4. Tighten the screws of the terminal board securely, and fix the wires with the cord clamp attached to the electrical control box. (Do not apply tension to the connecting section of the terminal board.)
5. Seal the clearances of each wiring connecting port with the attached seal material. (Cut the redundant portion of the seal material.)
6. Attach the wiring cover to the original position and fix it with two screws without pinching the wires.
7. Attach the cover of the electrical control box without pinching the wires. (Mount the cover after wiring the ceiling panel.)

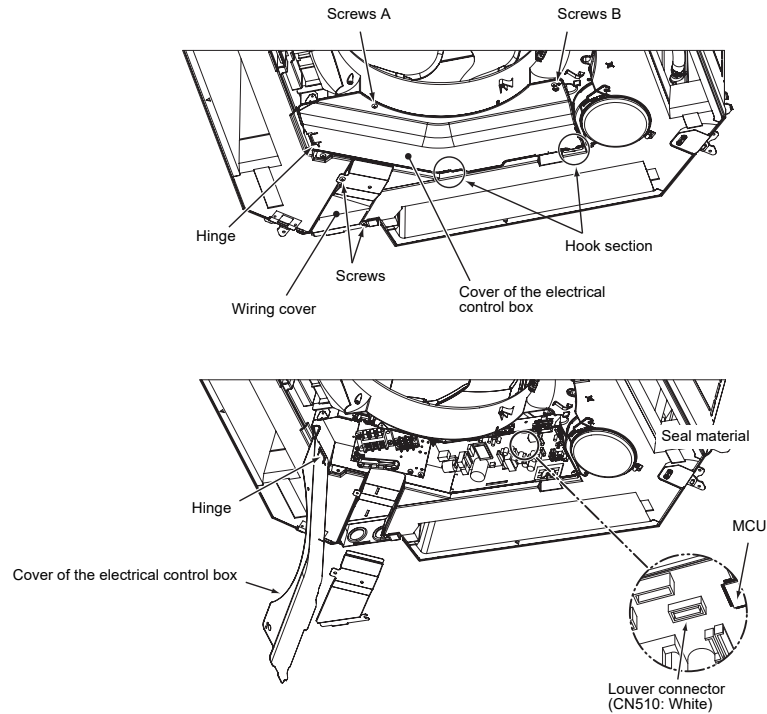

▼ Seal material of wiring connecting port

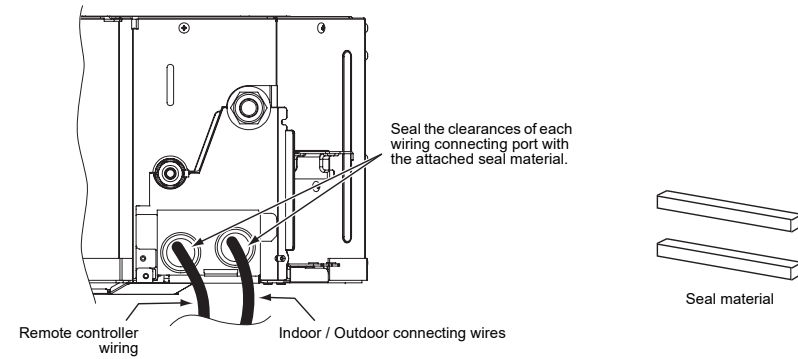

Side D (height: 8.5 mm)
Side C (height: 4 mm)

Clamp the Indoor / Outdoor connecting wires according to the table below based on the thickness and type.
* The clamp can be mounted on the right or left reverse.
Clamp two cables side-by-side for twin connection.

Wire type	Specification	Cable clamping position
Cable type	4-core stranded wire 2.5 mm ²	Side D
	4-core stranded wire 1.5 mm ²	Side C

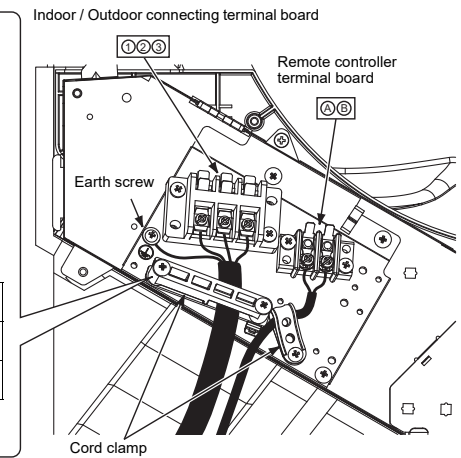

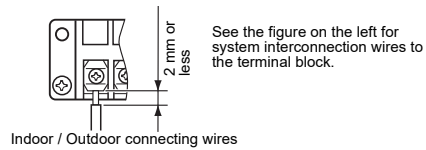
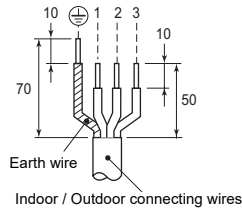

Remote controller wiring

Strip off approx. 9 mm the wire to be connected.

Wiring diagram

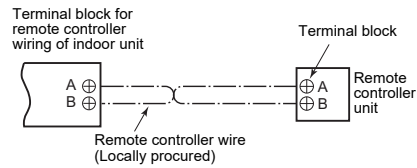

Wiring on the ceiling panel

As per the Installation Manual of the ceiling panel, connect the connector (20P: White) of the ceiling panel to the connector (CN510: White) onto the P.C. board within the electrical control box.

8 Applicable controls

- For using the wired remote controller RBC-AMS55E *, refer to the Owner's Manual attached to the wired remote controller.

REQUIREMENT

- When you use this air conditioner for the first time, it takes approx. 5 minutes until the remote controller becomes available after power-on. This is normal.
<When power is turned on for the first time after installation>
 It takes **approx. 5 minutes** until the remote controller becomes available.

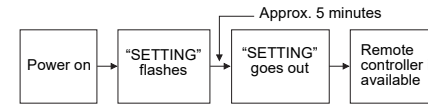

<When power is turned on for the second (or later) time>

It takes **approx. 1 minute** until the remote controller becomes available.

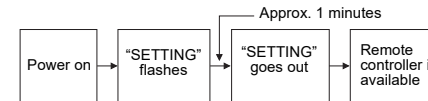

- Normal settings were made when the indoor unit was shipped from factory. Change the indoor unit settings as required.
- Use the wired remote controller to change the settings.
 - * The settings cannot be changed using the wireless remote controller, sub remote controller, or remote-controller-less system (for central remote controller only). Therefore, install the wired remote controller to change the settings.

Applicable controls setup (settings at the site)

Remote controller model name:

RBC-ASCU1*

Basic procedure

Be sure to stop the air conditioner before making settings.

(Change the setup while the air conditioner is not working.)

CAUTION

Set only the Code No. shown in the following table: Do NOT set any other Code No. If a Code No. not listed is set, it may not be possible to operate the air conditioner or other trouble with the product may result.

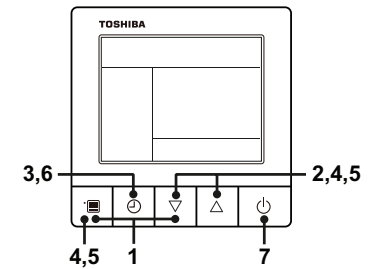

1 Push and hold menu button and [▽] setting button simultaneously for 10 seconds or more.

- After a while, the display flashes as shown in the figure. "ALL" is displayed as indoor unit numbers during initial communication immediately after the power has been turned on.

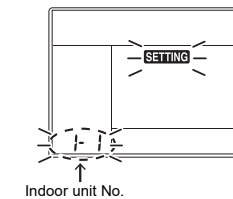

2 Each time [▽][△] setting button is pushed, indoor unit numbers in the group control change cyclically. Select the indoor unit to change settings for.

- The fan of the selected indoor unit runs and the louvers start swinging. The indoor unit can be confirmed for which to change settings.

3 Push OFF timer button to confirm the selected indoor unit.

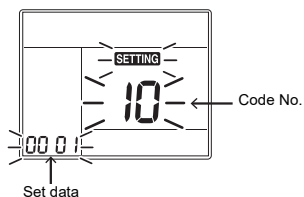

4 Push the menu button to make Code No. [**] flash. Change Code No. [**] with [▽][△] setting button.

5 Push the menu button to make Set data [****] flash. Change Set data [****] with [▽][△] setting button.

6 Push OFF timer button to complete the set up.

- To change other settings of the selected indoor unit, repeat from Procedure 4.

7 When all the settings have been completed, push ON/OFF button to finish the settings. (Return to the normal mode)

"SETTING" flashes and then the display content disappears and the air conditioner enters the normal stop mode. (The remote controller is unavailable while "SETTING" is flashing.)

- To change settings of another indoor unit, repeat from Procedure 1.

■ Installing indoor unit on high ceiling

When an indoor unit is installed on a ceiling higher than the standard height, make the high ceiling setting for fan speed adjustment.

Follow to the basic operation procedure (1 → 2 → 3 → 4 → 5 → 6 → 7).

- Specify [5d] for the Code No. in Procedure 4.
- Select the set data for Procedure 5 from the "Height list of ceiling possible to be installed" table in this manual.

Set data	Ceiling height
0000	Standard (Factory default)
0001	High ceiling (1)
0003	High ceiling (3)

Remote controller-less setting

Change the high-ceiling setting with the DIP switch on the P.C. board.

- * Once the Set data has been changed, though it can be freely set to "0001" or "0003", to reset it to "0000" (factory default), it need changing using remote controller (sold separately). After set data change, an air conditioner is operated. After setting has been completed, restart the air conditioner.

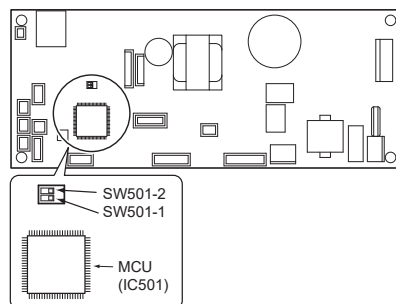

Set data	Ceiling height	SW501-1	SW501-2
0000	Standard (Factory default)	OFF	OFF
0001	High ceiling (1)	ON	OFF
0003	High ceiling (3)	OFF	ON

◆ To restore the factory defaults

To return the DIP switch settings to the factory defaults, set SW501-1 and SW501-2 to OFF, connect a separately sold wired remote controller, and then set the data of Code No. [5d] to "0000".

■ To secure better effect of heating

When it is difficult to obtain satisfactory heating due to installation place of the indoor unit or structure of the room, the detection temperature of heating can be raised. Also use a circulator or other machinery to circulate heat air near the ceiling.

Follow to the basic operation procedure

- (1 → 2 → 3 → 4 → 5 → 6 → 7).
- Specify [06] for the Code No. in Procedure 4.
- For the set data in Procedure 5, select the set data of shift value of detection temperature to be set up from the following table.

Set data	Detection temperature shift value
0000	No shift
0001	+1°C
0002	+2°C (Factory default)
0003	+3°C
0004	+4°C
0005	+5°C
0006	+6°C

■ Filter sign setting

According to the installation condition, the filter sign term (Notification of filter cleaning) can be changed.

Follow to the basic operation procedure (1 → 2 → 3 → 4 → 5 → 6 → 7).

- Specify [01] for the Code No. in Procedure 4.
- For the set data in Procedure 5, select the set data of filter sign term from the following table.

Set data	Filter sign term
0000	None
0001	150 H
0002	2500 H (Factory default)
0003	5000 H
0004	10000 H

- The filter sign may be unavailable depending on the remote controllers.

■ How to set up swing type

The swing type of the louver can be selected.

Follow to the basic operation procedure (1 → 2 → 3 → 4 → 5 → 6 → 7).

- Specify [F0] for the Code No. in Procedure 4.
- Select the following data for the set data in Procedure 5.

Set data	Swing of louvers
0001	Standard swing (Factory default)
0002	Dual swing
0003	Cycle swing

• About "Dual swing"

"Dual" means that louvers 01 and 03 are directed and swing in one direction and louvers 02 and 04 are directed and swing in the opposite direction. (When louvers 01 and 03 are directed downward, louvers 02 and 04 are directed horizontally.)

• About "Cycle swing"

The four louvers swing independently at respective timings.

⚠ CAUTION

Do not set the swing set data to "0000". (This setting may cause a failure of the louvers.)

■ How to set up louver lock (No swing)

A position of the individual louvers (four directions) can be locked.

Follow to the basic operation procedure (1 → 2 → 3 → 4 → 5 → 6 → 7).

- Specify [F1], [F2], [F3], or [F4] for the Code No. in Procedure 4.
- Select the following data for the set data in Procedure 5.



- * When (4) or (5) is selected, dew drop may occur during cooling mode.

- When the setting has been determined, lights up.

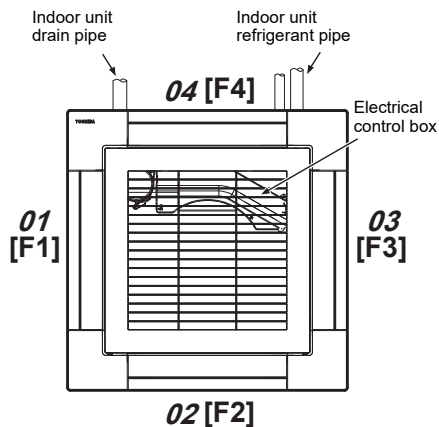

How to cancel louver lock

Set the wind direction to "0000" of the louver lock setup procedure above.



Setting data 0000

- When the setting is cancelled, goes out. Other operations are the same as those in "How to set up louver lock (No swing)".

To select horizontal wind direction

The louver positions at cooling can be changed from the smudge reducing position to the cold draft-less position.

Follow to the basic operation procedure (1 → 2 → 3 → 4 → 5 → 6 → 7).

- For the Code No. in Procedure 4, specify [45].
- Select the following data for the set data in Procedure 5.

Set data	Wind direction setting
0000	Smudge reducing position (Air direction to reduce ceiling contamination) [Factory default]
0002	Cold draft-less position (Air direction to control cold air fall)

Remote controller sensor

The temperature sensor of the indoor unit senses room temperature usually. Set the remote controller sensor to sense the temperature around the remote controller. Select items following the basic operation procedure (1 → 2 → 3 → 4 → 5 → 6 → 7).

- Specify [32] for the Code No. in Procedure 4.
- Select the following data for the set data in Procedure 5.

Set data	Remote controller sensor
0000	Not in use (Factory default)
0001	In use

When flashes, the remote controller sensor is defective.

Select the set data "0000" (not in use) or replace the remote controller.

Communication type

When connecting to an indoor unit or central controller dedicated to TCC-Link, it is necessary to change to TCC-Link.

Follow to the basic operation procedure (1 → 2 → 3 → 4 → 5 → 6 → 7).

- Specify [FC] for the Code No. in Procedure 4.
- Select the set data "0000" (TCC-Link) in Procedure 5.

Set data	Communication type
0000	TCC-Link
0004	TU2C-Link (Factory default)

Fan speed setting when thermostat-OFF in cooling mode

Set the fan speed when the room temperature reaches the set temperature in the cooling mode.

Follow to the basic operation procedure (1 → 2 → 3 → 4 → 5 → 6 → 7).

- Specify [9A] for the Code No. in Procedure 4.
- Select the following data for the set data in Procedure 5.

Set data	Fan speed when thermostat-OFF in cooling mode
0000	Remote controller setting
0001	Extremely low speed (UL) (Factory default)

8°C operation

Pre-heating operation can be set for cold regions where room temperature drops to below zero.

Follow to the basic operation procedure (1 → 2 → 3 → 4 → 5 → 6 → 7).

- Specify [d1] for the Code No. in Procedure 4.
- Select the following data for the set data in Procedure 5.

Set data	8°C Operation setting
0000	None (Factory default)
0001	8°C Operation setting

Installing optional parts

When installing optional parts, data setup may be required with remote controller.

Be sure to set the data, according to Installation Manual for optional parts.

Information

The following functions require a connection with the RBC-AMTU*** and RBC-AMSU*** remote controller. For details, refer to the manual included with the remote controller.

- Individual unit selection during group operation
- Individual setting of louver position (wind direction)
- Swing type setting
- Louver lock (no swing) setting
- Energy saving operation (Power saving operation)
- Notification of filter cleaning time

Others

The following functions can be used with this model. Refer to the Service Manual for more information.

- Rotation / backup operation
- Free cooling
- Secondary heating
- Power shift

■ Group control

Simultaneous twin system

A combination with an outdoor unit allows simultaneous ON / OFF operation of the indoor units. The following system patterns are available.

- Two indoor units for the twin system

▼ Twin system

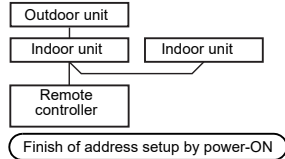

- For wiring procedure and wiring method, follow to the "Electrical connection" in this manual.
- When the power supply has been turned on, the automatic address setup starts and which indicates that address is being set up flashes on the display part.
During setup of automatic address, the remote controller operation is not accepted.

Required time up to the finish of automatic addressing is approx. 5 minutes.

Group control for system of multiple units

One group can control up to 16 (TU2C-Link) or 8 (TCC-Link) indoor units with one remote controller. (Refer to the Wiring specifications)

▼ Group control in single system

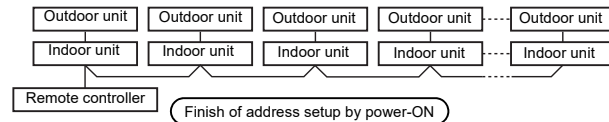

- For wiring procedure and wiring method of the individual line (Identical refrigerant line) system, follow to "Electrical connection".
- Wiring between lines is performed in the following procedure.
Connect the terminal block (A/B) of the indoor unit connected with a remote controller to the terminal blocks (A/B) of the indoor units of other indoor units by wiring the inter-unit wire of the remote controller.
- When the power supply has been turned on, the automatic address setup starts and which indicates that address is being set up flashes on the display part in about 3 minutes. During setup of automatic address, the remote controller operation is not accepted.

Required time up to the finish of automatic addressing is approx. 5 minutes.

NOTE

In some cases, it is necessary to change the address manually after setup of the automatic address according to the system configuration of the group control.

- The follow mentioned system configuration is a case when complex systems in which systems of the simultaneous twin unit is controlled as a group by a remote controller.

(Example) Group control for complex system

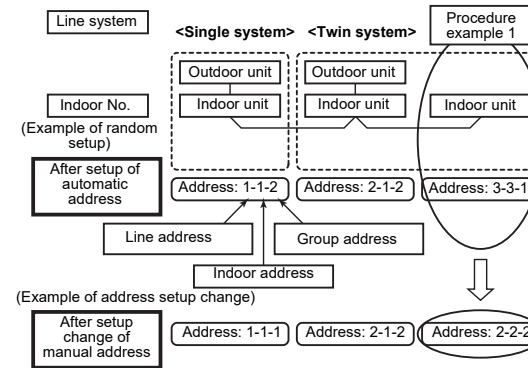

The above address is set by the automatic addressing when the power is turned on. However, line addresses and indoor addresses are set randomly. For this reason, change the setting to match line addresses with indoor addresses.

■ Manual address setting

- 1 Push and hold menu button and [▽] setting button simultaneously for 10 seconds or more.
- 2 Push OFF timer button to confirm the selected indoor unit.

<Line address>

- 3 Push the menu button until the Code No. flashes. And using the [▽] [△] buttons, specify the Code No. **[12]**.
- 4 Push the menu button until the Set data flashes. And using the [▽] [△] buttons, set a line address.
- 5 Push OFF timer button to confirm the Set data.

<Indoor unit address>

- 6 Push the menu button until the Code No. flashes. And using the [▽] [△] buttons, specify the Code No. **[13]**.
- 7 Push the menu button until the Set data flashes. And using the [▽] [△] buttons, set an indoor unit address.
- 8 Push OFF timer button to confirm the Set data.

<Group address>

- 9 Push the menu button until the Code No. flashes. And using the [▽] [△] buttons, specify the Code No. **[14]**.
- 10 Push the menu button until the Set data flashes. And using the [▽] [△] buttons, set a group address. If the indoor unit is individual, set the address to "0000". (header unit: **0001**, follower unit: **0002**)
- 11 Push OFF timer button to confirm the Set data.
- 12 When all the settings have been completed, push ON/OFF button to finish the settings. (Return to the normal mode)

■ To find an indoor unit's position from its address

- 1 Push and hold menu button and [▽] setting button simultaneously for 10 seconds or more.
E.g.) A unit number 1-1 is indicated on the LCD of the remote controller. The indicated number shows the line (system) address and indoor unit address of the unit.
- 2 When 2 or more indoor units are connected to the remote controller (group-controlled units), a number of other connected units appears each time you push the [▽] [△] buttons.
- 3 Push the ON/OFF button, return to the normal mode.

9 Test run

■ Before test run

- Before turning on the power supply, carry out the following procedure.
 - 1) By using 500 V-megger, check that resistance of 1 MΩ or more exists between the terminal block 1 to 3 and the earth (grounding work). If resistance of less than 1 MΩ is detected, do not run the unit.
 - 2) Check the valve of the outdoor unit being opened fully.
- To protect the compressor at activation time, leave power-ON for 12 hours or more before operating.

■ Execute a test run

Operate the unit with the wired remote controller as usual.

For the procedure of the operation, refer to the attached Owner's Manual.

A forced test run can be executed in the following procedure even if the operation stops by thermostat-OFF.

In order to prevent a serial operation, the forced test run is released after 60 minutes have passed and returns to the usual operation.

CAUTION

Do not use the forced test run for cases other than the test run because it applies an excessive load to the devices.

Wired remote controller

Be sure to stop the air conditioner before making settings.

(Change the setup while the air conditioner is not working.)

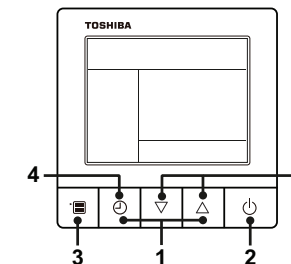

- 1 Push and hold OFF timer button and [△] setting button simultaneously for 10 seconds or more. [TEST] is displayed on the display part and the test run is permitted.

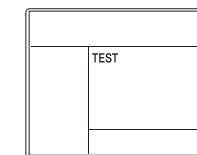

- 2 Push ON/OFF button.
- 3 Push menu button to select the operation mode. Select [Cool] or [Heat] with [▽] [△] setting button.
 - Do not run the air conditioner in a mode other than [Cool] or [Heat].
 - The temperature setting function does not work during test run.
 - The check code is displayed as usual.
- 4 After the test run, push OFF timer button to stop a test run.
([TEST] disappears on the display and the air conditioner enters the normal stop mode.)

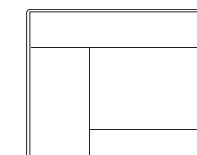

Wireless remote controller

Remote controller model name: RBC-AXU41U *

1 Turn on the power of the air conditioner. When power is turned on for the first time after installation, it takes approx. 5 minutes until the remote controller becomes available. In the case of subsequent power-on, it takes approx. 1 minute until the remote controller becomes available. Execute a test run after the predetermined time has passed.

2 Push "ON/OFF" button on the remote controller, select [Cool] or [Heat] with "MODE" button, and then select [HIGH] with "FAN" button.

Cooling test run	Heating test run
Set the temperature to 17°C with the temp. setup buttons.	Set the temperature to 30°C with the temp. setup buttons.

Cooling test run	Heating test run
After confirming a signal receiving sound "beep" immediately set the temperature to 18°C with the temp. setup buttons.	After confirming a signal receiving sound "beep" immediately set the temperature to 29°C with the temp. setup buttons.

Cooling test run	Heating test run
After confirming a signal receiving sound "beep" immediately set the temperature to 17°C with the temp. setup buttons.	After confirming a signal receiving sound "beep" immediately set the temperature to 30°C with the temp. setup buttons.

6 Repeat procedures 4 → 5 → 4 → 5. Indicators "Operation" (green), "Timer" (green), and "Ready" (orange) in the wireless receiver section flash in approx. 10 seconds, and the air conditioner starts operation. If any of these indicators does not flash, repeat procedures 2 to 5.

7 Upon completion of the test run, push "ON/OFF" button to stop operation.

<Overview of test run operations using the wireless remote controller>

▼ Cooling test run:
ON/OFF → 17°C → 18°C → 17°C → 18°C → 17°C → 18°C → 17°C → (test run) → ON/OFF

▼ Heating test run:
ON/OFF → 30°C → 29°C → 30°C → 29°C → 30°C → 29°C → 30°C → (test run) → ON/OFF

Monitoring function

This function can be used to call the service monitor mode from the remote controller during a test run to obtain the temperature of the sensors of the remote controller, indoor unit, and outdoor unit.

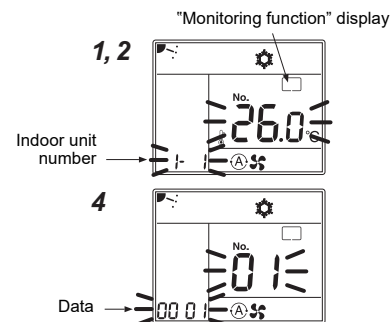
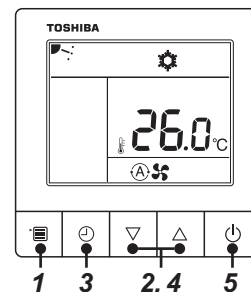

- 1 Push and hold menu button for 10 seconds or more. "Monitoring function" is displayed on a screen.
- 2 Every pushing [▽][△] buttons, the indoor unit numbers in group control are displayed successively.
- 3 Push OFF timer button to confirm the selected indoor unit.
- 4 Every pushing [▽][△] buttons, Code No. of the item is changed successively.
- 5 After you have finished checking, push "ON/OFF" button, return to normal mode.

Indoor unit data	
Code No.	Data name
01	Room temperature (remote controller)
02	Indoor unit intake air temperature (TA)
03	Indoor unit heat exchanger (coil) temperature (TCJ)
04	Indoor unit heat exchanger (coil) temperature (TC)
07	Indoor unit fan speed (×1 rpm)
B9	Communication protocol (0000: TCC-Link, 0001: TU2C-Link)
F3	Indoor unit fan cumulative operating hours (×1 h)
F8	Indoor unit discharge air temperature *1

Outdoor unit data *2	
Code No.	Data name
60	Outdoor unit heat exchanger (coil) temperature (TE)
61	Outside air temperature (TO)
62	Compressor discharge temperature (TD)
63	Compressor suction temperature (TS)
65	Heatsink temperature (THS)
6A	Operating current (×1/10)
6D	Outdoor heat exchange (coil) temperature (TL)
F1	Compressor cumulative operating hours (×100 h)

*1 : The above temperature values are estimated from the temperature of the heat exchanger. It may differ from the actual discharge temperature.
*2 : For outdoor unit data, refer to the Installation Manual and Service Manual of the outdoor unit.

10 Maintenance

<Daily maintenance>

▼ Cleaning of air filter

- Be sure to stop the air conditioner before cleaning of air filter, then turn off the circuit breaker.

1 Open the air intake grille

- Push the corner of the air intake grille and then slide the two hooks toward inside while pushing its corner, hold the air intake grille and open it quietly.

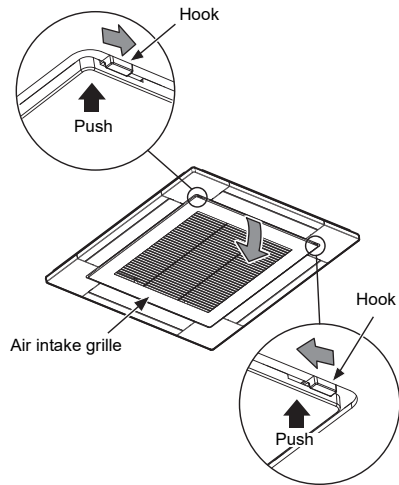

2 Remove the air filter

- Push the protruding section of the air filter towards the inside and pull it towards you to remove it.

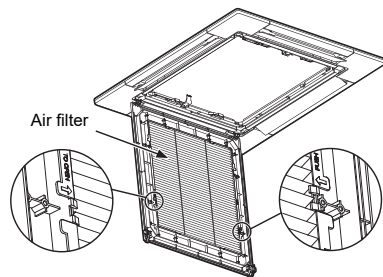

3 Suck up the dust with a vacuum cleaner or wash with water

- When the air filter is very dirty, the dirt can be removed effectively by washing with water or lukewarm water dissolved a neutral detergent.



- Dry well in the shade after washing with water.

4 Attach the air filter

5 Close the air intake grille

- Close the air intake grille, slide the two hooks towards the outside, and secure it properly.

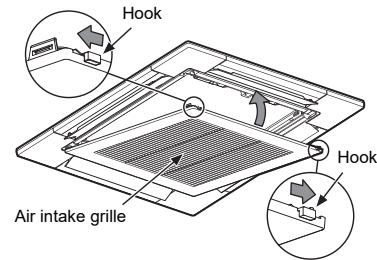

⚠ CAUTION

- Do not start the air conditioner while leaving air filter removed.

▼ Cleaning of discharge louver

- The discharge louver can be removed for cleaning.

1 Remove the corner cap

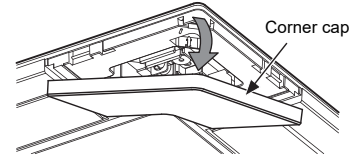

2 Remove the discharge louver

- Hold both ends of the discharge louver and deflect the center downwards to remove it.

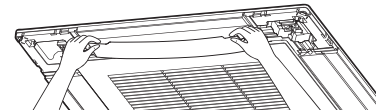

3 Wipe with a soft piece of cloth

- Do not wash with water. This will result in a failure.



4 Mount the discharge louver

- First push in one side and then insert the other side while deflecting the center section downward.

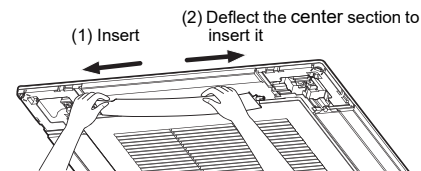

- #### 5
- First push the claws (2 locations) in the direction of the arrow to insert, push the corner section until it clicks into position, and then push the corner section of the corner cap to install it.

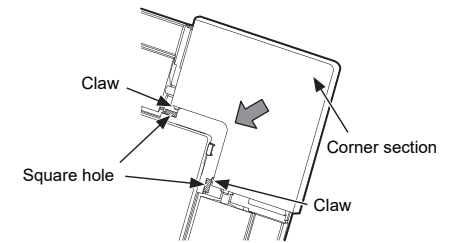

▼ **Periodic Maintenance**

- For environmental conservation, it is strongly recommended that the indoor and outdoor units of the air conditioner in use be cleaned and maintained regularly to ensure efficient operation of the air conditioner. When the air conditioner is operated for a long time, periodic maintenance (once a year) is recommended. Furthermore, regularly check the outdoor unit for rust and scratches, and remove them or apply rustproof treatment, if necessary.

As a general rule, when an indoor unit is operated for 8 hours or more daily, clean the indoor unit and outdoor unit at least once every 3 months. Ask a professional for this cleaning / maintenance work.

Such maintenance can extend the life of the product though it involves the owner's expense.

Failure to clean the indoor and outdoor units regularly will result in poor performance, freezing, water leakage, and even compressor failure.

Inspection before maintenance

Following inspection must be carried out by a qualified installer or qualified service person.

Parts	Inspection method
Heat exchanger*	Open the air intake grille to remove the bell mouth and the fan, and then check the heat exchanger if there is any clogging or damages.
Fan motor	Check if any abnormal noise can be heard.
Fan	Open the air intake grille and check the fan if there are any waggles, damages or adhesive dust.
Filter	Open the air intake grille and check if there are any stains or breaks on the filter.
Drain pan*	Remove the panel, the bell mouth and the drain pan, and then check if there is any clogging, abnormal smell or drain water pollution.

* Refer to the Service Manual for how to remove.

▼ **Maintenance List**

Part	Unit	Check (visual / auditory)	Maintenance
Heat exchanger	Indoor / outdoor	Dust / dirt clogging, scratches	Wash the heat exchanger when it is clogged.
Fan motor	Indoor / outdoor	Sound	Take appropriate measures when abnormal sound is generated.
Filter	Indoor	Dust / dirt, breakage	<ul style="list-style-type: none"> Wash the filter with water when it is contaminated. Replace it when it is damaged.
Fan	Indoor	<ul style="list-style-type: none"> Vibration, balance Dust / dirt, appearance 	<ul style="list-style-type: none"> Replace the fan when vibration or balance is terrible. Brush or wash the fan when it is contaminated.
Air intake / discharge grilles	Indoor / outdoor	Dust / dirt, scratches	Fix or replace them when they are deformed or damaged.
Drain pan	Indoor	Dust / dirt clogging, drain contamination	Clean the drain pan and check the downward slope for smooth drainage.
Ceiling panel, louvers	Indoor	Dust / dirt, scratches	Wash them when they are contaminated or apply repair coating.
Exterior	Outdoor	<ul style="list-style-type: none"> Rust, peeling of insulator Peeling / lift of coat 	Apply repair coating.

11 Troubleshooting

■ **Confirmation and check**

If a problem occurs with the air conditioner, the OFF timer indicator alternately shows the check code and the indoor Unit No. in which the problem occurred.

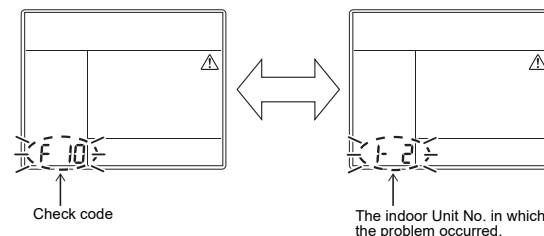

■ **Troubleshooting history and confirmation**

You can check the troubleshooting history with the following procedure if a problem occurs with the air conditioner. (The troubleshooting history records up to 4 incidents.)

You can check it during operation or when operation is stopped.

- If you check the troubleshooting history during OFF timer operation, the OFF timer will be cancelled.

Procedure	Description of operation
1	<p>Push the OFF timer button for over 10 seconds and the indicators appear as an image indicating the troubleshooting history mode has been entered. If [Service check] is displayed, the mode enters in the troubleshooting history mode.</p> <ul style="list-style-type: none"> [01: Order of troubleshooting history] appears in the temperature indicator. The OFF timer indicator alternately shows the [check code] and the [indoor Unit No.] in which the problem occurred.
2	<p>Each time the setting button is pushed, the recorded troubleshooting history is displayed in sequence. The troubleshooting history appears in order from [01] (newest) to [04] (oldest).</p> <p>CAUTION</p> <ul style="list-style-type: none"> In the troubleshooting history mode, DO NOT push the Menu button for over 10 seconds, doing so deletes the entire troubleshooting history of the indoor unit.
3	<p>After you have finished checking, push the ON/OFF button to return to the regular mode.</p> <ul style="list-style-type: none"> If the air conditioner is operating, it remains operated even after the ON/OFF button has been pushed. To stop its operation, push the ON/OFF button again.

■ Check codes and parts to be checked

Wired remote controller display	Wireless remote controller Sensor block display of receiving unit		Main defective parts	Judging device	Parts to be checked / trouble description	Air conditioner status
	Indication	Operation Timer Ready GR GR OR				
E01	⊙ ● ●		No header remote controller Remote controller communication trouble	Remote controller	Incorrect remote controller setting --- The header remote controller has not been set (including two remote controllers). No signal can be received from the indoor unit.	*
E02	⊙ ● ●		Remote controller transmission trouble	Remote controller	Indoor / outdoor connecting wires, indoor P.C. board, remote controller --- No signal can be sent to the indoor unit.	*
E03	⊙ ● ●		Indoor unit-remote controller regular communication trouble	Indoor	Remote controller, network adapter, indoor P.C. board --- No data is received from the remote controller or network adapter.	Auto-reset
E04	● ● ⊙		Indoor unit-outdoor unit serial communication trouble IPDU-CDB communication trouble	Indoor	Indoor / outdoor connecting wires, indoor P.C. board, outdoor P.C. board --- Serial communication trouble between indoor unit and outdoor unit	Auto-reset
E08	⊙ ● ●		Duplicated indoor addresses ★	Indoor	Indoor address setting trouble --- The same address as the self-address was detected.	Auto-reset
E09	⊙ ● ●		Duplicated header remote controllers	Remote controller	Remote controller address setting trouble --- Two remote controllers are set as header in the double-remote controller control. (* The header indoor unit stops raising alarm and follower indoor units continue to operate.)	*
E10	⊙ ● ●		CPU-CPU communication trouble	Indoor	Indoor P.C. board --- Communication trouble between main MCU and motor microcomputer MCU	Auto-reset
E11	⊙ ● ●		Communication trouble between Application control kit and Indoor unit	Indoor	Communication trouble between Application control kit and Indoor unit	Entire stop
E18	⊙ ● ●		Header unit follower unit regular communication trouble	Indoor	Indoor P.C. board --- Regular communication is not possible between header and follower indoor units or between twin header (main) and follower (sub) units.	Auto-reset
E31	● ● ⊙		IPDU communication trouble	Outdoor	Communication trouble between IPDU and CDB	Entire stop
F01	⊙ ⊙ ●	ALT	Indoor unit heat exchanger sensor (TCJ) trouble	Indoor	Heat exchanger sensor (TCJ), indoor P.C. board --- Open-circuit or short-circuit of the heat exchanger sensor (TCJ) was detected.	Auto-reset
F02	⊙ ⊙ ●	ALT	Indoor unit heat exchanger sensor (TC) trouble	Indoor	Heat exchanger sensor (TC), indoor P.C. board --- Open-circuit or short-circuit of the heat exchanger sensor (TC) was detected.	Auto-reset
F04	⊙ ⊙ ○	ALT	Outdoor unit discharge temp. sensor (TD) trouble	Outdoor	Outdoor temp. sensor (TD), outdoor P.C. board --- Open-circuit or short-circuit of the discharge temp. sensor was detected.	Entire stop
F06	⊙ ⊙ ○	ALT	Outdoor unit temp. sensor (TE / TS) trouble	Outdoor	Outdoor temp. sensors (TE / TS), outdoor P.C. board --- Open-circuit or short-circuit of the heat exchanger temp. sensor was detected.	Entire stop
F07	⊙ ⊙ ○	ALT	TL sensor trouble	Outdoor	TL sensor may be displaced, disconnected or short-circuited.	Entire stop
F08	⊙ ⊙ ○	ALT	Outdoor unit outside air temp. sensor trouble	Outdoor	Outdoor temp. sensor (TO), outdoor P.C. board --- Open-circuit or short-circuit of the outdoor air temp. sensor was detected.	Operation continued
F10	⊙ ⊙ ●	ALT	Indoor unit room temp. sensor (TA) trouble	Indoor	Room temp. sensor (TA), indoor P.C. board --- Open-circuit or short-circuit of the room temp. sensor (TA) was detected.	Auto-reset

Wired remote controller display	Wireless remote controller Sensor block display of receiving unit		Main defective parts	Judging device	Parts to be checked / trouble description	Air conditioner status
	Indication	Operation Timer Ready GR GR OR				
F12	⊙ ⊙ ○	ALT	TS sensor trouble	Outdoor	TS sensor may be displaced, disconnected or short-circuited.	Entire stop
F13	⊙ ⊙ ○	ALT	Heat sink sensor trouble	Outdoor	Abnormal temperature was detected by the temp. sensor of the IGBT heat sink.	Entire stop
F15	⊙ ⊙ ○	ALT	Temp. sensor connection trouble	Outdoor	Temp. sensor (TE / TS) may be connected incorrectly.	Entire stop
F29	⊙ ⊙ ●	SIM	Indoor unit, other P.C. board trouble	Indoor	Indoor P.C. board --- EEPROM trouble	Auto-reset
F30	⊙ ⊙ ○	SIM	Occupancy sensor trouble	Indoor	Abnormality was detected from occupancy sensor.	Operation continued
F31	⊙ ⊙ ○	SIM	Outdoor unit P.C. board	Outdoor	Outdoor P.C. board ---- In the case of EEPROM trouble.	Entire stop
H01	● ⊙ ●		Outdoor unit compressor breakdown	Outdoor	Current detect circuit, power voltage --- Minimum frequency was reached in the current releasing control or short-circuit current (Idc) after direct excitation was detected	Entire stop
H02	● ⊙ ●		Outdoor unit compressor lock	Outdoor	Compressor circuit --- Compressor lock was detected.	Entire stop
H03	● ⊙ ●		Outdoor unit current detect circuit trouble	Outdoor	Current detect circuit, outdoor unit P.C. board --- Abnormal current was detected in AC-CT or a phase loss was detected.	Entire stop
H04	● ⊙ ●		Case thermostat operation	Outdoor	Malfunction of the case thermostat	Entire stop
H06	● ⊙ ●		Outdoor unit low-pressure system trouble	Outdoor	Current, high-pressure switch circuit, outdoor P.C. board --- Pressure sensor trouble was detected or low-pressure protective operation was activated.	Entire stop
L03	⊙ ● ⊙	SIM	Duplicated header indoor units ★	Indoor	Indoor address setting trouble --- There are two or more header units in the group.	Entire stop
L07	⊙ ● ⊙	SIM	Group line in individual indoor unit ★	Indoor	Indoor address setting trouble --- There is at least one group-connected indoor unit among individual indoor units.	Entire stop
L08	⊙ ● ⊙	SIM	Indoor group address not set ★	Indoor	Indoor address setting trouble --- Indoor address group has not been set.	Entire stop
L09	⊙ ● ⊙	SIM	Indoor unit capacity not set	Indoor	Indoor unit capacity has not been set.	Entire stop
L10	⊙ ○ ⊙	SIM	Outdoor unit P.C. board	Outdoor	In the case of outdoor P.C. board jumper wire (for service) setting trouble	Entire stop
L20	⊙ ○ ⊙	SIM	LAN communication trouble	Network adapter central control	Address setting, central control remote controller, network adapter --- Duplication of address in central control communication	Auto-reset
L29	⊙ ○ ⊙	SIM	Other outdoor unit trouble	Outdoor	Other outdoor unit trouble 1) Communication trouble between IPDU MCU and CDB MCU 2) Abnormal temperature was detected by the heat sink temp. sensor in IGBT.	Entire stop
L30	⊙ ○ ⊙	SIM	Abnormal external input into indoor unit (interlock)	Indoor	External devices, outdoor unit P.C. board --- Abnormal stop due to incorrect external input into	Entire stop
L31	⊙ ○ ⊙	SIM	Phase sequence trouble, etc.	Outdoor	Power supply phase sequence, outdoor unit P.C. board --- Abnormal phase sequence of the 3-phase power supply	Operation continued (thermostat OFF)
P01	● ⊙ ⊙	ALT	Indoor unit fan trouble	Indoor	Indoor fan motor, indoor P.C. board --- Indoor AC fan trouble (fan motor thermal relay activated) was detected.	Entire stop
P03	⊙ ● ⊙	ALT	Outdoor unit discharge temp. trouble	Outdoor	An trouble was detected in the discharge temp. releasing control.	Entire stop

Wired remote controller display	Wireless remote controller Sensor block display of receiving unit		Main defective parts	Judging device	Parts to be checked / trouble description	Air conditioner status
	Indication	Operation Timer Ready GR GR OR				
P04	⊙ ● ⊙	ALT	Outdoor unit high-pressure system trouble	Outdoor	High-pressure switch --- The IOL was activated or an trouble was detected in the high-pressure releasing control using the TE.	Entire stop
P05	⊙ ● ⊙	ALT	Open phase detected	Outdoor	The power wire may be connected incorrectly. Check open phase and voltages of the power supply.	Entire stop
P07	⊙ ● ⊙	ALT	Heat sink overheat	Outdoor	Abnormal temperature was detected by the temp. sensor of the IGBT heat sink.	Entire stop
P10	● ⊙ ⊙	ALT	Indoor unit water overflow detected	Indoor	Drain pipe, clogging of drainage, float switch circuit, indoor P.C. board --- Drainage is out of order or the float switch was activated.	Entire stop
P12	● ⊙ ⊙	ALT	The fan trouble of the indoor unit	Indoor	Abnormal operation of the indoor fan motor, indoor P.C. board, or indoor DC fan (over current or lock, etc.) is detected.	Entire stop
P15	⊙ ● ⊙	ALT	Gas leakage detected	Outdoor	There may be gas leakage from the pipe or connecting part. Check for gas leakage.	Entire stop
P19	⊙ ● ⊙	ALT	4-way valve trouble	Outdoor (Indoor)	4-way valve, indoor temp. sensors (TC / TCJ) --- An trouble was detected due to temperature drop of the indoor unit heat exchanger sensor when heating.	Auto-reset
P20	⊙ ● ⊙	ALT	High-pressure protective operation	Outdoor	High-pressure protection	Entire stop
P22	⊙ ● ⊙	ALT	Outdoor unit fan trouble	Outdoor	Outdoor unit fan motor, outdoor unit P.C. board --- An trouble (overcurrent, locking, etc.) was detected in the outdoor unit fan drive circuit.	Entire stop
P26	⊙ ● ⊙	ALT	Outdoor unit inverter ldc activated	Outdoor	IGBT, outdoor unit P.C. board, inverter wiring, compressor --- Short-circuit protection for compressor drive circuit devices (G-Tr / IGBT) was activated.	Entire stop
P29	⊙ ● ⊙	ALT	Outdoor unit position trouble	Outdoor	Outdoor unit P.C. board, high-pressure switch --- Compressor motor position trouble was detected.	Entire stop
P31	⊙ ● ⊙	ALT	Other indoor unit trouble	Indoor	Another indoor unit in the group is raising an alarm.	Entire stop
					E03/L07/L03/L08 alarm check locations and trouble description	Auto-reset

⊙ : Lighting ⊙ : Flashing ● : OFF ★ : The air conditioner automatically enters the auto-address setting mode.
 ALT: When two LEDs are flashing, they flash alternately. SIM: When two LEDs are flashing, they flash in synchronization.
 Receiving unit display OR: Orange GR: Green

Toshiba Carrier Corporation

336 TADEHARA, FUJI-SHI, SHIZUOKA-KEN 416-8521 JAPAN

EB99847501