

# TOSHIBA

R32 or R410A

## AIR CONDITIONER (MULTI TYPE) Installation Manual

### Indoor Unit

Model name:

Ceiling Type

- MMC-UP0151HP-E**
- MMC-UP0181HP-E**
- MMC-UP0241HP-E**
- MMC-UP0271HP-E**
- MMC-UP0361HP-E**
- MMC-UP0481HP-E**
- MMC-UP0561HP-E**

For commercial use

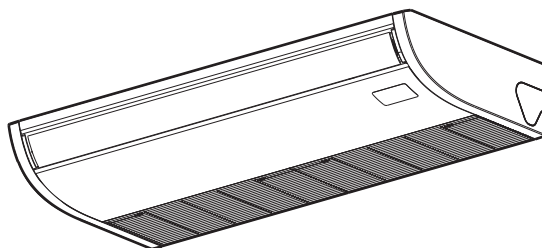

**Original instruction**

Please read this Installation Manual carefully before installing the Air Conditioner.

- This Manual describes the installation method of the indoor unit.
- For installation of the outdoor unit, follow the Installation Manual attached to the outdoor unit.

**ADOPTION OF R32 or R410A REFRIGERANT**

This Air Conditioner has adopted a refrigerant HFC (R32 or R410A) which does not destroy the ozone layer. Be sure to check the refrigerant type for outdoor unit to be combined, and then install it.

**Information**  
If U series models (TU2C-Link) are combined with models other than U series (TCC-Link), the wiring specifications and maximum number of connectable indoor units will be changed. Pay attentions to their communication specifications when carrying out the installation, maintenance, or repair. For its details, refer to the “**Electrical connection**” in this Manual.

**Product information of ecodesign requirements. (Regulation (EU) 2016/2281)**  
<http://ecodesign.toshiba-airconditioning.eu/en>

**Contents**

<b>1</b>	<b>Precautions for safety</b> .....	<b>3</b>
<b>2</b>	<b>Accessory parts</b> .....	<b>7</b>
<b>3</b>	<b>Selection of installation place</b> .....	<b>7</b>
<b>4</b>	<b>Installation</b> .....	<b>8</b>
<b>5</b>	<b>Drain piping</b> .....	<b>11</b>
<b>6</b>	<b>Refrigerant piping</b> .....	<b>13</b>
<b>7</b>	<b>Electrical connection</b> .....	<b>14</b>
<b>8</b>	<b>Applicable controls</b> .....	<b>18</b>
<b>9</b>	<b>Test run</b> .....	<b>20</b>
<b>10</b>	<b>Maintenance</b> .....	<b>21</b>
<b>11</b>	<b>Troubleshooting</b> .....	<b>22</b>
<b>12</b>	<b>Specifications</b> .....	<b>27</b>
<b>13</b>	<b>Notice code</b> .....	<b>27</b>
<b>14</b>	<b>Appendix</b> .....	<b>27</b>

Thank you for purchasing this Toshiba air conditioner.

Please read carefully through these instructions that contain important information which complies with the Machinery Directive (Directive 2006/42/EC), and ensure that you understand them.

After completing the installation work, hand over this Installation Manual as well as the Owner's Manual provided to the user, and ask the user to keep them in a safe place for future reference.

#### Generic Denomination: Air Conditioner

#### Definition of Qualified Installer or Qualified Service Person

The air conditioner must be installed, maintained, repaired and removed by a qualified installer or qualified service person. When any of these jobs is to be done, ask a qualified installer or qualified service person to do them for you. A qualified installer or qualified service person is an agent who has the qualifications and knowledge described in the table below.

Agent	Qualifications and knowledge which the agent must have
Qualified installer (*1)	<ul style="list-style-type: none"> <li>The qualified installer is a person who installs, maintains, relocates and removes the air conditioners made by Toshiba Carrier Corporation. He or she has been trained to install, maintain, relocate and remove the air conditioners made by Toshiba Carrier Corporation or, alternatively, he or she has been instructed in such operations by an individual or individuals who have been trained and is thus thoroughly acquainted with the knowledge related to these operations.</li> <li>The qualified installer who is allowed to do the electrical work involved in installation, relocation and removal has the qualifications pertaining to this electrical work as stipulated by the local laws and regulations, and he or she is a person who has been trained in matters relating to electrical work on the air conditioners made by Toshiba Carrier Corporation or, alternatively, he or she has been instructed in such matters by an individual or individuals who have been trained and is thus thoroughly acquainted with the knowledge related to this work.</li> <li>The qualified installer who is allowed to do the refrigerant handling and piping work involved in installation, relocation and removal has the qualifications pertaining to this refrigerant handling and piping work as stipulated by the local laws and regulations, and he or she is a person who has been trained in matters relating to refrigerant handling and piping work on the air conditioners made by Toshiba Carrier Corporation or, alternatively, he or she has been instructed in such matters by an individual or individuals who have been trained and is thus thoroughly acquainted with the knowledge related to this work.</li> <li>The qualified installer who is allowed to work at heights has been trained in matters relating to working at heights with the air conditioners made by Toshiba Carrier Corporation or, alternatively, he or she has been instructed in such matters by an individual or individuals who have been trained and is thus thoroughly acquainted with the knowledge related to this work.</li> </ul>
Qualified service person (*1)	<ul style="list-style-type: none"> <li>The qualified service person is a person who installs, repairs, maintains, relocates and removes the air conditioners made by Toshiba Carrier Corporation. He or she has been trained to install, repair, maintain, relocate and remove the air conditioners made by Toshiba Carrier Corporation or, alternatively, he or she has been instructed in such operations by an individual or individuals who have been trained and is thus thoroughly acquainted with the knowledge related to these operations.</li> <li>The qualified service person who is allowed to do the electrical work involved in installation, repair, relocation and removal has the qualifications pertaining to this electrical work as stipulated by the local laws and regulations, and he or she is a person who has been trained in matters relating to electrical work on the air conditioners made by Toshiba Carrier Corporation or, alternatively, he or she has been instructed in such matters by an individual or individuals who have been trained and is thus thoroughly acquainted with the knowledge related to this work.</li> <li>The qualified service person who is allowed to do the refrigerant handling and piping work involved in installation, repair, relocation and removal has the qualifications pertaining to this refrigerant handling and piping work as stipulated by the local laws and regulations, and he or she is a person who has been trained in matters relating to refrigerant handling and piping work on the air conditioners made by Toshiba Carrier Corporation or, alternatively, he or she has been instructed in such matters by an individual or individuals who have been trained and is thus thoroughly acquainted with the knowledge related to this work.</li> <li>The qualified service person who is allowed to work at heights has been trained in matters relating to working at heights with the air conditioners made by Toshiba Carrier Corporation or, alternatively, he or she has been instructed in such matters by an individual or individuals who have been trained and is thus thoroughly acquainted with the knowledge related to this work.</li> </ul>

#### Definition of Protective Gear



When the air conditioner is to be transported, installed, maintained, repaired or removed, wear protective gloves and 'safety' work clothing.

In addition to such normal protective gear, wear the protective gear described below when undertaking the special work detailed in the table below.

Failure to wear the proper protective gear is dangerous because you will be more susceptible to injury, burns, electric shocks and other injuries.

Work undertaken	Protective gear worn
All types of work	Protective gloves 'Safety' working clothing
Electrical-related work	Gloves to provide protection for electricians Insulating shoes Clothing to provide protection from electric shock
Work done at heights (50 cm or more)	Helmets for use in industry
Transportation of heavy objects	Shoes with additional protective toe cap
Repair of outdoor unit	Gloves to provide protection for electricians

These safety cautions describe important matters concerning safety to prevent injury to users or other people and damages to property. Please read through this manual after understanding the contents below (meanings of indications), and be sure to follow the description.





Indication	Meaning of Indication
 <b>WARNING</b>	Text set off in this manner indicates that failure to adhere to the directions in the warning could result in serious bodily harm (*1) or loss of life if the product is handled improperly.
 <b>CAUTION</b>	Text set off in this manner indicates that failure to adhere to the directions in the caution could result in slight injury (*2) or damage (*3) to property if the product is handled improperly.

\*1: Serious bodily harm indicates loss of eyesight, injury, burns, electric shock, bone fracture, poisoning, and other injuries which leave aftereffect and require hospitalization or long-term treatment as an outpatient.





\*2: Slight injury indicates injury, burns, electric shock, and other injuries which do not require hospitalization or long-term treatment as an outpatient.

\*3: Damage to property indicates damage extending to buildings, household effects, domestic livestock, and pets.

#### MEANINGS OF SYMBOLS DISPLAYED ON THE UNIT

	<b>WARNING</b> (Risk of fire)	This mark is for R32 refrigerant only. In case that refrigerant type is R32, this unit uses a flammable refrigerant. If refrigerant leaks and comes in contact with fire or heating part, it will create harmful gas and there is risk of fire.
		Read the OPERATIONS MANUAL carefully before operation.
		Service personnel are required to carefully read the OPERATIONS MANUAL and INSTALLATION MANUAL before operation.
		Further information is available in the OPERATIONS MANUAL, INSTALLATION MANUAL, and the like.

■ Warning indications on the air conditioner unit

Warning indication		Description
	<p><b>WARNING</b></p> <p><b>ELECTRICAL SHOCK HAZARD</b> Disconnect all remote electric power supplies before servicing.</p>	<p><b>WARNING</b></p> <p><b>ELECTRICAL SHOCK HAZARD</b> Disconnect all remote electric power supplies before servicing.</p>
	<p><b>WARNING</b></p> <p>Moving parts. Do not operate unit with grille removed. Stop the unit before the servicing.</p>	<p><b>WARNING</b></p> <p>Moving parts. Do not operate unit with grille removed. Stop the unit before the servicing.</p>
	<p><b>CAUTION</b></p> <p>High temperature parts. You might get burned when removing this panel.</p>	<p><b>CAUTION</b></p> <p>High temperature parts. You might get burned when removing this panel.</p>
	<p><b>CAUTION</b></p> <p>Do not touch the aluminum fins of the unit. Doing so may result in injury.</p>	<p><b>CAUTION</b></p> <p>Do not touch the aluminium fins of the unit. Doing so may result in injury.</p>
	<p><b>CAUTION</b></p> <p><b>BURST HAZARD</b> Open the service valves before the operation, otherwise there might be the burst.</p>	<p><b>CAUTION</b></p> <p><b>BURST HAZARD</b> Open the service valves before the operation, otherwise there might be the burst.</p>

# 1 Precautions for safety

The manufacturer shall not assume any liability for the damage caused by not observing the description of this manual.

## WARNING

### General

- Before starting to install the air conditioner, read through the Installation Manual carefully, and follow its instructions to install the air conditioner.
- Only a qualified installer (\*1) or qualified service person (\*1) is allowed to do installation work. Inappropriate installation may result in water leakage, electric shock or fire.
- Do not use any refrigerant different from the one specified for complement or replacement. Otherwise, abnormally high pressure may be generated in the refrigeration cycle, which may result in a failure or explosion of the product or an injury to your body.
- Before opening the intake grille of the indoor unit or service panel of the outdoor unit, set the circuit breaker to the OFF position. Failure to set the circuit breaker to the OFF position may result in electric shocks through contact with the interior parts. Only a qualified installer (\*1) or qualified service person (\*1) is allowed to remove the intake grille of the indoor unit or service panel of the outdoor unit and do the work required.
- Before carrying out the installation, maintenance, repair or removal work, set the circuit breaker to the OFF position. Otherwise, electric shocks may result.
- Place a “Work in progress” sign near the circuit breaker while the installation, maintenance, repair or removal work is being carried out. There is a danger of electric shocks if the circuit breaker is set to ON by mistake.
- Only a qualified installer (\*1) or qualified service person (\*1) is allowed to undertake work at heights using a stand of 50 cm or more or to remove the intake grille of the indoor unit to undertake work.

- Wear protective gloves and safety work clothing during installation, servicing and removal.
- Do not touch the aluminium fin of the unit. You may injure yourself if you do so. If the fin must be touched for some reason, first put on protective gloves and safety work clothing, and then proceed.
- Do not climb onto or place objects on top of the outdoor unit. You may fall or the objects may fall off of the outdoor unit and result in injury.
- Before opening the intake grille, set the circuit breaker to the OFF position. Failure to set the circuit breaker to the OFF position may result in injury through contact with the rotation parts. Only a qualified installer (\*1) or qualified service person (\*1) is allowed to remove the intake grille and do the work required.
- When work is performed at heights, use a ladder which complies with the ISO 14122 standard, and follow the procedure in the ladder's instructions. Also wear a helmet for use in industry as protective gear to undertake the work.
- Before cleaning the filter or other parts of the outdoor unit, set the circuit breaker to OFF without fail, and place a "Work in progress" sign near the circuit breaker before proceeding with the work.
- Before working at heights, put a sign in place so that no-one will approach the work location, before proceeding with the work. Parts and other objects may fall from above, possibly injuring a person below. While carrying out the work, wear a helmet for protection from falling objects.
- Do not use the refrigerant other than R32 or R410A. For the refrigerant type, check the outdoor unit to be combined.
- The refrigerant used by this air conditioner, follow to the outdoor unit.
- The air conditioner must be transported in stable condition. If any part of the product is broken, contact the dealer.
- When the air conditioner must be transported by hand, carry it by two or more people.
- Do not move or repair any unit by yourself. There is high voltage inside the unit. You may get electric shock when removing the cover and main unit.
- To transport the air conditioner, wear shoes with additional protective toe caps.

- To transport the air conditioner, do not take hold of the bands around the packing carton. You may injure yourself if the bands should break.
- This appliance is intended to be used by expert or trained users in shops, in light industry, or for commercial use by lay persons.

### **Selection of installation location**

- When the air conditioner is installed in a small room, provide appropriate measures to ensure that the concentration of refrigerant leakage occur in the room does not exceed the critical level.
- Do not install in a location where flammable gas leaks are possible. If the gas leak and accumulate around the unit, it may ignite and cause a fire.
- Install the indoor unit at least 2.5 m above the floor level since otherwise the users may injure themselves or receive electric shocks if they poke their fingers or other objects into the indoor unit while the air conditioner is running.
- Do not place any combustion appliance in a place where it is directly exposed to the wind of air conditioner, otherwise it may cause imperfect combustion

### **Installation**

- When the indoor unit is to be suspended, the designated hanging bolts (M10 or W3/8) and nuts (M10 or W3/8) must be used.
- Install the air conditioner securely in a location where the base can sustain the weight adequately. If the strength is not enough, the unit may fall down resulting in injury.
- Follow the instructions in the Installation Manual to install the air conditioner. Failure to follow these instructions may cause the product to fall down or topple over or give rise to noise, vibration, water leakage or other trouble.
- Carry out the specified installation work to guard against the possibility of high winds and earthquake. If the air conditioner is not installed appropriately, a unit may topple over or fall down, causing an accident.
- If refrigerant gas has leaked during the installation work, ventilate the room immediately. If the leaked refrigerant gas comes in contact with fire, noxious gas may generate.
- Use forklift to carry in the air conditioner units and use winch or hoist at installation of them.

## Refrigerant piping

- Install the refrigerant pipe securely during the installation work before operating the air conditioner. If the compressor is operated with the valve open and without refrigerant pipe, the compressor sucks air and the refrigeration cycles is over pressurized, which may cause a injury.
- Tighten the flare nut with a torque wrench in the specified manner. Excessive tighten of the flare nut may cause a crack in the flare nut after a long period, which may result in refrigerant leakage.
- After the installation work, confirm that refrigerant gas does not leak. If refrigerant gas leaks into the room and flows near a fire source, such as a cooking range, noxious gas may be generated.
- When the air conditioner has been installed or relocated, follow the instructions in the Installation Manual and purge the air completely so that no gases other than the refrigerant will be mixed in the refrigerating cycle. Failure to purge the air completely may cause the air conditioner to malfunction.
- Nitrogen gas must be used for the airtight test.
- The charge hose must be connected in such a way that it is not slack.
- If refrigerant gas has leaked during the installation work, ventilate the room immediately. If the leaked refrigerant gas comes in contact with fire, noxious gas may be generated.

## Electrical wiring

- Only a qualified installer (\*1) or qualified service person (\*1) is allowed to carry out the electrical work of the air conditioner. Under no circumstances must this work be done by an unqualified individual since failure to carry out the work properly may result in electric shocks and/or electrical leaks.
- To connect the electrical wires, repair the electrical parts or undertake other electrical jobs, wear gloves to provide protection for electricians, insulating shoes and clothing to provide protection from electric shocks. Failure to wear this protective gear may result in electric shocks.
- Use wiring that meets the specifications in the Installation Manual and the stipulations in the local regulations and laws. Use of wiring which does not meet the specifications may give rise to electric shocks, electrical leakage, smoking and/or a fire.

- Connect earth wire. (Grounding work)
- Incomplete grounding causes an electric shock.
- Do not connect earth wires to gas pipes, water pipes, and lightning conductor or telephone earth wires.
- After completing the repair or relocation work, check that the earth wires are connected properly.
- Install a circuit breaker that meets the specifications in the Installation Manual and the stipulations in the local regulations and laws.
- Install the circuit breaker where it can be easily accessed by the agent.
- When installing the circuit breaker outdoors, install one which is designed to be used outdoors.
- Under no circumstances the power wire must not be extended. Connection trouble in the places where the wire is extended may give rise to smoking and/or a fire.
- Electrical wiring work shall be conducted according to law and regulation in the community and Installation Manual. Failure to do so may result in electrocution or short circuit.

## Test run

- Before operating the air conditioner after having completed the work, check that the electrical control box cover of the indoor unit and service panel of the outdoor unit are closed, and set the circuit breaker to the ON position. You may receive an electric shock if the power is turned on without first conducting these checks.
- If there is any kind of trouble (such as an error display has appeared, smell of burning, abnormal sounds, the air conditioner fails to cool or heat or water is leaking) has occurred in the air conditioner, do not touch the air conditioner yourself but set the circuit breaker to the OFF position, and contact a qualified service person (\*1). Take steps to ensure that the power will not be turned on (by marking "out of service" near the circuit breaker, for instance) until qualified service person (\*1) arrives. Continuing to use the air conditioner in the trouble status may cause mechanical problems to escalate or result in electric shocks or other trouble.



- 
- After the work has finished, use an insulation tester set (500V Megger) to check the resistance is 1MΩ or more between the charge section and the non-charge metal section (Earth section). If the resistance value is low, a disaster such as a leak or electric shock is caused at user's side.
  - Upon completion of the installation work, check for refrigerant leaks and check the insulation resistance and water drainage. Then conduct a test run to check that the air conditioner is operating properly.

#### **Explanations given to user**

- Upon completion of the installation work, tell the user where the circuit breaker is located. If the user does not know where the circuit breaker is, he or she will not be able to turn it off in the event that trouble has occurred in the air conditioner.
- If the fan grille is damaged, do not approach the outdoor unit but set the circuit breaker to the OFF position, and contact a qualified service person (\*1) to have the repairs done. Do not set the circuit breaker to the ON position until the repairs are completed.
- After the installation work, follow the Owner's Manual to explain to the customer how to use and maintain the unit.

#### **Relocation**

- Only a qualified installer (\*1) or qualified service person (\*1) is allowed to relocate the air conditioner. It is dangerous for the air conditioner to be relocated by an unqualified individual since a fire, electric shocks, injury, water leakage, noise and/or vibration may result.
  - When carrying out the pump-down work shut down the compressor before disconnecting the refrigerant pipe. Disconnecting the refrigerant pipe with the service valve left open and the compressor still operating will cause air or other gas to be sucked in, raising the pressure inside the refrigeration cycle to an abnormally high level, and possibly resulting in rupture, injury or other trouble.
- 

---

### **⚠ CAUTION**

#### **New refrigerant air conditioner installation**

- **This air conditioner adopts the new HFC refrigerant (R32 or R410A) which does not destroy ozone layer.**
- The characteristics of R32 or R410A refrigerant are; easy to absorb water, oxidizing membrane or oil, and its pressure is approx. 1.6 times higher than that of refrigerant R22. Accompanied with the new refrigerant, refrigerating oil has also been changed. Therefore, do not let water, dust, former refrigerant, or refrigerating oil enter the refrigerating cycle during installation work.
- To prevent charging an incorrect refrigerant and refrigerating oil, the sizes of connecting sections of charging port of the main unit and installation tools are changed from those for the conventional refrigerant.
- Accordingly the exclusive tools are required for the new refrigerant (R32 or R410A).
- For connecting pipes, use new and clean piping designed for R32 or R410A, and please care so that water or dust does not enter.

#### **To disconnect the appliance from main power supply.**







- This appliance must be connected to the main power supply by means of a switch with a contact separation of at least 3 mm.

#### **The installation fuse (all types can be used) must be used for the power supply line of this conditioner.**

---

(\*1) Refer to the "Definition of Qualified Installer or Qualified Service Person."

## 2 Accessory parts

Part name	Q'ty	Shape	Usage
Installation Manual	1	This manual	(Hand over to customers) (For other languages that do not appear in this Installation Manual, please refer to the enclosed CD-R.)
CD-ROM	1	-	Installation Manual
Heat insulating pipe	2		For heat insulation of pipe connecting section
Washer	4	M10 × Ø25	For holding down unit
Hose band	2		For connecting drain pipe
Drain hose	1		For connecting drain pipe
Bushing	1		For protection of edge at power taking-in port
Heat insulator	1		For heat insulation of drain hose (10t × 190 × 190)
Heat insulator of top plate	1		For upper pipe hole of indoor unit (6t × 120 × 160)
Banding band	6		For heat insulation of pipe connecting section (n=4) and drain hose heat insulator (n=2).

## 3 Selection of installation place

### CAUTION

- **Do not install in a location where flammable gas may leak are possible.**  
If the gas leak and accumulate around the unit, it may ignite and cause a fire.
- **When an outdoor unit using R32 refrigerant is combined with indoor unit, be attention to the floor area in the room to be installed.**  
Indoor units cannot be installed in rooms with a floor area less than the minimum floor area. For details, follow the Installation Manual to the outdoor unit.

### **Avoid installing in the following places.**

Select a location for the indoor unit where the cool or warm air will circulate evenly.

Avoid installation in the following kinds of locations.

- Saline area (coastal area).
- Locations with acidic or alkaline atmospheres (such as areas with hot springs, factories where chemicals or pharmaceuticals are made and places where the exhaust air from combustion appliances will be sucked into the unit).  
Doing so may cause the heat exchanger (its aluminum fins and copper pipes) and other parts to become corroded.
- Places where iron or other metal dust is present. If iron or other metal dust adheres to or collects on the interior of the air conditioner, it may spontaneously combust and start a fire.
- Locations with atmospheres with mist of cutting oil or other types of machine oil.  
Doing so may cause the heat exchanger to become corroded, mists caused by the blockage of the heat exchanger to be generated, the plastic parts to be damaged, the heat insulators to peel off, and other such problems to result.
- Locations where vapors from food oils are formed (such as kitchens where food oils are used).  
Blocked filters may cause the air conditioner's performance to deteriorate, condensation to form, the plastic parts to be damaged, and other such problems to result.
- Locations near obstructions such as ventilation openings or lighting fixtures where the flow of the blown air will be disrupted (a disruption of the air flow may cause the air conditioner's performance to deteriorate or the unit to shut down).
- Locations where an in-house power generator is used for the power supply.  
The power line frequency and voltage may fluctuate, and the air conditioner may not work properly as a result.
- On truck cranes, ships or other moving conveyances.
- The air conditioner must not be used for special applications (such as for storing food, plants, precision instruments or art works).  
(The quality of the items stored may be degraded.)
- Locations where high frequencies are generated (by inverter equipment, in-house power generators, medical equipment or communication equipment).  
(Malfunctioning or control trouble in the air conditioner or noise may adversely affect the equipment's operation.)
- Locations where there is anything under the unit installed that would be compromised by wetness.  
(If the drain has become blocked or when the humidity is over 80%, condensation from the indoor unit will drip, possibly causing damage to anything underneath.)
- In the case of the wireless type of system, rooms with the inverter type of fluorescent lighting or locations exposed to direct sunlight.  
(The signals from the wireless remote controller may not be sensed.)
- Locations where organic solvents are being used.
- The air conditioner cannot be used for liquefied carbonic acid cooling or in chemical plants.
- Location near doors or windows where the air conditioner may come into contact with high-temperature, high-humidity outdoor air.  
(Condensation may occur as a result.)
- Locations where special sprays are used frequently.



## ■ Installation space

(Unit: mm)

Reserve sufficient space required for installation or service work.

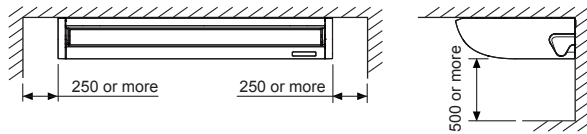

## ■ Ceiling height

Model MMC-	Possible installed ceiling height
UP015 to UP027	Up to 4.0 m
UP036 to UP056	Up to 4.3 m

If height of ceiling exceeds 3.5 m, hot air becomes difficult to reach the floor surface, and then the change of setup of high ceiling is necessary. For the change method of high ceiling, refer to the application control, "Installing indoor unit on high ceiling" in this Manual.

### ▼ Height list of ceiling possible to be installed

Model MMC-	UP015 to UP027	UP036 to UP056	SET DATA
Standard (Factory default)	Up to 3.5 m	Up to 3.5 m	0000
High ceiling (1)	Up to 4.0 m	Up to 4.3 m	0003

The lighting time of the filter sign (notification of filter cleaning) on the remote controller can be changed according to installation conditions.

When it is difficult to obtain satisfactory heating due to location place of the indoor unit or the structure of the room, the detection temperature of heating can be raised.

For change the setup time, refer to the application control, "Filter sign setting" and "To secure better effect of heating" in this Manual.

## ■ In case of wireless type

Decide the position which remote controller is operated and the installation place.

And then refer to the Installation Manual of the wireless remote controller kit sold separately.

(The signal of the wireless type remote controller can be received within approx. 8 m. This distance is a criterion and varies a little according to capacity of the battery)

- To prevent malfunction, select a place where is not affected by a fluorescent lamp or direct sunlight.
- Two wireless-type indoor units can be set in a room.

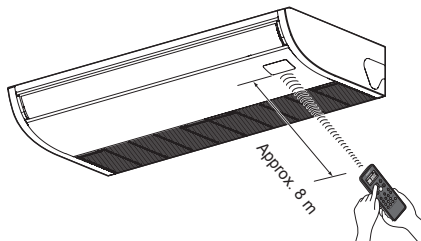

# 4 Installation

## ⚠ CAUTION

Strictly comply with the following rules to prevent damage of the indoor units and human injury.

- Do not put a heavy article on the indoor unit or let a person get on it. (Even units are packaged)
- Carry in the indoor unit as it is packaged if possible. If carrying in the indoor unit unpacked by necessity, use buffering cloth or other material to not damage the unit.
- Carry the package by two or more persons, and do not bundle it with plastic band at positions other than specified.
- To install vibration isolation material to hanging bolts, confirm that it does not increase the unit vibration.

## ■ External dimensions

(Unit: mm)

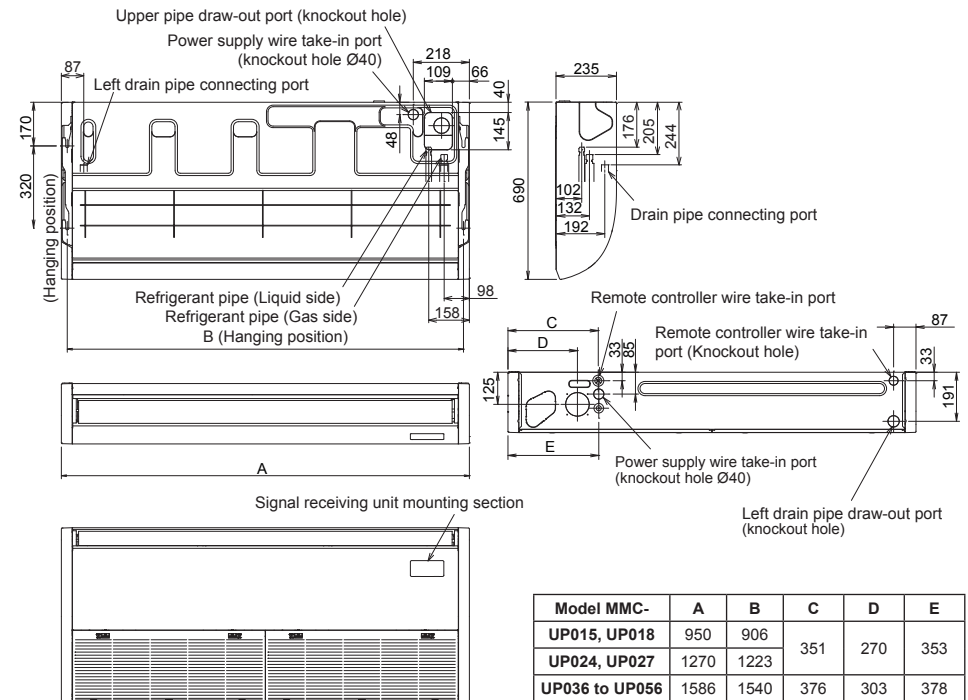

## ■ Installation of hanging bolt

- Consider the piping / wiring after the unit is hung to determine the location of the indoor unit installation and orientation.
- After the location of the indoor unit installation has been determined, install hanging bolts.
- For the dimensions of the hanging bolt pitches, refer to the external view and installation pattern.

Procure hanging bolts washer and nuts for installing the indoor unit (these are not supplied).

Hanging bolt	M10 or W3/8	4 pieces
Nut	M10 or W3/8	8 pieces

- To fasten the hanging bracket from above and below, twelve pieces of nuts are required.

### How to use attached installation pattern

Using the pattern, positioning of the hanging bolt and pipe hole can be performed. The installation pattern is printed on the packing carton. Cut it off the carton.

- \* As an error to some degree may generate on the pattern size due to temperature and humidity, be sure to confirm the size.

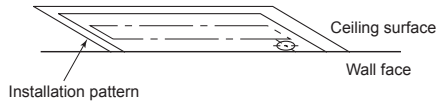

### Hole for drawing out pipe from top face

(Bottom View)

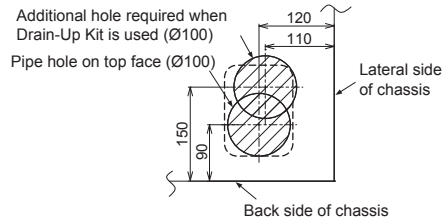

### Hole for drawing out pipe from back side

(Front View)

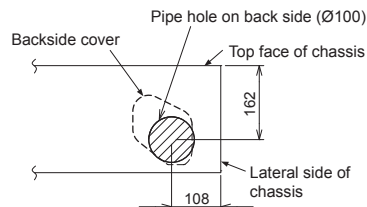

## Installation of hanging bolt

Use M10 hanging bolts (4 pcs, locally procured). Matching to the existing structure, set pitch according to size in the "External dimensions".

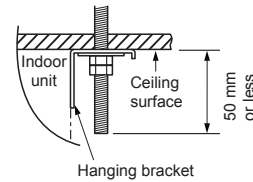

<b>New concrete slab</b>	
Install the bolts with insert brackets or anchor bolts.	
(Blade type bracket)	(Slide type bracket)
Anchor bolt (Pipe hanging anchor bolt)	
<b>Steel frame structure</b>	
Use existing angles or install new support angles.	
Support angle	
<b>Existing concrete slab</b>	
Use a hole-in anchors, hole-in plugs, or a hole-in bolts.	

## ■ Installation of remote controller (Sold separately)

For installation of the remote controller, follow the Installation Manual attached with the remote controller.

- Pull out the remote controller cord together with the refrigerant pipe or drain pipe. Pass the remote controller cord through upper side of the refrigerant pipe and drain pipe.
- Do not leave the remote controller at a place exposed to the direct sunlight and near a stove.
- Operate the remote controller, confirm that the indoor unit receives a signal surely, and then install it. (Wireless type)
- Keep 1 m or more from the devices such as television, stereo. (Disturbance of image or noise may generate.) (Wireless type)

## ■ Before installation

### 1 Removal of air intake grille

- 1) Remove the screws of air intake grille fixing knob on a side of each filter.
- 2) Slide the air intake grille fixing knobs (two positions) toward the arrow direction (OPEN), and then open the air intake grille.
- 3) With the air intake grille open, hold the hinge from above and below with one hand and take out the air intake grille with the other hand while gently pushing it. (There are two air intake grilles.)

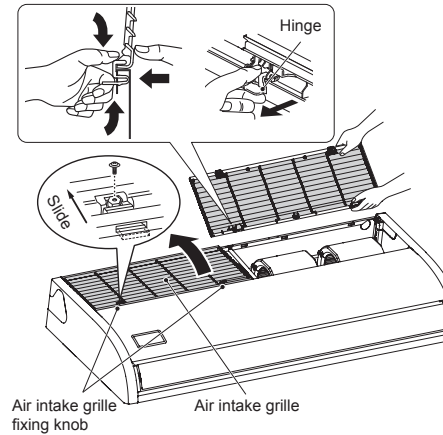

### 2 Removal of side panel

After removing the side panel fixing screws (1 each at right and left), slide the side panel forward and then remove it.

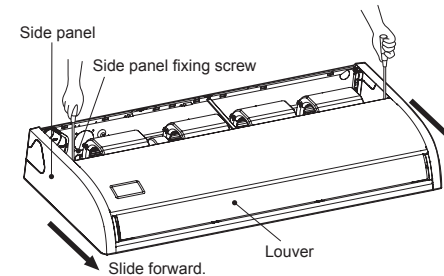

## ⚠ CAUTION

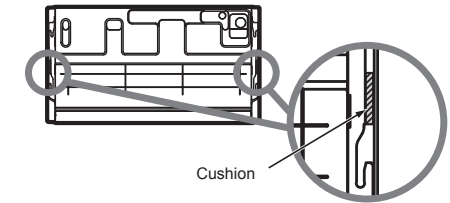

Cushions are inserted between the side panel and hanging hook for transportation. (In the two places shown above) Remove them before installation.

## ■ Draw-out direction of pipe / wire

Decide installation place of the unit and draw-out direction of pipe and wire.

## ■ Pipe knockout hole

### In case of taking pipe from the rear side

\* Cut off the groove section with a plastic cutter.

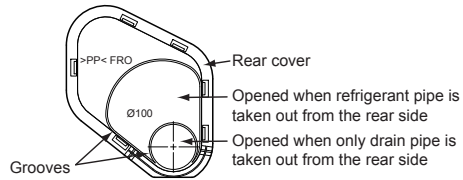

### <In case of taking pipe from right side>

\* Cut off the groove section with a metal saw or plastic cutter.

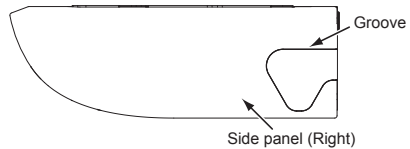

### <In case of taking pipe from left side>

Taking pipe from left side is applied only to the drain pipe. The refrigerant pipe cannot be taken out from the left side.

\* Cut off the groove section with a metal saw or plastic

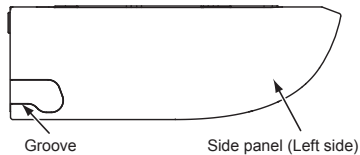

### <In case of taking pipe from upper side>

Taking pipe from upper side is applied only to the refrigerant pipe.

When taking out the drain pipe from the upper side, use a drain up kit sold separately.

Open the upper pipe draw-out port (Knockout hole) shown in the external dimensions.

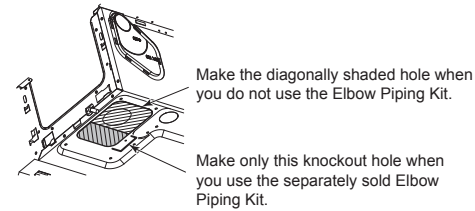

After piping, cut off the attached heat insulator of the top plate to pipe shape, and then seal the knockout hole.

## ■ Knockout hole of power wire take-in port

Open the power wire take-in port (Knockout hole) shown in the "External dimensions" and then mount the attached bushing.

## ■ Installation of indoor unit

### ◆ Preparation before holding down main unit

\* Confirm the presence of the ceiling material beforehand because the fixing method of hanging metal when the ceiling material is set differs from that when the ceiling material is not set.

#### <There is ceiling material>

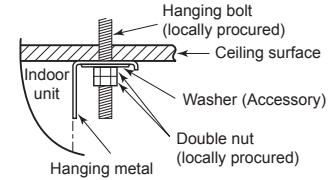

• Fix the hanging bracket as shown below if the ceiling is bent upwards when you fasten lower nuts to the hanging bracket.

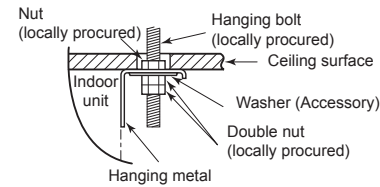

#### <There is no ceiling material>

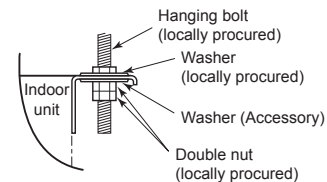

### ◆ Holding down of main unit

<Hanging the indoor unit directly from the ceiling>

1 Attach washer and nuts to the hanging bolt.

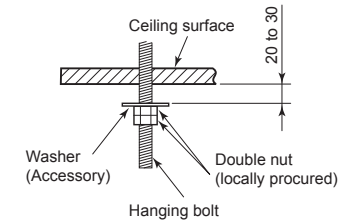

2 Hang the unit to the hanging bolt as shown the figure below.

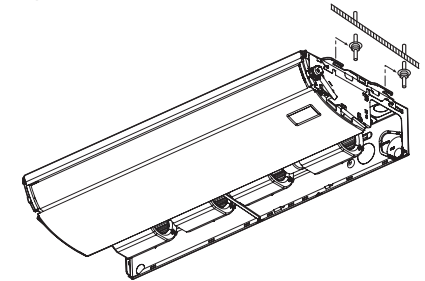

3 As shown in the figure below, fix the ceiling material securely with the double nuts.

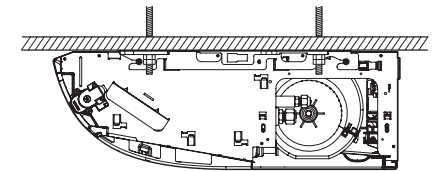

### ◆ Attaching the hanging bracket first

**1** Remove the screws fastening hanging bracket onto the indoor unit.

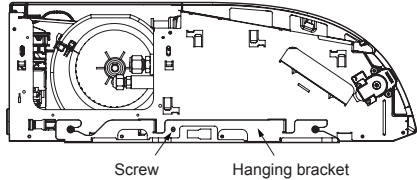

**2** Loosen the bolts fastening hanging bracket onto the indoor unit and remove the hanging bracket.

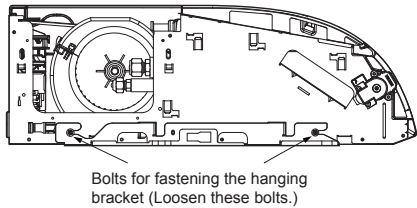

**3** Adjust the length of the two bolts for fastening the hanging bracket, as shown below.

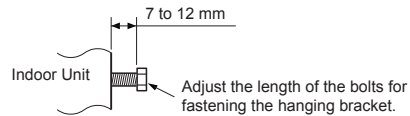

**4** Fasten the hanging bracket with the hanging bolts and ensure that the bracket is level from front to back and from side to side.

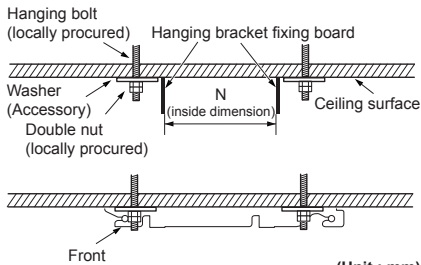

Model MMC-	N
UP015, UP018	867 to 872
UP024, UP027	1184 to 1189
UP036 to UP056	1501 to 1506

**5** Attach the indoor unit onto the hanging bracket and fasten it tight with the bolts and screws.

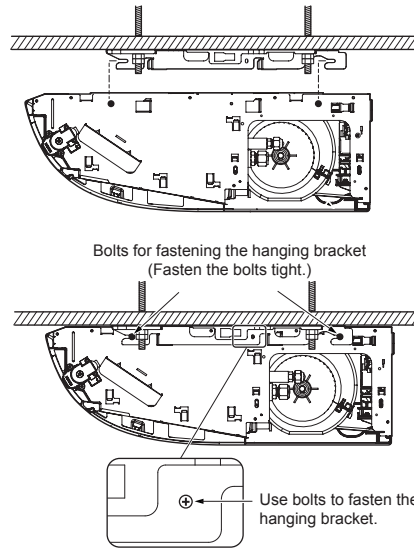

### ⚠ CAUTION

- The ceiling is not always level. Use the level gauge to measure the level of the ceiling in the width and depth directions. Adjust the bolts for the hanging brackets so that the level error will be within 5 mm.
- Do not lower the air discharge side and the side opposite to the selected drain pipe withdraw.

## 5 Drain piping

### ⚠ CAUTION

Following the Installation Manual, perform the drain piping work so that water is properly drained. Apply a heat insulation so as not to cause a dew condensation. Inappropriate piping work may result in water leakage in the room and wet furniture.

- Provide the indoor drain piping with proper heat insulation.
- Provide the area where the pipe connects to the indoor unit with proper heat insulation. Improper heat insulation will cause condensation to form.
- The drain pipe must be sloping downward (at an angle of 1/100 or more), and do not run the pipe up and down (arched shape) or allow it to form traps. Doing so may cause abnormal sounds.
- Restrict the length of the traversing drain pipe to 20 meters or less. For a long pipe, provide support brackets at intervals of 1.5 to 2 meters to prevent flapping.
- Install the collective piping as shown in the following figure.
- Do not provide any air vents. Otherwise, the drain water will spout, causing water to leak.
- Do not allow any force to be applied to the connection area with the drain pipe.
- A hard PVC pipe cannot be connected to the drain pipe connecting port of the indoor unit. Be absolutely sure to use the flexible hose provided for the connections with the drain pipe connecting port.
- Adhesive agents cannot be used for the drain pipe connecting port (hard socket) of the indoor unit. Be absolutely sure to secure the pipe using the hose bands provided. Use of an adhesive agent may damage the drain pipe connecting port or cause water to leak.

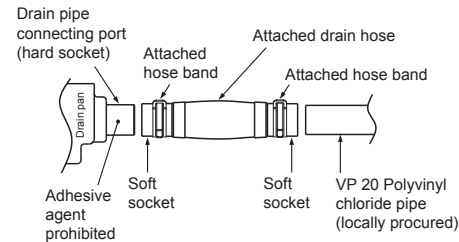
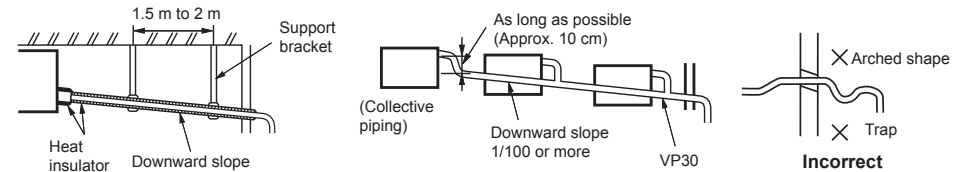

### ■ Pipe material, size and insulator

The following materials for piping work and insulating process are procured locally.

Pipe material	Hard vinyl chloride pipe VP20 (Nominal outer diameter 26 mm)
Insulator	Foamed polyethylene foam, thickness: 10 mm or more

## ■ Connection of drain hose

- Insert the attached drain hose into the drain pipe connecting port on the drain pan up to the end.
- Fit the attached hose band to the end of the pipe connecting port, and then tighten it securely.

### REQUIREMENT

- Fix the drain hose with the attached hose band, and set the tightening position upward.
- As the draining is the natural water draining, arrange the pipe outside of the unit on the down slope.
- If piping is performed as shown in the figure, drain cannot be discharged.

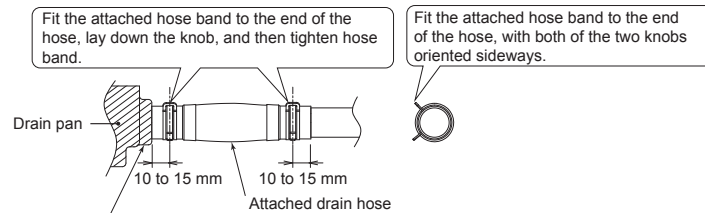
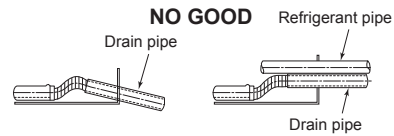

Confirm that soft hose is pushed in up to the end of the drain pan.

## ■ Connecting drain pipe

Connect the hard vinyl chloride pipe (locally procured) to the mounted drain hose which was attached. When Plug is detached, the drain pipe is not damaged. It causes the water leak.

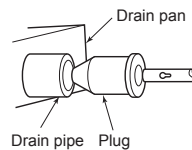

### In case of taking pipe from the left side

In case of taking pipe from the left side, exchange the plug from left to right. Push in the plug of which end is not sharp up to the end.

## ■ Drain up

When a down-gradient cannot be secured for the drain pipe, drain-up piping is possible.

- The height of the drain pipe must be 600 mm or less from the underside of the indoor unit.
- When Drain Pump Kit (sold separately) is installed, drain pipe and refrigerant pipe can only be connected from upper direction.

## ■ Heat insulating process

- Using the attached drain hose heat insulator, lap the connecting section and the drain hose without clearance, and then tighten with two handing band so that heat insulator does not open.
- Covering the attached drain hose heat insulator, lap the heat insulator (locally procured) to the drain pipe without clearance.

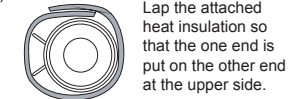
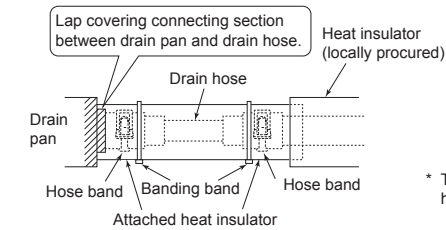

Lap the attached heat insulation so that the one end is put on the other end at the upper side.

- \* Tighten the banding band so that attached heat insulator is not pushed excessively.

- \* Fasten the binding bands in such a manner as to not squeeze the attached insulating material excessively.

# 6 Refrigerant piping

## ⚠ CAUTION

Use flare nuts that are included with the unit. Using different flare nuts may cause refrigerant gas leakage.

## ■ Refrigerant piping

Use the following item for the refrigerant piping.

**Material:** Seamless phosphorous de-oxidized copper pipe.

6.35, 9.52 and 12.7 wall thickness 0.8 mm or more.  
15.88 wall thickness 1.0 mm or more.

### REQUIREMENT

When the refrigerant pipe is long, provide support brackets at intervals of 2.5 - 3 m to clamp the refrigerant pipe. Otherwise, abnormal sound may be generated.

## ⚠ CAUTION

### IMPORTANT 4 POINTS FOR PIPING WORK

1. Reusable mechanical connectors and flared joints are not allowed indoors. When mechanical connectors are reused indoors, sealing parts shall be renewed.

When flared joints are reused indoors, the flare part shall be re-fabricated.

2. Tight connection (between pipes and unit)
3. Evacuate the air in the connecting pipes by using VACUUM PUMP.
4. Check the gas leakage. (Connected points)

## ■ Take out direction of refrigerant pipe

- The refrigerant pipe connecting sections are located as shown below. (Pipes can be taken out from one of the three directions.)
- Make a pipe knockout hole, referring to the section "Pipe knockout hole".

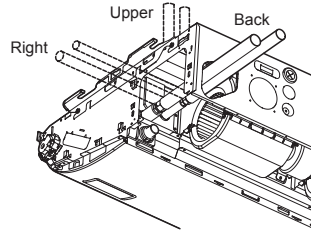

\* When Drain Pump Kit (sold separately) is installed, a refrigerant pipe can only be taken out from upper direction.

## ■ Permissible piping length and height difference

They vary depending on the outdoor unit. For details, refer to the Installation Manual attached to the outdoor unit.

## ■ Pipe size

Model MMC-	Pipe size (mm)	
	Gas side	Liquid side
UP015 to UP018	Ø12.7	Ø6.4
UP024 to UP056	Ø15.9	Ø9.5

## ■ Connecting refrigerant piping

### Flaring

1. **Cut the pipe with a pipe cutter.**  
Remove burrs completely. (Remaining burrs may cause gas leakage.)
2. **Insert a flare nut into the pipe, and flare the pipe.**  
Use the flare nut provided with the unit or the one used for the R32 or R410A refrigerant. The flaring dimensions for R32 or R410A are different from the ones used for the conventional R22 refrigerant. A new flare tool manufactured for use with the R32 or R410A refrigerant is recommended, but the conventional tool can still be used if the projection margin of the copper pipe is adjusted to be as shown in the following table.

### Projection margin in flaring: B (Unit: mm)

Outer dia. of copper pipe	Tool used	Conventional tool used
6.4, 9.5	0 to 0.5	1.0 to 1.5
12.7, 15.9		

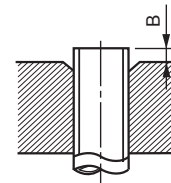

### Flaring diameter size: A (Unit: mm)

Outer dia. of copper pipe	A
	+0 -0.4
6.4	9.1
9.5	13.2
12.7	16.6
15.9	19.7

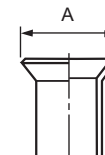

## ⚠ CAUTION

- Do not scratch the inner surface of the flared part when removing burrs.
- Flare processing under the condition of scratches on the inner surface of flare processing part will cause refrigerant gas leak.
- Check that the flared part is not scratched, deformed, stepped, or flattened, and that there are no chips adhered or other problems, after flare processing.
- Do not apply refrigerating machine oil to the flare surface.

- \* In case of flaring for R32 or R410A with the conventional flare tool, pull it out approx. 0.5 mm more than that for R22 to adjust to the specified flare size. The copper pipe gauge is useful for adjusting projection margin size.
- The sealed gas was sealed at the atmospheric pressure so when the flare nut is removed, there will no "whooshing" sound: This is normal and is not indicative of trouble.
- Use two wrenches to connect the indoor unit pipe.

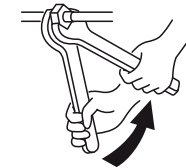

Work using double spanner

- Use the tightening torque levels as listed in the table below.

Outer dia. of connecting pipe (mm)	Tightening torque (N·m)
6.4	14 to 18 (1.4 to 1.8 kgf·m)
9.5	34 to 42 (3.4 to 4.2 kgf·m)
12.7	49 to 61 (4.9 to 6.1 kgf·m)
15.9	63 to 77 (6.3 to 7.7 kgf·m)

- Tightening torque of flare pipe connections. Pressure of R32 or R410A is higher than that of R22. (Approx. 1.6 times) Therefore, using a torque wrench, tighten the flare pipe connecting sections which connect the indoor and outdoor units of the specified tightening torque. Incorrect connections may cause not only a gas leak, but also a trouble of the refrigeration cycle.

## ⚠ CAUTION

Tightening with an excessive torque may crack the nut depending on installation conditions.



## ■ Evacuation

Perform vacuuming from the charge port of valve of the outdoor unit by using a vacuum pump.  
For details, follow to the Installation Manual attached to the outdoor unit.

- Do not use the refrigerant sealed in the outdoor unit for evacuation.

### REQUIREMENT

For the tools such as charge hose, use those manufactured exclusively for R32 or R410A.

## Refrigerant amount to be added

For addition of the refrigerant, add refrigerant "R32 or R410A" referring to the attached Installation Manual of outdoor unit.

Use a scale to charge the refrigerant of specified amount.

### REQUIREMENT

- Charging an excessive or too little amount of refrigerant causes a trouble of the compressor. Charge the refrigerant of specified amount.
- A personnel who charged the refrigerant should write down the pipe length and the added refrigerant amount in the F-GAS label of the outdoor unit. It is necessary to fix the compressor and refrigeration cycle malfunction.

## ■ Airtight test / Air purge, etc.

For air tightness test, vacuum drying and adding refrigerant, refer to the Installation Manual attached to the outdoor unit.

### ⚠ CAUTION

Do not supply power to the indoor unit until the airtight test and vacuuming are completed. (If the indoor unit is powered on, the pulse motor valve is fully closed, which extends the time for vacuuming.)

## Open the valve fully

Open the valve of the outdoor unit fully. A 4 mm-hexagonal wrench is required for opening the valve.  
For details, refer to the Installation Manual attached to the outdoor unit.

## Gas leak check

Check with a leak detector or soap water whether gas leaks or not, from the pipe connecting section or cap of the valve.

### REQUIREMENT

Use a leak detector manufactured exclusively for HFC refrigerant (R32, R134a, R410A, etc).

## Heat insulation process

Apply heat insulation for the pipes separately at liquid side and gas side.

- For the heat insulation to the pipes at gas side, use the material with heat-resisting temperature 120 °C or higher.
- To use the attached heat insulation pipe, apply the heat insulation to the pipe connecting section of the indoor unit securely without gap.

### REQUIREMENT

- Apply the heat insulation to the pipe connecting section of the indoor unit securely up to the root without exposure of the pipe. (The pipe exposed to the outside causes water leak.)
- Wrap heat insulator with its slits facing up (ceiling side).

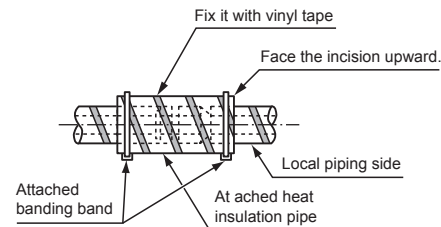

# 7 Electrical connection

### ⚠ WARNING

- **Use the specified wires for wiring connect the terminals. Securely fix them to prevent external forces applied to the terminals from affecting the terminals.**  
Incomplete connection or fixation may cause a fire or other trouble.
- **Connect earth wire. (grounding work)**  
Incomplete earthing cause an electric shock.  
Do not connect earth wires to gas pipes, water pipes, lightning conductor or telephone earth wires.
- **Appliance shall be installed in accordance with national wiring regulations.**  
Capacity shortage of power circuit or incomplete installation may cause an electric shock or a fire.

### ⚠ CAUTION

- **For communication line, use wires with the same type and size. If each wire has a different type and size from another one, it will cause a communication trouble.**
- If incorrect / incomplete wiring is carried out, it will cause an electrical fire or smoke.
- Install an earth leakage breaker that is not tripped by shock waves. If an earth leakage breaker is not installed, an electric shock may be caused.
- Use the cord clamps attached to the product.
- Do not damage or scratch the conductive core and inner insulator of power and system interconnection wires when peeling them.
- Use the power supply wire and control wires of specified thickness, type, and protective devices required.
- Do not connect 208-240V power to the terminal blocks (Uv (U1)), (Uv (U2)), (A), (B) for control wiring. (Otherwise, the system will fail.)
- Perform the electric wiring so that it does not come to contact with the high-temperature part of the pipe. The coating may melt resulting in an accident.

### REQUIREMENT

- For power supply wiring, strictly conform to the Local Regulation in each country.
- For wiring of power supply of the outdoor units, follow the Installation Manual of each outdoor unit.
- After connecting wires to the terminal blocks, provide a trap and fix wires with the cord clamp.
- Run the refrigerant piping line and control wiring line in the same line.
- Do not turn on the power of the indoor unit until vacuuming of the refrigerant pipes completes.

## ■ Power supply wire and communication wires specifications

Power supply wire and communication wires are locally procured.

For the power supply specifications, follow to the table below. If capacity is little, it is dangerous because overheat or burnout may be caused.

For specifications of the power capacity of the outdoor unit and the power supply wires, refer to the Installation Manual attached to the outdoor unit.

### Indoor unit power supply

- For the power supply of the indoor unit, prepare the exclusive power supply separated from that of the outdoor unit.
- Arrange the power supply, circuit breaker, and main switch of the indoor unit connected to the same outdoor unit so that they are commonly used.
- Power supply wire specification: Cable 3-core 2.5 mm<sup>2</sup>, in conformity with Design 60245 IEC 57.

▼ Power supply

Power supply	220-240V ~, 50 Hz 208-230V ~, 60 Hz	
Power supply switch / circuit breaker or power supply wiring / fuse rating for indoor units should be selected by the accumulated total current values of the indoor units.		
Power supply wiring	Below 50 m	2.5 mm <sup>2</sup>

**Control wiring, Central controller wiring**

- 2-core with polarity wires are used for the Control wiring between indoor unit and outdoor unit and Central controller wiring.
- To prevent noise trouble, use 2-core shield wire.
- The length of the communication line means the total length of the inter-unit wire length between indoor and outdoor units added with the central control system wire length.

▼ Communication line

TU2C-Link models (U series) can be combined with TCC-Link models (other than U series).  
For details of communication type, refer to the following table.

**Communication type and model names**

Communication type	TU2C-Link (U series and future models)	TCC-Link (Other than U series)
Outdoor unit	MMY-MUP*** ↑ This letter indicates U series model.	Other than U series MMY-MHP*** MCY-MHP*** MMY-MAP***
Indoor unit	MM*-UP*** ↑ This letter indicates U series model.	Other than U series MM*-AP***
Wired remote controller	RBC-ASCU*** ↑ This letter indicates U series model.	Other than U series
Wireless remote controller kit & receiver unit	RBC-AXU*** ↑ This letter indicates U series model.	Other than U series

U series outdoor unit : SMMS-u (MMY-MUP\*\*\*)

Other than U series outdoor unit : SMMS-i, SMMS-e etc. (MMY-MHP\*\*\*)

<In the case of combining with outdoor units of Super Modular Multi System u series (SMMS-u)>

<b>Uv line and Uc line (L2, L3, L4)</b> (2-core shield wire, non-polarity)	Wire size : 0.5 mm <sup>2</sup> (Up to 500 m) 0.75 to 1.25 mm <sup>2</sup> (Up to 1000 m)
<b>Uh line (L1)</b> (2-core shield wire, non-polarity)	Wire size : 0.75 to 1.25 mm <sup>2</sup> (Up to 1000 m) 2.0 mm <sup>2</sup> (Up to 2000 m)

- **U (v, h, c) line** means of control wiring.  
**Uv line** : Between indoor and outdoor units.  
**Uh line** : Central control line.  
**Uc line** : Between outdoor and outdoor units.
- **Uv line and Uc line** are independent from another refrigerant line. Total length of **Uv** and **Uc** lines (**L3+L4**) in each refrigerant line is up to 1000 m.

**[Uh line]**

**L1** = Up to 2000 m

**[Uv and Uc line]**

**L2** = Up to 1000 m

**(L3+L4)** = Up to 1000 m

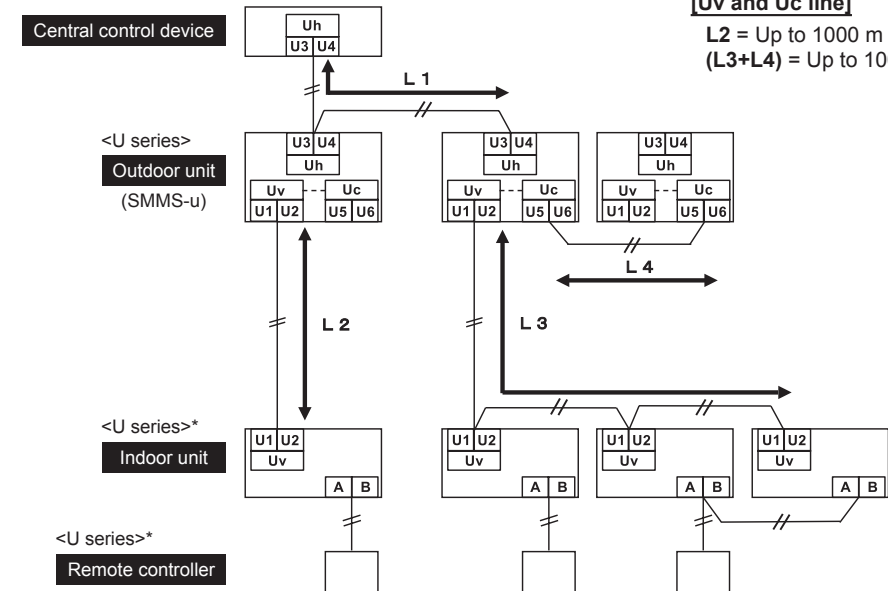

\* Even if the indoor unit and the remote controller are "other than U series", the wiring specification are the same.

<In the case of combining with outdoor units other than Super Modular Multi System u series (SMMS-u)>

Control wiring between indoor units, and outdoor unit (L2, L3) (2-core shield wire, non-polarity)	Wire size : 1.25 mm <sup>2</sup> (Up to 1000 m) 2.0 mm <sup>2</sup> (Up to 2000 m)
Central control line wiring (L1) (2-core shield wire, non-polarity)	
Control wiring between outdoor units (L4) (2-core shield wire, non-polarity)	Wire size : 1.25 to 2.0 mm <sup>2</sup> (Up to 100 m)

- The length of the communication line (L1+L2+L3) means the total length of the inter-unit wire length between indoor and outdoor units added with the central control system wire length.

**[Communication line]**

(L1+L2+L3) = Up to 2000 m

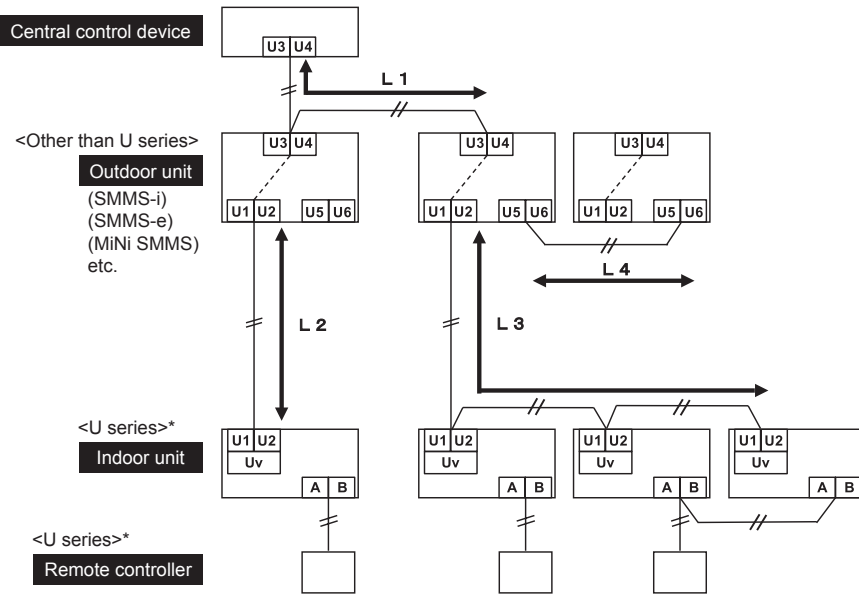

\* Even if the indoor unit and the remote controller are "other than U series", the wiring specification are the same.

**Remote controller wiring**

- 2-core with non-polarity wire is used for wiring of the remote controller wiring and group remote controllers wiring.

Remote controller wiring, remote controller inter-unit wiring	Wire size: 0.5 mm <sup>2</sup> to 2.0 mm <sup>2</sup>	
Total wire length of remote controller wiring and remote controller inter-unit wiring = L + L1 + L2 + ... Ln	In case of wired type only	Up to 500 m
	In case of wireless type included	Up to 400 m
Total wire length of remote controller inter-unit wiring = L1 + L2 + ... Ln	Up to 200 m	

**CAUTION**

- The remote controller wire (Communication line) and AC 208-240V wires cannot be parallel to contact each other and cannot be stored in the same conduits. If doing so, a trouble may be caused on the control system due to noise or other factor.
- If U series models (TU2C-Link) are combined with models other than U series (TCC-Link), the wiring specifications and maximum number of connectable indoor units will be changed. Pay attentions to their communication specifications when carrying out the installation, maintenance, or repair. For its details, refer to the "Communication line" in 7 Electrical connection.

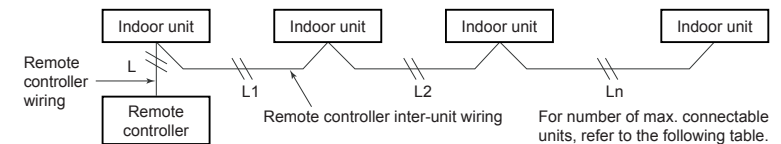

**Max. number of connectable indoor units, and communication type**

	Unit type							
	Outdoor unit	U series	U series	U series	U series	*	*	*
Indoor unit	U series	U series	*	*	U series	U series	*	*
Remote controller	U series	*	U series	*	U series	*	U series	*
Communication type	TU2C-Link	TCC-Link						
Max. number of connectable unit	16	8						

\* : Other than U series

## ◆ Wire connection

### REQUIREMENT

- Connect the wires matching the terminal numbers. Incorrect connection causes a trouble.
- Pass the wires through the bushing of wire connection holes of the indoor unit.
- Keep a margin (Approx. 100 mm) on a wire to hang down the electrical control box at servicing.
- The low-voltage circuit is provided for the remote controller. (Do not connect the high-voltage circuit)

- 1** Loosen the cover mounting screws (2 positions) of the electrical control box, and then remove the cover.
- 2** Connect the indoor power supply wire, system interconnection wires and the remote controller wire to the terminal block of the electrical control box.
- 3** Tighten screws of the terminal block securely, and fix the wires with code clamp attached to the electrical control box. (Do not apply tension to the connecting section of the terminal block.)
- 4** Mount the cover of the electrical control box so that it does not pinch the wires.

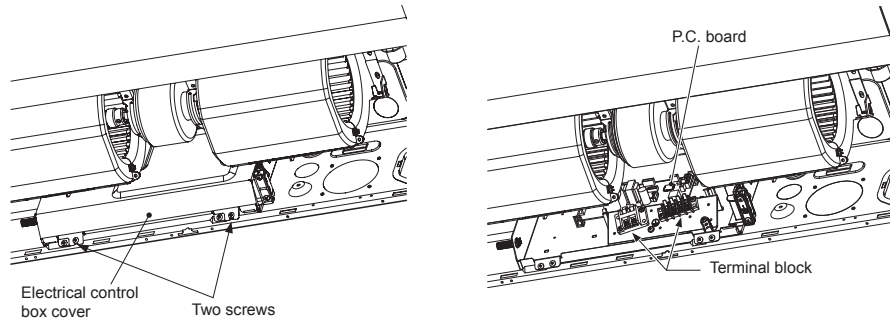

### ▼ Connecting power supply wire and the system interconnection wire

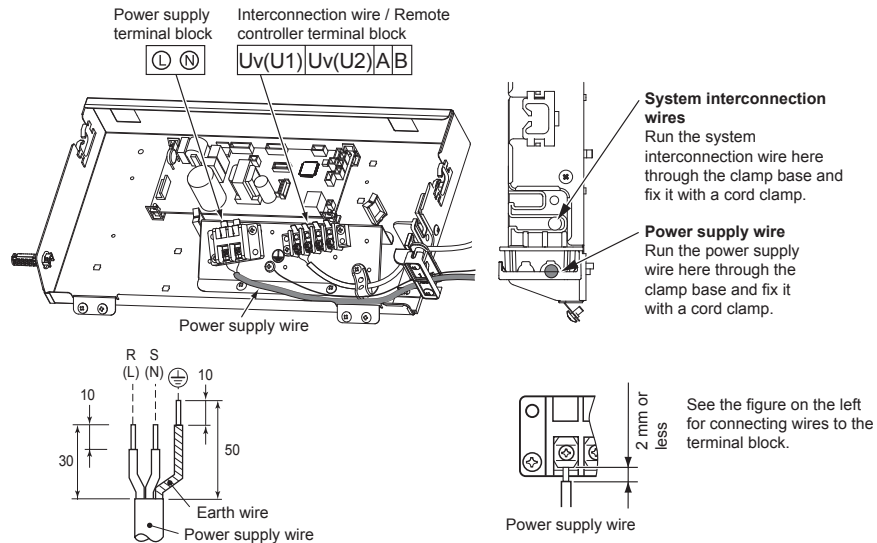

## ■ Remote controller wiring

Strip off approx. 9 mm the wire to be connected.

### Wiring diagram

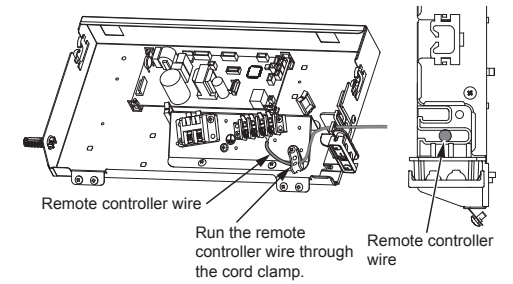
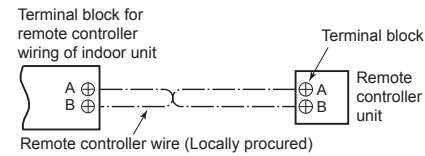

## ■ Wiring between indoor and outdoor units

### NOTE

- A wiring diagram below is an example for connection to SMMS-u series. For connecting to other outdoor unit series, refer to the Installation Manual attached to the outdoor unit to be connected.

### ▼ Wiring example

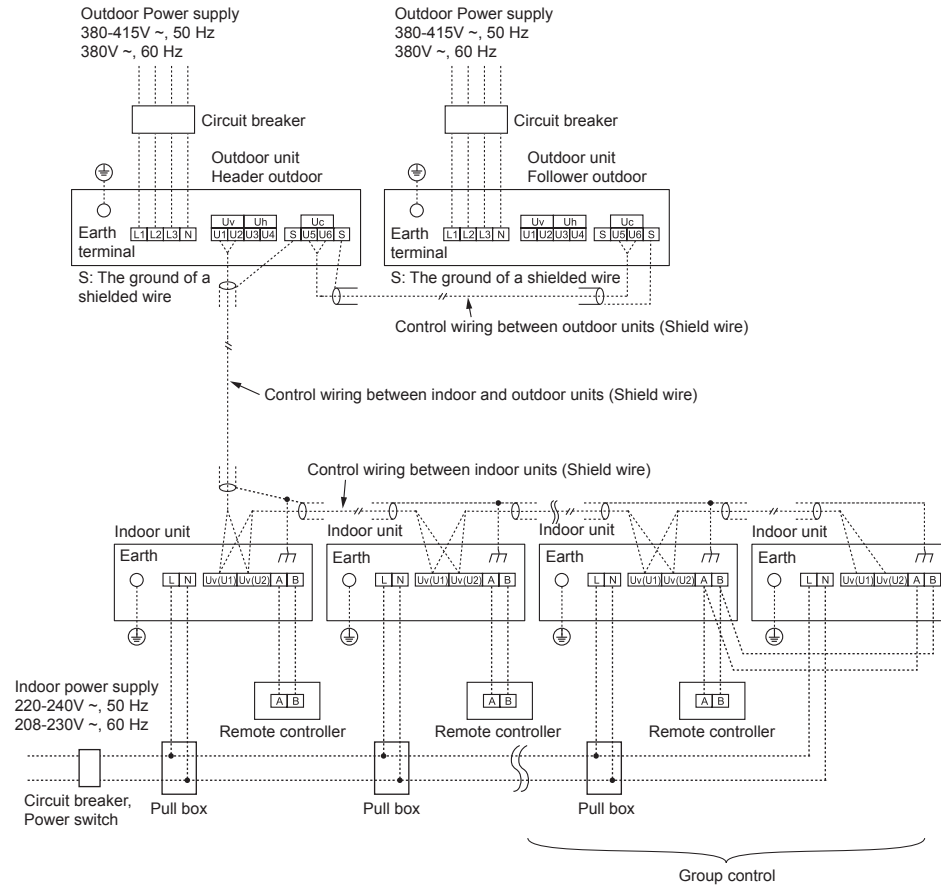

## ■ Address setup

Set up the addresses as per the Installation Manual supplied with the outdoor unit.

## 8 Applicable controls

### REQUIREMENT

When the air conditioner is used for the first time, it will take some moments after the power has been turned on before the remote controller becomes available for operations: This is normal and is not indicative of trouble.

- Concerning the automatic addresses (The automatic addresses are set up by performing operations on the outdoor interface circuit board.) While the automatic addresses are being set up, no remote controller operations can be performed. Setup takes up to 10 minutes (usually about 5 minutes).
- When the power is turned on after automatic address setup. It takes up to 10 minutes (usually about 3 minutes) for the outdoor unit to start operating after the power has been turned on.

Before the air conditioner was shipped from the factory, all units are set to [STANDARD] (factory default). If necessary, change the indoor unit settings. The settings are changed by operating the wired remote controller.

\* The settings cannot be changed using only a wireless remote controller, simple remote controller or group control remote controller by itself so install a wired remote controller separately as well.

## ■ Applicable controls setup (settings at the site)

### Remote controller model name: RBC-ASCU11-E

#### Basic procedure

Be sure to stop the air conditioner before making settings.

(Change the setup while the air conditioner is not working.)

#### ⚠ CAUTION

Set only the Code No. shown in the following table: Do NOT set any other Code No. If a Code No. not listed is set, it may not be possible to operate the air conditioner or other trouble with the product may result.

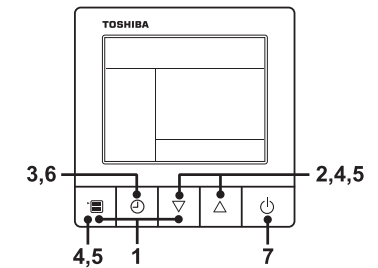

### 1 Push and hold menu button and [▽] setting button simultaneously for 10 seconds or more.

- After a while, the display flashes as shown in the figure. "ALL" is displayed as indoor unit numbers during initial communication immediately after the power has been turned on.

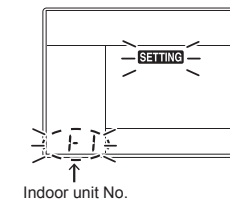

**2** Each time [▽][△] setting button is pushed, indoor unit numbers in the group control change cyclically. Select the indoor unit to change settings for.

- The fan of the selected indoor unit runs. The indoor unit can be confirmed for which to change settings.

**3** Push OFF timer button to confirm the selected indoor unit.

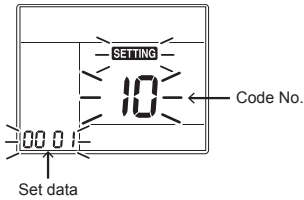

**4** Push the menu button to make Code No. [\*\*] flash. Change Code No. [\*\*] with [▽][△] setting button.

**5** Push the menu button to make Set data [\*\*\*\*] flash. Change Set data [\*\*\*\*] with [▽][△] setting button.

**6** Push OFF timer button. By doing so, the setup is completed.

- To change other settings of the selected indoor unit, repeat from Procedure 4.

**7** When all the settings have been completed, push ON/OFF button to determine the settings.

"SETTING" flashes and then the display content disappears and the air conditioner enters the normal stop mode. (The remote controller is unavailable while "SETTING" is flashing.)

- To change settings of another indoor unit, repeat from Procedure 1.

## ■ Installing indoor unit on high ceiling

When the height of the ceiling to be installed exceeds 3.5 m, adjustment of air volume is necessary.

Set up the high ceiling.

- Set according to the basic operation procedure (1 → 2 → 3 → 4 → 5 → 6).
- CODE No. in Procedure specifies [5d].
- Select [SET DATA] in Procedure from "List of installable ceiling height" in this Manual.
- For the CODE No. in Procedure 4, specify [5d].
- For the CODE No. in Procedure 5, select the SET DATA of ceiling height to be set up from the table on the below.

Model MMC-	UP015 to UP027	UP036 to UP056	SET DATA
Standard (Factory default)	Up to 3.5 m	Up to 3.5 m	0000
High ceiling (1)	Up to 4.0 m	Up to 4.3 m	0003

## ◆ Remote controller-less setting

Change the high-ceiling setting with the DIP switch on the indoor unit P.C. board.

- \* Once the setting is changed, setting to 0003 is possible, however setting to 0000 requires a setting data change to 0000 using the wired remote controller (separately sold) with the normal switch setting (factory default).

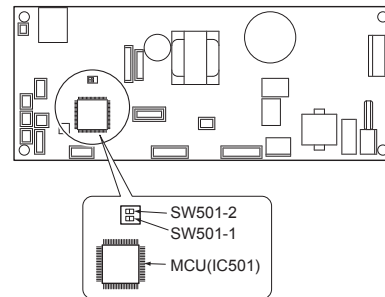

SET DATA	SW501-1	SW501-2
0000 (Factory default)	OFF	OFF
0003	OFF	ON

### To restore the factory defaults

To return the DIP switch settings to the factory defaults, set SW501-1 and SW501-2 to OFF, connect a separately sold wired remote controller, and then set the data of CODE No. [5d] to "0000".

## ■ Filter sign setting

According to the installation condition, the filter sign term (Notification of filter cleaning) can be changed.

Follow to the basic operation procedure

(1 → 2 → 3 → 4 → 5 → 6).

- For the CODE No. in Procedure 4, specify [01].
- For the [SET DATA] in Procedure 5, select the SET DATA of filter sign term from the following table.

SET DATA	Filter sign term
0000	None
0001	150H
0002	2500H (Factory default)
0003	5000H
0004	10000H

## ■ To secure better effect of heating

When it is difficult to obtain satisfactory heating due to installation place of the indoor unit or structure of the room, the detection temperature of heating can be raised. Also use a circulator or other device to circulate heat air near the ceiling.

Follow to the basic operation procedure

(1 → 2 → 3 → 4 → 5 → 6).

- For the CODE No. in Procedure 4, specify [06].
- For the set data in Procedure 5, select the SET DATA of shift value of detection temperature to be set up from the following table.

SET DATA	Detection temperature shift value
0000	No shift
0001	+1 °C
0002	+2 °C (Factory default)
0003	+3 °C
0004	+4 °C
0005	+5 °C
0006	+6 °C

## ■ Group control

In a group control, a remote controller can control up to maximum 8 or 16 units. (Depending on the outdoor unit.)

- For wiring procedure and wiring method of the individual line (Identical refrigerant line) system, refer to "Electrical connection" in this Manual.
- Wiring between indoor units in a group is performed in the following procedure. Connect the indoor units by connecting the remote controller inter-unit wires from the remote controller terminal blocks (A/B) of the indoor unit connected with a remote controller to the remote controller terminal blocks (A/B) of the other indoor unit. (Non-polarity)
- For address setup, refer to the Installation Manual attached to the outdoor unit.

## ■ Remote controller sensor

The temperature sensor of the indoor unit senses room temperature usually. Set the remote controller sensor to sense the temperature around the remote controller. Select items following the basic operation procedure (1 → 2 → 3 → 4 → 5 → 6).

- Specify [32] for the CODE No. in Procedure 4.
- Select the following data for the SET DATA in Procedure 5.

SET DATA	0000	0001
Remote controller sensor	Not used (factory default)	Used

When  flashes, the remote controller sensor is defective.

Select the SET DATA [0000] (not used) or replace the remote controller.



## 9 Test run

### ■ Before test run

- Before turning on the circuit breaker, carry out the following procedure.
  - 1) By using insulation tester (500V-megger), check that resistance of 1MΩ or more exists between the terminal block L to N and the earth (grounding). If resistance of less than 1MΩ is detected, do not run the unit.
  - 2) Check the valve of the outdoor unit being opened fully.
- To protect the compressor at activation time, leave power-ON for 12 hours or more for operating.
- Before starting a test run, be sure to set addresses following the Installation Manual supplied with the outdoor unit.

### ◆ Requirements for turning thermostat OFF

#### Cooling operation

- When the outdoor/suction air temperature is lower than or equal to 19 °C.
- When the outdoor/suction air temperature is lower than or equal to 3 °C above the set temperature.

#### Heating operation

- When the outdoor/suction air temperature is lower than or equal to -10 °C
- When the outdoor/suction air temperature is higher than or equal to 15 °C.
- When the outdoor/suction air temperature is higher than or equal to 3 °C above the set temperature.

### ■ Execute a test run

- When a fan operation is to be performed for an individual indoor unit, turn off the power, short circuit CN72 on the circuit board, and then turn the power back on. (Set the operation mode to “fan” to operate the unit.) When the test run has been performed using this method, be sure to release the short circuit of CN72 after the test run is completed.

Operate the unit with the remote controller as usual. For the procedure of the operation, refer to the Owner's Manual attached to the outdoor unit. A forced test run can be executed in the following procedure even if the operation stops by thermostat-OFF.

In order to prevent a serial operation, the forced test run is released after 60 minutes have passed and returns to the usual operation.

### ⚠ CAUTION

Do not use the forced test run for cases other than the test run because it applies an excessive load to the devices.

### Wired remote controller

Be sure to stop the air conditioner before making settings.

(Change the setup while the air conditioner is not working.)

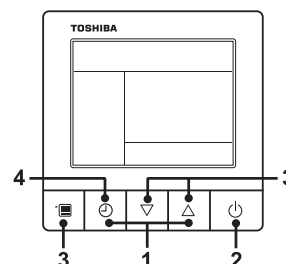

- 1 Push and hold OFF timer button and [△] setting button simultaneously for 10 seconds or more. [TEST] is displayed on the display part and the test run is permitted.

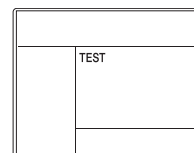

- 2 Push ON/OFF button.
- 3 Push menu button to select the operation mode. Select [❄️ Cool] or [🔥 Heat] with [▽] [△] setting button, and then push menu button (three times) again to determine the operation mode.
  - Do not run the air conditioner in a mode other than [Cool] or [Heat].
  - The temperature setting function does not work during test run.
  - The check code is displayed as usual.
- 4 After the test run, push OFF timer button to stop a test run. ([TEST] disappears on the display and the air conditioner enters the normal stop mode.)

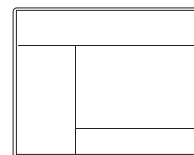

### Wireless remote controller

#### NOTE

- Be sure to operate the unit, following the instruction manual
- Do not run the air conditioner in forced cooling mode for a long time since it overloads the air conditioner.
- Forced heating is not available for trial runs. To perform a test run, set the unit to heating mode with the remote controller. The unit might not operate in heating mode, however, depending on temperature conditions.

- 1 Hold down the TEMPORARY button for over 10 seconds. With a beep sound, the unit is set to the forced cooling mode. In approximately three minutes, it is forced to start in cooling mode. Determine that cool air comes out of the unit. If the unit won't start, check the wiring.
- 2 Push the TEMPORARY button again (for about one second) to stop a trial run. The upper and lower wind direction changing blades close, and the unit stops operation.

#### Checking remote transmission

1. Push the ON/OFF button on the remote controller to determine that it works properly.
- Pushing the TEMPORARY button once (for about one second) causes the unit to enter auto operation mode. Hold down the TEMPORARY button for over 10 seconds to begin forced cooling.
  - Even if you select cooling with a remote controller, the unit does not always perform cooling operation, depending on temperature conditions. Check the wiring and piping of the indoor and outdoor units in forced cooling mode.

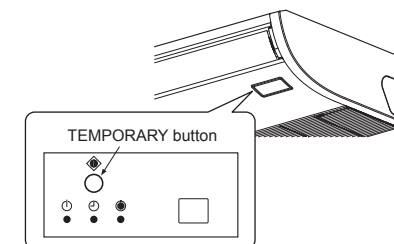

# 10 Maintenance

## <Daily maintenance>

### ▼ Cleaning of air filter

- If  is displayed on the remote controller, maintain the air filter.

- 1 Push the  button to stop the operation, then turn off the circuit breaker.

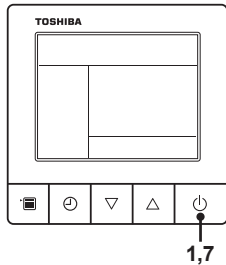

- 2 Open the air intake grille.

- Remove the screws of air intake grille fixing knob on a side of each filter.
- Slide the air intake grille fixing knobs (two positions) toward the arrow direction (OPEN), and then open the air intake grille.

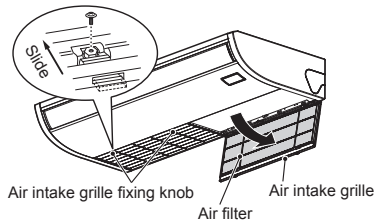

- 3 Take out air filter.

- Push the handle of the air filter, and remove the hook of the air intake grille. Pull out the air filter toward you.

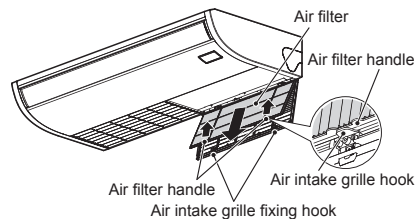

- 4 Cleaning with water or vacuum cleaner.

- If dust is heavy, wash it with tepid water including neutral detergent or water.

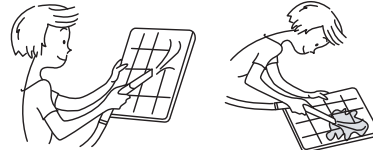



- After cleaning with water, dry it completely in the shade.

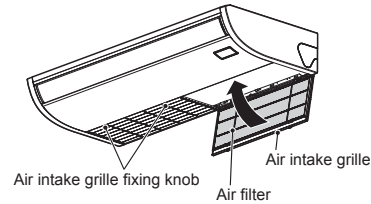

- 5 Mount the air filter.

- 6 Close the air intake grille.

- Close the air intake grille, and then fix it securely while sliding knob closed side (CLOSE).
- Fix the screws of air intake grille fixing knob on a side of each filter.



- 7 Turn on the circuit breaker, then push the  button on the remote controller to start the operation.

- 8 After cleaning, push .  display disappears.

### ⚠ CAUTION

- Do not start the air conditioner while leaving air filter removed.
- Push the filter reset button. ( indication will be turn off.)

### ▼ Periodic Maintenance

- For environmental conservation, it is strongly recommended that the indoor and outdoor units of the air conditioner in use be cleaned and maintained regularly to ensure efficient operation of the air conditioner. When the air conditioner is operated for a long time, periodic maintenance (once a year) is recommended. Furthermore, regularly check the outdoor unit for rust and scratches, and remove them or apply rustproof treatment, if necessary.

As a general rule, when an indoor unit is operated for 8 hours or more daily, clean the indoor unit and outdoor unit at least once every 3 months. Ask a professional for this cleaning / maintenance work. Such maintenance can extend the life of the product though it involves the owner's expense.

Failure to clean the indoor and outdoor units regularly will result in poor performance, freezing, water leakage, and even compressor failure.

### Inspection before maintenance

Following inspection must be carried out by a qualified installer or qualified service person.

Parts	Inspection method
Heat exchanger	Look through the air discharge port to check the part. Examine the heat exchanger if there is any clogging or damages.
Fan motor	Check if any abnormal noise can be heard.
Fan	Check if any abnormal noise can be heard.
Filter	Go to installed location and check if there are any stains or breaks on the filter.
Drain pan	Look through the air discharge port to check the part. Check if there is any clogging or drain water is polluted.

### ▼ Maintenance List

Part	Unit	Check (visual / auditory)	Maintenance
Heat exchanger	Indoor / outdoor	Dust / dirt clogging, scratches	Wash the heat exchanger when it is clogged.
Fan motor	Indoor / outdoor	Sound	Take appropriate measures when abnormal sound is generated.
Filter	Indoor	Dust / dirt, breakage	<ul style="list-style-type: none"> <li>• Wash the filter with water when it is contaminated.</li> <li>• Replace it when it is damaged.</li> </ul>
Fan	Indoor	<ul style="list-style-type: none"> <li>• Vibration, balance</li> <li>• Dust / dirt, appearance</li> </ul>	<ul style="list-style-type: none"> <li>• Replace the fan when vibration or balance is terrible.</li> <li>• Brush or wash the fan when it is contaminated.</li> </ul>
Air intake / discharge grilles	Indoor / outdoor	Dust / dirt, scratches	Fix or replace them when they are deformed or damaged.
Drain pan	Indoor	Dust / dirt clogging, drain contamination	Clean the drain pan and check the downward slope for smooth drainage.
Ceiling panel, louvres	Indoor	Dust / dirt, scratches	Wash them when they are contaminated or apply repair coating.
Exterior	Outdoor	<ul style="list-style-type: none"> <li>• Rust, peeling of insulator</li> <li>• Peeling / lift of coat</li> </ul>	Apply repair coating.

# 11 Troubleshooting

## ■ Confirmation and check

If a problem occurs with the air conditioner, the OFF timer indicator alternately shows the check code and the indoor Unit No. in which the problem occurred.

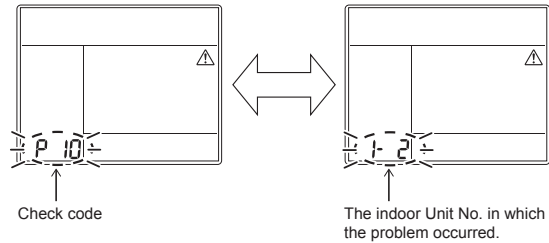

## ■ Troubleshooting history and confirmation

You can check the troubleshooting history with the following procedure if a problem occurs with the air conditioner. (The troubleshooting history records up to 4 incidents.)

You can check it during operation or when operation is stopped.

- If you check the troubleshooting history during OFF timer operation, the OFF timer will be canceled.

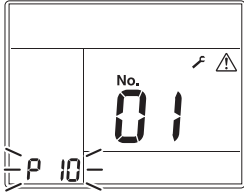
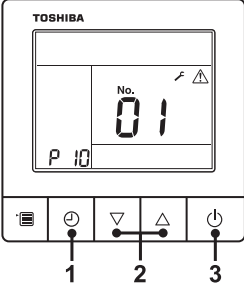
Procedure	Description of operation
1	<p>Push the OFF timer button for over 10 seconds and the indicators appear as an image indicating the troubleshooting history mode has been entered. If [Service check] is displayed, the mode enters in the troubleshooting history mode.</p> <ul style="list-style-type: none"> <li>• [01: Order of troubleshooting history] appears in the temperature indicator.</li> <li>• The OFF timer indicator alternately shows the [check code] and the [indoor Unit No. ] in which the problem occurred.</li> </ul> 
2	<p>Each time the setting button is pushed, the recorded troubleshooting history is displayed in sequence. The troubleshooting history appears in order from [01] (newest) to [04] (oldest).</p> <p><b>CAUTION</b></p> <p>In the troubleshooting history mode, DO NOT push the Menu button for over 10 seconds, doing so deletes the entire troubleshooting history of the indoor unit.</p> 
3	<p>After you have finished checking, push the ON/OFF button to return to the regular mode.</p> <ul style="list-style-type: none"> <li>• If the air conditioner is operating, it remains operated even after the ON/OFF button has been pushed. To stop its operation, push the ON/OFF button again.</li> </ul>

**Check method**

On the wired remote controller, central control remote controller and the interface P.C. board of the outdoor unit (I/F), a check display LCD (Remote controller) or 7-segment display (on the outdoor interface P.C. board) to display the operation is provided. Therefore the operation status can be known. Using this self-diagnosis function, a trouble or position with error of the air conditioner can be found as shown in the table.

**Check code list**

The following list shows each check code. Find the check contents from the list according to part to be checked.

- In case of check from indoor remote controller: See "Wired remote controller display" in the list.
- In case of check from outdoor unit: See "Outdoor unit 7-segment display" in the list.
- In case of check from indoor unit with a wireless remote controller: See "Sensor block display of receiving unit" in the list.

○ : Lighting, ◻ : Flashing, ● : Goes off  
 ALT: Flashing is alternately when there are two flashing LED.  
 SIM: Simultaneous flashing when there are two flashing LED.  
 Inverter: Compressor / Fan Inverter P.C. board  
 I/F : Interface P.C. board

Check code			Wireless remote controller				Check code name	Judging device
Wired remote controller display	Outdoor unit 7-segment display		Sensor block display of receiving unit					
		Auxiliary code	Operation	Timer	Ready	Flash		
E01	—	—	◻	●	●		Communication trouble between indoor unit and remote controller (Detected at remote controller side)	Remote controller
E02	—	—	◻	●	●		Remote controller transmission trouble	Remote controller
E03	—	—	◻	●	●		Communication trouble between indoor unit and remote controller (Detected at indoor unit side)	Indoor unit
E04	—	—	●	●	◻		Communication circuit trouble between indoor / outdoor unit (Detected at indoor unit side)	Indoor unit
E06	E06	No. of indoor units in which sensor has been normally received	●	●	◻		Decrease of No. of indoor units	I/F
—	E07	—	●	●	◻		Communication circuit trouble between indoor / outdoor unit (Detected at outdoor unit side)	I/F
E08	E08	Duplicated indoor unit addresses	◻	●	●		Duplicated indoor unit addresses	Indoor unit • I/F
E09	—	—	◻	●	●		Duplicated master remote controllers	Remote controller
E10	—	—	◻	●	●		Communication trouble between indoor unit MCU	Indoor unit
E11	—	—	◻	●	●		Communication trouble between Application control kit and indoor unit	Indoor unit Application control kit
E12	E12	01: Indoor / Outdoor units communication 02: Outdoor / Outdoor units communication	◻	●	●		Automatic address start trouble	I/F
E15	E15	—	●	●	◻		No indoor unit during automatic addressing	I/F
E16	E16	00: Capacity over 01: No. of connected units	●	●	◻		Capacity over / No. of connected indoor units	I/F
E17	—	—	◻	●	●		Communication trouble between indoor unit and Flow Selector unit	Indoor unit
E18	—	—	◻	●	●		Communication trouble between header and follower units Indoor unit	Indoor unit
E19	E19	00: Header is not detected 02: Two or more header units	●	●	◻		Outdoor header units quantity trouble	I/F
E20	E20	01: Outdoor unit of other line connected 02: Indoor unit of other line connected	●	●	◻		Other line connected during automatic address	I/F
E23	E23	—	●	●	◻		Sending trouble in communication between outdoor units Trouble in number of heat storage units (trouble with reception)	I/F
E25	E25	—	●	●	◻		Duplicated follower outdoor addresses	I/F
E26	E26	No. of outdoor units which received signal normally	●	●	◻		Decrease of No. of connected outdoor units	I/F
E28	E28	Detected outdoor unit number	●	●	◻		Follower outdoor unit trouble	I/F
E31	E31	*1 Inverter quantity information	●	●	◻		Inverter communication trouble	I/F
F01	—	—	◻	◻	●	ALT	Indoor unit TCJ sensor trouble	Indoor unit
F02	—	—	◻	◻	●	ALT	Indoor unit TC2 sensor trouble	Indoor unit
F03	—	—	◻	◻	●	ALT	Indoor unit TC1 sensor trouble	Indoor unit
F04	F04	—	◻	◻	○	ALT	TD1 sensor trouble	I/F
F05	F05	—	◻	◻	○	ALT	TD2 sensor trouble	I/F

Check code		Wireless remote controller				Check code name	Judging device	
Wired remote controller display	Outdoor unit 7-segment display		Sensor block display of receiving unit					
	Auxiliary code		Operation	Timer	Ready			Flash
F06	F06	01: TE1 sensor 02: TE2 sensor 03: TE3 sensor	☐	☐	○	ALT	TE1,TE2 or TE3 sensor trouble	I/F
F07	F07	01: TL1 sensor 02: TL2 sensor 03: TL3 sensor	☐	☐	○	ALT	TL1,TL2 or TL3 sensor trouble	I/F
F08	F08	—	☐	☐	○	ALT	TO sensor trouble	I/F
F09	F09	01: TG1 sensor 02: TG2 sensor 03: TG3 sensor	☐	☐	○	ALT	TG1,TG2 or TG3 sensor trouble	I/F
F10	—	—	☐	☐	●	ALT	Indoor unit TA sensor trouble	Indoor unit
F11	—	—	☐	☐	●	ALT	TF sensor trouble	Indoor unit
F12	F12	01: TS1 sensor 03: TS3 sensor 04: TS3 sensor disconnect	☐	☐	○	ALT	TS1 or TS3 sensor trouble	I/F
F13	F13	1 *: Comp. 1 side 2 *: Comp. 2 side	☐	☐	○	ALT	TH sensor trouble	Inverter
F15	F15	—	☐	☐	○	ALT	Outdoor unit temp. sensor miswiring (TE, TL)	I/F
F16	F16	—	☐	☐	○	ALT	Outdoor unit pressure sensor miswiring (Pd, Ps)	I/F
F22	F22	—	☐	☐	○	ALT	TD3 sensor trouble	I/F
F23	F23	—	☐	☐	○	ALT	Ps sensor trouble	I/F
F24	F24	—	☐	☐	○	ALT	Pd sensor trouble	I/F
F29	—	—	☐	☐	●	SIM	Indoor unit other trouble	Indoor unit
F30	F30	—	☐	☐	○	SIM	Occupancy sensor trouble	Indoor unit
F31	F31	—	☐	☐	○	SIM	Indoor unit EEPROM trouble	I/F
H01	H01	1 *: Comp. 1 side 2 *: Comp. 2 side	●	☐	●		Compressor break down	Inverter
H02	H02	1 *: Comp. 1 side 2 *: Comp. 2 side	●	☐	●		Compressor trouble (lock)	Inverter
H03	H03	1 *: Comp. 1 side 2 *: Comp. 2 side	●	☐	●		Current detect circuit system trouble	Inverter
H04	H04	—	●	☐	●		Comp. 1 case thermostat operation	I/F
H05	H05	—	●	☐	●		TD1 sensor miswiring	I/F
H06	H06	—	●	☐	●		Low pressure protective operation	I/F
H07	H07	—	●	☐	●		Oil level down detective protection	I/F
H08	H08	01: TK1 sensor trouble 02: TK2 sensor trouble 03: TK3 sensor trouble 04: TK4 sensor trouble 05: TK5 sensor trouble	●	☐	●		Oil level detective temp. sensor trouble	I/F
H14	H14	—	●	☐	●		Comp. 2 case thermostat operation	I/F
H15	H15	—	●	☐	●		TD2 sensor miswiring	I/F
H16	H16	01: TK1 oil circuit system trouble 02: TK2 oil circuit system trouble 03: TK3 oil circuit system trouble 04: TK4 oil circuit system trouble 05: TK5 oil circuit system trouble	●	☐	●		Oil level detective circuit trouble	I/F
H17	H17	1 *: Comp. 1 side 2 *: Comp. 2 side	●	☐	●		Compressor trouble (Step out)	I/F
H25	H25	—	●	☐	●		TD3 sensor miswiring	I/F
J02	—	Detected indoor unit address T—	●	☐	☐	SIM	Communication trouble between control boards in Flow Selector unit	Indoor unit

Check code		Wireless remote controller				Check code name	Judging device	
Wired remote controller display	Outdoor unit 7-segment display		Sensor block display of receiving unit					
		Auxiliary code	Operation	Timer	Ready			Flash
J03	—	—	●	○	○	SIM	Duplicated Flow Selector unit addresses	Indoor unit
J10	J10	Detected indoor unit address	●	○	○	SIM	Flow Selector unit overflow trouble	Indoor unit
J11	—	—	●	○	○	SIM	Flow Selector unit temperature sensor (TCS) trouble	
J29	—	—	●	○	○	SIM	Refrigerant leak detection sensor trouble	Indoor unit
J30	J30	Detected indoor unit address *Not displayed depending on the DN code (I.DN) setting	●	○	○	SIM	Refrigerant leak detection	Indoor unit
J31	—	—	●	○	○	SIM	Refrigerant leak detection sensor exceeding its life of the product	Indoor unit
L02	L02	Detected indoor unit address	○	●	○	SIM	Model mismatch of indoor and outdoor unit Indoor unit incompatible with A2L (R32) refrigerant	I/F
L03	—	—	○	●	○	SIM	Indoor unit centre unit duplicated	Indoor unit
L04	L04	—	○	○	○	SIM	Outdoor unit line address duplicated	I/F
L05	—	—	○	●	○	SIM	Duplicated indoor units with priority (Displayed in indoor unit with priority)	I/F
L06	L06	No. of indoor units with priority	○	●	○	SIM	Duplicated indoor units with priority (Displayed in unit other than indoor unit with priority)	I/F
L07	—	—	○	●	○	SIM	Group line in individual indoor unit	Indoor unit
L08	L08	—	○	●	○	SIM	Indoor unit group / Address unset	Indoor unit, I/F
L09	—	—	○	●	○	SIM	Indoor unit capacity unset	Indoor unit
L10	L10	—	○	○	○	SIM	Outdoor unit capacity unset	I/F
L11	L11	Detected indoor unit address	○	○	○	SIM	Flow Selector unit not connected	I/F
L12	L12	01: Flow Selector unit installation trouble	○	○	○	SIM	Flow Selector unit system trouble	I/F
L13	L13	Detected indoor unit address	○	○	○	SIM	Safety device setting unmatch	I/F
L14	L14	Detected indoor unit address	○	○	○	SIM	Safety device nonconformity	I/F
L17	L17	—	○	○	○	SIM	Outdoor unit type mismatch trouble	I/F
L18	L18	Detected indoor unit address	○	○	○	SIM	Flow selector unit trouble	I/F
L20	—	—	○	○	○	SIM	Duplicated central control addresses	Indoor unit
L22	—	—	○	○	○	SIM	There is a DX-kit (heat source capacity command) non-compliant machine in the group (DDC control, TA control and TF control are mixed)	Indoor unit
L24	L24	01: Duplication of Flow Selector unit address 02: Indoor unit operation mode priority setting	○	○	○	SIM	Flow Selector unit setting trouble	I/F
L28	L28	—	○	○	○	SIM	Too many outdoor units connected	I/F
L29	L29	*1 Inverter quantity information	○	○	○	SIM	No. of inverter trouble	I/F
L30	L30	Detected indoor unit address	○	○	○	SIM	Indoor unit outside interlock	Indoor unit
—	L31	—	—	—	—	—	Extended I/C trouble	I/F
P01	—	—	●	○	○	ALT	Indoor fan motor trouble	Indoor unit
P03	P03	—	○	●	○	ALT	Discharge temp. TD1 trouble	I/F
P04	P04	1 *: Comp. 1 side 2 *: Comp. 2 side	○	●	○	ALT	High-pressure SW system operation	Inverter
P05	P05	1 *: Comp. 1 side 2 *: Comp. 2 side	○	●	○	ALT	Phase missing detection / Power failure detection Inverter DC voltage trouble (comp.)	I/F
P07	P07	1 *: Comp. 1 side 2 *: Comp. 2 side 04: Heat sink	○	●	○	ALT	Heat sink overheat trouble Heat sink dew condensation trouble	Inverter, I/F
P10	P10	Detected indoor unit address	●	○	○	ALT	Indoor unit overflow trouble	Indoor unit
P11	P11	—	●	○	○	ALT	Outdoor heat exchanger freezing trouble	I/F
P12	—	—	●	○	○	ALT	Indoor unit fan motor trouble	Indoor unit
P13	P13	—	●	○	○	ALT	Outdoor liquid back detection trouble	I/F
P15	P15	01: TS condition 02: TD condition	○	●	○	ALT	Gas leak detection	I/F
P16	P16	01: PMV5 02: PMV6 03: SV7	○	●	○	ALT	Injection circuit trouble	I/F



Wired remote controller display	Check code		Wireless remote controller				Check code name	Judging device
	Outdoor unit 7-segment display		Sensor block display of receiving unit					
		Auxiliary code	Operation	Timer	Ready	Flash		
P17	P17	—	□	●	□	ALT	Discharge temp. TD2 trouble	I/F
P18	P18	—	□	●	□	ALT	Discharge temp. TD3 trouble	I/F
P19	P19	0#: 4-way valves 1#: 4-way valve1 2#: 4-way valve2 *Put in outdoor unit No. in [#] mark.	□	●	□	ALT	4-way valve inverse trouble	I/F
P20	P20	—	□	●	□	ALT	High-pressure protective operation	I/F
P22	P22	1 *: Compressor 1 side 2 *: Compressor 2 side	□	●	□	ALT	Outdoor unit fan inverter trouble	Inverter
P26	P26	1 *: Comp. 1 side 2 *: Comp. 2 side	□	●	□	ALT	IPM short protection trouble	Inverter
P29	P29	1 *: Comp. 1 side 2 *: Comp. 2 side	□	●	□	ALT	Comp. position detective circuit system trouble	Inverter
P31	—	—	□	●	□	ALT	Other indoor unit trouble (Group follower indoor unit trouble)	Indoor unit

\* For details about check codes determined with an Interface P.C. board or an Inverter P.C. board, refer to the Installation Manual of the outdoor unit.

#### \*1 Inverter quantity information

(Super Modular Multi System e and u series (SMMS-e, SMMS-u, SHRM-A))

No.	Comp. Inverter		Fan Inverter		Trouble
	1	2	1	2	
01	○				Comp. 1
02		○			Comp. 2
03	○	○			Comp. 1 + Comp. 2
08			○		Fan1
09	○		○		Comp. 1 + Fan1
0A		○	○		Comp. 2 + Fan1
0B	○	○	○		Comp. 1 + Comp. 2 + Fan1
10				○	Fan2
11	○			○	Comp. 1 + Fan2
12		○		○	Comp. 2 + Fan2
13	○	○		○	Comp. 1 + Comp. 2 + Fan2
18			○	○	Fan1 + Fan2
19	○		○	○	Comp. 1 + Fan1 + Fan2
1A		○	○	○	Comp. 2 + Fan1 + Fan2
1B	○	○	○	○	All
○ : Inverter trouble					

#### Trouble detected by central control device

Central control device indication	Check code		Wireless remote controller				Check code name	Judging device
	Outdoor unit 7-segment display		Sensor block display of receiving unit					
		Auxiliary code	Operation	Timer	Ready	Flash		
C05	—	—			—		Sending trouble in central control device	Central control device
C06	—	—			—		Receiving trouble in central control device	Central control device
C12	—	—			—		Batch alarm of general-purpose equipment control interface	General-purpose equipment I/F
P30 (L20)	Differs according to trouble contents of unit with occurrence of alarm						Group control follower unit trouble	Central control device
	—	—				(L20 is displayed.)	<ul style="list-style-type: none"> <li>• Duplication addresses of indoor units in central control device</li> <li>• With the combination of air conditioning system, the indoor unit may detect the check code of L20</li> </ul>	
S01	—	—			—		Receiving trouble in central control device	Central control device

# 12 Specifications

Model	Sound power level (dBA)		Weight (kg)
	Cooling	Heating	
MMC-UP0151HP-E	*	*	24
MMC-UP0181HP-E	*	*	24
MMC-UP0241HP-E	*	*	30
MMC-UP0271HP-E	*	*	30
MMC-UP0361HP-E	*	*	39
MMC-UP0481HP-E	*	*	39
MMC-UP0561HP-E	*	*	39

\* Under 70 dBA

# 13 Notice code

- Notice code is a function only in TC2U-Link communication.
- When the outdoor or indoor unit detects its conditions requiring caution or maintenance, this function notices you to check your units with the spanner mark (Notice code mark) on the wired remote controller or central controller display.
- Even while the notice code mark is displayed, the air conditioner can operate normally.
- A maximum of 5 notice codes can be issued simultaneously in one system (line).

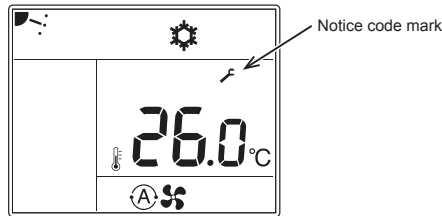

## How to check Notice code No.

- 1 Stop the operation of the air conditioner and push the Menu button and OFF timer button at the same time for 10 seconds or more.
- 2 The unit number of the indoor unit is displayed at the bottom left of the screen. Change it with the [▽] [△] setting button and push the OFF timer button to confirm.
- 3 The history number is displayed in the center of the screen, and the Notice code No. is displayed in the lower left. [▽] [△] You can switch the history with the setting button (a maximum of 5 notice codes).
- 4 Push the ON / OFF button to return to the operation stop screen.

## Notice code list

Notice code No.	Item	Content
203	Flow Selector unit battery dead	The battery kit connected to the Flow Selector unit has reached the end of its life.
204	Leak detector life advance display	The leak detector will soon reach the end of its life.

# 14 Appendix

## Work instructions

The existing R22 and R410A piping can be reused for inverter R32 product installations.

### ! WARNING

**Confirming the existence of scratches or dents on the existing pipes and confirming the reliability of the pipe strength are conventionally referred to the local site.**

**If the specified conditions can be cleared, it is possible to update existing R22 and R410A pipes to those for R32 models.**

### Basic conditions needed to reuse existing pipes

Check and observe the presence of three conditions in the refrigerant piping works.

1. **Dry** (There is no moisture inside of the pipes.)
2. **Clean** (There is no dust inside of the pipes.)
3. **Tight** (There are no refrigerant leaks.)

### Restrictions for use of existing pipes

**In the following cases, the existing pipes should not be reused as they are. Clean the existing pipes or exchange them with new pipes.**

1. When a scratch or dent is heavy, be sure to use new pipes for the refrigerant piping works.
  - The operating pressure of refrigerant is high. If there is a scratch or dent on the pipe or a thinner pipe is used, the pressure strength may be inadequate, which may cause the pipe to break in the worst case.

### \* Pipe diameter and thickness (mm)

Pipe outer diameter		Ø6.4	Ø9.5	Ø12.7	Ø15.9
Thickness	R32, R410A	0.8	0.8	0.8	1.0
	R22				

3. When the outdoor unit was left with the pipes disconnected, or the gas leaked from the pipes and the pipes were not repaired and refilled.
  - There is the possibility of rain water or air, including moisture, entering the pipe.
4. When refrigerant cannot be recovered using a refrigerant recovery unit.
  - There is the possibility that a large quantity of dirty oil or moisture remains inside the pipes.

5. When a commercially available dryer is attached to the existing pipes.

- There is the possibility that copper green rust has been generated.

6. When the existing air conditioner is removed after refrigerant has been recovered.

Check if the oil is judged to be clearly different from normal oil.

- The refrigerator oil is copper rust green in color: There is the possibility that moisture has mixed with the oil and rust has been generated inside the pipe.
- There is discolored oil, a large quantity of residue, or a bad smell.
- A large quantity of shiny metal dust or other wear residue can be seen in the refrigerant oil.

7. When the air conditioner has a history of the compressor failing and being replaced.

- When discolored oil, a large quantity of residue, shiny metal dust, or other wear residue or mixture of foreign matter is observed, trouble will occur.

8. When temporary installation and removal of the air conditioner are repeated such as when leased etc.

9. If the type of refrigerator oil of the existing air conditioner is other than the following oil (Mineral oil), Suniso, Freol-S, MS (Synthetic oil), alkyl benzene (HAB, Barrel-freeze), ester series, PVE only of ether series.

- The winding-insulation of the compressor may deteriorate.

### NOTE

The above descriptions are results have been confirmed by our company and represent our views on our air conditioners, but do not guarantee the use of the existing pipes of air conditioners that have adopted R32, R410A in other companies

### Curing of pipes

When removing and opening the indoor or outdoor unit for a long time, cure the pipes as follows:

- Otherwise rust may be generated when moisture or foreign matter due to condensation enters the pipes.
- The rust cannot be removed by cleaning, and new pipes are necessary.

Placement location	Term	Curing manner
Outdoors	1 month or more	Pinching or taping
	Less than 1 month	
Indoors	Every time	

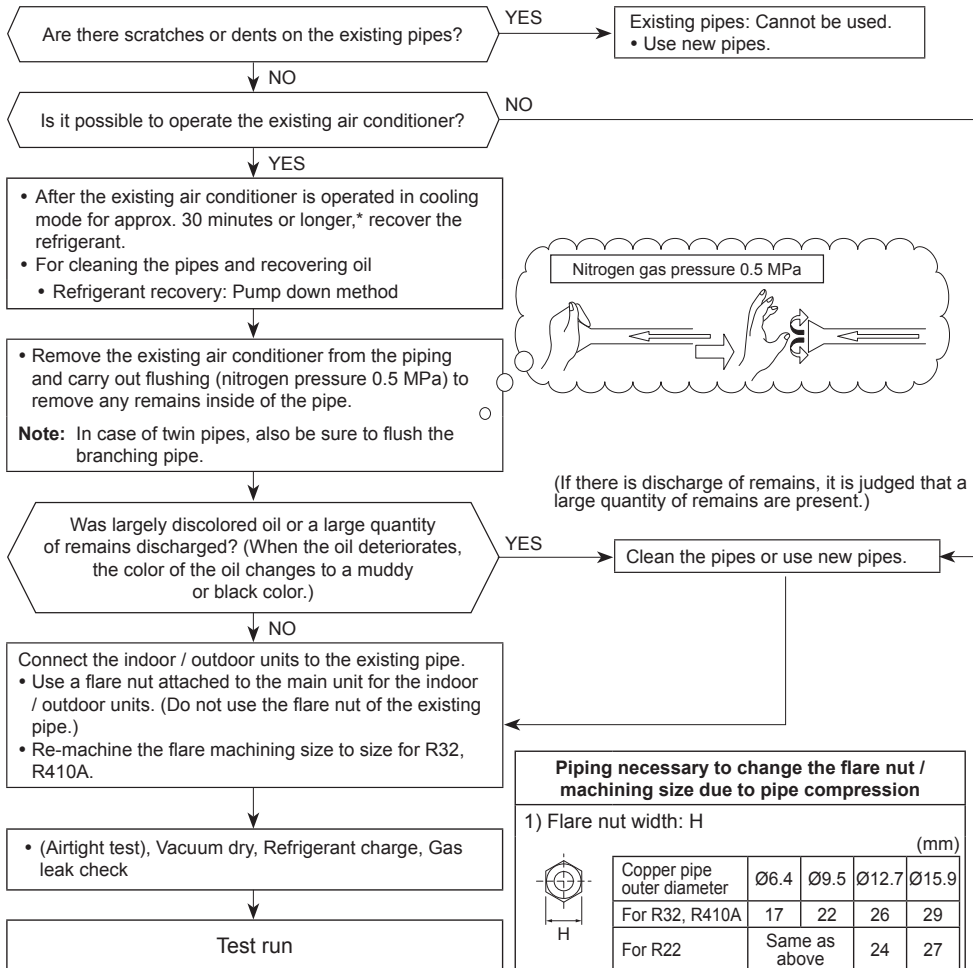

**Piping necessary to change the flare nut / machining size due to pipe compression**

1) Flare nut width: H (mm)

	Copper pipe outer diameter	Ø6.4	Ø9.5	Ø12.7	Ø15.9
	For R32, R410A	17	22	26	29
	For R22	Same as above	24	27	

2) Flare machining size: A (mm)

	Copper pipe outer diameter	Ø6.4	Ø9.5	Ø12.7	Ø15.9
	For R32, R410A	9.1	13.2	16.6	19.7
	For R22	9.0	13.0	16.2	19.4

Becomes a little larger for R32, R410A

Do not apply refrigerator oil to the flare surface.

## Declaration of Conformity

Manufacturer: Toshiba Carrier (Thailand) Co.,Ltd.  
144 / 9 Moo 5, Bangkadi Industrial Park, Tivanon Road, Tambol Bangkadi,  
Amphur Muang, Pathumthani 12000, Thailand

TCF holder: TOSHIBA CARRIER EUROPE S.A.S  
Route de Thil 01120 Montluel FRANCE

Hereby declares that the machinery described below:

Generic Denomination: Air Conditioner

Model / type: MMC-UP0151HP-E, MMC-UP0181HP-E  
MMC-UP0241HP-E, MMC-UP0271HP-E  
MMC-UP0361HP-E, MMC-UP0481HP-E  
MMC-UP0561HP-E

Commercial name: Super Modular Multi System Air Conditioner  
Super Heat Recovery Multi System Air Conditioner  
Mini-Super Modular Multi System Air Conditioner (MiNi-SMMS series)

Complies with the provisions of the Machinery Directive (Directive 2006/42/EC) and the regulations transposing into national law

Name: Masaru Takeyama  
Position: GM, Quality Assurance Dept.  
Date: 2 November, 2021  
Place Issued: Thailand

### NOTE

This declaration becomes invalid if technical or operational modifications are introduced without the manufacturer's consent.

## Declaration of Conformity

Manufacturer: Toshiba Carrier (Thailand) Co.,Ltd.  
144 / 9 Moo 5, Bangkadi Industrial Park, Tivanon Road, Tambol Bangkadi,  
Amphur Muang, Pathumthani 12000, Thailand

TCF holder: TOSHIBA CARRIER UK LTD.  
Porsham Close Belliver Industrial Estate Roborough Plymouth Devon  
PL6 7DB United Kingdom

Hereby declares that the machinery described below:

Generic Denomination: Air Conditioner

Model / type: MMC-UP0151HP-E, MMC-UP0181HP-E  
MMC-UP0241HP-E, MMC-UP0271HP-E  
MMC-UP0361HP-E, MMC-UP0481HP-E  
MMC-UP0561HP-E

Commercial name: Super Modular Multi System Air Conditioner  
Super Heat Recovery Multi System Air Conditioner  
Mini-Super Modular Multi System Air Conditioner (MiNi-SMMS series)

Complies with the provisions of the Supply of Machinery (Safety) Regulations 2008

Name: Masaru Takeyama  
Position: GM, Quality Assurance Dept.  
Date: 2 November, 2021  
Place Issued: Thailand

### NOTE

This declaration becomes invalid if technical or operational modifications are introduced without the manufacturer's consent.

# Warnings on Refrigerant Leakage

## Check of Concentration Limit

The room in which the air conditioner is to be installed requires a design that in the event of refrigerant gas leaking out, its concentration will not exceed a set limit.

The refrigerant R32 or R410A which is used in the air conditioner is safe, without the toxicity or combustibility of ammonia, and is not restricted by laws to be imposed which protect the ozone layer. However, since it contains more than air, it poses the risk of suffocation if its concentration should rise excessively. Suffocation from leakage of R32 or R410A is almost non-existent. With the recent increase in the number of high concentration buildings, however, the installation of multi air conditioner systems is on the increase because of the need for effective use of floor space, individual control, energy conservation by curtailing heat and carrying power etc.

Most importantly, the multi air conditioner system is able to replenish a large amount of refrigerant compared with conventional individual air conditioners. If a single unit of the multi conditioner system is to be installed in a small room, select a suitable model and installation procedure so that if the refrigerant accidentally leaks out, its concentration does not reach the limit (and in the event of an emergency, measures can be made before injury can occur).

In a room where the concentration may exceed the limit, create an opening with adjacent rooms, or install mechanical ventilation combined with a gas leak detection device. The concentration is as given below.

$$\frac{\text{Total amount of refrigerant (kg)}}{\text{Min. volume of the indoor unit installed room (m}^3\text{)}} \leq \text{Concentration limit (kg/m}^3\text{)}$$

The concentration limit of R32 or R410A which is used in multi air conditioners is 0.3 kg/m<sup>3</sup>.

### ▼ NOTE 1

If there are 2 or more refrigerating systems in a single refrigerating device, the amounts of refrigerant should be as charged in each independent device.

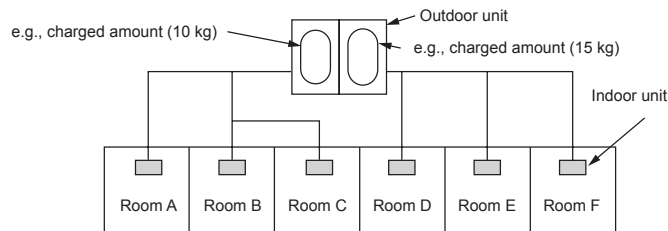

For the amount of charge in this example:

The possible amount of leaked refrigerant gas in rooms A, B and C is 10 kg.

The possible amount of leaked refrigerant gas in rooms D, E and F is 15 kg.

### ▼ NOTE 2

The standards for minimum room volume are as follows.

- 1) No partition (shaded portion)

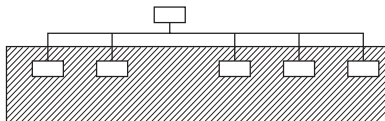

## Important

- 2) When there is an effective opening with the adjacent room for ventilation of leaking refrigerant gas (opening without a door, or an opening 0.15 % or larger than the respective floor spaces at the top or bottom of the door).

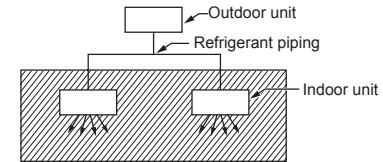

- 3) If an indoor unit is installed in each partitioned room and the refrigerant piping is interconnected, the smallest room of course becomes the object. But when a mechanical ventilation is installed interlocked with a gas leakage detector in the smallest room where the density limit is exceeded, the volume of the next smallest room becomes the object.

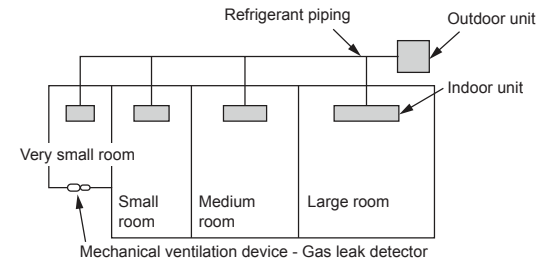

### ▼ NOTE 3

The minimum indoor floor area compared with the amount of refrigerant is roughly as follows: (When the ceiling is 2.7 m high)

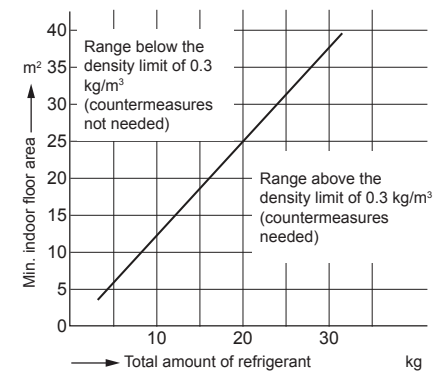

# **Toshiba Carrier (Thailand) Co., Ltd.**

144 / 9 Moo 5, Bangkadi Industrial Park, Tivanon Road, Tambol Bangkadi, Amphur Muang, Pathumthani 12000, Thailand

1115652797