

# TOSHIBA

## AIR CONDITIONER (SPLIT TYPE) Installation Manual

R32

### Indoor Unit

Model name:

For commercial use

4-way Cassette type

**RAV-HM561UTP-E**  
**RAV-HM801UTP-E**  
**RAV-HM901UTP-E**  
**RAV-HM1101UTP-E**  
**RAV-HM1401UTP-E**  
**RAV-HM1601UTP-E**

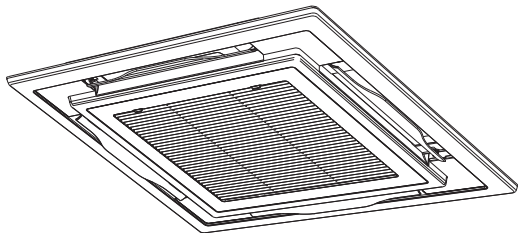

**Original instruction**

- Please read this Installation Manual carefully before installing the Air Conditioner.
- This Manual describes the installation method of the indoor unit.
  - For installation of the outdoor unit, follow the Installation Manual attached to the outdoor unit.
  - For precaution for safety, follow the Installation Manual attached to the outdoor unit.

**ADOPTION OF R32 REFRIGERANT**

This Air Conditioner has adopted a refrigerant HFC (R32) which does not destroy the ozone layer. Be sure to check the refrigerant type for outdoor unit to be combined, and then install it.

**Product information of ecodesign requirements. (Regulation (EU) 2016/2281)**  
<http://ecodesign.toshiba-airconditioning.eu/en>

**Contents**

<b>1</b>	<b>Precautions for safety</b> .....	<b>3</b>
<b>2</b>	<b>Accessory parts</b> .....	<b>7</b>
<b>3</b>	<b>Selection of installation place</b> .....	<b>7</b>
<b>4</b>	<b>Installation</b> .....	<b>9</b>
<b>5</b>	<b>Drain piping</b> .....	<b>11</b>
<b>6</b>	<b>Refrigerant piping</b> .....	<b>12</b>
<b>7</b>	<b>Electrical connection</b> .....	<b>13</b>
<b>8</b>	<b>Applicable controls</b> .....	<b>16</b>
<b>9</b>	<b>Test run</b> .....	<b>20</b>
<b>10</b>	<b>Maintenance</b> .....	<b>21</b>
<b>11</b>	<b>Troubleshooting</b> .....	<b>23</b>
<b>12</b>	<b>Specifications</b> .....	<b>25</b>
<b>13</b>	<b>Appendix</b> .....	<b>26</b>

Thank you for purchasing this air conditioner.

Please read carefully through these instructions that contain important information which complies with the Machinery Directive (Directive 2006/42/EC), and ensure that you understand them.

After completing the installation work, hand over this Installation Manual as well as the Owner's Manual provided to the user, and ask the user to keep them in a safe place for future reference.

#### Generic Denomination: Air Conditioner

#### Definition of Qualified Installer or Qualified Service Person

The air conditioner must be installed, maintained, repaired and removed by a qualified installer or qualified service person. When any of these jobs is to be done, ask a qualified installer or qualified service person to do them for you. A qualified installer or qualified service person is an agent who has the qualifications and knowledge described in the following table.

Agent	Qualifications and knowledge which the agent must have
Qualified installer	<ul style="list-style-type: none"> <li>The qualified installer is a person who installs, maintains, relocates and removes the air conditioners made by Toshiba Carrier Corporation. He or she has been trained to install, maintain, relocate and remove the air conditioners made by Toshiba Carrier Corporation or, alternatively, he or she has been instructed in such operations by an individual or individuals who have been trained and is thus thoroughly acquainted with the knowledge related to these operations.</li> <li>The qualified installer who is allowed to do the electrical work involved in installation, relocation and removal has the qualifications pertaining to this electrical work as stipulated by the local laws and regulations, and he or she is a person who has been trained in matters relating to electrical work on the air conditioners made by Toshiba Carrier Corporation or, alternatively, he or she has been instructed in such matters by an individual or individuals who have been trained and is thus thoroughly acquainted with the knowledge related to this work.</li> <li>The qualified installer who is allowed to do the refrigerant handling and piping work involved in installation, relocation and removal has the qualifications pertaining to this refrigerant handling and piping work as stipulated by the local laws and regulations, and he or she is a person who has been trained in matters relating to refrigerant handling and piping work on the air conditioners made by Toshiba Carrier Corporation or, alternatively, he or she has been instructed in such matters by an individual or individuals who have been trained and is thus thoroughly acquainted with the knowledge related to this work.</li> <li>The qualified installer who is allowed to work at heights has been trained in matters relating to working at heights with the air conditioners made by Toshiba Carrier Corporation or, alternatively, he or she has been instructed in such matters by an individual or individuals who have been trained and is thus thoroughly acquainted with the knowledge related to this work.</li> </ul>
Qualified service person	<ul style="list-style-type: none"> <li>The qualified service person is a person who installs, repairs, maintains, relocates and removes the air conditioners made by Toshiba Carrier Corporation. He or she has been trained to install, repair, maintain, relocate and remove the air conditioners made by Toshiba Carrier Corporation or, alternatively, he or she has been instructed in such operations by an individual or individuals who have been trained and is thus thoroughly acquainted with the knowledge related to these operations.</li> <li>The qualified service person who is allowed to do the electrical work involved in installation, repair, relocation and removal has the qualifications pertaining to this electrical work as stipulated by the local laws and regulations, and he or she is a person who has been trained in matters relating to electrical work on the air conditioners made by Toshiba Carrier Corporation or, alternatively, he or she has been instructed in such matters by an individual or individuals who have been trained and is thus thoroughly acquainted with the knowledge related to this work.</li> <li>The qualified service person who is allowed to do the refrigerant handling and piping work involved in installation, repair, relocation and removal has the qualifications pertaining to this refrigerant handling and piping work as stipulated by the local laws and regulations, and he or she has been trained in matters relating to refrigerant handling and piping work on the air conditioners made by Toshiba Carrier Corporation or, alternatively, he or she has been instructed in such matters by an individual or individuals who have been trained and is thus thoroughly acquainted with the knowledge related to this work.</li> <li>The qualified service person who is allowed to work at heights has been trained in matters relating to working at heights with the air conditioners made by Toshiba Carrier Corporation or, alternatively, he or she has been instructed in such matters by an individual or individuals who have been trained and is thus thoroughly acquainted with the knowledge related to this work.</li> </ul>

#### Definition of Protective Gear



When the air conditioner is to be transported, installed, maintained, repaired or removed, wear protective gloves and 'safety' work clothing.

In addition to such normal protective gear, wear the protective gear described below when undertaking the special work detailed in the following table.

Failure to wear the proper protective gear is dangerous because you will be more susceptible to injury, burns, electric shocks and other injuries.

Work undertaken	Protective gear worn
All types of work	Protective gloves 'Safety' working clothing
Electrical-related work	Gloves to provide protection for electricians and from heat Insulating shoes Clothing to provide protection from electric shock
Work done at heights (50 cm or more)	Helmets for use in industry
Transportation of heavy objects	Shoes with additional protective toe cap
Repair of outdoor unit	Gloves to provide protection for electricians and from heat

These safety cautions describe important matters concerning safety to prevent injury to users or other people and damages to property. Please read through this manual after understanding the contents below (meanings of indications), and be sure to follow the description.





Indication	Meaning of Indication
 <b>WARNING</b>	Text set off in this manner indicates that failure to adhere to the directions in the warning could result in serious bodily harm (*1) or loss of life if the product is handled improperly.
 <b>CAUTION</b>	Text set off in this manner indicates that failure to adhere to the directions in the caution could result in slight injury (*2) or damage (*3) to property if the product is handled improperly.

\*1: Serious bodily harm indicates loss of eyesight, injury, burns, electric shock, bone fracture, poisoning, and other injuries which leave aftereffect and require hospitalization or long-term treatment as an outpatient.





\*2: Slight injury indicates injury, burns, electric shock, and other injuries which do not require hospitalization or longterm treatment as an outpatient.

\*3: Damage to property indicates damage extending to buildings, household effects, domestic livestock, and pets.

#### MEANINGS OF SYMBOLS DISPLAYED ON THE UNIT

	<b>WARNING</b> (Risk of fire)	This mark is for R32 refrigerant only. In case that refrigerant type is R32, this unit uses a flammable refrigerant. If refrigerant leaks and comes in contact with fire or heating part, it will create harmful gas and there is risk of fire.
		Read the OWNER'S MANUAL carefully before operation.
		Service personnel are required to carefully read the OWNER'S MANUAL and INSTALLATION MANUAL before operation.
		Further information is available in the OWNER'S MANUAL, INSTALLATION MANUAL, and the like.

■ Warning indications on the air conditioner unit

Warning indication	Description		
 <table border="1"> <tr> <td><b>WARNING</b></td> </tr> <tr> <td><b>ELECTRICAL SHOCK HAZARD</b> Disconnect all remote electric power supplies before servicing.</td> </tr> </table>	<b>WARNING</b>	<b>ELECTRICAL SHOCK HAZARD</b> Disconnect all remote electric power supplies before servicing.	<p><b>WARNING</b></p> <p><b>ELECTRICAL SHOCK HAZARD</b> Disconnect all remote electric power supplies before servicing.</p>
<b>WARNING</b>			
<b>ELECTRICAL SHOCK HAZARD</b> Disconnect all remote electric power supplies before servicing.			
 <table border="1"> <tr> <td><b>WARNING</b></td> </tr> <tr> <td>Moving parts. Do not operate unit with grille removed. Stop the unit before the servicing.</td> </tr> </table>	<b>WARNING</b>	Moving parts. Do not operate unit with grille removed. Stop the unit before the servicing.	<p><b>WARNING</b></p> <p><b>Moving parts.</b> Do not operate unit with grille removed. Stop the unit before the servicing.</p>
<b>WARNING</b>			
Moving parts. Do not operate unit with grille removed. Stop the unit before the servicing.			
 <table border="1"> <tr> <td><b>CAUTION</b></td> </tr> <tr> <td>High temperature parts. You might get burned when removing this panel.</td> </tr> </table>	<b>CAUTION</b>	High temperature parts. You might get burned when removing this panel.	<p><b>CAUTION</b></p> <p>High temperature parts. You might get burned when removing this panel.</p>
<b>CAUTION</b>			
High temperature parts. You might get burned when removing this panel.			
 <table border="1"> <tr> <td><b>CAUTION</b></td> </tr> <tr> <td>Do not touch the aluminum fins of the unit. Doing so may result in injury.</td> </tr> </table>	<b>CAUTION</b>	Do not touch the aluminum fins of the unit. Doing so may result in injury.	<p><b>CAUTION</b></p> <p>Do not touch the aluminium fins of the unit. Doing so may result in injury.</p>
<b>CAUTION</b>			
Do not touch the aluminum fins of the unit. Doing so may result in injury.			
 <table border="1"> <tr> <td><b>CAUTION</b></td> </tr> <tr> <td><b>BURST HAZARD</b> Open the service valves before the operation, otherwise there might be the burst.</td> </tr> </table>	<b>CAUTION</b>	<b>BURST HAZARD</b> Open the service valves before the operation, otherwise there might be the burst.	<p><b>CAUTION</b></p> <p><b>BURST HAZARD</b> Open the service valves before the operation, otherwise there might be the burst.</p>
<b>CAUTION</b>			
<b>BURST HAZARD</b> Open the service valves before the operation, otherwise there might be the burst.			

# 1 Precautions for safety

The manufacturer shall not assume any liability for the damage caused by not observing the description of this manual.

## WARNING

### General

- Before starting to install the air conditioner, read through the Installation Manual carefully, and follow its instructions to install the air conditioner.
- Only a qualified installer or service person is allowed to do installation work. Inappropriate installation may result in water leakage, electric shock or fire.
- Do not use any refrigerant different from the one specified for complement or replacement. Otherwise, abnormally high pressure may be generated in the refrigeration cycle, which may result in a failure or explosion of the product or an injury to your body.
- Before opening the intake grille of the indoor unit or service panel of the outdoor unit, set the circuit breaker to the OFF position. Failure to set the circuit breaker to the OFF position may result in electric shocks through contact with the interior parts. Only a qualified installer(\*1) or qualified service person(\*1) is allowed to remove the intake grille of the indoor unit or service panel of the outdoor unit and do the work required.
- Before carrying out the installation, maintenance, repair or removal work, set the circuit breaker to the OFF position. Otherwise, electric shocks may result.
- Place a “Work in progress” sign near the circuit breaker while the installation, maintenance, repair or removal work is being carried out. There is a danger of electric shocks if the circuit breaker is set to ON by mistake.
- Only a qualified installer(\*1) or qualified service person(\*1) is allowed to undertake work at heights using a stand of 50 cm or more or to remove the intake grille of the indoor unit to undertake work.

- Wear protective gloves and safety work clothing during installation, servicing and removal.
- Do not touch the aluminium fin of the unit. You may injure yourself if you do so. If the fin must be touched for some reason, first put on protective gloves and safety work clothing, and then proceed.
- Do not climb onto or place objects on top of the outdoor unit. You may fall or the objects may fall off of the outdoor unit and result in injury.
- When work is performed at heights, use a ladder which complies with the ISO 14122 standard, and follow the procedure in the ladder's instructions. Also wear a helmet for use in industry as protective gear to undertake the work.
- Before cleaning the filter or other parts of the outdoor unit, set the circuit breaker to OFF without fail, and place a "Work in progress" sign near the circuit breaker before proceeding with the work.
- Before working at heights, put a sign in place so that no-one will approach the work location, before proceeding with the work. Parts and other objects may fall from above, possibly injuring a person below. While carrying out the work, wear a helmet for protection from falling objects.
- Do not use the refrigerant other than R32. For the refrigerant type, check the outdoor unit to be combined.
- The refrigerant used by this air conditioner, follow to the outdoor unit.
- The air conditioner must be transported in stable condition. If any part of the product is broken, contact the dealer.
- When the air conditioner must be transported by hand, carry it by two or more people.
- Do not move or repair any unit by yourself. There is high voltage inside the unit. You may get electric shock when removing the cover and main unit.
- This appliance is intended to be used by expert or trained users in shops, in light industry, or for commercial use by lay persons.

### **Selection of installation location**

- When the air conditioner is installed in a small room, provide appropriate measures to ensure that the concentration of refrigerant leakage occur in the room does not exceed the critical level.
- Do not install in a location where flammable gas leaks are possible. If the gas leak and accumulate around the unit, it may ignite and cause a fire.
- To transport the air conditioner, wear shoes with additional protective toe caps.
- To transport the air conditioner, do not take hold of the bands around the packing carton. You may injure yourself if the bands should break.
- Install the indoor unit at least 2.5 m above the floor level since otherwise the users may injure themselves or receive electric shocks if they poke their fingers or other objects into the indoor unit while the air conditioner is running.
- Do not place any combustion appliance in a place where it is directly exposed to the wind of air conditioner, otherwise it may cause imperfect combustion.

### **Installation**

- When the indoor unit is to be suspended, the designated hanging bolts (M10 or W3/8) and nuts (M10 or W3/8) must be used.
- Install the air conditioner securely in a location where the base can sustain the weight adequately. If the strength is not enough, the unit may fall down resulting in injury.
- Follow the instructions in the Installation Manual to install the air conditioner. Failure to follow these instructions may cause the product to fall down or topple over or give rise to noise, vibration, water leakage or other trouble.
- Carry out the specified installation work to guard against the possibility of high winds and earthquake. If the air conditioner is not installed appropriately, a unit may topple over or fall down, causing an accident.

- If refrigerant gas has leaked during the installation work, ventilate the room immediately. If the leaked refrigerant gas comes in contact with fire, noxious gas may generate.
- Use forklift to carry in the air conditioner units and use winch or hoist at installation of them.

### Refrigerant piping

- Install the refrigerant pipe securely during the installation work before operating the air conditioner. If the compressor is operated with the valve open and without refrigerant pipe, the compressor sucks air and the refrigeration cycles is over pressurized, which may cause an injury.
- Tighten the flare nut with a torque wrench in the specified manner. Excessive tightening of the flare nut may cause a crack in the flare nut after a long period, which may result in refrigerant leakage.
- After the installation work, confirm that refrigerant gas does not leak. If refrigerant gas leaks into the room and flows near a fire source, such as a cooking range, noxious gas may be generated.
- When the air conditioner has been installed or relocated, follow the instructions in the Installation Manual and purge the air completely so that no gases other than the refrigerant will be mixed in the refrigerating cycle. Failure to purge the air completely may cause the air conditioner to malfunction.
- Nitrogen gas must be used for the airtight test.
- The charge hose must be connected in such a way that it is not slack.

### Electrical wiring

- Only a qualified installer(\*1) or qualified service person(\*1) is allowed to carry out the electrical work of the air conditioner. Under no circumstances must this work be done by an unqualified individual since failure to carry out the work properly may result in electric shocks and/or electrical leaks.
- To connect the electrical wires, repair the electrical parts or undertake other electrical jobs, wear gloves to provide protection for electricians and from heat, insulating shoes and clothing to provide protection from electric shocks. Failure to wear this protective gear may result in electric shocks.
- Use wiring that meets the specifications in the Installation Manual and the stipulations in the local regulations and laws. Use of wiring which does not meet the specifications may give rise to electric shocks, electrical leakage, smoking and/or a fire.
- Connect earth wire. (Grounding work)  
Incomplete grounding causes an electric shock.
- Do not connect earth wires to gas pipes, water pipes, and lightning conductor or telephone earth wires.
- After completing the repair or relocation work, check that the earth wires are connected properly.
- Install a circuit breaker that meets the specifications in the installation manual and the stipulations in the local regulations and laws.
- Install the circuit breaker where it can be easily accessed by the agent.
- To install the circuit breaker outdoors, install one which is designed to be used outdoors.
- Under no circumstances the power wire must not be extended. Connection trouble in the places where the wire is extended may give rise to smoking and/or a fire.
- Electrical wiring work shall be conducted according to law and regulation in the community and installation manual. Failure to do so may result in electrocution or short circuit.

---

## Test run

- Before operating the air conditioner after having completed the work, check that the electrical control box cover of the indoor unit and service panel of the outdoor unit are closed, and set the circuit breaker to the ON position. You may receive an electric shock if the power is turned on without first conducting these checks.
- If there is any kind of trouble (such as an error display has appeared, smell of burning, abnormal sounds, the air conditioner fails to cool or heat or water is leaking) has occurred in the air conditioner, do not touch the air conditioner yourself but set the circuit breaker to the OFF position, and contact a qualified service person. Take steps to ensure that the power will not be turned on (by marking “out of service” near the circuit breaker, for instance) until qualified service person arrives. Continuing to use the air conditioner in the trouble status may cause mechanical problems to escalate or result in electric shocks or other trouble.
- After the work has finished, use an insulation tester set (500V Megger) to check the resistance is 1 MΩ or more between the charge section and the non-charge metal section (Earth section). If the resistance value is low, a disaster such as a leak or electric shock is caused at user’s side.
- Upon completion of the installation work, check for refrigerant leaks and check the insulation resistance and water drainage. Then conduct a test run to check that the air conditioner is operating properly.

## Explanations given to user

- Upon completion of the installation work, tell the user where the circuit breaker is located. If the user does not know where the circuit breaker is, he or she will not be able to turn it off in the event that trouble has occurred in the air conditioner.
- If the fan grille is damaged, do not approach the outdoor unit but set the circuit breaker to the OFF position, and contact a qualified service person(\*1) to have the repairs done. Do not set the circuit breaker to the ON position until the repairs are completed.

- 
- After the installation work, follow the Owner’s Manual to explain to the customer how to use and maintain the unit.

## Relocation

- Only a qualified installer(\*1) or qualified service person(\*1) is allowed to relocate the air conditioner. It is dangerous for the air conditioner to be relocated by an unqualified individual since a fire, electric shocks, injury, water leakage, noise and/or vibration may result.
- When carrying out the pump-down work shut down the compressor before disconnecting the refrigerant pipe. Disconnecting the refrigerant pipe with the service valve left open and the compressor still operating will cause air or other gas to be sucked in, raising the pressure inside the refrigeration cycle to an abnormally high level, and possibly resulting in rupture, injury or other trouble.

---

## CAUTION









### **This Air Conditioner has adopted a refrigerant HFC (R32) which does not destroy the ozone layer.**

- As the R32 refrigerant is easily affected by impurities such as moisture, oxidized film, oil, etc., due to the high pressure, be careful not to allow the moisture, dirt, existing refrigerant, refrigerating machine oil, etc., to get mixed up in the refrigeration cycle during the installation work.
- A special tool for the R32 refrigerant is required for installation.
- Use a new and clean piping materials for the connecting pipe so that moisture and dirt are not mixed together during the installation work.
- When using existing pipes, follow the installation manual enclosed with the outdoor unit.

---

(\*1) Refer to the “Definition of Qualified Installer or Qualified Service Person.”

## 2 Accessory parts

Part name	Q'ty	Shape	Usage
Installation Manual	1	This manual	(Hand over to customers) (For other languages that do not appear in this Installation Manual, please refer to the enclosed CD-R.)
Owner's Manual	1		(Hand over to customers) (For other languages that do not appear in this Owner's Manual, please refer to the enclosed CD-R.)
CD-ROM	1	—	Owner's Manual and Installation Manual
Heat insulating pipe	2		For heat insulation of the pipe connecting section
Installation pattern	1	—	For checking of ceiling opening and the main unit position
Installation gauge	2		For positioning of the ceiling position (To be used with the installation pattern)
Heat insulator	1		For heat insulation of drain connecting section
Washer	4		For hanging unit
Eccentric washer	4		For hanging-down unit
Hose band	1		For connecting drain pipe
Flexible hose	1		For drainage of drain water
Heat insulator	1		For sealing of wire connecting port

### ■ Separate sold parts

The Ceiling panel and remote controller are sold separately. For the installation of these products, follow the Installation Manuals supplied with them.

## 3 Selection of installation place

### ⚠ WARNING

- **Install the air conditioner at enough strong place to withstand the weight of the unit.**  
If the strength is not enough, the unit may fall down resulting in injury.
- **Install the air conditioner at a height 2.5 m or more from the floor.**  
If you insert your hands or others directly into the unit while the air conditioner operates, it is dangerous because you may contact with revolving fan or active electricity.

### ⚠ CAUTION

- **Do not install the air conditioner in a location subject to a risk of exposure to a combustible gas.**  
If a combustible gas leaks and stays around the unit, a fire may occur.

### **Upon approval of the customer, install the air conditioner in a place that satisfies the following conditions**

- Place where the unit can be installed horizontally.
- Place where a sufficient servicing space can be ensured for safety maintenance and check.
- Place where drained water will not cause any problem.

### **Avoid installing in the following places**

- Place exposed to air with high salt content (seaside area), or place exposed to large quantities of sulfide gas (hot spring).  
(Should the unit be used in these places, special protective measures are needed.)
- A restaurant kitchen where a lot of oil is used or place near machines in a factory (Oil adhering to the heat exchanger and resin part (turbo fan) in the indoor unit may reduce the performance, generate mist or dew drop, or deform or damage resin parts.)
- Places where iron or other metal dust is present. If iron or other metal dust adheres to or collects on the interior of the air conditioner, it may spontaneously combust and start a fire.
- Place where organic solvent is used nearby.
- Place close to a machine generating high frequency.
- Place where the discharged air blows directly into the window of the neighbor house. (Outdoor unit)
- Place where noise of the outdoor unit is easily transmitted.  
(When install the outdoor unit on the boundary with the neighbor, pay due attention to the level of noise.)
- Place with poor ventilation. (Before air ducting work, check whether value of air volume, static pressure and duct resistance are correct.)
- Do not use the air conditioner for special purposes such as preserving food, precision instruments, or art objects, or where breeding animals or growing plants are kept. (This may degrade the quality of preserved materials.)
- Place where any of high-frequency appliances (including inverter devices, private power generators, medical equipment, and communication equipment) and inverter-type fluorescent light is installed.  
(A malfunction of the air conditioner, abnormal control, or problems due to noise to such appliances / equipment may occur.)
- When the wireless remote controller is used in a room equipped with an inverter-type fluorescent light or at a place exposed to direct sunlight, signals from the remote controller may not be received correctly.
- Place where organic solvent is used.
- Place near a door or window exposed to humid outside air (Dew dropping may form.).
- Place where special spray is used frequently.



## ■ Installation space

(Unit : mm)

Secure the specified space in the figure for installation and servicing.

Model	A mm
HM56, HM80 Type	271 or more
HM90, HM110, HM140, HM160 Type	334 or more

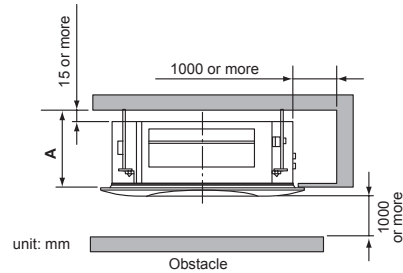

### ▼ When incorporating fresh air intake box (sold separately)

Provide an inspection opening at the outside-air intake box side.

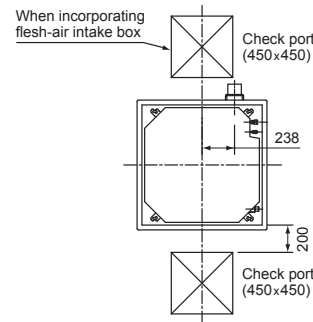

## ■ Selection of installation place

In case of continued operation of the indoor unit under high-humidity conditions as described below, dew may condense and water may drop. Especially, high-humidity atmosphere (dew point temperature : 23 °C or more) may generate dew inside the ceiling.

- Unit is installed inside the ceiling with slated roof.
- Unit is installed at a location using inside of the ceiling as fresh air take-in path.
- Kitchen

## ◆ Advice

- Set a service check opening panel at right side of the unit (size: 450 × 450 mm or more) for piping, maintenance, and servicing.
- If installing a unit at such place, put insulating material (glass wool, etc.) additionally on all the positions of the indoor unit which come to contact with high-humidity atmosphere.

### REQUIREMENT

When the humidity inside the ceiling seems to be higher than 80%, attach a heat insulator to the side (top) surface of the indoor unit. (Use a heat insulator that is 10 mm or more thick.)

## ■ Ceiling height

Model	Possible installed ceiling height
HM56, HM80 Type	Up to 3.8 m
HM90, HM110, HM140, HM160 Type	Up to 4.6 m

When the height of the ceiling exceeds the distance of the item Standard / 4-way in Table as below, the hot air is difficult to reach the floor.

Therefore, it is necessary to change the setup value of the high ceiling switch or discharge direction. The high-ceiling setting is also necessary when installing separately sold filters.

### REQUIREMENT

- When using the air conditioner with 2-way / 3-way discharge system, a strong wind blows directly if the ceiling height is lower than the standard. Therefore, change the setting switch according to height of the ceiling.
- When using the high ceiling (1) or (3) with 4-way discharge system, the draft is apt to be felt due to drop of the discharge temperature.

### ▼ Height list of ceiling possible to be installed

(Unit: m)

Model	HM56			HM80			HM90, HM110, HM140, HM160			Setup of high ceiling
	4-way	3-way	2-way	4-way	3-way	2-way	4-way	3-way	2-way	
Discharge direction	4-way	3-way	2-way	4-way	3-way	2-way	4-way	3-way	2-way	SET DATA
Standard (At shipment)	2.8	3.2	3.5	3.0	3.3	3.6	3.9	4.2	4.5	0000
High ceiling (1)	3.2	3.5	3.8	3.3	3.5	3.8	4.2	4.4	4.6	0001
High ceiling (3)	3.5	3.8	—	3.6	3.8	—	4.5	4.6	—	0003

## ■ Discharge direction

As shown in the figure below, air discharge directions can be selected according to the shape of the room and the location of the indoor unit installation.

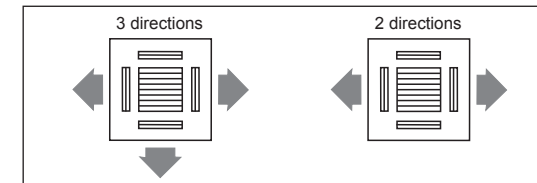

Use a shielding plate kit (sold separately) to change discharge directions. Discharge directions are limited. Follow the Installation Manual supplied with the shielding plate kit.

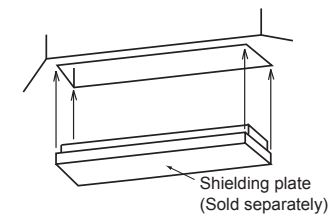

# 4 Installation

## REQUIREMENT

- Strictly comply with the following rules to prevent damage of the indoor units and human injury.
- Do not put a heavy article on the indoor unit. (Even units are packaged)
  - Carry in the indoor unit as it is packaged if possible. If carrying in the indoor unit unpacked by necessity, be sure to use buffering cloth, etc. to not damage the unit.
  - To move the indoor unit, hold the hooking metals (4 positions) only.  
Do not apply force to the other parts (refrigerant pipe, drain pan, foamed parts, or resin parts, etc.).
  - Carry the package by two or more persons, and do not bundle it with plastic band at positions other than specified.

## External view

(Unit: mm)

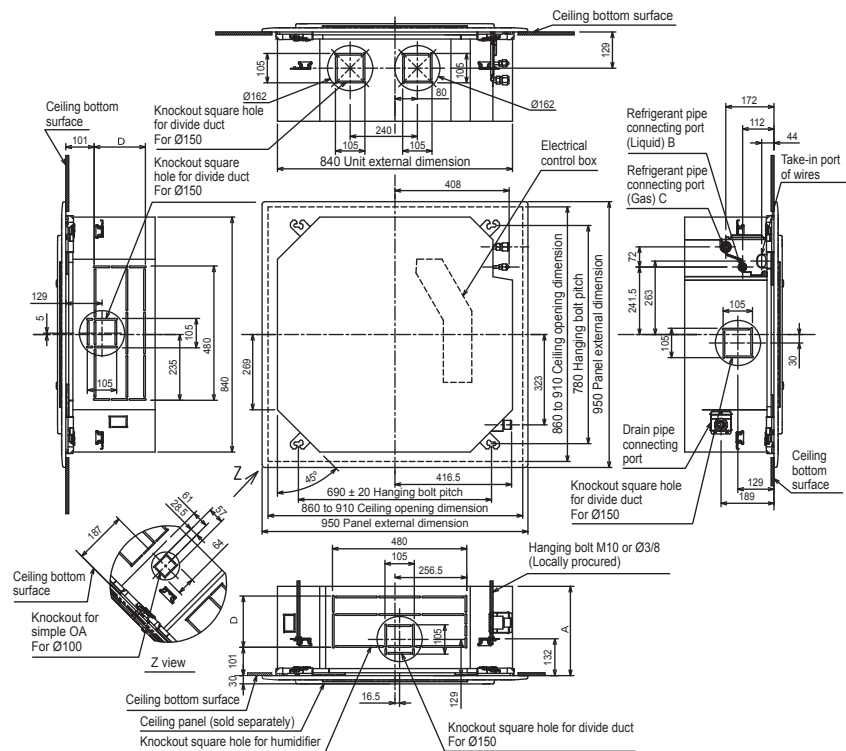

(mm)

Model	A	B	C	D	Model	A	B	C	D
HM56 Type	256	Ø6.4	Ø12.7	120	HM110 Type	319	Ø9.5	Ø15.9	183
HM80 Type	256	Ø9.5	Ø15.9	120	HM140 Type	319	Ø9.5	Ø15.9	183
HM90 Type	319	Ø9.5	Ø15.9	183	HM160 Type	319	Ø9.5	Ø15.9	183

## Opening a ceiling and installation of hanging bolts

- Consider the piping / wiring before the unit is hung when determining the location of the indoor unit installation and orientation.
- After the location of the indoor unit installation has been determined, open the ceiling and install hanging bolts.
- The dimensions of the ceiling opening and hanging bolt pitches are given in the outline drawing and the attached installation pattern.
- When a ceiling already exists, lay the drain pipe, refrigerant pipe, indoor unit / outdoor unit connection wires, and remote controller wires to their connection locations before hanging the indoor unit.

Procure hanging bolts and nuts for installing the indoor unit (these are not supplied).

Hanging bolt	M10 or W3/8	4 pieces
Nut	M10 or W3/8	12 pieces

## How to use the installation pattern (accessory)

The installation pattern is provided inside the packaging cap.

### <For existing ceiling>

Use the installation pattern positioning a ceiling opening and hanging bolts.

### <For new ceiling>

Use the installation pattern to position the ceiling opening when hanging a ceiling.

- After the hanging bolts have been installed, install the indoor unit.
- Hook the four holes in the installation pattern to the panel fixing screws of the indoor unit.
- When hanging a ceiling, open the ceiling along the outside dimensions of the installation pattern.

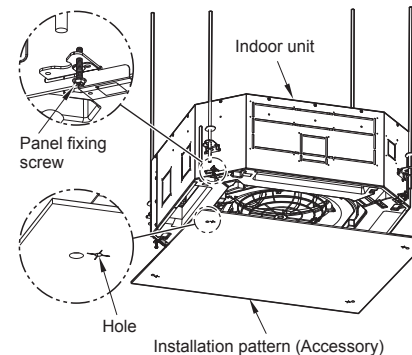

## Treatment of ceiling

The ceiling differs according to structure of building. For details, consult your constructor or interior finish contractor.

In the process after the ceiling board has been removed, it is important to reinforce ceiling foundation (frame) and to keep horizontal level of installed ceiling correctly in order to prevent vibration of ceiling board.

1. Cut and remove the ceiling foundation.
2. Reinforce the cut surface of ceiling foundation, and add ceiling foundation for fixing the end of ceiling board.

## Installation of hanging bolt

Use M10 hanging bolts (4 pcs, locally procured).

Matching to the existing structure, set pitch according to size in the unit external view as shown below.

<p><b>New concrete slab</b></p> <p>Install the bolts with insert brackets or anchor bolts.</p> <p>(Blade type bracket) (Slide type bracket) (Pipe hanging anchor bolt)</p>
<p><b>Steel frame structure</b></p> <p>Use existing angles or install new support angles.</p> <p>Hanging bolt Support angle</p>
<p><b>Existing concrete slab</b></p> <p>Use a hole-in anchors, hole-in plugs, or a hole-in bolts.</p>

## ◆ Installation of ceiling opening and hanging bolt

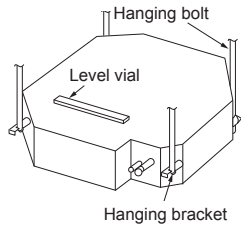

- Attach a nut (M10 or W3/8: not supplied) and the Ø34 washer (supplied) to each hanging bolt.
- Insert a washer on both sides of the T groove of the hanging bracket of the indoor unit, and hang the indoor unit.
- Check that the four sides of the indoor unit are level using a level vial (levelness: 5 mm or less).
- Detach the installation gauge (accessory) from the installation pattern.
- Using the installation gauge, check and adjust the positional relation between the indoor unit and the ceiling opening (1) (10 to 35 mm: 4 sides) and the hanging-up height (2) (12<sup>+5</sup> mm: 4 corners). (How to use the installation gauge is printed on the gauge.)

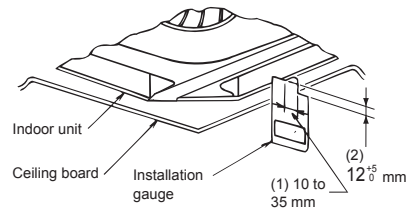
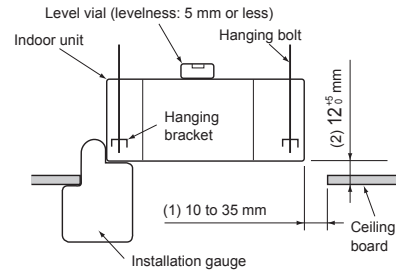
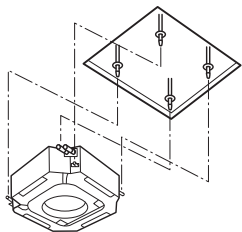
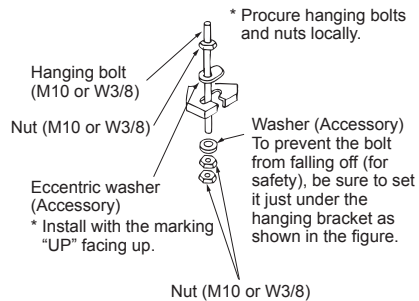

### REQUIREMENT

Before installation of the indoor unit, be sure to remove the tape for transportation between the fan and the bell mouth. Running the unit without removing the tape may damage the fan motor.

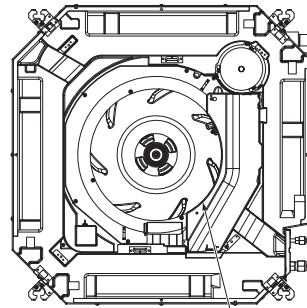

Be sure to remove the tape for transportation between the fan and the bell mouth.

## ■ Installation of ceiling panel (Sold separately)

Install the ceiling panel according to Installation Manual attached with it after piping / wiring work has completed. Check that installation of indoor unit and ceiling opening part is correct, and then install it.

### REQUIREMENT

- Joint the connecting sections of ceiling panel, ceiling surface, ceiling panel and indoor unit closely. Any gap between them will cause air leakage and the generate condensation or water leakage.
- Remove the adjust corner caps at the four corners of the ceiling panel, and then install the ceiling panel onto the indoor unit.
- Make sure that the claws of the four adjust corner caps are securely fit.  
\* Improper fitting of the claws may cause water leakage.

## ■ In case of wireless type

The sensor of indoor unit with wireless remote controller can receive a signal by distance within approx. 8 m. Based upon it, determine a place where the remote controller is operated and the installation place.

- Operate the remote controller, confirm that the indoor unit receives a signal surely, and then install it.
- Keep 1 m or more from the devices such as television, stereo, etc. (Disturbance of image or noise may generate.)
- To prevent a malfunction, select a place where is not influenced by a fluorescent light or direct sunlight.
- Two or more (Up to 6 units) indoor units with wireless type remote controller can be installed in the same room.

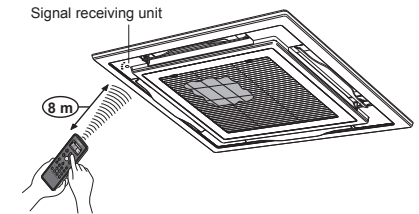

## ■ Installation of remote controller (Sold separately)

For installation of the wired remote controller, follow the Installation Manual attached with the remote controller.

- Pull out the remote controller cord together with the refrigerant pipe or drain pipe. Be sure to pass the remote controller cord through upper side of the refrigerant pipe and drain pipe.
- Do not leave the remote controller at a place exposed to the direct sunlight and near a stove

# 5 Drain piping

## ⚠ CAUTION

Following the Installation Manual, perform the drain piping work so that water is properly drained, and apply a heat insulation so as not to cause a dew dropping. Inappropriate piping work may result in water leakage in the room and wet of furniture.

## ■ Piping / Heat insulating material

Require the following materials for piping and heat insulating at site.

<b>Piping</b>	Hard vinyl chloride pipe VP25 (Outer dia. : Ø32 mm)
<b>Heat insulator</b>	Foam polyethylene : Thickness 10 mm or more

## ■ Flexible hose

Use the attached flexible hose to adjust center discrepancy of the hard vinyl chloride pipe or to adjust the angle.

- Do not use the flexible hose as stretched, or do not deform it more extent than that in the following figure.
- Be sure to fix the soft end of the flexible hose with the attached hose band.
- Use the flexible hose on a horizontal level.

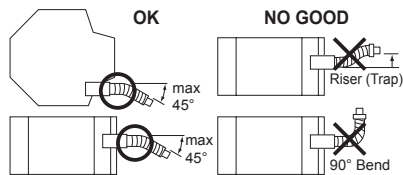

## REQUIREMENT

- Be sure to perform heat insulation of the drain pipes of the indoor unit.
- Never forget to perform heat insulation of the connecting part with the indoor unit. An incomplete heat insulation causes dew dropping.
- Set the drain pipe with downward slope (1/100 or more), and do not make swelling or trap on the piping. It may cause an abnormal sound.

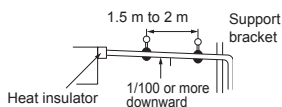

- For length of the traversing drain pipe, restrict to 20 m or less. In case of a long pipe, provide support brackets with interval of 1.5 to 2 m in order to prevent waving.

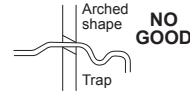

- Set the collective piping as shown in the below figure.

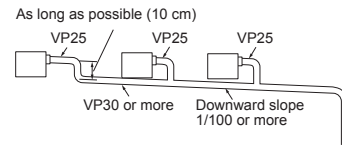

- Be sure not to apply force to the connecting part of the drain pipe.
- The hard vinyl-chloride pipe cannot be directly connected to the drain pipe connecting port of the indoor unit. For connection with the drain pipe connecting port, be sure to use / fix the attached flexible hose with the hose band, otherwise a damage or water leak is caused on the drain pipe connecting port.

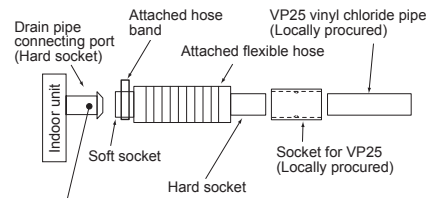

**Adhesive inhibited :**  
Use the attached flexible hose and hose band for connecting the drain hose to the clear drain socket. If applying the adhesive, socket will be damaged and cause water leakage

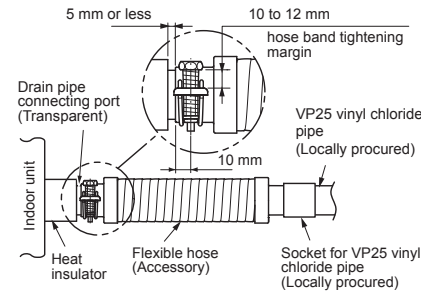

## ■ Connecting drain pipe

- Connect a hard socket (locally procured) to the hard socket of the attached supplied flexible hose.
- Connect a drain pipe (locally procured) to the connected hard socket.

## REQUIREMENT

- Connect hard vinyl chloride pipes securely using an adhesive for vinyl chloride to avoid water leakage.
- It takes some time until the adhesive is dried and hardened (refer to the manual of the adhesive). Do not apply stress to the joint with the drain pipe during this time period.

## ■ Drain up

When a down-gradient cannot be secured for the drainpipe, drain-up piping is possible.

- The height of the drain pipe must be 850 mm or less from the bottom of the ceiling.
- Take the drain pipe out of the drain pipe joint with the indoor unit in 300 mm or less, and bend up the pipe vertically.
- Immediately after the pipe is bent up vertically, lay the pipe making a down-gradient.
- Set downward grading immediately after raising up vertically.

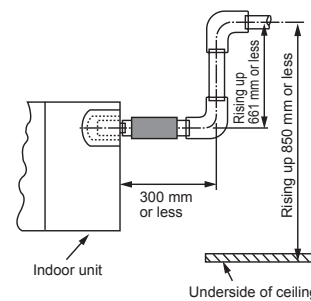

## ■ Check the draining

In the test run, check that water drain is properly performed and water does not leak from the connecting part of the pipes. Be sure to check draining also when installed in heating period. Using a pitcher or hose, pour water (1500 to 2000 cc) into the discharge port before installation of the ceiling panel. Pour water gradually so that water does not spread on the motor of the drain pump.

## ⚠ CAUTION

Pour water gently so that it does not spread around inside the indoor unit, which may cause a malfunction.

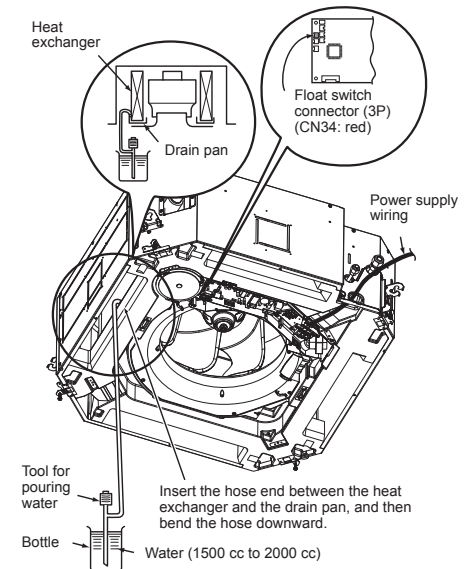

- After the electric work has finished, pour water during COOL mode operation.
- If the electric work has not yet finished, pull out the float switch connector (CN34 : Red) from the electrical control box, and check draining by plugging the single phase 220-240V power to the terminal blocks ① and ②. If doing so, the drain pump motor operates. (Never apply 220-240V to Ⓐ or Ⓑ, otherwise a trouble of P.C. board occurs.)

- Test water drain while checking the operation sound of the drain pump motor.  
(If the operation sound changes from continuous sound to intermittent sound, water is normally drained.)  
After the check, the drain pump motor runs, connecting the float switch connector.  
(In case of check by pulling out the float switch connector, be sure to return the connector to the original position.)

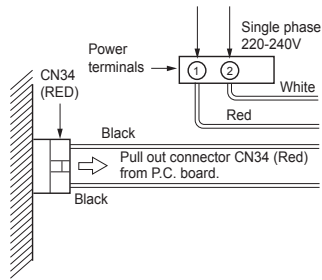

## ■ Perform heat insulating

- As shown in the figure, cover the flexible hose and hose band with the attached heat insulator up to the bottom of the indoor unit without gap.
- Cover the drain pipe seamlessly with a heat insulator locally procured so that it overlaps with the attached heat insulator of the drain connecting section.

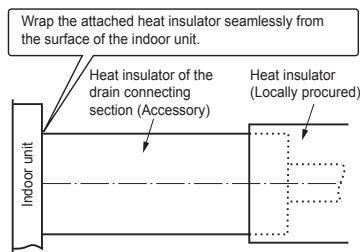

\* Direct the slits and seams of the heat insulator upward to avoid water leakage.

# 6 Refrigerant piping

## ⚠ CAUTION

When the refrigerant pipe is long, provide support brackets at intervals of 2.5 m to 3 m to clamp the refrigerant pipe. Otherwise, abnormal sound may be generated.

## ■ Permissible piping length and height difference

They vary depending on the outdoor unit. For details, refer to the Installation Manual attached to the outdoor unit, locally procured so that it overlaps with the attached heat insulator of the drain connecting section.

## ⚠ CAUTION

### IMPORTANT 4 POINTS FOR PIPING WORK

1. Reusable mechanical connectors and flared joints are not allowed indoors. When mechanical connectors are reused indoors, sealing parts shall be renewed. When flared joints are reused indoors, the flare part shall be refabricated.
2. Tight connection (between pipes and unit)
3. Evacuate the air in the connecting pipes by using VACUUM PUMP.
4. Check the gas leakage. (Connected points)

## ■ Pipe size

Model name		HM56 Type	HM80, HM90, HM110, HM140, HM160 Type
Pipe size	Gas side	12.7 mm	15.9 mm
	Liquid side	6.4 mm	9.5 mm

## ■ Connecting refrigerant piping

### Flaring

- Cut the pipe with a pipe cutter.  
Remove burrs completely.  
Remaining burrs may cause gas leakage.
- Insert a flare nut into the pipe, and flare the pipe.  
As the flaring sizes of R32 differ from those of refrigerant R22, the flare tools newly manufactured for R32 are recommended. However, the conventional tools can be used by adjusting projection margin of the copper pipe.

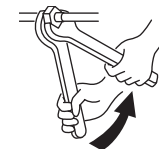

Work using double spanner

## Projection margin in flaring: B (Unit: mm)

Outer dia. of copper pipe	Tool used	Conventional tool used
6.4, 9.5	0.5 to 1.1	1.0 to 1.5
12.7, 15.9	0.5 to 1.1	1.5 to 2.0

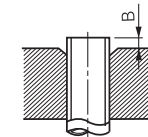

## Flaring diameter size: A (Unit: mm)

Outer dia. of copper pipe	A $\begin{smallmatrix} +0.4 \\ -0.4 \end{smallmatrix}$
6.4	9.1
9.5	13.2
12.7	16.6
15.9	19.7

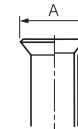

## ⚠ CAUTION

- Do not scratch the inner surface of the flared part when removing burrs.
- Flare processing under the condition of scratches on the inner surface of flare processing part will cause refrigerant gas leak.
- Check that the flared part is not scratched, deformed, stepped, or other problems, after flare processing.
- Do not apply refrigerating machine oil to the flare surface.
- In case of flaring with the conventional flare tool, pull it out approx. 0.5 mm more than that for R22 to adjust to the specified flare size. The copper pipe gauge is useful for adjusting projection margin size.
- The sealed gas was sealed at the atmospheric pressure so when the flare nut is removed, there will no "whooshing" sound: This is normal and is not indicative of trouble.
- Use two wrenches to connect the indoor unit pipe.

- Use the tightening torque levels as listed in the following table.

Outer dia. of connecting pipe (mm)	Tightening torque (N•m)
6.4	14 to 18 (1.4 to 1.8 kgf•m)
9.5	34 to 42 (3.4 to 4.2 kgf•m)
12.7	49 to 61 (4.9 to 6.1 kgf•m)
15.9	63 to 77 (6.3 to 7.7 kgf•m)

**▼ Tightening torque of flare pipe connections**

Incorrect connections may cause not only a gas leak, but also a trouble of the refrigeration cycle. Align the centres of the connecting pipes and tighten the flare nut as far as possible with your fingers. Then tighten the nut with a spanner and torque wrench as shown in the figure.

**⚠ CAUTION**

Tightening with an excessive torque may crack the nut depending on installation conditions.

**■ Evacuation**

Perform vacuuming from the charge port of valve of the outdoor unit by using a vacuum pump. For details, follow to the Installation Manual attached to the outdoor unit.

- Do not use the refrigerant sealed in the outdoor unit for evacuation.

**REQUIREMENT**

For the tools such as charge hose, use those manufactured exclusively for R32.

**Refrigerant amount to be added**

For addition of the refrigerant, add refrigerant "R32" referring to the attached Installation Manual of outdoor unit.

Use a scale to charge the refrigerant of specified amount.

**REQUIREMENT**

- Charging an excessive or too little amount of refrigerant causes a trouble of the compressor. Charge the refrigerant of specified amount.
- A personnel who charged the refrigerant should write down the pipe length and the added refrigerant amount in the F-GAS label of the outdoor unit. It is necessary to fix the compressor and refrigeration cycle malfunction.

**Open the valve fully**

Open the valve of the outdoor unit fully. A 4 mm-hexagonal wrench is required for opening the valve. For details, refer to the Installation Manual attached to the outdoor unit.

**Gas leak check**

Check with a leak detector or soap water whether gas leaks or not, from the pipe connecting section or cap of the valve.

**REQUIREMENT**

Use a leak detector manufactured exclusively for HFC refrigerant (R32, R134a, R410A, etc).

**Heat insulation process**

Apply heat insulation for the pipes separately at liquid side and gas side.

- For the heat insulation to the pipes at gas side, use the material with heat-resisting temperature 120 °C or higher.
- To use the attached heat insulation pipe, apply the heat insulation to the pipe connecting section of the indoor unit securely without gap.

**REQUIREMENT**

- Apply the heat insulation to the pipe connecting section of the indoor unit securely up to the root without exposure of the pipe. (The pipe exposed to the outside causes water leak.)
- Wrap heat insulator with its slits facing up (ceiling side).

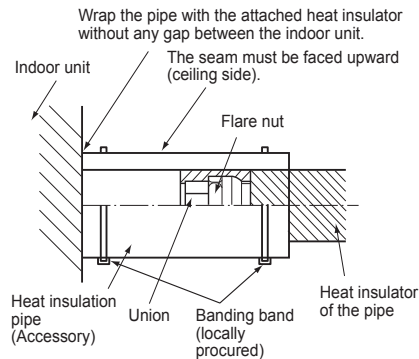

# 7 Electrical connection

**⚠ WARNING**

- Use the specified wires for wiring connect the terminals. Securely fix them to prevent external forces applied to the terminals from affecting the terminals.**  
Incomplete connection or fixation may cause a fire or other trouble.
- Connect earth wire. (grounding work)**  
Incomplete grounding cause an electric shock.  
Do not connect earth wires to gas pipes, water pipes, lightning conductor or telephone earth wires.
- Connect earth wire. (grounding work)**  
Capacity shortage of power circuit or incomplete installation may cause an electric shock or a fire.
- Under no circumstances, the power supply wire or the indoor and outdoor connecting wire must not be connected in the middle (Connection using a solderless terminal etc.)**  
Connection trouble in the places where the wire is connected in the middle may give rise to smoking and/or a fire.

**⚠ CAUTION**

- For power supply specifications, follow the Installation Manual of outdoor unit.
- Do not connect 220 – 240V power to the terminal blocks ( Ⓐ, Ⓑ ) for control wiring. Otherwise, the system will fail.
- Do not damage or scratch the conductive core and inner insulator of power and Indoor / Outdoor connecting wires during peeling them.
- Perform the electric wiring so that it does not come to contact with the high-temperature part of the pipe. The coating may melt resulting in an accident.
- Do not turn on the power of the indoor unit until vacuuming of the refrigerant pipes completes.

**■ Wiring specifications**

**Indoor / Outdoor connecting wires specifications**

**Indoor unit power supplied from outdoor unit**

- The outdoor unit power supply patterns vary on models.

Indoor unit power supply	1~50 Hz 220 - 240V
	1~60 Hz 220V

Indoor / Outdoor connecting wires*	4 x 1.5 mm <sup>2</sup> or more (H07RN-F or 60245 IEC 66)*	Up to 70 m
------------------------------------	--	------------

\*Number of wire x wire size  
\*Including earth line

**Remote controller wiring**

Remote controller wiring, remote controller inter-unit wiring	Wire size: 2 x 0.5 to 2.0 mm <sup>2</sup>	
Total wire length of remote controller wiring and remote controller inter-unit wiring = L + L1 + L2 + ... Ln	In case of wired type only	Up to 500 m
	2 remote controllers	Up to 300 m
Total wire length of remote controller inter-unit wiring = L1 + L2 + ... Ln	In case of wireless type included	Up to 400 m
		Up to 200 m

\* The remote controller wiring length differs depending on the remote controller used. For details, refer to the Installation Manual attached to the remote controller.

**⚠ CAUTION**

The remote controller wire and Indoor / Outdoor connecting wires cannot be parallel to contact each other and cannot be stored in the same conduits. If doing so, a trouble may be caused on the control system due to noise or other factor.

## ■ Communication type

TU2C-Link can be used with these models.

If the indoor unit and the connected remote controller / remote sensor are all TU2C-Link models, TU2C-Link communication will be performed automatically.

(If the TCC-Link model is included, TCC-Link communication will be performed.)

For details of communication type, refer to the following table.

### Communication type and model names

Communication type	TU2C-Link	TCC-Link
Indoor unit	RAV-HM *** series model	Other than RAV-HM *** series
Wired remote controller	RBC-A **U *** ↑ This letter indicates U series model.	Other than U series
Wireless remote controller kit & receiver unit	RBC-AXU *** ↑ This letter indicates U series model.	Other than U series
Remote sensor	TCB-TC **U *** ↑ This letter indicates U series model.	Other than U series

### ⚠ CAUTION

When connecting to the central control device dedicated to TCC-Link, it is necessary to change to TCC-Link using a wired remote controller. Set according to the Communication type procedure of "8 Applicable controls".

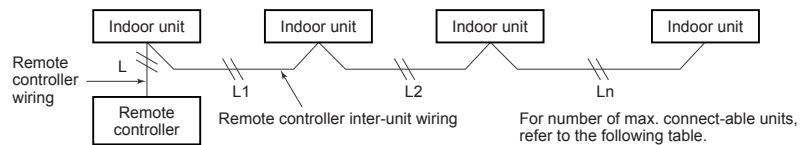

### Max. number of connect-able indoor units, and communication type

	Unit type			
	RAV-HM ***	RAV-HM ***	*	*
Indoor unit				
Remote controller	U series	*	U series	*
Remote sensor				
Communication type	TU2C-Link	TCC-Link		
Max. number of connect-able units	16	8		

\* : Other than RAV-HM \*\*\* and U series

## ■ Wiring between indoor unit and outdoor unit

- Figure below shows the wiring connections between the indoor and outdoor units and between the indoor units and remote controller. The wires indicated by the broken lines or dot-and-dash lines are provided at the locally.
- Refer to the both indoor and outdoor unit wiring diagrams.
- The power of the indoor unit is supplied from the outdoor unit.

### Wiring diagram

#### Single system

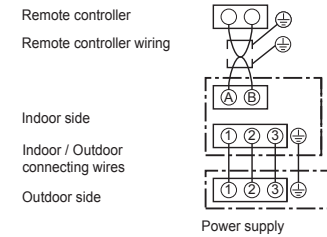

#### Simultaneous twin system

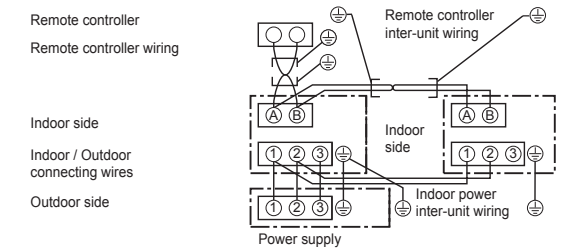

#### Simultaneous triple and double twin system

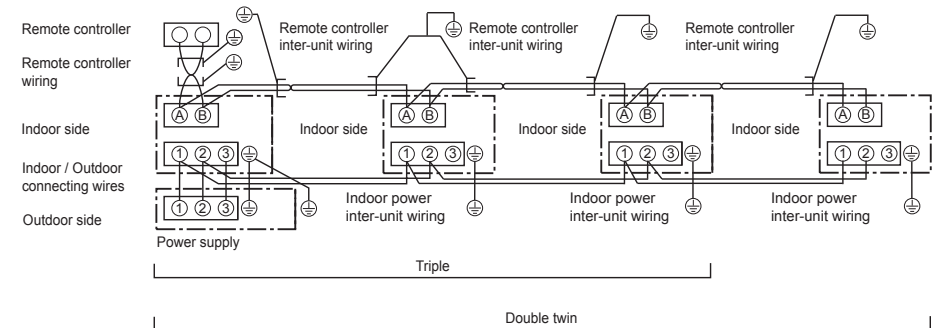

\* Use 2-core shield wire (MVVS 0.5 to 2.0 mm<sup>2</sup> or more) for the remote controller wiring in the simultaneous twin, simultaneous triple and simultaneous double twin systems to prevent noise problems. Connect both ends of the shield wire to earth leads.

\* Connect earth wires for each indoor unit in the simultaneous twin, simultaneous triple and simultaneous double twin systems.

## ■ Wire connection

### REQUIREMENT

- Connect the wires matching the terminal numbers. Incorrect connection causes a trouble.
- Pass the wires through the bushing of wire connection holes of the indoor unit.
- Keep a margin (Approx. 100 mm) on a wire to hang down the electrical control box at servicing or other purpose.
- The low-voltage circuit is provided for the remote controller. (Do not connect the high-voltage circuit)

1. Remove the cover of the electrical control box by taking off the mounting screws (2 positions) and pushing the hooking section. (The cover of the electrical control box remains hanged to the hinge.)
2. Connect the system interconnection Indoor / Outdoor connecting wires to the terminal block of the electrical control box.
3. Tighten the screws of the terminal block, and fix the wires with cord clamp attached to the electrical control box. (Do not apply tension to the connecting section of the terminal block.)
4. Using the attached heat insulation material, seal the pipe connecting port. Otherwise, dewing may be caused.
5. Mount the cover of the electrical control box without pinching wires.

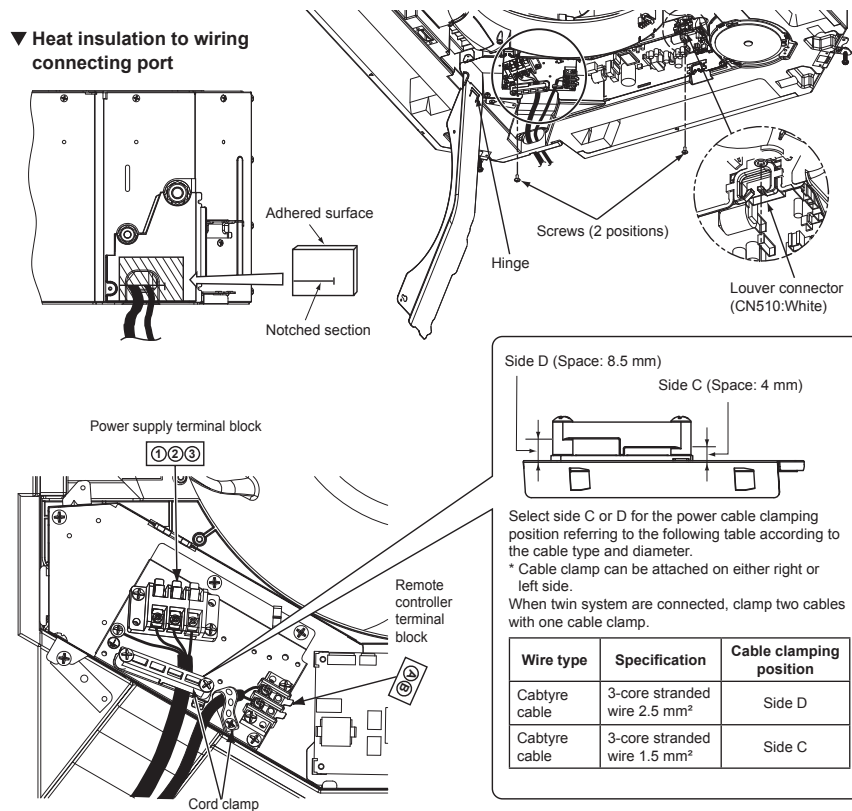

Side D (Space: 8.5 mm)

Side C (Space: 4 mm)

Select side C or D for the power cable clamping position referring to the following table according to the cable type and diameter.

\* Cable clamp can be attached on either right or left side.

When twin system are connected, clamp two cables with one cable clamp.

Wire type	Specification	Cable clamping position
Cabtyre cable	3-core stranded wire 2.5 mm <sup>2</sup>	Side D
Cabtyre cable	3-core stranded wire 1.5 mm <sup>2</sup>	Side C

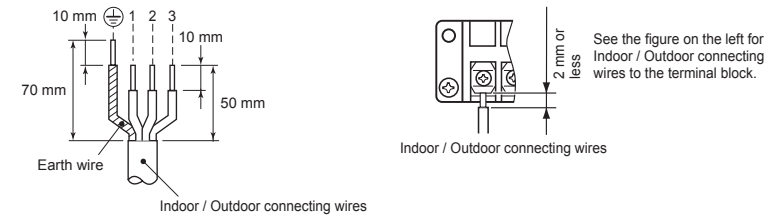

## ■ Remote controller wiring

Strip off approx. 9 mm the wire to be connected.

### Wiring diagram

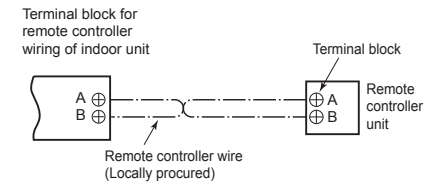

## ■ Wiring on the ceiling panel

As per the Installation Manual of the ceiling panel, connect the connector (20P: White) of the ceiling panel to the connector (CN510: White) onto the P.C. board within the electrical control box.



**⚠ WARNING**

For the synchronous twin and synchronous triple systems, perform the following to conform to EMC standards.

▼ Synchronous twin system

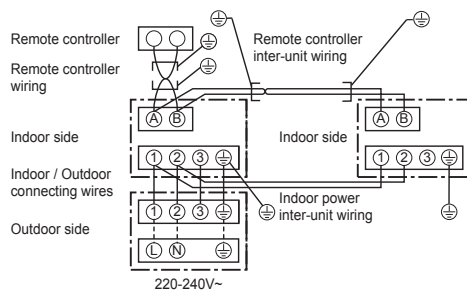

▼ Synchronous triple system

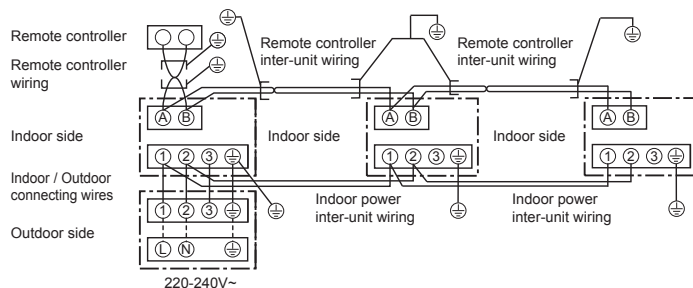

\* Use 2-core shield wire (MVVS 0.5 to 2.0 mm<sup>2</sup> or more) for the remote controller wiring in the synchronous twin and synchronous triple systems to prevent noise problems. Be sure to connect both ends of the shield wire to the earth.

\* Connect earth wire for each indoor unit in the synchronous twin and synchronous triple systems.

## 8 Applicable controls

- For using the wired remote controller RBC-AMS55E\*, refer to the Owner's Manual attached to the wired remote controller.

**REQUIREMENT**

- When you use this air conditioner for the first time, it takes approx. 5 minutes until the remote controller becomes available after power-on. This is normal. **<When power is turned on for the first time after installation>** It takes **approx. 5 minutes** until the remote controller becomes available.

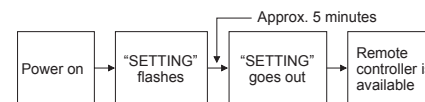

**<When power is turned on for the second (or later) time>**

It takes **approx. 1 minutes** until the remote controller becomes available.

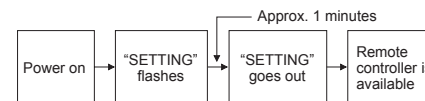

- Normal settings were made when the indoor unit was shipped from factory. Change the indoor unit settings as required.
- Use the wired remote controller to change the settings.
  - \* The settings cannot be changed using the wireless remote controller, sub remote controller, or remote-controller-less system (for central remote controller only). Therefore, install the wired remote controller to change the settings.

### ■ Applicable controls setup (settings at the site)

Remote controller model name: **RBC-ASCU1\***

**Basic procedure**

**Be sure to stop the air conditioner before making settings.**

(Change the setup while the air conditioner is not working.)

**⚠ CAUTION**

Set only the Code No. shown in the following table. Do NOT set any other Code No. If a Code No. not listed is set, it may not be possible to operate the air conditioner or other trouble with the product may result.

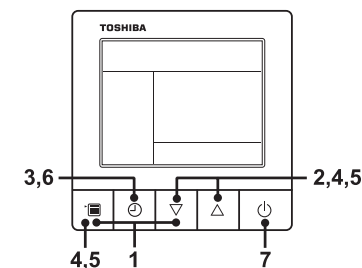

**1 Push and hold menu button and [▽] setting button simultaneously for 10 seconds or more.**

- After a while, the display flashes as shown in the figure. "ALL" is displayed as indoor unit numbers during initial communication immediately after the power has been turned on.

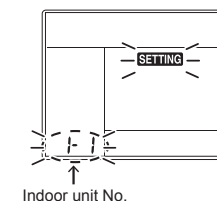

**2** Each time [▽][△] setting button is pushed, indoor unit numbers in the group control change cyclically. Select the indoor unit to change settings for.

- The fan of the selected indoor unit runs. The indoor unit can be confirmed for which to change settings.

**3** Push OFF timer button to confirm the selected indoor unit.

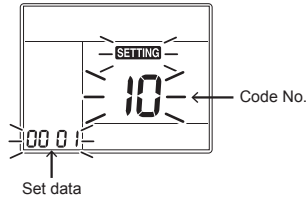

**4** Push the menu button to make Code No. [ \*\* ] flash. Change Code No. [ \*\* ] with [▽][△] setting button.

**5** Push the menu button to make Set data [ \*\*\*\* ] flash. Change Set data [ \*\*\*\* ] with [▽][△] setting button.

**6** Push OFF timer button. By doing so, the setup is completed.

- To change other settings of the selected indoor unit, repeat from Procedure 4.

**7** When all the settings have been completed, push ON/OFF button to determine the settings.

- "SETTING" flashes and then the display content disappears and the air conditioner enters the normal stop mode. (The remote controller is unavailable while "SETTING" is flashing.)
- To change settings of another indoor unit, repeat from Procedure 1.

## ■ Installing indoor unit on high ceiling

When an indoor unit is installed on a ceiling higher than the standard height, make the high-ceiling setting for fan speed adjustment.

Follow to the basic operation procedure (1 → 2 → 3 → 4 → 5 → 6).

- For the CODE No. in Procedure 4, specify [5d].
- Select the SET DATA for Procedure 5 from the "Height list of ceiling possible to be installed" table in this manual.

### ◆ Remote controller-less setting

Change the high-ceiling setting with the DIP switch on the receiver section P.C. board.

For details, refer to the manual of the wireless remote controller kit. The settings can also be changed with the switch on the indoor microcomputer P.C. board.

- \* Once the setting is changed, setting to 0001 or 0003 is possible, however setting to 0000 requires a setting data change to 0000 using the wired remote controller (separately sold) with the normal switch setting (factory default).

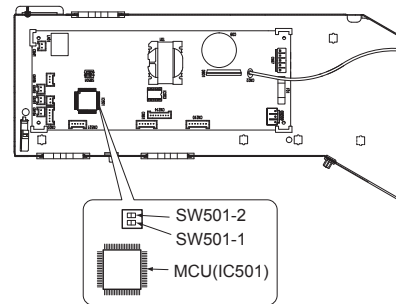

SET DATA	SW501-1	SW501-2
0000 (Factory default)	OFF	OFF
0001	ON	OFF
0003	OFF	ON

#### To restore the factory defaults

To return the DIP switch settings to the factory defaults, set SW501-1 and SW501-2 to OFF, connect a separately sold wired remote controller, and then set the data of CODE No. [5d] to "0000".

## ■ Filter sign setting

According to the installation condition, the filter sign term (Notification of filter cleaning) can be changed.

Follow to the basic operation procedure (1 → 2 → 3 → 4 → 5 → 6).

- For the CODE No. in Procedure 4, specify [01].
- For the [SET DATA] in Procedure 5, select the SET DATA of filter sign term from the following table.

SET DATA	Filter sign term
0000	None
0001	150 H
0002	2500 H (Factory default)
0003	5000 H
0004	10000 H

## ■ To secure better effect of heating

When it is difficult to obtain satisfactory heating due to installation place of the indoor unit or structure of the room, the detection temperature of heating can be raised. Also use a circulator or other device to circulate heat air near the ceiling.

Follow to the basic operation procedure (1 → 2 → 3 → 4 → 5 → 6).

- For the CODE No. in Procedure 4, specify [06].
- For the set data in Procedure 5, select the SET DATA of shift value of detection temperature to be set up from the following table.

SET DATA	Detection temperature shift value
0000	No shift
0001	+1 °C
0002	+2 °C (Factory default)
0003	+3 °C
0004	+4 °C
0005	+5 °C
0006	+6 °C

## ■ How to set up swing type

The swing type of the louver can be selected.

Follow to the basic operation procedure

(1 → 2 → 3 → 4 → 5 → 6 → 7).

- Specify [F0] for the CODE No. in Procedure 4.
- Select the following data for the SET DATA in Procedure 5.

Swing SET DATA	Swing of louvers
0001	Standard swing (Factory default)
0002	Dual swing
0003	Cycle swing

#### • About "Dual swing"

"Dual" means that louvers 01 and 03 are directed and swing in one direction and louvers 02 and 04 are directed and swing in the opposite direction. (When louvers 01 and 03 are directed downward, louvers 02 and 04 are directed horizontally.)

#### • About "Cycle swing"

The four louvers swing independently at respective timings.

### ⚠ CAUTION

Do not set the swing SET DATA to "0000". (This setting may cause a failure of the louvers.)

## ■ How to set up louver lock (No swing)

A position of the individual louvers (four directions) can be locked.

Follow to the basic operation procedure

(1 → 2 → 3 → 4 → 5 → 6 → 7).

- Specify [F1], [F2], [F3] or [F4] for the CODE No. in Procedure 4.
- Select the following data for the SET DATA in Procedure 5.

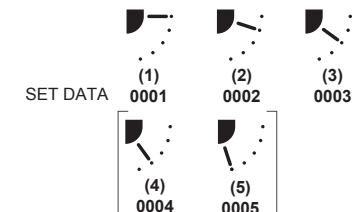

- \* When (4) or (5) is selected, dew drop may occur during cooling mode.

- When the setting has been determined, lights up.

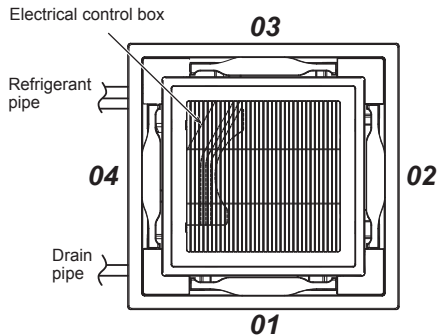

## How to cancel louver lock

Set the wind direction to “0000” of the louver lock setup procedure above.



- When the setting is canceled, goes out. **Other operations are the same as those in “How to set up louver lock (No swing)”.**

## To select horizontal wind direction

The louver positions at cooling can be changed from the smudge reducing position to the cold draftless position.

Follow to the basic operation procedure (1 → 2 → 3 → 4 → 5 → 6 → 7).

- Specify [45] for the Code NO. in Procedure 4.
- Select the following data for the SET DATA in Procedure 5.

Wind direction SET DATA	Wind direction setting
0000	Smudge reducing position (Air direction to reduce ceiling contamination) [Factory default]
0002	Cold draft position (Air direction to control cold air fall)

## Remote controller sensor

The temperature sensor of the indoor unit senses room temperature usually. Set the remote controller sensor to sense the temperature around the remote controller.

Select items following the basic operation procedure (1 → 2 → 3 → 4 → 5 → 6 → 7).

- Specify [32] for the Code No. in Procedure 4.
- Select the following data for the set data in Procedure 5.

Set data	Remote controller sensor
0000	Not in use (Factory default)
0001	In use

When flashes, the remote controller sensor is defective.

Select the set data [0000] (not in use) or replace the remote controller.

## Communication type

When connecting to the central control device dedicated to TCC-Link, it is necessary to change to TCC-Link.

Follow to the basic operation procedure (1 → 2 → 3 → 4 → 5 → 6 → 7).

- Specify [FC] for the Code No. in Procedure 4.
- Select the set data [0000] (TCC-Link) in Procedure 5.

Set data	Communication type
0000	TCC-Link
0004	TU2C-Link (Factory default)

## Fan speed setting when thermostat-OFF in cooling mode

Set the fan speed when the room temperature reaches the set temperature in the cooling mode.

Follow to the basic operation procedure (1 → 2 → 3 → 4 → 5 → 6 → 7).

- Specify [9A] for the Code No. in Procedure 4.
- Select the following data for the set data in Procedure 5.

Set data	Fan speed when thermostat-OFF in cooling mode
0000	Remote controller setting
0001	Extremely low speed (UL) (Factory default)

## 8°C operation

Pre-heating operation can be set for cold regions where room temperature drops to below zero.

Follow to the basic operation procedure

(1 → 2 → 3 → 4 → 5 → 6 → 7).

- Specify [d1] for the Code No. in Procedure 4.
- Select the following data for the set data in Procedure 5.

Set data	8°C Operation setting
0000	None (Factory default)
0001	8°C Operation setting

## Installing optional parts

When installing optional parts, data setup may be required with remote controller.

Be sure to set the data, according to Installation Manual for optional parts.

## Information

The following functions require a connection with the RBC-AMTU \*\*\* and RBC-AMSU \*\*\* remote controller. For details, refer to the manual included with the remote controller.

- Individual unit selection during group operation
- Individual setting of louver position (wind direction)
- Swing type setting
- Louver lock (no swing) setting
- Energy saving operation (Power saving operation)
- Notification of filter cleaning time

## Others

The following functions can be used with this model. Refer to the Service Manual for more information.

- Rotation / backup operation
- Free cooling
- Secondary heating
- Power shift

## Group control

### Simultaneous twin system

A combination with an outdoor unit allows simultaneous ON / OFF operation of the indoor units. The following system patterns are available.

- Two indoor units for the twin system

### ▼ Twin system

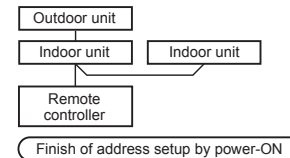

- For wiring procedure and wiring method, follow to the “Electrical connection” in this manual.
- When the power supply has been turned on, the automatic address setup starts and which indicates that address is being set up flashes on the display part.

During setup of automatic address, the remote controller operation is not accepted.

**Required time up to the finish of automatic addressing is approx. 5 minutes.**

### Group control for system of multiple units

One group can control up to 16 (TU2C-Link) or 8 (TCC-Link) indoor units with one remote controller. (Refer to the Wiring specifications)

#### ▼ Group control in single system

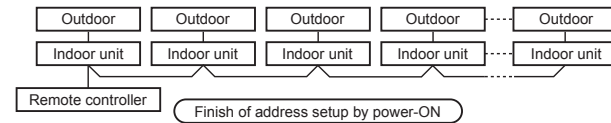

- For wiring procedure and wiring method of the individual line (Identical refrigerant line) system, follow to "Electrical connection".
- Wiring between lines is performed in the following procedure.  
Connect the terminal block (A/B) of the indoor unit connected with a remote controller to the terminal blocks (A/B) of master indoor unit of follower indoor units by wiring the inter-unit wire of the remote controller.
- When the power supply has been turned on, the automatic address setup starts and which indicates that address is being set up flashes on the display part in about 3 minutes. During setup of automatic address, the remote controller operation is not accepted.

**Required time up to the finish of automatic addressing is approx. 5 minutes.**

#### NOTE

In some cases, it is necessary to change the address manually after setup of the automatic address according to the system configuration of the group control.

- The follow mentioned system configuration is a case when complex systems in which systems of the simultaneous twin and simultaneous triple unit is controlled as a group by a remote controller.

### (Example) Group control for complex system

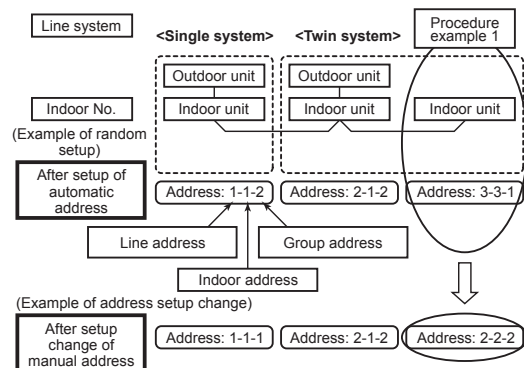

The above address is set by the automatic addressing when the power is turned on. However, line addresses and indoor addresses are set randomly. For this reason, change the setting to match line addresses with indoor addresses.

### ■ Manual address setting

- 1 Push and hold menu button and [▽] setting button simultaneously for 10 seconds or more.
- 2 Push OFF timer button to confirm the selected indoor unit.

#### <Line address>

- 3 Push the menu button until the Code No. flashes. And using the [▽][△] buttons, specify the Code No. **[12]**.
- 4 Push the menu button until the Set data flashes. And using the [▽][△] buttons, set a line address.
- 5 Push OFF timer button to confirm the Set data.

#### <Indoor unit address>

- 6 Push the menu button until the Code No. flashes. And using the [▽][△] buttons, specify the Code No. **[13]**.
- 7 Push the menu button until the Set data flashes. And using the [▽][△] buttons, set an indoor unit address.
- 8 Push OFF timer button to confirm the Set data.

#### <Group address>

- 9 Push the menu button until the Code No. flashes. And using the [▽][△] buttons, specify the Code No. **[14]**.
- 10 Push the menu button until the Set data flashes. And using the [▽][△] buttons, set a group address. If the indoor unit is individual, set the address to 0000. (header unit: 0001, follower unit: 0002)
- 11 Push OFF timer button to confirm the Set data.
- 12 When all the settings have been completed, push ON/OFF button to finish the settings. (Return to the normal mode)

### ■ To find an indoor unit's position from its address

- 1 Push and hold menu button and [▽] setting button simultaneously for 10 seconds or more.  
E.g.) A unit number 1-1 is indicated on the LCD of the remote controller. The indicated number shows the line (system) address and indoor unit address of the unit.
- 2 When 2 or more indoor units are connected to the remote controller (group-controlled units), a number of other connected units appears each time you push the [▽][△] buttons.
- 3 Push the ON/OFF button, return to the normal mode.

# 9 Test run

## ■ Before test run

- Before turning on the power supply, carry out the following procedure.
  - 1) By using insulation tester (500VMΩ), check that resistance of 1MΩ or more exists between the terminal block L to N and the earth (grounding). If resistance of less than 1MΩ is detected, do not run the unit.
  - 2) Check the valve of the outdoor unit being opened fully.
- To protect the compressor at activation time, leave power-ON for 12 hours or more for operating.

## ■ Execute a test run

Operate the unit with the remote controller as usual. For the procedure of the operation, refer to the Owner's Manual attached to the outdoor unit. A forced test run can be executed in the following procedure even if the operation stops by thermostat-OFF. In order to prevent a serial operation, the forced test run is released after 60 minutes have passed and returns to the usual operation.

### ⚠ CAUTION

- Do not use the forced test run for cases other than the test run because it applies an excessive load to the devices.

## Wired remote controller

Be sure to stop the air conditioner before making settings.

(Change the setup while the air conditioner is not working.)

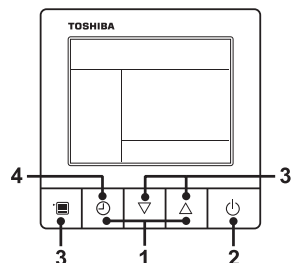

- 1 Push and hold OFF timer button and [△] setting button simultaneously for 10 seconds or more. [TEST] is displayed on the display part and the test run is permitted.

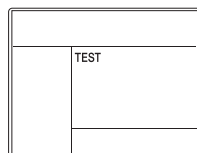

- 2 Push ON/OFF button.
- 3 Push menu button to select the operation mode. Select [Cool] or [Heat] with [▽] [△] setting button, and then push menu button (three times) again to determine the operation mode.
  - Do not run the air conditioner in a mode other than [Cool] or [Heat].
  - The temperature setting function does not work during test run.
  - The check code is displayed as usual.
- 4 After the test run, push OFF timer button to stop a test run. ([TEST] disappears on the display and the air conditioner enters the normal stop mode.)

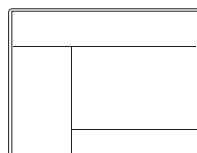

## Wireless remote controller

- 1 Turn on the power of the air conditioner. When power is turned on for the first time after installation, it takes approx. 5 minutes until the remote controller becomes available. In the case of subsequent power-on, it takes approx. 1 minute until the remote controller becomes available. Execute a test run after the predetermined time has passed.

- 2 Push "ON/OFF" button on the remote controller, select [Cool] or [Heat] with "MODE" button, and then select [HIGH] with "FAN" button.

- 3

Cooling test run	Heating test run
Set the temperature to 17°C with the temp. setup buttons.	Set the temperature to 30°C with the temp. setup buttons.

- 4

Cooling test run	Heating test run
After confirming a signal receiving sound "beep" immediately set the temperature to 18°C with the temp. setup buttons.	After confirming a signal receiving sound "beep" immediately set the temperature to 29°C with the temp. setup buttons.

- 5

Cooling test run	Heating test run
After confirming a signal receiving sound "beep" immediately set the temperature to 17°C with the temp. setup buttons.	After confirming a signal receiving sound "beep" immediately set the temperature to 30°C with the temp. setup buttons.

- 6 Repeat procedures 4 → 5 → 4 → 5. Indicators "Operation" (green), "Timer" (green), and "Ready" (orange) in the wireless receiver section flash in approx. 10 seconds, and the air conditioner starts operation. If any of these indicators does not flash, repeat procedures 2 to 5.

- 7 Upon completion of the test run, push "ON/OFF" button to stop operation.

<Overview of test run operations using the wireless remote controller>

▼ Cooling test run:  
ON/OFF → 17°C → 18°C → 17°C → 18°C → 17°C → 18°C → 17°C → (test run) → ON/OFF

▼ Heating test run:  
ON/OFF → 30°C → 29°C → 30°C → 29°C → 30°C → 29°C → 30°C → (test run) → ON/OFF

## ◆ Wireless remote controller (RBC-AX32U series)

### Test run (forced cooling operation)

#### REQUIREMENT

Finish the forced cooling operation in a short time because it applies excessive strength to the air conditioner.

#### ▼ How to perform forced cooling operation

- 1 When TEMPORARY button is pushed for 10 seconds or more, "Pi!" sound is heard and the operation changes to a forced cooling operation. After approx. 3 minutes, a cooling operation starts forcibly. Check cool air starts blowing. If the operation does not start, check wiring again.
- 2 To stop a test operation, push TEMPORARY button once again (approx. 1 second).

- Check wiring / piping of the indoor and outdoor units in forced cooling operation.

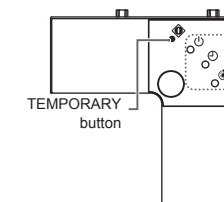

## ■ Monitoring function

This function can be used to call the service monitor mode from the remote controller during a test run to obtain the temperature of the sensors of the remote controller, indoor unit, and outdoor unit.

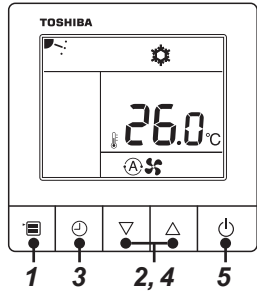

"Monitoring function" display

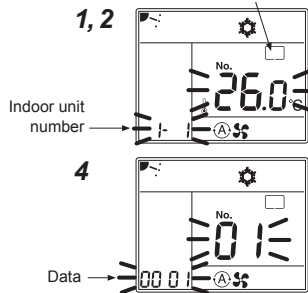

- 1** Push and hold menu button for 10 seconds or more. "Monitoring function" is displayed on a screen.
- 2** Every pushing [▽] [△] buttons, the indoor unit numbers in group control are displayed successively.
- 3** Push OFF timer button to confirm the selected indoor unit.
- 4** Every pushing [▽] [△] buttons, Code No. of the item is changed successively.
- 5** After you have finished checking, push "ON/OFF" button, return to normal mode.

Indoor unit data	
Code No.	Data name
01	Room temperature (remote controller)
02	Indoor unit intake air temperature (TA)
03	Indoor unit heat exchanger (coil) temperature (TCJ)
04	Indoor unit heat exchanger (coil) temperature (TC)
07	Indoor unit fan speed (×1 rpm)
B9	Communication protocol (0000: TCC-Link, 0001: TU2C-Link)
F3	Indoor unit fan cumulative operating hours (×1 h)
F8	Indoor unit discharge air temperature *1

Outdoor unit data *2	
Code No.	Data name
60	Outdoor unit heat exchanger (coil) temperature (TE)
61	Outside air temperature (TO)
62	Compressor discharge temperature (TD)
63	Compressor suction temperature (TS)
65	Heatsink temperature (THS)
6A	Operating current (×1/10)
6D	Outdoor heat exchange (coil) temperature (TL)
F1	Compressor cumulative operating hours (×100 h)

- \*1 : The above temperature values are estimated from the temperature of the heat exchanger. It may differ from the actual discharge temperature.  
 \*2 : For outdoor unit data, refer to the Installation Manual and Service Manual of the outdoor unit.

# 10 Maintenance

## ⚠ CAUTION

Before maintenance, be sure to turn off the leakage breaker.

### Cleaning of air filter

- Clogging of the air filter reduce cooling / heating performance.

### Cleaning of panel and air filter

#### Preparation :

1. Turn off the air conditioner by the remote controller.
2. Open the air intake grille.
  - Slide the button of the air intake grille inward, and open the air intake grille slowly while holding it.

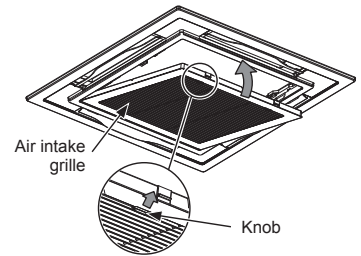
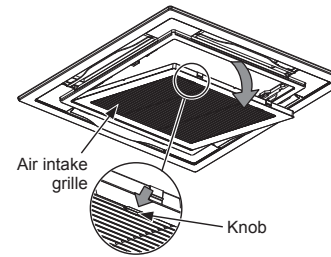

### Cleaning of air filters

If the air filters are not cleaned, it not only reduce the cooling a performance of air conditioner but causes a failure in the air conditioner such as water falling in drops.

#### Preparation :

1. Stop the operation by remote controller.
2. Dismount the air filter.

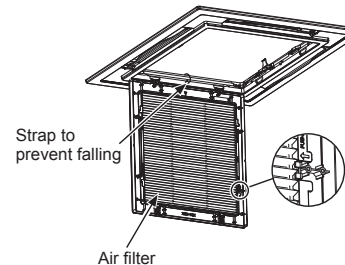

### Use a vacuum cleaner to remove dust from the filters or wash them with water.

- After rinsing the air filters with water, dry them in the shade.
- Set the air filter into the air conditioner.

### Clean the panel and air filter with water:

- Wipe down the panel and air filter with a sponge or towel moistened with a kitchen detergent. (Do not use any metallic brush for cleaning.)
- Carefully rinse the panel and air filter to wash out the detergent.
- After rinsing the panel and air filter with water, dry it in the shade.
  1. Close the air intake grille.
    - Close the air intake grille, slide the knob outward, and fix the air intake grille securely.

2. Turn on the circuit breaker, then push the [ON] button on the remote controller to start operation.

## ⚠ CAUTION

- Do not start the air conditioner while leaving the panel and air filter removed.

### Cleaning of discharge louver

The discharge louver can be removed to clean.

1. Remove the discharge louver.
  - Holding the both ends of the discharge louver, remove the louver sagging the center downward.

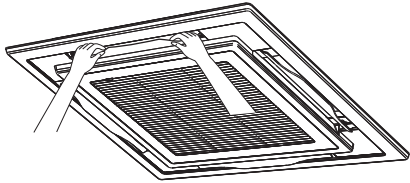

2. Cleaning with water
  - If the dirt is terrible, clean the louver by tepid water with neutral detergent or water.
3. Mount the discharge louver.
  - First push in one side of the louver, and then insert the other side sagging the center downward.

(1) Insert (2) Insert in the louver sagging down the center downward.

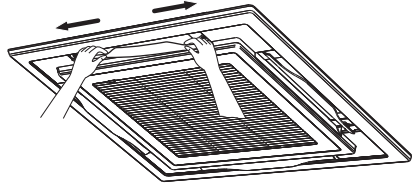

**Be careful to the direction of the louver when mounting.**

Mount the louver so that the side with the mark faces upward.

#### REQUIREMENT

**Be sure to clean the heat exchanger with pressurized water.**

If a commercially available detergent (strong alkaline or acid) cleaning agent is used, the surface treatment of the heat exchanger will be marred, which may degrade the self cleaning performance.

For details, contact the dealer.

### ▼ Periodic Maintenance

For environmental conservation, it is strongly recommended that the indoor and outdoor units of the air conditioner in use be cleaned and maintained regularly to ensure efficient operation of the air conditioner.

When the air conditioner is operated for a long time, periodic maintenance (once a year) is recommended. Furthermore, regularly check the outdoor unit for rust and scratches, and remove them or apply rustproof treatment, if necessary.

As a general rule, when an indoor unit is operated for 8 hours or more daily, clean the indoor unit and outdoor unit at least once every 3 months. Ask a professional for this cleaning / maintenance work.

Such maintenance can extend the life of the product though it involves the owner's expense.

Failure to clean the indoor and outdoor units regularly will result in poor performance, freezing, water leakage, and even compressor failure.

### Inspection before maintenance

Following inspection must be carried out by a qualified installer or qualified service person.

Parts	Possible installed ceiling height
Heat exchanger	Access from inspection opening and remove the access panel. Examine the heat exchanger if there is any clogging or damages.
Fan motor	Access from inspection opening and check if any abnormal noise can be heard.
Fan	Access from inspection opening and remove the access panel. Examine the fan if there are any waggles, damages or adhesive dust.
Filter	Go to installed location and check if there are any stains or breaks on the filter.
Drain pan	Access from inspection opening and remove the access panel. Check if there is any clogging or drain water is polluted.

### ▼ Maintenance List

Parts	Unit	Check (visual / auditory)	Maintenance
Heat exchanger	Indoor / outdoor	Dust / dirt clogging, scratches	Wash the heat exchanger when it is clogged.
Fan motor	Indoor / outdoor	Sound	Take appropriate measures when abnormal sound is generated.
Filter	Indoor	Dust / dirt, breakage	<ul style="list-style-type: none"> <li>• Wash the filter with water when it is contaminated.</li> <li>• Replace it when it is damaged.</li> </ul>
Fan	Indoor	<ul style="list-style-type: none"> <li>• Vibration, balance</li> <li>• Dust / dirt, appearance</li> </ul>	<ul style="list-style-type: none"> <li>• Replace the fan when vibration or balance is terrible.</li> <li>• Brush or wash the fan when it is contaminated.</li> </ul>
Air intake / discharge grilles	Indoor / outdoor	Dust / dirt, scratches	Fix or replace them when they are deformed or damaged.
Drain pan	Indoor	Dust / dirt clogging, drain contamination	Clean the drain pan and check the downward slope for smooth drainage.
Ornamental panel, louvres	Indoor	Dust / dirt, scratches	Wash them when they are contaminated or apply repair coating.
Exterior	Outdoor	<ul style="list-style-type: none"> <li>• Rust, peeling of insulator</li> <li>• Peeling / lift of coat</li> </ul>	Apply repair coating.

# 11 Troubleshooting

## Confirmation and check

If a problem occurs with the air conditioner, the OFF timer indicator alternately shows the check code and the indoor Unit No. in which the problem occurred.

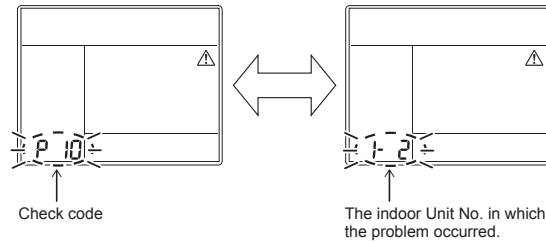

## Troubleshooting history and confirmation

You can check the troubleshooting history with the following procedure if a problem occurs with the air conditioner. (The troubleshooting history records up to 4 incidents.)

You can check it during operation or when operation is stopped.

- If you check the troubleshooting history during OFF timer operation, the OFF timer will be canceled.

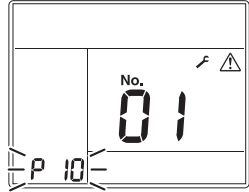
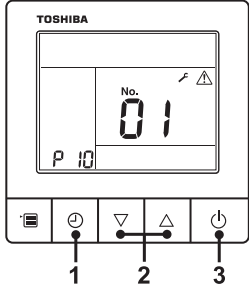
Procedure	Description of operation
1	<p>Push the OFF timer button for over 10 seconds and the indicators appear as an image indicating the troubleshooting history mode has been entered. If [Service check] is displayed, the mode enters in the troubleshooting history mode.</p> <ul style="list-style-type: none"> <li>• [01: Order of troubleshooting history] appears in the temperature indicator.</li> <li>• The OFF timer indicator alternately shows the [check code] and the [indoor Unit No. ] in which the problem occurred.</li> </ul> 
2	<p>Each time the setting button is pushed, the recorded troubleshooting history is displayed in sequence. The troubleshooting history appears in order from [01] (newest) to [04] (oldest).</p> <p><b>CAUTION</b></p> <p>In the troubleshooting history mode, DO NOT push the Menu button for over 10 seconds, doing so deletes the entire troubleshooting history of the indoor unit.</p> 
3	<p>After you have finished checking, push the ON/OFF button to return to the regular mode.</p> <ul style="list-style-type: none"> <li>• If the air conditioner is operating, it remains operated even after the ON/OFF button has been pushed. To stop its operation, push the ON/OFF button again.</li> </ul>

## Error codes and parts to be checked

Wired remote controller display	Wireless remote controller Sensor block display of receiving unit		Main defective parts	Judging device	Parts to be checked / error description	Air conditioner status
	Indication	Operation Timer Ready GR GR OR				
E01	○ ● ●		No header remote controller Remote controller communication error	Remote controller	Incorrect remote controller setting --- The header remote controller has not been set (including two remote controllers). No signal can be received from the indoor unit.	*
E02	○ ● ●		Remote controller transmission error	Remote controller	Indoor / Outdoor connecting wires, indoor P.C. board, remote controller --- No signal can be sent to the indoor unit.	*
E03	○ ● ●		Indoor unit-remote controller regular communication error	Indoor	Remote controller, network adapter, indoor P.C. board --- No data is received from the remote controller or network adapter.	Auto-reset
E04	● ● ○		Indoor unit-outdoor unit serial IPDU-CDB communication error	Indoor	Indoor / Outdoor connecting wires, indoor P.C. board, outdoor P.C. board --- Serial communication error between indoor unit and outdoor unit	Auto-reset
E08	○ ● ●		Duplicated indoor addresses ★	Indoor	Indoor address setting error --- The same address as the self-address was detected.	Auto-reset
E09	○ ● ●		Duplicated header remote controllers	Remote controller	Remote controller address setting error --- Two remote controllers are set as header in the double-remote controller control. (* The header indoor unit stops raising alarm and follower indoor units continue to operate.)	*
E10	○ ● ●		CPU-CPU communication error	Indoor	Indoor P.C. board --- Communication error between main MCU and motor microcomputer MCU	Auto-reset
E11	○ ● ●		Communication trouble between Application control kit and Indoor unit	Indoor	Communication trouble between Application control kit and Indoor unit	Entire stop
E18	○ ● ●		Header unit follower unit regular communication error	Indoor	Indoor P.C. board --- Regular communication is not possible between header and follower indoor units or between twin header (main) and follower (sub) units.	Auto-reset
E31	● ● ○		IPDU communication error	Outdoor	Communication error between IPDU and CDB	Entire stop
F01	○ ○ ●	ALT	Indoor unit heat exchanger sensor (TCJ) error	Indoor	Heat exchanger sensor (TCJ), indoor P.C. board --- Open-circuit or short-circuit of the heat exchanger sensor (TCJ) was detected.	Auto-reset
F02	○ ○ ●	ALT	Indoor unit heat exchanger sensor (TCJ) error	Indoor	Heat exchanger sensor (TC), indoor P.C. board --- Open-circuit or short-circuit of the heat exchanger sensor (TC) was detected.	Auto-reset
F04	○ ○ ○	ALT	Outdoor unit discharge temp. sensor (TD) error	Outdoor	Outdoor temp. sensor (TD), outdoor P.C. board --- Open-circuit or short-circuit of the discharge temp. sensor was detected.	Entire stop
F06	○ ○ ○	ALT	Outdoor unit temp. sensor (TE/TS) error	Outdoor	Outdoor temp. sensors (TE/TS), outdoor P.C. board --- Open-circuit or short-circuit of the heat exchanger temp. sensor was detected.	Entire stop
F07	○ ○ ○	ALT	TL sensor error	Outdoor	TL sensor may be displaced, disconnected or short-circuited.	Entire stop
F08	○ ○ ○	ALT	Outdoor unit outside air temp. sensor error	Outdoor	Outdoor temp. sensor (TO), outdoor P.C. board --- Open-circuit or short-circuit of the outdoor air temp. sensor was detected.	Operation continued
F10	○ ○ ●	ALT	Indoor unit room temp. sensor (TA) error	Indoor	Room temp. sensor (TA), indoor P.C. board --- Open-circuit or short-circuit of the room temp. sensor (TA) was detected.	Auto-reset
F12	○ ○ ○	ALT	TS sensor error	Outdoor	TS sensor may be displaced, disconnected or short-circuited.	Entire stop



Wired remote controller display	Wireless remote controller Sensor block display of receiving unit		Main defective parts	Judging device	Parts to be checked / error description	Air conditioner status
	Indication	Operation Timer Ready GR GR OR				
F13	◎ ◎ ○	ALT	Heat sink sensor error	Outdoor	Abnormal temperature was detected by the temp. sensor of the IGBT heat sink.	Entire stop
F15	◎ ◎ ○	ALT	Temp. sensor connection error	Outdoor	Temp. sensor (TE/TS) may be connected incorrectly.	Entire stop
F29	◎ ◎ ●	SIM	Indoor unit, other P.C. board error	Indoor	Indoor P.C. board --- EEPROM error	Auto-reset
F30	◎ ◎ ○	SIM	Occupancy sensor trouble	Indoor	Abnormality was detected from occupancy sensor.	Operation continued
F31	◎ ◎ ○	SIM	Outdoor unit P.C. board	Outdoor	Outdoor P.C. board ---- In the case of EEPROM error.	Entire stop
H01	● ◎ ●		Outdoor unit compressor breakdown	Outdoor	Current detect circuit, power voltage --- Minimum frequency was reached in the current releasing control or short-circuit current (Idc) after direct excitation was detected	Entire stop
H02	● ◎ ●		Outdoor unit compressor lock	Outdoor	Compressor circuit --- Compressor lock was detected.	Entire stop
H03	● ◎ ●		Outdoor unit current detect circuit error	Outdoor	Current detect circuit, outdoor unit P.C. board --- Abnormal current was detected in AC-CT or a phase loss was detected.	Entire stop
H04	● ◎ ●		Case thermostat operation	Outdoor	Malfunction of the case thermostat	Entire stop
H06	● ◎ ●		Outdoor unit low-pressure system error	Outdoor	Current, high-pressure switch circuit, outdoor P.C. board --- Pressure sensor error was detected or low-pressure protective operation was activated.	Entire stop
L03	◎ ● ◎	SIM	Duplicated indoor indoor units ★	Indoor	Indoor address setting error --- There are two or more header units in the group.	Entire stop
L07	◎ ● ◎	SIM	Group line in individual indoor unit ★	Indoor	Indoor address setting error --- There is at least one group-connected indoor unit among individual indoor units.	Entire stop
L08	◎ ● ◎	SIM	Indoor group address not set ★	Indoor	Indoor address setting error --- Indoor address group has not been set.	Entire stop
L09	◎ ● ◎	SIM	Indoor unit capacity not set	Indoor	Indoor unit capacity has not been set.	Entire stop
L10	◎ ○ ◎	SIM	Outdoor unit P.C. board	Outdoor	In the case of outdoor P.C. board jumper wire (for service) setting error	Entire stop
L20	◎ ○ ◎	SIM	LAN communication error	Network adapter central control	Address setting, central control remote controller, network adapter --- Duplication of address in central control communication	Auto-reset
L29	◎ ○ ◎	SIM	Other outdoor unit	Outdoor	Other outdoor unit error 1) Communication error between IPDU MCU and CDB MCU 2) Abnormal temperature was detected by the heat sink temp. sensor in IGBT.	Entire stop
L30	◎ ○ ◎	SIM	Abnormal external input into indoor unit (interlock)	Indoor	External devices, outdoor unit P.C. board --- Abnormal stop due to incorrect external input into CN80	Entire stop
L31	◎ ○ ◎	SIM	Phase sequence error, etc.	Outdoor	Power supply phase sequence, outdoor unit P.C. board --- Abnormal phase sequence of the 3-phase power supply	Operation continued (thermostat at OFF)
P01	● ◎ ◎	ALT	Indoor unit fan error	Indoor	Indoor fan motor, indoor P.C. board --- Indoor AC fan error (fan motor thermal relay activated) was detected.	Entire stop
P03	◎ ● ◎	ALT	Outdoor unit discharge temp. error	Outdoor	An error was detected in the discharge temp. releasing control.	Entire stop
P04	◎ ● ◎	ALT	Outdoor unit high-pressure system error	Outdoor	High-pressure switch --- The IOL was activated or an error was detected in the high-pressure releasing control using the TE.	Entire stop

Wired remote controller display	Wireless remote controller Sensor block display of receiving unit		Main defective parts	Judging device	Parts to be checked / error description	Air conditioner status
	Indication	Operation Timer Ready GR GR OR				
P05	◎ ● ◎	ALT	Open phase detected	Outdoor	The power wire may be connected incorrectly. Check open phase and voltages of the power supply.	Entire stop
P07	◎ ● ◎	ALT	Heat sink overheat	Outdoor	Abnormal temperature was detected by the temp. sensor of the IGBT heat sink.	Entire stop
P10	● ◎ ◎	ALT	Indoor unit water overflow detected	Indoor	Drain pipe, clogging of drainage, float switch circuit, indoor P.C. board --- Drainage is out of order or the float switch was activated.	Entire stop
P12	● ◎ ◎	ALT	The fan error of the indoor unit	Indoor	Abnormal operation of the indoor fan motor, indoor P.C. board, or indoor DC fan (over current or lock, etc.) is detected.	Entire stop
P15	◎ ● ◎	ALT	Gas leakage detected	Outdoor	There may be gas leakage from the pipe or connecting part. Check for gas leakage.	Entire stop
P19	◎ ● ◎	ALT	4-way valve error	Outdoor (Indoor)	4-way valve, indoor temp. sensors (TC/TCJ) --- An error was detected due to temperature drop of the indoor unit heat exchanger sensor when heating.	Auto-reset
P20	◎ ● ◎	ALT	High-pressure protective operation	Outdoor	High-pressure protection	Entire stop
P22	◎ ● ◎	ALT	Outdoor unit fan error	Outdoor	Outdoor unit fan motor, outdoor unit P.C. board --- An error (overcurrent, locking, etc.) was detected in the outdoor unit fan drive circuit.	Entire stop
P26	◎ ● ◎	ALT	Outdoor unit inverter Idc activated	Outdoor	IGBT, outdoor unit P.C. board, inverter wiring, compressor --- Short-circuit protection for compressor drive circuit devices (G-Tr/IGBT) was activated.	Entire stop
P29	◎ ● ◎	ALT	Outdoor unit position error	Outdoor	Outdoor unit P.C. board, high-pressure switch --- Compressor motor position error was detected.	Entire stop
P31	◎ ● ◎	ALT	Other indoor unit error	Indoor	Another indoor unit in the group is raising an alarm. E03/L07/L03/L08 alarm check locations and error description	Auto-reset

○ : Lighting ◎ : Flashing ● : OFF ★ : The air conditioner automatically enters the auto-address setting mode.  
ALT: When two LEDs are flashing, they flash alternately. SIM: When two LEDs are flashing, they flash in synchronization. Receiving unit display OR: Orange GR: Green

# 12 Specifications

Model	Sound pressure level (dBA)		Weight (kg)
	Cooling	Heating	
RAV-HM561UTP-E	*	*	20
RAV-HM801UTP-E	*	*	20
RAV-HM901UTP-E	*	*	24
RAV-HM1101UTP-E	*	*	24
RAV-HM1401UTP-E	*	*	24
RAV-HM1601UTP-E	*	*	24

\* Under 70 dBA

## Declaration of Conformity

Manufacturer: Toshiba Carrier (Thailand) Co., Ltd.  
144/9 Moo 5, Bangkadi Industrial Park, Tivanon road, Tambol Bangkadi,  
Amphur Muang, Pathumthani 12000, Thailand

TCF holder: TOSHIBA CARRIER EUROPE S.A.S  
Route de Thil 01120 Montluel FRANCE

Hereby declares that the machinery described below:

Generic Denomination: Air Conditioner

Model / type: RAV-HM561UTP-E,  
RAV-HM801UTP-E,  
RAV-HM901UTP-E,  
RAV-HM1101UTP-E,  
RAV-HM1401UTP-E,  
RAV-HM1601UTP-E

Commercial name: Digital Inverter Series / Super Digital Inverter Series Air Conditioner

Complies with the provisions of the Machinery Directive (Directive 2006/42/EC) and the regulations transposing into national law

Name: Masaru Takeyama  
Position: GM, Quality Assurance Dept.  
Date: 5 April, 2022  
Place Issued: Thailand

### NOTE

This declaration becomes invalid if technical or operational modifications are introduced without the manufacturer's consent.

## Declaration of Conformity

Manufacturer: Toshiba Carrier (Thailand) Co., Ltd.  
144/9 Moo 5, Bangkadi Industrial Park, Tivanon road, Tambol Bangkadi,  
Amphur Muang, Pathumthani 12000, Thailand

TCF holder: TOSHIBA CARRIER UK LTD.  
Porsham Close Belliver Industrial Estate Roborough Plymouth Devon  
PL6 7DB United Kingdom

Hereby declares that the machinery described below:

Generic Denomination: Air Conditioner

Model / type: RAV-HM561UTP-E,  
RAV-HM801UTP-E,  
RAV-HM901UTP-E,  
RAV-HM1101UTP-E,  
RAV-HM1401UTP-E,  
RAV-HM1601UTP-E

Commercial name: Digital Inverter Series / Super Digital Inverter Series Air Conditioner

Complies with the provisions of the Supply of Machinery (Safety) Regulations 2008

Name: Masaru Takeyama  
Position: GM, Quality Assurance Dept.  
Date: 5 April, 2022  
Place Issued: Thailand

### NOTE

This declaration becomes invalid if technical or operational modifications are introduced without the manufacturer's consent.

# 13 Appendix

## Work instructions

The existing R22 and R410A piping can be reused for inverter R32 product installations.

### WARNING

Confirming the existence of scratches or dents on the existing pipes and confirming the reliability of the pipe strength are conventionally referred to the local site.

If the specified conditions can be cleared, it is possible to update existing R22 and R410A pipes to those for R32 models.

### Basic conditions needed to reuse existing pipes

Check and observe the presence of three conditions in the refrigerant piping works.

1. **Dry** (There is no moisture inside of the pipes.)
2. **Clean** (There is no dust inside of the pipes.)
3. **Tight** (There are no refrigerant leaks.)

### Restrictions for use of existing pipes

In the following cases, the existing pipes should not be reused as they are. Clean the existing pipes or exchange them with new pipes.

1. When a scratch or dent is heavy, be sure to use new pipes for the refrigerant piping works.
2. When the existing pipe thickness is thinner than the specified "Pipe diameter and thickness," be sure to use new pipes for the refrigerant piping works.
  - The operating pressure of refrigerant is high. If there is a scratch or dent on the pipe or a thinner pipe is used, the pressure strength may be inadequate, which may cause the pipe to break in the worst case.

#### \* Pipe diameter and thickness (mm)

Pipe outer diameter		Ø6.4	Ø9.5	Ø12.7	Ø15.9
Thickness	R32, R410A	0.8	0.8	0.8	1.0
	R22				

3. When the outdoor unit was left with the pipes disconnected, or the gas leaked from the pipes and the pipes were not repaired and refilled.
  - There is the possibility of rain water or air, including moisture, entering the pipe.
4. When refrigerant cannot be recovered using a refrigerant recovery unit.
  - There is the possibility that a large quantity of dirty oil or moisture remains inside the pipes.

5. When a commercially available dryer is attached to the existing pipes.
  - There is the possibility that copper green rust has been generated.
6. When the existing air conditioner is removed after refrigerant has been recovered. Check if the oil is judged to be clearly different from normal oil.
  - The refrigerator oil is copper rust green in color: There is the possibility that moisture has mixed with the oil and rust has been generated inside the pipe.
  - There is discolored oil, a large quantity of residue, or a bad smell.
  - A large quantity of shiny metal dust or other wear residue can be seen in the refrigerant oil.
7. When the air conditioner has a history of the compressor failing and being replaced.
  - When discolored oil, a large quantity of residue, shiny metal dust, or other wear residue or mixture of foreign matter is observed, trouble will occur.
8. When temporary installation and removal of the air conditioner are repeated such as when leased etc.
9. If the type of refrigerator oil of the existing air conditioner is other than the following oil (Mineral oil), Suniso, Freol-S, MS (Synthetic oil), alkyl benzene (HAB, Barrel-freeze), ester series, PVE only of ether series.
  - The winding-insulation of the compressor may deteriorate.

### NOTE

The above descriptions are results have been confirmed by our company and represent our views on our air conditioners, but do not guarantee the use of the existing pipes of air conditioners that have adopted R32 in other companies

### Curing of pipes

When removing and opening the indoor or outdoor unit for a long time, cure the pipes as follows:

- Otherwise rust may be generated when moisture or foreign matter due to condensation enters the pipes.
- The rust cannot be removed by cleaning, and new pipes are necessary.

Placement location	Term	Curing manner
Outdoors	1 month or more	Pinching
	Less than 1 month	Pinching or taping
Indoors	Every time	

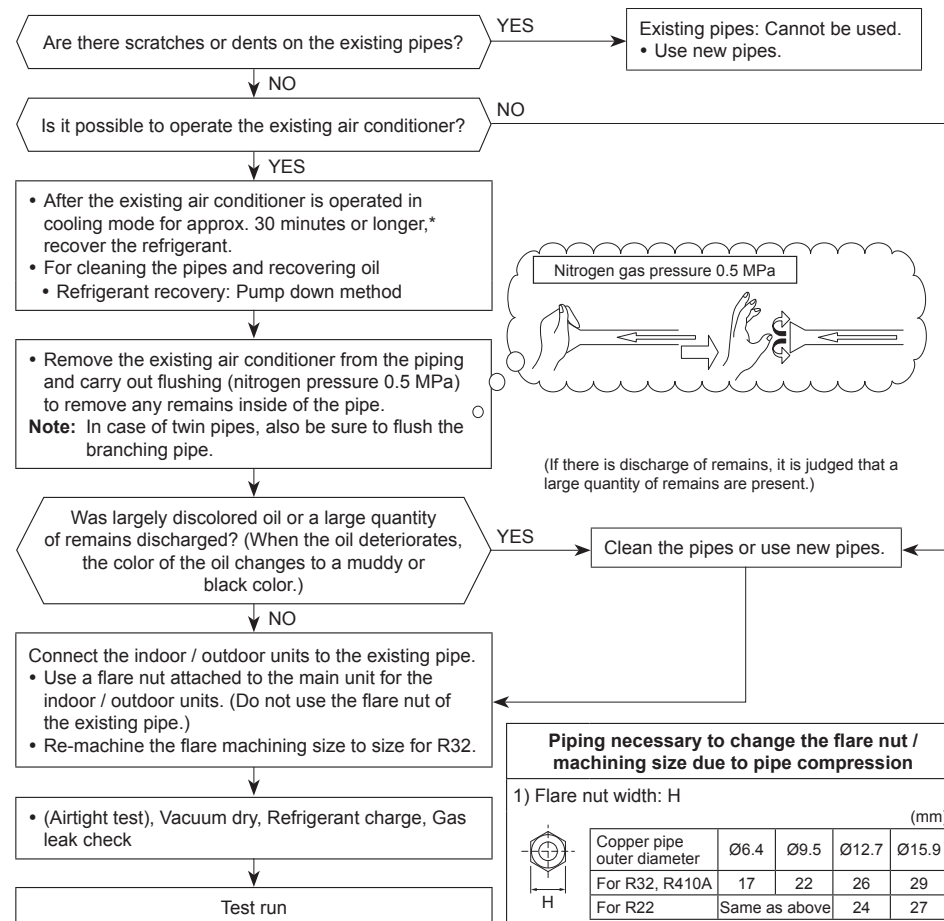

### Piping necessary to change the flare nut / machining size due to pipe compression

1) Flare nut width: H (mm)				
Copper pipe outer diameter	Ø6.4	Ø9.5	Ø12.7	Ø15.9
For R32, R410A	17	22	26	29
For R22	Same as above		24	27

2) Flare machining size: A (mm)				
Copper pipe outer diameter	Ø6.4	Ø9.5	Ø12.7	Ø15.9
For R32, R410A	9.1	13.2	16.6	19.7
For R22	9.0	13.0	16.2	19.4

Becomes a little larger for R32

Do not apply refrigerator oil to the flare surface.

# **Toshiba Carrier (Thailand) Co., Ltd.**

144 / 9 Moo 5, Bangkadi Industrial Park, Tivanon Road, Tambol Bangkadi, Amphur Muang, Pathumthani 12000, Thailand

1115350191