

# TOSHIBA

R32 or R410A

***INVERTER***

ENGLISH

## OWNER'S MANUAL

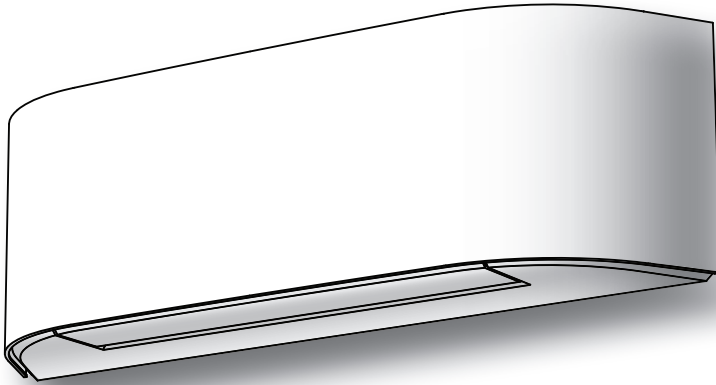

### **AIR CONDITIONER (SPLIT TYPE)**

For general public use

Indoor unit

RAS-B10, 13, 16N4KVRG-E

Outdoor unit

RAS-10, 13, 16J2AVSG-E1

## PRECAUTIONS FOR SAFETY



Read the precautions in this manual carefully before operating the unit.



This appliance is filled with R32.

### ■ Warning indications on the air conditioner unit

Warning indication	Description
	<p><b>CAUTION</b></p> <p><b>BURST HAZARD</b></p> <p>Open the service valves before the operation, otherwise there might be the burst.</p>

- Keep this manual where the operator can easily find it.
- Read the precautions in this manual carefully before operating the unit.
- This appliance is intended to be used by expert or trained users in shops, in light industry and on farms, or for commercial use by lay persons.
- The precautions described herein are classified as DANGER, WARNING and CAUTION. They both contain important information regarding safety. Be sure to observe all precautions without fail.

### **DANGER**

- Do not install, repair, open or remove the cover. It may expose you to dangerous voltages. Ask the dealer or the specialist to do this.
- Turning off the power supply will not prevent potential electric shock.
- The appliance shall be installed in accordance with national wiring regulation.
- Means for disconnection from the supply having a contact separation of at least 3 mm in all poles must be incorporated in the fixed wiring.
- The appliance must be stored in a room without continuously operating ignition sources (for example, open flames, an operating gas appliance or an operating electric heater).
- In order to avoid fire, explosion or injury, do not operate the unit when harmful gases (e.g. flammable or corrosive) are detected near the unit.

### **WARNING**

- Do not expose your body directly to cool or warm air for a long time.
- Do not insert your finger or any article into the air inlet/outlet.
- When an abnormality (burning smell, etc.) occurs, stop the air conditioner and disconnect the power supply or turn off the breaker.
- This appliance can be used by children aged from 8 years and above and persons with reduced physical, sensory or mental capabilities or lack of experience and knowledge if they have been given supervision or instruction concerning use of the appliance in a safe way and understand the hazards involved. Children shall not play with the appliance. Cleaning and user maintenance shall not be made by children without supervision.

## PRECAUTIONS FOR SAFETY

- This appliance is not intended for use by person (including children) with reduced physical, sensory or mental capabilities, or lack of experience and knowledge, unless they have been given supervision or instruction concerning use of the appliance by a person responsible for their safety.
- The air conditioner must be installed, maintained, repaired and removed by a qualified installer or qualified service person. When any of these jobs is to be done, ask a qualified installer or qualified service person to do them for you.
- Children should be supervised to ensure that they do not play with the appliance.
- Do not use any refrigerant different from the one specified (R32) for complement or replacement. Otherwise, abnormally high pressure may be generated in the refrigeration cycle, which may result in a failure or explosion of the product or an injury to your body.
- Do not use means to accelerate the defrosting process or to clean, other than those recommended by the manufacturer.
- The appliance shall be stored in a room without continuously operating ignition sources (for example: open flames, an operating gas appliance or an operating electric heater).
- Be aware that refrigerants may not contain an odour.
- Do not pierce or burn as the appliance is pressurized. Do not expose the appliance to heat, flames, sparks, or other sources or ignition. Else, it may explode and cause injury or death.

### CAUTION

- Do not wash the unit with water. It may cause an electric shock.
- Do not use this air conditioner for other purposes such as preserving food, breeding animal, etc.
- Do not step or put anything on the indoor/outdoor unit. It may cause an injury or damage the unit.
- Do not touch aluminium fin because it may cause an injury.
- Before cleaning the unit, turn off the main switch or the circuit breaker.
- When the unit won't be used for a long time, turn off the main switch or the circuit breaker.
- It is recommended that maintenance be performed by a specialist when the unit has been operated for a long time.
- The manufacturer shall not assume any liability for the damage caused by not observing the description of this manual.
- Remote controller and Holder are contained with magnet please keep far from product that effect with magnet (such as electronics appliance magnetic strip card and etc.)
- High temperature, high magnet field and direct force collisions may effect to magnet force down.

## 1 INDOOR UNIT DISPLAY

- 
- ① ECO (White)
  - ② Wi-Fi access (White)
  - ③ PURE (White)
  - ④ Timer (White)
  - ⑤ Operation Mode
    - Cool (Blue)
    - Heat (Orange)

• Display brightness can be adjusted, follow procedure on ⑪.

## 2 PREPARATION BEFORE USE

### Preparing Filters

- Open the air inlet grille and remove the air filters.
- Attach the filters. (see detail in the Installation Manual).

### Loading Batteries (when use wireless operation.)

- Remove the slide cover.
- Insert 2 new batteries (AAA type) following the (+) and (-) positions.

### Remote Control Reset

- Remove the batteries.
- Press .
- Insert the batteries.

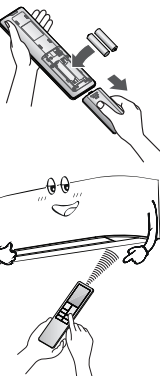

## 3 AIR FLOW DIRECTION

<b>1</b>	Press  : Move the louver in the desired vertical direction.	
<b>2</b>	Press  : Move the louver in the desired horizontal direction.	
<b>3</b>	<p>SWING operation can be selected from MENU button </p>	<ul style="list-style-type: none"> <li>• Vertical (Up-Down) swing</li> <li>• Horizontal (Left-Right) swing</li> <li>• HADA Care flow</li> </ul>

### Note:

- Do not move the louver manually by hands or others.
- The louver may automation positioning by some operation mode.

## 4 REMOTE CONTROL

- Infrared signal emitter
  - Start/Stop button
  - Mode select button
  - Temperature button
  - Fan speed button
  - Menu select button
  - Set louver Up-Down button
  - Set louver Left-Right button
  - Check button\*
- \*Check button under battery cover

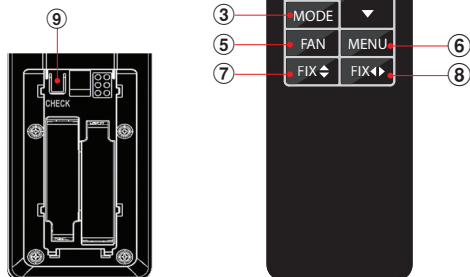

## 5 COOLING / FAN ONLY OPERATION

- Press : Select Cool or Fan only .
- Press : Set the desired temperature. Min. 17°C, Max. 30°C.  
Fan Only: No temperature indication
- Press : Select AUTO, LOW , LOW+ , MED , MED+ , HIGH or Quiet .

## 6 AUTOMATIC OPERATION

To automatically select cooling, heating, or fan only operation

- Press : Select Auto A.
- Press : Set the desired temperature. Min. 17°C, Max. 30°C.
- Press : Select AUTO, LOW , LOW+ , MED , MED+ , HIGH or Quiet .

## 7 HEATING and 8°C OPERATION

- Press : Select Heat .
- Press : Set the desired temperature. Min = 5°C, Max = 30°C.  
\* Temperature range 5-16°C is Heat mode with 8°C operation with less of energy usage
- Press : Select AUTO, LOW , LOW+ , MED , MED+ , HIGH or Quiet .

**Note:** During 8°C mode active (temperature range 5-16°C), some operation such as QUIET, Hi POWER, TIMER OFF cannot use.

## 8 DRY OPERATION

For dehumidification, a moderate cooling performance is controlled automatically.

- Press : Select Dry .
- Press : Set the desired temperature. Min. 17°C, Max. 30°C.

**Note:** DRY mode fan speed is set to Auto only.

## 9 MENU SETUP

For select more setting of Air conditioner such as Louver select ,Hi Power, OFF Timer and other use MENU button  MENU



## 9.1 LOUVER SWING and HADA CARE FLOW OPERATION



Comfortable air flow can select from feature.

**Louver swing operation:** 

- To distribute air flow in both vertical and horizontal by swing the louver automatically.

**HADA care flow operation:**  H.D.A

- Air flow upward to the ceiling, provide Indirect air flow to body and homogenize room temperature.

**Note:**

- During HADA CARE FLOW mode, FIX button cannot active.

### Louver Swing and HADA Care Flow Operation Setting

- Press MENU button for enter menu selection

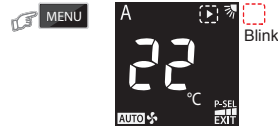

During triangle mark blink  can select menu by press TEMP. button.



- Enter Louver set by press MENU button again. triangle mark will stop blink and setting feature will be blink instead.

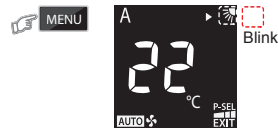

- Select Louver swing or HADA CARE FLOW by press TEMP. button.

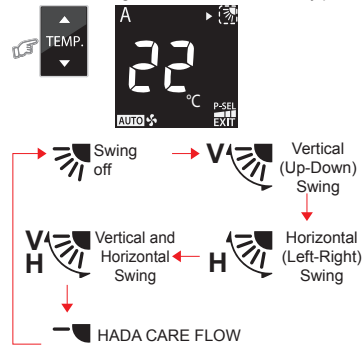

### H.D.A

- Confirm selected feature by press MENU button again.



When feature had selected will return to menu selection display triangle mark will blink .

- Leave from menu setting display by select exit and press menu button



Leave from menu setting to normal display (no triangle and feature blink).

## 9.2 SILENT OPERATION (Outdoor Unit)



Keep outdoor unit operating silently to ensure either yourself or neighborhood will have a tight sleep in nighttime. By this feature, the heating capacity will be optimized to deliver such silent experience. The silent operation can be selected from one of two purposes (Silent 1 and Silent 2). There are three setting parameters: Standard level > Silent 1 > Silent 2

### Silent 1:

- Though operating silently, the Heating (or Cooling) capacity is still prioritized to ensure having sufficient comfort inside the room.
- This setting is a perfect balance between the Heating (or Cooling) capacity and the Sound level of outdoor unit.

### Silent 2:

- Compromising the Heating (or Cooling) capacity to the Sound level in any circumstance where the outdoor unit's sound level is highly prioritized.
- This setting has a purpose to reduce the maximum sound level of outdoor unit by 4 dB(A).

#### Note:

- While activating of Silent operation, inadequate heating (or cooling) capacity may occur.

### Silent Operation Setting

- Press MENU button for enter menu selection

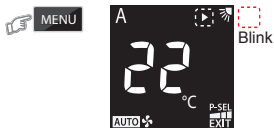

During triangle mark blink can select menu by press TEMP. button.



- Enter SILENT set by press MENU button. triangle mark will stop blink and setting feature will be blink instead.

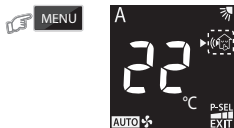

- Select SILENT operation by press TEMP. button.

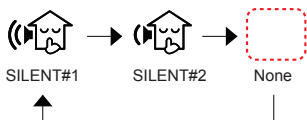
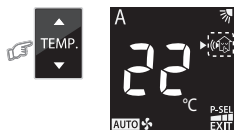

- Confirm selected feature by press MENU button again.



When feature had selected will return to menu selection display triangle mark will blink

- Leave from menu setting display by select EXIT.

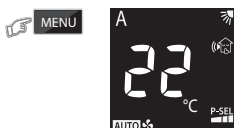

## 9.3 Hi POWER OPERATION

# Hi-P

To automatically control room temperature and airflow for faster cooling or heating operation (except in DRY and FAN ONLY mode)

- Press MENU button for enter menu setting and press TEMP. button to select Hi POWER



- Confirm selected feature by press MENU button again.

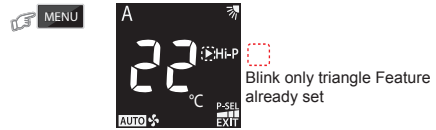

- Leave from menu setting display by select EXIT.



## 9.4 ECO OPERATION

# ECO

To automatically control room temperature to save energy (except in DRY and FAN ONLY mode)

- Press MENU button for enter menu setting and press TEMP. button to select ECO

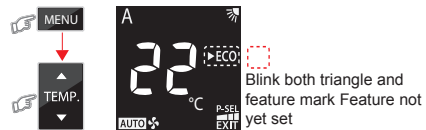

- Confirm selected feature by press MENU button again.



- Leave from menu setting display by select EXIT.



#### Note:

- Cooling operation; the set temperature will increase automatically 1 degree/hour for 2 hours (maximum 2 degrees increase). For heating operation the set temperature will decrease.

## 9.5 FIREPLACE OPERATION



Keep indoor unit's fan blowing continuously during thermo off, to circulate heat from other sources over the room. There are three setting parameters: Default setting > Fireplace 1 > Fireplace 2

### Fireplace 1:



- During thermo off period, the indoor unit's fan will continue to run by the same speed, previously selected by end-user.

### Fireplace 2:



- During thermo off period, the indoor unit's fan will continue to run at super-low speed, programmed from factory.

### Fireplace Operation Setting

1. Press MENU button for enter menu setting and press TEMP. button to select FIREPLACE



2. Enter FIREPLACE set by press MENU button. triangle mark will stop blink and setting feature will be blink instead.



3. Select FIREPLACE operation by press TEMP. button.

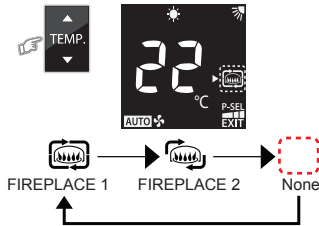

4. Confirm selected feature by press MENU button again.



When feature had selected will return to menu selection display triangle mark will blink

5. Leave from menu setting display by select EXIT.



#### Note:

- While Fireplace operation on heating mode, indoor unit fan always runs and cold air breezing might be occurred.
- Fireplace will operate in Heating mode only.

## 9.6 TIMER OFF OPERATION



To set the timer OFF when the air conditioner is operating.

1. Press MENU button for enter menu setting and press TEMP. button to select TIMER OFF.



2. Enter TIMER set by press MENU button. triangle mark will stop blink and setting feature will be blink instead.

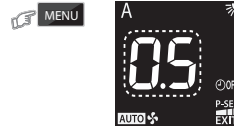

3. Select TIMER OFF by press TEMP. button. Can select TIMER OFF from 0.5 - 12hrs.

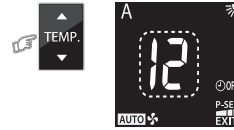

4. Confirm TIMER OFF by press MENU button.



5. Leave from menu setting display by select EXIT.

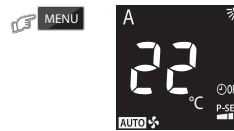

#### Note:

- The setting will be saved for the next same operation.

### Cancel TIMER OFF

6. During TIMER OFF already set (no.5) press MENU button and press TEMP. button to select TIMER OFF.



7. Press MENU button again will cancel TIMER OFF.



8. Leave from menu setting display by select EXIT.



## 9.7 PLASMA ION OPERATION

# PURE

Capture efficiency of floating impurities in the air is accelerated by plasma ion contaminates such as bacteria, odor, smoke, dust and virus are caught and deactivated by Plasma Ion.

1. Press MENU button for enter menu setting and press TEMP. button to select PURE



2. Confirm selected feature by press MENU button again.

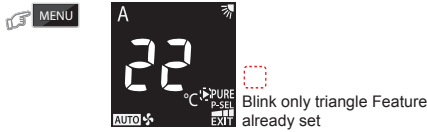

3. Leave from menu setting display by select EXIT.

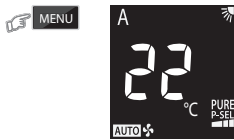

### Note:

- Plasma Ion operation dose not remove harmful substances from cigarette smoke (carbon monoxide etc.). Open a window occasionally for ventilation.

## 9.8 POWER-SELECTION OPERATION

# P-SEL

This function is used when the circuit breaker is shared with other electrical appliances. It limits the maximum current and power consumption to 100%, 75%, or 50% and can be implemented by POWER-SELECTION. The lower percentage, the higher saving and also longer compressor lifetime.

### Notes :

- Due to the reason that POWER-SELECTION function limits the maximum current, inadequate cooling or heating capacity may occur.
1. Press MENU button for enter menu setting and press TEMP. button to select POWER-SEL

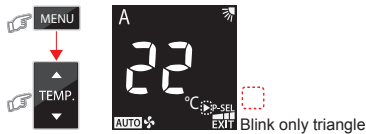

2. Enter POWER-SEL setting by press MENU button again.

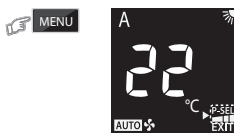

3. Select POWER-SEL level by press TEMP. button.

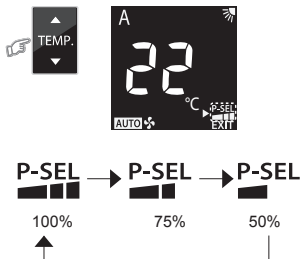

4. Confirm POWER-SEL level by press MENU button.



5. Leave from menu setting display by select EXIT.



## 10 MANUAL DEFORST OPERATION

- To defrosting the heat exchanger of the outdoor unit during Heating operation Press and hold : for 5 seconds , then remote control display will show dF as picture ① for 2 seconds.



## 11 DISPLAY LAMP BRIGHTNESS ADJUSTMENT

To decrease the display lamp brightness or turn it off.

1. Press and hold for 3 seconds until brightness level (d0, d1, d2 or d3) is shown on remote control LCD then release the button.
2. Press to adjust brightness in 4 levels.

Remote control LCD	Operation display	Brightness
d3	Lamp illuminates full brightness.	100%
d2	Lamp illuminates 50% brightness.	50%
d1	Lamp illuminates 50% brightness and the operation lamp is turned off.	50%
d0	All lamps are turned off.	All turned off

- In the examples of d1 and d0, the lamp illuminates for 5 seconds before going off.

## 12 AUTO RESTART FUNCTION SETTING

This product is designed so that, after a power failure, it can restart automatically in the same operating mode as before the power failure.

### Information

The product was shipped with Auto Restart function in the OFF position. Turn it ON as required.

### How to turn ON the Auto Restart Function

- Press and hold the [OPERATION] button on the indoor unit for 3 seconds (3 beep sounds and OPERATION lamp blink 5 time/sec for 5 seconds).

### How to turn OFF the Auto Restart Function

- Press and hold the [OPERATION] button on the indoor unit for 3 seconds (3 beep sounds but OPERATION lamp does not blink).

### Notes :

- In case of ON timer or OFF timer are set, AUTO RESTART OPERATION does not activate.

## 13 SELF CLEANING OPERATION (COOL AND DRY OPERATION ONLY)

To protect bad smell caused by the humidity in the indoor unit.

1. If the button is pressed once during "Cool" or "Dry" mode, the fan will continue to run for other 30 minutes, then it will turn off automatically. This will reduce the moisture in the indoor unit.
2. To stop the unit immediately, press the more 2 times within 30 seconds.



## 14 TEMPORARY OPERATION

In case of the misplaced or discharged remote control

- Pressing the RESET button, the unit can start or stop without using the remote control.
- Operation mode is set on AUTOMATIC operation, preset temperature is 24°C and fan operation is automatic speed.

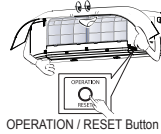

## 15 REMOTE CONTROL A-B SELECTION

To separate using of remote control for each indoor unit in case of 2 air conditioners are installed nearby.

### Remote Control B Setup.

1. Press RESET button on the indoor unit to turn the air conditioner ON.
2. Point the remote control at the indoor unit.
3. Push and hold button on the back side of Remote Control "00" will be shown on the display. (Picture ①)
4. Press during pushing . "B" will show on the display and "00" will disappear and the air conditioner will turn OFF. The Remote Control B is memorized. (Picture ②)

- Note:**
1. Repeat above step to reset Remote Control to be A.
  2. Remote Control A has not "A" display.
  3. Default setting of Remote Control from factory is A.

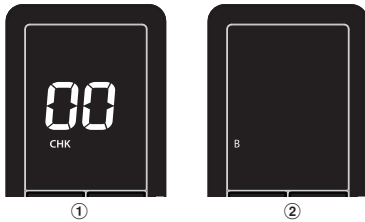

## 16 OPERATION AND PERFORMANCE

1. Three-minute protection feature: To prevent the unit from being activated for 3 minutes when suddenly restarted or switched to ON.
2. Preheating operation: Warm up the unit for 5 minutes before the heating operation starts.
3. Warm air control: When the room temperature reaches the set temperature, the fan speed is automatically reduced and the outdoor unit will stop.
4. Automatic defrosting: Fans will stop during defrost operation.
5. Heating capacity: Heat is absorbed from outdoors and released into the room. When the outdoor temperature is too low, use another recommended heating apparatus in combination with the air conditioner.
6. Consideration for accumulated snow: Select the position for outdoor unit where it will not be subjected to snow drifts, accumulation of leaves or other seasonal debris.
7. Some minor cracking sound may occur when unit operating. This is normal because the cracking sound may be caused by expansion/contraction of plastic.

**Note:** Item 2 to 6 for Heating model

### Air conditioner operating conditions

Operation	Temp.	
	Outdoor Temperature	Room Temperature
Heating	-15°C ~ 24°C	Less than 28°C
Cooling	-15°C ~ 46°C	21°C ~ 32°C
Dry	-15°C ~ 46°C	17°C ~ 32°C

## 17 MAINTENANCE

- Firstly, turn off the circuit breaker.

### Indoor Unit and Remote Control

- Clean the indoor unit and the remote control with a wet cloth when needed.
- No benzine, thinner, polishing powder or chemically-treated duster.

### Air filters

Clean every 2 weeks.

1. Open the air inlet grille.
2. Remove the air filters.
3. Vacuum or wash and then dry them.
4. Reinstall the air filters and close the air inlet grille.

## 18 TROUBLESHOOTING (CHECK POINT)

The unit does not operate.	Cooling or Heating is abnormally low.
<ul style="list-style-type: none"> <li>• The power main switch is turned off.</li> <li>• The circuit breaker is activated to cut off the power supply.</li> <li>• Stoppage of electric current</li> <li>• ON timer is set.</li> </ul>	<ul style="list-style-type: none"> <li>• The filters are blocked with dust.</li> <li>• The temperature has been set improperly.</li> <li>• The windows or doors are opened.</li> <li>• The air inlet or outlet of the outdoor unit is blocked.</li> <li>• The fan speed is too low.</li> <li>• The operation mode is FAN or DRY.</li> <li>• POWER SELECTION function is set 75% or 50% (<b>This function is depend on remote controller.</b>)</li> </ul>

# 19 WIRELESS LAN CONNECTION

## Toshiba Home AC Control

Please visit the application store on your device to download and install Toshiba Home AC Control application.



### Application

Keyword : Toshiba Home AC Control

## About Toshiba Home AC Control

1. Toshiba Home AC Control can control AC operation by Smartphone or tablet (mobile device) via internet connection.
2. Everywhere control, control software run on Cloud system and mobile device can set and monitor AC operation via internet connection.
3. Everyone can control, 1 Wireless adapter maximum 5 User (use 1 email register).
4. Multi AC system control, 1 user can control 10 AC.
5. Group control.
  - 5.1 Can create and control 3 groups of AC.
  - 5.2 Can control max 10 AC per group.

### Note:

1. Adapter can register only 1 email address, if register with new email, current email will be invalid.
2. 1 email address can use for register 5 devices for control same AC.

## Toshiba Home AC Control application support



iOS : 9.0 or later.



Android : Version 5.0 or later.

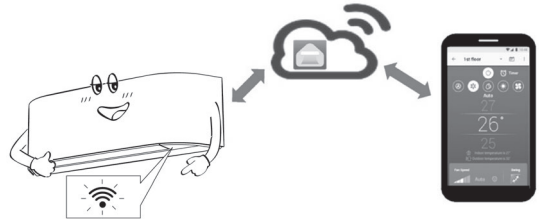

## Register process

Open an application and follow register for User registration.

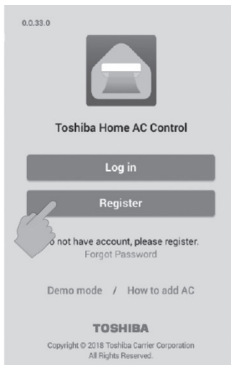

① Tab Register

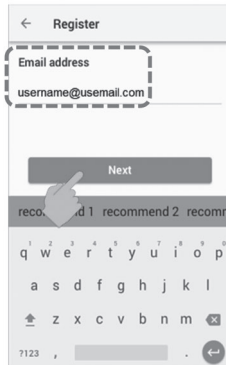

② Enter email address

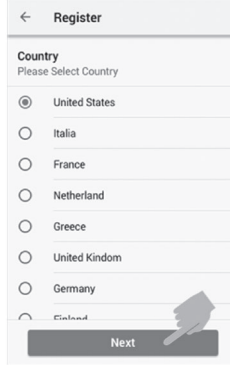

③ Select country

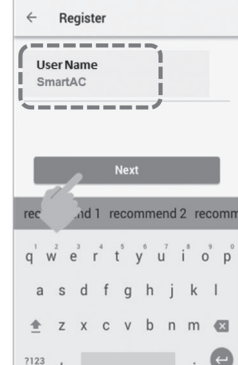

④ Enter user name

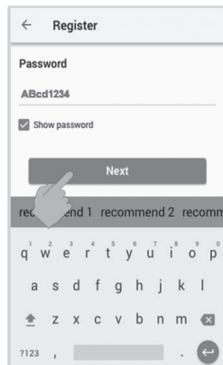

⑤ Enter password by 6-10 characters, combination of alphabet and number

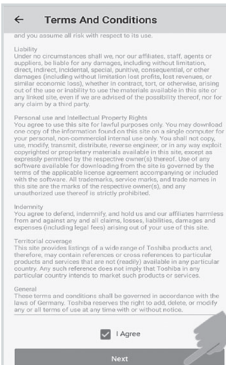

⑥ Check for term and condition

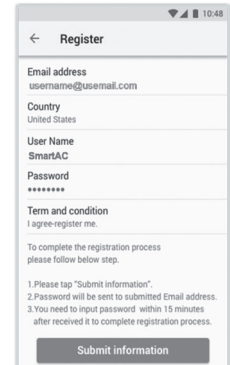

⑦ Confirm information



⑧ Information will be submitted to email, click link to confirm

**Login to Toshiba Home AC Control application.**

- 1 Connect Wireless adapter to A/C and turn on power supply.

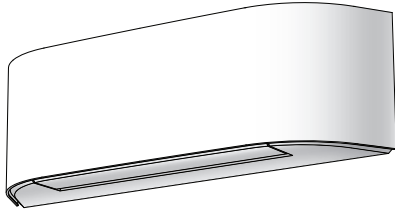

Build-in type , Wireless adapter already install with unit.

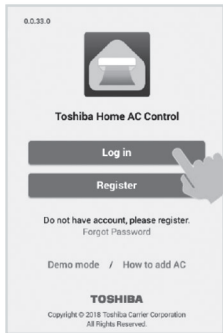

- 2 Open application and select Log in.

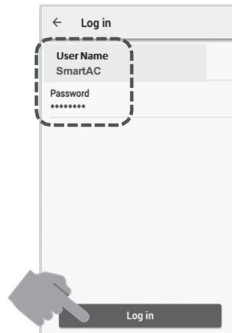

- 3 Enter user name and password.

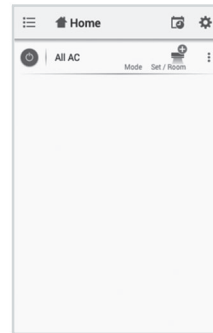

- 4 Login successful.

**Add Wireless adapter for control by Toshiba Home AC Control application.**

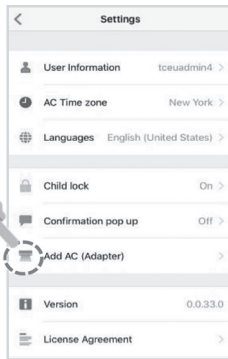
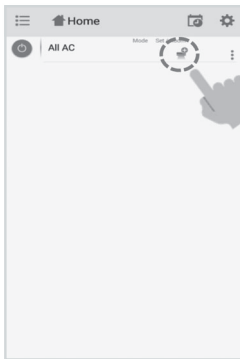

- 1 Select "Add AC (Adapter)" from both display above.

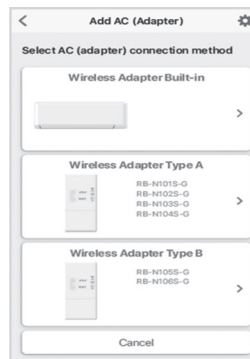

- 2 Select AC (adapter) connection method.

Wireless adapter Build-in  
Active Wireless adapter by remote controller and Auto login.

**\*Note**

1. In case of Wi-Fi router change or Email for register change need to re-process for add Wireless adapter again (Build in type : Press MODE button at Remote controller 5 seconds for active AP mode).
2. In case of change Wireless adapter to use with other A/C need to factory reset and re-process for add Wireless adapter again (Build in type : Press MODE button at Remote controller 5 seconds and select "rb").

**Add Wireless adapter for control by Toshiba Home AC Control application.**

**③ AC (adapter) connect**

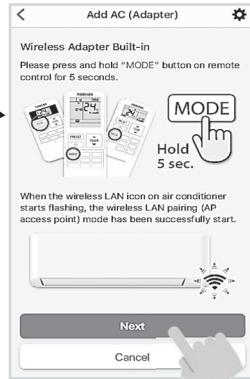
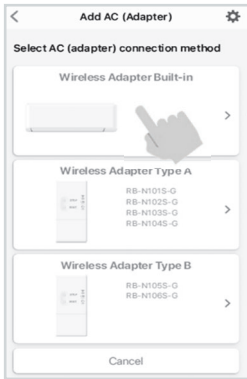

**④ Active Wireless adapter by Remote controller**

Press and hold MODE button 5 seconds

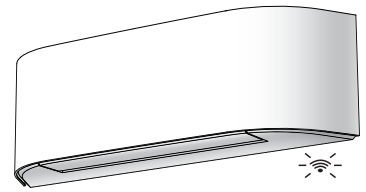
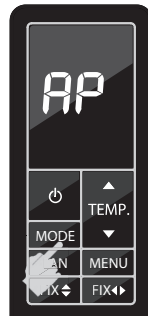

Wireless LED mark will blink when AP mode active



**⑤ Connect with Home Wi-Fi Router**

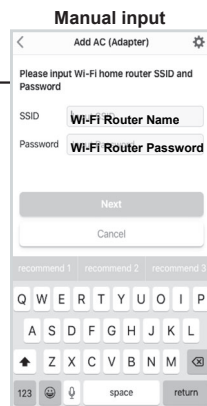
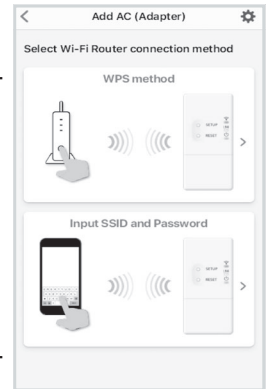

**⑥ A/C add finished**

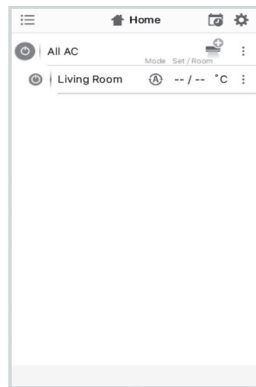

**⑦ Connect successfully**

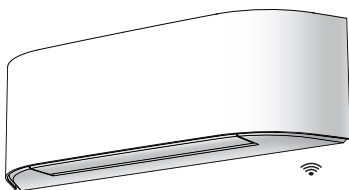

Wireless LED lamp stop blink.

Toshiba Home AC Control application

Home screen

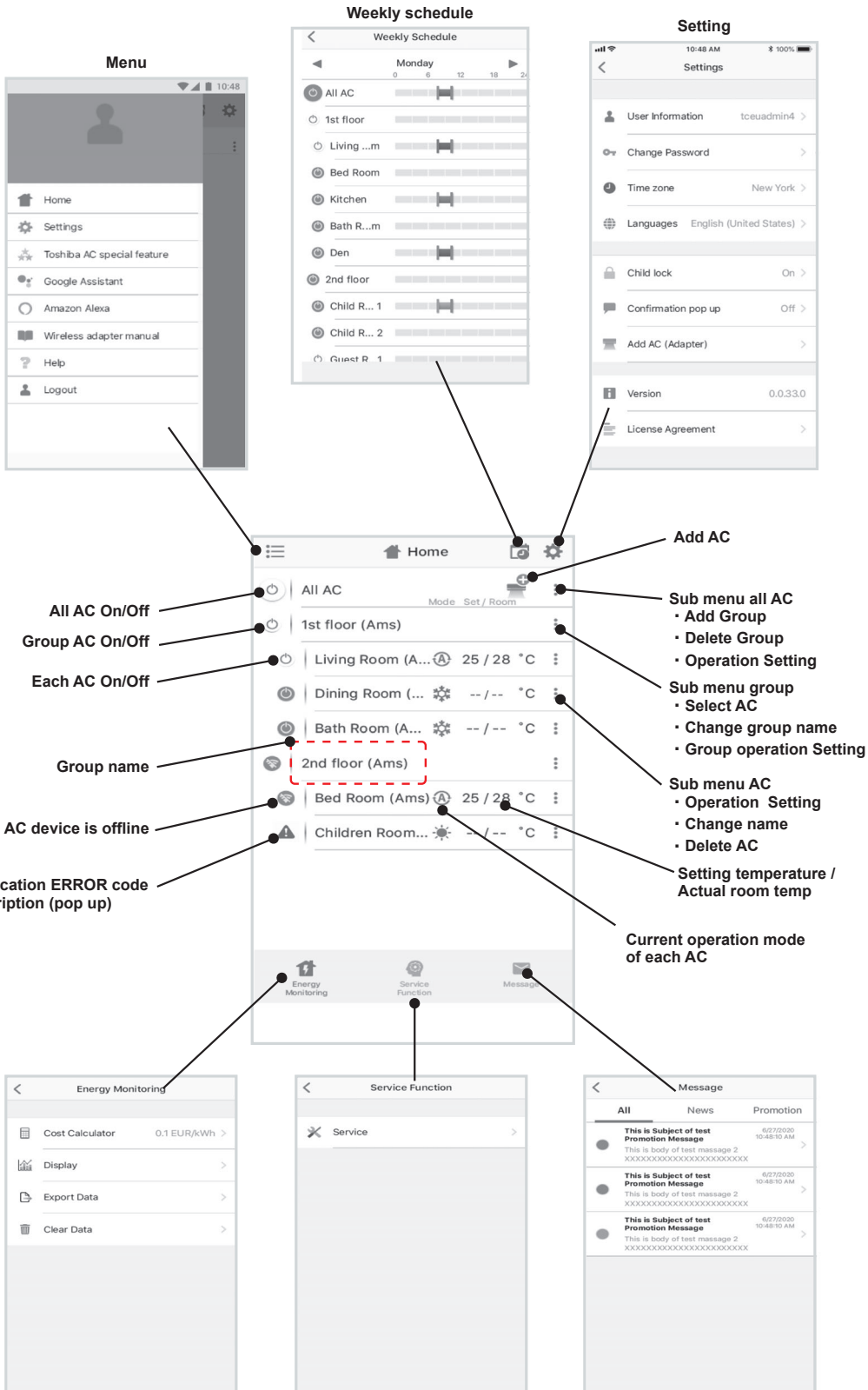

**Mode and Condition setting.**

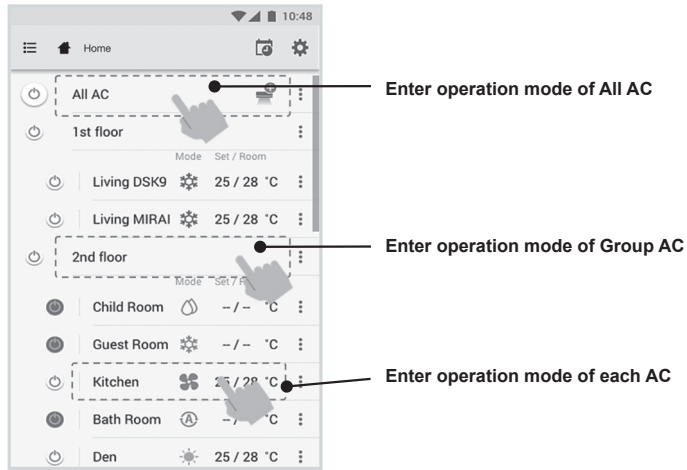

**Mode select for Toshiba Home AC Control application.**

Provide for 5 operation modes



**Setting in operation mode.**

**Tab for select AC**

**Weekly schedule**

**Mode select**

**OFF-ON Timer set**

**Temperature set**

**Indoor temperature**

**Outdoor temperature**

**Fan Speed**

**Fan speed set**

**Function**

**ECO** **HI POWER** **PURE** **8°C** **FLOOR**

**OFF-ON timer set 0.5-12hrs.**

**Off Timer**  
Please Select hour

- 0.5
- 1.0
- 1.5
- 2.0
- 2.5
- 3.0
- ? h

**On Timer**  
Please Select hour

- 0.5
- 1.0
- 1.5
- 2.0
- 2.5
- 3.0
- ? h

**ON timer set from Off mode only**

**Room name**

**off**

**26°C**

**25**

**Indoor temperature is 27°C**

**Outdoor temperature is 32°C**

**Fan Speed** **AUTO** **Swing**

**Louver set**

**Special feature**

### Group operation.

Maximum 3 groups

1 Group maximum = 10 units.

### Add group

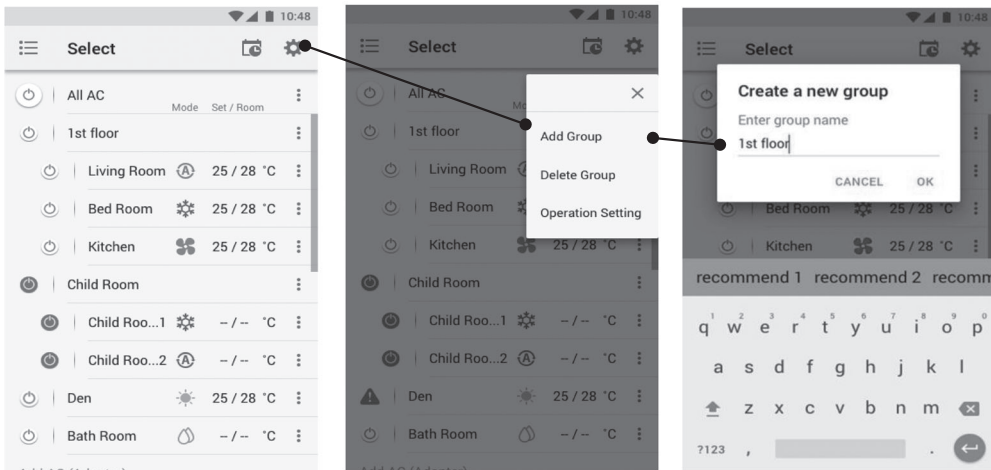

### Add AC in group

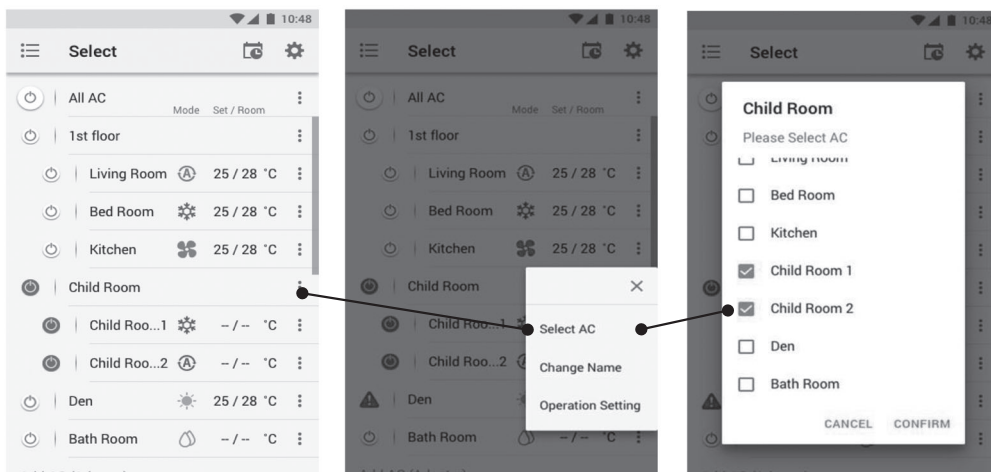

### Delete AC in group

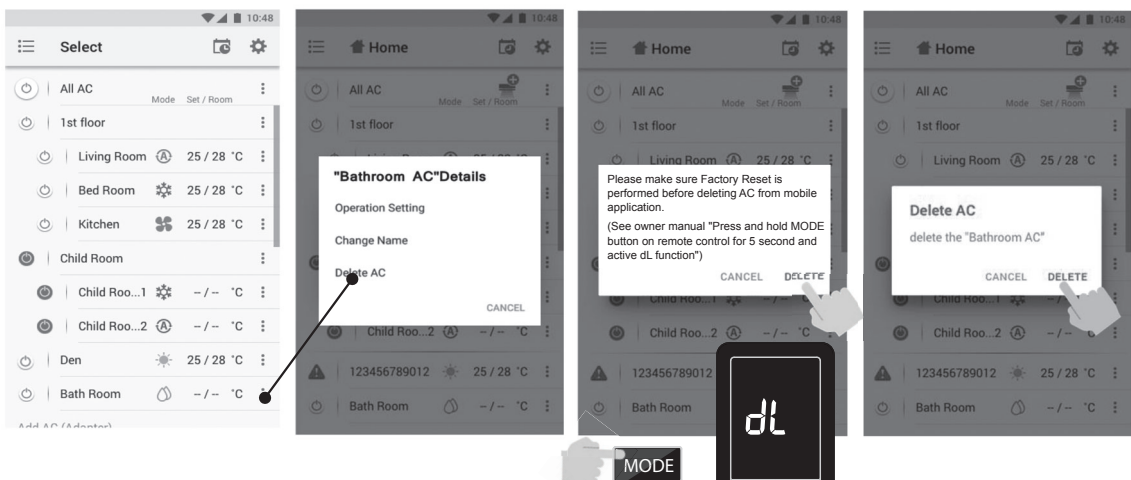



**Weekly schedule set.**

Day select Monday - Sunday

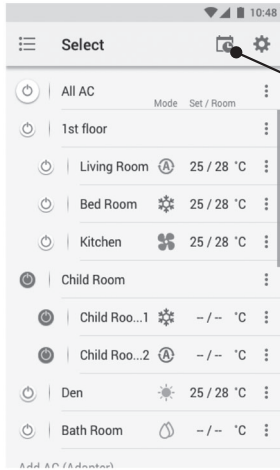

Weekly schedule of all AC unit

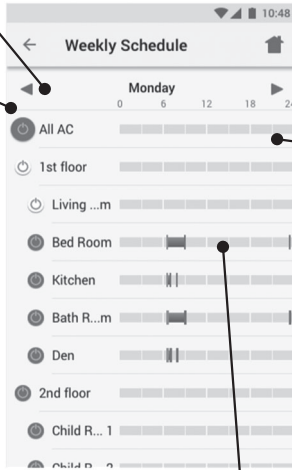

Weekly schedule of all AC unit

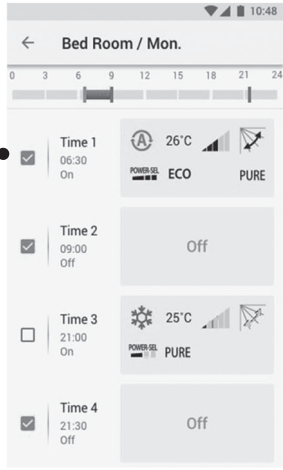

Time select



Weekly schedule set for each unit

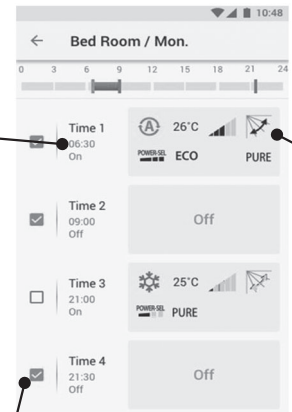

Mode select



Select program for active by tick at select box

**Weekly schedule cancel.**

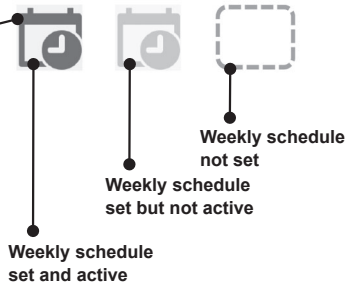
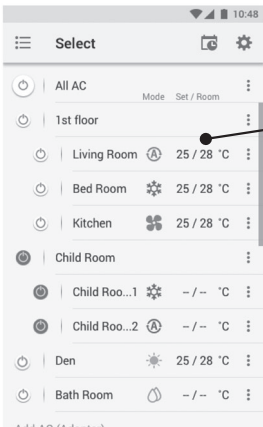

# Energy monitoring

## Select Room for Energy monitoring

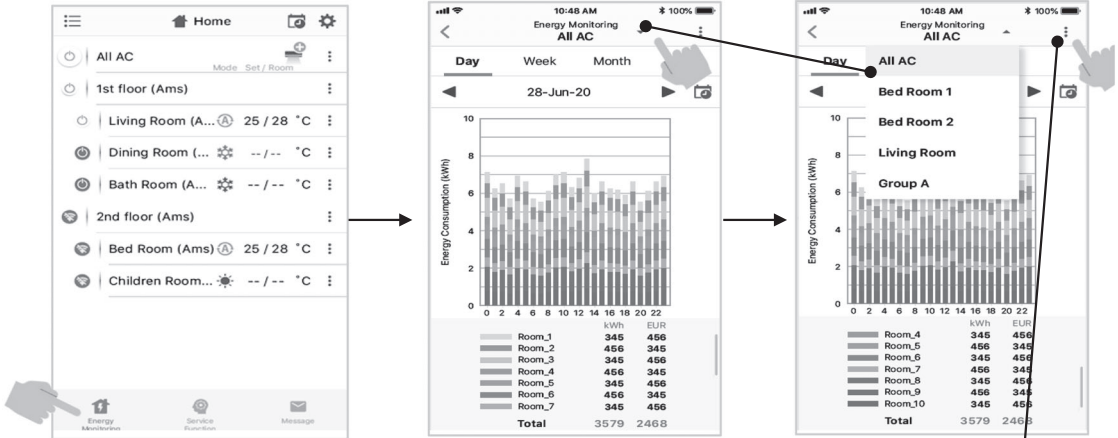

- ① Select Energy monitoring
- ② Energy monitoring display

## Set cost calculate and currency

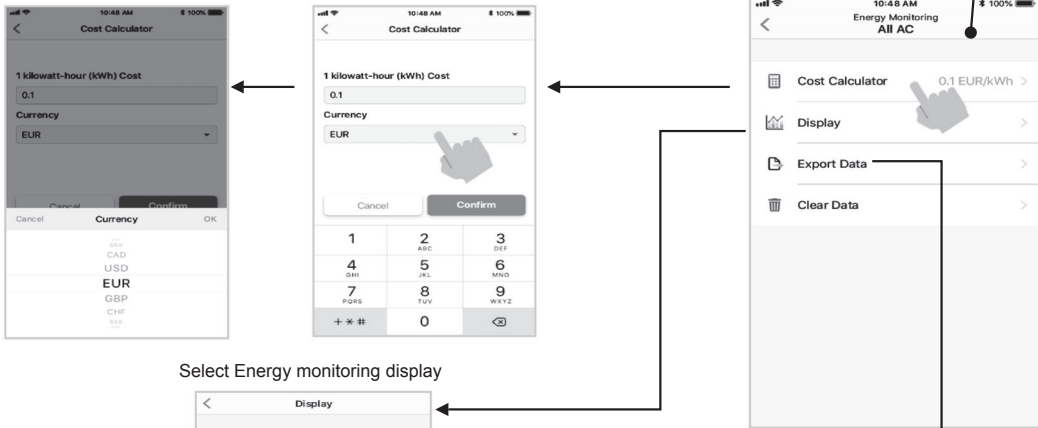

## Select Energy monitoring display



## Export data and send by Email

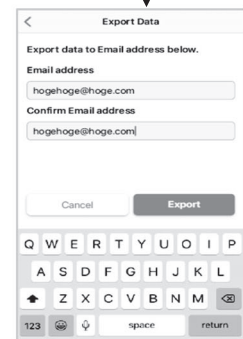

- The power consumption displayed is just an estimate as it is calculated simply. It may sometimes differ from the result measured by the power meter.

In case of have some problem can check from Help menu.

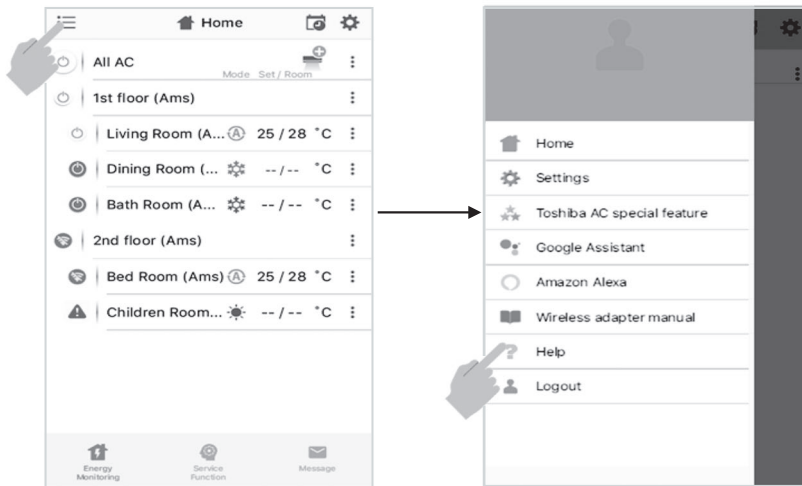

**Note :**

- The Wireless Adapter must be installed, maintained, repaired and removed by a qualified installer or qualified service person.
- Contact dealer and/or service center when equipment is malfunction.

## 20 DECORATIVE FABRIC INSTALLATION

The decorative fabric for cover on the air inlet grille of indoor unit was put in the accessories. User can use it as required.

The method of installation is as follows.

1. Remove the air inlet grille.  
Open the air inlet grille upward and pull it toward you.  
As shown on figure as below.

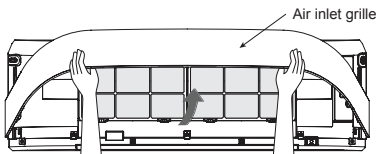

2. Prepare the fabric that you choose for install.
3. Insert the fabric into the left and right side of the air inlet grille.  
Attach the hook and loop of velcro tape fully together.  
As shown on figure as below.

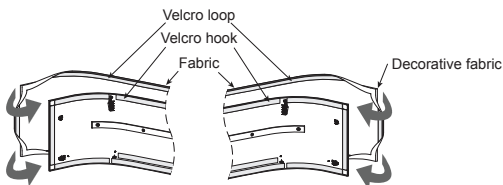

4. Insert the fabric into the top and bottom side of the air inlet grille.  
Attach the hook and loop of velcro tape fully together.  
As shown on figure as below.

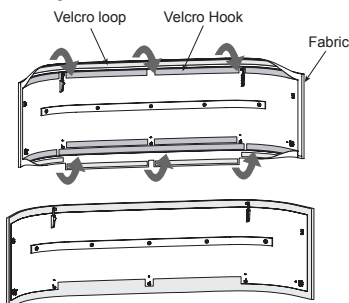

5. Reassembly the air inlet grille by reverse process of 1.

**Note:**

- The tightness of the fabric depends on attaching the hook and loop of velcro around the air inlet grille, take appropriate action.

**Maintenance & Shelf-life**

- Clean when dust stuck or covers the decorative fabric.
- Take extra care when cleaning the decorative fabric.
- Vacuum the decorative fabric with soft brush nozzle that use for cleaning on furniture or curtain.

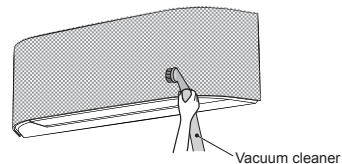

- In case of getting heavy dirty on decorative fabric, please use dry cleaning service or wash by hand with warm water separated from other clothes (to avoid color staining), then line dry in the shade.

**Note:**

- Switch "OFF" and unplug the air conditioner before removing the air inlet grille and decorative fabric.
- Ensure decorative fabric are completely dry before refitting to the air inlet grille.
- Do not put the decorative fabric in a dishwasher, washing machine, tumble dryer, oven, microwave or near an open flame.

**CAUTION**

- If clean decorative fabric by washing, it may affect to appearance and fitting of the decorative fabric.
- Recommend to use vacuum cleaner to removing the dusts from decorative fabric.

**TOSHIBA**