

# TOSHIBA

**R410A & R134a**

For commercial use

*HOT WATER MODULE (MULTI TYPE)*

## Installation Manual

### Indoor Unit

Model name: \_\_\_\_\_

High temperature Hot Water Module

**MMW-AP0481CHQ-E**

**Original instruction**

Please read this Installation Manual carefully before installing the hot water module.

- This Manual describes the installation method of the hot water module.
- For installation of the outdoor unit, follow the Installation Manual attached to the outdoor unit.

**ADOPTION OF R410A & R134a REFRIGERANT**

This Hot Water Module uses R410A & R134a an environmentally friendly refrigerant.

This equipment complies with IEC 61000-3-11 provided that the system impedance is less than or equal to  $Z_{max}$ . And with IEC61000-3-12 provided that the short-circuit power  $S_{sc}$  is greater than or equal to  $S_{sc}$  at the interface point between the user's supply and public system. It is the responsibility of the installer or user of the equipment to ensure, by consultation with the distribution network operator if necessary, that the equipment is connected only to a supply with a short-circuit power  $S_{sc}$  greater than or equal to  $S_{sc}$ .

Model	$S_{sc}$ (kW)
MMW-AP0481CHQ-E	900

## Contents

<b>1</b>	<b>Precautions for safety</b>	<b>3</b>
<b>2</b>	<b>Accessory parts</b>	<b>6</b>
<b>3</b>	<b>System control of Hot Water Module</b>	<b>7</b>
<b>4</b>	<b>Selection of installation place</b>	<b>12</b>
<b>5</b>	<b>Installation</b>	<b>13</b>
<b>6</b>	<b>Water piping</b>	<b>15</b>
<b>7</b>	<b>Drain piping</b>	<b>18</b>
<b>8</b>	<b>Refrigerant piping</b>	<b>19</b>
<b>9</b>	<b>Electrical connection</b>	<b>20</b>
<b>10</b>	<b>Applicable controls</b>	<b>27</b>
<b>11</b>	<b>Test run</b>	<b>29</b>
<b>12</b>	<b>Maintenance</b>	<b>31</b>
<b>13</b>	<b>Troubleshooting</b>	<b>31</b>
<b>14</b>	<b>Specifications</b>	<b>34</b>

Thank you for purchasing this Toshiba Hot Water Module.

Please read carefully through these instructions that contain important information, and ensure that you understand them.

After completing the installation work, hand over this Installation Manual and Owner's Manual as well as the Owner's Manual provided with the outdoor unit to the user, and ask the user to keep them in a safe place for future reference.

#### Generic Denomination: Hot Water Module

#### Definition of Qualified Installer or Qualified Service Person

The hot water module must be installed, maintained, repaired and removed by a qualified installer or qualified service person. When any of these jobs is to be done, ask a qualified installer or qualified service person to do them for you.

A qualified installer or qualified service person is an agent who has the qualifications and knowledge described in the table below.

Agent	Qualifications and knowledge which the agent must have
Qualified installer	<ul style="list-style-type: none"> <li>The qualified installer is a person who installs, maintains, relocates and removes the air conditioners (including the hot water modules) made by Toshiba Carrier Corporation. He or she has been trained to install, maintain, relocate and remove the air conditioners (including the hot water modules) made by Toshiba Carrier Corporation or, alternatively, he or she has been instructed in such operations by an individual or individuals who have been trained and is thus thoroughly acquainted with the knowledge related to these operations.</li> <li>The qualified installer who is allowed to do the electrical work involved in installation, relocation and removal has the qualifications pertaining to this electrical work as stipulated by the local laws and regulations, and he or she is a person who has been trained in matters relating to electrical work on the air conditioners (including the hot water modules) made by Toshiba Carrier Corporation or, alternatively, he or she has been instructed in such matters by an individual or individuals who have been trained and is thus thoroughly acquainted with the knowledge related to this work.</li> <li>The qualified installer who is allowed to do the refrigerant handling and piping work involved in installation, relocation and removal has the qualifications pertaining to this refrigerant handling and piping work as stipulated by the local laws and regulations, and he or she is a person who has been trained in matters relating to refrigerant handling and piping work on the air conditioners (including the hot water modules) made by Toshiba Carrier Corporation or, alternatively, he or she has been instructed in such matters by an individual or individuals who have been trained and is thus thoroughly acquainted with the knowledge related to this work.</li> <li>The qualified installer who is allowed to work at heights has been trained in matters relating to working at heights with the air conditioners (including the hot water modules) made by Toshiba Carrier Corporation or, alternatively, he or she has been instructed in such matters by an individual or individuals who have been trained and is thus thoroughly acquainted with the knowledge related to this work.</li> </ul>
Qualified service person	<ul style="list-style-type: none"> <li>The qualified service person is a person who installs, repairs, maintains, relocates and removes the air conditioners (including the hot water modules) made by Toshiba Carrier Corporation. He or she has been trained to install, repair, maintain, relocate and remove the air conditioners (including the hot water modules) made by Toshiba Carrier Corporation or, alternatively, he or she has been instructed in such operations by an individual or individuals who have been trained and is thus thoroughly acquainted with the knowledge related to these operations.</li> <li>The qualified service person who is allowed to do the electrical work involved in installation, repair, relocation and removal has the qualifications pertaining to this electrical work as stipulated by the local laws and regulations, and he or she is a person who has been trained in matters relating to electrical work on the air conditioners (including the hot water modules) made by Toshiba Carrier Corporation or, alternatively, he or she has been instructed in such matters by an individual or individuals who have been trained and is thus thoroughly acquainted with the knowledge related to this work.</li> <li>The qualified service person who is allowed to do the refrigerant handling and piping work involved in installation, repair, relocation and removal has the qualifications pertaining to this refrigerant handling and piping work as stipulated by the local laws and regulations, and he or she is a person who has been trained in matters relating to refrigerant handling and piping work on the air conditioners (including the hot water modules) made by Toshiba Carrier Corporation or, alternatively, he or she has been instructed in such matters by an individual or individuals who have been trained and is thus thoroughly acquainted with the knowledge related to this work.</li> <li>The qualified service person who is allowed to work at heights has been trained in matters relating to working at heights with the air conditioners (including the hot water modules) made by Toshiba Carrier Corporation or, alternatively, he or she has been instructed in such matters by an individual or individuals who have been trained and is thus thoroughly acquainted with the knowledge related to this work.</li> </ul>

#### Definition of Protective Gear



When the hot water module is to be transported, installed, maintained, repaired or removed, wear protective gloves and 'safety' work clothing.

In addition to such normal protective gear, wear the protective gear described below when undertaking the special work detailed in the table below.

Failure to wear the proper protective gear is dangerous because you will be more susceptible to injury, burns, electric shocks and other injuries.

Work undertaken	Protective gear worn
All types of work	Protective gloves 'Safety' working clothing
Electrical-related work	Gloves to provide protection for electricians Insulating shoes Clothing to provide protection from electric shock
Work done at heights (50 cm or more)	Helmets for use in industry
Transportation of heavy objects	Shoes with additional protective toe cap
Repair of outdoor unit	Gloves to provide protection for electricians

#### Warning indications on the hot water module

Warning indication	Description
 <p><b>WARNING</b> ELECTRICAL SHOCK HAZARD Disconnect all remote electric power supplies before servicing.</p>	<p><b>WARNING</b> ELECTRICAL SHOCK HAZARD Disconnect all remote electric power supplies before servicing.</p>
 <p><b>CAUTION</b> High temperature parts. You might get burned when removing this panel.</p>	<p><b>CAUTION</b> High temperature parts. You might get burned when removing this panel.</p>

#### CAUTION

- This is the part for transportation. Be sure to remove this part before operating the unit.
- To avoid water leak, wrap some sealing tape around the screw part.
- Do not operate VRF system before the commissioning of this product is fully completed. Failure to do so will result in water freezing and bursting/failure of the plate heat exchanger.

Set the DIP switch 4 of SW09 on the P.C. board of the header outdoor unit "ON". (Factory default is "OFF")  
VRF system will be stopped to avoid water freezing when the power supply is disconnected.

# 1 Precautions for safety

The manufacturer shall not assume any liability for the damage caused by not observing the description of this manual.

## WARNING

### General

- Before starting to install the hot water module, read through the Installation Manual carefully, and follow its instructions to install the hot water module.
- Only a qualified installer or service person is allowed to do installation work. Inappropriate installation may result in water leakage, electric shock or fire.
- Do not use any refrigerant different from the one specified for complement or replacement. Otherwise, abnormally high pressure may be generated in the refrigeration cycle, which may result in a failure or explosion of the product or an injury to your body.
- Before opening the front panel of the hot water module or service panel of the outdoor unit, set the circuit breaker to the OFF position. Failure to set the circuit breaker to the OFF position may result in electric shocks through contact with the interior parts. Only a qualified installer (\*1) or qualified service person (\*1) is allowed to remove the front panel of the hot water module or service panel of the outdoor unit and do the work required.
- Before carrying out the installation, maintenance, repair or removal work, set the circuit breaker to the OFF position. Otherwise, electric shocks may result.
- Place a “Work in progress” sign near the circuit breaker while the installation, maintenance, repair or removal work is being carried out. There is a danger of electric shocks if the circuit breaker is set to ON by mistake.
- Only a qualified installer (\*1) or qualified service person (\*1) is allowed to undertake work at heights using a stand of 50 cm or more or to remove the front panel of the hot water module to undertake work.
- Wear protective gloves and safety work clothing during installation, servicing and removal.

- Do not touch the plate heat exchanger of the unit. You may injure yourself if you do so. If the plate heat exchanger must be touched for some reason, first put on protective gloves and safety work clothing, and then proceed.
- Do not climb onto or place objects on top of the outdoor unit. You may fall or the objects may fall off of the outdoor unit and result in injury.
- When work is performed at heights, use a ladder which complies with the ISO 14122 standard, and follow the procedure in the ladder’s instructions. Also wear a helmet for use in industry as protective gear to undertake the work.
- Before other parts of the outdoor unit, set the circuit breaker to OFF without fail, and place a “Work in progress” sign near the circuit breaker before proceeding with the work.
- Before working at heights, put a sign in place so that no one will approach the work location, before proceeding with the work. Parts and other objects may fall from above, possibly injuring a person below. While carrying out the work, wear a helmet for protection from falling objects.
- The refrigerant used by this hot water module is the R410A.
- The hot water module must be transported in stable condition. If any part of the product is broken, contact the dealer.
- When the hot water module must be transported by hand, carry it by four or more people.
- Do not move or repair any unit by yourself. There is high voltage inside the unit. You may get electric shock when removing the cover and main unit.
- This appliance is intended to be used by expert or trained users in shops, in light industry, or for commercial use by lay persons.

### Selection of installation location

- When the hot water module is installed in a small room, provide appropriate measures to ensure that the concentration of refrigerant leakage occur in the room does not exceed the critical level.
- Do not install in a location where flammable gas leaks are possible. If the gas leak and accumulate around the unit, it may ignite and cause a fire.
- To transport the hot water module, wear shoes with additional protective toe caps.
- To transport the hot water module, do not take hold of the bands around the packing carton. You may injure yourself if the bands should break.

- 
- The hot water module has been designed to be fitted at floor level.

### **Installation**

- Install the hot water module securely in a location where the base can sustain the weight adequately. If the strength is not enough, the unit may fall down resulting in injury.
- Follow the instructions in the Installation Manual to install the hot water module. Failure to follow these instructions may cause the product to fall down or topple over or give rise to noise, vibration, water leakage or other trouble.
- Carry out the specified installation work to guard against the possibility of earthquake. If the hot water module is not installed appropriately, a unit may topple over or fall down, causing an accident.
- If refrigerant gas has leaked during the installation work, ventilate the room immediately. If the leaked refrigerant gas comes in contact with fire, noxious gas may generate.
- Use forklift to carry in the hot water module units and use winch or hoist at installation of them.
- Helmet must be worn to protect your head from falling objects. Especially, when you work under an inspection opening, helmet must be worn to protect your head from falling objects from the opening.
- The unit can be accessed from the service panel.

### **Refrigerant piping**

- Install the refrigerant pipe securely during the installation work before operating the hot water module. If the compressor is operated with the valve open and without refrigerant pipe, the compressor sucks air and the refrigeration cycles is over pressurized, which may cause a injury.
- Tighten the flare nut with a torque wrench in the specified manner. Excessive tighten of the flare nut may cause a crack in the flare nut after a long period, which may result in refrigerant leakage.
- After the installation work, confirm that refrigerant gas does not leak. If refrigerant gas leaks into the room and flows near a fire source, such as a cooking range, noxious gas may be generated.
- When the hot water module has been installed or relocated, follow the instructions in the Installation Manual and purge the air completely so that no gases other than the refrigerant will be mixed in the refrigerating cycle. Failure to purge the air completely may cause the hot water module to malfunction.

- 
- Nitrogen gas must be used for the airtight test.
  - The charge hose must be connected in such a way that it is not slack.

### **Water piping**

- Do not install water pipes in a location that is susceptible to freezing.

### **Electrical wiring**

- Only a qualified installer (\*1) or qualified service person (\*1) is allowed to carry out the electrical work of the hot water module. Under no circumstances must this work be done by an unqualified individual since failure to carry out the work properly may result in electric shocks and / or electrical leaks.
- To connect the electrical wires, repair the electrical parts or undertake other electrical jobs, wear gloves to provide protection for electricians and from heat, insulating shoes and clothing to provide protection from electric shocks. Failure to wear this protective gear may result in electric shocks.
- Use wiring that meets the specifications in the Installation Manual and the stipulations in the local regulations and laws. Use of wiring which does not meet the specifications may give rise to electric shocks, electrical leakage, smoking and / or a fire.
- Connect earth wire. (Grounding work)  
Incomplete grounding causes an electric shock.
- Do not connect earth wires to gas pipes, water pipes, and lightning conductor or telephone earth wires.
- After completing the repair or relocation work, check that the earth wires are connected properly.
- Install a circuit breaker that meets the specifications in the installation manual and the stipulations in the local regulations and laws.
- Install the circuit breaker where it can be easily accessed by the agent.
- When installing the circuit breaker outdoors, install one which is designed to be used outdoors.
- Under no circumstances the power wire must not be extended. Connection trouble in the places where the wire is extended may give rise to smoking and / or a fire.
- Electrical wiring work shall be conducted according to law and regulation in the community and installation manual. Failure to do so may result in electrocution or short circuit.

### Test run

- Before operating the hot water module after having completed the work, check that the electrical parts box cover (the front panel) of the hot water module and service panel of the outdoor unit are closed, and set the circuit breaker to the ON position. You may receive an electric shock if the power is turned on without first conducting these checks.
- If there is any kind of trouble (such as a check code display has appeared, smell of burning, abnormal sounds, the hot water module fails to heat or water is leaking) has occurred in the hot water module, do not touch the hot water module yourself but set the circuit breaker to the OFF position, and contact a qualified service person. Take steps to ensure that the power will not be turned on (by marking "out of service" near the circuit breaker, for instance) until qualified service person arrives. Continuing to use the hot water module in the trouble status may cause mechanical problems to escalate or result in electric shocks or other trouble.
- After the work has finished, use an insulation tester set (500 V Megger) to check the resistance is 1 MΩ or more between the charge section and the non-charge metal section (Earth section). If the resistance value is low, a disaster such as a leak or electric shock is caused at user's side.
- Upon completion of the installation work, check for refrigerant leaks and check the insulation resistance and water drainage. Then conduct a test run to check that the hot water module is operating properly.

### Explanations given to user

- Upon completion of the installation work, tell the user where the circuit breaker is located. If the user does not know where the circuit breaker is, he or she will not be able to turn it off in the event that trouble has occurred in the hot water module.
- If the fan grille is damaged, do not approach the outdoor unit but set the circuit breaker to the OFF position, and contact a qualified service person (\*1) to have the repairs done. Do not set the circuit breaker to the ON position until the repairs are completed.

### Relocation

- Only a qualified installer (\*1) or qualified service person (\*1) is allowed to relocate the hot water module. It is dangerous for the hot water module to be relocated by an unqualified individual since a fire, electric shocks, injury, water leakage, noise and / or vibration may result.
- When carrying out the pump-down work shut down the compressor before disconnecting the refrigerant pipe. Disconnecting the refrigerant pipe with the service valve left open and the compressor still operating will cause air or other gas to be sucked in, raising the pressure inside the refrigeration cycle to an abnormally high level, and possibly resulting in rupture, injury or other trouble.

---

### CAUTION

#### **R410A refrigerant hot water module Installation**

- **THIS HOT WATER MODULE ADOPTS THE HFC REFRIGERANT (R410A) WHICH DOES NOT DESTROY OZONE LAYER.**
- The characteristics of R410A refrigerant are; easy to absorb water, oxidizing membrane or oil, and its pressure is approx. 1.6 times higher than that of refrigerant R22. Accompanied with the R410A refrigerant, refrigerating oil has also been changed. Therefore, do not let water, dust, former refrigerant, or refrigerating oil enter the refrigerating cycle during installation work.
- To prevent charging an incorrect refrigerant and refrigerating oil, the sizes of connecting sections of charging port of the main unit and installation tools are changed from those for the conventional refrigerant.
- Accordingly the exclusive tools are required for the R410A refrigerant.
- For connecting pipes, use new and clean piping designed for R410A, and please care so that water or dust does not enter.







#### **To Disconnect the Appliance from Main Power Supply.**

- This appliance must be connected to the main power supply by means of a switch with a contact separation of at least 3 mm.

---

(\*1) Refer to the "Definition of Qualified Installer or Qualified Service Person."

## 2 Accessory parts

Part name	Qty	Shape	Usage
Installation Manual	1	This manual	(Hand over to customers) (For other languages that do not appear in this Installation Manual, please refer to the enclosed CD-R.)
Owner's Manual	1	—	(Hand over to customers) (For other languages that do not appear in the Owner's Manual, please refer to the enclosed CD-R.)
CD-ROM	1	—	Installation Manual, Owner's Manual
Heat insulator	1		For heat insulation of Gas pipe connecting section
	1		For heat insulation of Liquid pipe connecting section
Drain nipple	1		
Connector with wire	1		For external connecting to CN703 (I/F P.C. Board)
Clamp filter (large)	1		For external connecting to CN703 (I/F P.C. Board) or CN61 (Control P.C. Board)
Clamp filter (small)	2		
Binding band	3		For fixing clamp filter

# 3 System control of Hot Water Module

## ■ System able to be combined

The High temperature Hot water module (H-HWM) is connectable to SHRM-e.

In case of connecting at least one Hot water module in SHRM-e system, all of Flow Selector unit type should be Single port type Flow Selector unit (long piping model) or Multi port type Flow Selector unit.

Model name of usable Flow Selector unit: RBM-Y1124FE, RBM-Y1804FE, RBM-Y2804FE, RBM-Y1801F6PE, RBM-Y1801F4PE

The Fresh Air intake type and Air to Air Heat Exchanger with DX Coil cannot be connected with the same refrigerant system.

M-HWM: Mid temperature Hot water module

H-HWM: High temperature Hot water module

HWM: Mid temperature Hot water module and High temperature Hot water module

No.	Item			SHRM-e	
1	Indoor connection capacity(*1)	Total	Standard indoor unit + M-HWM + H-HWM	90 - 200% (*2) (*3)	
			Standard indoor unit + M-HWM	90 - 135% (*2) (*3)	
		Allowed capacity	Standard indoor unit	50 - 120% (*2)	
			M-HWM	0 - 67.5% (*2) (*3)	
			H-HWM	0 - 100% (*2) (*3)	
M-HWM + H-HWM	0 - 100% (*2) (*3)				
2	Maximum indoor unit quantity	Total	Standard indoor unit + M-HWM + H-HWM	32	
			Standard indoor unit + M-HWM	32	
		Allowed number	Standard indoor unit	2 - 32	
			M-HWM	0 - 14	
			H-HWM	0 - 12	
M-HWM + H-HWM	0 - 14				
3	Height difference	Height difference between outdoor and indoor units <b>H1</b> (*4) (Including HWM)	H2 > 3 m	Upper outdoor units	50 m
				Lower outdoor units	30 m
			H2 ≤ 3 m	Upper outdoor units	70 m
				Lower outdoor units	30 m
		Height difference between indoor units (Including HWM) <b>H2, H4, H5</b> (*4)	Indoor - Indoor H2	Upper outdoor units	40 m
				Lower outdoor units	15 m (*6)
			HWM - HWM H4	Upper outdoor units	40 m
				Lower outdoor units	15 m (*6)
			Indoor - HWM H5	Upper outdoor units	40 m
				Lower outdoor units	15 m (*6)
Height between outdoor units <b>H3</b>			5 m		
Height difference between indoor units in group control by one Flow Selector unit <b>H6</b>			0.5 m		



- (\*1): Ratio of connected total indoor unit capability to outdoor unit capability  
 (\*2): Maximum indoor connection capacity is varied depending on the height difference between indoor unit H2, H4, H5.

Combination of indoor units		SHRM-e
Standard indoor unit + M-HWM + H-HWM	H2, H4, H5 ≤ 15 m	Max. 200% (Standard indoor unit < 120%)
	15 m < H2, H4, H5	Max. 125% (Standard indoor unit < 100%)
Standard indoor unit + M-HWM	H2, H4, H5 ≤ 15 m	Max. 135% (Standard indoor unit < 120%)
	15 m < H2, H4, H5	Max. 125% (Standard indoor unit < 100%)

- (\*3): HWM connecting capacity should be smaller than standard indoor unit.  
 (\*4): As for 44HP to 54HP of SHRM-e, contact our agent.  
 (\*5): When M-HWM and standard indoor units are not operated simultaneously, it is possible up to 40 m.  
 (\*6): When system capacity is greater than 28HP, height difference between indoor units is limited to 3 m.  
 If the height difference between indoor units exceeds 3 m with a capacity greater than 28HP there may be a case of capacity shortage in cooling.

**NOTE**

Design the system that total capacity of simultaneous heating operation is 100% or less. If total capacity of simultaneous heating is over 100%, then each indoor units or HWM performance is descended.

▼ Figure 1

HWM: Mid temperature Hot water module and High temperature Hot water module

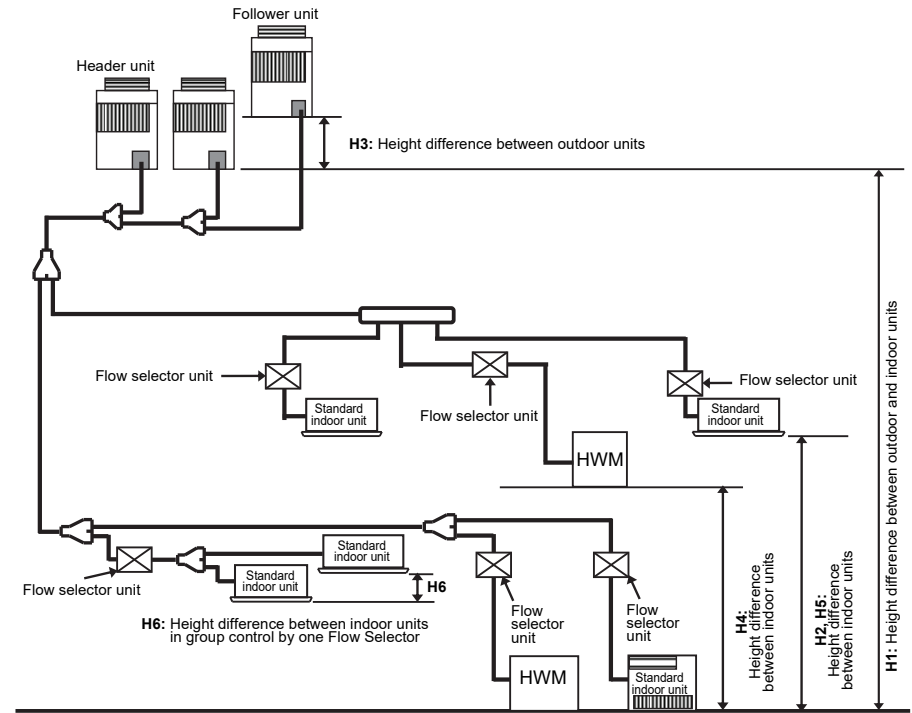

- H1: Height difference between outdoor units and indoor units (Including HWM)  
 H2: Height difference between standard indoor units  
 H3: Height difference between outdoor units  
 H4: Height difference between HWMs  
 H5: Height difference between standard indoor units and HWMs

**NOTE**

It is prohibited to connect the standard indoor unit and the HWM to the same Flow Selector unit in SHRM-e system.

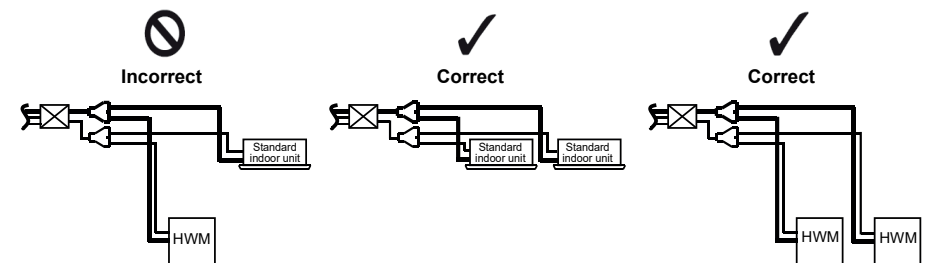

### In the case of SHRM-e system including the Hot water module

M-HWM: Mid temperature Hot water module  
H-HWM: High temperature Hot water module

SHRM-e	Capacity code of outdoor unit (HP)	Maximum indoor unit quantity	Total capacity code of indoor units (HP) Standard indoor unit + M-HWM + H-HWM		Total capacity code of indoor units (HP) Standard indoor unit + M-HWM	
			H2, H4, H5 ≤ 15m	15m < H2, H4, H5	H2, H4, H5 ≤ 15m	15m < H2, H4, H5
			Total capacity 90 - 200% (Standard indoor unit < 120%)	Total capacity 90 - 125% (Standard indoor unit < 100%)	Total capacity 90 - 135% (Standard indoor unit < 120%)	Total capacity 90 - 125% (Standard indoor unit < 100%)
MMY-MAP0806FT8P	8	18	7.2 to 16.0	7.2 to 10.0	7.2 to 10.8	7.2 to 10.0
MMY-MAP1006FT8P	10	22	9.0 to 20.0	9.0 to 12.5	9.0 to 13.5	9.0 to 12.5
MMY-MAP1206FT8P	12	27	10.8 to 24.0	10.8 to 15.0	10.8 to 16.2	10.8 to 15.0
MMY-MAP1406FT8P	14	31	12.6 to 28.0	12.6 to 17.5	12.6 to 18.9	12.6 to 17.5
MMY-MAP1606FT8P	16	32	14.4 to 32.0	14.4 to 20.0	14.4 to 21.6	14.4 to 20.0
MMY-MAP1806FT8P	18	32	16.2 to 36.0	16.2 to 22.5	16.2 to 24.3	16.2 to 22.5
MMY-MAP2006FT8P	20	32	18.0 to 37.0 (*1)	18.0 to 25.0	18.0 to 25.0 (*2)	18.0 to 25.0
MMY-MAP2206FT8P	22	32	19.8 to 44.0	19.8 to 27.5	19.8 to 29.7	19.8 to 27.5
MMY-MAP2416FT8P	24	32	21.6 to 48.0	21.6 to 30.0	21.6 to 32.4	21.6 to 30.0
MMY-MAP2616FT8P	26	32	23.4 to 52.0	23.4 to 32.5	23.4 to 35.1	23.4 to 32.5
MMY-MAP2816FT8P	28	32	25.2 to 56.0	25.2 to 35.0	25.2 to 37.8	25.2 to 35.0
MMY-MAP3016FT8P	30	32	27.0 to 60.0	27.0 to 37.5	27.0 to 40.5	27.0 to 37.5
MMY-MAP3216FT8P	32	32	28.8 to 64.0	28.8 to 40.0	28.8 to 43.2	28.8 to 40.0
MMY-MAP3416FT8P	34	32	30.6 to 68.0	30.6 to 42.5	30.6 to 45.9	30.6 to 42.5
MMY-MAP3616FT8P	36	32	32.4 to 72.0	32.4 to 45.0	32.4 to 48.6	32.4 to 45.0
MMY-MAP3816FT8P	38	32	34.2 to 72.2 (*1)	34.2 to 47.5	34.2 to 49.4 (*2)	34.2 to 47.5
MMY-MAP4016FT8P	40	32	36.0 to 74.0 (*1)	36.0 to 50.0	36.0 to 50.0 (*2)	36.0 to 50.0
MMY-MAP4216FT8P	42	32	37.8 to 84.0	37.8 to 52.5	37.8 to 56.7	37.8 to 52.5
MMY-MAP4416FT8P	44	32	39.6 to 88.0	39.6 to 55.0	39.6 to 59.4	39.6 to 55.0
MMY-MAP4616FT8P	46	32	41.4 to 92.0	41.4 to 57.5	41.4 to 62.1	41.4 to 57.5
MMY-MAP4816FT8P	48	32	43.2 to 96.0	43.2 to 60.0	43.2 to 64.8	43.2 to 60.0
MMY-MAP5016FT8P	50	32	45.0 to 100	45.0 to 62.5	45.0 to 67.5	45.0 to 62.5
MMY-MAP5216FT8P	52	32	46.8 to 104	46.8 to 65.0	46.8 to 70.2	46.8 to 65.0
MMY-MAP5416FT8P	54	32	48.6 to 108	48.6 to 67.5	48.6 to 72.9	48.6 to 67.5

H2, H4, H5: Height difference between indoor unit (Including HWM)

(\*1) 20HP and 40HP: 90-185%, 38HP: 90-190%

(\*2) 20HP and 40HP: 90-125%, 38HP: 90-130%

#### ▼ Capacity code of Hot water module

The capacity code of the Hot water module is different from the capacity code of the standard indoor unit.

Hot water module			Mid temperature		High temperature
			MMW-AP0271LQ-E	MMW-AP0561LQ-E	MMW-AP0481CHQ-E
Capacity rank type			027	056	048
Capacity code	Equivalent to HP (HP)		2.5	5	4.5
Equivalent to capacity (kW)			7.1	14.0	12.5

#### ▼ Capacity code of standard indoor unit

Capacity rank type		005	007	009	012	015	018	024	027	030	036	048	056	072	096
Capacity code	Equivalent to HP (HP)	0.6	0.8	1	1.25	1.7	2	2.5	3	3.2	4	5	6	8	10
Equivalent to capacity (kW)		1.7	2.2	2.8	3.6	4.5	5.6	7.1	8.0	9.0	11.2	14.0	16.0	22.4	28.0

## ■ Example of Installation for Hot Water Module water piping

### GENERAL NOTE

- To install the hot water module, connect the pump (procured locally).
- Do not connect more than one hot water module to one pump.
- Be sure to install one pump to one hot water module as shown in the following examples.
- Be sure to attach the air vent valve (procured locally) vertically at the highest possible place where air tends to rise.

HWM: Hot Water Module

### Sample 1.

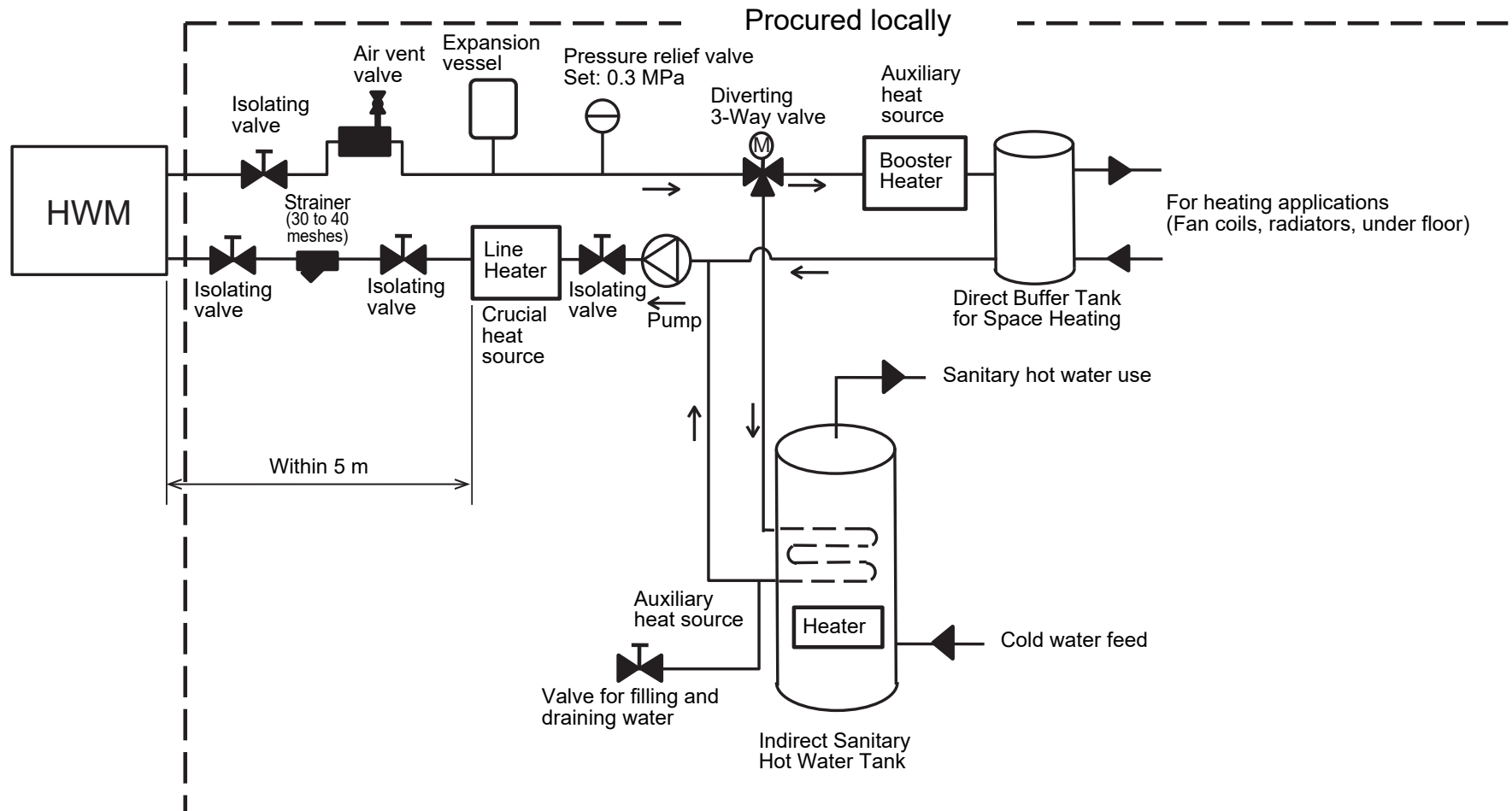

HWM: Hot Water Module

Sample 2.

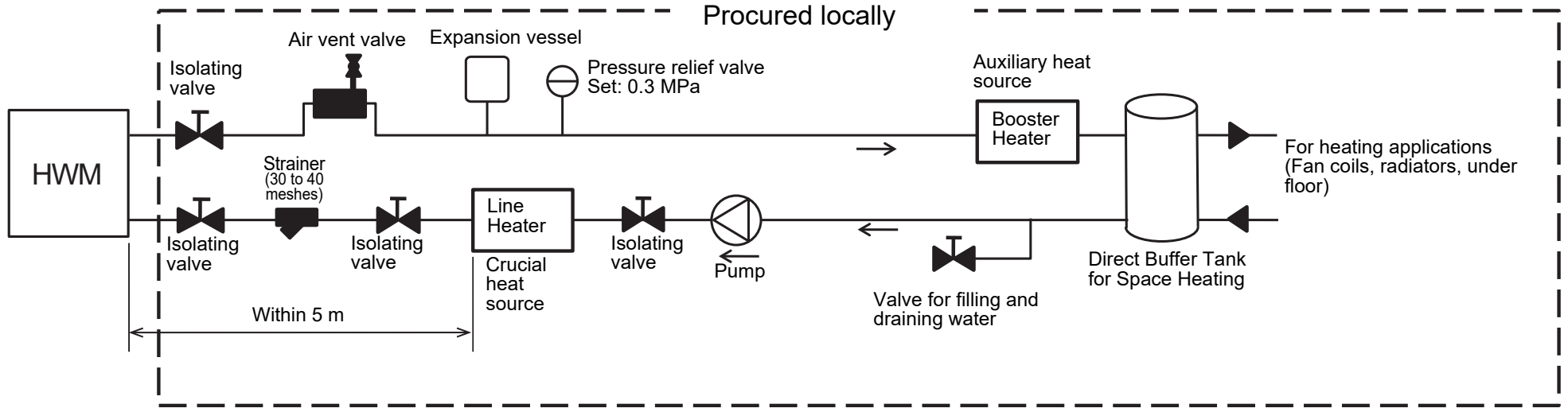

HWM: Hot Water Module

Sample 3.

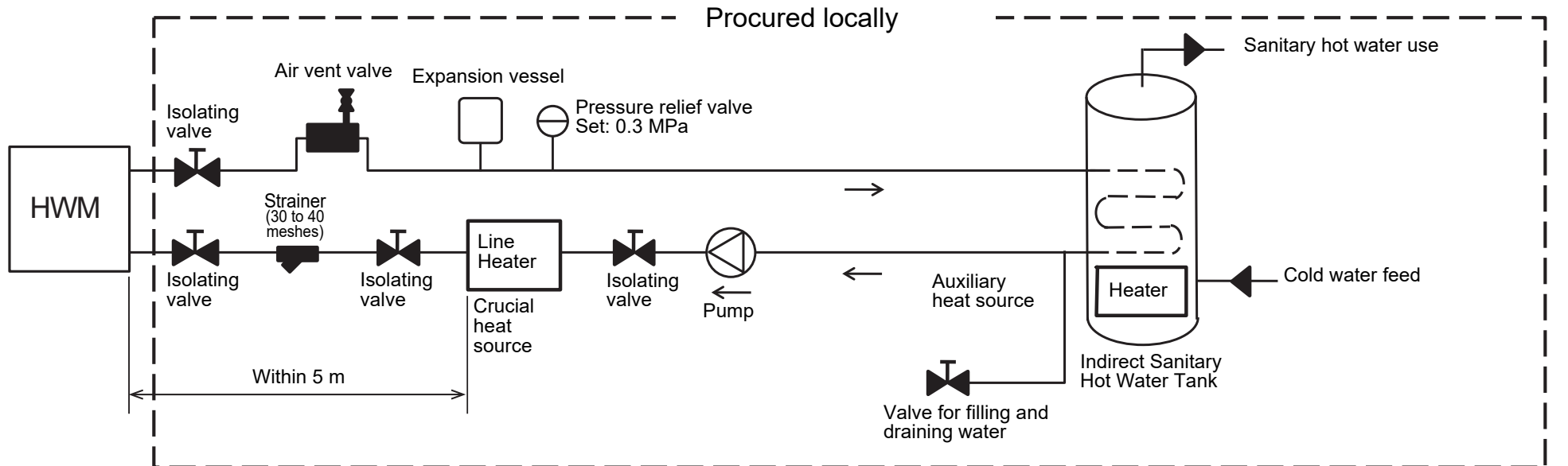

---

## 4 Selection of installation place

### Avoid installing in the following places

Select a location for the indoor unit where the cool or warm air will circulate evenly.

Avoid installation in the following kinds of locations.

- Saline area (coastal area)
- Locations with acidic or alkaline atmospheres (such as areas with hot springs, factories where chemicals or pharmaceuticals are made and places where the exhaust air from combustion appliances will be sucked into the unit).  
Doing so may cause the heat exchanger and other parts to become corroded.
- Locations with atmospheres with mist of cutting oil or other types of machine oil.  
Doing so may cause the heat exchanger to become corroded, mists caused by the blockage of the heat exchanger to be generated, the plastic parts to be damaged, the heat insulators to peel off, and other such problems to result.
- Locations where vapors from food oils are formed (such as kitchens where food oils are used).  
The plastic parts to be damaged, and other such problems to result.
- Locations where an in-house power generator is used for the power supply.  
The power line frequency and voltage may fluctuate, and the hot water module may not work properly as a result.
- On truck cranes, ships or other moving conveyances.
- The hot water module must not be used for special applications (such as for storing food, plants, precision instruments or art works).  
(The quality of the items stored may be degraded.)
- Locations where high frequencies are generated (by inverter equipment, in-house power generators, medical equipment or communication equipment).  
(Malfunctioning or control trouble in the hot water module or noise may adversely affect the equipment's operation.)
- Locations where there is anything under the unit installed that would be compromised by wetness.  
(If the drain has become blocked or when the humidity is over 85%, condensation from the hot water module will drip, possibly causing damage to anything underneath.)
- In the case of the wireless type of system, rooms with the inverter type of fluorescent lighting or locations exposed to direct sunlight.  
(The signals from the wireless remote controller may not be sensed.)
- Locations where organic solvents are being used.
- The hot water module cannot be used for liquefied carbonic acid cooling or in chemical plants.
- Location near doors or windows where the hot water module may come into contact with high-temperature, high-humidity outdoor air.  
(Condensation may occur as a result.)
- Locations where special sprays are used frequently.
- Places where iron or other metal dust is present. If iron or other metal dust adheres to or collects on the interior of the hot water module, it may spontaneously combust and start a fire.
- Locations such as living rooms and bedrooms where you can easily be bothered by noise. Noise may become a problem.

---

### CAUTION

- Do not install hot water module in a place where water freezes.
  - Do not install the hot water module in a place where combustible gas may leak.
  - Do not install the hot water module in a place exposed to rain or water.
  - Do not install the hot water module near equipment which generates heat.
  - Do not install the hot water module to a movable object.
  - Do not install the hot water module in a place exposed to vibration.
  - The hot water module must be installed in accordance with national wiring regulation.
  - The hot water module must not be installed in a high humidity condition area.
  - The hot water module must not be installed in a high dusty area.
-

## ■ Installation atmosphere

Installation atmosphere of the unit is as follows. Be careful of installation atmosphere. It becomes a cause of failure of a product by dewing or freezing.

Installation atmosphere	Dry-bulb temp. (°C)	5 to 32
	Wet-bulb temp. (°C)	24 (Max.)
	RH (%)	30 to 85
	Allowable dew point (°C Wet-bulb temp)	23 or less

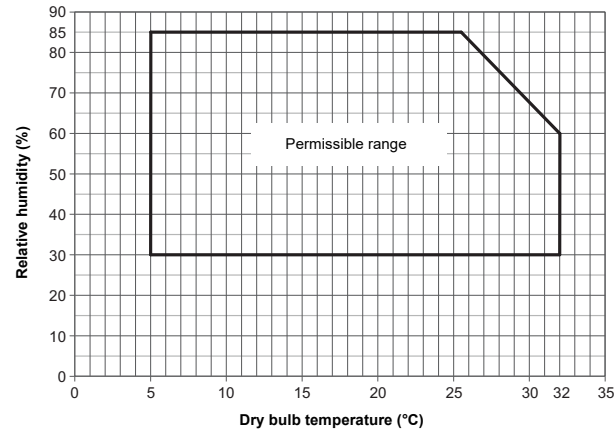

## ■ Installation space

(Unit: mm)

Reserve sufficient space required for installation or service work.

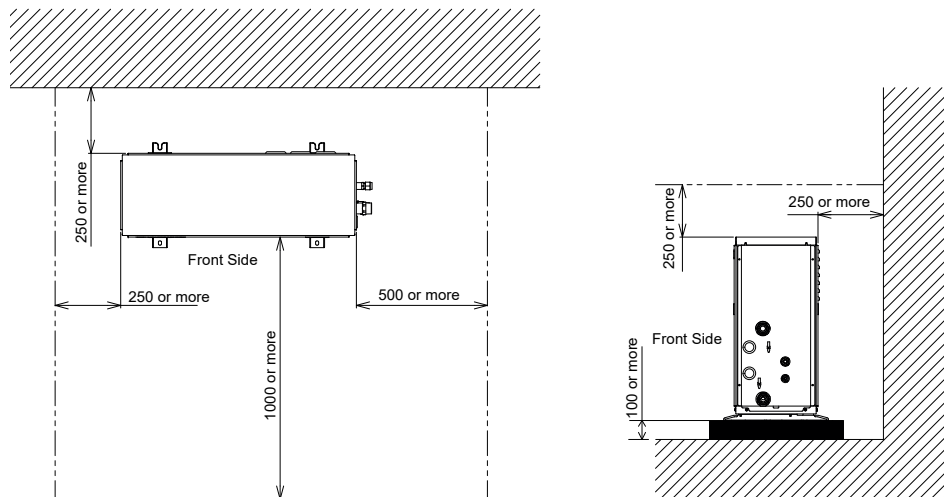

# 5 Installation

## ⚠ CAUTION

Strictly comply with the following rules to prevent damage of the hot water modules and human injury.

- Do not put a heavy article on the hot water module or let a person get on it. (Even units are packaged)
- Carry in the hot water module as it is packaged if possible. If carrying in the hot water module unpacked by necessity, use buffering cloth or other material to not damage the unit.
- To move the hot water module, hold the bottom face of the unit only. Do not apply force to the other parts (refrigerant pipe, drain pan, water pipe, foamed parts, resin parts or other parts).
- Carry the package by two or more persons, and do not bundle it with plastic band at positions other than specified.
- To protect yourself from injury, always use PPE (Personal Protective Equipment), that is, wear gloves.
- Install the Hot water module in a place strong enough to withstand the following weights:  
Hot water module weight with no water 100 kg  
Hot water module weight with full water 102 kg

## External dimensions

(Unit: mm)

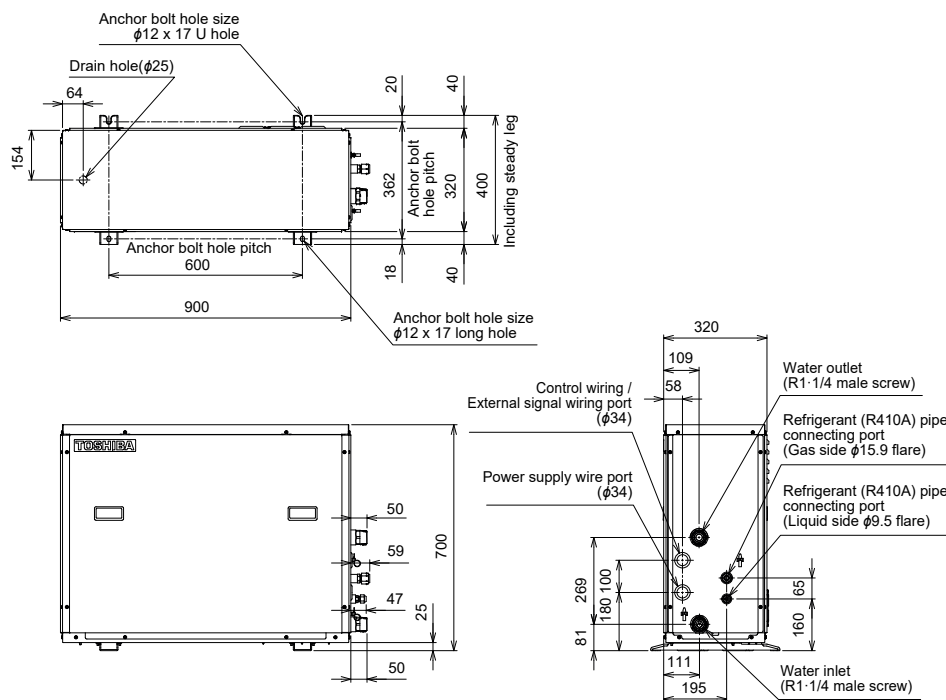

## Fixing the hot water module to floor

1. Fix the hot water module with M10 anchor bolts at 4 positions. 15 mm projection is appropriate for an anchor bolt.

(Unit: mm)



### WARNING

- **Be sure to install the hot water module in a place able to bear its weight.** If strength is insufficient, the unit may fall down resulting in human injury.
- **Perform specified installation work to protect earthquakes.** If the hot water module is imperfectly installed, an accident by falling or dropping may be caused.

### CAUTION

- Drain water is discharged from the hot water module. (Especially while operating) Install the hot water module in a place with good drainage.
- For installation, be careful of the strength and level of the foundation so that abnormal sounds (vibration or noise) are not generated.
- Be sure to install the hot water module in a place strong enough to withstand its weight. If the base is unstable, reinforce with a concrete base.
- The hot water module must be anchored on a level surface. Use a level to check after installation.
- If the hot water module is installed near a room where noise is a problem, using an anti-vibration stand on the base of the unit is recommended.

**REQUIREMENT**

- Fix the unit in a horizontal position.  
When unit is fixed to slant, it may cause overflow of drainage.
- Install the unit within the dimension according to the figure below.
- Use level gauge or vinyl hose to confirm whether the unit is fix horizontally.

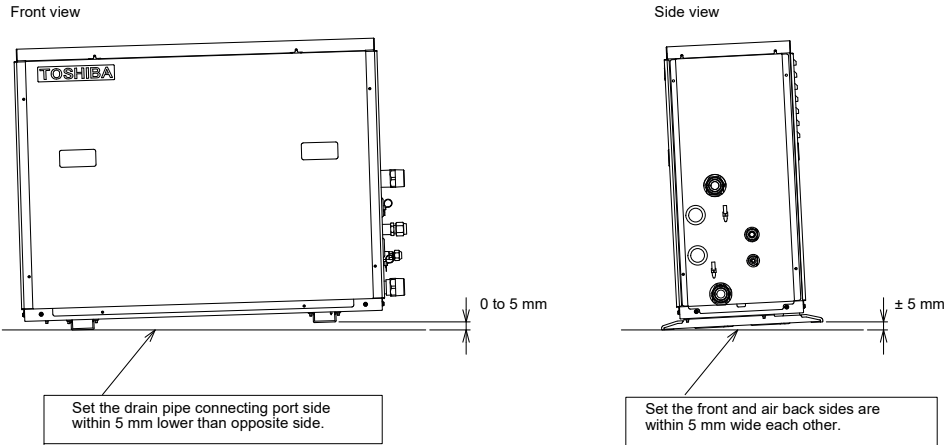

## 6 Water piping

**WARNING**

- Install water pipes according to the regulations of respective countries.
- Install water pipes in the freeze-free place.
- Make sure that water pipes have sufficient pressure resistance. The design pressure is 1.0 MPa.

**CAUTION**

- Do not use zinc plated water pipes. When steel pipes are used, insulate both ends of the pipes.
- Copper pipes are recommended.
- The water to be used must meet the water quality standard specified in EN directive 98/83 EC.
- **After the vacuuming is completed, carry out the following procedure before adding refrigerant.**  
Plate heat exchanger may explode because the water in the plate heat exchanger frozen.  
To avoid this phenomenon, ensure that the VRF system is fully commissioned, including the control system, before filling the water circuit.
- The hot water module and the buffer/cylinder tank must be installed on the same floor height.
- The water piping on the inlet side of the hot water module must not be connected with right-angled loop piping (refer to the figure below).
- When flow switch detects a decrease in the water flow rate, the outdoor unit stops.

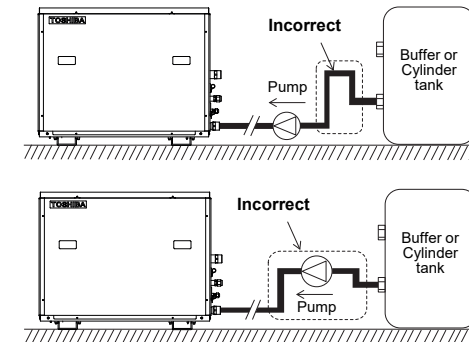



## ■ Water piping and line heater installation

- Install a suitably sized expansion vessel, 3 bar (0.3 MPa) pressure relief valve, water drain, and fill valve (procured locally).  
Follow all local regulations for the installation of closed circuit heating systems.
- Make the piping route a closed circuit. (An open water circuit may cause a failure.)
- Before a long period of none use, purge the water out of the pipes and thoroughly let them dry. Do not add brine to the circulating water.
- Do not use the water used for the unit for drinking or food manufacturing.
- To insure easy maintenance, inspection, and replacement of the unit, use a proper joint, valve, etc (procured locally) on the water inlet and outlet port.
- Be sure to install a strainer with 30 to 40 meshes (procured locally) on the water inlet pipe. If a strainer is not installed, this may cause impaired performance, or damage to the plate heat exchanger from freezing.
- Install a suitable air vent (procured locally) on the water pipe. After sending water through the pipe, be sure to vent the excess air.
- Be sure to attach the air vent valve vertically at the highest possible place where air tends to rise.
- To avoid water leak, wrap some sealing tape around the screw part.
- Water pipes can get very hot, depending on the preset temperature. Wrap the water pipes with heat insulation (procured locally) to prevent burns.
- In case of installing the line heater (procured locally) on the water inlet side. In addition, position it within 5 m of the water inlet pipe of the hot water module.
- Follow the table below to select a line heater (procured locally) within the range of 40 to 50 % of the hot water module's rated capacity.

Hot water module model name	Capacity of line heater (kW)
MMW-AP0481CHQ-E	5.8 ~ 7.2

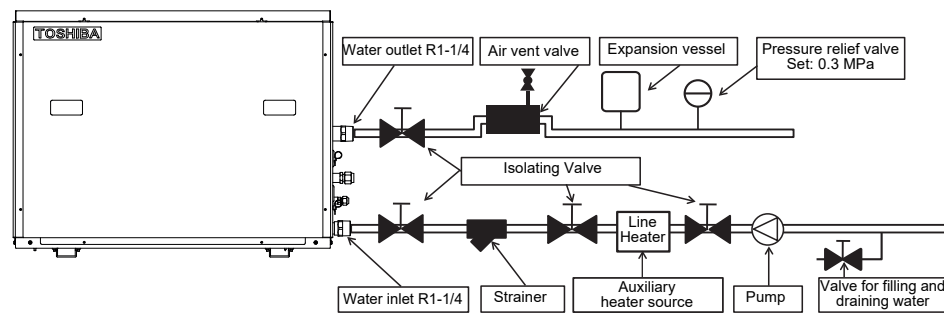

## ■ Pipe size, material and insulator

The following specification for piping work and insulating process are procured locally.

Model	MMW-	AP048	
Connecting pipe (unit side)	Water pipe	Inlet	R1-1/4
		Outlet	R1-1/4
Connecting pipes material		Copper pipes are recommended	
Insulator		Formed polyethylene foam, thickness: 10 mm or more	

### ⚠ CAUTION

Since the water pipe becomes high temperature (about 90°C), wrap around the pipe with heat insulation (procured locally).

### ■ Characteristics of hot water module flow rate and pressure loss

The following graph shows the range of flow rates used for the hot water module, and the characteristic pressure losses. Use this as an aid in the local pump procurement process.

048type	Min.	Rated	Max.
Water flow rate (L/min)	34	40	46
Pressure loss (kPa)	12	15	18.5

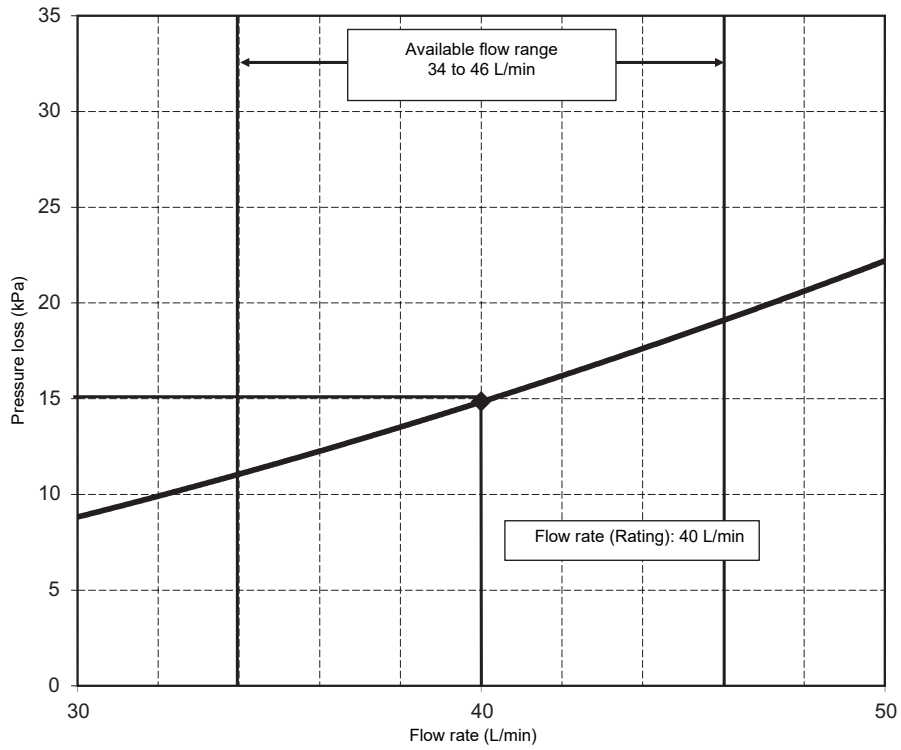

# 7 Drain piping

## ⚠ CAUTION

- Following the Installation Manual, perform the drain piping work so that water is properly drained. Apply a heat insulation so as not to cause a dew condensation. Inappropriate piping work may result in water leakage in the room and wet furniture.

### Drain piping

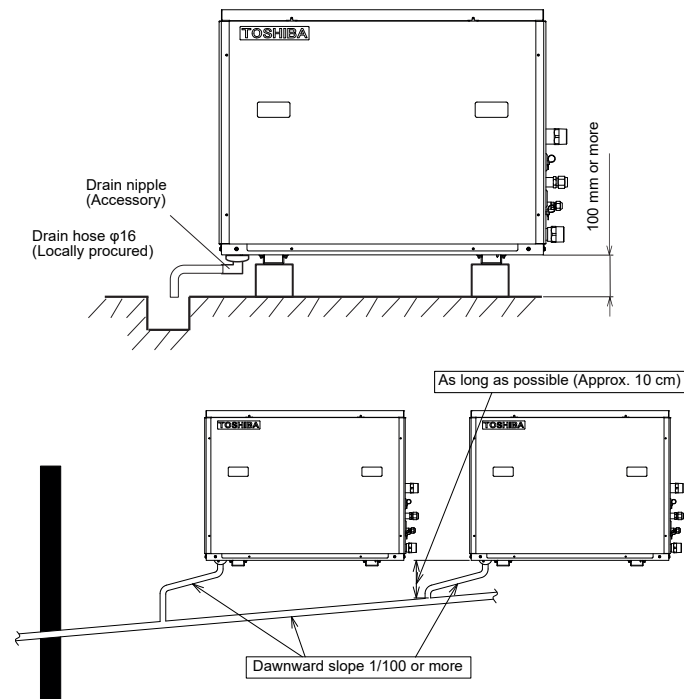

- Connect the drain hose (locally procured) size inner diameter  $\phi 16$  to the drain nipple (accessory).
- Provide the indoor drain piping with proper heat insulation.
- Provide the area where the pipe connects to the indoor unit with proper heat insulation. Improper heat insulation will cause condensation to form.
- The drain pipe must be sloping downward (at an angle of 1/100 or more), and do not run the pipe up and down (arched shape) or allow it to form traps. Doing so may cause abnormal sounds.
- Install the collective piping as shown in the following figure.
- Do not provide any air vents. Otherwise, the drain water will spout, causing water to leak.
- Do not allow any force to be applied to the connection area with the drain pipe.

## ■ Check the draining

In the test run, check that water drain is properly performed and water does not leak from the connecting part of the pipes. Check draining also when installed in heating period.

- Check the water drainage is surely performed at the trial operation.
- Check also no water leakage is found at the pipe connecting part.

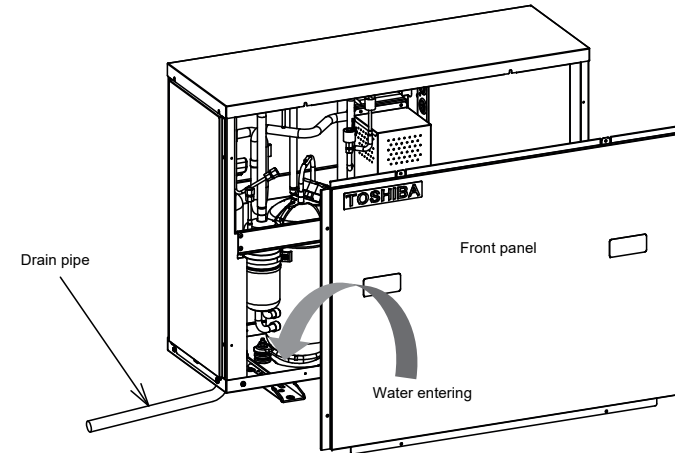

### REQUIREMENT

Enter water gradually using a kettle or a hose from drain pan of the discharge port.

## ⚠ CAUTION

### Pour water slowly.

If it is poured urgently, water is spread inside of the indoor unit resulted in a trouble.

# 8 Refrigerant piping

## ⚠ CAUTION

When the refrigerant pipe is long, provide support brackets at intervals of 2.5 m to 3 m to clamp the refrigerant pipe. Otherwise, abnormal sound may be generated.

Use the flare nut attached with the indoor unit or R410A flare nut.

## ■ Permissible piping length and height difference

They vary depending on the outdoor unit. For details, refer to the Installation Manual attached to the outdoor unit, and this manual (Refer to "3. System control of Hot Water Module").

## ■ Pipe size

Model MMW-	Pipe size (mm)	
	Gas side	Liquid side
AP048	Ø15.9	Ø9.5

## ■ Connecting refrigerant piping

### Flaring

**1 Cut the pipe with a pipe cutter.**  
Remove burrs completely. (Remaining burrs may cause gas leakage.)

**2 Insert a flare nut into the pipe, and flare the pipe.**

Use the flare nut provided with the unit or the one used for the R410A refrigerant. The flaring dimensions for R410A are different from the ones used for the conventional R22 refrigerant. A new flare tool manufactured for use with the R410A refrigerant is recommended, but the conventional tool can still be used if the projection margin of the copper pipe is adjusted to be as shown in the following table.

### Projection margin in flaring: B (Unit: mm)

Outer dia. of copper pipe	R410A tool used	Conventional tool used
6.4, 9.5	0 to 0.5	1.0 to 1.5
12.7, 15.9		

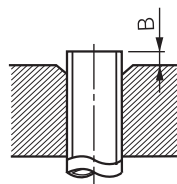

### Flaring diameter size: A (Unit: mm)

Outer dia. of copper pipe	A <sup>+0</sup> / <sub>-0.4</sub>
6.4	9.1
9.5	13.2
12.7	16.6
15.9	19.7

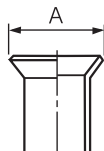

\* In case of flaring for R410A with the conventional flare tool, pull it out approx. 0.5 mm more than that for R22 to adjust to the specified flare size. The copper pipe gauge is useful for adjusting projection margin size.

- The sealed gas was sealed at the atmospheric pressure so when the flare nut is removed, there will no "whooshing" sound: This is normal and is not indicative of trouble.
- Use two wrenches to connect the indoor unit pipe.

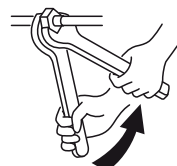

Work using double spanner

- Use the tightening torque levels as listed in the table below.

Outer dia. of connecting pipe (mm)	Tightening torque (N·m)
6.4	14 to 18 (1.4 to 1.8 kgf·m)
9.5	33 to 42 (3.3 to 4.2 kgf·m)
12.7	50 to 62 (5.0 to 6.2 kgf·m)
15.9	63 to 77 (6.3 to 7.7 kgf·m)

- Tightening torque of flare pipe connections. Pressure of R410A is higher than that of R22. (Approx. 1.6 times) Therefore, using a torque wrench, tighten the flare pipe connecting sections which connect the indoor and outdoor units of the specified tightening torque. Incorrect connections may cause not only a gas leak, but also a trouble of the refrigeration cycle.

## ⚠ CAUTION

Tightening with an excessive torque may crack the nut depending on installation conditions.

## ■ Airtight test / air purge, etc.

For air tightness test, adding refrigerant, refer to the Installation Manual attached to the outdoor unit.

## ⚠ CAUTION

- Do not supply power to the indoor unit and the hot water module until the airtight test and vacuuming are completed. (If the indoor unit or the hot water module is powered on, the pulse motor valve is fully closed, which extends the time for vacuuming.)

- After the vacuuming is completed, carry out the following procedure before adding refrigerant.**

Plate heat exchanger may explode because the water in the plate heat exchanger frozen.

To avoid this phenomenon, add refrigerant before carrying out a water supply to the water pipe system of the Hot Water Module.

## ■ Open the valve fully

Open the valve of the outdoor unit fully.

## ■ Heat insulation process

Apply heat insulation for the pipes separately at liquid side and gas side.

- For the heat insulation to the pipes at gas side, use the material with heat-resisting temperature 120 °C or higher.
- To use the attached heat insulation pipe, apply the heat insulation to the pipe connecting section of the hot water module securely without gap.

### REQUIREMENT

- Apply the heat insulation to the pipe connecting section of the hot water module securely up to the root without exposure of the pipe. (The pipe exposed to the outside causes water leak.)
- Wrap heat insulator with its slits facing up (ceiling side).

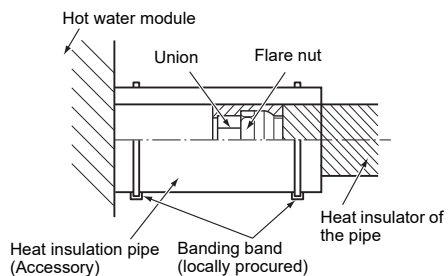

## ■ Installation of remote controller (Sold separately)

For installation of the wired remote controller, follow the Installation Manual attached with the remote controller.

- Pull out the remote controller cord together with the refrigerant pipe or drain pipe.  
Pass the remote controller cord through upper side of the refrigerant pipe and drain pipe.
- Do not leave the remote controller at a place exposed to the direct sunlight and near a stove.

# 9 Electrical connection

## ⚠ WARNING

- **Use the specified wires for wiring connect the terminals. Securely fix them to prevent external forces applied to the terminals from affecting the terminals.**  
Incomplete connection or fixation may cause a fire or other trouble.
- **Connect earth wire. (grounding work)**  
Incomplete grounding cause an electric shock.  
Do not connect earth wires to gas pipes, water pipes, lightning conductor or telephone earth wires.
- **Appliance shall be installed in accordance with national wiring regulations.**  
Capacity shortage of power circuit or incomplete installation may cause an electric shock or a fire.

## ⚠ CAUTION

- If incorrect / incomplete wiring is carried out, it will cause an electrical fire or smoke.
- Install an earth leakage breaker that is not tripped by shock waves.  
If an earth leakage breaker is not installed, an electric shock may be caused.
- Use the cord clamps attached to the product.
- Do not damage or scratch the conductive core and inner insulator of power and inter-connecting wires when peeling them.
- Use the power cord and Inter-connecting wire of specified thickness, type, and protective devices required.
- Do not connect 220 V – 240 V power to the terminal blocks (Ⓚ, Ⓛ, ⓐ, ⓑ) for control wiring and the terminal blocks (COM, S1, S2, S3, S4, S5) for output function. (Otherwise, the system will fail.)
- Do not damage or scratch the conductive core and inner insulator of power and inter-connecting wires when peeling them.
- Perform the electric wiring so that it does not come to contact with the high-temperature part of the pipe.  
The coating may melt resulting in an accident.

**REQUIREMENT**

- For power supply wiring, strictly conform to the Local Regulation in each country.
- For wiring of power supply of the outdoor units, follow the Installation Manual of each outdoor unit.
- Perform the electric wiring so that it does not come to contact with the high-temperature part of the pipe. The coating may melt resulting in an accident.
- After connecting wires to the terminal blocks, provide a trap and fix wires with the cord clamp.
- Run the refrigerant piping line and control wiring line in the same line.
- Do not turn on the power of the hot water module until vacuuming of the refrigerant pipes completes.

**Power supply wire and communication wires specifications**

Power supply wire and communication wires are procured locally.

For the power supply specifications, follow to the table below. If capacity is little, it is dangerous because overheat or burnout may be caused.

For specifications of the power capacity of the outdoor unit and the power supply wires, refer to the Installation Manual attached to the outdoor unit.

**Hot water module power supply**

- For the power supply of the hot water module, prepare the exclusive power supply separated from that of the outdoor unit and other indoor units.
- Arrange the power supply, circuit breaker, and main switch of the hot water module connected to the same outdoor unit so that they are commonly used.
- Power supply wire specification: Cable 3-core, **in conformity with 60245 IEC 57.**

**Power supply**

Power supply	220 V – 240 V ~, 50 Hz
Maximum running current	17.5 A
Recommended field fuse	25 A

**Control wiring, Central controller wiring**

- 2-core with non-polarity wires are used for the Control wiring between indoor unit (including hot water module) and outdoor unit and Central controller wiring.
- To prevent noise trouble, use 2-core shield wire.
- The length of the communication line means the total length of the inter-unit wire length between indoor (including hot water module) and outdoor units added with the central control system wire length.

**Communication line**

Control wiring between indoor units (including hot water module), and outdoor unit (2-core shield wire)	Wire size	(Up to 1000 m) 1.25 mm <sup>2</sup> (Up to 2000 m) 2.0 mm <sup>2</sup>
Central control line wiring (2-core shield wire)		

**Remote controller wiring**

- 2-core with non-polarity wire is used for wiring of the remote controller wiring and group remote controllers wiring.

Remote controller wiring, remote controller inter-unit wiring	Wire size: 0.5 mm <sup>2</sup> to 2.0 mm <sup>2</sup>
---	---

**Connecting to SHRM-e**

Total wire length between indoor unit and Flow selector unit (L2+L3)	Up to 200 m
Total wire length between remote controller and Flow selector unit (L1+L2+L3)	Up to 300 m
Maximum wire length of remote controller (L1)	Up to 300 m

**Output signal function wiring**

- To prevent noise trouble, use 2-core shield wire.

Output function wiring (2-core shield wire)	Wire size	(up to 2 m) 0.5 mm <sup>2</sup>
---	-----------	---------------------------------

**⚠ CAUTION**

The remote controller wire (Communication line) and AC 220 – 240 V wires cannot be parallel to contact each other and cannot be stored in the same conduits. If doing so, a trouble may be caused on the control system due to noise or other factor.

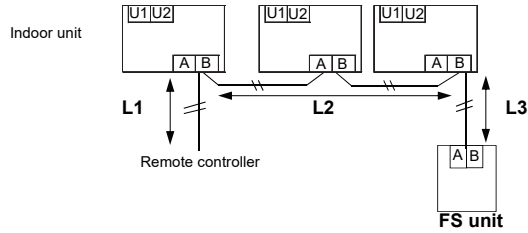

M-HWM: Mid temperature Hot Water Module  
H-HWM: High temperature Hot Water Module

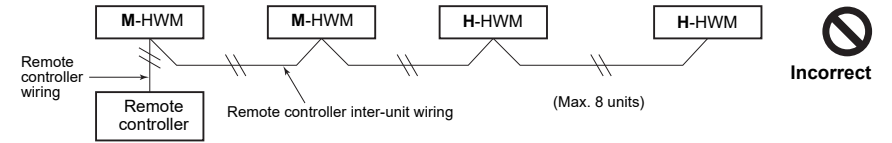
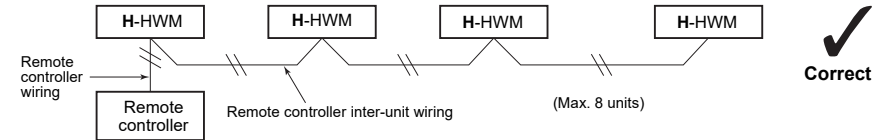
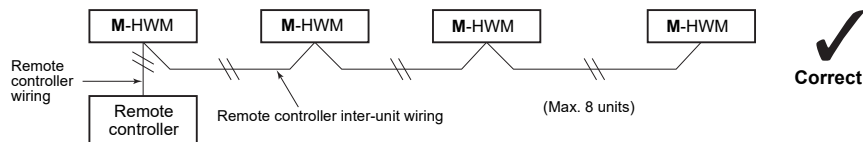
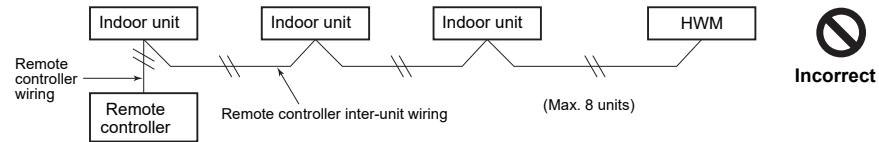
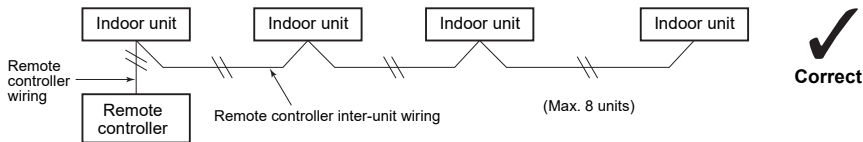

(\*): In the case of multiple refrigerant systems

**NOTE**

It is not possible to connect any Hot Water Modules and any indoor units together for group control.  
It is not possible to connect M-HWM and H-HWM together for group control.

## ■ Wiring between indoor (including hot water module) and outdoor units

### NOTE

- An outdoor unit connected with control wiring between indoor (including hot water module) and outdoor units wire becomes automatically the header unit.
- Do not turn off the circuit breaker of the hot water module when the circuit breaker of the system (outdoor unit) is set to the ON position.
- It becomes a cause of a trouble.

### ▼ Wiring example

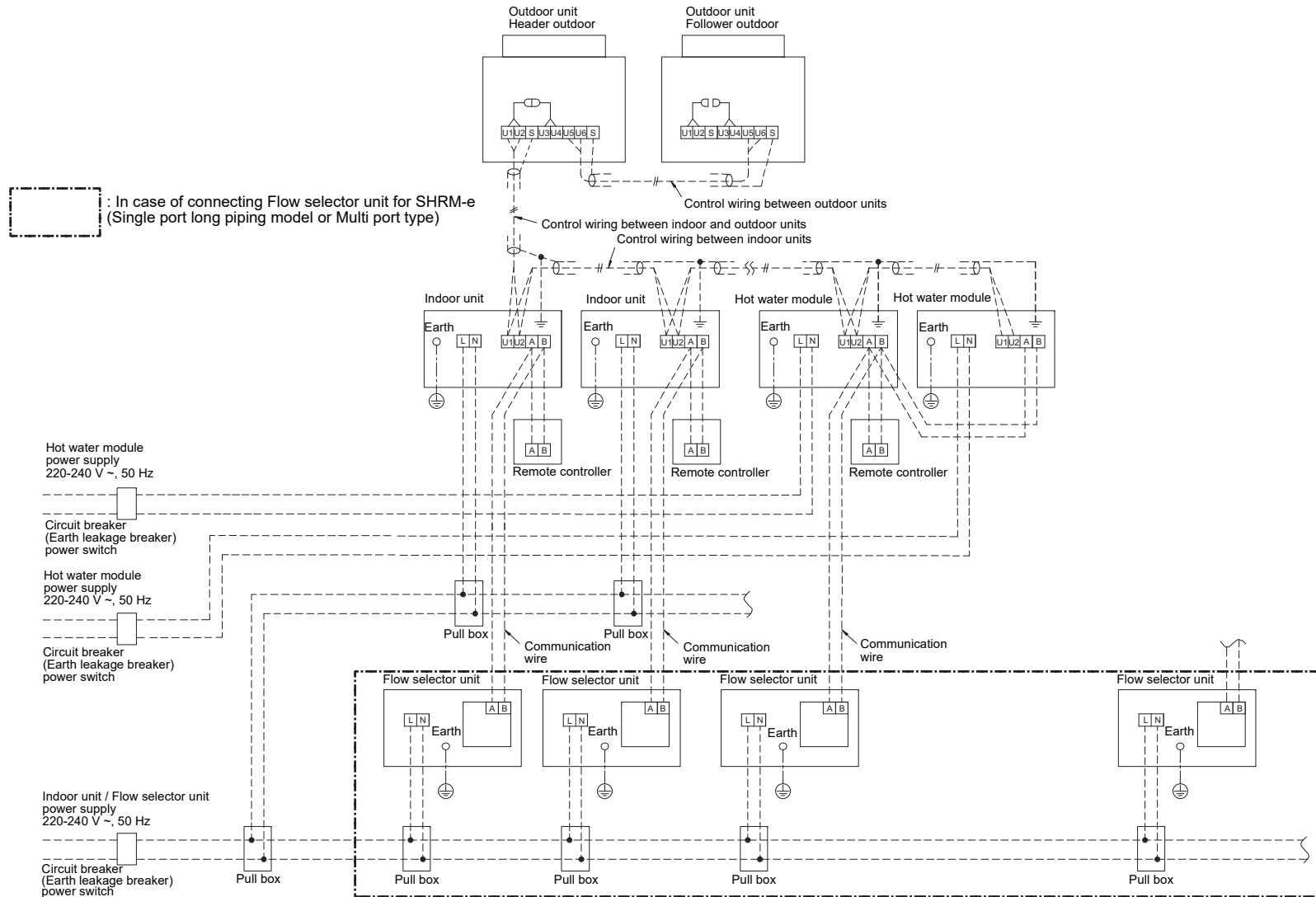



## ■ Wire connection

### REQUIREMENT

- Connect the wires matching the terminal numbers. Incorrect connection causes a trouble.
- Pass the wires through the bushing of wire connection holes of the hot water module.
- Keep a margin (Approx. 100 mm) on a wire to hang down the electrical control box at servicing or other purpose.
- The low-voltage circuit is provided for the remote controller. (Do not connect the high-voltage circuit)

- Remove the front panel of the hot water module by taking off the mounting screws (8 positions).
- Wrap a heat insulation (locally procured) around the power supply to fill the gap between cord and port cap.
- Wrap a heat insulation (locally procured) around the control wires and external signal wires to fill the gap between cord and port cap.
- Tighten the screws of the terminal block, and fix the wires with cord clamp attached to the electrical control box. (Do not apply tension to the connecting section of the terminal block.)
- Mount the front panel of the hot water module without pinching wires.

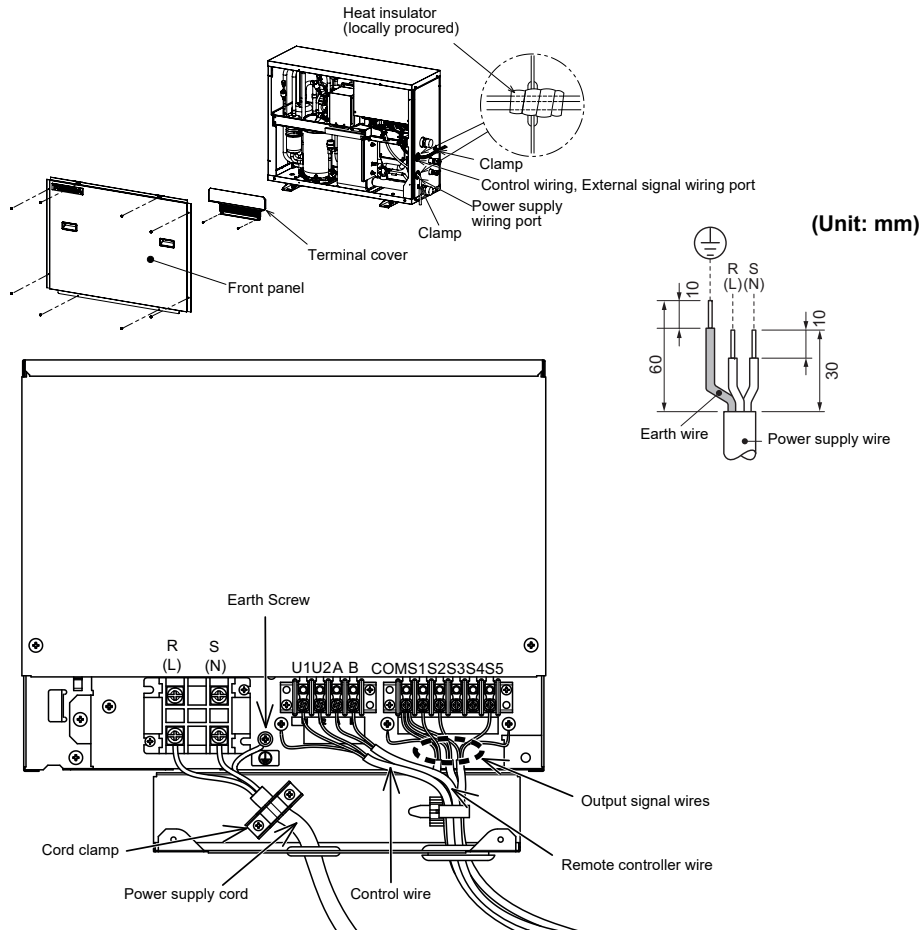

## ■ Wiring for Flow selector unit (FS unit) for SHRM-e

Connect communication wire of FS unit to terminal A, B (no polarity) of Hot Water Module, when the Hot Water Module connects to SHRM-e system.

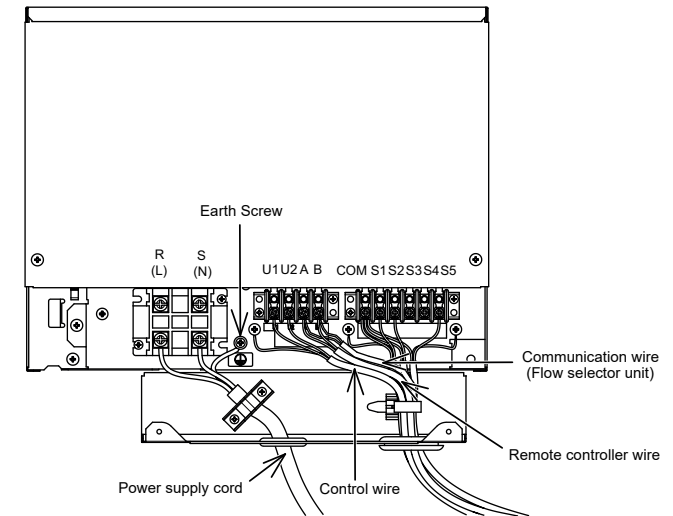

### NOTE

- In case of connecting at least one Hot Water Module in SHRM-e system, all of FS units in the system should be Single port type FS unit (long piping model) or Multiport type FS unit.

## ■ Remote controller wiring

- Strip off approx. 9 mm the wire to be connected.

### ▼ Wiring diagram

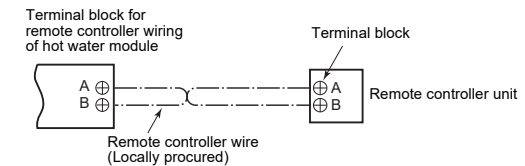

## ■ Output signal function wiring

Connect the following output signals from the hot water module.

Terminal block No.	Function	Comments
COM	DC12V (COM)	Common for connector S2 ~ S5
S1	Defrosting output (COM-S1)	DC12V Relay coil is less than 16mA.
S2	Line heater output (COM-S2)	DC12V Relay coil is less than 16mA.
S3	-	-
S4	Heating thermostat ON output (COM-S4)	DC12V Relay coil is less than 16mA.
S5	Pump output (COM-S5)	DC12V Relay coil is less than 16mA.

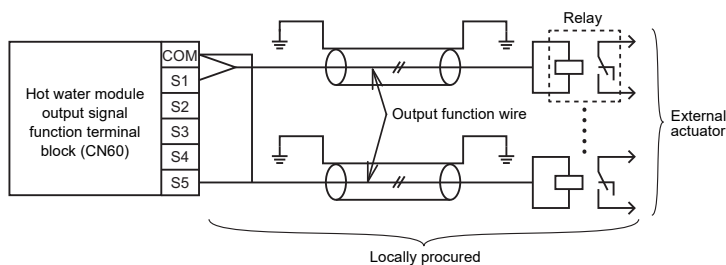

### NOTE

Auxiliary relays (locally procured) must be connected to output signal function wirings to allow connection to the hot water module output signal functions. The maximum current output signal, from each of the output signal function wirings, is 16 mA. Please ensure the rated current of the relay coil is less than 16 mA to avoid damage to the hot water module P.C. board.

### ▼ Output function wire

## ⚠ CAUTION

Output signal functions are separated from primary basic insulation.

- To prevent noise trouble, use 2-core shield wire.
- Determine the wire length between the hot water module output signal function terminal block and the relay up to 2 m.
- Locally procure and install protective devices such as the heater and pump.

## ■ Outside trouble input wiring

- In case of connecting the Relay (procured locally) for outside trouble input, connect a connector with wire (accessory) to CN703 on I/F P.C. Board (MCC-1628).
- After signal is input, 3 sec. later : Forced thermostat - OFF  
1 min. later : Check code "L30" (Hot water module is locked) (Interlock from outside)

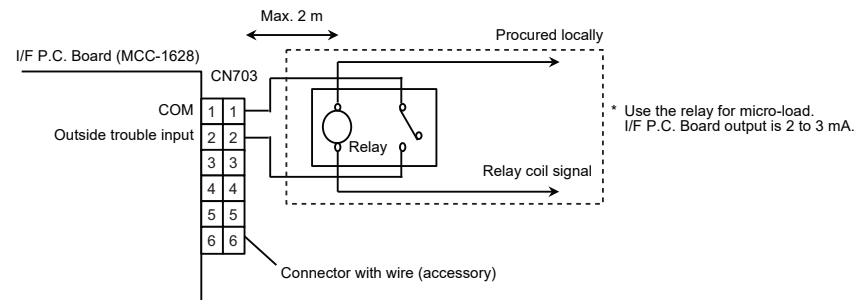

▼ **Clamp filter (accessory)**

- In case of using external connecting to CN703 on I/F P.C. Board (MCC-1628) or CN61 on Control P.C. Board (MCC-1643), attach the clamp filters (accessory) as following.
- Fix a clamp filter to a spacer of P.C. Board or Power supply wire with a binding band.

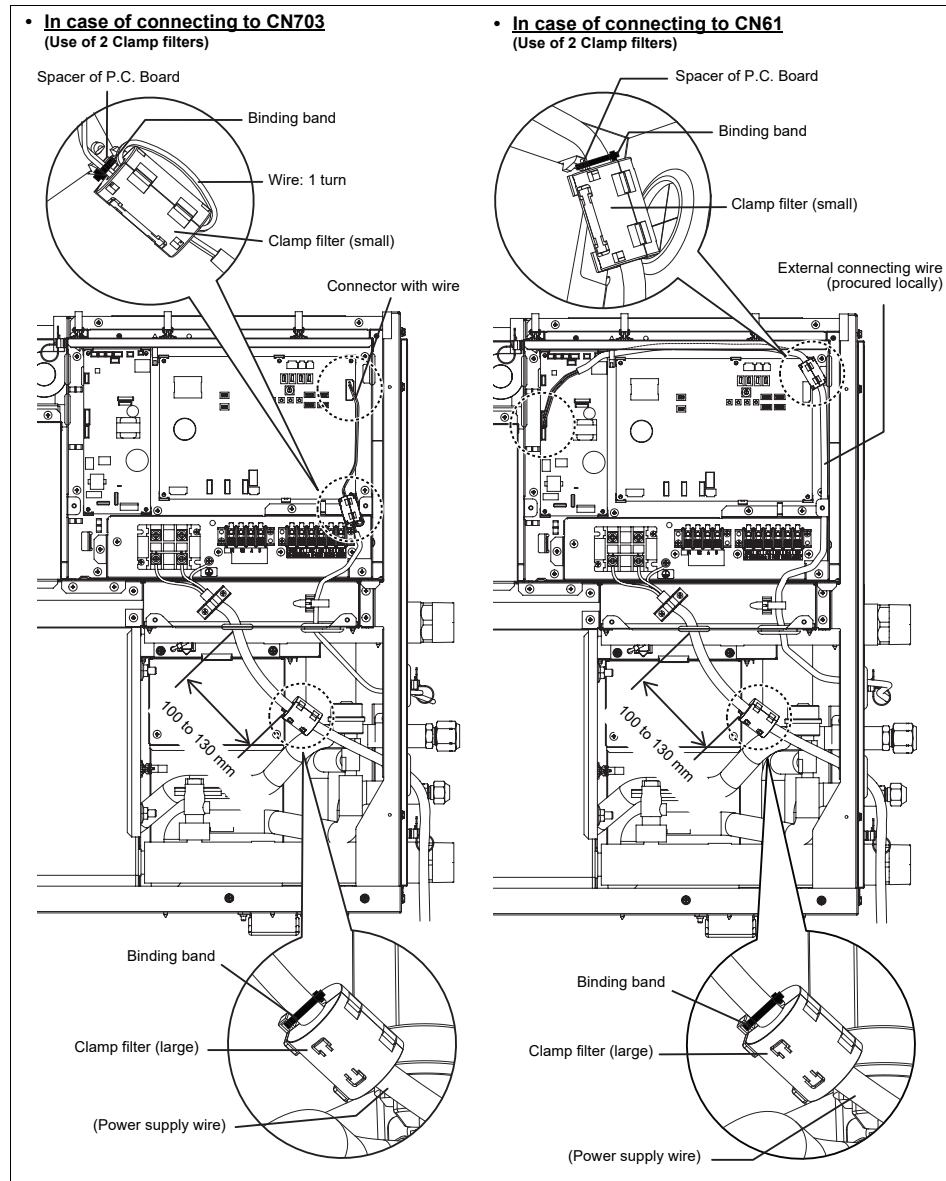

■ **Address setup**

Set up the addresses as per the Installation Manual supplied with the outdoor unit.

**⚠ CAUTION**

Set the DIP switch 4 of SW09 on the P.C. board of the header outdoor unit "ON". (Factory default is "OFF")  
VRF system will be stopped to avoid water freezing when the power supply is disconnected.

**Interface P.C. board on the header outdoor unit**

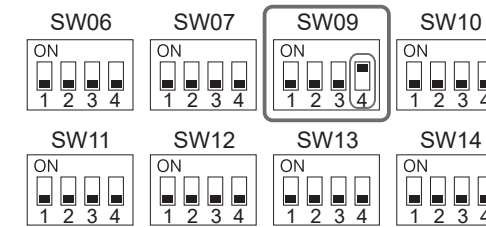

# 10 Applicable controls

## REQUIREMENT

When the hot water module is used for the first time, it will take some moments after the power has been turned on before the remote controller becomes available for operations: This is normal and is not indicative of trouble.

- Concerning the automatic addresses (The automatic addresses are set up by performing operations on the outdoor interface circuit board.)

While the automatic addresses are being set up, no remote controller operations can be performed.

- Setup takes up to 10 minutes (usually about 5 minutes).
- When the power is turned on after automatic address setup  
It takes up to 10 minutes (usually about 3 minutes) for the outdoor unit to start operating after the power has been turned on.

Before the hot water module was shipped from the factory, all units are set to [STANDARD] (factory default). If necessary, change the indoor unit (including hot water module) settings. The settings are changed by operating the wired remote controller.

- \* The settings cannot be changed using only a wireless remote controller, simple remote controller or group control remote controller by itself so install a wired remote controller separately as well.

## Group control

In a group control, a remote controller can control up to maximum 8 units.

- The wired remote controller only can control a group control. The wireless remote controller is unavailable for this control.
- For wiring procedure and wires of the individual line (Identical refrigerant line) system, refer to "Electrical Connection" in this Manual.
- Wiring between indoor units in a group is performed in the following procedure.
- Connect the hot water modules by connecting the remote controller wires from the remote controller terminal blocks (A, B) of the hot water module connected with a remote controller to the remote controller terminal blocks (A, B) of the other hot water modules. (Non-polarity)
- For address setup, refer to the Installation Manual attached to the outdoor unit.

## Remote controller sensor

### CAUTION

Remote controller sensor cannot be used for the hot water module. Remote controller sensor has no function when remote controller is connected to the hot water module.

## Basic procedure for changing settings

Change the settings while the hot water module is not working. (**Stop the hot water module before making settings.**)

### CAUTION

Set only the CODE No. shown in the following table: Do NOT set any other CODE No.

If a CODE No. not listed is set, it may not be possible to operate the hot water module or other trouble with the product may result.

### <RBC-AMT32E>

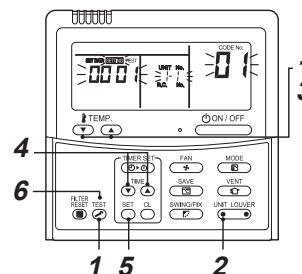

- Push and hold **TEST** button and "TEMP." button simultaneously for at least 4 seconds. After a while, the display flashes as shown in the figure. Confirm that the CODE No. is [01].
  - If the CODE No. is not [01], push **TEST** button to clear the display content, and repeat the procedure from the beginning. (No operation of the remote controller is accepted for a while after **TEST** button is pushed.) (While hot water modules are operated under the group control, "ALL" is displayed first. When **UNIT LOUVER** is pushed, the indoor unit number displayed following "ALL" is the header unit.)

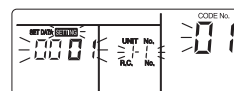

(\* Display content varies with the indoor unit (including hot water module) model.)

- Each time **UNIT LOUVER** button is pushed, hot water module numbers in the control group change cyclically. Select the hot water module to change settings for.

The LED on the P.C. board of the selected hot water module flashes. The hot water module for change settings can be confirmed.

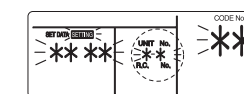
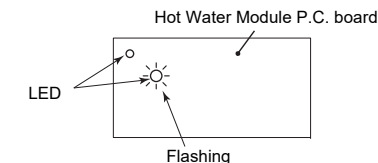

- Specify CODE No. [ \* \* ] with "TEMP." / buttons.
- Select SET DATA [ \* \* \* \* ] with "TIME" / buttons.
- Push **SET** button. When the display changes from flashing to lit, the setup is completed.
  - To change settings of another hot water module, repeat from Procedure 2.
  - To change other settings of the selected hot water module, repeat from Procedure 3.
- Use **SET** button to clear the settings. To make settings after **SET** button was pushed, repeat from Procedure 2.
- When settings have been completed, push **TEST** button to determine the settings. When **TEST** button is pushed, **SETTING** flashes and then the display content disappears and the hot water module enters the normal stop mode. (While **SETTING** is flashing, no operation of the remote controller is accepted.)

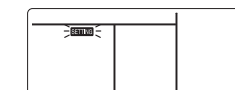

## <RBC-AMS55E-ES/EN>

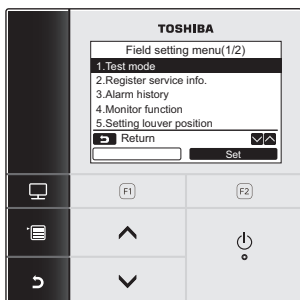

- 1** Push the [ MENU ] button to display the menu screen.
- 2** Push and hold the [ MENU ] button and the [ ↓ ] button at the same time to display the “Field setting menu”.  
→Push and hold the buttons for more than 4 seconds.
- 3** Push the [ CANCEL ] button to return.

Item	Function
1. Test mode	Settings for when performing the test operation after installation
2. Register service info	Registration of information about the contact number for service, model name and serial number of the indoor unit and outdoor unit
3. Alarm history	List of latest 10 alarm data: information of check code, date, time, and unit
4. Monitor function	Monitoring data of sensor temperature, rotating speed of the compressor or other factor.
5. Setting louver position	Change the louver indication setting to match the indoor unit type.
6. Setting timer operation mode	Set whether or not the operation mode can be selected when setting the schedule timer.
7. DN setting	Advanced settings using DN code
8. Reset power consumption data	Resetting the power consumption data saved in the remote controller.

Perform the advanced settings for the air conditioner.

Carry out the setting operation while the indoor unit is stopped. (Turn off the air conditioning unit before starting the setting operation.)

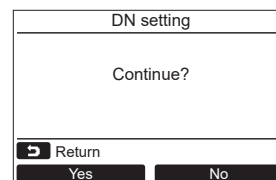
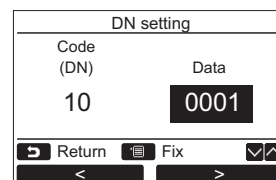
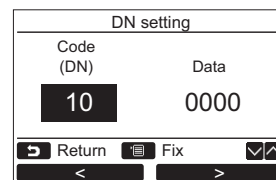

- 1** Push the [ ↑ ] / [ ↓ ] button to select “7. DN setting” on the “Field setting menu” screen, then push the “ Set ” [ F2 ] button.

→The fan and louver of the indoor unit operate.

When the group control is used, the fan and louver of the selected indoor unit operate.

→Move the cursor to select “Code(DN)” with the “ < ” [ F1 ] button, then set “Code(DN)” with the [ ↑ ] / [ ↓ ] button.

→Move the cursor to select “Data” with the “ > ” [ F2 ] button, then set “Data” with the [ ↑ ] / [ ↓ ] button.

- 2** Refer to the Installation Manual supplied with the indoor unit or service manual for details about the Code(DN) and Data.
- 3** Push the [ MENU ] button to set the other Code(DN) and Data. After “Continue?” is displayed on the screen, push the “ Yes ” [ F1 ] button.
- 4** Push the “ No ” [ F2 ] button to finish the setting operation. “ Setting ” appears on the screen for a while, then the screen returns to the “Field setting menu” screen.

→Pushing the “ No ” [ F2 ] button displays the unit selection screen when the group control is used. Push the [ CANCEL ] button on the unit selection screen to finish the setting operation. “ Setting ” appears on the screen for a while, then the screen returns to the “Field setting menu” screen.

# 11 Test run

## ■ Before test run

- Before turning on the power supply, carry out the following procedure.
  - 1) By using 500 V-megger, check that resistance of 1 MΩ or more exists between the terminal block L to N and the earth (grounding). If resistance of less than 1 MΩ is detected, do not run the unit.
  - 2) Check the valve of the outdoor unit being opened fully.
- To protect the compressor at activation time, leave power-ON for 12 hours or more before operating.
- Do not press the electromagnetic contactor to forcibly perform a test run. (This is very dangerous because the protective device does not work.)
- Before starting a test run, set addresses by following the Installation Manual supplied with the outdoor unit.
- Before carrying out a test run, complete the water supply (10 °C or more) to the water pipe system and the wiring for the pump. The entire system stops by detecting a check code (check code: A01) when the water is not supplied to the Hot Water Module and when the water does not circulate.

## ■ Execute a test run

Operate the unit with the wired remote controller as usual.  
 For the procedure of the operation, refer to the attached Owner's Manual to the outdoor unit.  
 A forced test run can be executed in the following procedure even if the operation stops by thermostat-OFF.  
 In order to prevent a serial operation, the forced test run is released after 60 minutes have passed and returns to the usual operation.

### ⚠ CAUTION

Do not use the forced test run for cases other than the test run because it applies an excessive load to the devices.

### <RBC-AMT32E>

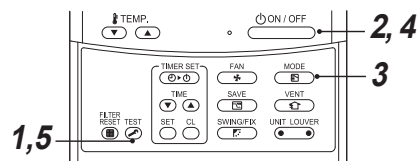

- 1 Push **TEST** button for 4 seconds or more. [TEST] is displayed on the display part and the selection of mode in the test mode is permitted.

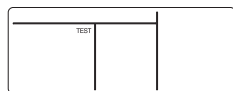

- 2 Push **ON/OFF** button.
- 3 Select the operation mode with **MODE** button, [**Heat**].

- Cannot select the hot water module in a mode other than [**Heat**].
- The temperature controlling function does not work during test run.
- The detection of trouble is performed as usual.

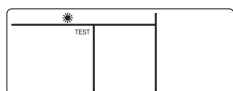

- 4 After the test run, push **ON/OFF** button to stop a test run. (Display part is same as procedure 1.)

- 5 Push **TEST** check button to cancel (release from) the test run mode. ([TEST] disappears on the display and the status returns to a normal.)

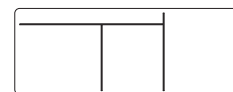

### <RBC-AMS55E-ES/EN>

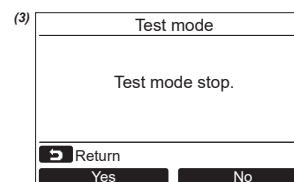
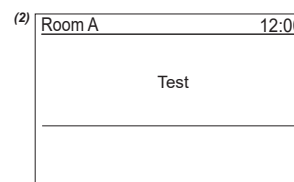
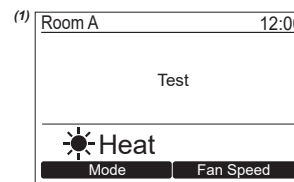
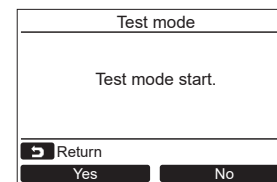
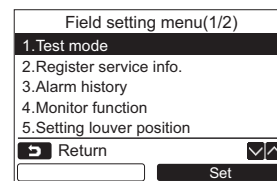

- 1 Push the [**▲** / **▲**] / [**▼** / **▼**] button to select "1. Test mode" on the "Field setting menu" screen, then push the "**Set**" button. [F2] F2] button.

→Pushing the "**Yes**" / "**Yes**" [F1] F1] button sets the test mode and the screen returns to the "Field setting menu" screen. Push [**CANCEL**] twice, the screen (2) appears.

- 2 Push the [**ON/OFF**] button to start the test mode. The screen (1) shown in the left appears. (The screen (2) appears when the operation is stopped.)

→Perform the test mode in the "Cool" or "Heat" mode.  
 →Temperature setting cannot be adjusted during the test mode.  
 →Check codes are displayed as usual.

- 3 When the test mode is finished, push the [**▲** / **▲**] / [**▼** / **▼**] button to select "1. Test mode" on the "Field setting menu" screen, then push the "**Set**" / "**Set**" [F2] F2] button.

The screen (3) appears.  
 →Pushing the "**Yes**" / "**Yes**" [F1] F1] button stops the test mode screen and continues the normal operation.

### NOTE

The test mode stops after 60 minutes and the screen returns to the normal / detailed display.

## Using the Service monitor with the [MONITOR] button during the test mode

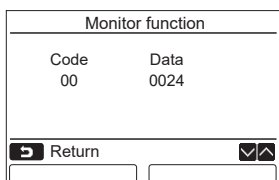
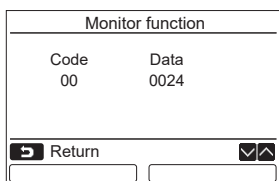
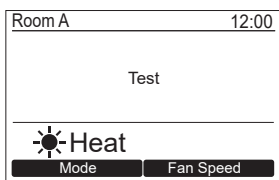

Push the [MONITOR] button

- 1 Push the [▲ ▲] / [▼ ▼] button to select "4. Monitor function" on the "Field setting menu" screen, then push the "Set" button. → Push the [▲ ▲] / [▼ ▼] button to select the code to check data.
- 2 Refer to the Installation Manual supplied with the indoor unit or outdoor unit or service manual for details about the check code and data.
- 3 Push the [CANCEL] button to return to the "Field setting menu" screen.

## Items to check before conducting a trial operation

Check the following items before the trial operation. The numbers in parentheses are the chapter numbers in the table of contents of the installation manual.

		Check
Installation work	Is the equipment attached to the legs with bolts? (See chapter 5.)	
	Is there sufficient open space around the equipment for servicing? (See chapter 5.)	
	Have the criteria for selecting a location to install the equipment been met? (See chapter 4.)	
Piping work	Are all of the pipes connected correctly? (See chapter 5.)	
	Are there no water leaks?	
	Is the flow rate suitable? (See chapter 6.)	
	Is the strainer in a suitable location? (See chapters 3 and 6.)	
	Is the line heater in a suitable location and is the flow rate suitable? (See chapters 3 and 6.)	
	Have suitable safety devices for pressure relief and expansion tanks been installed? (See chapters 3 and 6.)	
	Is the shut-off valve in a suitable location? (See chapters 3 and 6.)	
	Is the air vent valve in a suitable location? (See chapters 3 and 6.)	
Electric wiring work	Is the piping material suitably heat resistant and corrosion resistant? (See chapters 6 to 8.)	
	Can water discharge through the drain? (See chapter 7.)	
	Was the heat-retention work done suitably? (See chapters 6 to 8.)	
	Is the electric wiring connected correctly? (See chapter 9.)	
Outdoor unit board settings	Is the electric wiring thick enough? (See chapter 9.)	
	Is the power fed from a dedicated ground fault circuit breaker?	
	Is the output terminal wired? (See chapter 9.)	
	Is the address fixed? (*1)	
	Has DIP switch 4 of SW09 on the interface board of the header outdoor unit been set to "ON" (factory default is "OFF")? (See chapter 9.) (*2)	

\*1 Do not operate the air conditioner (run the compressor) before the address to the hot water module is fixed. Doing so will cause the heat exchanger in the hot water module to freeze, rupture, and leak water.

\*2 Set DIP switch 4 of SW09 on the P.C. board of the header outdoor unit to "ON" (factory default is "OFF"). The VRF system will be stopped to avoid water freezing when the power supply is disconnected.

### NOTE

Before you run the compressor, always confirm that the hot water module is operable (power on, address fixed, communication wiring complete).

Failure to do this will cause the heat exchanger in the hot water module to freeze, rupture, and leak water.

# 12 Maintenance

## ▼ Periodic Maintenance

- For environmental conservation, it is strongly recommended that the indoor and outdoor units of the air conditioner (including hot water module) in use be cleaned and maintained regularly to ensure efficient operation of the air conditioner.  
When the air conditioner (including hot water module) is operated for a long time, periodic maintenance (once a year) is recommended.  
Furthermore, regularly check the outdoor unit for rust and scratches, and remove them or apply rustproof treatment, if necessary.  
As a general rule, when an indoor unit is operated for 8 hours or more daily, clean the indoor unit and outdoor unit at least once every 3 months. Ask a professional for this cleaning / maintenance work.  
Such maintenance can extend the life of the product though it involves the owner's expense.  
Failure to clean the indoor and outdoor units regularly will result in poor performance, freezing, water leakage, and even compressor failure.

## Inspection before maintenance

Following inspection must be carried out by a qualified installer or qualified service person.

Parts	Inspection method
Drain pan	Access from inspection opening and remove the front panel. Check if there is any clogging or drain water is polluted.

## ▼ Maintenance List

Part	Unit	Check (visual / auditory)	Maintenance
Heat exchanger	Outdoor	Dust / dirt clogging, scratches	Wash the heat exchanger when it is clogged.
Fan motor	Outdoor	Sound	Take appropriate measures when abnormal sound is generated.
Air inlet / outlet grilles	Outdoor	Dust / dirt, scratches	Fix or replace them when they are deformed or damaged.
Drain pan	Hot water module	Dust / dirt clogging, drain contamination	Clean the drain pan and check the downward slope for smooth drainage.
Exterior	Hot water module / Outdoor	<ul style="list-style-type: none"> <li>Rust, peeling of insulator</li> <li>Peeling / lift of coat</li> </ul>	Apply repair coating.
Water pipes	Hot water module	Rust, leakage Evidence of leakage	Checking
Strainer	Hot water module	Dust / dirt clogging	Checking
Air vent valve	Hot water module	Air entrainment	Checking an air vent valve

It recommends that a pump and a strainer are maintained periodically.

# 13 Troubleshooting

## <RBC-AMT32E>

### ■ Confirmation and check

When a trouble occurred in the hot water module, a check code and indoor UNIT No. (including hot water module) appear on the display part of the remote controller.  
The check code is only displayed during the operation.  
If the display disappears, operate the hot water module according to the following "Confirmation of trouble log" for confirmation.

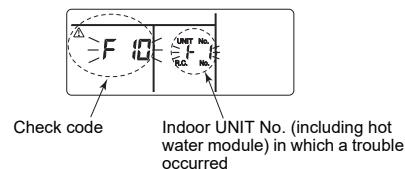

### ■ Confirmation of trouble log

When a trouble occurred on the hot water module, the trouble log can be confirmed with the following procedure. (The trouble log is stored in memory up to 4 trouble.)  
The log can be confirmed from both operating status and stop status.

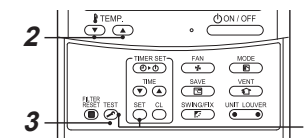

**1**  
When **SET** and **TEST** buttons are pushed simultaneously for 4 seconds or more, the following display appears. If **F** is displayed, the mode enters in the trouble log mode.

- [01: Order of trouble log] is displayed in CODE No..
- [Check code] is displayed in CHECK.
- [Indoor unit address in which a trouble occurred] is displayed in Unit No..

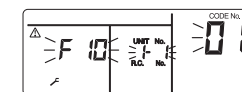

**2**  
Every pushing of **TEMP.** button used to set temperature, the trouble log stored in memory is displayed in order.  
The numbers in CODE No. indicate CODE No. [01] (latest) → [04] (oldest).

#### REQUIREMENT

Do not push **ON/OFF** button because all the trouble log of the indoor unit (including hot water module) will be deleted.

**3**  
After confirmation, push **TEST** button to return to the usual display.



## <RBC-AMS55E-ES/EN>

### ■ Confirmation and check

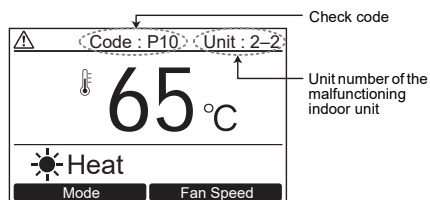

Check code

Unit number of the malfunctioning indoor unit

When an error has occurred in the air conditioner, the check code and the unit number of the indoor unit appear on the display of the remote controller.

\* The check code appears only while the unit is running.

Push the [MONITOR] button or [CANCEL] button to display the check information screen.

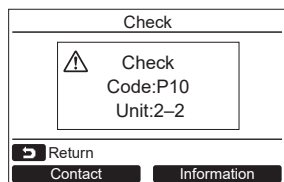

While the check information screen appears:  
Push the "Contact" [F1] button to display the contact number for service.  
Push the "Information" [F2] button to display the model name and serial number of the unit.

in addition to the CODE No. on the remote controller of an indoor unit, you can diagnose failure type of an outdoor unit by checking the 7-segment display on the interface P.C. board.  
Use the function for various checks.  
Set every DIP switch to OFF after checking.

### 7-Segment display and check code

Rotary switch setting value			Indication	LED	
SW01	SW02	SW03			
1	1	1	Outdoor unit check code	A	Outdoor unit number (U <sub>1</sub> to U <sub>3</sub> )
				B	Check code display*

\* If a check code has an auxiliary code, the display indicates the check code for three seconds and the auxiliary code for one second alternately.

### Check code (indicated on the 7-segment display on the outdoor unit)

Indicated when SW01 = [1], SW02 = [1], and SW03 = [1].

Check code		Check code name
Indication on 7-segment display on the outdoor unit		
Auxiliary code		
A01	Detected Hot water module address	Flow switch operation trouble
A02	Detected Hot water module address	Water temperature decrease trouble
A04	Detected Hot water module address	Activation of water heat exchanger frost protection
A05	Detected High-temperature Hot water module address	Activation of water High-temperature protection
A06	Detected High-temperature Hot water module address	Activation of low-pressure protection
A07	Detected High-temperature Hot water module address	PMV2 trouble
A08	Detected High-temperature Hot water module address	Reversal of inlet water temperature and outlet water temperature
A09	Detected High-temperature Hot water module address	Mixed refrigerant (R410A with R134a)
A10	Detected High-temperature Hot water module address	TD/TE/TS sensor trouble
A11	Detected High-temperature Hot water module address	TD/TE/TS sensor connection trouble
A12	Detected High-temperature Hot water module address	Pressure sensor trouble (PD, PS)
A13	Detected High-temperature Hot water module address	EEPROM (I/F) trouble
A14	Detected High-temperature Hot water module address	Heat sink overheat trouble
A15	Detected High-temperature Hot water module address	IGBT short-circuit protection trouble
A16	Detected High-temperature Hot water module address	Current detection circuit system trouble
A17	Detected High-temperature Hot water module address	Compressor trouble (lock)
A18	Detected High-temperature Hot water module address	Compressor breakdown
A19	Detected High-temperature Hot water module address	Compressor position detection circuit system trouble
A20	Detected High-temperature Hot water module address	---
A21	Detected High-temperature Hot water module address	Inverter DC voltage (Vdc) trouble (compressor).
A22	Detected High-temperature Hot water module address	Compressor case thermo operation
A23	Detected High-temperature Hot water module address	High-pressure SW system trouble
A24	Detected High-temperature Hot water module address	TH sensor trouble
A25	Detected High-temperature Hot water module address	Discharge temperature TD trouble

Check code		Check code name
Indication on 7-segment display on the outdoor unit		
Auxiliary code		
A26	Detected High-temperature Hot water module address	Gas leak detection
A27	Detected High-temperature Hot water module address	High-pressure protective operation
A28	Detected High-temperature Hot water module address	P.C. board communication trouble between I/F and IPDU.
E06	Number of indoor units and Hot Water Module which received normally	Decrease of number of indoor units and Hot Water Module
E07	—	Indoor / outdoor communication circuit trouble
E08	Duplicated indoor addresses	Duplication of indoor addresses.
E11	Detected High-temperature Hot water module address	P.C. board communication trouble between I / F and Main.
E12	01: Communication between indoor and outdoor units 02: Communication between outdoor units	Automatic addressing start trouble
E15	—	No indoor unit during automatic addressing
E16	00: Capacity over 01~: Number of connected units	Capacity over / number of connected indoor units
E19	00: Header is nothing 02: 2 or more header units	Number of header outdoor unit trouble
E20	01: Other line outdoor connected 02: Other line indoor connected	Other lines connected during automatic addressing
E23	—	Communication transmission trouble between outdoor units
E25	—	Duplicated follower outdoor address set up
E26	Number of outdoor units which received normally	Decrease of connected outdoor units
E28	Detected outdoor unit No.	Follower outdoor unit trouble
E31	IPDU quantity information <sup>(*)</sup>	IPDU communication trouble
E31	80	Communication trouble between MCU and sub MCU
F04	—	TD1 sensor trouble
F05	—	TD2 sensor trouble
F06	01: TE1 sensor 02: TE2 sensor	TE1 sensor trouble TE2 sensor trouble
F07	01: TL1 sensor	TL1 sensor trouble
F08	—	TO sensor trouble
F12	01: TS1 sensor 02: TS2 sensor	TS1 or TS2 sensor trouble
F13	01: Compressor 1 02: Compressor 2	TH (Heat sink) sensor trouble
F15	—	Outdoor temp. sensor miswiring (TE1, TL1)
F16	—	Outdoor pressure sensor miswiring (Pd, Ps)
F23	—	Ps sensor trouble
F24	—	Pd sensor trouble
F31	—	Outdoor EEPROM trouble
H01	01: Compressor 1 02: Compressor 2	Compressor breaking down
H02	01: Compressor 1 02: Compressor 2	Compressor trouble (Locked)
H03	01: Compressor 1 02: Compressor 2	Current detection circuit trouble
H05	—	TD1 sensor miswiring

Check code		Check code name
Indication on 7-segment display on the outdoor unit		
Auxiliary code		
H06	—	Low pressure protective operation
H07	Detected outdoor unit No.	Oil level down detection (Indicated only on the header outdoor unit)
H08	01: TK1 sensor trouble 02: TK2 sensor trouble 04: TK4 sensor trouble 05: TK5 sensor trouble	Temperature sensor trouble for oil level
H15	—	TD2 sensor miswiring
H16	01: TK1 oil circuit trouble 02: TK2 oil circuit trouble 04: TK4 oil circuit trouble 05: TK5 oil circuit trouble	Oil level detector circuit trouble
J10	Detected indoor unit address	Flow selector units overflow trouble
L02	Model mismatch of indoor and outdoor unit	System shutdown trouble from indoor unit
L04	—	Outdoor system address duplication
L06	Number of prior indoor units	Duplication of indoor units with priority
L08	—	Indoor unit group / address unset
L10	—	Outdoor unit capacity unset.
L12	01: Flow selector unit(s) installation trouble	Flow selector unit(s) system trouble
L17	—	Inconsistent models of outdoor units
L18	Detected indoor unit address	Flow selector unit trouble
L23	01: Clean Converter setting trouble 02: Hot Water Module setting trouble	Setting trouble
L24	01: Duplication of flow selector unit address 02: Indoor unit(s) operation mode priority setting	Flow selector unit(s) setting trouble
L28	—	Outdoor connected quantity over
L29	IPDU number information <sup>(*)</sup>	IPDU quantity trouble
L30	Detected indoor unit address	External interlock of indoor unit
L31	—	Compressor IPDU trouble
P03	—	Discharge temperature TD1 trouble
P04	01: Compressor 1 02: Compressor 2	High-pressure SW system operation
P05	01: Compressor 1 02: Compressor 2	Compressor Vdc trouble AC detection circuit trouble
P07	01: Compressor 1 02: Compressor 2	Heat sink overheat trouble
P10	Detected indoor unit address	Indoor overflow trouble
P13	—	Outdoor unit flow back trouble detected
P15	01: TS condition 02: TD condition	Gas leak detection
P17	—	Discharge temperature TD2 trouble
P19	Detected outdoor unit number	4-way valve inverse trouble
P20	—	High-pressure protective operation

Check code		Check code name
Indication on 7-segment display on the outdoor unit		
Auxiliary code		
P22	#0: Element short circuit #E: Vdc voltage trouble #1: Position detection circuit trouble #2: Input current sensor trouble #3: Motor lock trouble #C: Sensor temperature trouble (No TH sensor) #4: Motor current trouble #D: Sensor short circuit/release trouble (No TH sensor) #5: Synchronization/step-out trouble *Put in Fan IPDU No. in [#] mark.	Outdoor fan IPDU trouble
P26	01: Compressor 1 02: Compressor 2	IPM short protection trouble
P29	01: Compressor 1 02: Compressor 2	Compressor position detecting circuit trouble

\*1 IPDU number information

- 01: Compressor 1 trouble
- 02: Compressor 2 trouble
- 03: Compressor 1 and 2 trouble
- 08: Fan 1 trouble
- 09: Compressor 1, Fan 1 trouble
- 0A: Compressor 2, Fan 1 trouble
- 0B: Compressor 1 and 2, Fan 1 trouble

# 14 Specifications

Model	Sound pressure level (dB(A))	Weight (kg) Main unit
	Heating	
MMW-AP0481CHQ-E	*	100

\* Under 70 dB(A)

Contains fluorinated greenhouse gases	
Chemical Name of Gas	R134a
Global Warming Potential (GWP) of Gas	1430

## CAUTION

- (1) Stick the enclosed refrigerant label adjacent to the service ports for charging or recovering location and where possible adjacent to existing nameplates or product information label.
- (2) Prevent emission of the contained fluorinated greenhouse gas. Ensure that the fluorinated greenhouse gas is never vented to the atmosphere during installation, service or disposal. When any leakage of the contained fluorinated greenhouse gas is detected, the leak shall be stopped and repaired as soon as possible.
- (3) Only qualified service personnel are allowed to access and service this product.
- (4) Any handling of the fluorinated greenhouse gas in this product, such as when moving the product or recharging the gas, shall comply under (EU) Regulation No.517/2014 on certain fluorinated greenhouse gases and any relevant local legislation.
- (5) Periodical inspections for refrigerant leaks may be required depending on European or local legislation.
- (6) Contact dealers, installers, etc., for any questions.

## Warnings on Refrigerant Leakage

### Check of Concentration Limit

The room in which the air conditioner (including hot water module) is to be installed requires a design that in the event of refrigerant gas leaking out, its concentration will not exceed a set limit.

The refrigerant R410A which is contained in the outdoor unit and R134a which is contained in High temperature hot water module are safe, without the toxicity or combustibility of ammonia, and is not restricted by laws to be imposed which protect the ozone layer. However, since it contains more than air, it poses the risk of suffocation if its concentration should rise excessively. Suffocation from leakage of R410A and R134a are almost non-existent. With the recent increase in the number of high concentration buildings, however, the installation of multi air conditioner systems (including hot water module) is on the increase because of the need for effective use of floor space, individual control, energy conservation by curtailing heat and carrying power etc.

Most importantly, the multi air conditioner system (including hot water module) is able to replenish a large amount of refrigerant compared with conventional individual air conditioners. If a single unit of the multi conditioner system (including hot water module) is to be installed in a small room, select a suitable model and installation procedure so that if the refrigerant accidentally leaks out, its concentration does not reach the limit (and in the event of an emergency, measures can be made before injury can occur).

In a room where the concentration may exceed the limit, create an opening with adjacent rooms, or install mechanical ventilation combined with a gas leak detection device. The concentration is as given below.

$$\frac{\text{Total amount of refrigerant (kg)}}{\text{Min. volume of the indoor unit (including hot water module) installed room (m}^3\text{)}} \leq \text{Concentration limit (kg/m}^3\text{)}$$

Refrigerant Concentration Limit shall be in accordance with local regulations.

#### ▼ NOTE 1

If there are 2 or more refrigerating systems in a single refrigerating device, the amounts of refrigerant should be as charged in each independent device.

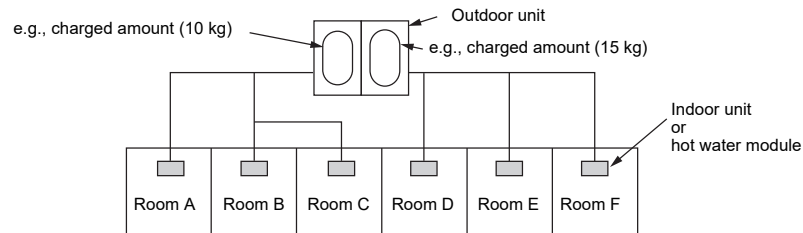

For the amount of charge in this example:

The possible amount of leaked refrigerant gas in rooms A, B and C is 10 kg.

The possible amount of leaked refrigerant gas in rooms D, E and F is 15 kg.

#### ▼ NOTE 2

The standards for minimum room volume are as follows.

- 1) No partition (shaded portion)

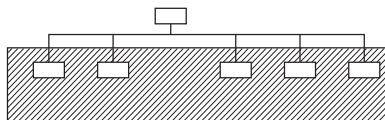

### Important

- 2) When there is an effective opening with the adjacent room for ventilation of leaking refrigerant gas (opening without a door, or an opening 0.15% or larger than the respective floor spaces at the top or bottom of the door).

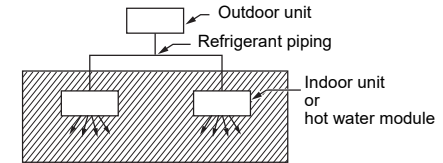

- 3) If an indoor unit (including hot water module) is installed in each partitioned room and the refrigerant piping is interconnected, the smallest room of course becomes the object. But when a mechanical ventilation is installed interlocked with a gas leakage detector in the smallest room where the density limit is exceeded, the volume of the next smallest room becomes the object.

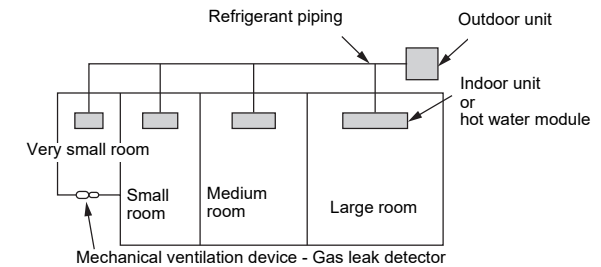

## Confirmation of indoor unit setup

Prior to delivery to the customer, check the address and setup of the indoor unit (including hot water module), which has been installed in this time and fill the check sheet (Table below). Data of four units can be entered in this check sheet. Copy this sheet according to the No. of the indoor units (including hot water module). If the installed system is a group control system, use this sheet by entering each line system info to each installation manual attached to the other indoor units (including hot water module).

### REQUIREMENT

This check sheet is required for maintenance after installation. Fill this sheet and then pass this Installation Manual to the customers.

#### Indoor unit setup check sheet

Indoor unit		Indoor unit		Indoor unit		Indoor unit	
Room name		Room name		Room name		Room name	
Model		Model		Model		Model	
Check indoor unit address. (For check method, refer to APPLICABLE CONTROLS in this manual.)							
*In case of a single system, it is unnecessary to enter the indoor address. (CODE NO.: Line [12], Indoor [13], Group [14], Central control [03])							
Line	Indoor	Group	Line	Indoor	Group	Line	Indoor
Central control address		Central control address		Central control address		Central control address	
Various setup		Various setup		Various setup		Various setup	
Have you changed lighting time of filter sign? If not, fill check mark [x] in [NO CHANGE], and fill check mark [x] in [ITEM] if changed, respectively. (For check method, refer to APPLICABLE CONTROLS in this manual.)							
Have you changed detected temp. shift value? If not, fill check mark [x] in [NO CHANGE], and fill check mark [x] in [ITEM] if changed, respectively. (For check method, refer to APPLICABLE CONTROLS in this manual.)							
Incorporation of parts sold separately		Incorporation of parts sold separately		Incorporation of parts sold separately		Incorporation of parts sold separately	
Have you incorporated the following parts sold separately? If incorporated, fill check mark [x] in each [ITEM]. (When incorporating, the setup change is necessary in some cases. For setup change method, refer to Installation Manual attached to each part sold separately.)							
<input type="checkbox"/> Others (    )	<input type="checkbox"/> Others (    )	<input type="checkbox"/> Others (    )	<input type="checkbox"/> Others (    )	<input type="checkbox"/> Others (    )	<input type="checkbox"/> Others (    )	<input type="checkbox"/> Others (    )	<input type="checkbox"/> Others (    )
<input type="checkbox"/> Others (    )	<input type="checkbox"/> Others (    )	<input type="checkbox"/> Others (    )	<input type="checkbox"/> Others (    )	<input type="checkbox"/> Others (    )	<input type="checkbox"/> Others (    )	<input type="checkbox"/> Others (    )	<input type="checkbox"/> Others (    )

# **Toshiba Carrier Corporation**

**336 TADEHARA, FUJI-SHI, SHIZUOKA-KEN 416-8521 JAPAN**

**EB99829001-1**