

TOSHIBA

Leading Innovation >>>

For commercial use

Air to Air Heat Exchanger **Owner's Manual**

**Concealed Microcomputer
Control Type**

Model name:

VN-M1000HE1

VN-M1500HE1

VN-M2000HE1

Original instruction

Thank you very much for purchasing TOSHIBA Air to Air Heat Exchanger.
 Please read this owner's manual carefully before using your Air to Air Heat Exchanger.

- Obtain the "Owner's manual" and "Installation manual" from constructor (or dealer).

Request to constructor or dealer

- Please clearly explain the contents of the Owner's manual and hand over it.

This appliance is not intended for use by person (including children) with reduced physical, sensory or mental capabilities, or lack of experience and knowledge, unless they have been given supervision or instruction concerning use of the appliance by a person responsible for their safety.
 Children should be supervised to ensure that they do not play with the appliance.

This appliance can be used by children aged from 8 years and above and persons with reduced physical, sensory or mental capabilities or lack of experience and knowledge if they have been given supervision or instruction concerning use of the appliance in a safe way and understand the hazards involved. Children shall not play with the appliance. Cleaning and user maintenance shall not be made by children without supervision.

Contents

1 Precautions for safety 2

2 Features 6

3 Standard installation example 6

4 System configuration. 7

5 Part names and functions 8

6 How to use 12

7 Timer operation 15

8 Maintenance 16

9 Specifications. 16

10 Before calling for service 17

11 Troubleshooting. 18

Please read carefully through these instructions that contain important information which complies with the "Machinery" Directive (Directive 2006/42/EC), and understand them.



Generic Denomination: Air to Air Heat Exchanger

Definition of Qualified Installer or Qualified Service Person

The Air to Air Heat Exchanger must be installed, maintained, repaired and removed by a qualified installer or qualified service person. When any of these jobs is to be done, ask a qualified installer or qualified service person to do them for you. A qualified installer or qualified service person is an agent who has the qualifications and knowledge described in the table below.



Agent	Qualifications and knowledge which the agent must have
Qualified installer	<ul style="list-style-type: none"> • The qualified installer is a person who installs, maintains, relocates and removes the Air to Air Heat Exchangers made by Toshiba Carrier Corporation. He or she has been trained to install, maintain, relocate and remove the Air to Air Heat Exchangers made by Toshiba Carrier Corporation or, alternatively, he or she has been instructed in such operations by an individual or individuals who have been trained and is thus thoroughly acquainted with the knowledge related to these operations. • The qualified installer who is allowed to do the electrical work involved in installation, relocation and removal has the qualifications pertaining to this electrical work as stipulated by the local laws and regulations, and he or she is a person who has been trained in matters relating to electrical work on the Air to Air Heat Exchangers made by Toshiba Carrier Corporation or, alternatively, he or she has been instructed in such matters by an individual or individuals who have been trained and is thus thoroughly acquainted with the knowledge related to this work. • The qualified installer who is allowed to work at heights has been trained in matters relating to working at heights with the Air to Air Heat Exchangers made by Toshiba Carrier Corporation or, alternatively, he or she has been instructed in such matters by an individual or individuals who have been trained and is thus thoroughly acquainted with the knowledge related to this work.
Qualified service person	<ul style="list-style-type: none"> • The qualified service person is a person who installs, repairs, maintains, relocates and removes the Air to Air Heat Exchangers made by Toshiba Carrier Corporation. He or she has been trained to install, repair, maintain, relocate and remove the Air to Air Heat Exchangers made by Toshiba Carrier Corporation or, alternatively, he or she has been instructed in such operations by an individual or individuals who have been trained and is thus thoroughly acquainted with the knowledge related to these operations. • The qualified service person who is allowed to do the electrical work involved in installation, repair, relocation and removal has the qualifications pertaining to this electrical work as stipulated by the local laws and regulations, and he or she is a person who has been trained in matters relating to electrical work on the Air to Air Heat Exchangers made by Toshiba Carrier Corporation or, alternatively, he or she has been instructed in such matters by an individual or individuals who have been trained and is thus thoroughly acquainted with the knowledge related to this work. • The qualified service person who is allowed to work at heights has been trained in matters relating to working at heights with the Air to Air Heat Exchangers made by Toshiba Carrier Corporation or, alternatively, he or she has been instructed in such matters by an individual or individuals who have been trained and is thus thoroughly acquainted with the knowledge related to this work.

These safety cautions describe important matters concerning safety to prevent injury to users or other people and damages to property. Please read through this manual after understanding the contents below (meanings of indications), and be sure to follow the description.



Indication	Meaning of Indication
 WARNING	Text set off in this manner indicates that failure to adhere to the directions in the warning could result in serious bodily harm (*1) or loss of life if the product is handled improperly.
 CAUTION	Text set off in this manner indicates that failure to adhere to the directions in the caution could result in slight injury (*2) or damage (*3) to property if the product is handled improperly.

- *1: Serious bodily harm indicates loss of eyesight, injury, burns, electric shock, bone fracture, poisoning, and other injuries which leave aftereffect and require hospitalization or long-term treatment as an outpatient.
 *2: Slight injury indicates injury, burns, electric shock, and other injuries which do not require hospitalization or long-term treatment as an outpatient.
 *3: Damage to property indicates damage extending to buildings, household effects, domestic livestock, and pets.

MEANINGS OF SYMBOLS DISPLAYED ON THE UNIT

	Read the OWNER'S MANUAL carefully before operation.
	Service personnel are required to carefully read the OWNER'S MANUAL and INSTALLATION MANUAL before operation.
	Further information is available in the OWNER'S MANUAL, INSTALLATION MANUAL, and the like.

Warning indications on the Air to Air Heat Exchanger

Warning indication	Description		
 <table border="1"> <tr> <td>WARNING</td> </tr> <tr> <td>ELECTRICAL SHOCK HAZARD Disconnect all remote electric power supplies before servicing.</td> </tr> </table>	WARNING	ELECTRICAL SHOCK HAZARD Disconnect all remote electric power supplies before servicing.	WARNING ELECTRICAL SHOCK HAZARD Disconnect all remote electric power supplies before servicing.
WARNING			
ELECTRICAL SHOCK HAZARD Disconnect all remote electric power supplies before servicing.			
 <table border="1"> <tr> <td>WARNING</td> </tr> <tr> <td>Moving parts. Do not operate unit with inspection cover removed. Stop the unit before the servicing.</td> </tr> </table>	WARNING	Moving parts. Do not operate unit with inspection cover removed. Stop the unit before the servicing.	WARNING Moving parts. Do not operate unit with inspection cover removed. Stop the unit before the servicing.
WARNING			
Moving parts. Do not operate unit with inspection cover removed. Stop the unit before the servicing.			
 <table border="1"> <tr> <td>CAUTION</td> </tr> <tr> <td>High temperature parts. You might get burned when removing this cover.</td> </tr> </table>	CAUTION	High temperature parts. You might get burned when removing this cover.	CAUTION High temperature parts. You might get burned when removing this cover.
CAUTION			
High temperature parts. You might get burned when removing this cover.			

1 Precautions for safety

The manufacturer shall not assume any liability for the damage caused by not observing the description of this manual.

WARNING

General

- Carefully read Owner's Manual before starting the Air to Air Heat Exchanger. There are many important things to keep in mind for daily operation.
- Ask for installation to be performed by the dealer or a professional. Only a qualified installer (*1) is able to install an Air to Air Heat Exchanger. If a non-qualified person installs an Air to Air Heat Exchanger, it may result in problems such as fire, electric shock, injury, water leakage, noise and vibration.

Transportation and storage

- When transporting the Air to Air Heat Exchanger, wear shoes with protective toe caps, protective gloves, and other protective clothing.
- When transporting the Air to Air Heat Exchanger, do not take hold of the bands around the packing carton. You may injure yourself if the bands should break.
- When stacking the packing cartons for storage or transportation, heed the precautions written on the packing cartons. Failure to heed the precautions may cause the stack to collapse.
- The Air to Air Heat Exchanger should be transported in stable condition. If any part of the product broken, contact your dealer.
- Use a hand truck or forklift to carry the unit. When carrying it by human power, have four persons or more (VN-M1000HE1) eight persons or more (VN-M1500HE1 and M2000HE1); otherwise, you may strain your back.

Installation

- Only a qualified installer(*1) or qualified service person(*1) is allowed to carry out the electrical work of the Air to Air Heat Exchanger. Under no circumstances must this work be done by an unqualified individual since failure to carry out the work properly may result in electric shocks and/or electrical leaks.
- After the installation work has been completed, have the installer explain about the circuit breaker positions. In the event that trouble has occurred in the Air to Air Heat Exchanger, set the circuit breaker to the OFF position, and contact a service person.

- Do not install the Air to Air Heat Exchanger in a location that may be subject to a risk of exposure to a combustible gas. If a combustible gas leaks and becomes concentrated around the unit, a fire may occur.
- Use the company-specified products for the separately purchased parts. Use of non-specified products may result in fire, electric shock, water leakage or other trouble. Have the installation performed by a professional.
- Confirm that earthing is performed correctly.

Operation

- Before opening the electrical control cover or inspection cover of the Air to Air Heat Exchanger, set the circuit breaker to the OFF position. Failure to set the circuit breaker to the OFF position may result in electric shocks through contact with the interior parts. Only a qualified installer(*1) or qualified service person(*1) is allowed to remove the electrical control cover or inspection cover of the Air to Air Heat Exchanger and do the work required.
- Inside the Air to Air Heat Exchanger are high-voltage areas and rotating parts. Due to the danger of electric shocks or of your fingers or physical objects becoming trapped in the rotating parts, do not remove the electrical control cover or inspection cover of the Air to Air Heat Exchanger. When work involving the removal of these parts is required, contact a qualified installer or a qualified service person.
- Do not move or repair any unit by yourself. Since there is high voltage inside the unit, you may get electric shock when removing the cover and main unit.
- Use of a stand more than 50 cm high to clean the filter or heat exchange element of the Air to Air Heat Exchanger or to carry out other such jobs constitutes working at heights. Due to the danger of falling off the stand and injuring yourself while working at heights, this kind of work should not be done by unqualified individuals. When this kind of work must be carried out, do not do it yourself but ask a qualified installer or a qualified service person to do it for you.
- Do not place any combustion appliance in a place where it is directly exposed to the wind of Air to Air Heat Exchanger, otherwise it may cause imperfect combustion.
- Do not insert your finger or a stick into the air intake or discharge. Doing so may result injury as the fan is rotating at high speed inside the unit.

Repairs

- When you have noticed that some kind of trouble (such as when a check display has appeared, there is a smell of burning, abnormal sounds are heard, water is leaking) has occurred in the Air to Air Heat Exchanger, do not touch the Air to Air Heat Exchanger yourself but set the circuit breaker to the OFF position, and contact a qualified service person. Take steps to ensure that the power will not be turned on (by marking "out of service" near the circuit breaker, for instance) until qualified service person arrives. Continuing to use the Air to Air Heat Exchanger in the trouble status may cause mechanical problems to escalate or result in electric shocks or other trouble.
- If there is a danger of the Air to Air Heat Exchanger's falling, do not approach the Air to Air Heat Exchanger but set the circuit breaker to the OFF position, and contact a qualified installer or a qualified service person to refit the unit. Do not set the circuit breaker to the ON position until the unit has been refitted.
- Do not modify the products. Do not also disassemble or modify the parts. It may cause a fire, electric shock or injury.

Relocation

- When the Air to Air Heat Exchanger is to be relocated, do not relocate it yourself but contact a qualified installer or a qualified service person. Failure to relocate the Air to Air Heat Exchanger properly may result in electric shocks and/or a fire.

(*1) Refer to the "Definition of Qualified Installer or Qualified Service Person."

⚠ CAUTION

Cautions about installation (confirm the following cautions.)

- Connect the Air to Air Heat Exchanger to an exclusive power supply of the rated voltage, otherwise the unit may break down or cause a fire.

Cautions about operation











- Do not use this Air to Air Heat Exchanger for special purpose such as preserving food, precision instruments, art objects, breeding animals, car, vessel, etc.
 - Do not touch any switches with wet finger, otherwise you may get an electric shock.
 - If the Air to Air Heat Exchanger will not be used for a considerably long time, turn off the main switch or the circuit breaker, for safety.
 - Prevent any liquid from falling into the remote controller. Do not spill juice, water or any kind of liquid.
 - Do not pour or spray water or detergent on the electric parts. Doing so may cause electric leakage and result in a fire, electric shocks and/or injury.
 - Do not install the unit and inside air intake in a place such as a machine factory, chemical plant, or research institute, where acids, alkaline, organic solvents, or coating materials are handled and toxic gases and/or corrosive gases may be produced. Otherwise, gas poisoning may occur and/or the inside of the unit may be eroded or deteriorated. The deterioration and erosion may result in a fire.
 - Do not use "Bypass mode" when heating the room in winter. Water condensed on the unit may drip onto the ceiling board and may soil the ceiling.
 - Do not use the unit in a place where it is hot (40 °C or higher) or where much oily smoke is produced, and do not directly expose the unit to flame. Doing so may result in a fire.
 - Do not expose animals or plants to the wind from the unit. Doing so may harm the animal or plant.
 - Do not use a flammable spray near the unit or inside air intake. Doing so may result in a fire.
-

■ Disposal

Dispose of Air to Air Heat Exchanger in accordance with the Directive 2012/19/EU WEEE (Waste Electrical and Electronic Equipment).

Information on the transportation, handling and storage of the carton

Examples of indication on the carton

Symbol	Description	Symbol	Description
	Keep dry		Do not drop
	Do not lay down		Stacking height (3 cartons can be stacked in this case)
	This side up		Do not step
	Handle with care		Weight
	Do not roll		Do not clamp

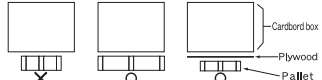
Other cautions	Description
 <div style="border: 1px solid black; padding: 5px;"> <p>Caution</p> <p>Injury possibility. Don't handle with packing band, or may get injured in case of broken band.</p> </div>	<p>CAUTION</p> <p>Injury possibility. Don't handle with packing band, or may get injured in case of broken band.</p>
<div style="border: 1px solid black; padding: 5px;"> <p>Stacking notice.</p> <p>In case that cardboard boxes protrude out of pallet when stacking, lay a 10mm thick plywood over the pallet.</p>  </div>	<p>Stacking notice.</p> <p>In case that cardboard boxes protrude out of pallet when stacking. Lay a 10 mm thick plywood over the pallet.</p>

2 Features

■ Main features

◆ Power saving ventilation

The cost of cooling and heating is reduced thanks to the unit efficiently retrieving thermal energy (outdoor air load) which has been lost during ordinary ventilation.

◆ Space saving

Significant reduction of outdoor air load and the ability to retrieve thermal energy enable the production of smaller air conditioning devices.

◆ Humidity control

When cooling, highly humid outdoor air is conditioned to near the humidity of the dehumidified (cooled) indoor air before being supplied.

When heating, moisture from the indoor air is transferred to the dry outdoor air before the outdoor air is supplied.

◆ Comfortable ventilation

Ventilation without big changes in temperature is realized.

In addition, stable ventilation is possible even in an air tight room due to simultaneous air intake and expulsion.

◆ Sound insulation

Air trunks and heat exchange elements provide sound insulation.

They reduce the incoming of outdoor noise and the outward flow of sounds indoor and help keep the office or shop, and their surroundings quiet.

■ About ventilation modes

The unit has three ventilation modes.

- Heat exchange mode
Exchanging heat between the outdoor and indoor air and making the temperature and humidity of the outdoor air closer to those of the indoor air before supplying it.
- Bypass mode
Outdoor air is taken into a room as it is. This mode is mainly used in spring and summer.
- Automatic mode
 1. For an Air to Air Heat Exchanger system
The heat exchange mode and the bypass mode are automatically switched between following the information from the indoor and outdoor temperature sensors in the unit.
 2. For an Air to Air Heat Exchanger system linked with Air conditioners
The heat exchange mode and the bypass mode are automatically switched between depending on the operation status of the Air conditioner (cooling, heating, dry, fan, or temperature setting) and the information from the indoor and outdoor temperature sensors in the unit.

⚠ CAUTION

If the outdoor temperature becomes about to 15 °C or less in [Automatic mode] or [Bypass mode], the system will automatically start to run in [Heat exchange mode] regardless of the mode setting to prevent condensation in the Air to Air Heat Exchanger.

* The indication of the ventilation mode setting does not change.

3 Standard installation example

■ Concealed microcomputer control type

▼ VN-M1000HE1

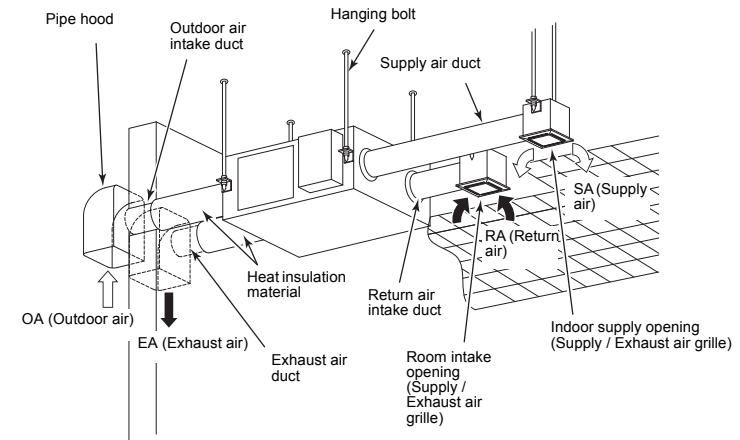

▼ VN-M1500HE1 and VN-M2000HE1

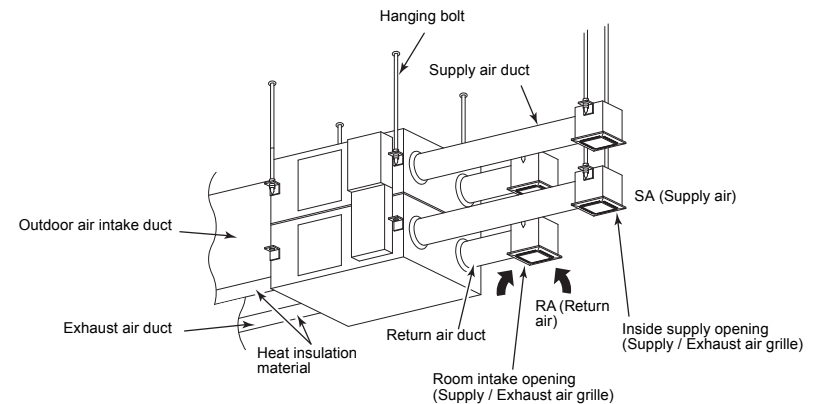

NOTE

The printed indications on the unit become upside-down when the unit is installed upside-down.

4 System configuration

The control method of this product differs depending on the system configuration. Operate it following the methods explained in the system configuration examples below.

- For the actual system configuration, ask your dealer or the installer of the product for information.
- Refer also to the installation manuals and owner's manuals of the remote controllers.
- If you use the central remote controller, refer also to its installation manual and owner's Manual.

System example	Operation	Cautions
<p>A. Air to Air Heat Exchanger system</p> <p>Remote controller for the Air to Air Heat Exchanger NRC-01HE</p>	<ul style="list-style-type: none"> • Using the remote controller for the Air to Air Heat Exchanger NRC-01HE, you can start and stop the unit, control the Ventilation fan speed, and select the ventilation mode. • The remote controllers for the Air conditioner RBC-AMT32E and RBC-AMS55E* are not compatible with the Air to Air Heat Exchanger system. Only ON/OFF operation is available for RBC-AMS41E. <p>For operation details using the remote controller for the Air to Air Heat Exchanger NRC-01HE, see page 12 "6.How to use".</p>	<p>If two remote controllers are used, the latter operation overrides the former and their indications always reflect the result of the latter operation.</p>
<p>B. Air to Air Heat Exchanger system linked with Air conditioners</p> <p>Remote controller for Air conditioner RBC-AMT32E, AMS41E, AMS55E* Remote controller for the Air to Air Heat Exchanger NRC-01HE</p>	<ul style="list-style-type: none"> • The remote controller for the Air conditioner or the Air to Air Heat Exchanger can be used to start / stop the whole system. • The remote controller for the Air conditioner or the Air to Air Heat Exchanger can be used to start / stop the Air to Air Heat Exchanger separately. • However, setting modifications are required for separate control. Contact your dealer for more information. • The remote controller for the Air to Air Heat Exchanger NRC-01HE and the remote controller for Air conditioner RBC-AMS55E* can be used to control the Ventilation fan speed and ventilation mode of the Air to Air Heat Exchanger. • The remote controller for Air conditioner RBC-AMT32E, AMS41E cannot be used to control the Ventilation fan speed or ventilation mode of the Air to Air Heat Exchanger. <p>For operation details using the remote controllers for the Air to Air Heat Exchanger NRC-01HE, see page 12 "6.How to use". For operation details using the remote controller for the Air conditioner RBC-AMS55E*, see page 12 "6.How to use".</p>	<p>If two remote controllers are used, the latter operation overrides the former and their indications always reflect the result of the latter operation.</p>

System example	Operation	Cautions
<p>C. Central control system (When controlling the Air conditioner group and the Air to Air Heat Exchanger group separately)</p> <p>Remote controller for Air conditioner RBC-AMT32E, AMS41E, AMS55E* Remote controller for the Air to Air Heat Exchanger NRC-01HE</p>	<ul style="list-style-type: none"> • The central controller can be used to start / stop the whole system and separately start / stop groups of Air conditioners and the Air to Air Heat Exchangers. (In this system, the Air conditioners and the Air to Air Heat Exchangers are not linked in operation.) • The central controller cannot be used to control the Ventilation fan speed or ventilation mode of the Air to Air Heat Exchanger. • If the remote controller for the Air to Air Heat Exchanger NRC-01HE has been installed, you can start and stop the unit, control the Ventilation fan speed, and select the ventilation mode with the remote controller. • The remote controllers for the Air conditioner RBC-AMT32E and RBC-AMS55E* are not compatible with the Air to Air Heat Exchanger system. Only ON/OFF operation is available for RBC-AMS41E. <p>For operation details using the remote controller for the Air to Air Heat Exchanger NRC-01HE, see page 12 "6.How to use".</p>	<p>If three control devices are used; the central controller and the remote controllers for the Air to Air Heat Exchanger and the Air conditioner, the latter operation overrides the former regardless of which device is used.</p>
<p>D. Central control system (When controlling the Air conditioners and the Air to Air Heat Exchangers together)</p> <p>Remote controller for the Air to Air Heat Exchanger NRC-01HE Remote controller for Air conditioner RBC-AMT32E, AMS41E, AMS55E*</p>	<ul style="list-style-type: none"> • The central controller can be used to start / stop the whole system. It can also be used to start / stop the Air to Air Heat Exchanger separately. • However, setting modifications are required for separate control. Contact your dealer for more information. • The central controller cannot be used to control the Ventilation fan speed or ventilation mode of the Air to Air Heat Exchanger. • If the remote controller for the Air to Air Heat Exchanger NRC-01HE or the remote controller for Air conditioner RBC-AMS55E* has been installed, you can control the Ventilation fan speed and ventilation mode of the Air to Air Heat Exchanger with the remote controller. • The remote controller for Air conditioner RBC-AMT32E, AMS41E cannot be used to control the Ventilation fan speed and ventilation mode of the Air to Air Heat Exchanger. <p>For operation details using the remote controller for the Air to Air Heat Exchanger NRC-01HE, see page 12 "6.How to use". For operation details using the remote controller for the Air conditioner RBC-AMS55E*, see page 12 "6.How to use".</p>	

NOTE

The heat exchange element may smell during the initial period of use. However, this is not a malfunction and the smell is harmless.

5 Part names and functions

■ Concealed microcomputer control type (main unit)

▼ VN-M1000HE1

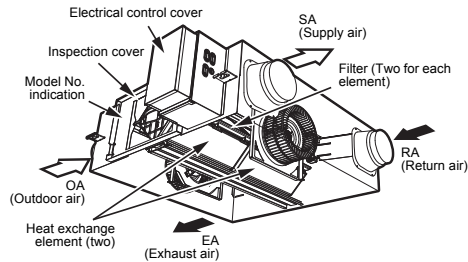

▼ VN-M1500HE1 and VN-M2000HE1

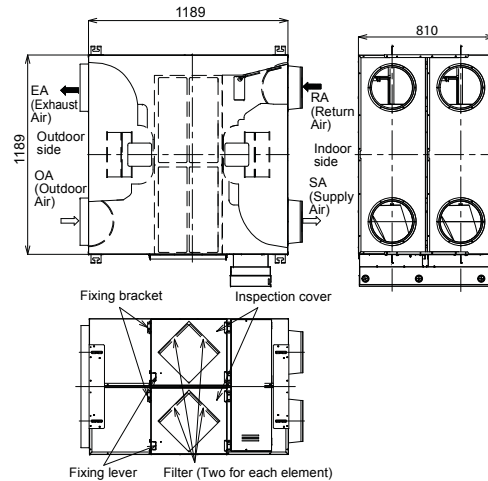
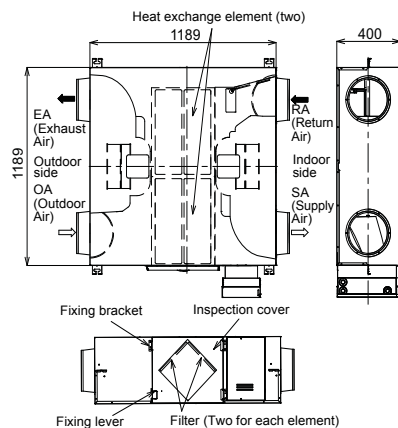
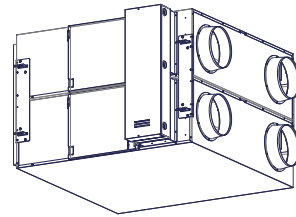

Dimensions of hanging parts are not included.

5-1. Remote controller for the Air to Air Heat Exchanger NRC-01HE

◆ Operation section

- One of these remote controllers can be used to control both indoor Air conditioner units and Air to Air Heat Exchangers (up to 8 units in total).
- After setting the operation conditions, you can use the units by just pressing the ON/OFF button.
- Functions concerning controlling the Air to Air Heat Exchanger are explained here. For controlling an Air conditioner, refer to the owner's manuals supplied with the Air conditioner.

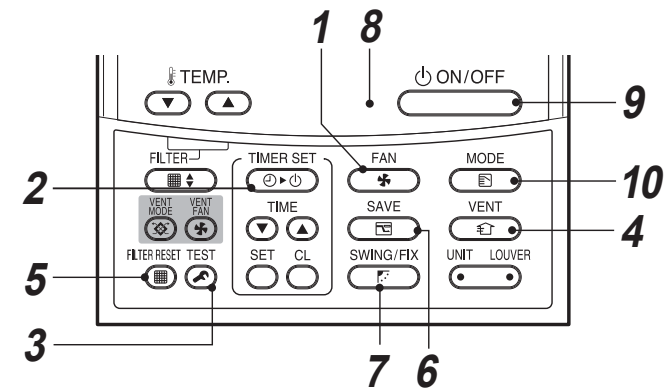
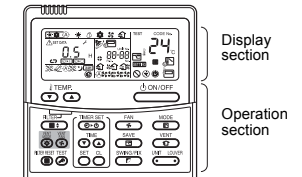

- 1** **FAN button (Fan speed select button) (*1)**
Selects the desired Fan speed.
- 2** **TIMER SET button (Timer set button)**
Used for timer setting
- 3** **TEST button (Test button)**
Used for service.
Do not use this button in everyday operations.
- 4** **VENT button (Ventilation button)**
This button is used when the Air to Air Heat Exchanger is in a system linked with Air conditioners. Push the button to turn on/off the Air to Air Heat Exchanger. Turning on/off the Air conditioner also turn on/off the Air to Air Heat Exchanger.
* No Air to Air Heat Exchanger is connected or separate operation of the Air to Air Heat Exchanger is not set, if "⊖" appears on the remote controller display after pushing the button.
- 5** **FILTER reset button**
Resets "■ FILTER" indication after cleaning.
- 6** **SAVE button (Power save operation) (*1)**
Use to initiate power saving mode.
- 7** **SWING / Louver direction button) (*1)**
Use to select automatic swing or fixed louver position.
* Not available for concealed duct, slim duct, floor concealed and floor standing cabinet fresh air intake types.
- 8** **Operation lamp**
Lights up during operation.
Blinks when a trouble occurs or the protective device activates.
- 9** **ON/OFF button**
Turns on the unit when pressed, and turns it off when pressed again.
- 10** **MODE button (Operation mode select button) (*1)**
Selects desired operation mode.

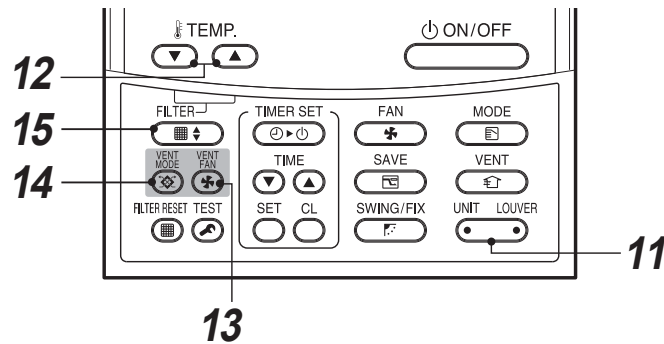

11 button (Unit / Louver select button)

Used for selecting a unit while changing settings if the remote controls two or more units.

UNIT button:

If two or more indoor units are controlled by one remote controller, use this button to select a unit to adjust its air blow direction.

LOUVER button (*1): (4-way cassette type 2H series only)

Selects a louver to control when adjusting the louver lock setting or wind direction setting separately for each louver.

12 button (Temperature set button)(*1)

Adjusts the set temperature.

Select the desired set point by pushing TEMP. .

or TEMP. .

13 button (Ventilation fan speed button)

Used to select the ventilation fan speed

You can stop 24-hour ventilation temporarily by pressing and holding the button for 4 seconds while is displayed.

14 button (Ventilation mode button)

Used to select a ventilation mode.

15 button (Filter elevating button) (*1)

* This function is not available.

OPTION:

Remote controller sensor (*1)

Normally the temperature sensor of the indoor unit senses the temperature. The temperature around the remote controller can also be sensed. For details, contact your dealer.

* Do not use the function when the Air conditioner is controlled in a group.

(*1):

This function is not available for Air to Air Heat Exchanger.

"" will be displayed for few seconds when the unit is running in a system equipped with only the Air to Air Heat Exchanger.

◆ Display section

All indicators are displayed on the display example below for explanation. In reality, only the selected options will be displayed. Indications concerning controlling the Air to Air Heat Exchanger are explained here. For indications concerning an Air conditioner, refer to the owner's manuals supplied with the Air conditioner.

- **SETTING** blinks on the display of the remote controller when the power switch is turned on for the first time. The initial settings progress while **SETTING** is blinking. Start to use the remote controller after **SETTING** has disappeared.

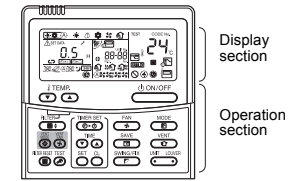

NOTE

The LCD may temporarily be blurred due to static electricity.

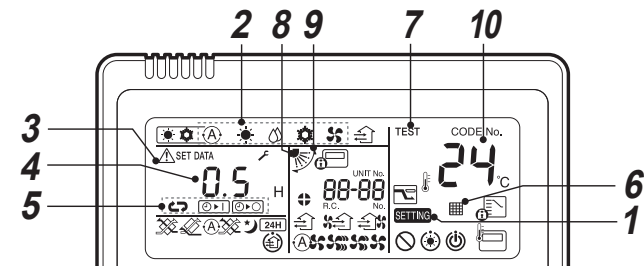

1 **SETTING indicator**

Displayed when setting the timer or other functions.

2 **Operation mode indicator (*1)**

Indicates the operation mode selected.

3 **Check display**

Displayed when the protective device activates or a trouble occurs.

4 **Time indicator**

Indicates time concerning the timer. (Indicates a check code when a trouble occurs.)

5 **Timer mode indicator**

Each time you press the button, the indication changes as follows: , , and no timer indication.

6 **Filter indicator**

Reminder to clean the air filter.

7 **Test run indicator**

Displayed during a test run.

8 **Louver position display (*1)**

Indicates the louver position.

9 **Swing indicator (*1)**

Displayed during up/down movement of the louver.

10 **Set temperature display (*1)**

The selected set temperature is displayed.

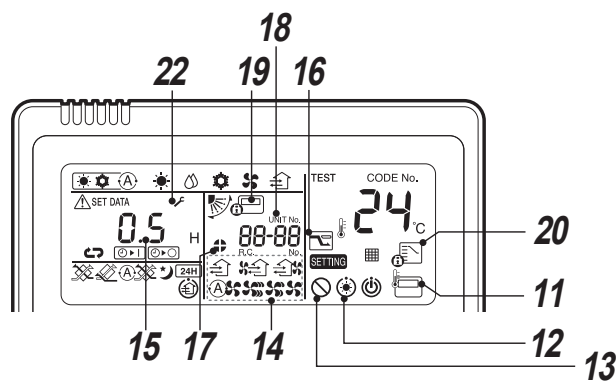

11 Remote controller sensor indicator (*1)

Displayed when the remote controller sensor is used.

12 Pre-heat indicator (*1)

Displayed when the heating mode is energized or defrost cycle is initiated. While this indication is displayed, the indoor fan stops or operate in fan mode.

13 No function indicator

Displayed when the function requested is not available on that model.

14 Fan speed indicator (*1)

Indicates the selected fan speed:

(Auto)	
(High)	
(Medium)	
(Low)	

15 Louver Number display. (*1) (example:01, 02, 03, 04)

16 Power saving mode display (*1)

Displayed during capacity saving mode.

17 Louver lock indicator (*1)

Displayed when a louver is locked. (4-way cassette type only)

18 UNIT No. indicator

The number of the Air to Air Heat Exchanger selected using the UNIT button or that of the unit in which a trouble has occurred.

19 Central control indicator

Displayed when a central control device such as a central controller is also used. If the central control

device prohibits the use of local remote controllers, blinks when any of the , or TEMP. buttons are pressed and the operation is rejected.

The items controllable with the remote differ depending on the mode of central control. Refer to the owner's manual of the central control device you are using for more information

20 Operation mode controlled indicator (*1)

Displayed when MODE button is pushed while operation mode is fixed to cool or heat by the Air conditioner administrator.

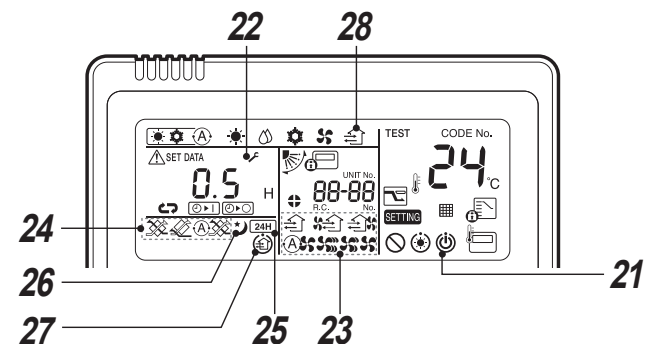

21 Operation ready display (*1)

This display appears on some models.

22 Service display

Displayed while the protective device works or a trouble occurs.

23 Ventilation fan speed indicator

Indicates the ventilation fan's speed. , , or is indicated. When the remote is used to control Air conditioners together with the Air to Air Heat Exchanger as a group, VENT FAN indicator appears (blinks) only when the button is pressed.

(High)

(Low)

(SA > EA)

(SA < EA)

* Displayed when the setting is activated.

24 Ventilation mode indicator

Indicates the selected ventilation mode. , or is indicated.

(Automatic mode)

(Heat exchange mode)

(Bypass mode)

25 24-hour ventilation indicator

Displayed during 24-hour ventilation.

* Displayed when the setting is activated.

26 Nighttime heat purge indicator

Displayed during the nighttime heat purge operation.

* Displayed when the setting is activated.

27 Ventilation on-standby indicator

Displayed while the Air to Air Heat Exchanger is on standby. While this indicator is displayed, the Air to Air Heat Exchanger is not in operation.

* Displayed when the setting is activated.

28 Ventilation indicator

If the remote is used to control the Air to Air Heat Exchanger in the Air to Air Heat Exchanger system linked with Air conditioners, and separate operation of the unit is set to available, the indicator is displayed while the unit is running.

* The indicator is not displayed when the unit is running in a system equipped with only the Air to Air Heat Exchanger.

(*1):

Not displayed. These functions are not available for Air to Air Heat Exchanger.

5-2. Remote controller for the Air conditioner RBC-AMS55E*

For RBC-AMS55E* remote-controller operation, refer also to the Owner's Manual of RBC-AMS55E*.

* For Air to Air Heat Exchanger in a single system, the remote controller is not available.

◆ Detailed display mode

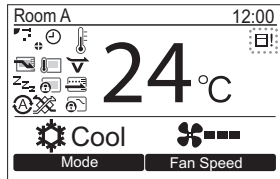

* For a normal display, Air to Air Heat Exchanger icon following below does not appear on the screen.

◆ Switching between the normal display and detailed display

Push and hold the [CANCEL] button and [MONITOR] button at the same time for more than 4 seconds to switch the display mode.

▼ Ventilation icon list

	Automatic mode		24-hour ventilation mode
	Bypass mode		Nighttime heat purge mode
	Total heat exchange mode		

◆ Operation button section

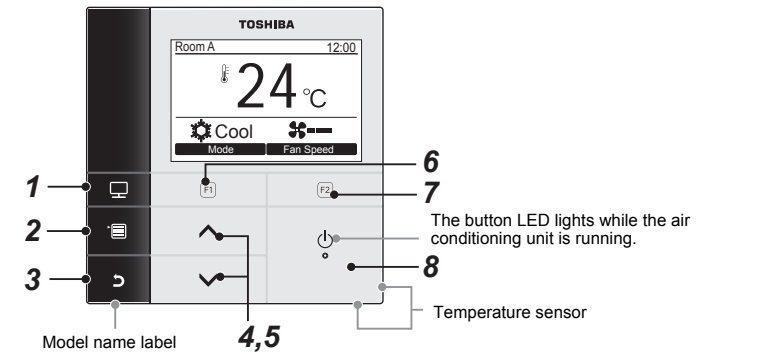

1 [MONITOR] button

Displays the monitoring screen.

2 [MENU] button

Displays the menu screen.

3 [CANCEL] button

Functions as indicated on the screen, such as returning to the previous menu screen.

4 [^ ^] button

During normal operation: adjusts the temperature.
On the menu screen: selects a menu item.

5 [v v] button

During normal operation: adjusts the temperature.
On the menu screen: selects a menu item.

6 [F1] button

Varies its function according to the setting screen.

7 [F2] button

Varies its function according to the setting screen.

8 [ON/OFF] button

◆ Menu items

Push the [MENU] button to display the main menu screen.

Select "11. ventilation" with the [^ ^]/[v v] button to display Air to Air Heat Exchanger setting screen.

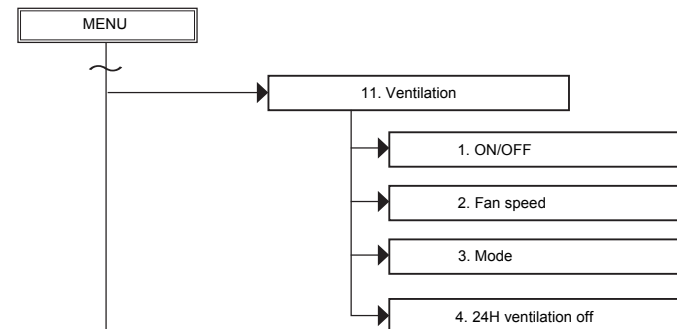

6 How to use

6-1 When using the remote controller for the Air to Air Heat Exchanger (NRC-01HE)

When the Air to Air Heat Exchanger is used for the first time or change the settings, operate the remote following the procedure below.

From the next time, the unit starts running following the set operation conditions by just pressing the button.

◆ Preparation

Turning on the circuit breaker

When turned on, the separation lines appear and **SETTING** blinks on the display of the remote controller.

- * The remote controller will not work for about 1 minute after turning on the power. This is not a malfunction.
- * If an Air to Air Heat Exchanger system linked with Air conditioners is used, turn on the circuit breaker for the Air conditioners too.

REQUIREMENT

- Keep the circuit breaker turned on during use.
- For an Air to Air Heat Exchanger system linked with Air conditioners, when the system is used after a long period of disuse, turn on the circuit breaker of the unit and Air conditioners 12 hours or more before starting operation.

■ Operations

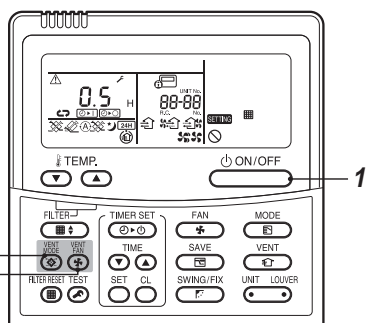

- 1 Push the buttons to start operation. The operation lamp lights up.

REQUIREMENT

Operation will be started when the heat exchange ventilation is in an Air to Air Heat Exchanger system linked with Air conditioners.

- 2 Push the button to select the ventilation fan speed.

Each time the button is pushed, the ventilation fan speed and indication changes as follows.

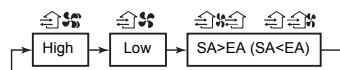

* The indications and are displayed only when the imbalanced ventilation fan speed setting is activated.

REQUIREMENT

As factory default, the imbalanced ventilation fan speed setting is deactivated only [High] and [Low] are available for selection. Consult your dealer to activate the setting.

- 3 Push the button to select a ventilation mode.

Each time the button is pushed, the ventilation mode and indication change as follows:

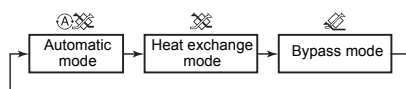

- 4 Push the buttons to stop operation. The operation lamp turns off.

■ About the separate operation of the Air to Air Heat Exchanger in an Air to Air Heat Exchanger system linked with Air conditioners

* The procedure below is not effective in a system equipped with the Air to Air Heat Exchanger only.

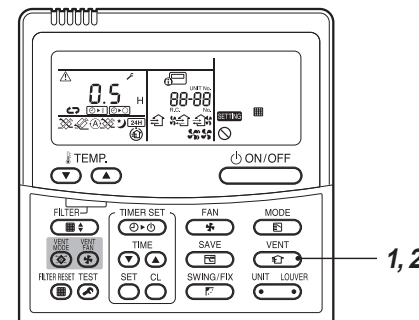

- 1 Push the button while the system is running.

Only the Air to Air Heat Exchanger stops and the indicator turns off.

- 2 Push the button while the system is stopped.

The indicator lights up and the Air to Air Heat Exchanger starts running separately.

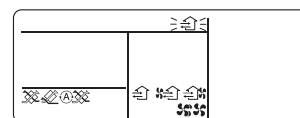

NOTE

- Normally, the Air to Air Heat Exchanger ON/OFF as the Air conditioner is ON/OFF when it is in an Air to Air Heat Exchanger system linked with Air conditioners.
- If " " is displayed when the button is pushed, certain settings need to be changed to operate the unit separately. Consult your dealer to change the settings.

■ Functions

About ventilation modes

* For details, see "About ventilation modes" on page 6. [Heat exchange mode], [Bypass mode] or [Automatic mode] can be selected.

About imbalanced ventilation fan speed ([SA>EA]/ [SA<EA])

For normal ventilation (High or Low):

The volumes of the indoor air supply and outdoor air exhaustion are set to the same level.

For imbalanced ventilation fan speed:

- When [SA>EA] is selected: the volume of the indoor air supply is larger than that of the outdoor air exhaustion. (Inflow of humidity and smells from the toilet and kitchen is reduced.)
 - When [SA<EA] is selected: the volume of the outdoor air exhaustion is larger than that of the indoor air supply. (Outflow of smells and floating bacteria into a corridor or other places is reduced.)
- * Consult your dealer if the setting of the imbalanced ventilation fan speed seems incorrect.

About 24-hour ventilation

- When the 24-hour ventilation setting is active, press the button while the system is running and the operation lamp turns off, appears on the display, and 24-hour ventilation starts.
- Press and hold the button for 4 seconds or more while the indicator is displayed to stop 24-hour ventilation temporarily. The indicator turns off and 24-hour ventilation stops temporarily.

NOTE

- The setting of 24-hour ventilation is "OFF" as factory default. Consult your dealer to change the setting to "ON".
- The settings of or cannot be changed during 24-hour ventilation. Their indicators are not displayed.
 - * During 24-hour ventilation, the unit is running intermittently (stops for 60 minutes after running for 60 minutes) under the settings [LOW] ventilation fan speed and [Heat exchange mode].
- While 24-hour ventilation is running, the indicator stays lit even during the intervals.

About nighttime heat purge operation

- Nighttime heat purge is a function to reduce the room air conditioning load in the morning in summer by exhausting the air indoor which has become warm while the Air conditioner is stopped in the night automatically in the Bypass mode.
- The nighttime heat purge operation functions if night purge is activated and the last operation mode of the Air conditioner before stopping is or in an Air to Air Heat Exchanger system linked with Air conditioners. If the button is pushed while the system is running, the operation lamp turns off, appears on the display, and the nighttime heat purge operation turns on-standby. After the operation becomes on-standby, the unit automatically starts ventilation in [Low] ventilation fan speed and [Bypass mode] when the conditions to start the nighttime heat purge operation below are fulfilled. The nighttime heat purge operation is paused for one hour if any of the conditions to pause the operation are detected. If the conditions to start the nighttime heat purge operation are fulfilled one hour after the pause, the operation will start again. If not, the operation will remain paused for one more hour. This cycle is repeated until the conditions to stop (end) the nighttime heat purge operation below are fulfilled.

The conditions to start the nighttime heat purge operation

The unit compares temperatures indoor and outdoor using the monitoring operation (for about 5 minutes) and will start the nighttime heat purge operation if the following conditions are fulfilled.

1. A certain amount of time has passed between the nighttime heat purge operation becoming on-standby and the monitoring operation starting. (The time is set between 1- 48 hours in 1 hour steps.)
2. The indoor temperature is 3 °C or more higher than the outdoor temperature and the indoor temperature is 2 °C or more higher than the temperature set for the operation.

The conditions to pause the nighttime heat purge operation (the operation pauses for one hour.)

1. The indoor temperature is the same or lower than the outdoor temperature, the indoor temperature is the same or lower than the temperature set for the operation, or one hour has passed since the nighttime heat purge operation started.

The conditions to stop (end) the nighttime heat purge operation

The nighttime heat purge operation ends and the indicator disappears if any of the following conditions are fulfilled.

1. The Air conditioner or Air to Air Heat Exchanger is started.
2. 48 hours has passed since the monitoring operation started.

NOTE

- The setting of the nighttime heat purge operation is "OFF" As factory default. Consult your dealer to change the setting to "ON" or the setting of the time until the monitoring operation starts.
- The settings of or cannot be changed during the nighttime heat purge operation. Their indicators are not displayed.
- The indicator stays lit while the operation is on-standby or paused.
- The nighttime heat purge operation cannot be activated if 24-hour ventilation is activated.

CAUTION

The nighttime heat purge operation is not executed if the outdoor temperature becomes about 15°C or less to prevent condensation in the Air to Air Heat Exchanger, but the indicator is still lit.

6-2. When using the remote controller for the Air conditioner (RBC-AMS55E*)

Set for the ventilation operation linked to the Air conditioner.

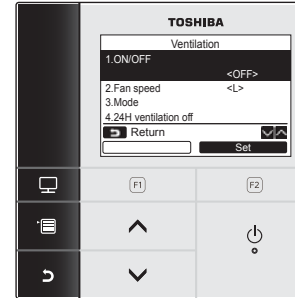

- 1 Select "11. Ventilation" on the menu screen, then push the " Set" [F2 F2] button.
- 2 Push the [^] / [v] button to select the item to set.
- 3 Push the " Set" [F2 F2] button.

Item	Function
1. ON/OFF	The run and stop operation of ventilation
2. Fan speed	Setting of the fan speed
3. Mode	Setting of the ventilation mode
4. 24H ventilation off	Setting of 24H ventilation operation stop time.

1.ON/OFF

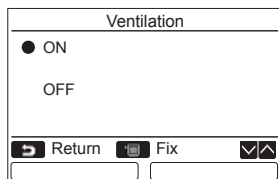
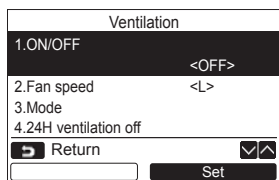

1 Push the [] / [] button to select "1. ON/OFF" on the "Ventilation" screen, then push the " Set" [F2] button.

2 Push the [] / [] button to select "ON" or "OFF".

- Select "OFF" on the "1. ON/OFF" setting while operating the Air conditioner.
 - * Only Air to Air Heat Exchanger will stop.
 - * For the detailed display, ventilation mode display disappears on the screen.
- Select "ON" on the "1. ON/OFF" setting while stopping the Air conditioner.
 - * Air to Air Heat Exchanger starts the single operation.
 - * For the detailed display, ventilation mode display disappears on the screen.

NOTE

- Normally, when the Air conditioner operates and stops, Air to Air Heat Exchanger also simultaneously operates and stops.
- If " Impossible" appears on the screen when "1. ON/OFF" has been set, contact the dealer where you purchased the Air conditioner to change the setting.

3 Push the [MENU] button.

→The screen returns to the "Ventilation setting" screen.

2. Fan speed

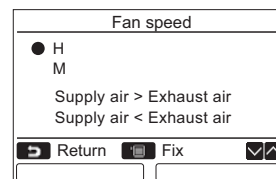
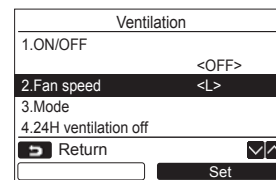

1 Push the [] / [] button to select "2. Fan speed" on the "Ventilation" screen, then push the " Set" [F2] button.

- " Impossible" appears on the display when 24H-hour ventilation, or nighttime heat purge is being operated while Air to Air Heat Exchanger is stopped.

2 Push the [] / [] button to select "Fan speed".

- If an unbalance setting of ventilation air volume (Supply air > Exhaust air, Supply air < Exhaust air) has not been carried out during installation, its settings (Supply air > Exhaust air, Supply air < Exhaust air) can not be selected by the remote controller.

NOTE

- Ventilation air volume setting is not available (only High (H) or Middle (M)) at the factory default. Contact the dealer where you purchased the Air conditioner to set the Ventilation air volume (Supply air > Exhaust air, Supply air < Exhaust air).

3 Push the [MENU] button.

→The screen returns to the "Ventilation setting" screen.

3. Mode

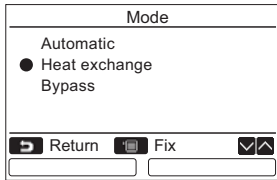
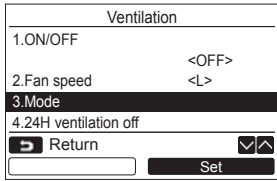

4. 24H ventilation off

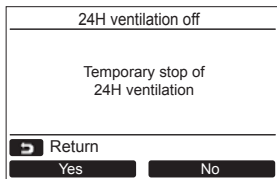
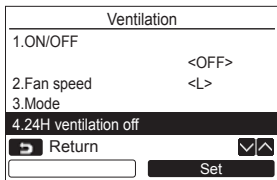

1 Push the [▲ ▲] / [▼ ▼] button to select "3. Mode" on the "Ventilation" screen, then push the "Set" [F2] button.

2 Push the [▲ ▲] / [▼ ▼] button to select "Mode".

- "Impossible" appears on the screen when 24H-hour ventilation, or nighttime heat purge is being operated while Air to Air Heat Exchanger is stopped.

3 Push the [MENU] button.
→The screen returns to the "Ventilation setting" screen.

1 Push the [▲ ▲] / [▼ ▼] button to select "4. 24H ventilation off" on the "Ventilation" screen, then push the "Set" [F2] button.

- "Impossible" appears on the screen when Air to Air Heat Exchanger is not on the 24H ventilation operation.

2 Push the "Yes" [F1] button.

NOTE

- 24H ventilation operation setting is OFF at the factory default. Contact the dealer where you purchased the Air conditioner to set the 24H ventilation to ON.

3 Push the [MENU] button.
→The screen returns to the "Ventilation setting" screen.

7 Timer operation

For Timer operation in the remote controllers for the Air conditioner RBC-AMT32E, AMS41E and AMS55E*, refer to the Owner's Manual of the respective remote controllers. Select a timer type from the following three: (Max. 168 hours)

- OFF timer** : Stops running after a specified period.
- Repeat-OFF timer** : Stops running after a specified period every time the unit is used.
- On timer** : Starts running after a specified period.

Setting the timer

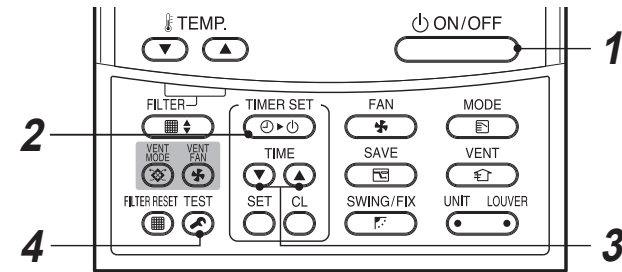

1 Push the ON/OFF button to start operation. The operation lamp lights up.

2 Push the TIMER SET button. Each time the button is pushed, the timer mode and indication change in the following order:

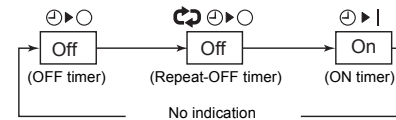

SETTING and the time indication blink.

3 Push the TIME buttons to set the period of time until the timer actions.

- The time setting increases in 0.5-hour (30 minute) increments each time ▲ is pushed. The setting increases in 1-hour increments if it is over 1 day (24 hours). The maximum is 7 days (168 hours). On the remote controller, settings between 0.5 hours and 23.5 hours (*1) are displayed as is. For settings over 24 hours (*2), the days and hours are displayed.
- The time setting decreases in 0.5-hour (30 minute) decrements (0.5 hours to 23.5 hours) or 1-hour decrements (24 hours to 168 hours) each time ▼ is pushed.

Example of indication on the remote controller

• 23.5 hours (*1)

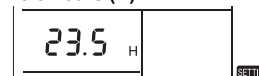

• 34 hours (*2)

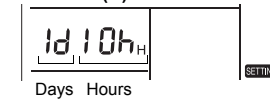

1d indicates 1 day (24 hours).
10h indicates 10 hours. (Total: 34 hours)

4 Push the SET button.

- SETTING disappears, the time indication is displayed, and ◀▶ or ▶▶ flashes. (When using the ON timer, all indications other than the time indication and ▶▶ turn off.)

Canceling the timer

1 Push the ON/OFF button. The timer indicator disappears.

NOTE

- When using the Repeat-OFF timer, pressing the ON/OFF button after the unit has been stopped by the timer starts it running again, and the unit will stop again after the specified period.
- When 24-hour ventilation or the nighttime heat purge operation is activated, the unit is running the activated operation while the unit stops following the timer setting.

8 Maintenance

■ Maintenance of the filter and heat exchange element

⚠ WARNING

Cleaning the filter and heat exchange element involves dangerous work in high places, have a qualified installer or qualified service person to do it.
Do not attempt it by yourself.

⚠ CAUTION

Do not push buttons with wet hands.
Doing so may result in electric shock.

◆ Cleaning the filters

- 1 Clean the filter if “” is indicated on the remote controller.
- 2 Press the “” button after cleaning the filter. The “**FILTER RESET**” indicator disappears.

* If the filter or heat exchange element is clogged, the ventilation amount is reduced and ventilation effect will be deteriorated.

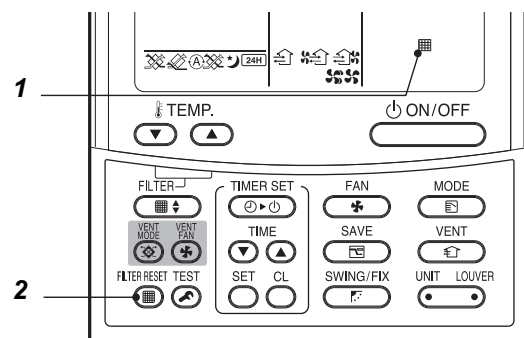

⚠ CAUTION

Cleaning remote controller

- Use a dry cloth to wipe the remote controller.
- Do not use a damp cloth on the remote controller.
- Do not use a chemically-treated duster for wiping or leave such materials on the unit for long.
It may damage or fade the surface of the unit.
- Do not use benzine, thinner, polishing powder, or similar solvents for cleaning.
These may cause the plastic surface to crack or deform.

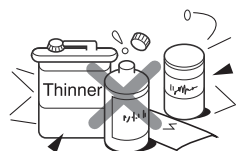

9 Specifications

■ Concealed microcomputer control type



Item	Fan Speed	Model No.	VN-M1000HE1	VN-M1500HE1	VN-M2000HE1
		Power Supply (V)			
		220-240 V~, 50 Hz			
Power consumption (W)	Heat Exchange Mode	(Extra high)	390	640	780
		High	340	570	680
		Low	190	320	380
	Bypass Mode	(Extra high)	390	640	780
		High	340	570	680
		Low	190	320	380
Current (A)	Heat Exchange Mode	(Extra high)	2.40	3.69	4.50
		High	2.12	3.31	3.95
		Low	1.25	1.93	2.29
	Bypass Mode	(Extra high)	2.40	3.69	4.50
		High	2.12	3.31	3.95
		Low	1.25	1.93	2.29
Maximum running Current (A)	Heat Exchange Mode	(Extra high)	2.70	5.08	5.08
		High	2.55	4.77	4.77
		Low	1.71	3.13	3.13
	Bypass Mode	(Extra high)	2.70	5.08	5.08
		High	2.55	4.77	4.77
		Low	1.71	3.13	3.13
Air Volume (m ³ /h)	(Extra high)	1000	1500	2000	
	High	1000	1500	2000	
	Low	700	1200	1400	
External Static Pressure (Pa)	Heat Exchange Mode	(Extra high)	105	140	105
		High	80	110	80
		Low	70	80	70
	Bypass Mode	(Extra high)	105	140	105
		High	80	110	80
		Low	70	80	70

Item	Model No.		VN-M1000HE1	VN-M1500HE1	VN-M2000HE1
	Fan Speed				
Sound pressure level (dB(A))	Heat Exchange Mode	(Extra high)	38.0	41.0	41.5
		High	37.0	40.0	40.5
		Low	33.0	36.0	36.5
	Bypass Mode	(Extra high)	38.0	41.0	41.5
		High	37.0	40.0	40.5
		Low	33.0	36.0	36.5
Temperature Exchange Efficiency (%)	(Extra high)	73.5	76.5	73.5	
	High	73.5	76.5	73.5	
	Low	77.0	79.0	77.5	
Enthalpy exchange Efficiency (%)	for heating	(Extra high)	68.5	71.0	68.5
		High	68.5	71.0	68.5
		Low	71.5	73.5	72.0
	for cooling	(Extra high)	60.5	64.0	60.5
		High	60.5	64.0	60.5
		Low	64.5	67.0	65.5
External dimensions (Length x Width x Height) (mm)			1189 x 1189 x 400	1189 x 1189 x 810	1189 x 1189 x 810
Product weight (kg)			62	126	126
Applicable duct nominal diameter (mm)			Ø250	indoor side: Ø250 outdoor side: 283*730	

* Sound pressure level is less than 70 dBA

10 Before calling for service

Check the points described below before asking for repair servicing.

Symptom	Cause
Operation does not start after pressing the button.	• Is the circuit breaker turned off?
	• Has a power failure occurred?
The unit runs though the operation lamp does not turn on.	• Does the  indicator light up? (The ventilation delay setting is set to "ON" and it is not malfunction. The Air to Air Heat Exchanger will start running after the time set has passed. Consult your dealer for details.)
	Does the  or  indicator appear on the display? The nighttime heat purge operation or 24-hour ventilation is set to "ON". See page 12 for how to use the functions. Consult your dealer to change the setting to "OFF".
The unit starts running without any operation of the remote controller.	Has the unit just recovered from a power failure or have you just turned on the circuit breaker? (The settings concerning recovering from power failure are set to "ON". Consult your dealer for details.

11 Troubleshooting

CAUTION

If any of the following conditions occur, turn off the main power supply switch and immediately contact the dealer:

- Switch operation does not work properly.
- The main power fuse often blows out, or the circuit breaker is often activated.
- A foreign matter or water fall indoor the Air to Air Heat Exchanger.
- When the Air to Air Heat Exchanger does not operate even after the cause of the protective device activation has been removed.
(The operation lamp and \curvearrowright on the remote controller are flashing. When \curvearrowright and a combination of E, F, H, L, or P and a number are displayed on the remote controller, also inform a qualified service person of the display content.)
- Any other unusual conditions are observed.

Confirmation and check

When a trouble occurred in the Air to Air Heat Exchanger, the check code and the unit No. of the Air to Air Heat Exchanger appear on the display part of the remote controller.

The check code is only displayed during the operation.
If the display disappears, operate the Air to Air Heat Exchanger according to the following "Confirmation of trouble history" for confirmation.

* Unit No. of the Air to Air Heat Exchanger is 31-**.

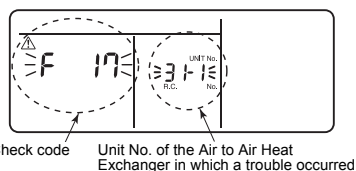

Confirmation of trouble history

When a trouble occurred on the Air to Air Heat Exchanger, the trouble history can be confirmed with the following procedure. (The trouble history is stored in memory up to 4 troubles.)

The history can be confirmed from both operating status and stop status.

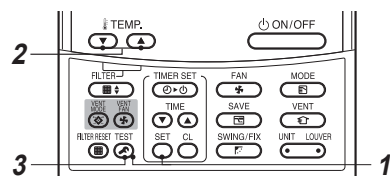

Procedure	Description
1	<p>When pushing SET and TEST buttons at the same time for 4 seconds or more, the following display appears.</p> <p>If [\curvearrowright Service check] is displayed, the mode enters in the trouble history mode.</p> <ul style="list-style-type: none"> • [01 : Order of trouble history] is displayed in CODE No. window. • [Check code] is displayed. • [Unit No. of the Air to Air Heat Exchanger in which a trouble occurred] is displayed in UNIT No.. <p>* Unit No. of the Air to Air Heat Exchanger is 31-**.</p>
2	<p>Every pushing of [\updownarrow / $\leftarrow\rightarrow$] button used to set temperature, the trouble history stored in memory is displayed in order.</p> <p>The numbers in CODE No. indicate CODE No. [01] (latest) to [04] (oldest).</p> <p>CAUTION Do not push ON/OFF button because all the trouble history of the Air to Air Heat Exchanger will be deleted.</p>
3	<p>After confirmation, push TEST button to return to the usual display.</p>

1. Check the troubles according to the above procedure.
2. Ask an authorized dealer or qualified service (maintenance) professional to repair or maintain the Air to Air Heat Exchanger.
3. More details of the check code are explained in Installation Manual.

Declaration of Incorporation of Partly Completed Machinery

Manufacturer: TOSHIBA CARRIER CORPORATION
336 Tadehara, Fuji-shi, Shizuoka-ken 416-8521 JAPAN

TCF holder: TOSHIBA CARRIER EUROPE S.A.S
Route de Thil
01120 Montluel FRANCE

Hereby declares that the machinery described below:

Generic Denomination: Air to Air Heat Exchanger

Model / type: VN-M1000HE1
VN-M1500HE1
VN-M2000HE1

Commercial name: Air to Air Heat Exchanger

Complies with the provisions of the "Machinery" Directive (Directive 2006/42/EC) and the regulations transposing into national law.

Must not be put into service until the final machinery into which it is to be incorporated has been declared in conformity with the provisions of Machinery Directive, where appropriate.

NOTE

This declaration becomes invalid if technical or operational modifications are introduced without the manufacturer's consent.

TOSHIBA CARRIER CORPORATION

336 TADEHARA, FUJI-SHI, SHIZUOKA-KEN 416-8521 JAPAN

EB21907401