

Model name:

RB-RWS21-E



- Read this manual before using the RB-RWS21-E remote controller.
- Refer to the Installation Manual supplied with the indoor unit for any installation instructions other than operations of the remote controller.

Contents





| | | |
|----------|---|-----------|
| 1 | Precautions for Safety | 2 |
| 2 | Accessory Parts | 3 |
| 3 | Installation | 4 |
| | Requirements to install the remote controller | 4 |
| | Install the remote controller | 6 |
| | Wire the remote controller | 7 |
| | Requirements for installing two remote controllers | 7 |
| | Note | 8 |
| 4 | Part Names and Functions | 9 |
| | Monitor screen | 10 |
| 5 | Initial setting | 11 |
| | 1. Clock | 11 |
| | 2. Name of room | 12 |
| | 3. Screen contrast | 13 |
| | 4. Backlight | 14 |
| | 5. Key lock | 15 |
| | 6. Header/Follower | 16 |
| | 7. Language | 17 |
| | 8. Press & hold 4sec. | 18 |
| | 9. Clock display | 19 |
| 6 | Field setting menu | 20 |
| | 1. Test mode | 20 |
| | 2. Register service info. | 22 |
| | 3. Alarm history | 26 |
| | 4. Monitor function | 27 |
| | 5. Setting louver position | 28 |
| | 6. FC setting | 29 |

1 Precautions for Safety

- Read these “Precautions for Safety” carefully before installation.
- The precautions described below include important items regarding safety. Observe them without fail. Understand the following details (indications and symbols) before reading the body text, and follow the instructions.
- Ask customer to keep this Manual at accessible place for future reference.

| Indication | Meaning of Indication |
|--|---|
|  WARNING | Text set off in this manner indicates that failure to adhere to the directions in the warning could result in serious bodily harm (*1) or loss of life if the product is handled improperly. |
|  CAUTION | Text set off in this manner indicates that failure to adhere to the directions in the caution could result in minor bodily injury (*2) or damage (*3) to property if the product is handled improperly. |





*1: Serious bodily harm indicates loss of eyesight, injury, burns, electric shock, bone fracture, poisoning, and other injuries which leave aftereffect and require hospitalization or long-term treatment as an outpatient.
 *2: Bodily injury indicates injury, burns, electric shock, and other injuries which do not require hospitalization or long-term treatment as an outpatient.
 *3: Damage to property indicates damage extending to buildings, household effects, domestic livestock, and pets.

| Symbols | Meaning of Symbols |
|---|--|
|  | “  ” Indicates prohibited items. The actual contents of the prohibition are indicated by a picture or text placed inside or next to the graphic symbol. |
|  | “  ” Indicates compulsory (mandatory) items. The actual contents of the obligation indicated by a picture or text placed inside or next to the graphic symbol. |

 **WARNING**

| | |
|---|--|
|  | <ul style="list-style-type: none"> • Only a qualified installer or service person is allowed to do installation work. Inappropriate installation may result in water leakage, electric shock or fire. • Perform installation work properly according to the Installation Manual. Inappropriate installation may result in water leakage, electric shock or fire. • Electrical work must be performed by a qualified electrician in accordance with this installation manual. The work must satisfy all local, national and international regulations. Inappropriate work may result in electric shock or fire. • Use predefined wire and connect them certainly. Keep the connecting terminal free from external force. Improper wire connection or clamping may result in exothermic, fire or malfunction. |
|---|--|

2 Accessory Parts

| No. | Part name | | Quantity |
|-----|--------------------------------------|---|----------|
| (1) | Screws M4 x 20 |  | 2 |
| (2) | Wood screws M3.8 x 16 |  | 2 |
| (3) | Owner's Manual |  | 1 |
| (4) | Installation Manual (This manual) |  | 1 |
| (5) | CD-ROM | | 1 |

3 Installation

■ Requirements to install the remote controller

◆ Installation place

- Install the remote controller at a height of 1 to 1.5 m from the floor so that the average temperature in the room can be detected.
- Do not install the remote controller in a place exposed to direct sunlight or direct outside air, such as the side of a window.
- Do not install the remote controller in a place behind something or to the rear side of an object, where air flow is not sufficient.
- Do not install the remote controller in a freezing box or refrigerator, as the remote controller is not waterproof.
- Install the remote controller vertically to the wall.

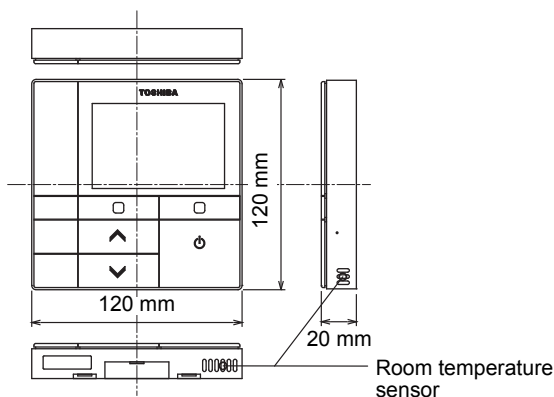

◆ Installation dimension

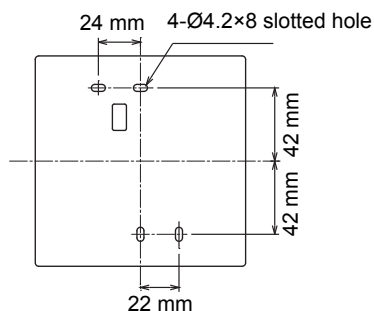

◆ Remote control wiring and inter-unit wiring between remote controllers

Do not allow the wire for the remote controller (communication wire) and the wire for AC220-240 V to come into contact or put them together in one electrical conduit; otherwise, the control system may have trouble due to noise.

| Wiring type | VCTF: 0.5 mm ² to 2.0 mm ² x 2 | |
|-------------|--|---------------------|
| | Total length of remote control wiring and inter-wiring between remote controllers (L+L1) | 1 remote controller |
| Up to 500 m | | Up to 300 m |

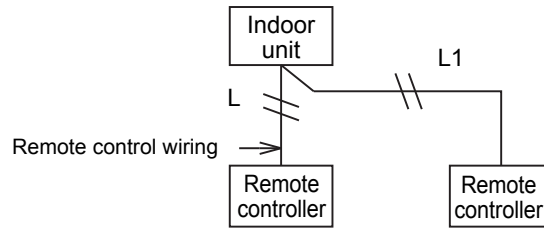

◆ Installation of multiple remote controllers

To install two or more adjacent remote controllers, follow the instructions in the Fig. 1 and 2.

(Fig. 1)

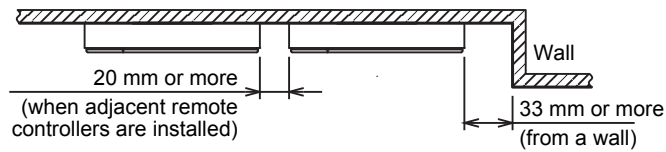

(Fig. 2)

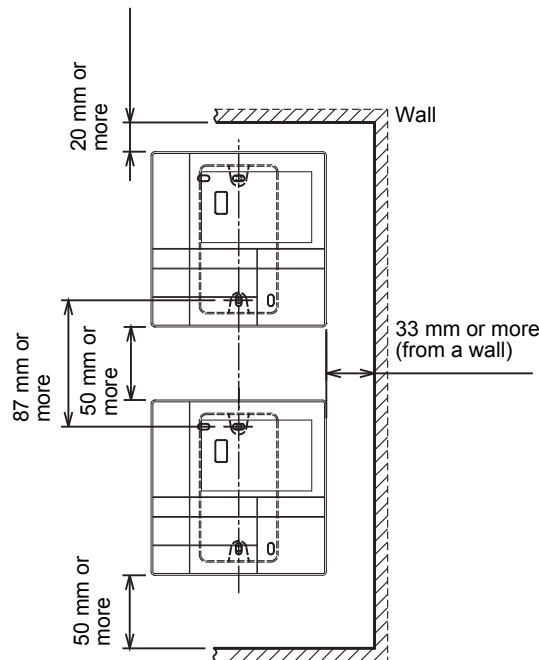

■ Install the remote controller

NOTE

- Wiring for the remote controller should not be bundled or installed in the same conduit with a power cable.; otherwise, malfunction may result.
- Install the remote controller away from sources of electrical interference and electromagnetic fields.

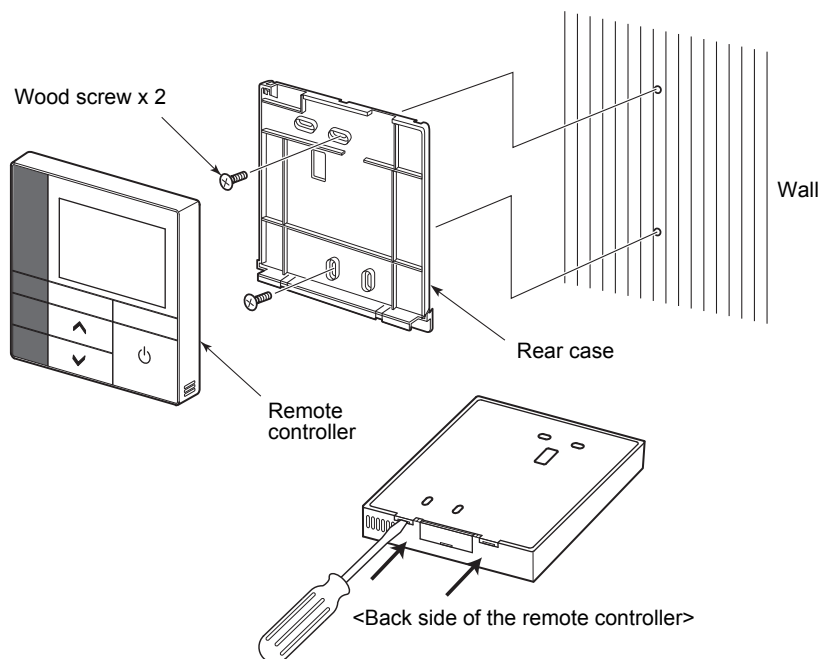

- 1** Insert a flat-blade screwdriver into the groove on the back side of the remote controller to remove the rear case.
- 2** Use the wood screws (2 pieces) supplied with the remote controller to attach the rear case of the remote controller to the wall.
Do not use an electrical screwdriver. Do not over-tighten the screw (Tightening torque is up to 2 kg / f·cm.); otherwise, the rear case may be damaged.
- 3** Connect the electrical wire from the indoor unit to the terminal block of remote controller.
(Refer to “■ Wire the remote controller”.)
**Check the terminal number of electrical wire from the indoor unit to avoid miswiring.
(If AC 220-240 V is applied, the remote controller and indoor unit will break down.)**

■ Wire the remote controller

Wiring diagram

Terminal block for the remote control wiring on the indoor unit

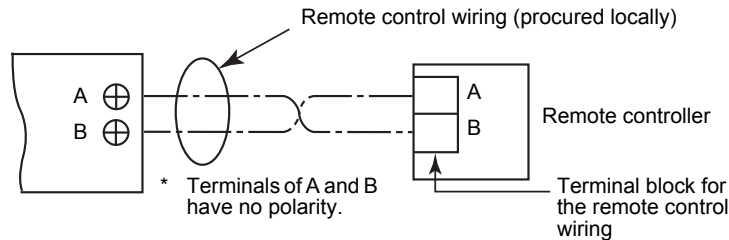

- * Use wire of 0.5 mm² to 2.0 mm².
- * A crimp-style terminal cannot be used.

■ Requirements for installing two remote controllers

In the dual remote controller system, one or more units are operated from two remote controllers. (Up to two remote controllers can be installed.)

Set the Follower remote controller

Set from "6. Header/Follower" in "Initial setting" on the MENU screen.
For details, refer to the page 16.

Install the remote controllers

For the dual remote controller system, install the remote controllers as follows:

Set one remote controller as the Header remote controller.

(The remote controllers are set as "Header remote controller" as factory default.)

Basic wiring diagram

NOTE

Terminals of A and B have no polarity.

To diverge from the indoor unit

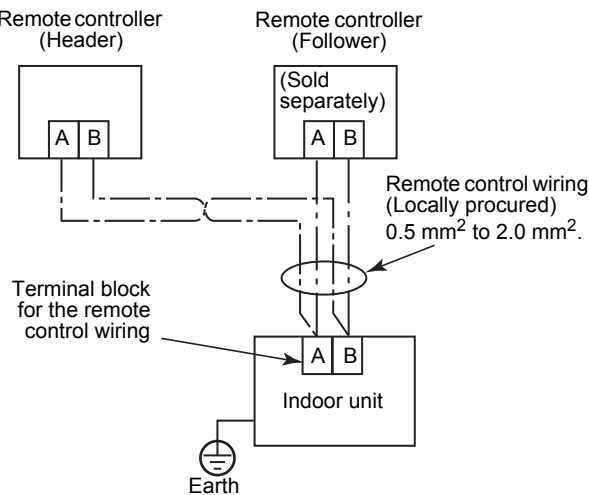

To diverge from the Header remote controller

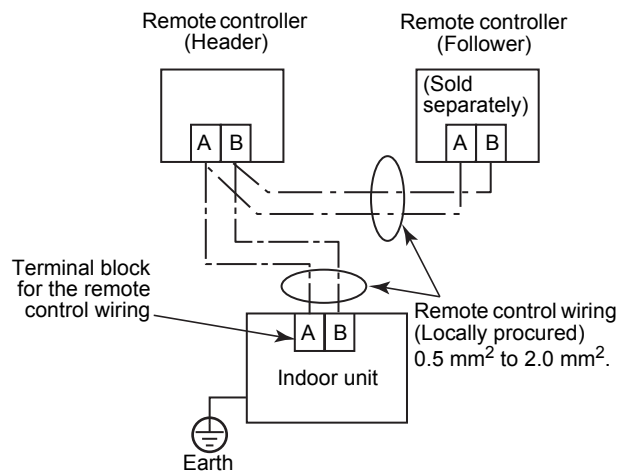

Note

- It takes some time before the remote controller becomes operable when the power is turned on. This is not a malfunction.

<When the power is turned on the remote controller>

It takes about 1 minute before the remote controller becomes operable.

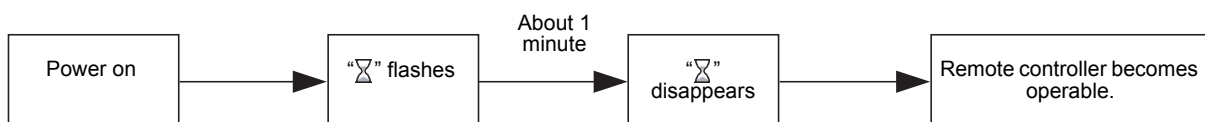

- For the operation of switching the room temperature sensor and the settings of the test operation, refer to the page 20.

4 Part Names and Functions

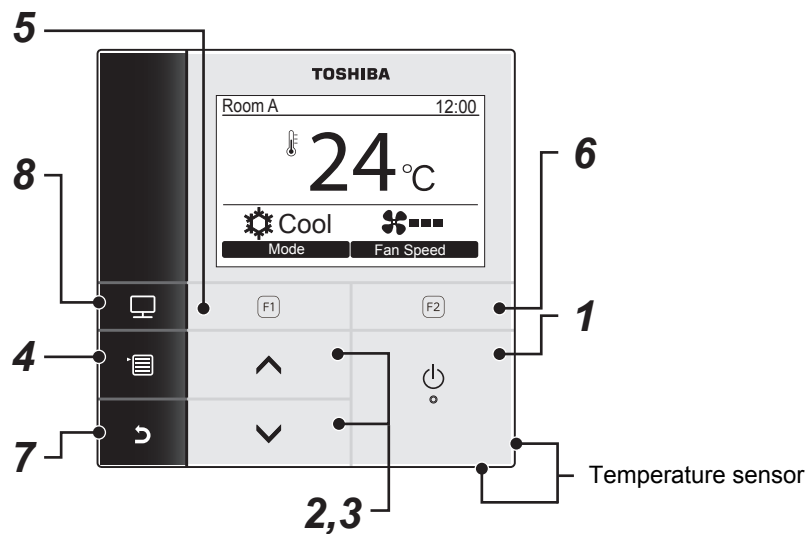

- | | |
|--|---|
| <p>1 [] ON / OFF button</p> <p>2 [] button During normal operation: adjusts the temperature. On the menu screen: selects a menu item.</p> <p>3 [] button During normal operation: adjusts the temperature. On the menu screen: selects a menu item.</p> <p>4 [] MENU button Displays the menu screen.</p> | <p>5 [] F1 button Varies its function according to the setting screen.</p> <p>6 [] F2 button Varies its function according to the setting screen.</p> <p>7 [] CANCEL button Functions as indicated on the screen, such as returning to the previous menu screen.</p> <p>8 [] MONITOR button Displays the monitoring screen.</p> |
|--|---|

■ Monitor screen

Check the current usage status.

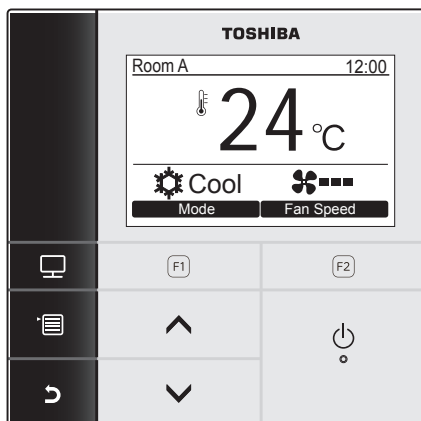

- 1** Push [MONITOR] button.
The monitor screen appears.
- 2** Push [CANCEL] button to return.

| Monitor | |
|---|-------|
| (1) Set temp. | 24°C |
| (2) Control temp. | 24°C |
| (3) Outdoor temp. | 35°C |
| (4) Filter remaining hour | 2500 |
| (5) Total running hour | 10480 |
| Return | |
| <input type="text"/> <input type="text"/> | |

- (1) Displays the set temperature.
- (2) Displays the temperature measured by the room temperature sensor of the indoor unit.
If the sensor is set to that of the remote controller, the temperature measured by the remote sensor is displayed.
- (3) Displays the temperature around the vent of the outdoor unit.
- (4) Displays the remaining time until the filter sign lights up.
- (5) Displays the accumulated operating time.

NOTE

Total running hour

- The Total running hour is recorded on the remote controller.
- The time is not recorded during Self cleaning operation or fan operation.

Outdoor temp.

- Displays the temperature around the vent of the outdoor unit.
- The displayed temperature may differ from the actual outdoor temperature.

Filter remaining hour

- The filter remaining hour is not displayed when the filter cleaning timer of the indoor unit is not set.

5 Initial setting



- 1** Push the [MENU] button to display the menu screen.
- 2** Push the [^]/[v] button to select “9.Initial setting” on the menu screen, then push the “ Set” [F2 F2] button.
- 3** Push the [^]/[v] button to select an item on the “Initial setting” screen.
- 4** Push the “ Set” [F2 F2] button.
→The selected menu setting screen will be displayed.
- 5** Push the [CANCEL] button to return.
→The screen returns to the “Initial setting” screen.

1. Clock

Set the Year, Month, Day, and time.

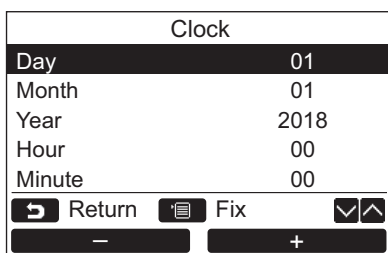
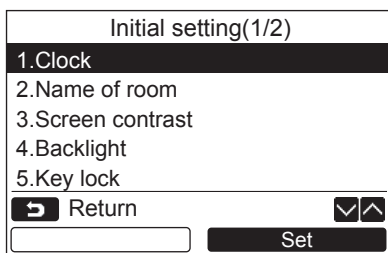

- 1** Push the [^]/[v] button to select “1. Clock” on the “Initial setting” screen, then push the “ Set” [F2 F2] button.
- 2** Push the [^]/[v] button to select the Year, Month, Day, and time.
→Push the “ -” [F1 F1] / “ +” [F2 F2] button to set the value.
- 3** Push the [MENU] button.

To adjust the clock

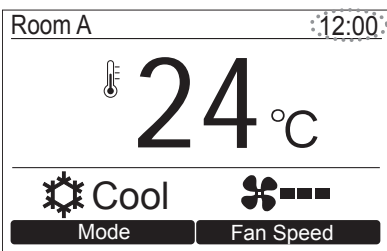
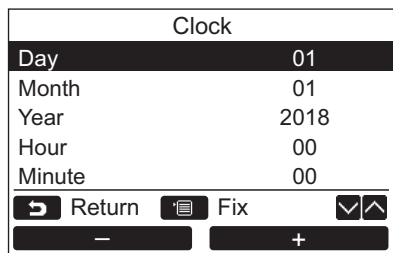

1 Push the []/[] button to select “1. Clock” on the “Initial setting” screen, then push the “ Set” [F2 F2] button.

2 Push the []/[] button to select the Year, Month, Day, and time.

→Push the “ -” [F1 F1] / “ +” [F2 F2] button to set the value.

3 Push the [MENU] button.

→The screen returns to the “Initial setting” screen.

The clock display appears on the upper right of the screen.

- The clock display blinks if the clock setting has been reset due to power failure or other cause.

NOTE

The available date range is from January 1st, 2018 to December 31st, 2099.

2. Name of room

Set the name of the room or place where the remote controller is installed. (Operations of the air conditioner are possible without this setting.)

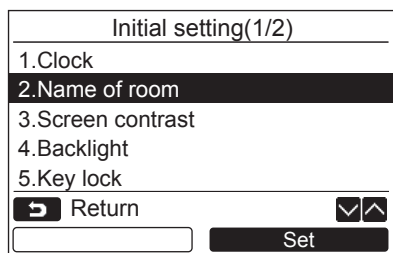

1 Push the []/[] button to select “2. Name of room” on the “Initial setting” screen, then push the “ Set” [F2 F2] button.

2 Set the name of the remote controller.

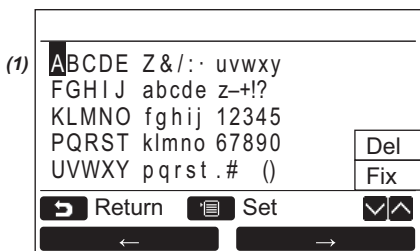

Enter the characters of the name in the screen (1) .

Move the cursor to select the character with the []/[] button and “ ←” [F1 F1] / “ →” [F2 F2] button (the selected character is highlighted), then push the [MENU] button. Name of the remote controller appears.

Up to 16 characters can be entered for Name of room.

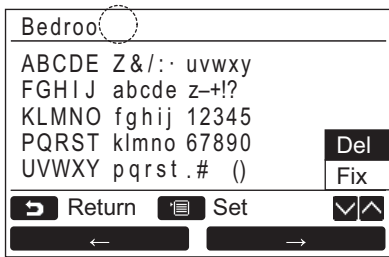

To delete a character, highlight “Del” and push [MENU] button.

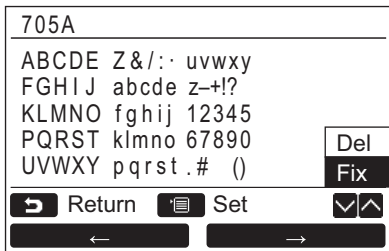

To confirm the name, highlight “Fix” and push [MENU] button.

→The screen returns to the “Initial setting” screen.

3. Screen contrast

Adjust the contrast of the LCD.

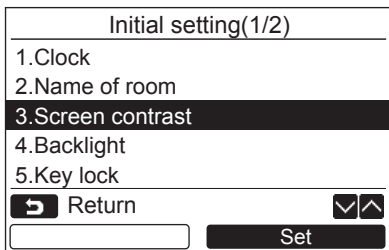

1 Push the [^ ^] / [v v] button to select “3. Screen contrast” on the “Initial setting” screen, then push the “Set Set” [F2] button.

2 Push the “-” [F1] / “+” [F2] button to adjust.

3 Push the [MENU] button.
→The screen returns to the “Initial setting” screen.

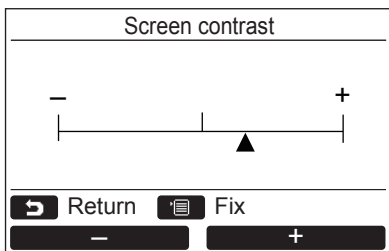

4. Backlight

Turn on or off the back light of the LCD.

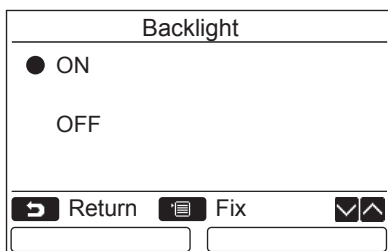
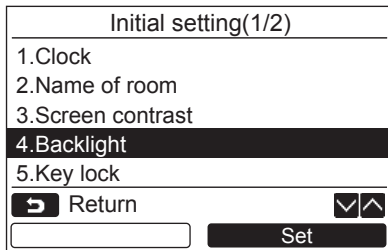

- 1** Push the [] / [] button to select “4. Backlight” on the “Initial setting” screen, then push the “ Set” [F2 F2] button.
- 2** Push the [] / [] button to select “ON” or “OFF”.
- 3** Push the [MENU] button.
 →When “ON” is selected, the back light is turned on during operating with the remote controller.
 →When “OFF” is selected, the back light is not turned on.

NOTE

- The back light of the LCD is turned on as factory default.
- The back light is on for a predetermined time after button operation.

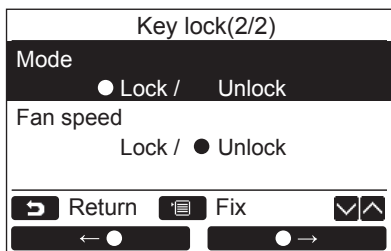
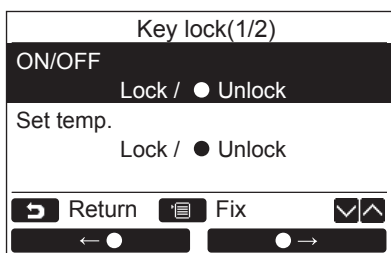
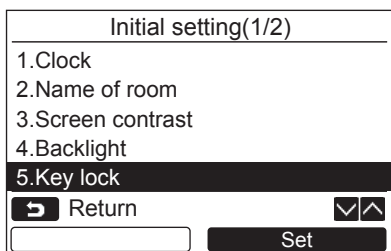

5. Key lock

Select whether to lock / unlock [ON / OFF], [▼▲], [MODE](F1) and [FAN SPEED](F2).



1 Push the [▲ ▲] / [▼ ▼] button to select “5. Key lock” on the “Initial setting” screen, then push the “ Set” [F2 F2] button.

2 Push the [▲ ▲] / [▼ ▼] button to select a key to lock / unlock.

3 Push the “ ←●” [F1 F1] button to select “Lock”, or “ ●→” [F2 F2] button to select “Unlock”.

4 Push the [MENU] button.

→When "Lock" is selected, the key cannot be used during key lock.

When "Unlock" is selected, the key can be used even during key lock.

→All keys are unlocked while “Check” is displayed.

→For the key lock setting, refer to the owner’s manual.

→The factory default is "Lock".

6. Header/Follower

Set the remote controller as “Header remote controller” or “Follower remote controller” when the dual remote controller system is used.

Carry out the setting operation while the indoor unit is stopped. (Turn off the air conditioning unit before starting the setting operation.)

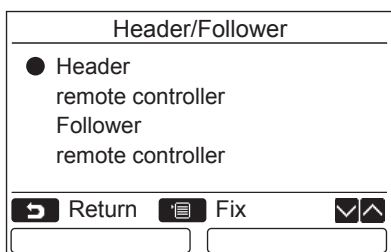
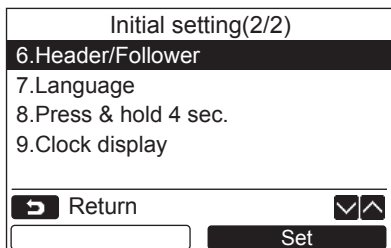

- 1** Push the [] button to select “6. Header/Follower” on the “Initial setting” screen, then push the “ Set” [] button.
- 2** Push the [] button to select the setting.
- 3** Push the [MENU] button.
→ “ Setting” appears on the screen, then the screen returns to the “Initial setting” screen.

Note for the Header/Follower setting

- Schedule timer functions is not available when the remote controller is set as the Follower remote controller:

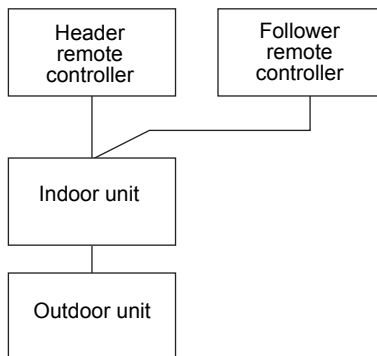

NOTE

- Some functions are not available when the remote controller is set as the Follower remote controller.
- In the dual remote controller system, the latter operation overrides the former.
- The remote controller is set as “Header remote controller” as factory default.
- If the Header/Follower remote controller settings are not set correctly, the “30” or “32” check code is displayed.

7. Language

Select a language for the screen text.

| Initial setting(2/2) | |
|-----------------------|----------------------------------|
| 6.Header/Follower | |
| 7.Language | |
| 8.Press & hold 4 sec. | |
| 9.Clock display | |
| Return | |
| <input type="text"/> | <input type="text" value="Set"/> |

| Language(1/2) | |
|--|----------------------|
| <input checked="" type="radio"/> English | |
| French | Français |
| Russian | Русский |
| German | Deutsch |
| Italian | Italiano |
| Return | Fix |
| <input type="text"/> | <input type="text"/> |

| Language(2/2) | |
|--|----------------------|
| <input checked="" type="radio"/> Dutch | Nederlands |
| | |
| Return | Fix |
| <input type="text"/> | <input type="text"/> |

1 Push the [] / [] button to select “7. Language” on the “Initial setting” screen, then push the “ Set” [F2] button.

2 Push the [] / [] button to select a language.



3 Push the [MENU] button.



The screen text changes to the selected language.





→The factory default is English.

8. Press & hold 4sec.

Set the "Press & hold 4 sec." operation for the [ ON / OFF] button.

| Initial setting(2/2) | |
|--|---|
| 6.Header/Follower | |
| 7.Language | |
| 8.Press & hold 4 sec. | |
| 9.Clock display | |
|  Return |  |
| <input type="text"/> | <input type="text" value="Set"/> |

| Press & hold 4sec. | |
|--|---|
| <input checked="" type="radio"/> ON | |
| <input type="radio"/> OFF | |
|  Return |  Fix  |
| <input type="text"/> | <input type="text"/> |

1 Push the [ ] / [ ] button to select "8. Press & hold 4sec." on the "Initial setting" screen, then push the " [ F2] button.

2 Push the [ ] / [ ] button to select "ON" or "OFF".

3 Push the [ MENU] button.

→When "ON" is selected, the air-conditioner starts / stops running when the [ ON / OFF] button is pressed and hold 4 seconds.

→When "OFF" is selected, the air-conditioner starts / stops running when the [ ON / OFF] button is pressed.

9. Clock display

Select the “12-hour clock” and “24-hour clock”.

| Initial setting(2/2) | |
|------------------------|------------|
| 6.Header/Follower | |
| 7.Language | |
| 8.Press & hold 4 sec. | |
| 9.Clock display | |
| Return | |
| <input type="text"/> | Set |

| Clock display | |
|--------------------------------------|----------------------|
| <input checked="" type="radio"/> 24H | |
| <input type="radio"/> AM/PM | |
| Return | Fix |
| <input type="text"/> | <input type="text"/> |

- 1** Push the [^] / [v] button to select “9. Clock display” on the menu screen, then push the “ Set” [F2] button.
- 2** Push the [^] / [v] button to select “24H” or “AM/PM”.
24H: 24-hour clock
AM/PM: 12-hour clock
- 3** Push the [MENU] button.
→The screen returns to the “Initial setting” screen.

NOTE

- Even if you select the “12-hour clock”, the “24-hour clock” display will still appear in the setting screen of the schedule timer etc.

6 Field setting menu

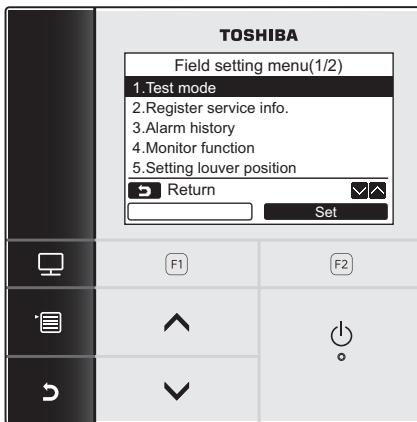

- 1** Push the [MENU] button to display the menu screen.
- 2** Push and hold the [MENU] button and the [↓] button at the same time to display the “Field setting menu”.
→Push and hold the buttons for more than 4 seconds.
- 3** Push the [CANCEL] button to return.

| Item | Function |
|----------------------------|--|
| 1. Test mode | Settings for when performing the test operation after installation |
| 2. Register service info. | Registration of information about the contact number for service, model name and serial number of the indoor unit and outdoor unit |
| 3. Alarm history | List of latest 10 alarm data: information of check code, date, time, and unit |
| 4. Monitor function | Monitoring data of sensor temperature, rotating speed of the compressor or other factor. |
| 5. Setting louver position | Change the louver indication setting to match the indoor unit type. |
| 6. FC setting | Advanced settings using Function code |

1. Test mode

Set for the test operation after installation.

Before the test mode

- Perform the followings before turning on the power:
 - 1) By using 500 V-megger, check that resistance of 1 MΩ or more exists between the terminal block of the power supply and the earth (earthing).
If resistance of less than 1 MΩ is detected, do not run the unit.
 - 2) Check all valve of the outdoor unit is opened fully.
- To protect the compressor at the time of startup, leave the power on for 12 hours or more before operation.
- Do not press the electromagnetic contactor to forcibly perform the test mode. (It is very dangerous because the protective device does not work.)
- Peel off the protective sheet affixed when the remote controller was shipped before performing a test run.

Performing the test mode

For the procedure of the operation, refer to the supplied Owner’s Manual. A forced test mode can be performed according to the following procedure when the room temperature rises / falls enough for the thermostat to turn off. In order to prevent a continuous operation, the forced test operation is released after 60 minutes have passed and returns to the normal operation.

CAUTION

Do not perform the forced test mode for purposes other than the test mode because it applies an excessive load to the devices.

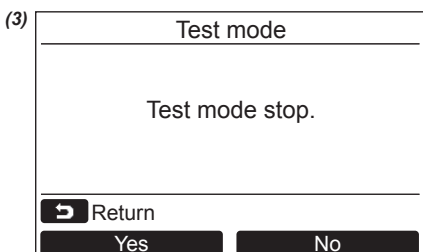
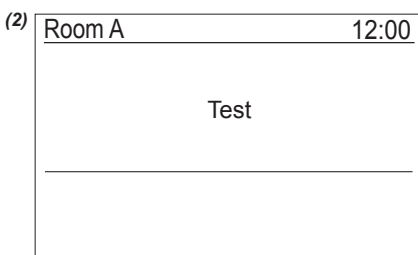
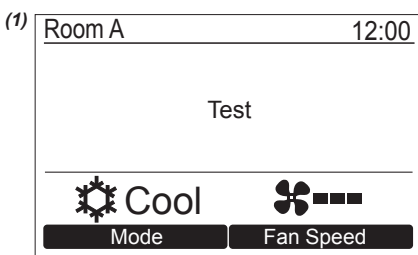
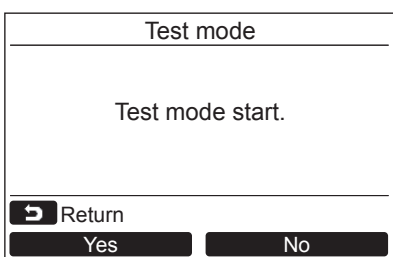
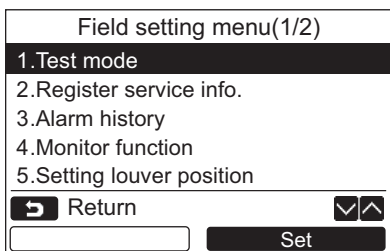

1 Push the [] / [] button to select “1. Test mode” on the “Field setting menu” screen, then push the “ Set” [F2] button.

→Pushing the “ Yes” [F1] button sets the test mode and the screen returns to the “Field setting menu” screen.
Push [CANCEL] twice, the screen (2) appears.

2 Push the [ON / OFF] button to start the test mode. The screen (1) shown in the left appears. (The screen (2) appears when the operation is stopped.)

→Perform the test mode in the “Cool” or “Heat” mode.
→Temperature setting cannot be adjusted during the test mode.
→Check codes are displayed as usual.

3 When the test mode is finished, push the [] / [] button to select “1. Test mode” on the “Field setting menu” screen, then push the “ Set” [F2] button.

The screen (3) appears.

→Pushing the “ Yes” [F1] button stops the test mode screen and continues the normal operation.

NOTE

The test mode stops after 60 minutes.

Using the Service monitor with the [MONITOR] button during the test mode

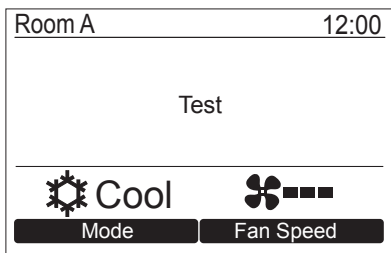

Push the [MONITOR] button

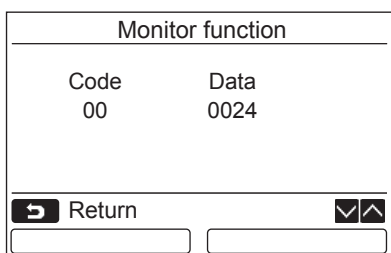

Refer to “4. Monitor function” (page 27) for details.

When the group control is used, select the unit to monitor in the unit selection screen before displaying the monitoring display.

2. Register service info.

Register information about the contact number for service, model name and serial number of the indoor unit and outdoor unit.

- Enter information manually for the outdoor unit.
Information data of the indoor unit is loaded automatically. Automatic loading is not available for some models. In this case, enter information manually.
- Enter the contact number for service displayed in “2. Service information” of “11. information” on the menu screen.
- Enter the model name and serial number displayed in “1. Model information” of “11. information” on the menu screen.

Entering information manually

| | |
|----------------------------|-----|
| Register service info. | |
| 1. Service contact tel No. | |
| 2. Outdoor model name | |
| 3. Outdoor unit serial No. | |
| 4. Indoor model name | |
| 5. Indoor unit serial No. | |
| Return | Set |

- 1 Push the [▲ ▲] / [▼ ▼] button to select "2. Register service info." on the Field setting menu screen.
- 2 Push the "Set" [F2 F2] button.
→The setting screen for entering information appears.
- 3 Enter the information with the "←" [F1 F1] / "→" [F2 F2] button and [▲ ▲] / [▼ ▼] button.

| Item | Function |
|----------------------------|--|
| 1. Service contact tel No. | Enter the contact number for service. |
| 2. Outdoor model name | Enter / reset the model name of the outdoor unit. |
| 3. Outdoor unit serial No. | Enter / reset the serial number of the outdoor unit. |
| 4. Indoor model name | Enter / reset the model name of the indoor unit. |
| 5. Indoor unit serial No. | Enter / reset the serial number of the indoor unit. |

Entering the contact number for service

| | |
|----------------------------|-----|
| Register service info. | |
| 1. Service contact tel No. | |
| 2. Outdoor model name | |
| 3. Outdoor unit serial No. | |
| 4. Indoor model name | |
| 5. Indoor unit serial No. | |
| Return | Set |

| | |
|-------------------------|-----|
| Service contact tel No. | |
| Input telephone number | |
| - - - - - | |
| Return | Fix |
| ← | → |

- 1 Push the [▲ ▲] / [▼ ▼] button to select "1. Service contact tel No.", then push the "Set" [F2 F2] button.
- 2 Move the cursor to select the character (selected character is highlighted) with the "←" [F1 F1] / "→" [F2 F2] button, then enter the contact number with the [▲ ▲] / [▼ ▼] button.
- 3 Push the [MENU] button.

Entering the model name and serial number

Enter the model name and serial number manually for the outdoor unit. Information data is loaded automatically for the indoor units. Enter the model name and serial number manually after replacing the circuit board to the service circuit board (unless entering information manually before replacement of the circuit board).

| Product | Model name and serial number display |
|-----------------------|--|
| Indoor unit | Information data is loaded automatically from the indoor unit and displayed. |
| Outdoor unit | Enter information manually on the remote controller. |
| Service circuit board | Enter information manually on the remote controller. |

<Flow chart of usual process>

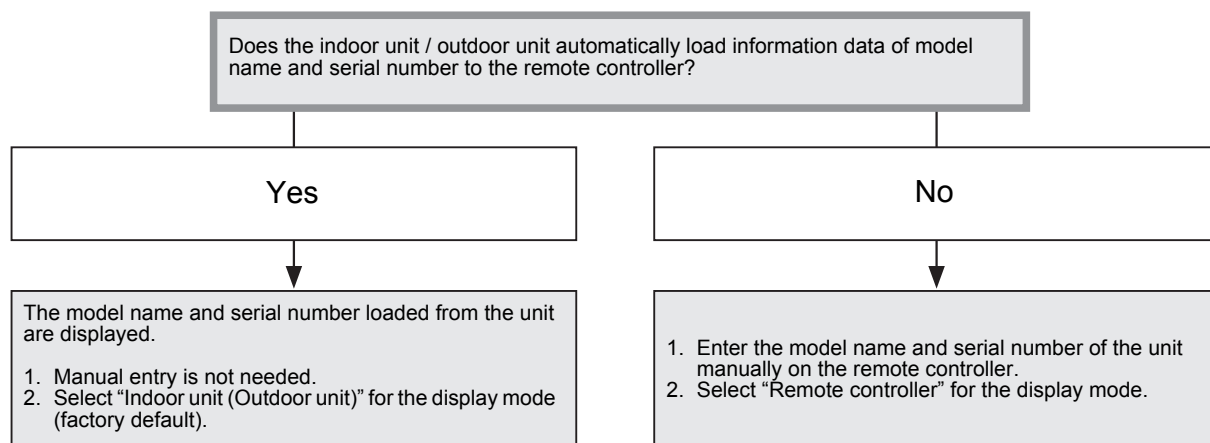

Entering the model name and serial number manually

Register service info.

1. Service contact tel No.

2. Outdoor model name

3. Outdoor unit serial No.

4. Indoor model name

5. Indoor unit serial No.

Return [Set]

1 Push the [▲ ▲] / [▼ ▼] button to select **"2. Outdoor model name"** on the **"Register service info."** screen, then push the **"Set" [F2 F2] button.**

→ Select "3. Outdoor unit serial No." to enter the serial number of the outdoor unit.

→ Select "4. Indoor model name" to enter the model name of the indoor unit.

→ Select "5. Indoor unit serial No." to enter the serial number of the indoor unit.

Outdoor model name

1. Manual model name input

2. Model name selection

Outdoor model name

Return [Fix] [Set]

2 Push the [▲ ▲] / [▼ ▼] button to select **"1. Manual model name input"** on the **"Outdoor model name"** screen, then push the **"Set" [F2 F2] button.**

→ Select "1. Manual serial No. input" to enter the serial number of the outdoor unit.

→ Select "1. Manual model name input" to enter the model name of the indoor unit.

→ Select "1. Manual serial No. input" to enter the serial number of the indoor unit.

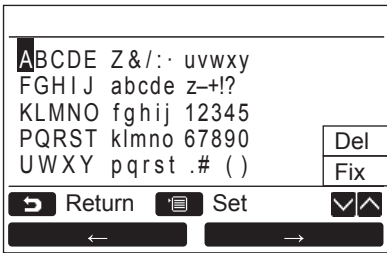

Selecting the model name and serial No.

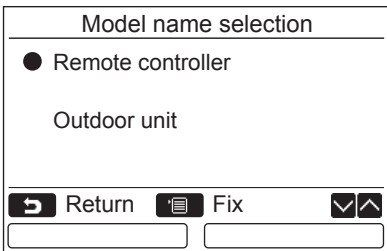
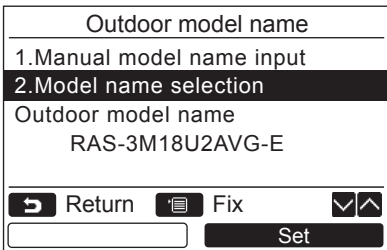

- 3 Enter the model name of the outdoor unit.**
→ See page 12 about how to enter the model name and serial number.
- 4 Select “Remote controller” for the display mode of model name or serial number to display the manually entered model name or serial number. (See page 12.)**

- 1 Push the [^ ^] / [v v] button to select “2. Model name selection” on the “Outdoor model name” screen, then push the [Set] [F2] button.**
→ To select the serial number of the outdoor unit, select "2. Serial No. selection".
→ To select the model name of the indoor unit, select "2. Model name selection".
→ To select the serial number of the indoor unit, select "2. Serial No. selection".

- 2 Push the [^ ^] / [v v] button to select “Remote controller” or “Outdoor unit”.**
→ When "Outdoor unit" is selected, the model name or serial number of the outdoor unit is not displayed.
→ When "Indoor unit" is selected, the model name or serial number received from the indoor unit is displayed.
→ When "Remote controller" is selected, the manually entered model name or serial number is displayed.
→ The factory default is "Outdoor unit" or "Indoor unit".

- 3 Push the [MENU] button.**
→ The screen returns to the “Outdoor model name” screen.

Checking the model name or serial number

The model name or serial number to be displayed on the Outdoor (Indoor) model name or Outdoor (Indoor) unit serial No. screen is displayed.

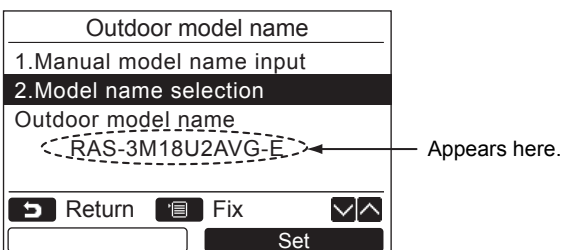

3. Alarm history

List of latest 10 alarm data: error information of check code, date, time, and unit, is displayed.

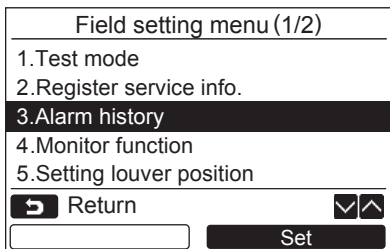

- 1 Push the []/[] button to select “3. Alarm history” on the “Field setting menu” screen, then push the “ Set” [F2] button.

List of latest 10 Alarm data is displayed.

- * The oldest data are deleted in order to record the new ones.
- The date and time when the error occurred for the first time is displayed for the repeated alarm.

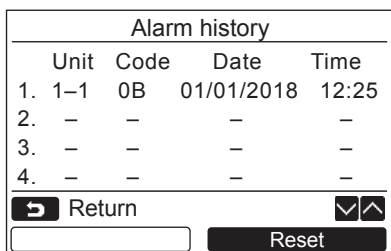

Deleting the alarm history

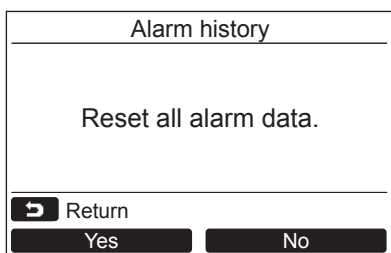

- 1 Push the “ Reset” [F2] button while the list of alarm history is displayed.
- 2 Push the “ Yes” [F1] button after the confirmation screen is displayed.
 - Delete the alarm history in each remote controller when the dual remote controller system is used.

4. Monitor function

The sensor temperature or operational status of indoor unit, outdoor unit, or remote controller can be monitored.

| Field setting menu (1/2) | |
|----------------------------|------------|
| 1. Test mode | |
| 2. Register service info. | |
| 3. Alarm history | |
| 4. Monitor function | |
| 5. Setting louver position | |
| Return | |
| <input type="text"/> | Set |

| Monitor function | |
|----------------------|----------------------|
| Code | Data |
| 00 | 0024 |
| Return | |
| <input type="text"/> | <input type="text"/> |

- 1** Push the [] / [] button to select “4. Monitor function” on the “Field setting menu” screen, then push the “**Set**” [**F2**] button.
 → Push the [] / [] button to select the code to check data.
- 2** Refer to the Installation Manual supplied with the indoor unit or outdoor unit or service manual for details about the check code and data.
- 3** Push the [**CANCEL**] button to return to the “Field setting menu” screen.

5. Setting louver position

The louver indication setting can be changed.

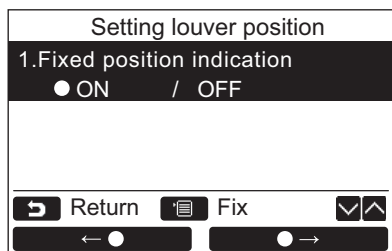
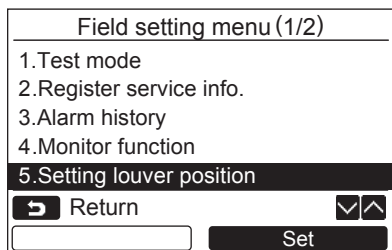

1 Push the [▲ ▲] / [▼ ▼] button to select “5. Setting louver position”, then push the “**Set**” [F2 F2] button.

→ “Impossible” is displayed in the case of a model for which the wind direction cannot be set.

→ ● is displayed for the selected item.

2 Push the [▲ ▲] / [▼ ▼] button to select an item on the “Fixed position indication” screen.

The highlighted item can be set.

→ Move ○ with the “←●” [F1 F1] / “●→” [F2 F2] button to set the setting.

3 After setting each item, push the [MENU] button to confirm the changes to the settings.

Change the flap position indication for when swinging is cancelled in [Fixed position indicator].

→ When “ON” is selected, the louver stops and the indication becomes as shown on the right when swinging is cancelled.

(Factory default)

→ When “OFF” is selected, the stop position and indication becomes as shown on the right after swinging is cancelled.



6. FC setting

Perform the advanced settings for the air conditioner.

Carry out the setting operation while the indoor unit is stopped. (Turn off the air conditioning unit before starting the setting operation.)

| Field setting menu (2/2) | |
|--------------------------|-----|
| 6.FC setting | |
| | |
| Return | Set |

| FC setting | |
|------------|------|
| Code (FC) | Data |
| 10 | 0000 |
| Return | Fix |
| < | > |

| FC setting | |
|------------|------|
| Code (FC) | Data |
| 10 | 0001 |
| Return | Fix |
| < | > |

| FC setting | |
|------------|----|
| Continue? | |
| Return | |
| Yes | No |

- 1 Push the [] / [] button to select “6. FC setting” on the “Field setting menu” screen, then push the “ Set” [F2] button.

→ The fan of the indoor unit operate.

→ Move the cursor to select “Function code” with the “ <” [F1] button, then set “Function code” with the [] / [] button.

→ Move the cursor to select “data” with the “ >” [F2] button, then set “data” with the [] / [] button.

- 2 Refer to the Installation Manual supplied with the indoor unit or service manual for details about the Function code and data.
- 3 Push the [MENU] button to set the other Function codes. After “Continue?” is displayed on the screen, push the “ Yes” [F1] button.
- 4 Push the “ No” [F2] button to finish the setting operation. “ ” appears on the screen for a while, then the screen returns to the “Field setting menu” screen.

TOSHIBA CARRIER CORPORATION