

# TOSHIBA

**INSTALLATION MANUAL**  
**AIR CONDITIONER (SPLIT TYPE)**

**R32**

***INVERTER***

ENGLISH

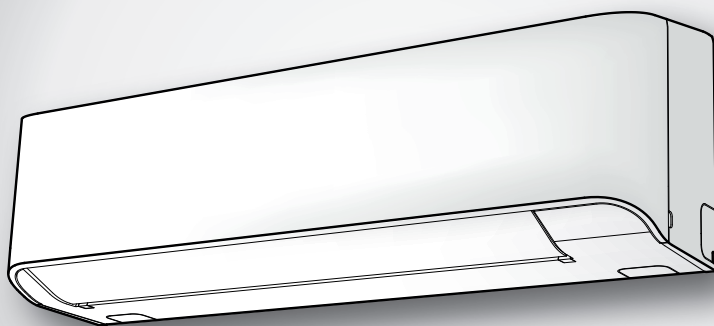

**Indoor unit**  
**RAS-24BKVG-E**

**Outdoor unit**  
**RAS-24BAVG-E**



1120650130

<b>PRECAUTIONS FOR SAFETY</b> .....	1
<b>ACCESSORY PARTS</b> .....	5
<b>INSTALLATION DIAGRAM OF INDOOR AND OUTDOOR UNITS</b> .....	6
■ Optional Installation Parts .....	6
<b>INDOOR UNIT</b> .....	7
■ Installation Place .....	7
■ Cutting a Hole and Mounting Installation Plate .....	7
■ Piping and Drain Hose Installation .....	7
■ Indoor Unit Fixing .....	8
■ Drainage .....	9
<b>OUTDOOR UNIT</b> .....	9
■ Installation Place .....	9
■ Precautions about Installation in Regions with Snowfall and Cold Temperatures .....	9
■ Refrigerant Piping Connection .....	9
■ Evacuating .....	10
<b>ELECTRICAL WORKS</b> .....	11
■ Wiring Connection .....	11
■ Power Supply and Connecting Cable Connection .....	12
■ Power Supply Input Wiring Diagram .....	13
<b>OTHERS</b> .....	14
■ Gas Leak Test .....	14
■ Remote Control A-B Selection .....	14
■ Test Operation .....	14
■ Auto Restart Setting .....	14
<b>APPENDIX</b> .....	15

## PRECAUTIONS FOR SAFETY



Read the precautions in this manual carefully before operating the unit.



This appliance is filled with R32.

EN

- Before installation, please read these precautions for safety carefully.
- Be sure to follow the precautions provided here to avoid safety risks. The symbols and their meanings are shown below.

**WARNING** : It indicates that incorrect use of this unit may cause severe injury or death.

**CAUTION** : It indicates that incorrect use of this unit may cause personal injury (\*1), or property damage (\*2).

\*1: Personal injury means a slight accident, burn, or electrical shock which does not require admission or repeated hospital treatment.

\*2: Property damage means greater damage which affects assets or resources.

### For general public use

Power supply cord and connecting cable of appliance use shall be at least polychloroprene sheathed flexible cord (design H07RN-F) or cord designation 60245 IEC66. (Shall be installed in accordance with national wiring regulations.)

### **CAUTION** To disconnect the appliance from the main power supply

This appliance must be connected to the main power supply by means of a circuit breaker or a switch with a contact separation of at least 3 mm in all poles.

## **DANGER**

- FOR USE BY QUALIFIED PERSONS ONLY.
- TURN OFF MAIN POWER SUPPLY BEFORE ATTEMPTING ANY ELECTRICAL WORK. MAKE SURE ALL POWER SWITCHES ARE OFF.  
FAILURE TO DO SO MAY CAUSE ELECTRIC SHOCK.
- CONNECT THE CONNECTING CABLE CORRECTLY. IF THE CONNECTING CABLE IS CONNECTED WRONGLY, ELECTRIC PARTS MAY BE DAMAGED.
- CHECK THE EARTH WIRE THAT IT IS NOT BROKEN OR DISCONNECTED BEFORE INSTALLATION.
- DO NOT INSTALL NEAR CONCENTRATIONS OF COMBUSTIBLE GAS OR GAS VAPORS.  
FAILURE TO FOLLOW THIS INSTRUCTION CAN RESULT IN FIRE OR EXPLOSION.
- TO PREVENT OVERHEATING THE INDOOR UNIT AND CAUSING A FIRE HAZARD, PLACE THE UNIT WELL AWAY (MORE THAN 2 M) FROM HEAT SOURCES SUCH AS RADIATORS, HEATERS, FURNACE, STOVES, ETC.
- WHEN MOVING THE AIR CONDITIONER FOR INSTALLING IT IN ANOTHER PLACE AGAIN, BE VERY CAREFUL NOT TO GET THE SPECIFIED REFRIGERANT (R32) WITH ANY OTHER GASEOUS BODY INTO THE REFRIGERATION CYCLE. IF AIR OR ANY OTHER GAS IS MIXED IN THE REFRIGERANT, THE GAS PRESSURE IN THE REFRIGERATION CYCLE BECOMES ABNORMALLY HIGH AND IT RESULTINGLY CAUSES BURST OF THE PIPE AND INJURIES ON PERSONS.
- IN THE EVENT THAT THE REFRIGERANT GAS LEAKS OUT OF THE PIPE DURING THE INSTALLATION WORK, IMMEDIATELY LET FRESH AIR INTO THE ROOM. IF THE REFRIGERANT GAS IS HEATED BY FIRE OR SOMETHING ELSE, IT CAUSES GENERATION OF POISONOUS GAS.

## **WARNING**

- Never modify this unit by removing any of the safety guards or bypassing any of the safety interlock switches.
- Do not install in a place which cannot bear the weight of the unit.  
Personal injury and property damage can result if the unit falls.
- Before doing the electrical work, attach an approved plug to the power supply cord.  
Also, make sure the equipment is properly earthed.
- Appliance shall be installed in accordance with national wiring regulations.  
If you detect any damage, do not install the unit. Contact your dealer immediately.

- Do not use any refrigerant different from the one specified for complement or replacement.  
Otherwise, abnormally high pressure may be generated in the refrigeration cycle, which may result in a failure or explosion of the product or an injury to your body.
- Do not use means to accelerate the defrosting process or to clean, other than those recommended by the manufacturer.
- The appliance shall be stored in a room without continuously operating ignition sources (for example: open flames, an operating gas appliance or an operating electric heater).
- Be aware that refrigerants may not contain an odour.
- Do not pierce or burn as the appliance is pressurized. Do not expose the appliance to heat, flame, sparks, or other sources or ignition. Else, it may explode and cause injury or death.
- For R32 model, use pipes, flare nut and tools which is specified for R32 refrigerant. Using of existing (R22) piping, flare nut and tools may cause abnormally high pressure in the refrigerant cycle (piping), and possibly result in explosion and injury.
- Thickness of copper pipes used R32 must be more than 0.8mm. Never use copper pipes thinner than 0.8mm.
- Do not perform flare connection inside a building or dwelling or room, when joining the heat exchanger of indoor unit with interconnection piping. Refrigerant connection inside a building or dwelling or room must be made by brazing or welding. Joint connection of indoor unit by flaring method can only be made at outdoor or at outside of building or dwelling or room. Flare connection may cause gas leak and flammable atmosphere.
- After completion of installation or service, confirm there is no leakage of refrigerant gas. It may generate toxic gas when the refrigerant contacts with fire.
- Appliance and pipe-work shall be installed, operated and stored in a room with a floor area larger than  $A_{\min}$  m<sup>2</sup>.  
How to get  $A_{\min}$  m<sup>2</sup> :  $A_{\min} = (M / (2.5 \times 0.22759 \times h_0))^2$   
M is the refrigerant charge amount in appliance in kg.  $h_0$  is the installation height of the appliance in m: 0.6 m for floor standing/1.8 m for wall mounted/1.0 m for window mounted/2.2 m for ceiling mounted (For these units recommend installation height 2.5 m.).
- Comply with national gas regulations.

## CAUTION

- Exposure of unit to water or other moisture before installation could result in electric shock.  
Do not store it in a wet basement or expose to rain or water.
- After unpacking the unit, examine it carefully for possible damage.
- Do not install the unit at place where leakage of flammable gas may occur. In case gas leaks and accumulates at surrounding of the unit, it may cause of fire.
- Do not install in a place that can increase the vibration of the unit. Do not install in a place that can amplify the noise level of the unit or where noise and discharged air might disturb neighbors.
- To avoid personal injury, be careful when handling parts with sharp edges.
- Please read this installation manual carefully before installing the unit. It contains further important instructions for proper installation.
- The manufacturer shall not assume any liability for the damage caused by not observing the description of this manual.

## REQUIREMENT OF REPORT TO THE LOCAL POWER SUPPLIER

Please make absolutely sure that the installation of this appliance is reported to the local power supplier before installation. If you experience any problems or if the installation is not accepted by the supplier, the service agency will take adequate countermeasures.

### ■ Important information regarding the refrigerant used

This product contains fluorinated greenhouse gases.

Do not vent gases into the atmosphere.

Refrigerant type: **R32**

GWP<sup>(1)</sup> value: **675** \* (ex. R32 ref. AR4)







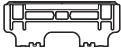

<sup>(1)</sup>GWP = global warming potential

The refrigerant quantity is indicated on the unit name plate.

\* This value is based on F gas regulation 517/2014

# ACCESSORY PARTS

EN

Indoor Unit			
No.	Part name	No.	Part name
①	 Installation Plate × 1	②	 Wireless remote control × 1
③	 Battery × 2	④	 Remote control holder × 1
⑤	 Mounting screw × 6	⑥	 Flat head wood screw × 2
⑦	 Owner's Manual × 1	⑧	 Installation Manual × 1
⑨	 Screw × 2		

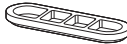
Outdoor Unit			
No.	Part name	No.	Part name
⑩	 Drain nipple × 1	⑪	 Cap water proof × 2

### Air filters

Clean every 2 weeks.

1. Open the air inlet grille.
2. Remove the air filters.
3. Vacuum or wash and then dry them.
4. Reinstall the air filters and close the air inlet grille.



# INSTALLATION DIAGRAM OF INDOOR AND OUTDOOR UNITS

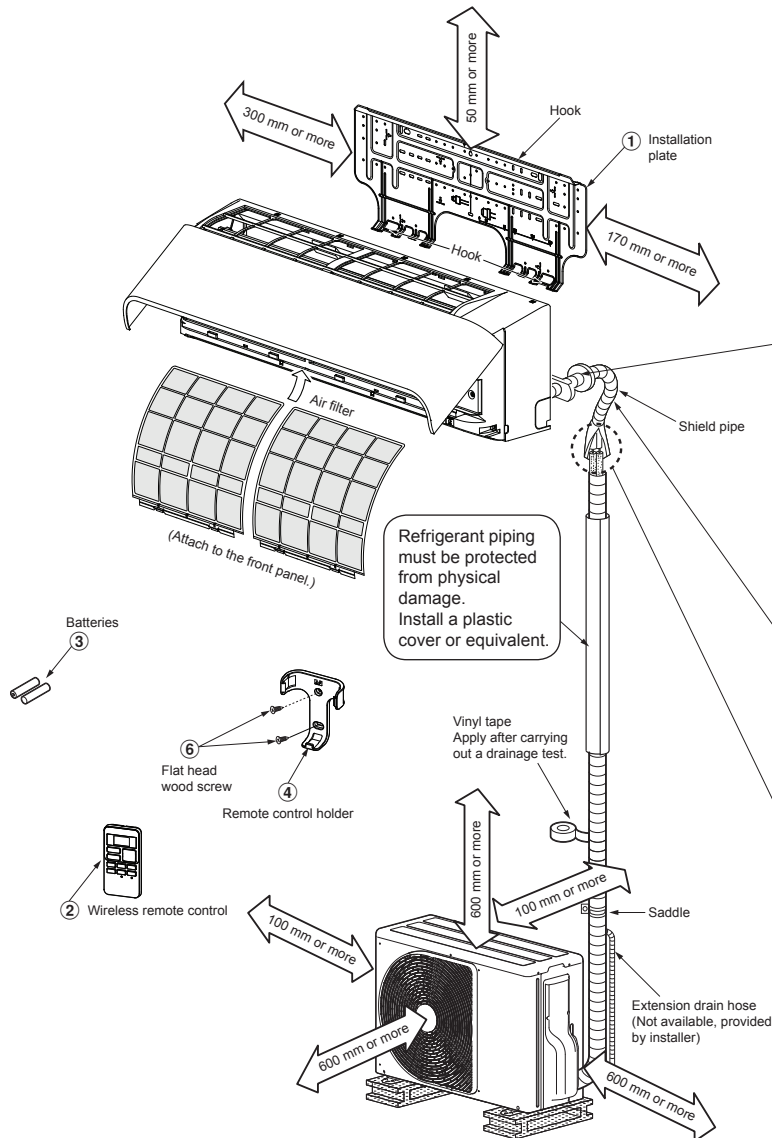

**For the rear left and left piping**

Wall

Insert the cushion between the indoor unit and wall, and tilt the indoor unit for better operation.

The auxiliary piping can be connected to the left, rear left, rear right, right, bottom right or bottom left.

Do not allow the drain hose to get slack.

Cut the piping hole sloped slightly.

Make sure to run the drain hose sloped downward.

The flare connection should be installed outdoors.

Insulate the refrigerant pipes separately with insulation, not together.

8 mm thick heat resisting polyethylene foam

## Optional Installation Parts

Part code	Parts name	Q'ty
(A)	Refrigerant piping Liquid side : $\varnothing 6.35$ mm Gas side : $\varnothing 12.70$ mm	One each
(B)	Pipe insulating material (polyethylene foam, 8 mm thick)	1
(C)	Putty, PVC tapes	One each

## Fixing bolt arrangement of outdoor unit

- Secure the outdoor unit with fixing bolts and nuts if the unit is likely to be exposed to a strong wind.
- Use  $\varnothing 8$  mm or  $\varnothing 10$  mm anchor bolts and nuts.
- If it is necessary to drain the defrost water, attach drain nipple (10) and cap water proof (11) to the bottom plate of the outdoor unit before installing it.

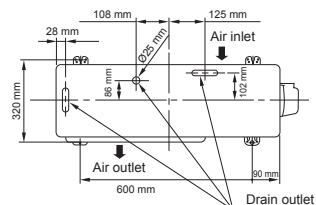



# INDOOR UNIT

## Installation Place

- A place which provides the spaces around the indoor unit as shown in the diagram
- A place where there are no obstacles near the air inlet and outlet
- A place which allows easy installation of the piping to the outdoor unit
- A place which allows the front panel to be opened
- The indoor unit shall be installed at least 2.5 m height. Also, it must be avoided to put anything on the top of the indoor unit.

### CAUTION

- Direct sunlight to the indoor unit's wireless receiver should be avoided.
- The microprocessor in the indoor unit should not be too close to RF noise sources.  
(For details, see the owner's manual.)

## Remote control

- A place where there are no obstacles such as a curtain that may block the signal from the indoor unit
- Do not install the remote control in a place exposed to direct sunlight or close to a heating source such as a stove.
- Keep the remote control at least 1 m apart from the nearest TV set or stereo equipment. (This is necessary to prevent image disturbances or noise interference.)
- The location of the remote control should be determined as shown below.

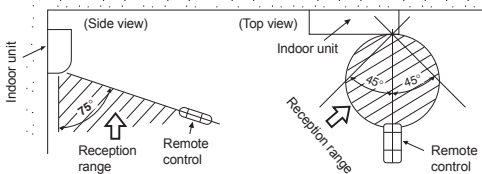

## Cutting a Hole and Mounting Installation Plate

### Cutting a hole

When installing the refrigerant pipes from the rear

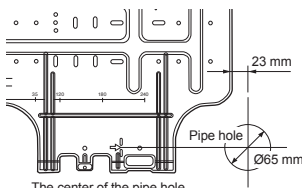

1. After determining the pipe hole position on the mounting plate (➔), drill the pipe hole (Ø65 mm) at a slight downward slant to the outdoor side.

### NOTE

- When drilling a wall that contains a metal lath, wire lath or metal plate, be sure to use a pipe hole brim ring sold separately.

### Mounting the installation plate

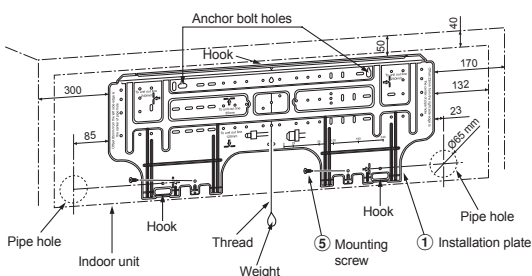

### When the installation plate is directly mounted on the wall

1. Securely fit the installation plate onto the wall by screwing it in the upper and lower parts to hook up the indoor unit.
2. To mount the installation plate on a concrete wall with anchor bolts, use the anchor bolt holes as illustrated in the below figure.
3. Install the installation plate horizontally in the wall.

### CAUTION

When installing the installation plate with a mounting screw, do not use the anchor bolt holes. Otherwise, the unit may fall down and result in personal injury and property damage.

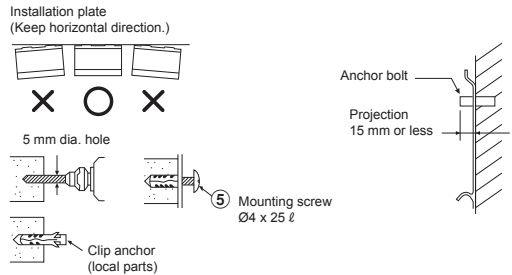

### CAUTION

Failure to firmly install the unit may result in personal injury and property damage if the unit falls.

- In case of block, brick, concrete or similar type walls, make 5 mm dia. holes in the wall.
- Insert clip anchors for appropriate mounting screws ⑤.

### NOTE

- Secure four corners and lower parts of the installation plate with 4 to 6 mounting screws to install it.

## Piping and Drain Hose Installation

### Piping and drain hose forming

- Since dewing results in a machine trouble, make sure to insulate both connecting pipes. (Use polyethylene foam as insulating material.)

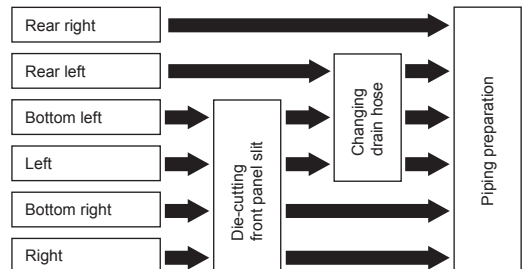

#### 1. Die-cutting front panel slit

Cut out the slit on the left or right side of the front panel for the left or right connection and the slit on the bottom left or right side of the front panel for the bottom left or right connection with a pair of nippers.

#### 2. Changing drain hose

For leftward connection, bottom-leftward connection and rearleftward connection's piping, it is necessary to change the drain hose and drain cap.

## How to remove the drain hose

- The drain hose can be removed by removing the screw securing the drain hose and then pulling out the drain hose.
- When removing the drain hose, be careful of any sharp edges of steel plate. The edges can injure.
- To install the drain hose, insert the drain hose firmly until the connection part contacts with heat insulator, and then secure it with original screw.

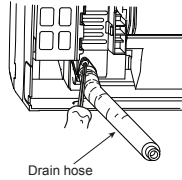

## How to remove the drain cap

Clip the drain cap by needle-nose pliers and pull out.

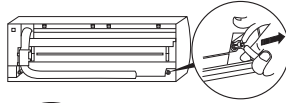

## How to fix the drain cap

- 1) Insert hexagon wrench (4 mm) in a center head.

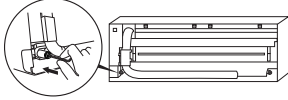

- 2) Firmly insert the drain cap.

Do not apply lubricating oil (refrigerant machine oil) when inserting the drain cap. Application causes deterioration and drain leakage of the plug.

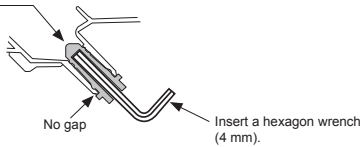

## CAUTION

Firmly insert the drain hose and drain cap; otherwise, water may leak.

## In case of right or left piping

- After scribing slits of the front panel with a knife or a making-off pin, cut them with a pair of nippers or an equivalent tool.

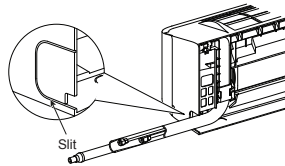

## In case of bottom right or bottom left piping

- After scribing slits of the front panel with a knife or a making-off pin, cut them with a pair of nippers or an equivalent tool.

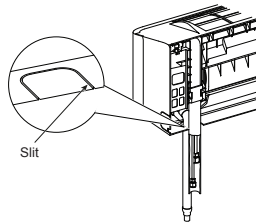

## Left-hand connection with piping

- Bend the connecting pipe so that it is laid within 43 mm above the wall surface. If the connecting pipe is laid exceeding 43 mm above the wall surface, the indoor unit may unstably be set on the wall. When bending the connecting pipe, make sure to use a spring bender so as not to crush the pipe.

### Bend the connecting pipe within a radius of 30 mm.

To connect the pipe after installation of the unit (figure)

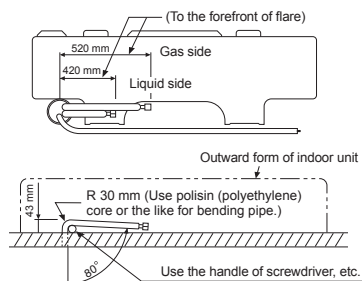

## NOTE

If the pipe is bent incorrectly, the indoor unit may unstably be set on the wall. After passing the connecting pipe through the pipe hole, connect the connecting pipes to the auxiliary pipes and wrap the facing tape around them.

## CAUTION

- Bind the auxiliary pipes (two) and connecting cable with facing tape tightly. In case of leftward piping and rear-leftward piping, bind the auxiliary pipes (two) only with facing tape.

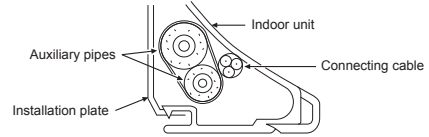

- Carefully arrange pipes so that any pipe does not stick out of the rear plate of the indoor unit.
- Carefully connect the auxiliary pipes and connecting pipes to one another and cut off the insulating tape wound on the connecting pipe to avoid double-taping at the joint; moreover, seal the joint with the vinyl tape, etc.
- Since dewing results in a machine trouble, make sure to insulate both connecting pipes. (Use polyethylene foam as insulating material.)
- When bending a pipe, carefully do it, not to crush it.

## Indoor Unit Fixing

1. Pass the pipe through the hole in the wall and hook the indoor unit on the installation plate at the upper hook.
2. Swing the indoor unit to right and left to confirm that it is firmly hooked up on the installation plate.
3. While pressing the indoor unit onto the wall, hook it at the lower part on the installation plate. Pull the indoor unit toward you to confirm that it is firmly hooked up on the installation plate.

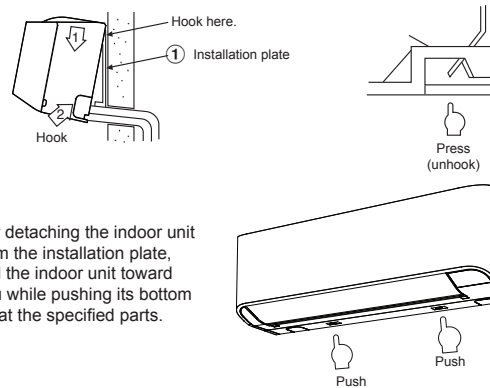

- For detaching the indoor unit from the installation plate, pull the indoor unit toward you while pushing its bottom up at the specified parts.

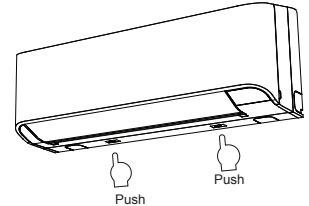

## Information

The lower part of indoor unit may float, due to the condition of piping and you cannot fix it to the installation plate. In that case, use the ⑨ screws provided to fix the unit and the installation plate.

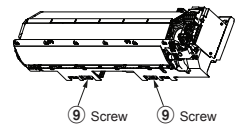

## Drainage

1. Run the drain hose sloped downwards.

### NOTE

- The hole should be made at a slight downward slant on the outdoor side.

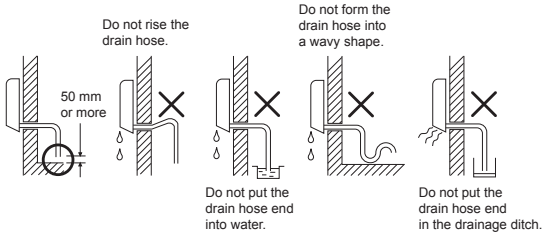

2. Put water in the drain pan and make sure that the water is drained out of doors.
3. When connecting extension drain hose, insulate the connecting part of extension drain hose with shield pipe.

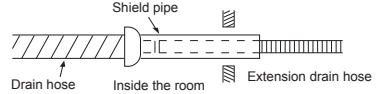

### CAUTION

Arrange the drain pipe for proper drainage from the unit. Improper drainage can result in dew-dropping.

This air conditioner has the structure designed to drain water collected from dew, which forms on the back of the indoor unit, to the drain pan. Therefore, do not store the power cord and other parts at a height above the drain guide.

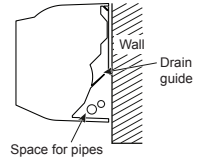

## OUTDOOR UNIT

### Installation Place

- A place which provides the spaces around the outdoor unit as shown in the diagram
- A place which can bear the weight of the outdoor unit and does not allow an increase in noise level and vibration
- A place where the operation noise and discharged air do not disturb your neighbors
- A place which is not exposed to a strong wind
- A place free of a leakage of combustible gases
- A place which does not block a passage
- When the outdoor unit is to be installed in an elevated position, be sure to secure its feet.
- The allowable length of the connecting pipe.

Models	RAS-24BAVG-E
Chargeless	Up to 15 m
Maximum length	20 m
Additional refrigerent charging	16 - 20 m (20 g / 1 m)

- The allowable height of outdoor unit installation site.

Models	RAS-24BAVG-E
Maximum height	12 m

- A place where the drain water does not raise any problems

### CAUTION

When the outdoor unit is installed in a place where the drain water might cause any problems, Seal the water leakage point tightly using a silicone adhesive or caulking compound.

### Precautions about Installation in Regions with Snowfall and Cold Temperatures

- Do not use the supplied drain nipple for draining water. Drain the water from all the drain holes directly.
- To protect the outdoor unit from snow accumulation, install a holding frame, and attach a snow protection hood and plate.
- Do not use a double-stacked design.

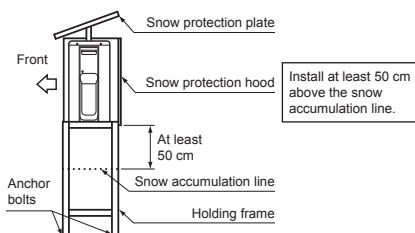

### CAUTION

1. Install the outdoor unit without anything blocking the air discharging.
2. When the outdoor unit is installed in a place always exposed to strong wind like a coast or on a high storey of a building, secure the normal fan operation using a duct or a windshield.
3. In particularly windy areas, install the unit such as to avoid admission of wind.
4. Installation in the following places may result in trouble.

- Do not install the unit in such places.
- A place full of machine oil
  - A saline-place such as the coast
  - A place full of sulfide gas
  - A place where high-frequency waves are likely to be generated as from audio equipment, welders, and medical equipment

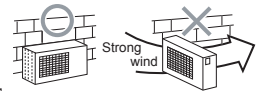

### Refrigerant Piping Connection

#### Flaring

1. Cut the pipe with a pipe cutter.

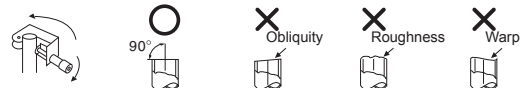

2. Insert a flare nut into the pipe and flare the pipe.

- Projection margin in flaring : A (Unit : mm)

RIGID (clutch type)

Outer dia. of copper pipe	R32 tool used	Conventional tool used
Ø6.35	0 to 0.5	1.0 to 1.5
Ø9.52	0 to 0.5	1.0 to 1.5
Ø12.70	0 to 0.5	1.0 to 1.5
Pipes thickness	0.8 mm or more	

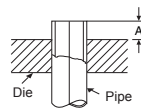

IMPERIAL (wing nut type)

Outer dia. of copper pipe	R32
Ø6.35	1.5 to 2.0
Ø9.52	1.5 to 2.0
Ø12.70	2.0 to 2.5
Pipes thickness	0.8 mm or more

### CAUTION

- Do not scratch the inner surface of the flared part when removing burrs.
- Flare processing under the condition of scratches on the inner surface of flare processing part will cause refrigerant gas leak.

## Tightening connection

Align the centers of the connecting pipes and tighten the flare nut as far as possible with your fingers. Then tighten the nut with a spanner and torque wrench as shown in the figure.

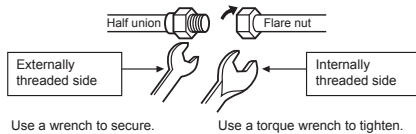

Use a wrench to secure.

Use a torque wrench to tighten.

### CAUTION

Do not apply excess torque. Otherwise, the nut may crack depending on the conditions.

(Unit : N·m)

Outer dia. of copper pipe	Tightening torque
Ø6.35 mm	16 to 18 (1.6 to 1.8 kgf·m)
Ø12.70 mm	50 to 62 (5.0 to 6.2 kgf·m)

### Tightening torque of flare pipe connections

The operating pressure of R32 is higher than that of R22 (approx. 1.6 times). It is therefore necessary to firmly tighten the flare pipe connecting sections (which connect the indoor and outdoor units) up to the specified tightening torque. Incorrect connections may cause not only a gas leakage, but also damage to the refrigeration cycle.

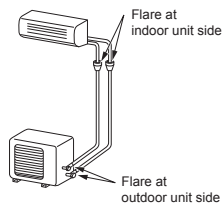

## Evacuating

After the piping has been connected to the indoor unit, you can perform the air purge together at once.

### AIR PURGE

Evacuate the air in the connecting pipes and in the indoor unit using a vacuum pump. Do not use the refrigerant in the outdoor unit. For details, see the manual of the vacuum pump.

## Using a vacuum pump

Be sure to use a vacuum pump with counter-flow prevention function so that inside oil of the pump does not flow backward into pipes of the air conditioner when the pump stops.

(If oil inside of the vacuum pump enters the air conditioner, which use R32, refrigeration cycle trouble may result.)

1. Connect the charge hose from the manifold valve to the service port of the packed valve at gas side.
2. Connect the charge hose to the port of the vacuum pump.
3. Open fully the low pressure side handle of the gauge manifold valve.
4. Operate the vacuum pump to start evacuating. Perform evacuating for about 15 minutes if the piping length is 20 meters. (15 minutes for 20 meters) (assuming a pump capacity of 27 liters per minute) Then confirm that the compound pressure gauge reading is  $-101$  kPa ( $-76$  cmHg).
5. Close the low pressure side valve handle of the gauge manifold valve.
6. Open fully the valve stem of the packed valves (both gas and liquid sides).
7. Remove the charging hose from the service port.
8. Securely tighten the caps on the packed valves.

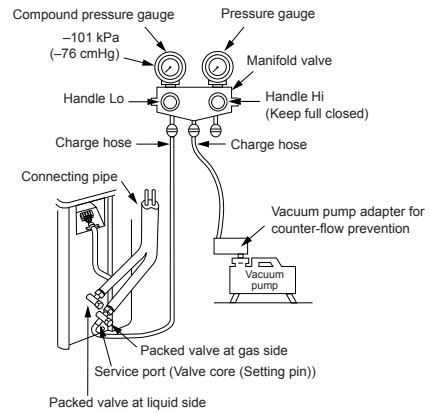

### CAUTION

#### KEEP IMPORTANT 6 POINTS FOR PIPING WORK.

- (1) Take away dust and moisture (inside of the connecting pipes).
- (2) Tighten the connections (between pipes and unit).
- (3) Evacuate the air in the connecting pipes using a VACUUM PUMP.
- (4) Check gas leak (connected points).
- (5) Be sure to fully open the packed valves before operation.
- (6) Reusable mechanical connectors and flared joints are not allowed indoors. When mechanical connectors are reused indoors, sealing parts shall be renewed. When flared joints are reused indoors, the flare part shall be refabricated.

## Packed valve handling precautions

- Open the valve stem all the way out, but do not try to open it beyond the stopper.

Pipe size of Packed Valve	Size of Hexagon wrench
12.70 mm and smaller	A = 4 mm
15.88 mm	A = 5 mm

- Securely tighten the valve cap with torque in the following table:

Cap	Cap Size (H)	Torque
Valve Rod Cap	H17 - H19	14~18 N·m (1.4 to 1.8 kgf·m)
	H22 - H30	33~42 N·m (3.3 to 4.2 kgf·m)
Service Port Cap	H14	8~12 N·m (0.8 to 1.2 kgf·m)
	H17	14~18 N·m (1.4 to 1.8 kgf·m)

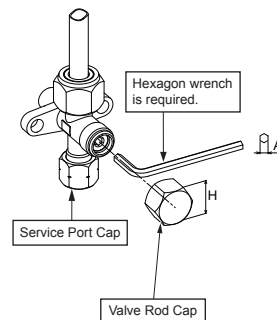

# ELECTRICAL WORKS

The power supply can be selected to connect to indoor unit or outdoor unit. Choose proper way and connect the power supply and connecting cable by follow the instruction as following.

Model	RAS-24BKVGE
Power source	50Hz, 220 – 240 V Single phase
Maximum running current	12.00A
Circuit breaker rating	15.0A
Power supply cable	H07RN-F or 60245 IEC66 (2.5 mm <sup>2</sup> or more)
Connecting cable	H07RN-F or 60245 IEC66 (1.5 mm <sup>2</sup> or more)

## Wiring Connection

### Indoor unit

**Wiring of the connecting cable can be carried out without removing the front panel.**

1. Remove the air inlet grille.  
Open the air inlet grille upward and pull it toward you.
2. Remove the terminal cover and cord clamp.
3. Insert the connecting cable (according to the local cords) into the pipe hole on the wall.
4. Take out the connecting cable through the cable slot on the rear panel so that it protrudes about 20 cm from the front.
5. Insert the connecting cable fully into the terminal block and secure it tightly with screws.
6. Tightening torque : 1.2 N·m (0.12 kgf·m)
7. Secure the connecting cable with the cord clamp.
8. Fix the terminal cover, rear plate bushing and air inlet grille on the indoor unit.

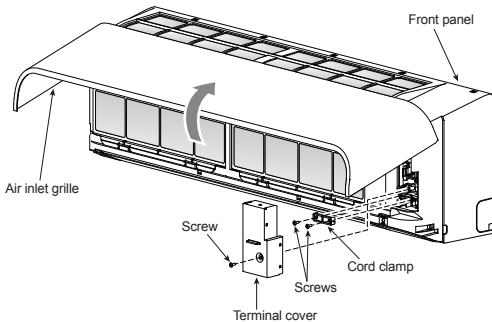

### Outdoor unit

1. Remove the valve cover, the electric parts cover and the cord clamp from the outdoor unit.
2. Connect the connecting cable to the terminal as identified by the matching numbers on the terminal block of indoor and outdoor unit.
3. Insert the power cord and the connecting cable carefully into the terminal block and secure it tightly with screws.
4. Use vinyl tape, etc. to insulate the cords which are not going to be used. Locate them so that they do not touch any electrical or metal parts.
5. Secure the power cord and the connecting cable with the cord clamp.
6. Attach the electric parts cover and the valve cover on the outdoor unit.

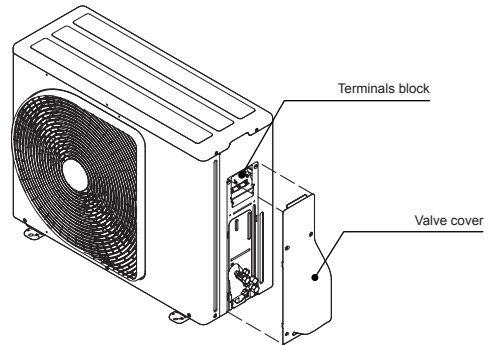

### How to install the air inlet grille on the indoor unit

- When attaching the air inlet grille, the contrary of the removed operation is performed.

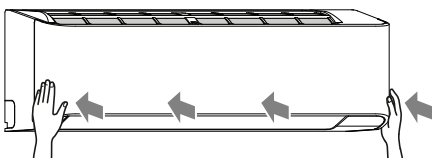
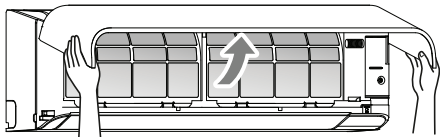

# Power Supply and Connecting Cable Connection

## Power Supply Input at Indoor Unit Terminal Block (Recommend)

### Indoor Unit

#### Power supply cable

Power supply cable connect to L N ⊕

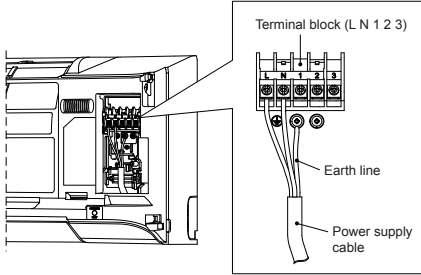

#### Stripping length of the power supply cable

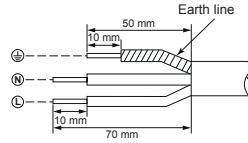

### Outdoor Unit

#### Terminal block

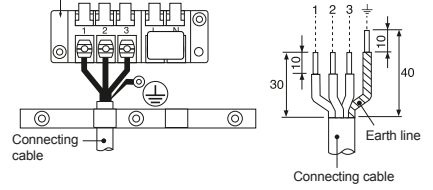

#### Connecting cable

Connecting cable connect to 1 2 3 ⊕

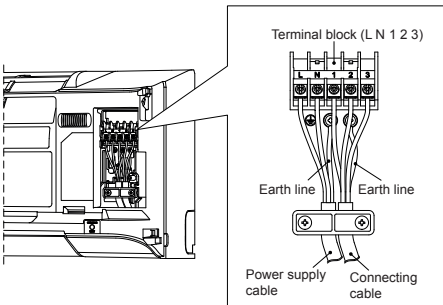

#### Stripping length of the connecting cable

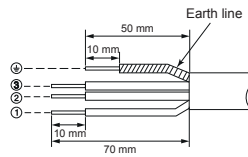

## Power Supply Input at Outdoor Unit Terminal Block (Optional)

### Indoor Unit

#### Connecting cable

Connecting cable connect to L N 1 2 3 ⊕

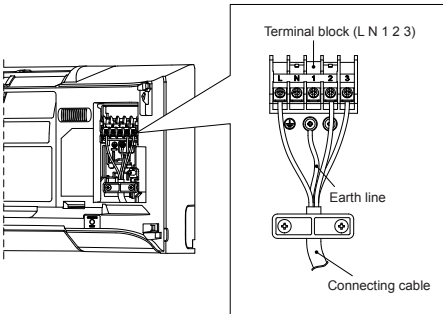

#### Stripping length of the connecting cable

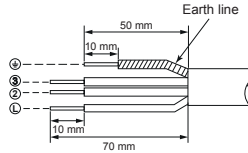

### Outdoor Unit

#### Terminal block

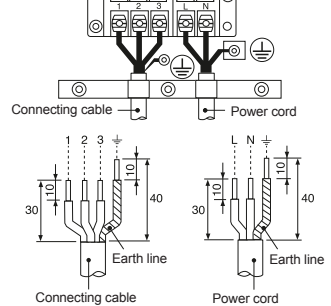

## Power Supply Input Wiring Diagram

EN

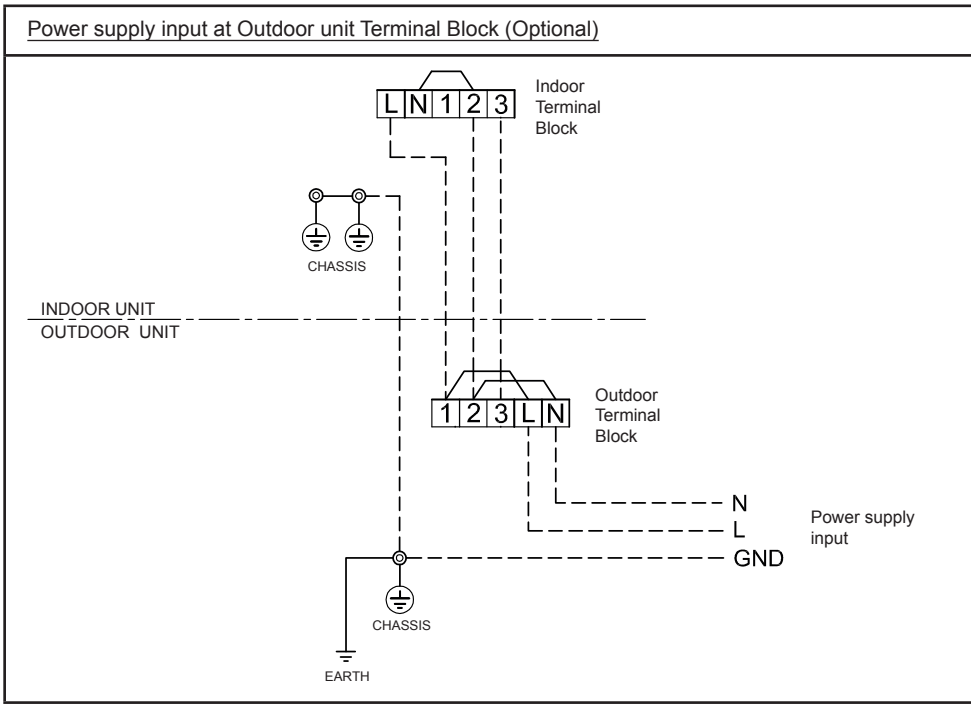
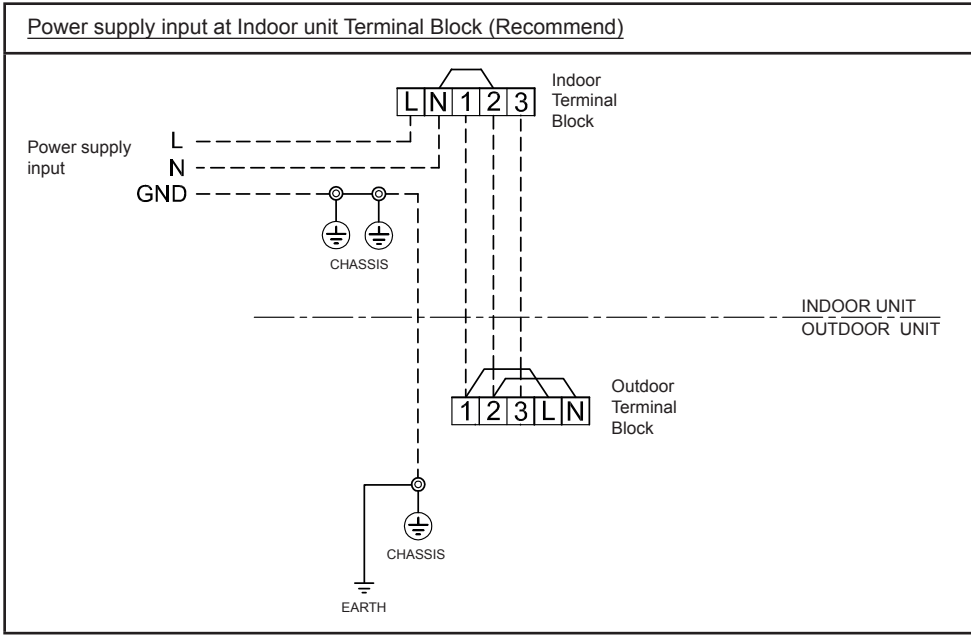

### CAUTION

1. The power supply must be same as the rated of air conditioner.
2. Prepare the power source for exclusive use with air conditioner.
3. Circuit breaker must be used for the power supply line of this air conditioner.
4. Be sure to comply power supply and connecting cable for size and wiring method.
5. Every wire must be connected firmly.
6. Perform wiring works so as to allow a general wiring capacity.
7. Wrong wiring connection may cause some electrical part burn out.
8. Incorrect or incomplete wiring is carried out, it will cause an ignition or smoke.
9. This product can be connected to main power supply.  
 Connection to fixed wiring : A switch which disconnects all poles and has a contact separation at least 3 mm must be incorporated in the fixed wiring.

# OTHERS

## Gas Leak Test

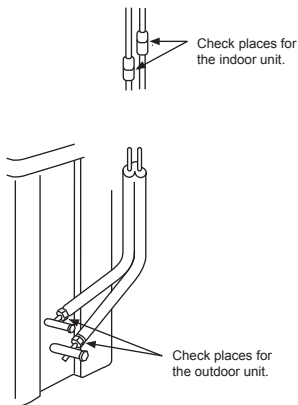

- Check the flare nut connections for the gas leak with a gas leak detector or soap water.

## Remote Control A-B Selection

- When two indoor units are installed in the same room or adjacent two rooms, if operating a unit, two units may receive the remote control signal simultaneously and operate. In this case, the operation can be preserved by setting either one remote control to B setting. (Both are set to A setting in factory shipment.)
- The remote control signal is not received when the settings of indoor unit and remote control are different.
- There is no relation between A setting/B setting and A room/B room when connecting the piping and cables.

To separate using of remote control for each indoor unit in case of 2 air conditioner are installed near.

### Remote Control B Setup.

1. Press [RESET] button on the indoor unit to turn the air conditioner ON.
2. Point the remote control at the indoor unit.
3. Push and hold [CHECK] button on the Remote Control by the tip of the pencil. "00" will be shown on the display (Picture ①).
4. Press [MODE] during pushing [CHECK]. "B" will show on the display and "00" will disappear and the air conditioner will turn OFF. The Remote Control B is memorized (Picture ②).

- Note :
1. Repeat above step to reset Remote Control to be A.
  2. Remote Control A have not "A" display.
  3. Default setting of Remote Control from factory is A.

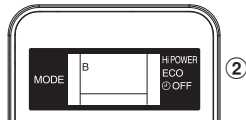
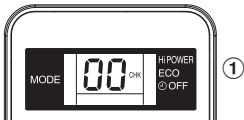

## Test Operation

To switch the TEST RUN (COOL) mode, press [RESET] button for 10 seconds. (The beeper will make a short beep.)

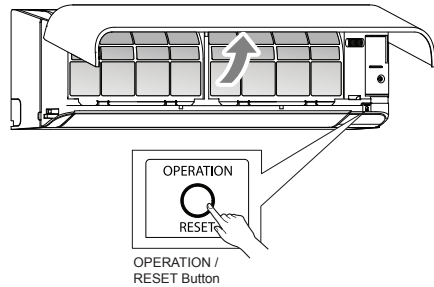

## Auto Restart Setting

This product is designed so that, after a power failure, it can restart automatically in the same operating mode as before the power failure.

### Information

The product was shipped with Auto Restart function in the off position. Turn it on as required.

### How to set the Auto Restart

1. Press and hold the [RESET] button on the indoor unit for 3 seconds to set the operation. (3 beep sound and OPERATION lamp blink 5 time/sec for 5 seconds)
2. Press and hold the [RESET] button on the indoor unit for 3 seconds to cancel the operation. (3 beep sound but OPERATION lamp does not blink)
  - In case of ON timer or OFF timer are set, AUTO RESTART OPERATION does not activate.



# APPENDIX

## Work instructions

The existing R22 and R410A piping can be reused for inverter R32 product installations.



## WARNING

Confirming the existence of scratches or dents on the existing pipes and confirming the reliability of the pipe strength are conventionally referred to the local site.  
 If the specified conditions can be cleared, it is possible to update existing R22 and R410A pipes to those for R32 models.

## Basic conditions needed to reuse existing pipes

Check and observe the presence of three conditions in the refrigerant piping works.

1. **Dry** (There is no moisture inside of the pipes.)
2. **Clean** (There is no dust inside of the pipes.)
3. **Tight** (There are no refrigerant leaks.)

## Restrictions for use of existing pipes

In the following cases, the existing pipes should not be reused as they are. Clean the existing pipes or exchange them with new pipes.

1. When a scratch or dent is heavy, be sure to use new pipes for the refrigerant piping works.
2. When the existing pipe thickness is thinner than the specified "Pipe diameter and thickness," be sure to use new pipes for the refrigerant piping works.

- The operating pressure of R32 is high (1.6 times that of R22). If there is a scratch or dent on the pipe or a thinner pipe is used, the pressure strength may be inadequate, which may cause the pipe to break in the worst case.

## \* Pipe diameter and thickness (mm)

Pipe outer diameter	Ø6.4	Ø9.5	Ø12.7
Thickness	R32, R410A R22	0.8	0.8

3. When the outdoor unit was left with the pipes disconnected, or the gas leaked from the pipes and the pipes were not repaired and refilled.
  - There is the possibility of rain water or air, including moisture, entering the pipe.
4. When refrigerant cannot be recovered using a refrigerant recovery unit.
  - There is the possibility that a large quantity of dirty oil or moisture remains inside the pipes.

5. When a commercially available dryer is attached to the existing pipes.
  - There is the possibility that copper green rust has been generated.
6. When the existing air conditioner is removed after refrigerant has been recovered.
  - Check if the oil is judged to be clearly different from normal oil.

7. After the existing air conditioner is operated in cooling mode for approx. 30 minutes or longer,\* recover the refrigerant.
  - For cleaning the pipes and recovering oil
    - Refrigerant recovery: Pump down method
  - Remove the existing air conditioner from the piping and carry out flushing (nitrogen pressure 0.5 MPa) to remove any remains inside of the pipe.
    - Note:** In case of twin pipes, also be sure to flush the branching pipe.
8. When discolored oil, a large quantity of residue, shiny metal dust, or other wear residue or mixture of foreign matter is observed, trouble will occur.
9. When temporary installation and removal of the air conditioner are repeated such as when leased etc.
  - If the type of refrigerant oil of the existing air conditioner is other than the following oil (Mineral oil, Suniso, Freol-S, MS (Synthetic oil), alkyl benzene (HAB, Barrel-freeze), ester series, PVE only of ether series.
    - The winding-insulation of the compressor may deteriorate.

## NOTE

The above descriptions are results have been confirmed by our company and represent our views on our air conditioners, but do not guarantee the use of the existing pipes of air conditioners that have adopted R32 in other companies.

## Curing of pipes

When removing and opening the indoor or outdoor unit for a long time, cure the pipes as follows:

- Otherwise rust may be generated when moisture or foreign matter due to condensation enters the pipes.
- The rust cannot be removed by cleaning, and new pipes are necessary.

Placement location	Term	Curing manner
Outdoors	1 month or more	Pinching
Indoors	Less than 1 month Every time	Pinching or taping

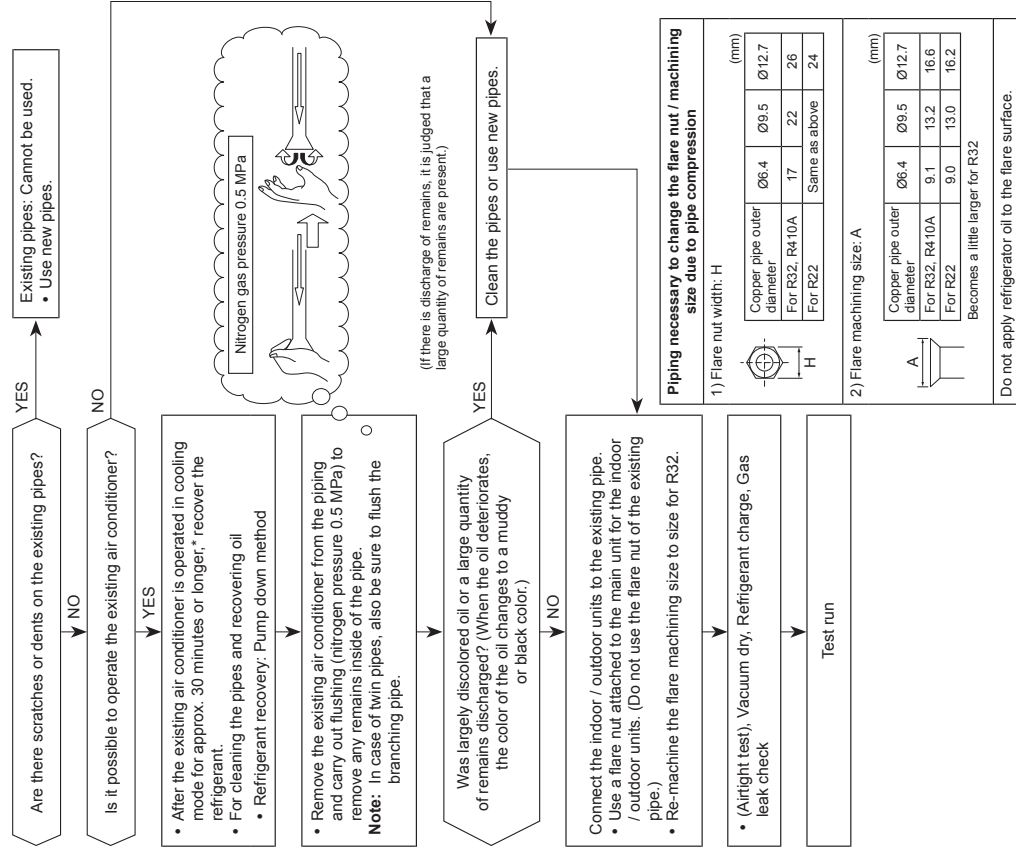

The image features the Toshiba logo in a bold, black, sans-serif font, centered on a white background. The logo is surrounded by several semi-transparent, gray, spherical bubbles of varying sizes, some of which have a slight shadow, giving them a three-dimensional appearance. The bubbles are scattered across the page, with a larger one near the top center and others of various sizes around it. In the bottom right corner, there is a gray curved shape that partially overlaps the white background.

**TOSHIBA**



1120650130