

TOSHIBA

Leading Innovation >>>

AIR CONDITIONER (MULTI TYPE) Installation Manual



Indoor Unit

Model name:

For commercial use

Floor Standing Type

MMF-AP0156H1-E

MMF-AP0366H1-E

MMF-AP0186H1-E

MMF-AP0486H1-E

MMF-AP0246H1-E

MMF-AP0566H1-E

MMF-AP0276H1-E

Original instruction

Please read this Installation Manual carefully before installing the Air Conditioner.

- This Manual describes the installation method of the indoor unit.
- For installation of the outdoor unit, follow the Installation Manual attached to the outdoor unit.

ADOPTION OF NEW REFRIGERANT

This Air Conditioner uses R410A an environmentally friendly refrigerant.

Contents

1	Precautions for safety	3
2	Accessory parts	7
3	Selection of installation place	7
4	Installation	8
5	Drain piping	9
6	Refrigerant piping	11
7	Electrical connection	12
8	Applicable controls	14
9	Test run	15
10	Maintenance	16
11	Troubleshooting	17
12	Specifications	22

Thank you for purchasing this Toshiba air conditioner.

Please read carefully through these instructions that contain important information which complies with the "Machinery" Directive (Directive 2006/42/EC), and ensure that you understand them.

After completing the installation work, hand over this Installation Manual as well as the Owner's Manual provided with the outdoor unit to the user, and ask the user to keep them in a safe place for future reference.

Generic Denomination: Air Conditioner

Definition of Qualified Installer or Qualified Service Person

The air conditioner must be installed, maintained, repaired and removed by a qualified installer or qualified service person. When any of these jobs is to be done, ask a qualified installer or qualified service person to do them for you. A qualified installer or qualified service person is an agent who has the qualifications and knowledge described in the following table.

Agent	Qualifications and knowledge which the agent must have
Qualified installer	<ul style="list-style-type: none"> The qualified installer is a person who installs, maintains, relocates and removes the air conditioners made by Toshiba Carrier Corporation. He or she has been trained to install, maintain, relocate and remove the air conditioners made by Toshiba Carrier Corporation or, alternatively, he or she has been instructed in such operations by an individual or individuals who have been trained and is thus thoroughly acquainted with the knowledge related to these operations. The qualified installer who is allowed to do the electrical work involved in installation, relocation and removal has the qualifications pertaining to this electrical work as stipulated by the local laws and regulations, and he or she is a person who has been trained in matters relating to electrical work on the air conditioners made by Toshiba Carrier Corporation or, alternatively, he or she has been instructed in such matters by an individual or individuals who have been trained and is thus thoroughly acquainted with the knowledge related to this work. The qualified installer who is allowed to do the refrigerant handling and piping work involved in installation, relocation and removal has the qualifications pertaining to this refrigerant handling and piping work as stipulated by the local laws and regulations, and he or she is a person who has been trained in matters relating to refrigerant handling and piping work on the air conditioners made by Toshiba Carrier Corporation or, alternatively, he or she has been instructed in such matters by an individual or individuals who have been trained and is thus thoroughly acquainted with the knowledge related to this work. The qualified installer who is allowed to work at heights has been trained in matters relating to working at heights with the air conditioners made by Toshiba Carrier Corporation or, alternatively, he or she has been instructed in such matters by an individual or individuals who have been trained and is thus thoroughly acquainted with the knowledge related to this work.
Qualified service person	<ul style="list-style-type: none"> The qualified service person is a person who installs, repairs, maintains, relocates and removes the air conditioners made by Toshiba Carrier Corporation. He or she has been trained to install, repair, maintain, relocate and remove the air conditioners made by Toshiba Carrier Corporation or, alternatively, he or she has been instructed in such operations by an individual or individuals who have been trained and is thus thoroughly acquainted with the knowledge related to these operations. The qualified service person who is allowed to do the electrical work involved in installation, repair, relocation and removal has the qualifications pertaining to this electrical work as stipulated by the local laws and regulations, and he or she is a person who has been trained in matters relating to electrical work on the air conditioners made by Toshiba Carrier Corporation or, alternatively, he or she has been instructed in such matters by an individual or individuals who have been trained and is thus thoroughly acquainted with the knowledge related to this work. The qualified service person who is allowed to do the refrigerant handling and piping work involved in installation, repair, relocation and removal has the qualifications pertaining to this refrigerant handling and piping work as stipulated by the local laws and regulations, and he or she is a person who has been trained in matters relating to refrigerant handling and piping work on the air conditioners made by Toshiba Carrier Corporation or, alternatively, he or she has been instructed in such matters by an individual or individuals who have been trained and is thus thoroughly acquainted with the knowledge related to this work. The qualified service person who is allowed to work at heights has been trained in matters relating to working at heights with the air conditioners made by Toshiba Carrier Corporation or, alternatively, he or she has been instructed in such matters by an individual or individuals who have been trained and is thus thoroughly acquainted with the knowledge related to this work.

Definition of Protective Gear

When the air conditioner is to be transported, installed, maintained, repaired or removed, wear protective gloves and 'safety' work clothing.

In addition to such normal protective gear, wear the protective gear described below when undertaking the special work detailed in the following table.

Failure to wear the proper protective gear is dangerous because you will be more susceptible to injury, burns, electric shocks and other injuries.

Work undertaken	Protective gear worn
All types of work	Protective gloves 'Safety' working clothing
Electrical-related work	Gloves to provide protection for electricians Insulating shoes Clothing to provide protection from electric shock
Work done at heights (50 cm or more)	Helmets for use in industry
Transportation of heavy objects	Shoes with additional protective toe cap
Repair of outdoor unit	Gloves to provide protection for electricians



■ Centre of gravity and weight

(Unit: mm)

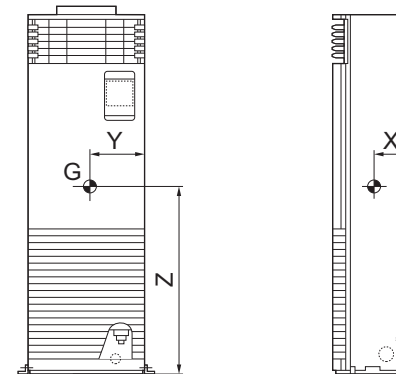
Model name	X(mm)	Y(mm)	Z(mm)	Total weight (kg)
MMF-AP0156H1-E	90	290	830	46
MMF-AP0186H1-E				47
MMF-AP0246H1-E				
MMF-AP0276H1-E	180	295	860	62
MMF-AP0366H1-E				
MMF-AP0486H1-E				
MMF-AP0566H1-E				



■ **Warning indications on the air conditioner unit**

Warning indication		Description
 <p>WARNING ELECTRICAL SHOCK HAZARD Disconnect all remote electric power supplies before servicing.</p>	<p>WARNING ELECTRICAL SHOCK HAZARD Disconnect all remote electric power supplies before servicing.</p>	
 <p>WARNING Moving parts. Do not operate unit with grille removed. Stop the unit before the servicing.</p>	<p>WARNING Moving parts. Do not operate unit with grille removed. Stop the unit before the servicing.</p>	
 <p>CAUTION Do not touch the aluminum fins of the unit. Doing so may result in injury.</p>	<p>CAUTION Do not touch the aluminium fins of the unit. Doing so may result in injury.</p>	

1 Precautions for safety

The manufacturer shall not assume any liability for the damage caused by not observing the description of this manual.

⚠ WARNING

General

- Before starting to install the air conditioner, read through the Installation Manual carefully, and follow its instructions to install the air conditioner.
- Only a qualified installer or service person is allowed to do installation work. Inappropriate installation may result in water leakage, electric shock or fire.
- Do not use any refrigerant different from the one specified for complement or replacement. Otherwise, abnormally high pressure may be generated in the refrigeration cycle, which may result in a failure or explosion of the product or an injury to your body.
- Before opening the intake grille of the indoor unit or service panel of the outdoor unit, set the circuit breaker to the OFF position. Failure to set the circuit breaker to the OFF position may result in electric shocks through contact with the interior parts. Only a qualified installer(*1) or qualified service person(*1) is allowed to remove the intake grille of the indoor unit or service panel of the outdoor unit and do the work required.
- Before carrying out the installation, maintenance, repair or removal work, set the circuit breaker to the OFF position. Otherwise, electric shocks may result.
- Place a “Work in progress” sign near the circuit breaker while the installation, maintenance, repair or removal work is being carried out. There is a danger of electric shocks if the circuit breaker is set to ON by mistake.
- Only a qualified installer(*1) or qualified service person(*1) is allowed to undertake work at heights using a stand of 50 cm or more or to remove the intake grille of the indoor unit to undertake work.
- Wear protective gloves and safety work clothing during installation, servicing and removal.
- Do not touch the aluminium fin of the unit. You may injure yourself if you do so. If the fin must be touched for some reason, first put on protective gloves and safety work clothing, and then proceed.
- Do not climb onto or place objects on top of the outdoor unit. You may fall or the objects may fall off of the outdoor unit and result in injury.

- When work is performed at heights, use a ladder which complies with the ISO 14122 standard, and follow the procedure in the ladder's instructions. Also wear a helmet for use in industry as protective gear to undertake the work.
- Before cleaning the filter or other parts of the outdoor unit, set the circuit breaker to OFF without fail, and place a "Work in progress" sign near the circuit breaker before proceeding with the work.
- Before working at heights, put a sign in place so that no-one will approach the work location, before proceeding with the work. Parts and other objects may fall from above, possibly injuring a person below. While carrying out the work, wear a helmet for protection from falling objects.
- The refrigerant used by this air conditioner is the R410A.
- The air conditioner must be transported in stable condition. If any part of the product is broken, contact the dealer.
- When the air conditioner must be transported by hand, carry it by four or more people.
- Do not move or repair any unit by yourself. There is high voltage inside the unit. You may get electric shock when removing the cover and main unit.
- This appliance is intended to be used by expert or trained users in shops, in light industry, or for commercial use by lay persons.

Selection of installation location

- When the air conditioner is installed in a small room, provide appropriate measures to ensure that the concentration of refrigerant leakage occur in the room does not exceed the critical level.
- Do not install in a location where flammable gas leaks are possible. If the gas leak and accumulate around the unit, it may ignite and cause a fire.
- To transport the air conditioner, wear shoes with additional protective toe caps.
- To transport the air conditioner, do not take hold of the bands around the packing carton. You may injure yourself if the bands should break.
- Do not place any combustion appliance in a place where it is directly exposed to the wind of air conditioner, otherwise it may cause imperfect combustion.

Installation

- Install the air conditioner securely in a location where the base can sustain the weight adequately. If the strength is not enough, the unit may fall down resulting in injury.
- Follow the instructions in the Installation Manual to install the air conditioner. Failure to follow these instructions may cause the product to fall down or topple over or give rise to noise, vibration, water leakage or other trouble.
- Carry out the specified installation work to guard against the possibility of high winds and earthquake. If the air conditioner is not installed appropriately, a unit may topple over or fall down, causing an accident.
- If refrigerant gas has leaked during the installation work, ventilate the room immediately. If the leaked refrigerant gas comes in contact with fire, noxious gas may generate.
- Use forklift to carry in the air conditioner units and use winch or hoist at installation of them.

Refrigerant piping

- Install the refrigerant pipe securely during the installation work before operating the air conditioner. If the compressor is operated with the valve open and without refrigerant pipe, the compressor sucks air and the refrigeration cycles is over pressurized, which may cause a injury.
- Tighten the flare nut with a torque wrench in the specified manner. Excessive tighten of the flare nut may cause a crack in the flare nut after a long period, which may result in refrigerant leakage.
- After the installation work, confirm that refrigerant gas does not leak. If refrigerant gas leaks into the room and flows near a fire source, such as a cooking range, noxious gas may be generated.
- When the air conditioner has been installed or relocated, follow the instructions in the Installation Manual and purge the air completely so that no gases other than the refrigerant will be mixed in the refrigerating cycle. Failure to purge the air completely may cause the air conditioner to malfunction.
- Nitrogen gas must be used for the airtight test.
- The charge hose must be connected in such a way that it is not slack.

Electrical wiring

- Only a qualified installer(*1) or qualified service person(*1) is allowed to carry out the electrical work of the air conditioner. Under no circumstances must this work be done by an unqualified individual since failure to carry out the work properly may result in electric shocks and / or electrical leaks.
- To connect the electrical wires, repair the electrical parts or undertake other electrical jobs, wear gloves to provide protection for electricians and from heat, insulating shoes and clothing to provide protection from electric shocks. Failure to wear this protective gear may result in electric shocks.
- Use wiring that meets the specifications in the Installation Manual and the stipulations in the local regulations and laws. Use of wiring which does not meet the specifications may give rise to electric shocks, electrical leakage, smoking and / or a fire.
- Connect earth wire. (Grounding work)
Incomplete grounding causes an electric shock.
- Do not connect earth wires to gas pipes, water pipes, and lightning conductor or telephone earth wires.
- After completing the repair or relocation work, check that the earth wires are connected properly.
- Install a circuit breaker that meets the specifications in the installation manual and the stipulations in the local regulations and laws.
- Install the circuit breaker where it can be easily accessed by the agent.
- When installing the circuit breaker outdoors, install one which is designed to be used outdoors.
- Under no circumstances the power wire must not be extended.
Connection trouble in the places where the wire is extended may give rise to smoking and / or a fire.
- Electrical wiring work shall be conducted according to law and regulation in the community and installation manual.
Failure to do so may result in electrocution or short circuit.

Test run

- Before operating the air conditioner after having completed the work, check that the electrical control box cover of the indoor unit and service panel of the outdoor unit are closed, and set the circuit breaker to the ON position. You may receive an electric shock if the power is turned on without first conducting these checks.
- If there is any kind of trouble (such as an error display has appeared, smell of burning, abnormal sounds, the air conditioner fails to cool or heat or water is leaking) has occurred in the air conditioner, do not touch the air conditioner yourself but set the circuit breaker to the OFF position, and contact a qualified service person. Take steps to ensure that the power will not be turned on (by marking "out of service" near the circuit breaker, for instance) until qualified service person arrives. Continuing to use the air conditioner in the trouble status may cause mechanical problems to escalate or result in electric shocks or other trouble.
- After the work has finished, use an insulation tester set (500 V Megger) to check the resistance is 1 MΩ or more between the charge section and the non-charge metal section (Earth section). If the resistance value is low, a disaster such as a leak or electric shock is caused at user's side.
- Upon completion of the installation work, check for refrigerant leaks and check the insulation resistance and water drainage. Then conduct a test run to check that the air conditioner is operating properly.

Explanations given to user

- Upon completion of the installation work, tell the user where the circuit breaker is located. If the user does not know where the circuit breaker is, he or she will not be able to turn it off in the event that trouble has occurred in the air conditioner.
- If the fan grille is damaged, do not approach the outdoor unit but set the circuit breaker to the OFF position, and contact a qualified service person(*1) to have the repairs done. Do not set the circuit breaker to the ON position until the repairs are completed.

Relocation

- Only a qualified installer(*1) or qualified service person(*1) is allowed to relocate the air conditioner. It is dangerous for the air conditioner to be relocated by an unqualified individual since a fire, electric shocks, injury, water leakage, noise and / or vibration may result.
 - When carrying out the pump-down work shut down the compressor before disconnecting the refrigerant pipe. Disconnecting the refrigerant pipe with the service valve left open and the compressor still operating will cause air or other gas to be sucked in, raising the pressure inside the refrigeration cycle to an abnormally high level, and possibly resulting in rupture, injury or other trouble.
-





CAUTION

New Refrigerant Air Conditioner Installation

- **This air conditioner adopts the new HFC refrigerant (R410A) which does not destroy ozone layer.**
 - The characteristics of R410A refrigerant are; easy to absorb water, oxidizing membrane or oil, and its pressure is approx. 1.6 times higher than that of refrigerant R22. Accompanied with the new refrigerant, refrigerating oil has also been changed. Therefore, do not let water, dust, former refrigerant, or refrigerating oil enter the refrigerating cycle during installation work.
 - To prevent charging an incorrect refrigerant and refrigerating oil, the sizes of connecting sections of charging port of the main unit and installation tools are changed from those for the conventional refrigerant.
 - Accordingly the exclusive tools are required for the new refrigerant (R410A).
 - For connecting pipes, use new and clean piping designed for R410A, and please care so that water or dust does not enter.
-

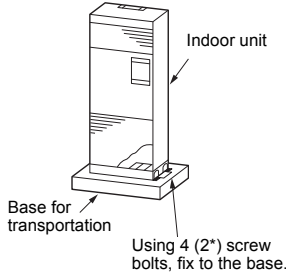
(*1) Refer to the "Definition of Qualified Installer or Qualified Service Person."

2 Accessory parts

Attached position	Part name	Q'ty	Shape	Stored position
Upper part of main unit	Bracket for fixing to wall	1		
Accessory bag	Installation Manual	1	—	
	CD-R	1	—	
	Heat insulator	2		
	Screw bolt	4 (2*)		
	Heat insulator	2		
Lower part of main unit	Bracket for fixing to floor	2		

* Quantities in the parentheses are for MMF-AP036, AP048 and AP056 models.
The brackets for fixing to the floor are already mounted to the indoor unit.

3 Selection of installation place

Avoid installing in the following places.

Select a location for the indoor unit where the cool or warm air will circulate evenly.

Avoid installation in the following kinds of locations.

- Saline area (coastal area).
- Locations with acidic or alkaline atmospheres (such as areas with hot springs, factories where chemicals or pharmaceuticals are made and places where the exhaust air from combustion appliances will be sucked into the unit).
Doing so may cause the heat exchanger (its aluminum fins and copper pipes) and other parts to become corroded.
- Locations with atmospheres with mist of cutting oil or other types of machine oil.
Doing so may cause the heat exchanger to become corroded, mists caused by the blockage of the heat exchanger to be generated, the plastic parts to be damaged, the heat insulators to peel off, and other such problems to result.
- Places where iron or other metal dust is present. If iron or other metal dust adheres to or collects on the interior of the air conditioner, it may spontaneously combust and start a fire.
- Locations where vapors from food oils are formed (such as kitchens where food oils are used).
Blocked filters may cause the air conditioner's performance to deteriorate, condensation to form, the plastic parts to be damaged, and other such problems to result.
- Locations near obstructions such as ventilation openings or lighting fixtures where the flow of the blown air will be disrupted (a disruption of the air flow may cause the air conditioner's performance to deteriorate or the unit to shut down).
- Locations where an in-house power generator is used for the power supply.
The power line frequency and voltage may fluctuate, and the air conditioner may not work properly as a result.
- On truck cranes, ships or other moving conveyances.
- The air conditioner must not be used for special applications (such as for storing food, plants, precision instruments or art works).
(The quality of the items stored may be degraded.)
- Locations where high frequencies are generated (by inverter equipment, in-house power generators, medical equipment or communication equipment).
(Malfunctioning or control trouble in the air conditioner or noise may adversely affect the equipment's operation.)
- Locations where there is anything under the unit installed that would be compromised by wetness.
(If the drain has become blocked or when the humidity is over 80%, condensation from the indoor unit will drip, possibly causing damage to anything underneath.)
- In the case of the wireless type of system, rooms with the inverter type of fluorescent lighting or locations exposed to direct sunlight.
(The signals from the wireless remote controller may not be sensed.)
- Locations where organic solvents are being used.
- The air conditioner cannot be used for liquefied carbonic acid cooling or in chemical plants.
- Location near doors or windows where the air conditioner may come into contact with high-temperature, high-humidity outdoor air.
(Condensation may occur as a result.)
- Locations where special sprays are used frequently.

■ Installation space

(Unit: mm)

Reserve sufficient space required for installation or service work.

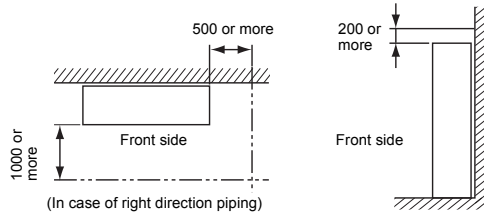

REQUIREMENT

When using the air conditioner under condition of high humidity, attach the heat insulator to the side face and the rear side of the indoor unit.

■ Filter cleaning sign term setting

The lighting term setup of the filter sign (Notification of filter cleaning) of the remote controller can be changed according to the condition of installation.

For setup method, refer to "Filter sign setting" in the Applicable controls of this Manual.

■ To open the intake grille

The intake grille is fixed by the screws for safety reasons. Use a screwdriver to unfasten the screws of the intake grille (two places) to open the intake grille. The screws are designed to stay on the intake grille.

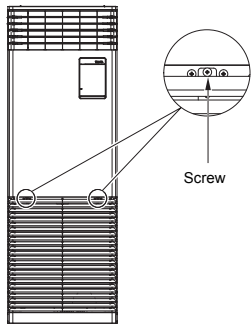

4 Installation

CAUTION

Strictly comply with the following rules to prevent damage of the indoor units and human injury.

- Do not put a heavy article on the indoor unit or let a person get on it. (Even units are packaged)
- Carry in the indoor unit as it is packaged if possible. If carrying in the indoor unit unpacked by necessity, use buffering cloth or other material not to damage the unit.
- Carry the package by four or more persons, and do not bundle it with plastic band at positions other than specified.
- Four or more persons must carry the product (without package) by holding it at the locations shown in the figure.

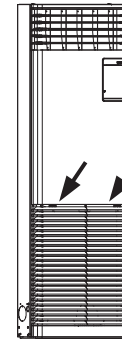

- Be sure to take measures to prevent falling at the wall surface and the floor and fix it surely considering prevention of accident of falling because this unit is formed into a thin type. If it is not fixed, a falling accident may occur.
- After carry in the indoor unit to the specified place, fix it to the wall and the floor immediately for safety.

■ Installation of indoor unit

Fixing to the wall surface

Use the attached wall fixing bracket by inverting it at upper side of the unit. Fix the indoor unit to the wall surface using the attached screw bolts, anchor bolts or etc. at two positions. A many holes for fixing the indoor unit to wall surface and for fixing the indoor unit itself are provided on the bracket. Sliding the bracket right and left sides, select a position which can securely fix the indoor unit and then fix it.

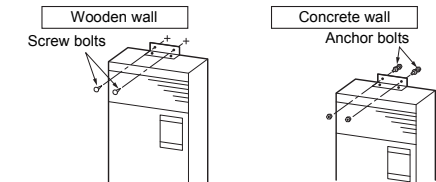

A hole on the wall fixing bracket for the indoor unit is a long hole. Therefore the indoor unit can be fixed at any position keeping clearance from 0 to 50 mm.

As shown below, it is also possible to fix the indoor unit without inverting the bracket. (In this case, keep clearance with length of head of the bolt between the indoor unit and the wall.)

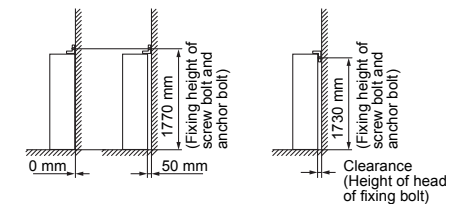

Fixing to the floor

Use the attached the attached floor fixing bracket to fix the lower right and left sides of the indoor unit to the floor.

To fix to the indoor unit, use the side plate screws and use the screw bolts or anchor bolts for fixing to the floor respectively, and then fix the indoor unit at total four positions, two positions for right and left each.

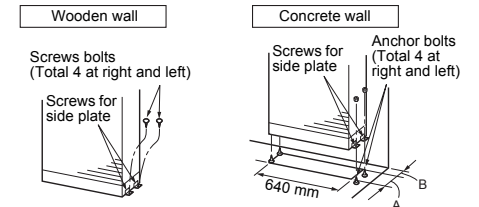

(Unit: mm)

Model MMF-	A	B
AP015H to AP027H type	88	42 to 92
AP036H to AP056H type	258	52 to 102

Indoor unit fixing figure (Example)

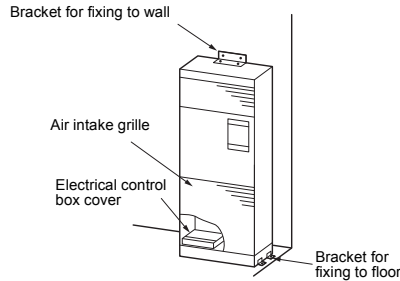

REQUIREMENT

In case of installing the indoor unit to the floor and the wall other than wooden floor and wall, the six anchor bolts (M8 × L50 or longer) are required. Procure them at the local site.

Direction of vertical louver

The direction of the auto turn louver (Vertical louver) may change during transportation. As shown below, lift up the vertical louver lightly, turn it matching with the direction of the plastic coupling rod, insert it into clearance of the extrusion, and then arrange the direction of the vertical louver to the desired direction.

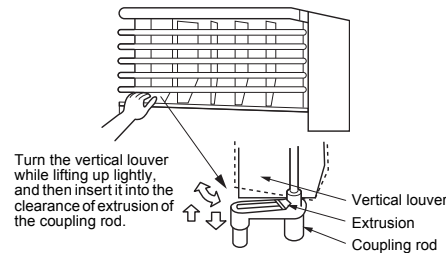

Installation of remote controller (Sold separately)

For installation of the wired remote controller, follow the Installation Manual attached with the remote controller.

- Pull out the remote controller cord together with the refrigerant pipe or drain pipe. Pass the remote controller cord through upper side of the refrigerant pipe and drain pipe.
- Do not leave the remote controller at a place exposed to the direct sunlight and near a stove.

Wireless remote controller

The sensor of indoor unit with wireless remote controller can receive a signal by distance within approx. 8 m. Based upon it, determine a place where the remote controller is operated and the installation place.

- Operate the remote controller, confirm that the indoor unit receives a signal surely, and then install it.
- Keep 1 m or more from the devices such as television, stereo. (Disturbance of image or noise may generate.)
- To prevent a malfunction, select a place where is not influenced by a fluorescent light or direct sunlight.
- Two or more (Up to 6 units) indoor units with wireless type remote controller can be installed in the same room.

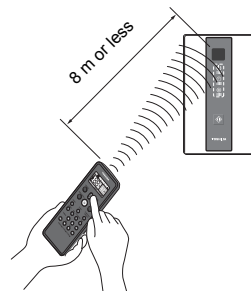

5 Drain piping

CAUTION

- Following the Installation Manual, perform the drain piping work so that water is properly drained. Apply a heat insulation so as not to cause a dew condensation. Inappropriate piping work may result in water leakage in the room and wet furniture.
- After opening the knockout hole, deburr the edge. Burrs adhered to opening of the knockout hole may causes an injury by touching it.

- Provide the indoor drain piping with proper heat insulation.
- Provide the area where the pipe connects to the indoor unit with proper heat insulation. Improper heat insulation will cause condensation to form.
- The drain pipe must be sloping downward (at an angle of 1/100 or more), and do not run the pipe up and down (arched shape) or allow it to form traps. Doing so may cause abnormal sounds.
- Restrict the length of the traversing drain pipe to 20 meters or less. For a long pipe, provide support brackets at intervals of 1.5 to 2 meters to prevent flapping.
- Install the collective piping as shown in the following figure.
- Do not provide any air vents. Otherwise, the drain water will spout, causing water to leak.
- Do not allow any force to be applied to the connection area with the drain pipe.

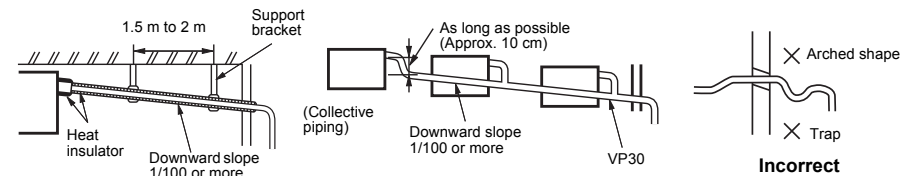

Pipe material, size and insulator

The following materials for piping work and insulating process are procured locally.

Pipe material	Hard vinyl chloride pipe (Nominal outer diameter Ø20 mm)
Insulator	Foamed polyethylene foam, thickness: 6 mm or more

■ Connecting drain pipe

The following materials for piping work and insulating process are procured locally.

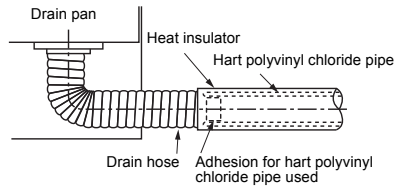

REQUIREMENT

- Using adhesive agent for vinyl chloride, connect the hard vinyl chloride pipes certainly so that water does not leak.
- It requires several times to dry and harden the adhesive agent. (Refer to Guide Manual of the adhesive agent.)
In this time, be sure not to apply force to the connecting section with the drain pipes.

Piping method

Drain and refrigerant pipes can be drew out from left, right, back or bottom depending on the installation location. However, drain pipes can be drew out from left only when the refrigerant pipes are drew out from left. The drain hose must be fix to the refrigerant pipe with banding band and installed with gradient of 1/100 or more. The drain hose end connected to the indoor unit must be free from external force.

- Do not route the drain hose and refrigerant pipes over the electrical control box. Condensed water from the pipes may enter the electrical control box and cause malfunction. Exclude AP015 to AP027 models.
- On the AP015 to AP027 models, the drain hose and refrigerant pipes coming out of the electrical control box must be 5 mm apart. If the clearance is less than 5 mm, it will be hard to remove the drip-proof cover and the electrical control box can not be taken out.

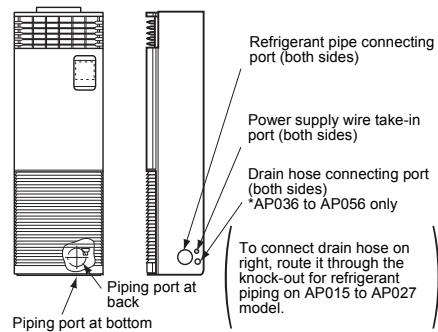

• To connect drain hose on left

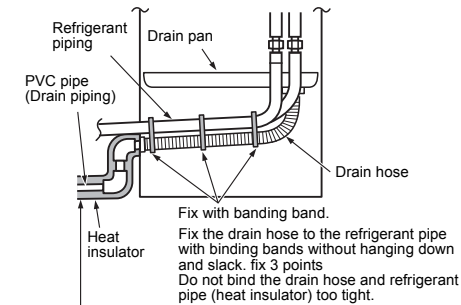

• To connect drain hose on right

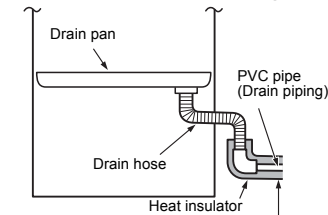

*Connect and fix drain pipe at outside of the unit on site.

(Install the drain hose with gradient of 1/100 or more to connect it to unit on both left and right sides.)

■ Check the draining

- After piping work, gets completed, remove the air intake grille and pour water in the drain pan to check water drain and water leakage from connecting part of the drain hose.
- After check of the water drain, attach the air intake grille as before.

6 Refrigerant piping

⚠ CAUTION

When the refrigerant pipe is long, provide support brackets at intervals of 2.5 m to 3 m to clamp the refrigerant pipe. Otherwise, abnormal sound may be generated.
Use the flare nut attached with the indoor unit or R410A flare nut.

■ Permissible piping length and height difference

They vary depending on the outdoor unit. For details, refer to the Installation Manual attached to the outdoor unit.

■ Pipe size

Model MMF-	Pipe size (mm)	
	Gas side	Liquid side
AP015 to AP018	Ø12.7	Ø6.4
AP024 to AP056	Ø15.9	Ø9.5

■ Connecting refrigerant piping

Flaring

- Cut the pipe with a pipe cutter.
Remove burrs completely. (Remaining burrs may cause gas leakage.)
- Insert a flare nut into the pipe, and flare the pipe.
Use the flare nut provided with the unit or the one used for the R410A refrigerant. The flaring dimensions for R410A are different from the ones used for the conventional R22 refrigerant. A new flare tool manufactured for use with the R410A refrigerant is recommended, but the conventional tool can still be used if the projection margin of the copper pipe is adjusted to be as shown in the following table.

Projection margin in flaring: B (Unit: mm)

Outer dia. of copper pipe	R410A tool used	Conventional tool used
6.4, 9.5	0 to 0.5	1.0 to 1.5
12.7, 15.9		

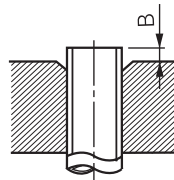

Flaring diameter size: A (Unit: mm)

Outer dia. of copper pipe	A $\begin{matrix} +0 \\ -0.4 \end{matrix}$
6.4	9.1
9.5	13.2
12.7	16.6
15.9	19.7

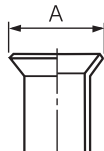

- * In case of flaring for R410A with the conventional flare tool, pull it out approx. 0.5 mm more than that for R22 to adjust to the specified flare size. The copper pipe gauge is useful for adjusting projection margin size.
- * The sealed gas was sealed at the atmospheric pressure so when the flare nut is removed, there will no "whooshing" sound: This is normal and is not indicative of trouble.

- Use two wrenches to connect the indoor unit pipe.

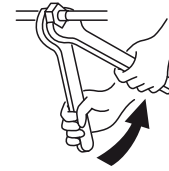

Work using double spanner

- Use the tightening torque levels as listed in the following table.

Outer dia. of connecting pipe (mm)	Tightening torque (N·m)
6.4	14 to 18 (1.4 to 1.8 kgf·m)
9.5	34 to 42 (3.4 to 4.2 kgf·m)
12.7	49 to 61 (4.9 to 6.1 kgf·m)
15.9	63 to 77 (6.3 to 7.7 kgf·m)

- Tightening torque of flare pipe connections.
Pressure of R410A is higher than that of R22. (Approx. 1.6 times) Therefore, using a torque wrench, tighten the flare pipe connecting sections which connect the indoor and outdoor units of the specified tightening torque.
Incorrect connections may cause not only a gas leak, but also a trouble of the refrigeration cycle.

⚠ CAUTION

Tightening with an excessive torque may crack the nut depending on installation conditions.

■ Airtight test / air purge, etc.

For air tightness test, adding refrigerant, refer to the Installation Manual attached to the outdoor unit.

⚠ CAUTION

Do not supply power to the indoor unit until the airtight test and vacuuming are completed. (If the indoor unit is powered on, the pulse motor valve is fully closed, which extends the time for vacuuming.)

■ Open the valve fully

Open the valve of the outdoor unit fully.

■ Heat insulation process

Apply heat insulation for the pipes separately at liquid side and gas side.

- For the heat insulation to the pipes at gas side, use the material with heat-resisting temperature 120 °C or higher.
- To use the attached heat insulation pipe, apply the heat insulation to the pipe connecting section of the indoor unit securely without gap.

REQUIREMENT

- Apply the heat insulation to the pipe connecting section of the indoor unit securely up to the root without exposure of the pipe. (The pipe exposed to the outside causes water leak.)
- Insulate the refrigerant pipe in the indoor unit securely up to the point shown in the following figure.

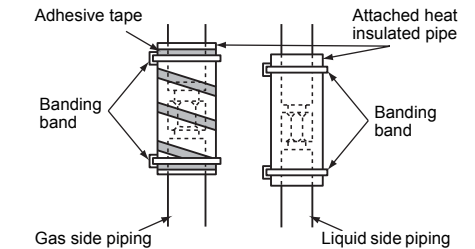

7 Electrical connection

⚠ WARNING

- **Use the specified wires for wiring connect the terminals. Securely fix them to prevent external forces applied to the terminals from affecting the terminals.**
Incomplete connection or fixation may cause a fire or other trouble.
- **Connect earth wire. (grounding work)**
Incomplete grounding cause an electric shock. Do not connect earth wires to gas pipes, water pipes, lightning conductor or telephone earth wires.
- **Appliance shall be installed in accordance with national wiring regulations.**
Capacity shortage of power circuit or incomplete installation may cause an electric shock or a fire.

⚠ CAUTION

- If incorrect / incomplete wiring is carried out, it will cause an electrical fire or smoke.
- Use the cord clamps attached to the product.
- Do not damage or scratch the conductive core and inner insulator of power and inter-connecting wires when peeling them.
- Use the power cord and Inter-connecting wire of specified thickness, type, and protective devices required.
- Do not connect 220 V – 240 V power to the terminal blocks (Ⓢ, Ⓣ, Ⓜ, Ⓝ) for control wiring. (Otherwise, the system will fail.)
- Do not allow the electric wiring to touch the hot pipes. Doing so could melt the coatings.

REQUIREMENT

- For power supply wiring, strictly conform to the Local Regulation in each country.
- For wiring of power supply of the outdoor units, follow the Installation Manual of each outdoor unit.
- After connecting wires to the terminal blocks, provide a trap and fix wires with the cord clamp.
- Run the refrigerant piping line and control wiring line in the same line.
- Do not turn on the power of the indoor unit until the refrigerant pipes are vacuumed.

■ Power supply wire and communication wires specifications

Power supply wire and communication wires are procured locally.

For the power supply specifications, follow to the following table. If capacity is little, it is dangerous because overheat or burnout may be caused.

For specifications of the power capacity of the outdoor unit and the power supply wires, refer to the Installation Manual attached to the outdoor unit.

Indoor unit power supply

- For the power supply of the indoor unit, prepare the exclusive power supply separated from that of the outdoor unit.
- Arrange the power supply, circuit breaker, and main switch of the indoor unit connected to the same outdoor unit so that they are commonly used.
- Power supply wire specification: Cable 3-core 2.5 mm², in conformity with Design 60245 IEC 57.

▼ Power supply

Power supply	220 V – 240 V ~, 50 Hz 220 V ~, 60 Hz	
Power supply switch / circuit breaker or power supply wiring / fuse rating for indoor units should be selected by the accumulated total current values of the indoor units.		
Power supply wiring	Below 50 m	2.5 mm ²

Control wiring, Central controller wiring

- 2-core with polarity wires are used for the Control wiring between indoor unit and outdoor unit and Central controller wiring.
- To prevent noise trouble, use 2-core shield wire.
- The length of the communication line means the total length of the inter-unit wire length between indoor and outdoor units added with the central control system wire length.

▼ Communication line

Control wiring between indoor units, and outdoor unit (2-core shield wire)	Wire size	(Up to 1000 m) 1.25 mm ² (Up to 2000 m) 2.0 mm ²
Central control line wiring (2-core shield wire)	Wire size	(Up to 1000 m) 1.25 mm ² (Up to 2000 m) 2.0 mm ²

Remote controller wiring

2-core with non-polarity wire is used for wiring of the remote controller wiring and group remote controllers wiring.

Remote controller wiring, remote controller inter-unit wiring	Wire size: 0.5 mm ² to 2.0 mm ²	
Total wire length of remote controller wiring and remote controller inter-unit wiring = L + L1 + L2 + ... Ln	In case of wired type only	Up to 500 m
	In case of wireless type included	Up to 400 m
Total wire length of remote controller inter-unit wiring = L1 + L2 + ... Ln	Up to 200 m	

⚠ CAUTION

The remote controller wire (Communication line) and AC 220 – 240 V wires cannot be side-by-side in contact with each other and cannot be run in the same conduits. Doing so may cause trouble on the control system due to noise or other factors.

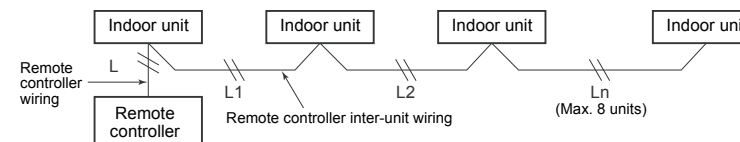

■ Wiring between indoor and outdoor units

NOTE

An outdoor unit connected with control wiring between indoor and outdoor units wire becomes automatically the header unit.

▼ Wiring example

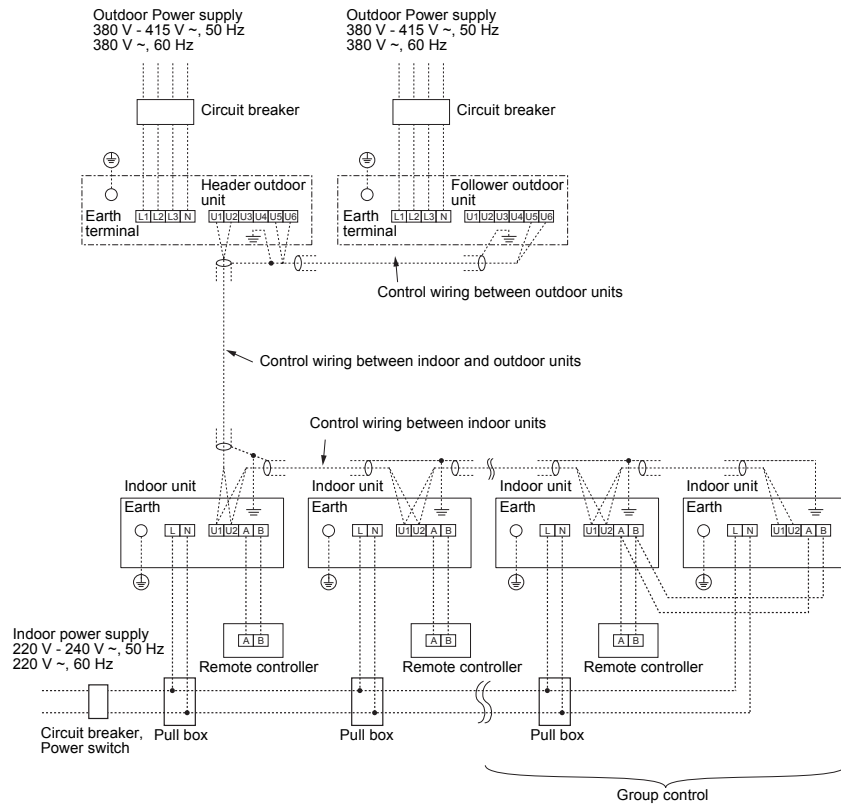

■ Wire connection

REQUIREMENT

- Connect the wires matching the terminal numbers. Incorrect connection causes a trouble.
- Pass the wires through the bushing of wire connection holes of the indoor unit.
- Keep a margin (Approx. 100 mm) on a wire to hang down the electrical control box at servicing or other purpose.
- The low-voltage circuit is provided for the remote controller. (Do not connect the high-voltage circuit)

<How to remove the electrical control box cover>

• AP015 to AP027 models

Take off screws (1) and (2) at this side of the electrical control box and remove the drip-proof cover.

Take off screws (3) and (4) at front side of the electrical control box and remove the cover of the electrical control box cover.

• AP036 to AP056 models

Take off screws (3) and (4) at front side of the electrical control box and remove the cover of the electrical control box.

(The drip-proof cover is provided to AP015 to AP027 models only.)

<Wiring>

- Draw the wire into the control wire hole (knockout hole).
- As shown in the figure, set a trap and fix the wire with a cord clamp.
- Be sure to mount cover of the electrical control box and the drip-proof cover.

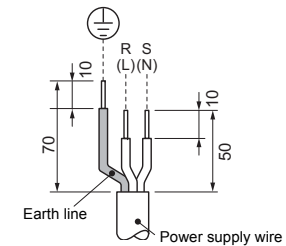
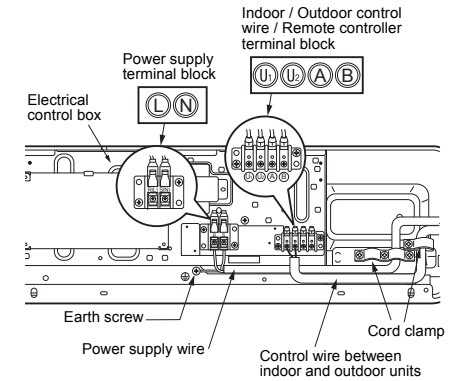
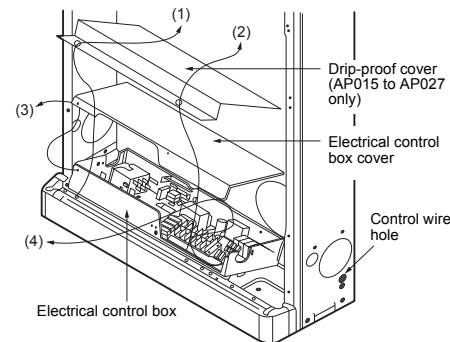

■ Remote controller wiring

Strip off approx. 9 mm the wire to be connected.

▼ Wiring diagram

Terminal block for remote controller wiring of indoor unit

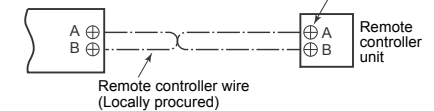

■ Address setup

Set up the addresses as per the Installation Manual supplied with the outdoor unit.

8 Applicable controls

REQUIREMENT

When the air conditioner is used for the first time, it will take some moments after the power has been turned on before the remote controller becomes available for operations: This is normal and is not indicative of trouble.

- Concerning the automatic addresses (The automatic addresses are set up by performing operations on the outdoor interface circuit board.)

While the automatic addresses are being set up, no remote controller operations can be performed. Setup takes up to 10 minutes (usually about 5 minutes).

- When the power is turned on after automatic address setup

It takes up to 10 minutes (usually about 3 minutes) for the outdoor unit to start operating after the power has been turned on.

Before the air conditioner was shipped from the factory, all units are set to [STANDARD] (factory default). If necessary, change the indoor unit settings.

The settings are changed by operating the wired remote controller.

- The settings cannot be changed by using only a wireless remote controller, simple remote controller or group control remote controller by itself so install a wired remote controller separately as well.

Basic procedure for changing settings

Change the settings while the air conditioner is not working. **(Stop the air conditioner before making settings.)**

CAUTION

Set only the CODE No. shown in the following table: Do NOT set any other CODE No.

If a CODE No. not listed is set, it may not be possible to operate the air conditioner or other trouble with the product may result.

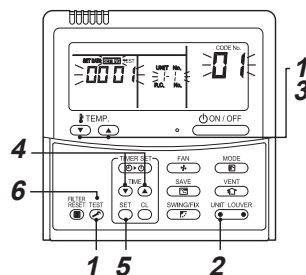

- Push and hold **TEST** button and “TEMP.” button simultaneously for at least 4 seconds. After a while, the display flashes as shown in the figure. Confirm that the CODE No. is [01].

If the CODE No. is not [01], push **TEST** button to clear the display content, and repeat the procedure from the beginning. (No operation of the **TEST** remote controller is accepted for a while after button is pushed.)

(While air conditioners are operated under the group control, “ALL” is displayed first. When **UNIT LOUVER** is pushed, the indoor unit number displayed following “ALL” is the header unit.)

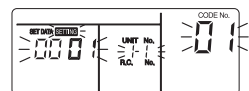

(* Display content varies with the indoor unit model.)

- Each time **UNIT LOUVER** button is pushed, indoor unit numbers in the control group change cyclically. Select the indoor unit to change settings for.

The fan of the selected unit runs and the louvers start swinging. The indoor unit for change settings can be confirmed.

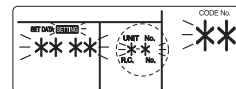

- Specify CODE No. [***] with “TEMP.” / buttons.

- Select SET DATA [****] with “TIME” / buttons.

- Push **SET** button. When the display changes from flashing to lit, the setup is completed.

- To change settings of another indoor unit, repeat from Procedure 2.
- To change other settings of the selected indoor unit, repeat from Procedure 3.

Use **SET** button to clear the settings. To make settings after **SET** button was pushed, repeat from Procedure 2.

- When settings have been completed, push **TEST** button to determine the settings.

When **TEST** button is pushed, **SETTING** flashes and then the display content disappears and the air conditioner enters the normal stop mode.

(While **SETTING** is flashing, no operation of the remote controller is accepted.)

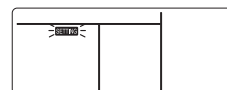

Filter sign setting

According to the installation condition, the filter sign term (Notification of filter cleaning) can be changed. Follow to the basic operation procedure (1 → 2 → 3 → 4 → 5 → 6).

- For the CODE No. in Procedure 3, specify [01].
- For the [SET DATA] in Procedure 4, select the SET DATA of filter sign term from the following table.

SET DATA	Filter sign term
0000	None
0001	150 H (Factory default)
0002	2500 H
0003	5000 H
0004	10000 H

To secure better effect of heating

When it is difficult to obtain satisfactory heating due to installation place of the indoor unit or structure of the room, the detection temperature of heating can be raised. Also use a circulator or other machinery to circulate heat air near the ceiling.

Follow to the basic operation procedure (1 → 2 → 3 → 4 → 5 → 6).

- For the CODE No. in Procedure 3, specify [06].
- For the set data in Procedure 4, select the SET DATA of shift value of detection temperature to be set up from the following table.

SET DATA	Detection temperature shift value
0000	No shift (Factory default)
0001	+1 °C
0002	+2 °C
0003	+3 °C
0004	+4 °C
0005	+5 °C
0006	+6 °C

Remote controller sensor

The temperature sensor of the indoor unit senses room temperature usually. Set the remote controller sensor to sense the temperature around the remote controller.

Select items following the basic operation procedure (1 → 2 → 3 → 4 → 5 → 6).

- Specify [32] for the CODE No. in Procedure 3.
- Select the following data for the SET DATA in Procedure 4.

SET DATA	0000	0001
Remote controller sensor	Not used (Factory default)	Used

When  flashes, the remote controller sensor is defective.

Select the SET DATA [0000] (not used) or replace the remote controller.

Group control

In a group control, a remote controller can control up to maximum 8 units.

- The wired remote controller only can control a group control. The wireless remote controller is unavailable for this control.
- For wiring procedure and wires of the individual line (Identical refrigerant line) system, refer to "Electrical Connection" in this Manual.
- Wiring between indoor units in a group is performed in the following procedure.
- Connect the indoor units by connecting the remote controller wires from the remote controller terminal blocks (A, B) of the indoor unit connected with a remote controller to the remote controller terminal blocks (A, B) of the other indoor unit. (Non-polarity)
- For address setup, refer to the Installation Manual attached to the outdoor unit.

9 Test run

Before test run

- Before turning on the power supply, carry out the following procedure.
 - By using 500 V-megger, check that resistance of 1 MΩ or more exists between the terminal block L to N and the earth (grounding). If resistance of less than 1 MΩ is detected, do not run the unit.
 - Check the valve of the outdoor unit being opened fully.
- To protect the compressor at activation time, leave power-ON for 12 hours or more before operating.
- Do not press the electromagnetic contactor to forcibly perform a test run. (This is very dangerous because the protective device does not work.)
- Before starting a test run, set addresses by following the Installation Manual supplied with the outdoor unit.

Execute a test run

- When a fan operation is to be performed for an individual indoor unit, turn off the power, short CN72 on the circuit board, and then turn the power back on. (First set the operating mode to "fan," and then operate.) When the test run has been performed using this method, do NOT forget to release the shorting of CN72 after the test run is completed.

Operate the unit with the wired remote controller as usual.

For the procedure of the operation, refer to the attached Owner's Manual to the outdoor unit.

A forced test run can be executed in the following procedure even if the operation stops by thermostat-OFF.

In order to prevent a serial operation, the forced test run is released after 60 minutes have passed and returns to the usual operation.

CAUTION

Do not use the forced test run for cases other than the test run because it applies an excessive load to the devices.



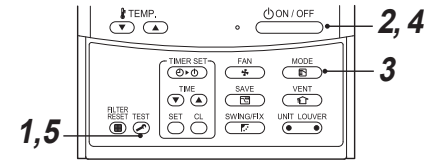

Wired remote controller

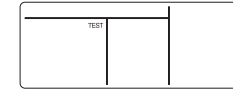



- Push  button for 4 seconds or more. [TEST] is displayed on the display part and the selection of mode in the test mode is permitted.

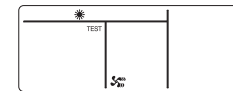

- Push  button.

- Select the operation mode with  button,  [Cool] or  [Heat].
 - Do not run the air conditioner in a mode other than  [Cool] or  [Heat].
 - The temperature controlling function does not work during test run.
 - The detection of error is performed as usual.



- After the test run, push  button to stop a test run. (Display part is same as procedure 1.)

- Push  button to cancel (release from) the test run mode. ([TEST] disappears on the display and the status returns to a normal.)

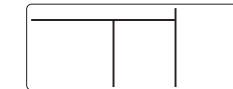

Wireless remote controller

(TCB-AX32E2)

- When TEMPORARY button is pushed for 10 seconds or more, "P!!" sound is heard and the operation changes to a forced cooling operation. After approx. 3 minutes, a cooling operation starts forcibly.

Check cool air starts blowing. If the operation does not start, check wiring again.

- To stop a test operation, push TEMPORARY button once again (Approx. 1 second).

- Check wiring / piping of the indoor and outdoor units in forced cooling operation.

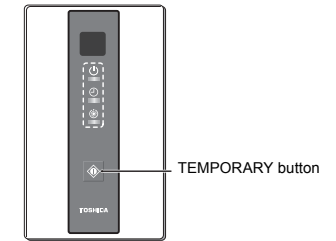

10 Maintenance

<Daily maintenance>

▼ Cleaning of air filter

If  is displayed on the remote controller, maintain the air filter.

- 1 Push the  button to stop the operation, then turn off the circuit breaker.

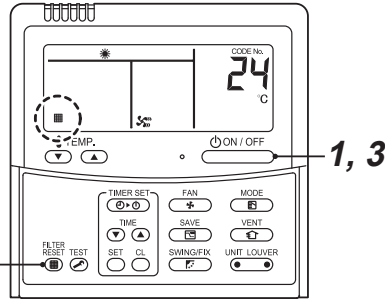

- 2 Use a screwdriver to unfasten the screws of the intake grille (two places) to open the intake grille. The screws are designed to stay on the intake grille.

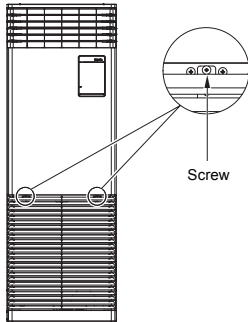

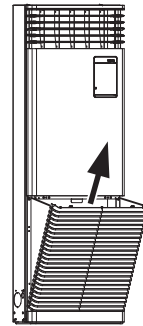

- 3 Take out the air filter.
 - Pull up the air filter toward you.



- Cleaning with water or vacuum cleaner
- If dirt is heavy, clean the air filter by tepid water with neutral detergent or water.
- After cleaning with water, dry the air filter sufficiently in a shade place.
- To attach the air filter, insert it into the unit and push it in.

- 4 Close the intake grille and fasten the screws (two places).

- 5 Turn on the circuit breaker, then push the  button on the remote controller to start the operation.

- 6 After cleaning, push .  display disappears.

▼ To open the access panel

Use a screwdriver to unfasten the screws of the access panel (two places), slide the cabinet upward by approximately 30mm, and pull it out toward you.

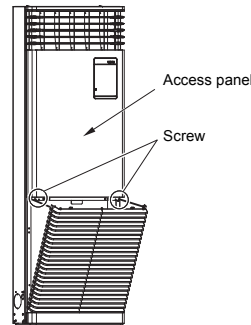

⚠ CAUTION

- Do not start the air conditioner while leaving air filter removed.
- Push the filter reset button. ( indication will be turn off.)

▼ Periodic Maintenance

For environmental conservation, it is strongly recommended that the indoor and outdoor units of the air conditioner in use be cleaned and maintained regularly to ensure efficient operation of the air conditioner. When the air conditioner is operated for a long time, periodic maintenance (once a year) is recommended. Furthermore, regularly check the outdoor unit for rust and scratches, and remove them or apply rustproof treatment, if necessary.

As a general rule, when an indoor unit is operated for 8 hours or more daily, clean the indoor unit and outdoor unit at least once every 3 months. Ask a professional for this cleaning / maintenance work. Such maintenance can extend the life of the product though it involves the owner's expense. Failure to clean the indoor and outdoor units regularly will result in poor performance, freezing, water leakage, and even compressor failure.

▼ Inspection before maintenance

Following inspection must be carried out by a qualified installer or qualified service person.

Parts	Inspection method
Heat exchanger	Access from inspection opening and remove the access panel. Examine the heat exchanger if there is any clogging or damages.
Fan motor	Access from inspection opening and check if any abnormal noise can be heard.
Fan	Access from inspection opening and remove the access panel. Examine the fan if there are any waggles, damages or adhesive dust.
Filter	Go to installed location and check if there are any stains or breaks on the filter.
Drain pan	Access from inspection opening and remove the access panel. Check if there is any clogging or drain water is polluted.

▼ Maintenance List

Part	Unit	Check (visual / auditory)	Maintenance
Heat exchanger	Indoor / outdoor	Dust / dirt clogging, scratches	Wash the heat exchanger when it is clogged.
Fan motor	Indoor / outdoor	Sound	Take appropriate measures when abnormal sound is generated.
Filter	Indoor	Dust / dirt, breakage	<ul style="list-style-type: none"> • Wash the filter with water when it is contaminated. • Replace it when it is damaged.
Fan	Indoor	<ul style="list-style-type: none"> • Vibration, balance • Dust / dirt, appearance 	<ul style="list-style-type: none"> • Replace the fan when vibration or balance is terrible. • Brush or wash the fan when it is contaminated.
Air intake / discharge grilles	Indoor / outdoor	Dust / dirt, scratches	Fix or replace them when they are deformed or damaged.
Drain pan	Indoor	Dust / dirt clogging, drain contamination	Clean the drain pan and check the downward slope for smooth drainage.
Ornamental panel, louvres	Indoor	Dust / dirt, scratches	Wash them when they are contaminated or apply repair coating.
Exterior	Outdoor	<ul style="list-style-type: none"> • Rust, peeling of insulator • Peeling / lift of coat 	Apply repair coating.

11 Troubleshooting

Confirmation and check

When an error occurred in the air conditioner, an error code and indoor UNIT No. appear on the display part of the remote controller. The error code is only displayed during the operation. If the display disappears, operate the air conditioner according to the following "Confirmation of error log" for confirmation.

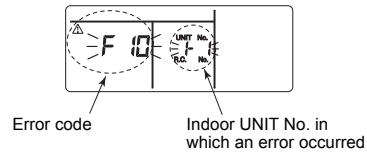

Confirmation of error log

When an error occurred on the air conditioner, the error log can be confirmed with the following procedure. (The error log is stored in memory up to 4 errors.) The log can be confirmed from both operating status and stop status.

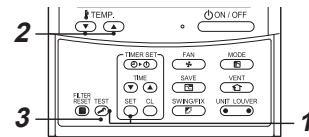

1 When **SET** and **TEST** buttons are pushed simultaneously for 4 seconds or more, the following display appears.

If **F** is displayed, the mode enters in the error log mode.

- [01: Order of error log] is displayed in CODE No..
- [Error code] is displayed in CHECK.
- [Indoor unit address in which an error occurred] is displayed in Unit No..

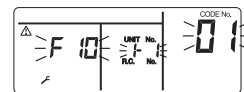

2 Every pushing of **TEMP.** button used to set temperature, the error log stored in memory is displayed in order.

The numbers in CODE No. indicate CODE No. [01] (latest) → [04] (oldest).

REQUIREMENT

Do not push **ON/OFF** button because all the error log of the indoor unit will be deleted.

3 After confirmation, push **TEST** button to return to the usual display.

Check method

On the wired remote controller, central control remote controller and the interface P.C. board of the outdoor unit (I/F), a check display LCD (Remote controller) or 7-segment display (on the outdoor interface P.C. board) to display the operation is provided. Therefore the operation status can be known. Using this self-diagnosis function, a trouble or position with error of the air conditioner can be found as shown in the following table.

Check code list

The following list shows each check code. Find the check contents from the list according to part to be checked.

- In case of check from indoor remote controller: See "Wired remote controller display" in the list.
- In case of check from outdoor unit: See "Outdoor unit 7-segment display" in the list.
- In case of check from indoor unit with a wireless remote controller: See "Sensor block display of receiving unit" in the list.

○: Lighting, ◻: Flashing, ●: Goes off
 IPDU: Intelligent Power Drive Unit
 ALT: Flashing is alternately when there are two flashing LED.
 SIM: Simultaneous flashing when there are two flashing LED.

Check code			Wireless remote controller				Check code name	Judging device
Wired remote controller display	Outdoor unit 7-segment display		Sensor block display of receiving unit					
		Auxiliary code	Operation	Timer	Ready	Flash		
E01	—	—	◻	●	●		Communication error between indoor unit and remote controller (Detected at remote controller side)	Remote controller
E02	—	—	◻	●	●		Remote controller transmission error	Remote controller
E03	—	—	◻	●	●		Communication error between indoor unit and remote controller (Detected at indoor unit side)	Indoor unit
E04	—	—	●	●	◻		Communication circuit error between indoor / outdoor unit (Detected at indoor unit side)	Indoor unit
E06	E06	No. of indoor units in which sensor has been normally received	●	●	◻		Decrease of No. of indoor units	I/F
—	E07	—	●	●	◻		Communication circuit error between indoor / outdoor unit (Detected at outdoor unit side)	I/F
E08	E08	Duplicated indoor unit addresses	◻	●	●		Duplicated indoor unit addresses	Indoor unit • I/F
E09	—	—	◻	●	●		Duplicated master remote controllers	Remote controller
E10	—	—	◻	●	●		Communication error between indoor unit MC	Indoor unit
E12	E12	01:Indoor / Outdoor units communication 02:Outdoor / Outdoor units communication	◻	●	●		Automatic address start error	I/F
E15	E15	—	●	●	◻		No indoor unit during automatic addressing	I/F
E16	E16	00:Capacity over 01 ~:No. of connected units	●	●	◻		Capacity over / No. of connected indoor units	I/F
E18	—	—	◻	●	●		Communication error between header and follower units Indoor unit	Indoor unit
E19	E19	00:No header 02:Two or more header units	●	●	◻		Outdoor header units quantity error	I/F
E20	E20	01:Outdoor unit of other line connected 02:Indoor unit of other line connected	●	●	◻		Other line connected during automatic address	I/F
E21	E21	02:No header unit 00:Multiple number of header units	●	●	◻		Error in number of heat storage master units	I/F
E22	E22	—	●	●	◻		Reduction in number of heat storage units	I/F
E23	E23	—	●	●	◻		Sending error in communication between outdoor units Error in number of heat storage units (trouble with reception)	I/F
E25	E25	—	●	●	◻		Duplicated follower outdoor addresses	I/F
E26	E26	No. of outdoor units which received signal normally	●	●	◻		Decrease of No. of connected outdoor units	I/F
E28	E28	Detected outdoor unit number	●	●	◻		Follower outdoor unit error	I/F
E31	E31	Number of IPDU (*1)	●	●	◻		IPDU communication error	I/F
F01	—	—	◻	◻	●	ALT	Indoor unit TCJ sensor error	Indoor unit

Check code			Wireless remote controller				Check code name	Judging device
Wired remote controller display	Outdoor unit 7-segment display		Sensor block display of receiving unit					
		Auxiliary code	Operation	Timer	Ready	Flash		
F02	—	—	☐	☐	●	ALT	Indoor unit TC2 sensor error	Indoor unit
F03	—	—	☐	☐	●	ALT	Indoor unit TC1 sensor error	Indoor unit
F04	F04	—	☐	☐	○	ALT	TD1 sensor error	I/F
F05	F05	—	☐	☐	○	ALT	TD2 sensor error	I/F
F06	F06	01:TE1 sensor 02:TE2 sensor	☐	☐	○	ALT	TE1 sensor error TE2 sensor error	I/F
F07	F07	—	☐	☐	○	ALT	TL sensor error	I/F
F08	F08	—	☐	☐	○	ALT	TO sensor error	I/F
F10	—	—	☐	☐	●	ALT	Indoor unit TA sensor error	Indoor unit
F12	F12	—	☐	☐	○	ALT	TS1 sensor error	I/F
F13	F13	01:Comp. 1 side 02:Comp. 2 side 03:Comp. 3 side	☐	☐	○	ALT	TH sensor error	IPDU
F15	F15	—	☐	☐	○	ALT	Outdoor unit temp. sensor miscabling (TE, TL)	I/F
F16	F16	—	☐	☐	○	ALT	Outdoor unit pressure sensor miscabling (Pd, Ps)	I/F
F22	F22	—	☐	☐	○	ALT	TD3 sensor error	I/F
F23	F23	—	☐	☐	○	ALT	Ps sensor error	I/F
F24	F24	—	☐	☐	○	ALT	Pd sensor error	I/F
F29	—	—	☐	☐	●	SIM	Indoor unit other error	Indoor unit
F31	F31	—	☐	☐	○	SIM	Indoor unit EEPROM error	I/F
H01	H01	01:Comp. 1 side 02:Comp. 2 side 03:Comp. 3 side	●	☐	●		Compressor break down	IPDU
H02	H02	01:Comp. 1 side 02:Comp. 2 side 03:Comp. 3 side	●	☐	●		Compressor trouble (lock)	IPDU
H03	H03	01:Comp. 1 side 02:Comp. 2 side 03:Comp. 3 side	●	☐	●		Current detect circuit system error	IPDU
H04	H04	—	●	☐	●		Comp. 1 case thermo operation	I/F
H05	H05	—	●	☐	●		TD1 sensor miswiring	I/F
H06	H06	—	●	☐	●		Low pressure protective operation	I/F
H07	H07	—	●	☐	●		Oil level down detective protection	I/F
H08	H08	01:TK1 sensor error 02:TK2 sensor error 03:TK3 sensor error 04:TK4 sensor error 05:TK5 sensor error	●	☐	●		Oil level defective temp sensor error	I/F
H14	H14	—	●	☐	●		Comp. 2 case thermo operation	I/F
H15	H15	—	●	☐	●		TD2 sensor miswiring	I/F
H16	H16	01:TK1 oil circuit system error 02:TK2 oil circuit system error 03:TK3 oil circuit system error 04:TK4 oil circuit system error 05:TK5 oil circuit system error	●	☐	●		Oil level defective circuit error	I/F
H25	H25	—	●	☐	●		TD3 sensor miswiring	I/F
L03	—	—	☐	●	☐	SIM	Indoor unit centre unit duplicated	Indoor unit
L04	L04	—	☐	○	☐	SIM	Outdoor unit line address duplicated	I/F

Check code			Wireless remote controller				Check code name	Judging device
Wired remote controller display	Outdoor unit 7-segment display		Sensor block display of receiving unit					
		Auxiliary code	Operation	Timer	Ready	Flash		
L05	—	—	☐	●	☐	SIM	Duplicated indoor units with priority (Displayed in indoor unit with priority)	I/F
L06	L06	No. of indoor units with priority	☐	●	☐	SIM	Duplicated indoor units with priority (Displayed in unit other than indoor unit with priority)	I/F
L07	—	—	☐	●	☐	SIM	Group line in individual indoor unit	Indoor unit
L08	L08	—	☐	●	☐	SIM	Indoor unit group / Address unset	Indoor unit, I/F
L09	—	—	☐	●	☐	SIM	Indoor unit capacity unset	Indoor unit
L10	L10	—	☐	○	☐	SIM	Outdoor unit capacity unset	I/F
L17	L17	—	☐	○	☐	SIM	Outdoor unit type mismatch error	I/F
L20	—	—	☐	○	☐	SIM	Duplicated central control addresses	Indoor unit
L26	L26	Number of heat storage units connected	☐	○	☐	SIM	Too many heat storage units connected	I/F
L27	L27	Number of heat storage units connected	☐	○	☐	SIM	Error in number of heat storage units connected	I/F
L28	L28	—	☐	○	☐	SIM	Too many outdoor units connected	I/F
L29	L29	Number of IPDU (*1)	☐	○	☐	SIM	No. of IPDU error	I/F
L30	L30	Detected indoor unit address	☐	○	☐	SIM	Indoor unit outside interlock	Indoor unit
—	L31	—	—	—	—	—	Extended I/C error	I/F
P01	—	—	●	☐	☐	ALT	Indoor fan motor error	Indoor unit
P03	P03	—	☐	●	☐	ALT	Discharge temp. TD1 error	I/F
P04	P04	01:Comp. 1 side 02:Comp. 2 side 03:Comp. 3 side	☐	●	☐	ALT	High-pressure SW system operation	IPDU
P05	P05	00: 01:Comp. 1 side 02:Comp. 2 side 03:Comp. 3 side	☐	●	☐	ALT	Phase missing detection / Power failure detection Inverter DC voltage error (comp.) Inverter DC voltage error (comp.) Inverter DC voltage error (comp.)	I/F
P07	P07	01:Comp. 1 side 02:Comp. 2 side 03:Comp. 3 side	☐	●	☐	ALT	Heat sink overheat error	IPDU, I/F
P09	P09	Detected heat storage address	●	☐	☐	ALT	No heat storage unit water error	Heat storage unit
P10	P10	Detected indoor unit address	●	☐	☐	ALT	Indoor unit overflow error	Indoor unit
P12	—	—	●	☐	☐	ALT	Indoor unit fan motor error	Indoor unit
P13	P13	—	●	☐	☐	ALT	Outdoor liquid back detection error	I/F
P15	P15	01:TS condition 02:TD condition	☐	●	☐	ALT	Gas leak detection	I/F
P17	P17	—	☐	●	☐	ALT	Discharge temp. TD2 error	I/F
P18	P18	—	☐	●	☐	ALT	Discharge temp. TD3 error	I/F
P19	P19	Detected outdoor unit number	☐	●	☐	ALT	4-way valve inverse error	I/F
P20	P20	—	☐	●	☐	ALT	High-pressure protective operation	I/F
P22	P22	0*:IGBT circuit 1*:Position detective circuit error 3*:Motor lock error 4*:Motor current detection C*:TH sensor error D*:TH sensor error E*:Inverter DC voltage error (outdoor unit fan)	☐	●	☐	ALT	Outdoor unit fan IPDU error Note: Ignore 0 to F displayed in "*" position.	IPDU
P26	P26	01:Comp. 1 side 02:Comp. 2 side 03:Comp. 3 side	☐	●	☐	ALT	G-TR short protection error	IPDU

Check code			Wireless remote controller				Check code name	Judging device
Wired remote controller display	Outdoor unit 7-segment display		Sensor block display of receiving unit					
		Auxiliary code	Operation	Timer	Ready	Flash		
P29	P29	01:Comp. 1 side 02:Comp. 2 side 03:Comp. 3 side	□	●	□	ALT	Comp. position detective circuit system error	IPDU
P31	—	—	□	●	□	ALT	Other indoor unit error (Group follower indoor unit error)	Indoor unit

*1 Number of IPDU

01: Comp. 1

02: Comp. 2

03: Comp. 1 + Comp. 2

04: Comp. 3

05: Comp. 1 + Comp. 3

06: Comp. 2 + Comp. 3

07: Comp. 1 + Comp. 2 + Comp. 3

08: Fan

09: Comp. 1 + Fan

0A: Comp. 2 + Fan

0B: Comp. 1 + Comp. 2 + Fan

0C: Comp. 3 + Fan

0D: Comp. 1 + Comp. 3 + Fan

0E: Comp. 2 + Comp. 3 + Fan

0F: Comp. 1 + Comp. 2 + Comp. 3 + Fan

Error detected by TCC-LINK central control device

Check code			Wireless remote controller				Check code name	Judging device
Central control device indication	Outdoor unit 7-segment display		Sensor block display of receiving unit					
		Auxiliary code	Operation	Timer	Ready	Flash		
C05	—	—	—				Sending error in TCC-LINK central control device	TCC-LINK
C06	—	—	—				Receiving error in TCC-LINK central control device	TCC-LINK
C12	—	—	—				Batch alarm of general-purpose equipment control interface	General-purpose equipment, I/F
P30	Alarms occur according to the type of error						Group control follower unit error	TCC-LINK
	—	—	(L20 is displayed.)				Duplicated addresses of indoor units in TCC-Link central device	

TCC-LINK: TOSHIBA Carrier Communication Link.

12 Specifications

Model	Sound pressure level (dBA)		Weight (kg)
	Cooling	Heating	
MMF-AP0156H1-E	*	*	46
MMF-AP0186H1-E	*	*	46
MMF-AP0246H1-E	*	*	47
MMF-AP0276H1-E	*	*	47
MMF-AP0366H1-E	*	*	62
MMF-AP0486H1-E	*	*	62
MMF-AP0566H1-E	*	*	62

* Under 70 dBA

Declaration of Conformity

Manufacturer: TOSHIBA CARRIER CORPORATION
336 Tadehara, Fuji-shi, Shizuoka-ken 416-8521 JAPAN

TCF holder: TOSHIBA CARRIER EUROPE S.A.S
Route de Thil
01120 Montluel FRANCE

Hereby declares that the machinery described below:

Generic Denomination: Air Conditioner

Model / type: MMF-AP0156H1-E, MMF-AP0186H1-E, MMF-AP0246H1-E, MMF-AP0276H1-E,
MMF-AP0366H1-E, MMF-AP0486H1-E, MMF-AP0566H1-E

Commercial name: Super Modular Multi System Air Conditioner
Super Heat Recovery Multi System Air Conditioner
Mini-Super Modular Multi System Air Conditioner (MiNi-SMMS series)

Complies with the provisions of the "Machinery" Directive (Directive 2006/42/EC) and the regulations transposing into national law

NOTE

This declaration becomes invalid if technical or operational modifications are introduced without the manufacturer's consent.

Warnings on Refrigerant Leakage

Check of Concentration Limit

The room in which the air conditioner is to be installed requires a design that in the event of refrigerant gas leaking out, its concentration will not exceed a set limit.

The refrigerant R410A which is used in the air conditioner is safe, without the toxicity or combustibility of ammonia, and is not restricted by laws to be imposed which protect the ozone layer. However, since it contains more than air, it poses the risk of suffocation if its concentration should rise excessively. Suffocation from leakage of R410A is almost non-existent. With the recent increase in the number of high concentration buildings, however, the installation of multi air conditioner systems is on the increase because of the need for effective use of floor space, individual control, energy conservation by curtailing heat and carrying power etc.

Most importantly, the multi air conditioner system is able to replenish a large amount of refrigerant compared with conventional individual air conditioners. If a single unit of the multi conditioner system is to be installed in a small room, select a suitable model and installation procedure so that if the refrigerant accidentally leaks out, its concentration does not reach the limit (and in the event of an emergency, measures can be made before injury can occur).

In a room where the concentration may exceed the limit, create an opening with adjacent rooms, or install mechanical ventilation combined with a gas leak detection device. The concentration is as given below.

$$\frac{\text{Total amount of refrigerant (kg)}}{\text{Min. volume of the indoor unit installed room (m}^3\text{)}} \leq \text{Concentration limit (kg/m}^3\text{)}$$

The concentration limit of R410A which is used in multi air conditioners is 0.3 kg/m³.

▼ NOTE 1

If there are 2 or more refrigerating systems in a single refrigerating device, the amounts of refrigerant should be as charged in each independent device.

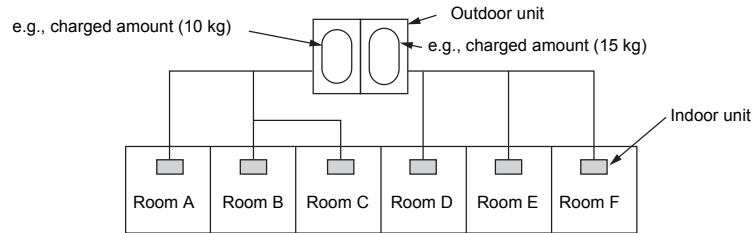

For the amount of charge in this example:

The possible amount of leaked refrigerant gas in rooms A, B and C is 10 kg.

The possible amount of leaked refrigerant gas in rooms D, E and F is 15 kg.

▼ NOTE 2

The standards for minimum room volume are as follows.

- 1) No partition (shaded portion)

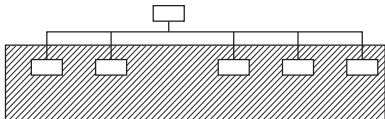

Important

- 2) When there is an effective opening with the adjacent room for ventilation of leaking refrigerant gas (opening without a door, or an opening 0.15 % or larger than the respective floor spaces at the top or bottom of the door).

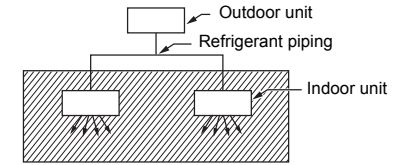

- 3) If an indoor unit is installed in each partitioned room and the refrigerant piping is interconnected, the smallest room of course becomes the object. But when a mechanical ventilation is installed interlocked with a gas leakage detector in the smallest room where the density limit is exceeded, the volume of the next smallest room becomes the object.

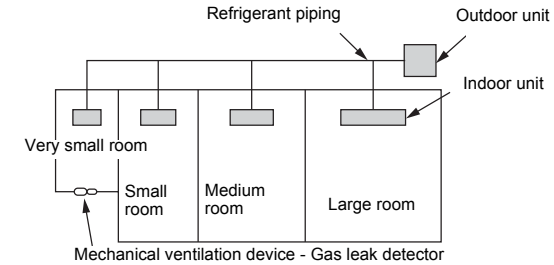

▼ NOTE 3

The minimum indoor floor area compared with the amount of refrigerant is roughly as follows: (When the ceiling is 2.7 m high)

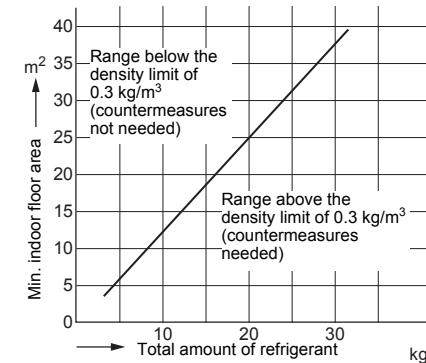

Confirmation of indoor unit setup

Prior to delivery to the customer, check the address and setup of the indoor unit, which has been installed in this time and fill the check sheet (Following table). Data of four units can be entered in this check sheet. Copy this sheet according to the No. of the indoor units. If the installed system is a group control system, use this sheet by entering each line system into each installation manual attached to the other indoor units.

REQUIREMENT

This check sheet is required for maintenance after installation. Fill this sheet and then pass this Installation Manual to the customers.

Indoor unit setup check sheet

Indoor unit		Indoor unit		Indoor unit		Indoor unit	
Room name	Room name	Room name	Room name	Room name	Room name	Room name	Room name
Model	Model	Model	Model	Model	Model	Model	Model
Check indoor unit address. (For check method, refer to APPLICABLE CONTROLS in this manual.)							
*In case of a single system, it is unnecessary to enter the indoor address. (CODE NO.: Line [12], Indoor [13], Group [14], Central control [03])							
Line	Indoor	Group	Line	Indoor	Group	Line	Indoor
Central control address		Central control address		Central control address		Central control address	
Various setup		Various setup		Various setup		Various setup	
Have you changed high ceiling setup? If not, fill check mark [x] in [NO CHANGE], and fill check mark [x] in [ITEM] if changed, respectively. (For check method, refer to APPLICABLE CONTROLS in this manual.) * In case of replacement of jumper blocks on indoor microcomputer P.C. board, setup is automatically changed.							
Have you changed lighting time of filter sign? If not, fill check mark [x] in [NO CHANGE], and fill check mark [x] in [ITEM] if changed, respectively. (For check method, refer to APPLICABLE CONTROLS in this manual.)							
Filter sign lighting time (CODE NO.: [011])		Filter sign lighting time (CODE NO.: [011])		Filter sign lighting time (CODE NO.: [011])		Filter sign lighting time (CODE NO.: [011])	
<input type="checkbox"/> NO CHANGE <input type="checkbox"/> NONE <input type="checkbox"/> 150H <input type="checkbox"/> 2500H <input type="checkbox"/> 5000H <input type="checkbox"/> 10000H		<input type="checkbox"/> NO CHANGE <input type="checkbox"/> NONE <input type="checkbox"/> 150H <input type="checkbox"/> 2500H <input type="checkbox"/> 5000H <input type="checkbox"/> 10000H		<input type="checkbox"/> NO CHANGE <input type="checkbox"/> NONE <input type="checkbox"/> 150H <input type="checkbox"/> 2500H <input type="checkbox"/> 5000H <input type="checkbox"/> 10000H		<input type="checkbox"/> NO CHANGE <input type="checkbox"/> NONE <input type="checkbox"/> 150H <input type="checkbox"/> 2500H <input type="checkbox"/> 5000H <input type="checkbox"/> 10000H	
Have you changed detected temp. shift value? If not, fill check mark [x] in [NO CHANGE], and fill check mark [x] in [ITEM] if changed, respectively. (For check method, refer to APPLICABLE CONTROLS in this manual.)							
Detected temp. shift value setup (CODE NO.: [06])		Detected temp. shift value setup (CODE NO.: [06])		Detected temp. shift value setup (CODE NO.: [06])		Detected temp. shift value setup (CODE NO.: [06])	
<input type="checkbox"/> NO CHANGE <input type="checkbox"/> NO SHIFT <input type="checkbox"/> +1°C <input type="checkbox"/> +2°C <input type="checkbox"/> +3°C <input type="checkbox"/> +4°C <input type="checkbox"/> +5°C <input type="checkbox"/> +6°C		<input type="checkbox"/> NO CHANGE <input type="checkbox"/> NO SHIFT <input type="checkbox"/> +1°C <input type="checkbox"/> +2°C <input type="checkbox"/> +3°C <input type="checkbox"/> +4°C <input type="checkbox"/> +5°C <input type="checkbox"/> +6°C		<input type="checkbox"/> NO CHANGE <input type="checkbox"/> NO SHIFT <input type="checkbox"/> +1°C <input type="checkbox"/> +2°C <input type="checkbox"/> +3°C <input type="checkbox"/> +4°C <input type="checkbox"/> +5°C <input type="checkbox"/> +6°C		<input type="checkbox"/> NO CHANGE <input type="checkbox"/> NO SHIFT <input type="checkbox"/> +1°C <input type="checkbox"/> +2°C <input type="checkbox"/> +3°C <input type="checkbox"/> +4°C <input type="checkbox"/> +5°C <input type="checkbox"/> +6°C	
Incorporation of parts sold separately		Incorporation of parts sold separately		Incorporation of parts sold separately		Incorporation of parts sold separately	
Have you incorporated the following parts sold separately? If incorporated, fill check mark [x] in each [ITEM]. (When incorporating, the setup change is necessary in some cases. For setup change method, refer to Installation Manual attached to each part sold separately.)							
<input type="checkbox"/> Others () <input type="checkbox"/> Others ()		<input type="checkbox"/> Others () <input type="checkbox"/> Others ()		<input type="checkbox"/> Others () <input type="checkbox"/> Others ()		<input type="checkbox"/> Others () <input type="checkbox"/> Others ()	

TOSHIBA CARRIER CORPORATION

336 TADEHARA, FUJI-SHI, SHIZUOKA-KEN 416-8521 JAPAN

EB99802601-1