



*AIR CONDITIONER (MULTI TYPE)*  
**Installation Manual**



**Outdoor Unit**

For commercial use

Model name: \_\_\_\_\_

Heat Pump Model

**MCY-MHP0404HS-E**

**MCY-MHP0504HS-E**

**MCY-MHP0604HS-E**

**MCY-MHP0404HSJ-E**

**MCY-MHP0504HSJ-E**

**MCY-MHP0604HSJ-E**

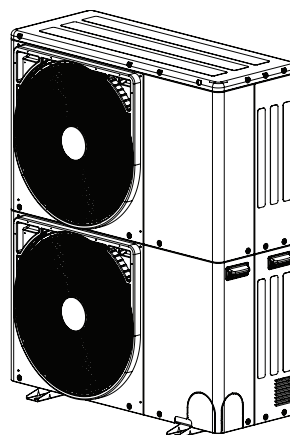

English

Español

Français

Italiano

Deutsch

Português

Polski

Česky

Русский

Hrvatski

Magyar

Türkçe

Nederlands

Ελληνικά

Svenska

Suomi

Norsk

Dansk

Română

Български

Eesti

Latviski

Slovenčina

Slovenščina

Original instruction

**ADOPTION OF NEW REFRIGERANT**

This Air Conditioner uses R410A an environmentally friendly refrigerant.

# Contents

1	Precautions for Safety . . . . .	4
2	Accessory Parts . . . . .	8
3	Installation of New Refrigerant Air Conditioner . . . . .	8
4	Installation Conditions . . . . .	9
5	Refrigerant Piping . . . . .	13
6	Electric Wiring . . . . .	22
7	Address Setting . . . . .	27
8	Test Run . . . . .	34
9	Troubleshooting . . . . .	37

Thank you for purchasing this Toshiba air conditioner.

This Installation Manual describes the installation method of the outdoor unit. For installation of indoor units, follow the Installation Manual supplied with the indoor unit.

Moreover, as this installation manual includes the important articles concerning the "Machinery" Directive (Directive 2006/42/EC), please read through the manual and make sure you understand it. After installation, give this Installation Manual, the Owner's Manual and the Installation Manual supplied with the indoor unit to the customer and tell the customer to keep them safe.

Prepare an exclusive power source for indoor units, independent to that for outdoor units.

Y-shaped branching joints or a branching header (separately purchased) are required for connecting pipes between indoor and outdoor units. Choose either of them considering the system capacity concerning piping. For installing branching pipes, refer to the installation manual of the Y-shaped branching unit or branching header (separately purchased).

Outdoor connecting branching joints are required for connecting between outdoor units.

## Generic Denomination: Air Conditioner

### Definition of Qualified Installer or Qualified Service Person

The air conditioner must be installed, maintained, repaired and removed by a qualified installer or qualified service person. When any of these jobs is to be done, ask a qualified installer or qualified service person to do them for you. A qualified installer or qualified service person is an agent who has the qualifications and knowledge described in the table below.

Agent	Qualifications and knowledge which the agent must have
Qualified installer	<ul style="list-style-type: none"> <li>The qualified installer is a person who installs, maintains, relocates and removes the air conditioners made by Toshiba Carrier Corporation. He or she has been trained to install, maintain, relocate and remove the air conditioners made by Toshiba Carrier Corporation or, alternatively, he or she has been instructed in such operations by an individual or individuals who have been trained and is thus thoroughly acquainted with the knowledge related to these operations.</li> <li>The qualified installer who is allowed to do the electrical work involved in installation, relocation and removal has the qualifications pertaining to this electrical work as stipulated by the local laws and regulations, and he or she is a person who has been trained in matters relating to electrical work on the air conditioners made by Toshiba Carrier Corporation or, alternatively, he or she has been instructed in such matters by an individual or individuals who have been trained and is thus thoroughly acquainted with the knowledge related to this work.</li> <li>The qualified installer who is allowed to do the refrigerant handling and piping work involved in installation, relocation and removal has the qualifications pertaining to this refrigerant handling and piping work as stipulated by the local laws and regulations, and he or she is a person who has been trained in matters relating to refrigerant handling and piping work on the air conditioners made by Toshiba Carrier Corporation or, alternatively, he or she has been instructed in such matters by an individual or individuals who have been trained and is thus thoroughly acquainted with the knowledge related to this work.</li> <li>The qualified installer who is allowed to work at heights has been trained in matters relating to working at heights with the air conditioners made by Toshiba Carrier Corporation or, alternatively, he or she has been instructed in such matters by an individual or individuals who have been trained and is thus thoroughly acquainted with the knowledge related to this work.</li> </ul>

Qualified service person	<ul style="list-style-type: none"> <li>The qualified service person is a person who installs, repairs, maintains, relocates and removes the air conditioners made by Toshiba Carrier Corporation. He or she has been trained to install, repair, maintain, relocate and remove the air conditioners made by Toshiba Carrier Corporation or, alternatively, he or she has been instructed in such operations by an individual or individuals who have been trained and is thus thoroughly acquainted with the knowledge related to these operations.</li> <li>The qualified service person who is allowed to do the electrical work involved in installation, repair, relocation and removal has the qualifications pertaining to this electrical work as stipulated by the local laws and regulations, and he or she is a person who has been trained in matters relating to electrical work on the air conditioners made by Toshiba Carrier Corporation or, alternatively, he or she has been instructed in such matters by an individual or individuals who have been trained and is thus thoroughly acquainted with the knowledge related to this work.</li> <li>The qualified service person who is allowed to do the refrigerant handling and piping work involved in installation, repair, relocation and removal has the qualifications pertaining to this refrigerant handling and piping work as stipulated by the local laws and regulations, and he or she is a person who has been trained in matters relating to refrigerant handling and piping work on the air conditioners made by Toshiba Carrier Corporation or, alternatively, he or she has been instructed in such matters by an individual or individuals who have been trained and is thus thoroughly acquainted with the knowledge related to this work.</li> <li>The qualified service person who is allowed to work at heights has been trained in matters relating to working at heights with the air conditioners made by Toshiba Carrier Corporation or, alternatively, he or she has been instructed in such matters by an individual or individuals who have been trained and is thus thoroughly acquainted with the knowledge related to this work.</li> </ul>
--------------------------	--

### Definition of Protective Gear





When the air conditioner is to be transported, installed, maintained, repaired or removed, wear protective gloves and 'safety' work clothing.



In addition to such normal protective gear, wear the protective gear described below when undertaking the special work detailed in the table below.

Failure to wear the proper protective gear is dangerous because you will be more susceptible to injury, burns, electric shocks and other injuries.

Work undertaken	Protective gear worn
All types of work	Protective gloves 'Safety' working clothing
Electrical-related work	Gloves to provide protection for electricians Insulating shoes Clothing to provide protection from electric shock
Work done at heights (50 cm or more)	Helmets for use in industry
Transportation of heavy objects	Shoes with additional protective toe cap
Repair of outdoor unit	Gloves to provide protection for electricians

■ Warning Indications on the Air Conditioner Unit

Warning indication	Description
 <p><b>WARNING</b> ELECTRICAL SHOCK HAZARD Disconnect all remote electric power supplies before servicing.</p>	<p><b>WARNING</b> <b>ELECTRICAL SHOCK HAZARD</b> Disconnect all remote electric power supplies before servicing.</p>
 <p><b>WARNING</b> Moving parts. Do not operate unit with grille removed. Stop the unit before the servicing.</p>	<p><b>WARNING</b> Moving parts. Do not operate unit with grille removed. Stop the unit before the servicing.</p>
 <p><b>CAUTION</b> High temperature parts. You might get burned when removing this panel.</p>	<p><b>CAUTION</b> High temperature parts. You might get burned when removing this panel.</p>
 <p><b>CAUTION</b> Do not touch the aluminum fins of the unit. Doing so may result in injury.</p>	<p><b>CAUTION</b> Do not touch the aluminum fins of the unit. Doing so may result in injury.</p>

 <p><b>CAUTION</b> <b>BURST HAZARD</b> Open the service valves before the operation, otherwise there might be the burst. Refrigerant recovery during operation is prohibited.</p>	<p><b>CAUTION</b> <b>BURST HAZARD</b> Open the service valves before the operation, otherwise there might be the burst. Refrigerant recovery during operation is prohibited.</p>
 <p><b>CAUTION</b> <b>Do not climb onto the top side.</b> Doing so may result in injury.</p>	<p><b>CAUTION</b> <b>Do not climb onto the fan guard.</b> Doing so may result in injury.</p>



# 1 Precautions for Safety

The manufacturer shall not assume any liability for the damage caused by not observing the description of this manual.

## WARNING

### General

- Before starting to install the air conditioner, read through the Installation Manual carefully, and follow its instructions to install the air conditioner. Otherwise, falling down of the unit may occur, or the unit may cause noise, vibration or water leakage.
- Only a qualified installer or qualified service person is allowed to do installation work. If installation is carried out by an unqualified individual, a fire, electric shocks, injury, water leakage, noise and / or vibration may result.
- Do not use any refrigerant different from the one specified for complement or replacement. Otherwise, abnormally high pressure may be generated in the refrigeration cycle, which may result in a failure or explosion of the product or an injury to your body.
- If using separately sold products, make sure to use Toshiba specified products only. Using unspecified products may cause fire, electric shock, water leak or other failure.
- Before opening the service panel of the outdoor unit, set the circuit breaker to the OFF position. Failure to set the circuit breaker to the OFF position may result in electric shocks through contact with the interior parts. Only a qualified installer or qualified service person is allowed to remove the service panel of the outdoor unit and do the work required.
- Before carrying out the installation, maintenance, repair or removal work, be sure to set the circuit breakers for both the indoor and outdoor units to the OFF position. Otherwise, electric shock may result.
- Place a “Work in progress” sign near the circuit breaker while the installation, maintenance, repair or removal work is being carried out. There is a danger of electric shocks if the circuit breaker is set to ON by mistake.
- Only a qualified installer or qualified service person is allowed to undertake work at heights using a stand of 50 cm or more.
- When working at heights, use a ladder which complies with the ISO 14122 standard, and follow the procedure in the ladders instructions. Also wear a helmet for use in industry as protective gear to undertake the work.
- Wear protective gloves and safety work clothing during installation, servicing and removal.
- Do not touch the aluminium fin of the outdoor unit. You may injure yourself if you do so. If the fin must be touched for some reason, first put on protective gloves and safety work clothing, and then proceed.
- Do not climb onto or place objects on top of the outdoor unit. You may fall or the objects may fall off of the outdoor unit and result in injury.
- When working at height, put a sign in place so that no-one will approach the work location before proceeding with the work. Parts or other objects may fall from above, possibly injuring a person below. Also, be sure that workers put on helmets.
- When cleaning the filter or other parts of the outdoor unit, set the circuit breaker to OFF without fail, and place a “Work in progress” sign near the circuit breaker before proceeding with the work.
- The refrigerant used by this air conditioner is the R410A.
- You shall ensure that the air conditioner is transported in stable condition. If you find any part of the product broken, contact your dealer.
- Do not modify the products. Do not also disassemble or modify the parts. It may cause a fire, electric shock or injury.
- Before starting to repair the air conditioner, read carefully through the Service Manual, and repair the air conditioner by following its instructions.
- Only qualified service person is allowed to repair the air conditioner. Repair of the air conditioner by unqualified person may give rise to a fire, electric shocks, injury, water leaks and/or other problem.

- Once the repair work has been completed, check for refrigerant leaks, and check the insulation resistance and water drainage. Then perform a trial run to check that the air conditioner is running properly.
- This appliance is intended to be used by expert or trained users in shops, in light industry and on farms, or for commercial use by lay persons.

### **Selection of installation location**

- If you install the unit in a small room, take appropriate measures to prevent the refrigerant from exceeding the limit concentration even if it leaks. Consult the dealer from whom you purchased the air conditioner when you implement the measures. Accumulation of highly concentrated refrigerant may cause an oxygen deficiency accident.
- Do not install the air conditioner in a location that may be subject to a risk of exposure to a combustible gas. If a combustible gas leaks and becomes concentrated around the unit, a fire may occur.
- When transporting the air conditioner, wear shoes with additional protective toe caps.
- When transporting the air conditioner, do not take hold of the bands around the packing carton. You may injure yourself if the bands should break.
- Do not place any combustion appliance in a place where it is directly exposed to the wind of air conditioner, otherwise it may cause imperfect combustion.
- Places where the operation sound of the outdoor unit may cause a disturbance. (Especially at the boundary line with a neighbour, install the air conditioner while considering the noise.)
- When transporting the air conditioner, use a forklift and when moving the air conditioner by hand, move the unit with 5 people.

### **Installation**

- Follow the instructions in the installation manual to install the air conditioner. Failure to follow these instructions may cause the product to fall down or topple over or give rise to noise, vibration, water leakage, etc.

- The designated bolts (M12) and nuts (M12) for securing the outdoor unit must be used when installing the unit.
- Install the outdoor unit properly in a location that is durable enough to support the weight of the outdoor unit. Insufficient durability may cause the outdoor unit to fall, which may result in injury.
- Install the unit in the prescribed manner for protection against strong wind and earthquake. Incorrect installation may result in the unit falling down, or other accidents.
- Be sure to fix the screws back which have been removed for installation or other purposes.

### **Refrigerant piping**

- Install the refrigerant pipe securely during the installation work before operating the air conditioner. If the compressor is operated with the valve open and without refrigerant pipe, the compressor sucks air and the refrigeration cycles is over pressurized, which may cause a injury.
- Tighten the flare nut with a torque wrench in the specified manner. Excessive tighten of the flare nut may cause a crack in the flare nut after a long period, which may result in refrigerant leakage.
- Ventilate the air if the refrigerant gas leaks during installation. If the leaked refrigerant gas comes into contact with fire, toxic gas may be produced.
- After installation work, check the refrigerant gas does not leak. If the refrigerant gas leaks in the room, poisonous gas generates when gas touches to fire such as fan heater, stove or cooking stove though the refrigerant gas itself is innocuous.
- When the air conditioner has been installed or relocated, follow the instructions in the Installation Manual and purge the air completely so that no gases other than the refrigerant gas will be mixed in the refrigerating cycle. Failure to purge the air completely may cause the air conditioner to malfunction.
- Nitrogen gas must be used for the airtight test.
- The charge hose must be connected in such a way that it is not slack.

- If refrigerant gas has leaked during the installation work, ventilate the room immediately. If the leaked refrigerant gas comes in contact with fire, noxious gas may be generated.

### Electrical wiring

- Only a qualified installer or qualified service person is allowed to carry out the electrical work of the air conditioner. Under no circumstances must this work be done by an unqualified individual since failure to carry out the work properly may result in electric shocks and / or electrical leaks.
- When connecting the electrical wires, repairing the electrical parts or undertaking other electrical jobs, wear gloves to provide protection for electricians, insulating shoes and clothing to provide protection from electric shocks. Failure to wear this protective gear may result in electric shocks.
- When executing address setting, test run, or troubleshooting through the checking window on the electric parts box, put on insulated gloves to provide protection from electric shock. Otherwise you may receive an electric shock.
- Use wiring that meets the specifications in the Installation Manual and the stipulations in the local regulations and laws. Use of wiring which does not meet the specifications may give rise to electric shocks, electrical leakage, smoking and / or a fire.
- Check that the product is properly earthed. (grounding work) Incomplete earthing may cause electric shock.
- Do not connect the earth line to a gas pipe, water pipe, lightning conductor, or a telephone earth line.
- After completing the repair or relocation work, check that the ground wires are connected properly.
- Install a circuit breaker that meets the specifications in the installation manual and the stipulations in the local regulations and laws.
- Install the circuit breaker where it can be easily accessed by the qualified service person.

- When installing the circuit breaker outdoors, install one which is designed to be used outdoors.
- Under no circumstances must the power cable be extended. Connection trouble in the places where the cable is extended may give rise to smoking and / or a fire.
- Electrical wiring work shall be conducted according to law and regulation in the community and installation manual. Failure to do so may result in electrocution or short circuit.
- Do not supply power from the power terminal block equipped on the outdoor unit to another outdoor unit. Capacity overflow may occur on the terminal block and may result in fire.
- When carrying out electric connection, use the wire specified in the Installation Manual and connect and fix the wires securely to prevent them applying external force to the terminals. Improper connection or fixing may result in fire.

### Test run

- Before operating the air conditioner after having completed the work, check that the electrical parts box cover of the indoor unit and service panel of the outdoor unit are closed, and set the circuit breaker to the ON position. You may receive an electric shock if the power is turned on without first conducting these checks.
- When you have noticed that some kind of trouble (such as when an error display has appeared, there is a smell of burning, abnormal sounds are heard, the air conditioner fails to cool or heat or water is leaking) has occurred in the air conditioner, do not touch the air conditioner yourself but set the circuit breaker to the OFF position, and contact a qualified service person. Take steps to ensure that the power will not be turned on (by marking "out of service" near the circuit breaker, for instance) until qualified service person arrives. Continuing to use the air conditioner in the trouble status may cause mechanical problems to escalate or result in electric shocks or other failure.

- After the work has finished, be sure to use an insulation tester set (500 V Megger) to check the resistance is 1 MΩ or more between the charge section and the non-charge metal section (Earth section). If the resistance value is low, a disaster such as a leak or electric shock is caused at user's side.
- Upon completion of the installation work, check for refrigerant leaks and check the insulation resistance and water drainage. Then conduct a test run to check that the air conditioner is operating properly.

#### Explanations given to user

- Upon completion of the installation work, tell the user where the circuit breaker is located. If the user does not know where the circuit breaker is, he or she will not be able to turn it off in the event that trouble has occurred in the air conditioner.
- If you have discovered that the fangard is damaged, do not approach the outdoor unit but set the circuit breaker to the OFF position, and contact a qualified service person to have the repairs done. Do not set the circuit breaker to the ON position until the repairs are completed.
- After the installation work, follow the Owner's Manual to explain to the customer how to use and maintain the unit.

#### Relocation

- Only a qualified installer or qualified service person is allowed to relocate the air conditioner. It is dangerous for the air conditioner to be relocated by an unqualified individual since a fire, electric shocks, injury, water leakage, noise and / or vibration may result.
- When carrying out the pump-down work shut down the compressor before disconnecting the refrigerant pipe. Disconnecting the refrigerant pipe with the service valve left open and the compressor still operating will cause air or other gas to be sucked in, raising the pressure inside the refrigeration cycle to an abnormally high level, and possibly resulting in rupture, injury or other trouble.

- Never recover the refrigerant into the outdoor unit. Be sure to use a refrigerant recovery machine to recover the refrigerant when moving or repairing. It is impossible to recover the refrigerant into the outdoor unit. Refrigerant recovery into the outdoor unit may result in serious accidents such as explosion of the unit, injury or other accidents.

---

#### CAUTION

---

#### New Refrigerant Air Conditioner Installation

- **This air conditioner adopts the new HFC refrigerant (R410A) which does not destroy ozone layer.**
- The characteristics of R410A refrigerant are; easy to absorb water, oxidizing membrane or oil, and its pressure is approx. 1.6 times higher than that of refrigerant R22. Accompanied with the new refrigerant, refrigerating oil has also been changed. Therefore, during installation work, be sure that water, dust, former refrigerant, or refrigerating oil does not enter the refrigerating cycle.
- To prevent charging an incorrect refrigerant and refrigerating oil, the sizes of connecting sections of charging port of the main unit and installation tools are changed from those for the conventional refrigerant.
- Accordingly the exclusive tools are required for the new refrigerant (R410A).
- For connecting pipes, use new and clean piping designed for R410A, and please care so that water or dust does not enter.



#### To Disconnect the Appliance from Main Power Supply.

- This appliance must be connected to the main power supply by means of a switch with a contact separation of at least 3 mm.

**The installation fuse (all type can be used) must be used for the power supply line of this conditioner.**

---

## 2 Accessory Parts

Part name	Q'ty	Shape	Usage
Owner's Manual	1		Hand this directly to the customer.
Installation Manual	1		Hand this directly to the customer.
CD-ROM (Owner's manual, Installation manual)	1	-	For other languages that do not appear in this Installation Manual, Please refer to the enclosed CD-ROM.
F-GAS label	1		Fill the items on the label after adding refrigerant.

### NOTE

- Before installing the unit, check that the unit has the correct model name to prevent the wrong unit from being installed in the wrong place.
- Before proceeding to braze the refrigerant pipe, be sure to pass nitrogen through the pipe.
- Before installing the indoor units, read the instructions in the installation manual provided with the indoor units.
- Before installing a branch pipe, read the instructions in the installation manual provided with the branch pipe kit.

## 3 Installation of New Refrigerant Air Conditioner

This air conditioner adopts the new HFC refrigerant (R410A) which does not deplete the ozone layer.

- R410A refrigerant is vulnerable to impurities such as water, oxidizing membranes, or oils because the pressure of R410A refrigerant is higher than that of the former refrigerant by approximately 1.6 times. As well as the adoption of the new refrigerant, the refrigerating oil has been also changed. Therefore, pay attention so that water, dust, former refrigerant, or refrigerating oil does not enter the refrigerating cycle of the new refrigerant air conditioner during installation.
- To prevent mixing of refrigerant or refrigerating oil, the size of the charge port of the main unit or connecting section of the installation tool differs to that of an air conditioner for the former refrigerant. Accordingly, exclusive tools are required for the new refrigerant (R410A) as shown below.
- For connecting pipes, use new and clean piping materials so that water or dust does not enter.

### Required tools and cautions on handling

It is necessary to prepare the tools and parts for installation as described below. The tools and parts which will be newly prepared in the following items should be restricted to exclusive use.

#### Explanation of symbols

- △ : Newly prepared (It is necessary to use it exclusively with R410A, separately from those for R22 or R407C.)
- ◎ : Former tool is available.

Used tools	Usage	Proper use of tools / parts
Gauge manifold	Vacuuming, charging refrigerant and operation check	△ Exclusive to R410A
Charging hose		△ Exclusive to R410A
Charging cylinder	Charging refrigerant	Unusable (Use the Refrigerant charging balance.)
Gas leak detector	Checking gas leak	△ Exclusive to R410A
Vacuum pump	Vacuum drying	Usable if a counter-flow preventive adapter is attached
Vacuum pump with counterflow	Vacuum drying	◎ R22 (Existing article)
Flare tool	Flare processing of pipes	◎ Usable by adjusting size
Bender	Bending processing of pipes	◎ R22 (Existing article)
Refrigerant recovery device	Recovering refrigerant	△ Exclusive to R410A
Torque wrench	Tightening flare nut	△ Exclusive to Ø12.70 mm and Ø15.88 mm
Pipe cutter	Cutting pipes	◎ R22 (Existing article)
Refrigerant canister	Charging refrigerant	△ Exclusive to R410A Enter the refrigerate name for identification
Welding machine / Nitrogen gas cylinder	Welding of pipes	◎ R22 (Existing article)
Refrigerant charging balance	Charging refrigerant	◎ R22 (Existing article)

# 4 Installation Conditions

## ■ Before installation

Be sure to prepare to the following items before installation.

### Airtight test

- 1** Before starting an airtight test, further tighten the spindle valves on the gas and liquid sides.
- 2** Pressurize the pipe with nitrogen gas charged from the service port to the design pressure to conduct an airtight test.
- 3** After the airtight test is completed, evacuate the nitrogen gas.

### Air purge

- To purge air, use a vacuum pump.
- Do not use refrigerant charged in the outdoor unit to purge air. (The air purge refrigerant is not contained in the outdoor unit.)

### Electrical wiring

Be sure to fix the power wires, indoor / outdoor connecting wires and remote controller wires with clamps so that they do not come into contact with the cabinet, etc.

### Earthing

## WARNING

### **Make sure that proper earthing is provided.**

Improper earthing may cause an electric shock. For details on how to check earthing, contact the dealer who installed the air conditioner or a professional installation company.

- Proper earthing can prevent charging of electricity on the outdoor unit surface due to the presence of a high frequency in the frequency converter (inverter) of the outdoor unit, as well as prevent electric shock. If the outdoor unit is not properly earthed, you may be exposed to an electric shock.
- **Be sure to connect the earth wire (grounding work).**  
Incomplete earthing can cause an electric shock.  
Do not connect earth wires to gas pipes, water pipes, lightning rods or earth wires for telephone wires.

### Test run

Turn on the leakage breaker at least 12 hours before starting a test run to protect the compressor.

## CAUTION

Incorrect installation work may result in a malfunction or complaints from customers.

## ■ Installation location

### WARNING

**Install the outdoor unit properly in a location that is durable enough to support the weight of the outdoor unit.**

Insufficient durability may cause the outdoor unit to fall, which may result in injury.

This outdoor unit has a weight of about 127 kg. Pay special attention when installing the unit onto a wall surface.

### CAUTION

**Do not install the outdoor unit in a location that is subject to combustible gas leaks.**

Accumulation of combustible gas around the outdoor unit may cause a fire.

**Install the outdoor unit in a location that meets the following conditions after the customer's consent is obtained.**

- A well-ventilated location free from obstacles near the air intake and air discharge
- A location that is not exposed to rain or direct sunlight
- A location that does not increase the operating noise or vibration of the outdoor unit
- A location that does not produce any drainage problems from discharged water

**Do not install the outdoor unit in the following locations.**

- A location with a saline atmosphere (coastal area) or one that is full of sulfide gas (hot-spring area) (Special maintenance is required.)
- A location subject to oil, vapor, oily smoke, or corrosive gases
- A location in which organic solvent is used
- Places where iron or other metal dust is present. If iron or other metal dust adheres to or collects on the interior of the air conditioner, it may spontaneously combust and start a fire.
- A location where high-frequency equipment (including inverter equipment, private power generator, medical equipment, and communication equipment) is used  
(Installation in such a location may cause malfunction of the air conditioner, abnormal control or problems due to noise from such equipment.)
- A location in which the discharged air of the outdoor unit blows against the window of a neighboring house
- A location where the operating noise of the outdoor unit is transmitted
- When the outdoor unit is installed in an elevated position, be sure to secure its fixing leg.
- A location in which drain water poses any problems.

When collectively draining discharged water completely, use a drain pan.



**⚠ CAUTION**

1. Install the outdoor unit in a location where the discharge air is not blocked.
2. When an outdoor unit is installed in a location that is always exposed to strong winds like a coast or on the high stories of a building, secure normal fan operation by using a duct or wind shield.
3. When installing the outdoor unit in a location that is constantly exposed to strong winds such as on the upper stairs or rooftop of a building, apply the wind-proofing measures referred to in the following examples.

- 1) Install the unit so that its discharge port faces the wall of the building.  
Keep a distance 500 mm or more between the unit and wall surface.

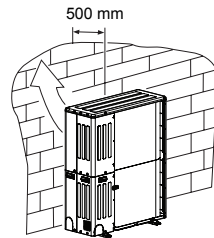

- 2) Leave a clearance of at least 250 mm between the right side panel and wall or other surface of the building for installation and servicing purposes.

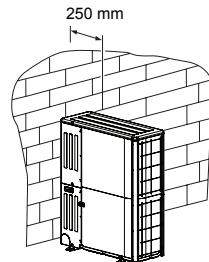

- 3) Leave a clearance of at least 200 mm between the rear panel and wall or other surface of the building in order to maintain the performance of the air conditioner.

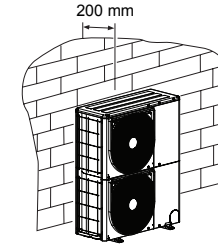

- 4) Consider the wind direction during the operational season of the air conditioner, and install the unit so that the discharge port is set at a right angle relative to the wind direction.

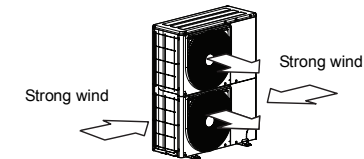

When installing the unit in an area where snowfalls may be heavy, take steps to prevent the unit from being adversely affected by the fallen or accumulated snow.

- Either make the foundation higher or install a stand (which is high enough to ensure that the unit will be above the fallen or accumulated snow) and place the unit on it.
- Attach a snow shield (locally procured).

**<Example>**

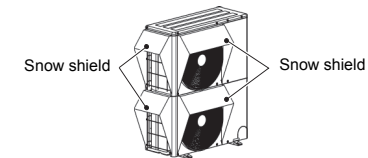

## ■ Necessary space for installation (Unit: mm)

### Obstacle at rear side

#### Upper side is free

1. Single unit installation

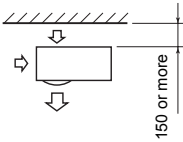

2. Obstacles on both right and left sides

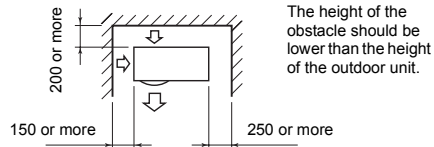

3. Serial installation of two or more units

The height of the obstacle should be lower than the height of the outdoor unit.

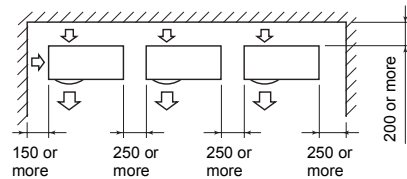

### Obstacle also above unit

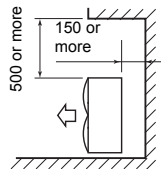

### Obstacle in front

#### Above unit is free

1. Single unit installation

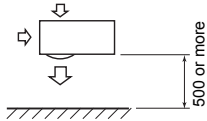

2. Serial installation of two or more units

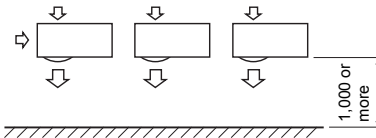

### Obstacle also above unit

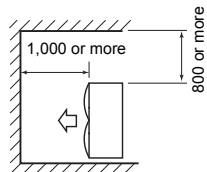

### Obstacles in both front and rear of unit

Open above and to the right and left of the unit.  
The height of an obstacle in both the front and rear of the unit, should be lower than the height of the outdoor unit.

#### Standard installation

1. Single unit installation

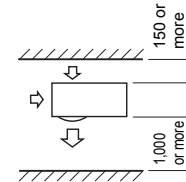

2. Serial installation of two or more units

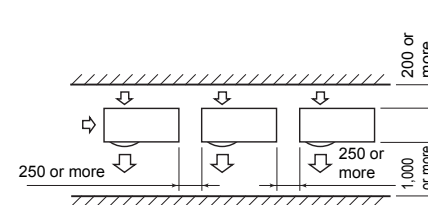

### Serial installation in front and rear

Open above and to the right and left of the unit.  
The height of an obstacle in both the front and rear of the unit should be lower than the height of the outdoor unit.

#### Standard installation

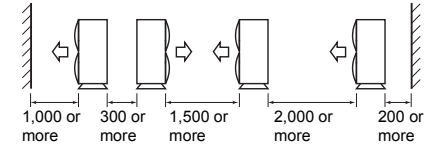

## ■ Installation of outdoor unit

- Before installation, check the strength and horizontalness of the base so that abnormal sounds do not emanate.
- According to the following base diagram, fix the base firmly with the anchor bolts.  
(Anchor bolt, nut: M12 x 4 pairs)

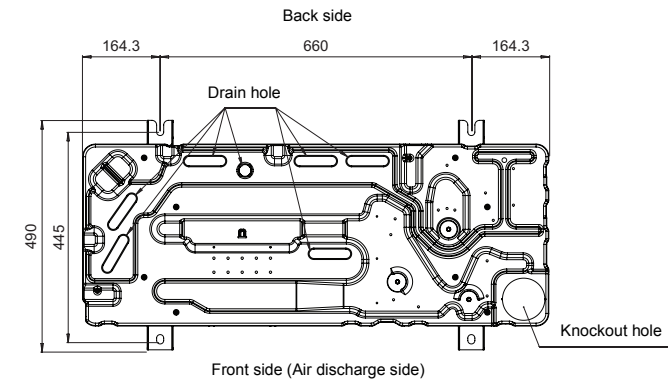



- As shown in the figure below, install vibration-proof rubber pads to directly support the bottom surface of the fixing leg.
- \* When installing the foundation for an outdoor unit with downward piping, consider the piping work.

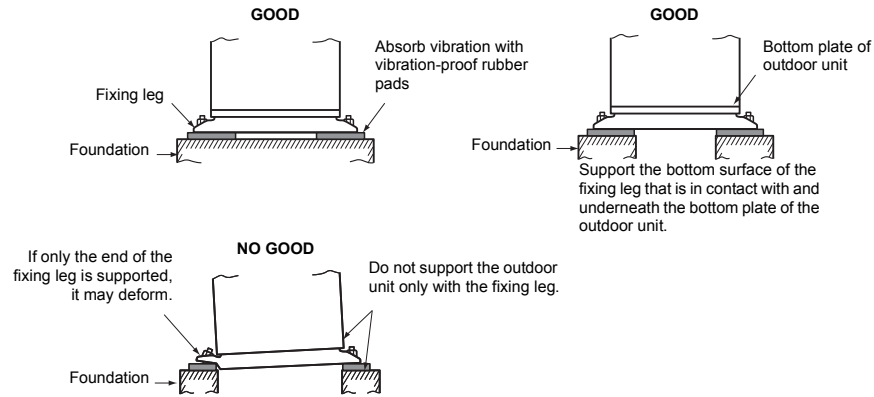

Set the out margin of the anchor bolt to 20 mm or less.

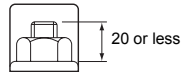

- When the unit is to be installed in a location where it is likely to be exposed to strong winds or where the foundation is unstable, additional measures must be taken to prevent tip-over as shown in the figure below.

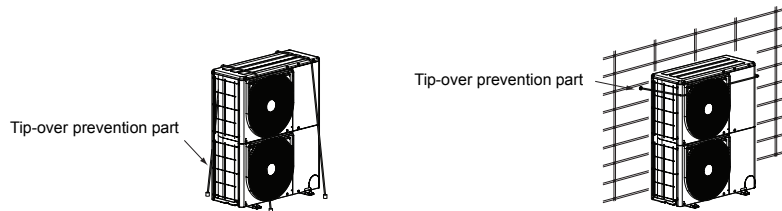

**⚠ CAUTION**

- Carry out the installation work by following the prescribed procedure to make provision against the shaking of the unit caused by strong winds, earthquakes, etc.
- Failure to carry out the installation work as prescribed may lead to the unit tipping over, in turn causing an accident.

**■ For reference**

If a heating operation is to be continuously performed for a long time under the condition that the outdoor temperature is 0 °C or lower, draining defrosted water may be difficult due to the bottom plate freezing, resulting in trouble with the cabinet or fan.

It is recommended to procure an anti-freeze heater locally in order to safely install the air conditioner. For details, contact the dealer.

# 5 Refrigerant Piping

## ■ Leading out the pipes

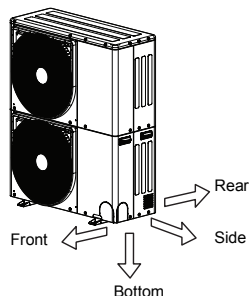

- The indoor/outdoor unit connecting pipes can be connected in any of 4 directions. Use a screwdriver to punch out the knockout part of the front panel, side panel or base. Wear heavy work gloves to protect yourself from injury while doing this work. After punching out the knockout hole in a manner which ensures that the pipes and wires will not be damaged in any way, remove the burrs from around the hole.

## ■ Optional installation parts (locally procured)

	Parts name	Q'ty
A	Refrigerant piping Liquid side: Ø9.52 mm Gas side: Ø15.88 mm or Ø19.05 mm	One each
B	Pipe insulating material (polyethylene foam, 10 mm thick)	1
C	Putty, PVC tape	One each

### REQUIREMENT

Follow the instructions in the installation manual provided with the branch pipe kit and the instructions in the installation manual of the indoor unit to connect the refrigerant pipe between the branch pipe and indoor unit.

## ■ Refrigerant piping connection

### ⚠ CAUTION

#### TAKE NOTE OF THESE 4 IMPORTANT POINTS BELOW FOR PIPING WORK

- Keep dust and moisture away from inside the connecting pipes.
- Tightly connect the connection between pipes and the unit.
- Evacuate the air in the connecting pipes using a VACUUM PUMP.
- Check for gas leaks at connection points.

### Pipe connection method

#### Flaring

- Cut the pipe with a pipe cutter.

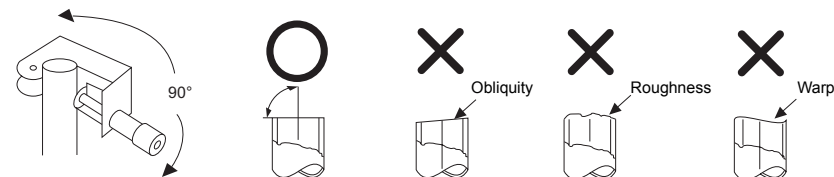

- Remove the burr inside of the pipe. When removing the burr, be careful so that chips do not fall into the pipe.
- Remove the flare nuts attached to the outdoor / indoor unit, then insert them into each of the pipes.
- Flare the pipes. See the following table for the projection margin (A) and flaring size (B).

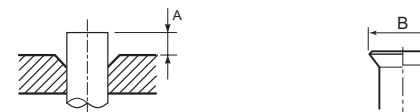

Pipe		A		B	Flare Nut		
Outside diameter	Thickness	Rigid (clutch type) R410A tool	Imperial (wing nut type) R410A tool		Width across flat	Tighten torque	
mm	mm	mm	mm	mm	mm	N·m	kgf·m
6.35	0.8	0 to 0.5	1.0 to 1.5	9.9	17	14 to 18	1.4 to 1.8
9.52	0.8	0 to 0.5	1.0 to 1.5	13.2	22	33 to 42	3.3 to 4.2
12.70	0.8	0 to 0.5	1.0 to 1.5	16.6	26	49 to 61	4.9 to 6.1
15.88	1.0	0 to 0.5	1.0 to 1.5	19.7	29	63 to 77	6.6 to 7.7
19.05	1.2	0 to 0.5	1.0 to 1.5	24.0	36	100 to 120	10.0 to 12.0

\* In case of flaring for R410A with the conventional flare tool, pull the tool out approx. 0.5 mm more than that for R22 to adjust it to the specified flare size. The copper pipe gauge is useful for adjusting the projection margin size.

**REQUIREMENT**

- For a brazing work of the refrigerant pipes, be sure to use nitrogen gas in order to prevent oxidation of the inside of the pipes; otherwise clogging of the refrigerating cycle due to oxidized scale may occur.
- Use clean and new pipes for the refrigerant pipes and perform piping work so that water or dust does not contaminate the refrigerant.
- \* **Remove all flux after brazing.**
- Be sure to use a double spanner to loosen or tighten the flare nut. If a single spanner is used, the required level of tightening cannot be obtained. Tighten the flare nut with the specified torque.
- **Do not apply refrigerant oil to the surface of the flare.**

**Coupling size of brazed pipe**

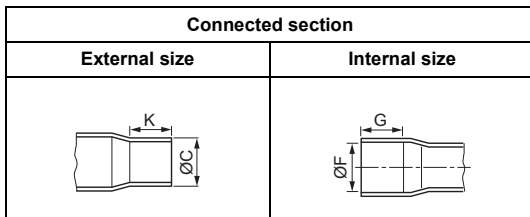

(Unit: mm)

Standard outer dia. of connected copper pipe	Connected section				Oval value	Min. thickness of coupling
	External size	Internal size	Min. depth of insertion			
	Standard outer dia. (Allowable difference)		K	G		
	C	F				
6.35	6.35 (±0.03)	6.45 (+0.04/-0.02)	7	6	0.06 or less	0.50
9.52	9.52 (±0.03)	9.62 (+0.04/-0.02)	8	7	0.08 or less	0.60
12.70	12.70 (±0.03)	12.81 (+0.04/-0.02)	9	8	0.10 or less	0.70
15.88	15.88 (±0.03)	16.00 (+0.04/-0.02)	9	8	0.13 or less	0.80
19.05	19.05 (±0.03)	19.19 (+0.03/-0.03)	11	10	0.15 or less	0.80

**■ Selection of pipe materials and size**

**Selection of pipe material**

Material: Phosphorus deoxidation seam-less pipe

**Capacity code of indoor and outdoor units**

- For the indoor unit, the capacity code is decided at each capacity rank.
- The capacity codes of the outdoor units are decided at each capacity rank. The maximum No. of connectable indoor unit and the total value of capacity codes of the indoor units are also decided.

**Minimum wall thickness for R410A application**

Soft	Half Hard or Hard	OD (Inch)	OD (mm)	Minimum wall thickness (mm)
OK	OK	1/4"	6.35	0.80
OK	OK	3/8"	9.52	0.80
OK	OK	1/2"	12.70	0.80
OK	OK	5/8"	15.88	1.00
NG *(1)	OK	3/4"	19.05	1.00

\*(1) If the pipe size is Ø19.05, use a suitable material.

**Table 1**

Indoor unit capacity type	Capacity code		Indoor unit capacity type	Capacity code	
	Equivalent to HP	Equivalent to capacity		Equivalent to HP	Equivalent to capacity
005 type	0.6	1.7	018 type	2.0	5.6
007 type	0.8	2.2	020 type	2.25	6.3
008 type	0.9	2.5	024 type	2.5	7.1
009 type	1.0	2.8	027 type	3.0	8.0
010 type	1.1	3.2	030 type	3.2	9.0
012 type	1.25	3.6	036 type	4.0	11.2
014 type	1.5	4.0	048 type	5.0	14.0
015 type	1.7	4.5	056 type	6.0	16.0
017 type	1.85	5.0	—	—	—

**Table 2**

Outdoor unit capacity type	Capacity code	No. of connectable indoor units	Total capacity code of connectable indoor units	
	Equivalent to HP		Min. (HP) *(2)	Max. (HP)
040 type	4	2 to 8	3.2	5.2
050 type	5	2 to 10	4.0	6.5
060 type	6	2 to 13	4.8	7.8

\*(2) When system includes Air to Air Heat Exchanger with DX-Coil Unit, refer to table3. for Min. (HP) capacity.

**Table 3**

Outdoor unit capacity type	Capacity code	Min. (HP)		
		Ratio of connected Air to Air Heat Exchanger with DX-Coil Units *(3)		
	Equivalent to HP	30% or less	Over 30% to 60%	Over 60% to 100%
040 type	4	3.6	4.0	4.4
050 type	5	4.5	5.0	5.5
060 type	6	5.4	6.0	6.6

\*(3) Ratio of connected Air to Air Heat Exchanger with DX-Coil Units (%) =  $\frac{\text{Total capacity code of connected Air to Air Heat Exchanger with DX-Coil Units (HP)}}{\text{Total capacity code of all connected indoor units (HP)}}$

■ Selection of refrigerant piping

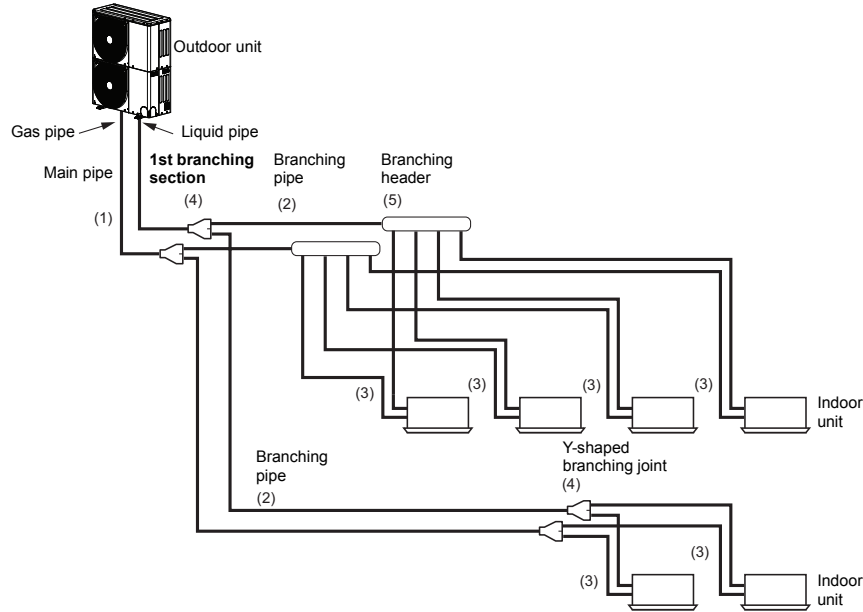

(3)	Branching section ↓ Indoor unit	Indoor unit connecting pipe	Connecting pipe size of indoor unit		
			Capacity rank	Gas pipe	Liquid pipe
			005 to 012 type	9.52	6.35
			014 to 018 type	12.70	6.35
			020 to 056 type	15.88	9.52
(4)	Branching section	Y-shaped branching joint	Selection of branching section (Y-shaped branching joint)		
				Model name	
			Y-shape branch joint	RBM-BY55E	
(5)	Branching section	Branching header	Selection of branching section (Branching header)		
				Model name	
			Branching header *	For 4 branches	RBM-HY1043E
			For 8 branches	RBM-HY1083E	
* Up to total 6.0 of maximum equivalent to HP capacity codes is connectable to one line after branching of header.					

No.	Piping parts	Name	Selection of pipe size				Remarks
(1)	Outdoor unit ↓ 1st branching section	Main pipe	Size of main pipe				Same as connecting pipe size of the outdoor unit.
			Outdoor unit capacity type	Gas pipe	Liquid pipe		
			0404 type	15.88	9.52		
			0504 type	15.88	9.52		
			0604 type	19.05	9.52		
(2)	Branching section ↓ Branching section	Branching pipe	Pipe size between branching sections				Pipe size differs based on the total capacity code value of indoor units at the downstream side. If the total value exceeds the capacity code of the outdoor unit, apply the capacity code of the outdoor unit. (See Table 1 and 2.)
			Total capacity codes of indoor units at downstream side		Gas pipe	Liquid pipe	
			Equivalent to HP	Equivalent to capacity			
			Below 2.4	Below 6.6	12.70	9.52	
			2.4 to below 6.4	6.6 to below 18.0	15.88	9.52	
6.4 or more	18.0 or more	19.05	9.52				

■ Selection of refrigerant piping for quiet place (with PMV Kit)

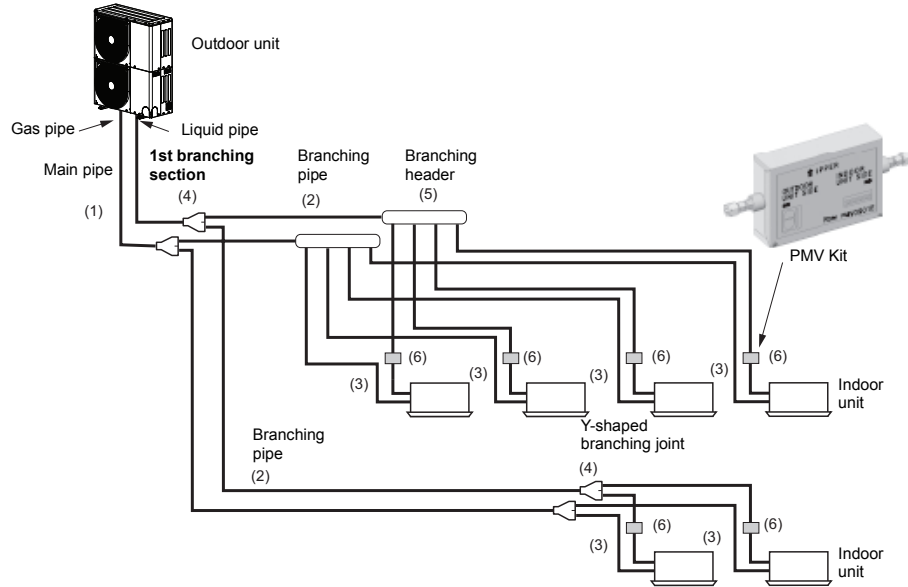

(3)	Branching section ↓ Indoor unit	Indoor unit connecting pipe	Connecting pipe size of indoor unit		
			Capacity rank	Gas pipe	Liquid pipe
			005 to 012 type	9.52	6.35
			014 to 018 type	12.70	6.35
			020 to 056 type	15.88	9.52
(4)	Branching section	Y-shaped branching joint	Selection of branching section (Y-shaped branching joint)		
				Model name	
			Y-shape branch joint	RBM-BY55E	
(5)	Branching section	Branching header	Selection of branching section (Branching header)		
				Model name	
			Branching header *	For 4 branches	RBM-HY1043E
			For 8 branches	RBM-HY1083E	
* Up to total 6.0 of maximum equivalent to HP capacity codes is connectable to one line after branching of header.					
(6)	PMV Kit	PMV Kit	Selection of PMV Kit		
			Capacity rank	Model name	
			005 to 014 type	RBM-PMV0362E	
			015 to 027 type	RBM-PMV0902E	
* PMV kit can be connected less than 027 type FCU.					

No.	Piping parts	Name	Selection of pipe size				Remarks
(1)	Outdoor unit ↓ 1st branching section	Main pipe	Size of main pipe				Same as connecting pipe size of the outdoor unit.
			Outdoor unit capacity type	Gas pipe	Liquid pipe		
			0404 type	15.88	9.52		
			0504 type	15.88	9.52		
			0604 type	19.05	9.52		
(2)	Branching section ↓ Branching section	Branching pipe	Pipe size between branching sections				Pipe size differs based on the total capacity code value of indoor units at the downstream side. If the total value exceeds the capacity code of the outdoor unit, apply the capacity code of the outdoor unit. (See Table 1 and 2.)
			Total capacity codes of indoor units at down stream side		Gas pipe	Liquid pipe	
			Equivalent to HP	Equivalent to capacity			
			Below 2.4	Below 6.6	12.70	9.52	
			2.4 to below 6.4	6.6 to below 18.0	15.88	9.52	
6.4 or more	18.0 or more	19.05	9.52				

**Allowable length / height difference of refrigerant piping**

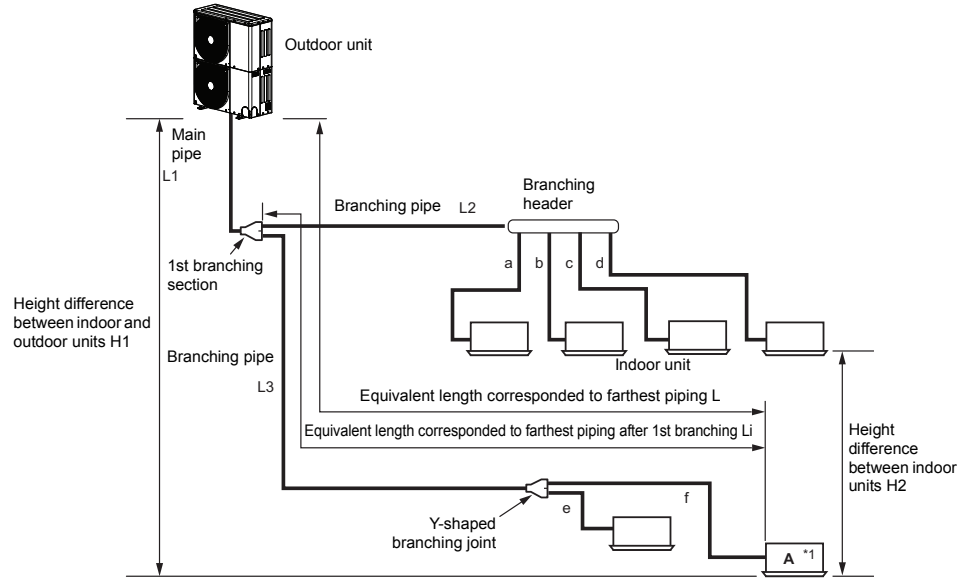

		Allowable value	Pipes
Piping Length	Total extension of pipe (liquid pipe, real length)	180 m	$L1 + L2 + L3 + a + b + c + d + e + f$
	Furthest piping length L (*1)	Real length	100 m
		Equivalent length	125 m
	Max. equivalent length of main pipe	65 m	L1
	Max. equivalent length of furthest piping from 1st branching Li (*1)	35 m	$L3 + f$
	Max. real length of indoor unit connecting pipe	15 m	a, b, c, d, e, f
Height Difference	Height between indoor and outdoor units H1	Upper outdoor unit	30 m
		Lower outdoor unit	20 m
	Height between indoor units H2	15 m	

\*1 Furthest indoor unit from 1st branch to be named "A".

**Allowable length / height difference of refrigerant piping for quiet places (with PMV Kit)**

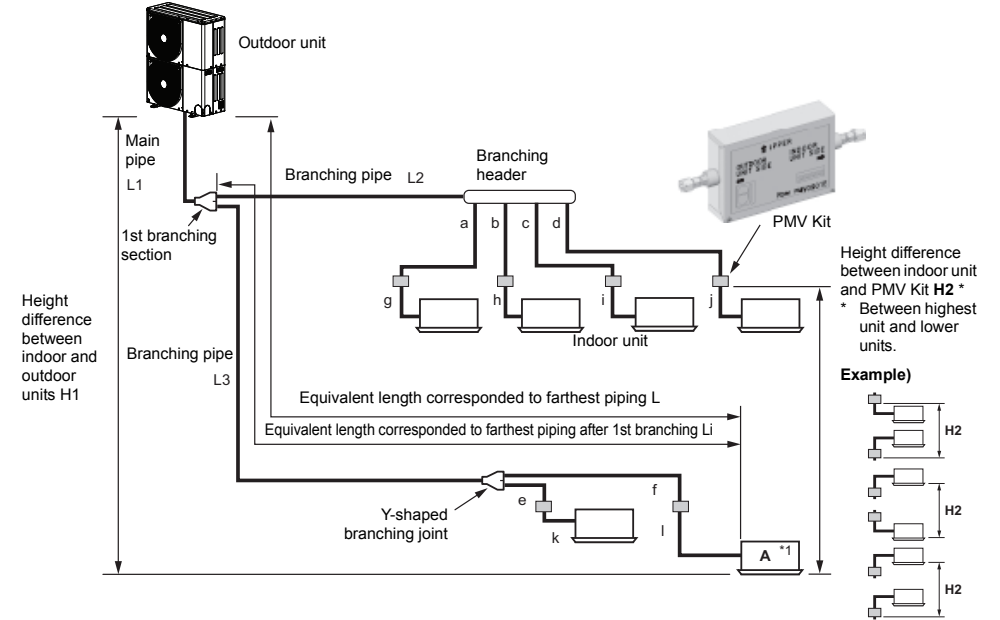

		Allowable value	Pipes
Piping Length	Total extension of pipe (Liquid pipe, real length)	150 m	$L1 + L2 + L3 + a + b + c + d + e + f + g + h + i + j + k + l$
	Furthest piping length L (*1)	Real length	65 m
		Equivalent length	80 m
	Max. equivalent length of main pipe	50 m	L1
	Max. equivalent length of furthest piping from 1st branching Li (*1)	15 m	$L3 + f + l$
	Max. real length of indoor unit connecting pipe	15 m	$a + g, b + h, c + i, d + j, e + k, f + l$
	Real length between PMV Kit and indoor unit	2 m or more Below 10 m	g, h, i, j, k, l
Height Difference	Height between indoor and outdoor units H1	Upper outdoor unit	30 m
		Lower outdoor unit	20 m
	Height between indoor units (PMV Kit) H2	15 m	

\*1 Furthest indoor unit from 1st branch to be named "A".

**NOTE**

Do not connect two or more indoor units to one PMV Kit. Arrange one indoor unit and one PMV Kit set to 1 by 1.



**■ Airtight test**

Before starting an airtight test, further tighten the spindle valves on the gas side and liquid side. Pressurize the pipe with nitrogen gas charged from the service port to the design pressure to conduct the airtight test. After the airtight test is completed, evacuate the nitrogen gas.

- Apply pressure from the service ports of the packed valves (or ball valves) at liquid side and gas side.
- An air tight test can be only performed to the service ports at liquid side and gas side of the outdoor unit.
- Close fully valves at liquid side and gas side. As there is possibility that nitrogen gas enters in the refrigerant cycle, re-tighten the valve rods before applying pressure.

(Re-tightening of the valve rods are unnecessary for valves at gas side because they are ball valves.)

- For each refrigerant line, apply pressure gradually with steps at liquid side and gas side.

**Apply pressure to gas side and liquid side.**

**REQUIREMENT**

Do not use "Oxygen", "Flammable gas" and "Noxious gas" in an airtight test.

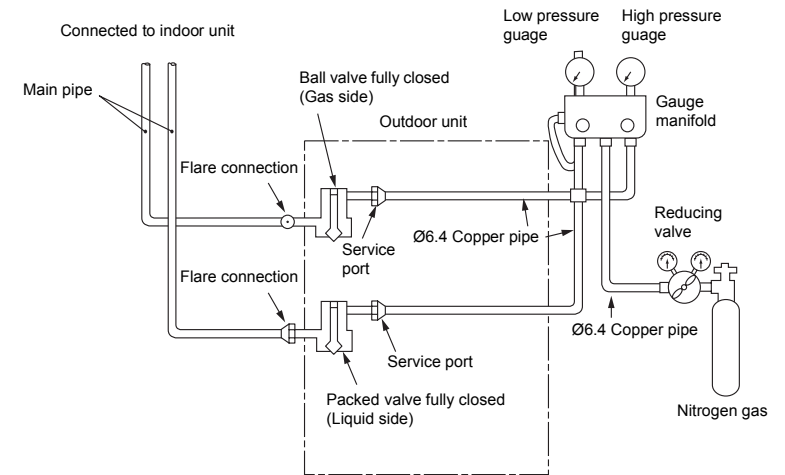

**To detect a gross leakage**

1. Apply pressure 0.3 MPa (3.0 kg / cm<sup>2</sup>G) for 3 minutes or more.
2. Apply pressure 1.5 MPa (15 kg / cm<sup>2</sup>G) for 3 minutes or more.

**To detect a slow leakage**

3. Apply pressure 3.73 MPa (38 kg / cm<sup>2</sup>G) for approx. 24 hours.

- Check pressure down.  
No pressure down: Accepted  
Pressure down: Check the leaked position.

**NOTE**

However, if the environmental temperature changes from the moment of applying pressure to 24 hours after that, the pressure will change by about 0.01 MPa (0.1 kg / cm<sup>2</sup>G) per 1 °C. Consider the pressure change when checking the test result.

**REQUIREMENT**

When pressure decrease is detected in steps 1-3, check the leakage at the connecting points. Check the leakage using a foaming agent or other measures and seal the leak with re-brazing, flare retightening or other methods. After sealing, execute an airtight test again.

**■ Air purge**

**NOTE**

For the air purge at installation time (Discharge of air in connecting pipes), use "Vacuum pump method" from viewpoint of the protection of the earth's environment.

- For protection of the earth's environment, do not discharge the refrigerant gas in the air.
  - Eliminate the remaining air (nitrogen gas, etc.) in the unit by using a vacuum pump.
- If gas remains, performance and reliability of the unit may be reduced.

After the airtight test, discharge nitrogen gas. Then connect the gauge manifold to the service ports at gas side and liquid side, and connect the vacuum pump as shown in the following figure.

Perform vacuuming for gas side and liquid side.

- Perform vacuuming from both liquid and gas sides.
- Use a vacuum pump with counter-flow preventive function so that oil in the pump does not back up in the pipe of the air conditioner when the pump has been stopped. (If oil in the vacuum pump enters in to the air conditioner with R410A refrigerant, an error may occur in the refrigeration cycle.)

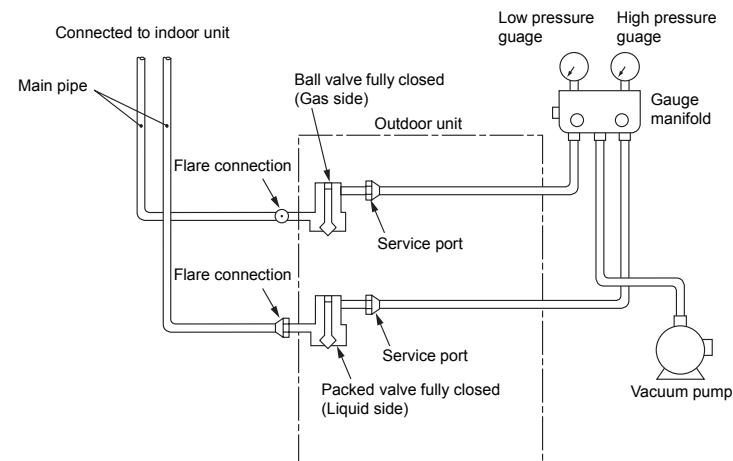

- Use a vacuum pump that has a high vacuum (below -755 mmHg) and a large exhaust gas amount (over 40 L / minute).
- Perform vacuuming for 2 or 3 hours though time differs due to pipe length. In this time, check all valves at liquid and gas sides are fully closed.
- If vacuuming valve amount is not decreased to below -755 mmHg even after vacuuming for 2 hours or more, continue vacuuming for 1 hour or more. If -755 mmHg or less cannot be obtained by 3 hours or more vacuuming, detect and repair the leak.
- When the vacuuming valve has reached -755 mmHg or less after vacuuming for 2 hours or more, close valves VL and VH on the gauge manifold fully. Stop the vacuum pump, leave it as it is for 1 hour and then check the vacuum does not change. If it does change then there may be a leak within the system.
- After the above procedure for vacuuming has finished, exchange the vacuum pump with a refrigerant cylinder and advance to the additional charging of refrigerant.



### ■ Adding refrigerant

After finishing vacuuming, exchange the vacuum pump with a refrigerant canister and start additional charging of refrigerant.

#### Calculation of additional refrigerant charge amount

Default refrigerant amount does not include the refrigerant for pipes at the local site.

For refrigerant to be charged in pipes at the local site, calculate the amount and charge it additionally.

Outdoor unit type	MHP0404	MHP0504	MHP0604
Charging amount (kg)	6.4	6.4	6.4

$$\text{Additional refrigerant charge amount at local site} = \text{Real length of liquid pipe} \times \text{Additional refrigerant charge amount per 1 m liquid pipe (Table 1)} + \text{Compensation by outdoor HP (Table 2)}$$

Table 1

Liquid pipe dia. (mm)	6.35	9.52
Additional refrigerant amount / 1 m liquid pipe (kg / m)	0.025	0.055

Table 2

Outdoor unit type	MHP0404	MHP0504	MHP0604
Compensation by outdoor HP (kg)	0	0.4	0.8

#### Example: (060 type)

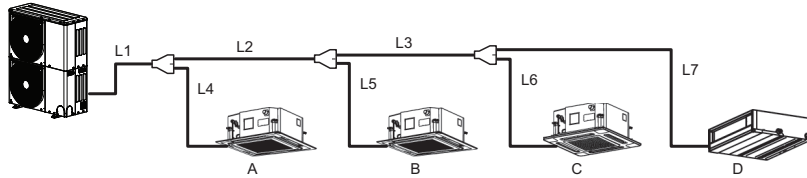

L1	Ø9.52: 10 m	L2	Ø9.52: 10 m	L3	Ø9.52: 5 m	L4	Ø9.52: 3 m
L5	Ø6.35: 3 m	L6	Ø6.35: 4 m	L7	Ø6.35: 5 m		

#### Additional charge amount R (kg)

$$\begin{aligned} &= (Lx \times 0.025 \text{ kg/m}) + (Ly \times 0.055 \text{ kg/m}) + (0.8 \text{ kg}) \\ &= (12 \times 0.025 \text{ kg}) + (28 \times 0.055 \text{ kg}) + (0.8 \text{ kg}) \\ &= 2.64 \text{ kg} \end{aligned}$$

Lx: Real total length of liquid pipe diameter 6.35 mm (m)

Ly: Real total length of liquid pipe diameter 9.52 mm (m)

#### Charging of refrigerant

- Keeping the valve of the outdoor unit closed, be sure to charge the liquid refrigerant into the service port at the liquid side.
- If the specified amount of refrigerant cannot be charged, fully open the valves of the outdoor unit at liquid and gas sides, operate the air conditioner in COOL mode, and then charge refrigerant into service port at the gas side. In this time, choke the refrigerant slightly by operating the valve of the canister to charge liquid refrigerant.
- The liquid refrigerant may be charged suddenly, therefore be sure to charge refrigerant gradually.

### ■ Full opening of the valve

Open the valves of the outdoor unit fully.

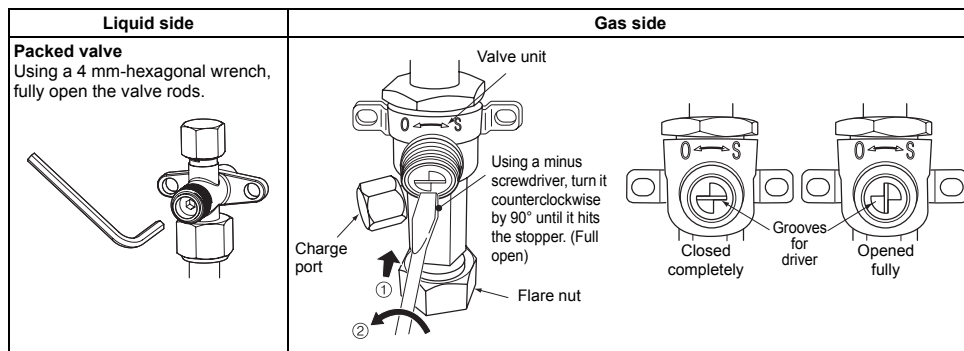

### ■ F-GAS label

This product contains fluorinated greenhouse gases covered by the Kyoto Protocol.

- Chemical Name of Gas R410A
- Global Warming Potential (GWP) of Gas 1975

### ⚠ CAUTION

1. Stick the enclosed refrigerant label adjacent to the charging and/or recovering location.
2. Clearly write the charged refrigerant quantity on the refrigerant label using indelible ink. Then, place the included transparent protective sheet over the label to prevent the writing from rubbing off.
3. Prevent emission of the contained fluorinated greenhouse gas. Ensure that the fluorinated greenhouse gas is never vented to the atmosphere during installation, service or disposal. When any leakage of the contained fluorinated greenhouse gas is detected, the leak shall be stopped and repaired as soon as possible.
4. Only qualified service personnel are allowed to access and service this product.

5. Any handling of the fluorinated greenhouse gas in this product, such as when moving the product or recharging the gas, shall comply under (EC) Regulation No. 842/2006 on certain fluorinated greenhouse gases and any relevant local legislation.
6. Periodical inspections for refrigerant leaks may be required depending on European or local legislation.
7. Contact dealers, installers, etc., for any questions.

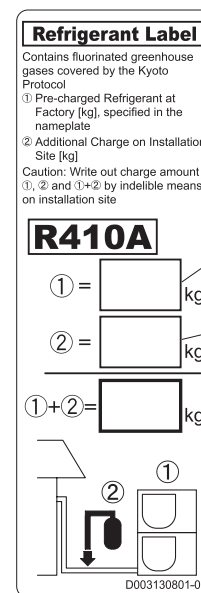

Pre-charged Refrigerant at Factory [kg], specified in the nameplate

Additional Charge on Installation Site [kg]

### ■ Heat insulation for pipe

- Apply heat insulation of pipe separately at the liquid, gas, and balance sides.
- Be sure to use thermal insulator resistant up to 120 °C or higher for pipes at the gas side.

■ **Finishing after connecting pipes**

- After piping connection work has been finished, cover the opening of the piping / wiring panel with the piping cover, or fill silicon or putty into the space between the pipes.
- In case of drawing-out the pipes downward or sideward, also close the openings of the base plate and the side plate.
- Under the opened condition, a problem may be caused due to the entering of water or dust.

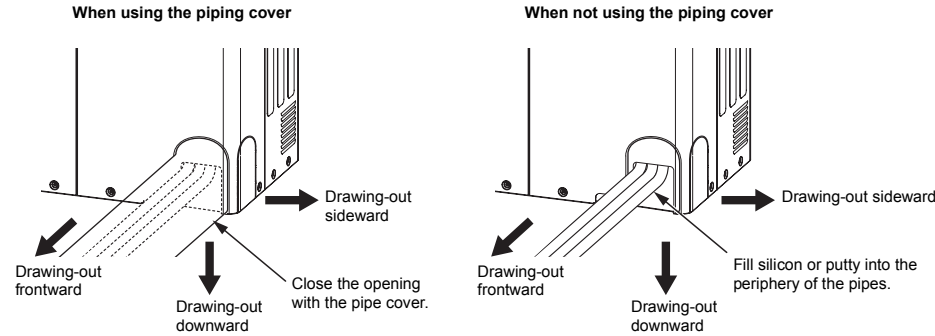

**Pipe holding bracket**

Attach pipe holding brackets following the table below.

Diameter of pipe (mm)	Interval
Ø19.05 or less	2 m

# 6 Electric Wiring

**⚠ WARNING**

**The appliance shall be installed in accordance with national wiring regulations.**

Capacity shortages of the power circuit or an incomplete installation may cause an electric shock or fire.

**⚠ CAUTION**

- Perform wiring of power supply complying with the rules and regulations of the local electric company.
- Do not connect 220-240 V power to the terminal blocks for control cables (U1, U2, U3, U4); otherwise, the unit may break down.
- Be sure that electric wiring does not come into contact with high-temperature parts of piping; otherwise, the coating of cables may melt and cause an accident.
- After connecting wires to the terminal block, take off the traps and fix the wires with cord clamps.
- Do not conduct power to indoor units until vacuuming of the refrigerant pipes has finished.
- For the wiring of power to indoor units and that between indoor and outdoor units, follow the instructions in the installation manual of each indoor unit.
- Prepare an exclusive power supply for the air conditioner.

**Power wiring selection**

**Standard model**

MCA: Maximum Circuit Amps  
MOCP: Maximum Overcurrent Protection (Amps)

Model	Power Supply Nominal Voltage, Phase and frequency	MCA (A)	MOCP (A)
MCY-MHP0404*	220-240 V 1N~, 50 Hz	23.5	32.0
MCY-MHP0504*		26.5	32.0
MCY-MHP0604*		28.0	32.0

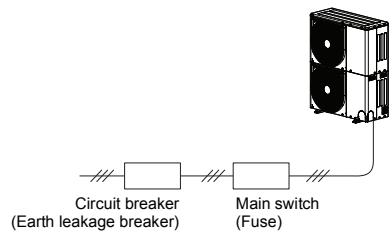

**Specifications for communication wiring**

**Design of communication wiring**

**Summary of communication wiring**

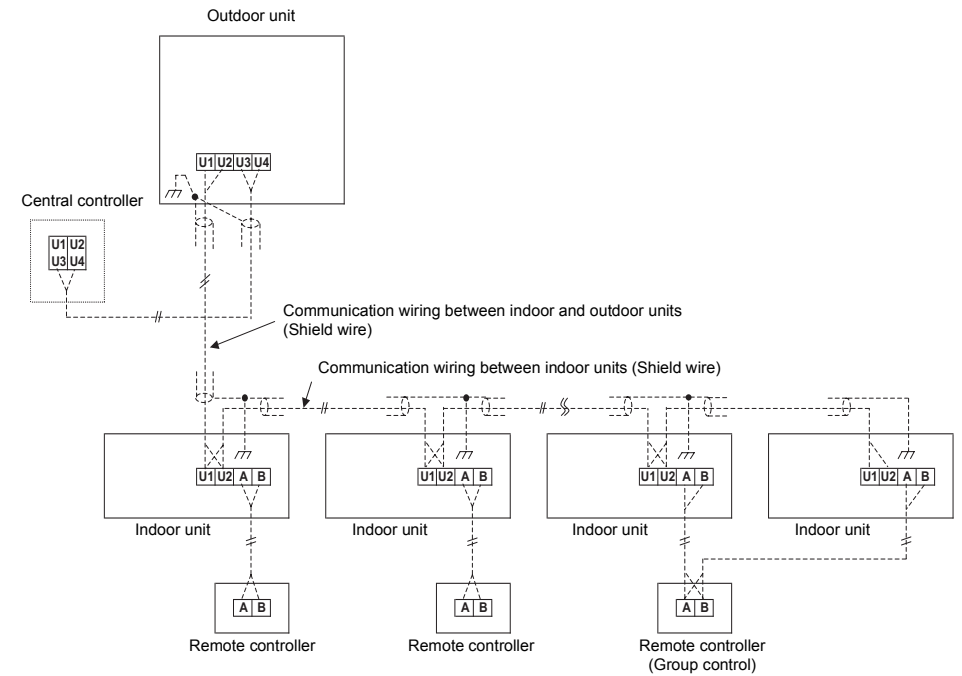

Communication wiring and central control wiring use 2-core non-polarity wires.

Use 2-core shield wires to prevent noise trouble.

In this case, for the system grounding, close (connect) the end of shield wires, and isolate the end of terminal.

Use 2-core non-polarity wire for remote controller. (A, B terminals)

Use 2-core non-polarity wire for wiring of group control. (A, B terminals)

Keep the rule of below tables about size and length of communication wiring.

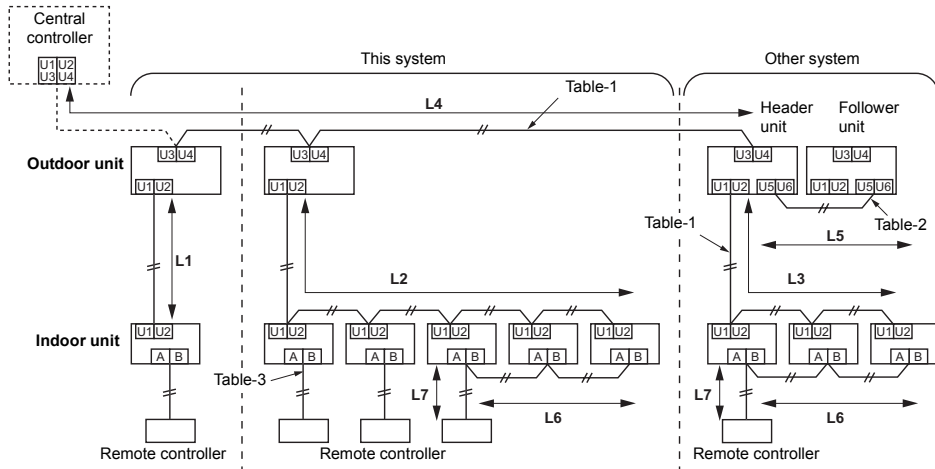

**Table-1 Control wiring between indoor and outdoor units (L1, L2, L3), Central control wiring (L4)**

Wiring	2-core, non-polarity
Type	Shield wire
Size / Length *1	1.25 mm <sup>2</sup> : Up to 1000 m 2.0 mm <sup>2</sup> : Up to 2000 m

\*1 Total of control wiring length for all refrigerant circuits ( L1 + L2 + L3 + L4 )

**Table-2 Control wiring between outdoor units (L5) (Other system)**

Wiring	2-core, non-polarity
Type	Shield wire
Size / Length	1.25 mm <sup>2</sup> to 2.0 mm <sup>2</sup> Up to 100 m (L5)

**Table-3 Remote controller wiring (L6, L7)**

Wiring	2-core
Size	0.5 mm <sup>2</sup> to 2.0 mm <sup>2</sup>
Length	<ul style="list-style-type: none"> <li>Up to 500 m (L6 + L7)</li> <li>Up to 400 m with of wireless remote controller in group control.</li> <li>Up to 200 m total length of control wiring between indoor units ( L6 )</li> </ul>

### Group control through a remote controller

Group control of multiple indoor units (8 units) through a single remote controller

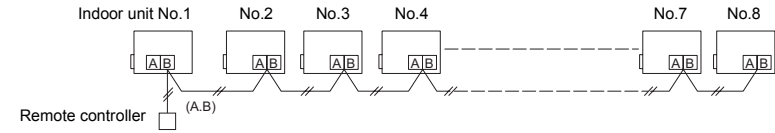

### ■ Connection of power wires and communication wires

Remove knockouts on the piping / wiring panel on the front of the unit or the panel on the bottom to get the power and communication wires through the holes.  
Use the protective parts, such as flexible bushings, to prevent the power wire and communication wire from contacting the edge of the metal plate.

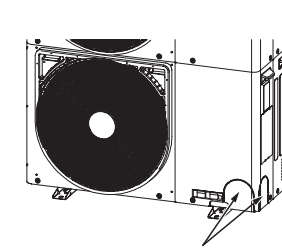

Knockout for the communication wires and refrigerant piping

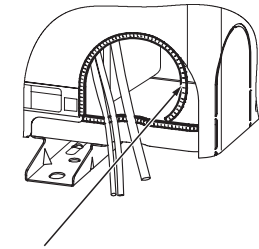

Protection components

### NOTE

Separate the power wire and communication wires.

Remove the front panel and then remove the cover of the electrical control box.

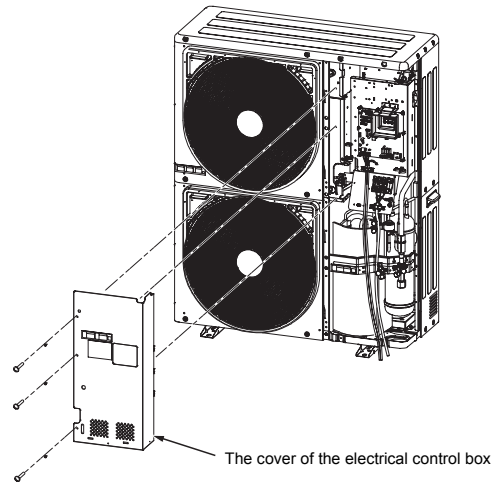

The cover of the electrical control box

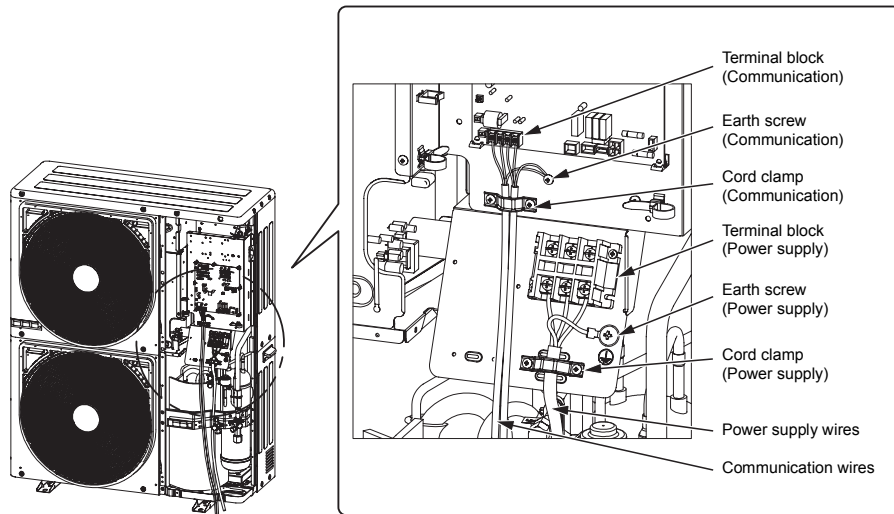

### Power supply wire connection

1. Insert the power supply wire through the cutout on the side of the electrical control box and connect the power supply wire to the power supply terminal block and the earth line to the earth screw. After that, fix the power supply wire with the cord clamp.
2. Use round-type crimping terminals for power connection.  
 Also, apply insulating sleeves to the crimping parts. Use a driver of appropriate size to fix the terminal screws.

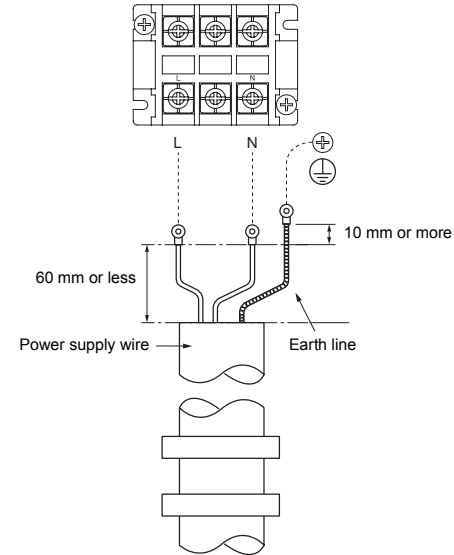

Wire size*
4.0 mm <sup>2</sup>

\* Design 60245 IEC66

### Screw size and tightening torque

	Screw size	Tightening torque (N·m)
Power supply terminal	M6	2.5 to 3.0
Earth screw	M8	5.5 to 6.6

**Communication wire connection**

Connect the communication wires to the communication wire terminals from under the electrical control box, and fix them with the communication cable clamps.

[U1, U2] and [U3, U4] not connected

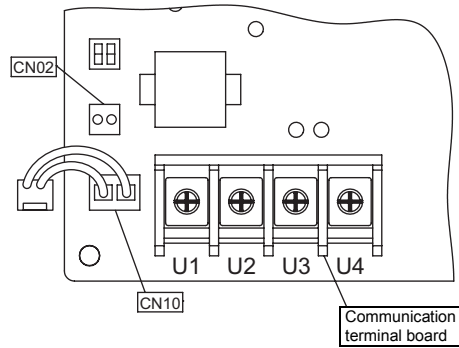

[U1, U2] and [U3, U4] connected

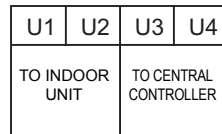
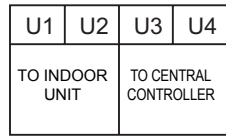
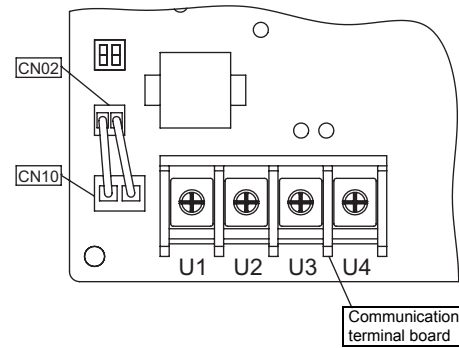

U3, U4: Central control device

U1, U2: Communication wiring between Indoor / Outdoor unit

**Screw size and tightening torque**

	Screw size	Tightening torque (N•m)
Communication wire terminal	M4	1.2 to 1.4

**Regulation of harmonic current**

The equipment is professional-use equipment. So must be installed, maintained, repaired and removed by a qualified installer or qualified service person.

This equipment complies with IEC 61000-3-12 provided that the short-circuit power  $S_{sc}$  is greater than or equal to  $S_{sc}^{(*)}$  at the interface point between the user's supply and the public system. It is the responsibility of the installer or user of the equipment to ensure, by consultation with the distribution network operator if necessary, that the equipment is connected only to a supply with a short-circuit power  $S_{sc}$  greater than or equal to  $S_{sc}^{(*)}$ .

Furthermore, when similar equipment or other equipment which may cause harmonic current emissions are to be connected to the same interface point with this equipment, to reduce the risk of possible problems which may be caused from addition of those harmonic current emissions, it is recommended to make sure that the short-circuit power  $S_{sc}$  at the interface point is greater than the sum of the minimum  $S_{sc}$  required by all the equipment which will be connected to the interface point.

$S_{sc}^{(*)}$

Model	$S_{sc}$ (kVA)
MCY-MHP0404HS(J)-E	940
MCY-MHP0504HS(J)-E	
MCY-MHP0604HS(J)-E	

# 7 Address Setting

On this unit, it is required to set the addresses of the indoor units before starting air conditioning. Set the addresses following the steps below.

## ⚠ CAUTION

- Be sure to complete the electric wiring before setting the addresses.
- If you turn on the outdoor unit before turning on the indoor units, the CODE No. [E19] is indicated on the 7-segment display on the interface P.C. board of the outdoor unit until the indoor units are turned on. This is not a malfunction.
- It may take up to ten minutes (normally about five minutes) to address one refrigerant line automatically.
- Settings on the outdoor unit are required for automatic addressing. (Address setting is not started simply by turning on the power.)
- Running the unit is not required for address setting.
- The addresses can be set manually.

Automatic addressing: setting addresses using SW15 on the interface P.C. board on the outdoor unit

Manual addressing: setting addresses on the wired remote controller.

\* When setting an address manually, the wired remote controller must temporarily be paired with an indoor unit one-to-one. (when the system is organized for group operation and no Remote controller)

## REQUIREMENT

High voltage parts exist in the electrical control box. If you set addresses on an outdoor unit, operate the unit through the cover of electrical control box, to avoid electric shock. Do not remove the cover of electrical control box.

## ■ Automatic address setting

No central control (single refrigerant line): go to Address setting procedure 1  
 Central control of 2 or more refrigerant lines: go to Address setting procedure 2

(Example)	When controlling a single refrigerant line centrally	When controlling 2 or more refrigerant lines centrally
Address setting procedure	To procedure 1	To procedure 2
System wiring diagram		

### Address setting procedure 1

- 1 Turn on indoor units first, and then turn on outdoor units.
- 2 About one minute after turning the power on, confirm that the 7-segment display on the interface P.C. board of the outdoor unit indicates **[U. 1. L08 (U. 1. flash)]**.
- 3 Press SW 15 to start the automatic address setting. (It may take up to 10 minutes (normally about 5 minutes) to complete one line's setting.)
- 4 The 7-segment display indicates **[Auto 1 → Auto 2 → Auto 3]**. After the indication, **[U. 1. --- (U. 1. flash)]** starts flashing on the display. When the flashing stops and **[U. 1. --- (U. 1. light)]** remains lit on the display, the setting is complete.

Interface P.C. board on the outdoor unit

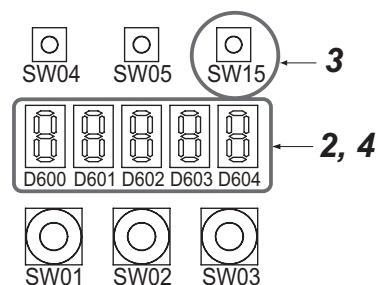



**REQUIREMENT**

- When 2 or more refrigerant lines are controlled as a group, be sure to turn on all the indoor units in the group before setting addresses.
- If you set the unit addresses of each line separately, each line's header indoor unit is set separately. In that case, the CODE No. "L03" (Indoor header unit overlap) is indicated as running starts. Change the group address to make one unit the header unit using wired remote controller.

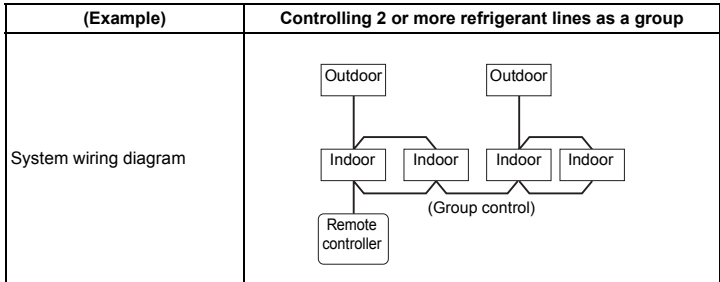

**Address setting procedure 2**

- 1 Set a system address for each system using SW 13 and 14 on the interface P.C. board on the outdoor unit of each system.  
(Factory default: Address 1)

**NOTE**

Be sure to set a unique address on each system. Do not use a same address as another system (refrigerant line) or a custom side.

**Interface P.C. board on the outdoor unit**

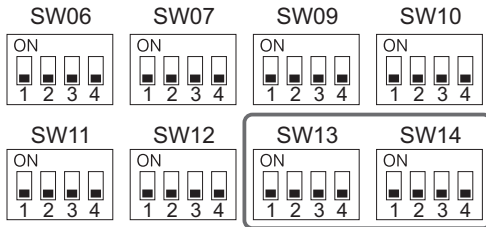

**Switch settings for a line (system) address on the interface P.C. board on the outdoor unit**  
(O: switch ON, x: switch OFF)

Line (system) address	SW13				SW14			
	1	2	3	4	1	2	3	4
1	-	-	-	x	x	x	x	x
2	-	-	-	x	O	x	x	x
3	-	-	-	x	x	O	x	x
4	-	-	-	x	O	O	x	x
5	-	-	-	x	x	x	O	x
6	-	-	-	x	O	x	O	x
7	-	-	-	x	x	O	O	x
8	-	-	-	x	O	O	O	x
9	-	-	-	x	x	x	x	O
10	-	-	-	x	O	x	x	O
11	-	-	-	x	x	O	x	O
12	-	-	-	x	O	O	x	O
13	-	-	-	x	x	x	O	O
14	-	-	-	x	O	x	O	O
15	-	-	-	x	x	O	O	O
16	-	-	-	x	O	O	O	O
17	-	-	-	O	x	x	x	x
18	-	-	-	O	O	x	x	x
19	-	-	-	O	x	O	x	x
20	-	-	-	O	O	O	x	x
21	-	-	-	O	x	x	O	x
22	-	-	-	O	O	x	O	x
23	-	-	-	O	x	O	O	x
24	-	-	-	O	O	O	O	x
25	-	-	-	O	x	x	x	O
26	-	-	-	O	O	x	x	O
27	-	-	-	O	x	O	x	O
28	-	-	-	O	O	O	x	O

"-": not used for system address setting (Do not change their positions.)

**2** In all the outdoor units connected to the central control, please make sure that the relay connector of the interface P.C. board "CN10" has not been connected to the "CN02".

**NOTE**

If you connect a relay connector "CN10" to "CN02", the communication line [U1, U2] will be connected to [U3, U4].  
If [U1, U2] is connected to the [U3, U4], refrigerant line address cannot be set correctly.

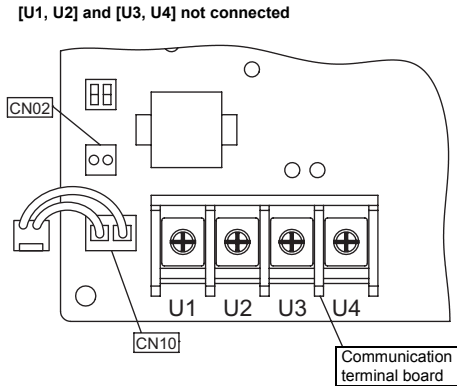

- 3** Turn on indoor units first, and then turn on outdoor units.
- 4** About 1 minute after turning the power on, confirm that the 7-segment display on the interface P.C. board of the outdoor unit indicates **U. 1. L08 (U. 1. flash)**.
- 5** Press SW 15 to start the automatic address setting.  
(It may take up to 10 minutes (normally about 5 minutes) to complete one line's setting.)
- 6** The 7-segment display indicates **Auto 1 → Auto 2 → Auto 3**.  
After the indication, **U. 1. --- (U. 1. flash)** starts flashing on the display.  
When the flashing stops and **U. 1. --- (U. 1. light)** remains lit on the display, the setting is complete.
- 7** Repeat steps 4 to 6 for other refrigerant lines.
- 8** After completing address setting of all systems, turn off dip switch 2 of SW30 on the interface P.C. boards of all the outdoor units connected to the same central control, except the unit that has the lowest address.  
(For unifying the termination of the wiring for the central control of indoor and outdoor units)

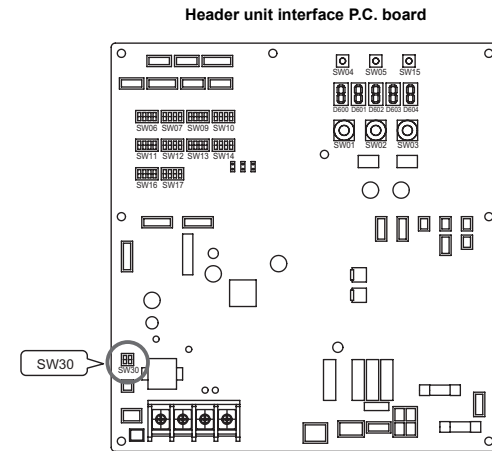

**9** Connect the relay connectors "CN10" to "CN02", which are mounted on the interface P.C. boards of all the outdoor units connected to the central control.

**NOTE**

Please make sure that before you perform this task, address setting of the refrigerant line all have been completed.

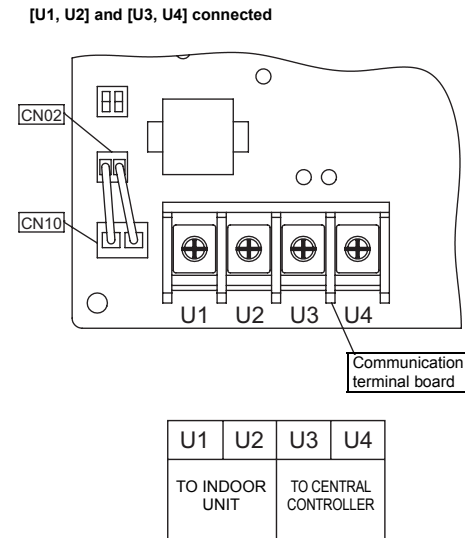

**10** Set the central control address.  
(For the setting of the central control address, refer to the installation manuals of the central control devices.)

**Switch setting (setting example when controlling 2 or more refrigerant lines centrally)**

**Outdoor units (setting manually)**

\*The items in bold font must be set manually.

Outdoor unit's interface P.C. board	Outdoor unit	Outdoor unit	Outdoor unit	Factory default
SW13, 14 (Line (system) address)	1	2	3	1
Dip switch 2 of SW30 (Terminator of indoor / outdoor communication line and central control line)	ON	<b>Set to OFF after setting addresses.</b>	<b>Set to OFF after setting addresses.</b>	ON
Relay connector	<b>Connect after setting addresses.</b>	<b>Connect after setting addresses.</b>	<b>Connect after setting addresses.</b>	Open

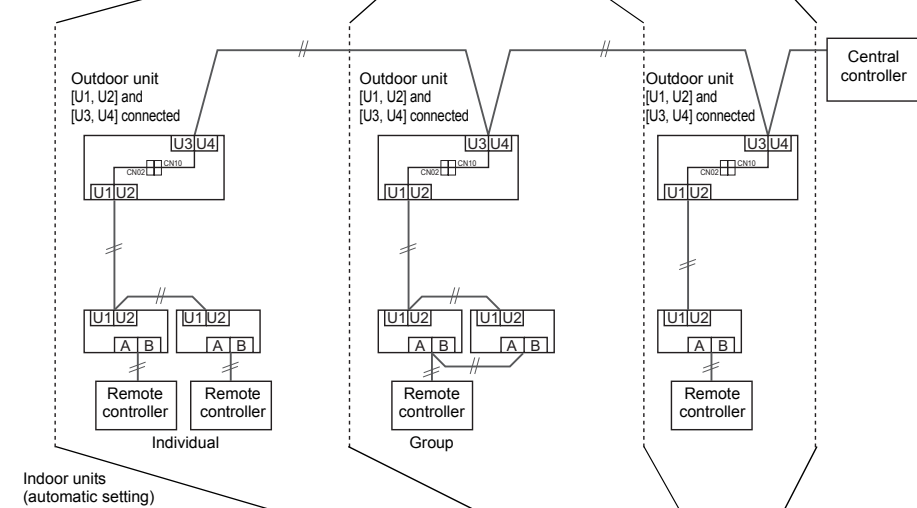

Line (system) address	1	1	2	2	3
Indoor unit address	1	2	1	2	1
Group address	0	0	1	2	0

**CAUTION**

**Relay connector connection**

Never connect relay connectors between the [U1, U2] and [U3, U4] terminals before completing address setting of all the refrigerant lines. Otherwise, the addresses cannot be set correctly.

**Manual address setting with the remote controller**

Procedure when setting indoor units' addresses first under the condition that indoor wiring has been completed and outdoor wiring has not been started (manual setting using the remote controller)

**Wiring example of 2 refrigerant lines**

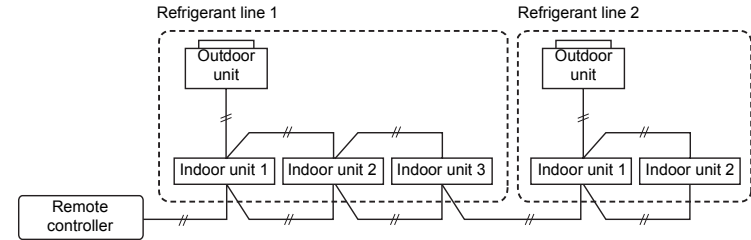

Line (system) address	1	1	1	2	2
Indoor unit address	1	2	3	1	2
Group address	Header unit	Follower unit	Follower unit	Follower unit	Follower unit

In the example above, disconnect the remote controller connections between the indoor units and connect a wired remote controller to the target unit directly before address setting.

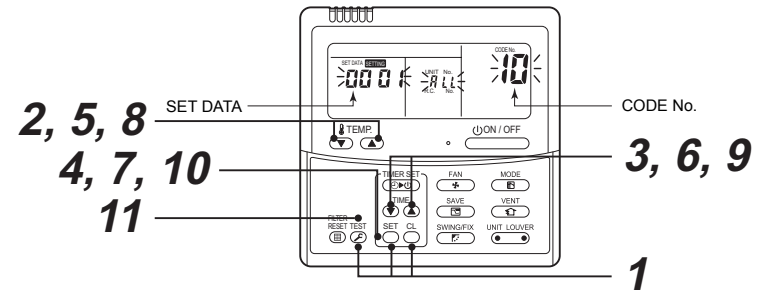

Pair the indoor unit to set and the remote controller one-to-one.

Turn on the power.

- 1 Push and hold the **SET**, **ON**, and **TEST** buttons at the same time for more than 4 seconds. LCD starts flashing.

<Line (system) address>

- 2 Push the TEMP. (▼) / (▲) buttons repeatedly to set the CODE No. to /2.
- 3 Push the TIME (▼) / (▲) buttons repeatedly to set a system address.  
(Match the address with the address on the interface P.C. board of the outdoor unit in the same refrigerant line.)
- 4 Push the SET button.  
(It is OK if the display turns on.)

<Indoor unit address>

- 5 Push the TEMP. (▼) / (▲) buttons repeatedly to set the CODE No. to /3.
- 6 Push the TIME (▼) / (▲) buttons repeatedly to set an indoor unit address.
- 7 Push the SET button.  
(It is OK if the display turns on.)

<Group address>

- 8 Push the TEMP. (▼) / (▲) buttons repeatedly to set the CODE No. to /4.
- 9 Push the TIME (▼) / (▲) buttons repeatedly to set a group address. If the indoor unit is individual, set the address to 0000 ; header unit, 0001 ; follower unit, 0002.

Individual	: 0000	} In case of group control
Header unit	: 0001	
Follower unit	: 0002	

- 10 Push the SET button.  
(It is OK if the display turns on.)
- 11 Push the TEST button.  
The address setting is complete.  
(SETTING flashes. You can control the unit after SETTING has disappeared.)

NOTE

1. Do not use address numbers 29 or 30 when setting system addresses using the remote controller. These 2 address numbers cannot be used on outdoor units and the CODE No. [E04] (Indoor / outdoor communication error) will appear if they are mistakenly used.
2. If you set addresses to indoor units in 2 or more refrigerate lines manually using the remote controller and will control them centrally, set the outdoor unit of each line as below.
  - Set a system address for the outdoor unit of each line with SW13 and 14 of their interface P.C. boards.
  - Turn off dip switch 2 of SW30 on the interface P.C. boards of all the outdoor units connected to the same central control, except the unit that has the lowest address. (For unifying the termination of the wiring for the central control of indoor and outdoor units)
  - Connect the relay connectors (CN10) between the [U1, U2] and [U3, U4] terminals on the interface P.C. board to CN02 in all the outdoor units to which the central control is connected.
  - After finishing all the settings above, set the address of the central control devices. (For the setting of the central control address, refer to the installation manuals of the central control devices.)

■ Confirming the indoor unit addresses and the position of an indoor unit using the remote controller

Confirming the numbers and positions of indoor units

To see the indoor unit address of an indoor unit which you know the position of

When the unit is individual (the indoor unit is paired with a wired remote controller one-to-one), or it is a group-controlled one.

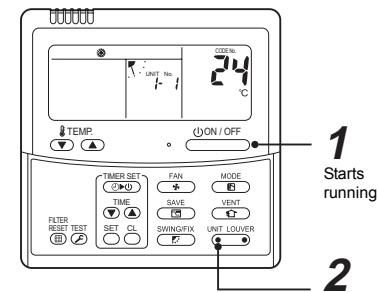

(Execute it while the units are running.)

- 1 Push the ON/OFF button if the units stop.
- 2 Push the UNIT LOUVER button (left side of the button).  
A unit numbers /- / is indicated on the LCD (it will disappear after a few seconds). The indicated number shows the system address and indoor unit address of the unit.  
When 2 or more indoor units are connected to the remote controller (group-controlled units), a number of other connected units appears each time you push the UNIT LOUVER button (left side of the button).

To find an indoor unit's position from its address

When checking unit numbers controlled as a group

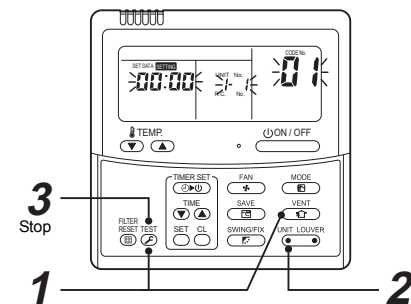

(Execute it while the units are stopped.)

The indoor unit numbers in a group are indicated one after another. The fan and louvers of the indicated units are activated.

- 1** Push and hold the and buttons at the same time for more than 4 seconds.
  - *ALL* appears on UNIT No. on the LCD display.
  - The fans and louvers of all the indoor units in the group are activated.
- 2** Push the button (left side of the button). Each time you push the button, the indoor unit numbers are indicated one after another.
  - The first-indicated unit number is the address of the header unit.
  - Only the fan and louvers of the indicated indoor unit are activated.
- 3** Push the button to finish the procedure.
  - All the indoor units in the group stop.

To check all the indoor unit addresses using an arbitrary wired remote controller.  
(When communication wirings of 2 or more refrigerant lines are interconnected for central control)

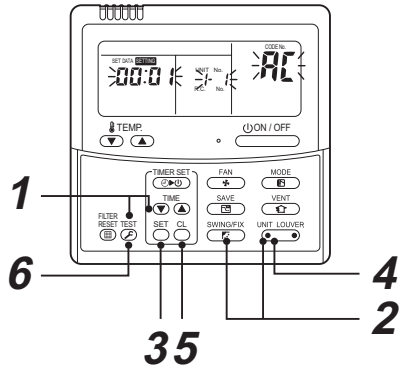

(Execute it while the units are stopped.)

You can check indoor unit addresses and positions of the indoor units in a single refrigerant line. When an outdoor unit is selected, the indoor unit numbers of the refrigerant line of the selected unit are indicated one after another and the fan and louvers of the indicated indoor units are activated.

- 1** Push and hold the and buttons at the same time for more than 4 seconds. At first, the line 1 and CODE No. *ALL* (Address Change) are indicated on the LCD display. (Select an outdoor unit.)
- 2** Push the (left side of the button) and buttons repeatedly to select a system address.
- 3** Push the button to confirm the system address selection.
  - The address of an indoor unit connected to the selected refrigerant line is indicated on the LCD display and its fan and louvers are activated.
- 4** Push the button (left side of the button). Each time you push the button, the indoor unit numbers of the selected refrigerant line are indicated one after another.
  - Only the fan and louvers of the indicated indoor unit are activated.

▼ To select another system address

- 5** Push the button to return to step 2.
  - After returning to step 2, select another system address and check the indoor unit addresses of the line.
- 6** Push the button to finish the procedure.

### ■ Changing the indoor unit address using a remote controller

To change an indoor unit address using a wired remote controller.

The method to change the address of an individual indoor unit (the indoor unit is paired with a wired remote controller one-to-one), or an indoor unit in a group. (The method is available when the addresses have already been set automatically.)

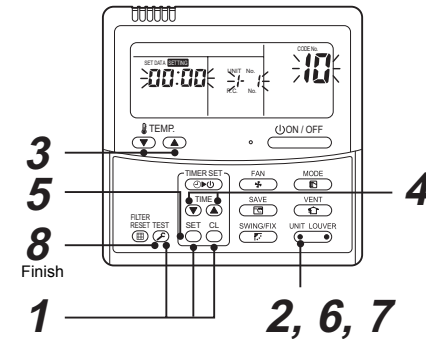

(Execute it while the units are stopped.)

- 1** Push and hold the , , and buttons at the same time for more than 4 seconds. (If 2 or more indoor units are controlled in a group, the first indicated UNIT No. is that of the head unit.)
- 2** Push the button repeatedly to select an indoor unit number to change if 2 or more units are controlled in a group. (The fan and louvers of the selected indoor unit are activated.) (The fan of the selected indoor unit is turned on.)
- 3** Push the buttons repeatedly to select *13* for CODE No.
- 4** Push the buttons repeatedly to change the value indicated in the SET DATA section to that you want.
- 5** Push the button.
- 6** Push the button repeatedly to select another indoor UNIT No. to change. Repeat steps 4 to 6 to change the indoor unit addresses so as to make each of them unique.
- 7** Push the button to check the changed addresses.
- 8** If the addresses have been changed correctly, push the button to finish the procedure.

To change all the indoor unit addresses using an arbitrary wired remote controller.  
(The method is available when the addresses have already been set automatically.)

(When communication wirings of 2 or more refrigerant lines are interconnected for central control)

**NOTE**

You can change the addresses of indoor units in each refrigerant line using an arbitrary wired remote controller.

\* Enter the address check / change mode and change the addresses.

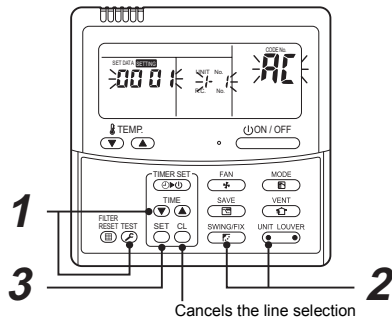

If no number appears on UNIT No., no outdoor unit exists on the line. Push button and select another line following step 2.

(Execute it while the units are stopped.)

- 1** Push and hold the TIME and buttons at the same time for more than 4 seconds.  
At first, the line 1 and CODE No. **AC** (Address Change) are indicated on the LCD display.
- 2** Push (left side of the button) and buttons repeatedly to select a system address.
- 3** Push the button.
  - The address of one of the indoor units connected to the selected refrigerant line is indicated on the LCD display and the fan and louvers of the unit are activated.
  - At first, the current indoor unit address is displayed in SET DATA.
  - (No system address is indicated.)

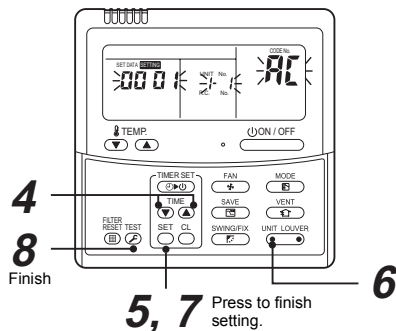

- 4** Push the TIME / buttons repeatedly to change the value of the indoor unit address in SET DATA.  
Change the value in SET DATA to that of a new address.
- 5** Push the button to confirm the new address on SET DATA.
- 6** Push the button (left side of the button) repeatedly to select another address to change.  
Each time you push the button, the indoor unit numbers in a refrigerant line are indicated one after another. Only the fan and louvers of the selected indoor unit are activated.  
Repeat steps 4 to 6 to change the indoor unit addresses so as to make each of them unique.
- 7** Push the button.  
(All the segments on the LCD display light up.)
- 8** Push the button to finish the procedure.

**Resetting the address  
(Resetting to the factory default (address undecided))**

**Method 1**

Clearing each address separately using a wired remote controller.  
Set the system address, indoor unit address and group address to "0099" using a wired remote controller.  
(For the setting procedure, refer to the address setting procedures using the wired remote controller on the previous pages.)

**Method 2**

Clearing all the indoor unit addresses on a refrigerate line at once from the outdoor unit.

- 1** Turn off the refrigerant line to reset to the factory default and set the outdoor unit of the line as below.
  - 1) Disconnect the relay connectors between the [U1, U2] and [U3, U4] terminals.  
(Leave them as they are if they have already been disconnected.)
  - 2) Turn on dip switch 2 of SW30 on the interface P.C. board of the outdoor unit if the switch is OFF.  
(Leave it as it is if it has already been set to ON.)

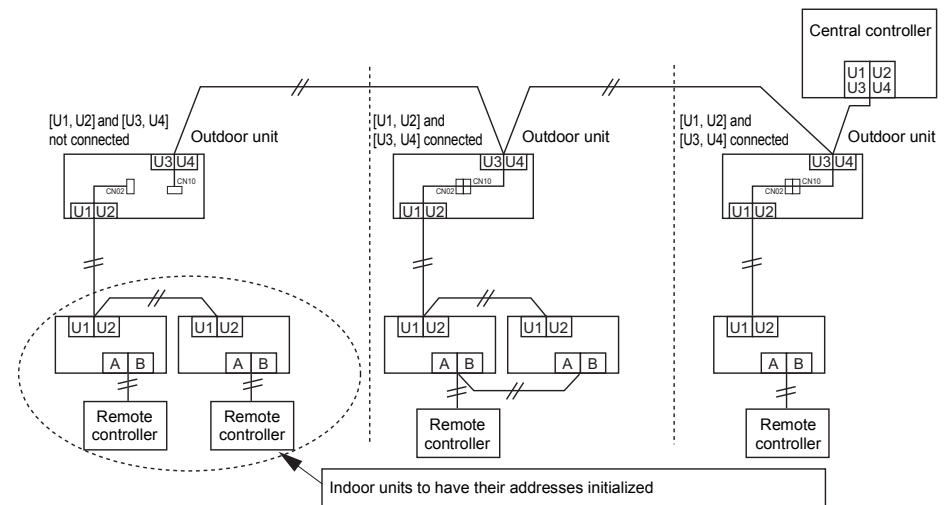

- 2** Turn on the indoor and outdoor units of the refrigerant line for which you want to initialize the addresses. About one minute after turning on the power, confirm that the 7-segment display on the outdoor unit indicates **U. 1. - - -** and operate the interface P.C. board on the outdoor unit of the refrigerant line as follows.

SW01	SW02	SW03	SW04	Clearable addresses
2	1	2	Confirm that the 7-segment display indicates <b>A.d.buS</b> and turn SW04 ON for more than five seconds.	System / indoor unit / group address
2	2	2	Confirm that the 7-segment display indicates <b>A.d.nEt</b> and turn SW04 ON for more than five seconds.	Central control address

- 3** Confirm that the 7-segment display indicates **A.d. c.L.** and set SW01, SW02 and SW03 to 1, 1, 1 respectively.
- 4** After a time **U.1.L08** appears on the 7-segment display if the address clearing has been completed successfully.  
If **A.d. n.G.** appears on the 7-segment display, the outdoor unit may still be connected to another refrigerant line. Check again the connection of the relay connectors (CN10) between the [U1, U2] and [U3, U4] terminals.

**NOTE**

Take care to carry out the procedure above correctly; otherwise, addresses in other refrigerate lines may also be cleared.

- 5** Set the addresses again after finishing the clearance.

# 8 Test Run

**■ Before test run**

Confirm that the valve of the refrigerate pipe of the outdoor unit is OPEN.

- Before turning on the power, confirm that the resistance between the terminal block of power supply and the earth is more than 1 MΩ using a 500 V megohmmeter.  
Do not run the unit if it is less than 1 MΩ.

**⚠ CAUTION**

- Turn on the power and turn on the case heater of the compressor. To save the compressor when it is activated, leave the power on for more than 12 hours.

**■ Methods of test run**

**When executing a test run using a remote controller**

Operate the system normally to check the running condition using the wired remote controller. Follow the instructions in the supplied owner's manual when operating the unit.

If you use a wireless remote controller for operations, follow the instructions in the installation manual supplied with the indoor unit.

To execute a test run forcibly under the condition that the thermostat automatically turns the unit off due to the indoor temperature, follow the procedure below.

The forcible test run will automatically stop after 60 minutes to prevent continuous forcible running and return to normal running.

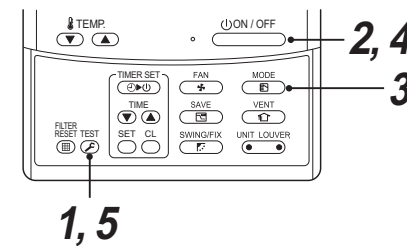

**⚠ CAUTION**

Do not use forcible running except for a test run as it overloads the unit.

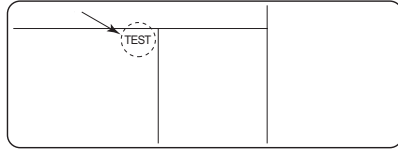

- 1 Push and hold the  button for more than 4 seconds. TEST appears on the LCD display and the unit enters the test mode.  
(TEST is indicated on the LCD display during the test run.)





- 2 Push the  button.
- 3 Push the  button to switch the running mode to COOL or HEAT.

**NOTE**

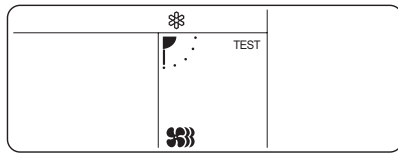
- Do not run the unit in any mode other than COOL or HEAT.
- You cannot change the temperature setting during the test run.
- Errors are detected as usual.



- 4 Push the  button to stop running after finishing the test run. The indication on the LCD display returns to the status of procedure 1.
- 5 Push the  button to exit the test mode. (TEST disappears on the LCD display and the status changes to normal stopped mode.)



**When executing a test run using the interface P.C. board on the outdoor unit**

You can execute a test run by operating switches on the interface P.C. board of the outdoor unit. "Individual test run", which tests each indoor unit separately, and "collective test run", which tests all the indoor units connected, are available.

**<Individual test run>**

**Starting operation**

- 1 Set the running mode to "COOL" or "HEAT" on the remote controller of the indoor unit to be tested. (The unit will run in the current mode unless you set the mode otherwise.)

7-segment display	
[A]	[B]
[U1]	[ ]

- 2 Set the rotary switches on the interface P.C. board of the outdoor unit: SW01 to [16], SW02 and SW03 to the address of the indoor unit to be tested.

SW02	SW03	Indoor unit address	
1 to 16	1	1 to 16	Set number of SW02
1 to 16	2	17 to 32	Set number of SW02 + 16
1 to 16	3	33 to 48	Set number of SW02 + 32
1 to 16	4	49 to 64	Set number of SW02 + 48

7-segment display	
[A]	[B]
[ ]	[ ]
↓	
Address display of the corresponding indoor unit	

- 3 Push and hold SW04 for more than 10 seconds.

7-segment display	
[A]	[B]
[ ]	[ ]
↓	↓
Address display of the corresponding indoor unit	[FF] is displayed for 5 seconds.

**NOTE**

- The running mode follows the mode setting on the remote controller of the target indoor unit.
- You cannot change the temperature setting during the test run.
- Errors are detected as usual.
- The unit does not perform test run for 3 minutes after turning the power on or stopping running.



Finishing operation

- 1 Set the rotary switches on the interface P.C. board of the outdoor unit back: SW01 to [1], SW02 to [1] and SW03 to [1].

7-segment display	
[A] [U1]	[B] [ ] ]

<Collective test run>

Start operation

- 1 Set the rotary switches on the interface P.C. board of the outdoor unit as below.  
When in "COOL" mode: SW01=[2], SW02=[5], SW03=[1].  
When in "HEAT" mode: SW01=[2], SW02=[6], SW03=[1].

7-segment display	
[A] [C ] [H ]	[B] [ ] ] [ ] ]

- 2 Push and hold SW04 for more than 2 seconds.

7-segment display	
[A] [C ] [H ]	[B] [ - C ] [ - H ]

NOTE

- You cannot change the temperature setting during the test run.
- Errors are detected as usual.
- The unit does not perform test run for 3 minutes after turning the power on or stopping running.

Stop operation

- 1 Set the rotary switches on the interface P.C. board of the outdoor unit back: SW01 to [1], SW02 to [1] and SW03 to [1].

7-segment display	
[A] [U1]	[B] [ ] ]

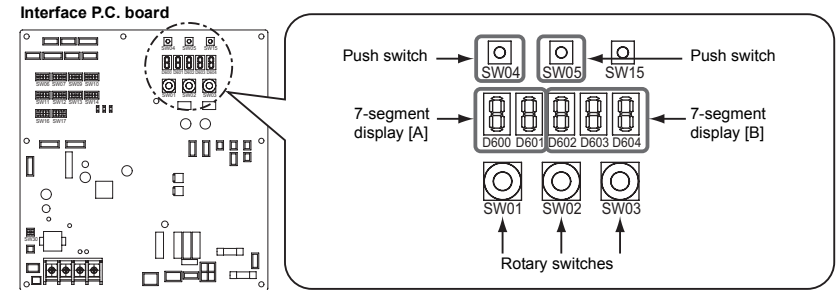

# 9 Troubleshooting

In addition to the CODE No. on the remote controller of an indoor unit, you can diagnose failure type of an outdoor unit by checking the 7-segment display on the interface P.C. board.

Use the function for various checks.

Set every dip switch to OFF after checking.

## 7-Segment display and check code

Rotary switch setting value			Indication	LED	
SW01	SW02	SW03			
1	1	1	Outdoor unit check code	A	Outdoor unit number (U1)
				B	Check code display*

\* If a check code has an auxiliary code, the display indicates the check code for three seconds and the auxiliary code for one second alternately.

### Check code (indicated on the 7-segment display on the outdoor unit)

Indicated when SW01 = [1], SW02 = [1], and SW03 = [1].

Check code		Check code name
Indication on 7-segment display on the outdoor unit		
Auxiliary code		
E06	Number of indoor units which received normally	Decrease of number of indoor units
E07	—	Indoor / Outdoor communication circuit error
E08	Duplicated indoor addresses	Duplication of indoor addresses
E15	—	No indoor unit during automatic addressing
E16	00: Capacity over 01 or more: No. of connected units	Number of connected capacity over / indoor units
E20	01: Other line outdoor connected 02: Other line indoor connected	Other line connected during automatic addressing
E31	IPDU quantity information*1	IPDU communication error
F04	—	TD sensor error
F06	—	TE sensor error
F07	—	TL sensor error
F08	—	TO sensor error
F12	—	TS sensor error
F13	—	TH sensor (Board installed) error
F15	—	Outdoor temp. sensor miswiring (TE, TL)
F16	—	Outdoor pressure sensor miswiring (Pd, Ps)
F23	—	Ps sensor error
F24	—	Pd sensor error
F31	—	Outdoor EEPROM error
H01	—	Compressor breakdown

Check code		Check code name
Indication on 7-segment display on the outdoor unit		
Auxiliary code		
H02	—	Compressor trouble (Lock)
H03	—	Current detective circuit system error
H06	—	Low-pressure protective operation
L04	—	Outdoor system address duplicated
L06	Number of indoor units with priority	Duplication of indoor units with priority
L08	—	Indoor group / Address unset
L10	—	Outdoor capacity unset
L29	IPDU quantity information *1	IPDU quantity error
L30	Detected indoor unit address	External interlock of indoor unit
P03	—	Discharge temp TD error
P04	—	High-pressure switch error
P05	*E (*: Fan motor number)	Fan motor Vdc error
	—	Compressor Vdc error
P07	—	Heat sink overheat error
P10	Detected indoor unit address	Indoor overflow error
P13	—	Outdoor liquid back detection error
P15	01: TS condition 02: TD condition	Gas leak detection
P19	—	4-way valve operation error
P20	—	High-pressure protective operation
P22	*0: Elemental device short *1: Position detective circuit error *2: Input current sensor error *3: Fan motor lock error *4: Motor current error *5: Synchronize, step out error *C: Sensor temperature error (No TH sensor) *D: Sensor short, free error (No TH sensor) (*: Fan motor number)	Outdoor fan IPDU error
P26	—	G-TR short protection error
P29	—	Compressor position detective circuit system error

\*1 IPDU number information

01: Compressor 02: Fan 1 03: Compressor and Fan 1  
04: Fan 2 05: Compressor and Fan 2 06: Fan 1 and Fan 2  
07: Compressor, Fan 1 and Fan 2 08: Fan 3 09: Compressor and Fan 3  
0A: Fan 1 and Fan 3 0B: Compressor, Fan 1 and Fan 3 0C: Fan 2 and Fan 3  
0D: Compressor, Fan 2 and Fan 3 0E: Fan 1, Fan 2 and Fan 3  
0F: Compressor, Fan 1, Fan 2 and Fan 3

## WARNINGS ON REFRIGERANT LEAKAGE

### Check of Concentration Limit

The room in which the air conditioner is to be installed requires a design that in the event of refrigerant gas leaking out, its concentration will not exceed a set limit.

The refrigerant R410A which is used in the air conditioner is safe, without the toxicity or combustibility of ammonia, and is not restricted by laws to be imposed which protect the ozone layer. However, since it contains more than air, it poses the risk of suffocation if its concentration should rise excessively. Suffocation from leakage of R410A is almost non-existent. With the recent increase in the number of high concentration buildings, however, the installation of multi air conditioner systems is on the increase because of the need for effective use of floor space, individual control, energy conservation by curtailing heat and carrying power etc.

Most importantly, the multi air conditioner system is able to replenish a large amount of refrigerant compared with conventional individual air conditioners. If a single unit of the multi conditioner system is to be installed in a small room, select a suitable model and installation procedure so that if the refrigerant accidentally leaks out, its concentration does not reach the limit (and in the event of an emergency, measures can be made before injury can occur).

In a room where the concentration may exceed the limit, create an opening with adjacent rooms, or install mechanical ventilation combined with a gas leak detection device.

The concentration is as given below.

$$\frac{\text{Total amount of refrigerant (kg)}}{\text{Min. volume of the indoor unit installed room (m}^3\text{)}} \leq \text{Concentration limit (kg/m}^3\text{)}$$

The concentration limit of R410A which is used in multi air conditioners is 0.3 kg/m<sup>3</sup>.

#### ▼ NOTE 1

If there are 2 or more refrigerating systems in a single refrigerating device, the amounts of refrigerant should be as charged in each independent device.

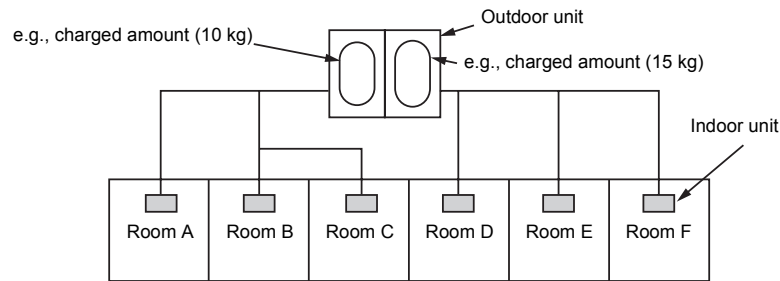

For the amount of charge in this example:

The possible amount of leaked refrigerant gas in rooms A, B and C is 10 kg.

The possible amount of leaked refrigerant gas in rooms D, E and F is 15 kg.

### Important

#### ▼ NOTE 2

The standards for minimum room volume are as follows.

(1) No partition (shaded portion)

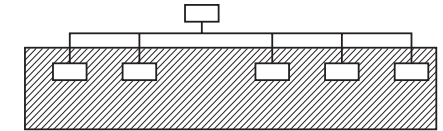

(2) When there is an effective opening with the adjacent room for ventilation of leaking refrigerant gas (opening without a door, or an opening 0.15% or larger than the respective floor spaces at the top or bottom of the door).

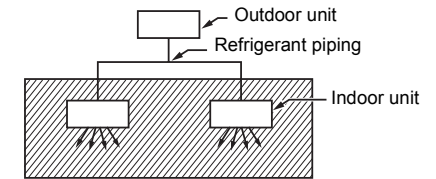

(3) If an indoor unit is installed in each partitioned room and the refrigerant piping is interconnected, the smallest room of course becomes the object. But when a mechanical ventilation is installed interlocked with a gas leakage detector in the smallest room where the density limit is exceeded, the volume of the next smallest room becomes the object.

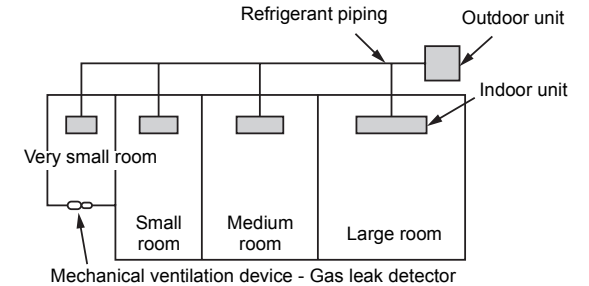

#### ▼ NOTE 3

The minimum indoor floor area compared with the amount of refrigerant is roughly as follows: (When the ceiling is 2.7m high)

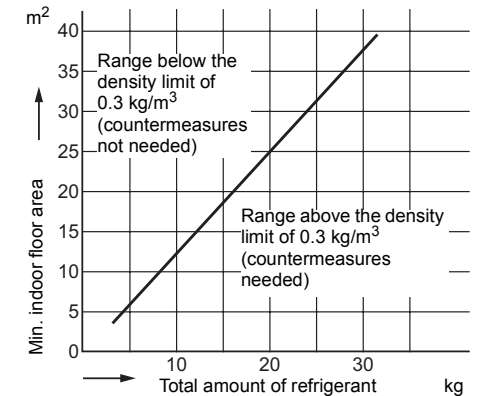

**Toshiba Carrier Air Conditioning (China) Co., Ltd.**

**DB11207501-00**