

# TOSHIBA

Leading Innovation >>>

AIR CONDITIONER (MULTI TYPE)

## Owner's Manual



For commercial use

### Indoor Unit

Model name:

---

High-Wall Type

**MMK-AP0054MHP-E**

**MMK-AP0074MH-E**

**MMK-AP0094MH-E**

**MMK-AP0124MH-E**

**MMK-AP0054MHP-E1**

**MMK-AP0074MHP-E1**

**MMK-AP0094MHP-E1**

**MMK-AP0124MHP-E1**

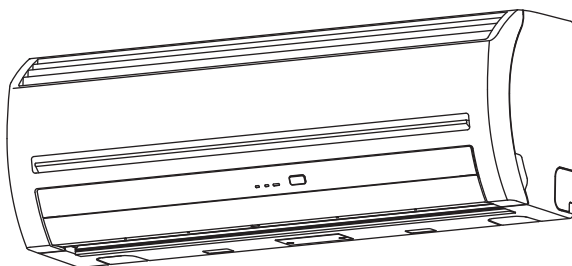

Thank you very much for purchasing TOSHIBA Air Conditioner.

Please read this owner's manual carefully before using your Air Conditioner.

- Be sure to obtain the "Owner's manual" and "Installation manual" from constructor (or dealer).  
Request to constructor or dealer
- Please clearly explain the contents of the Owner's manual and hand over it.

## NOTE

This manual describes operations of the indoor unit and the wireless remote controller.

For details of the wired remote controller and the outdoor unit, refer to the Owner's manual supplied with the outdoor unit. (Keep these manuals carefully.)

## ADOPTION OF NEW REFRIGERANT

This Air Conditioner is a new type which adopts a new refrigerant HFC (R410A) instead of the conventional refrigerant R22 in order to prevent destruction of the ozone layer.

This appliance is not intended for use by person (including children) with reduced physical, sensory or mental capabilities, or lack of experience and knowledge, unless they have been given supervision or instruction concerning use of the appliance by a person responsible for their safety.

## Contents

<b>1</b>	<b>Precautions for Safety</b> .....	<b>4</b>
<b>2</b>	<b>Accessory Parts</b> .....	<b>9</b>
<b>3</b>	<b>Parts Name</b> .....	<b>9</b>
<b>4</b>	<b>Parts Name of Remote Controller</b> .....	<b>11</b>
<b>5</b>	<b>Adjusting Clock</b> .....	<b>14</b>
<b>6</b>	<b>Limited Operation by Group Control</b> .....	<b>15</b>
<b>7</b>	<b>Handling the Remote Controller</b> .....	<b>16</b>
<b>8</b>	<b>How to Use Remote Controller</b> .....	<b>17</b>
<b>9</b>	<b>Hints for Economical Operation</b> .....	<b>25</b>
<b>10</b>	<b>Temporary Operation</b> .....	<b>26</b>
<b>11</b>	<b>How the Air Conditioner Works</b> .....	<b>27</b>
<b>12</b>	<b>Maintenance</b> .....	<b>28</b>
<b>13</b>	<b>Troubles and Causes</b> .....	<b>31</b>
<b>14</b>	<b>Specifications</b> .....	<b>33</b>

Please read carefully through these instructions that contain important information which complies with the "Machinery" Directive (Directive 2006/42/EC), and ensure that you understand them.

### Generic Denomination: Air Conditioner







#### Definition of Qualified Installer or Qualified Service Person

The air conditioner must be installed, maintained, repaired and removed by a qualified installer or qualified service person. When any of these jobs is to be done, ask a qualified installer or qualified service person to do them for you.

A qualified installer or qualified service person is an agent who has the qualifications and knowledge described in the table below.

Agent	Qualifications and knowledge which the agent must have
<ul style="list-style-type: none"> <li>• Qualified installer</li> </ul>	<ul style="list-style-type: none"> <li>• The qualified installer is a person who installs, maintains, relocates and removes the air conditioners made by Toshiba Carrier Corporation. He or she has been trained to install, maintain, relocate and remove the air conditioners made by Toshiba Carrier Corporation or, alternatively, he or she has been instructed in such operations by an individual or individuals who have been trained and is thus thoroughly acquainted with the knowledge related to these operations.</li> <li>• The qualified installer who is allowed to do the electrical work involved in installation, relocation and removal has the qualifications pertaining to this electrical work as stipulated by the local laws and regulations, and he or she is a person who has been trained in matters relating to electrical work on the air conditioners made by Toshiba Carrier Corporation or, alternatively, he or she has been instructed in such matters by an individual or individuals who have been trained and is thus thoroughly acquainted with the knowledge related to this work.</li> <li>• The qualified installer who is allowed to do the refrigerant handling and piping work involved in installation, relocation and removal has the qualifications pertaining to this refrigerant handling and piping work as stipulated by the local laws and regulations, and he or she is a person who has been trained in matters relating to refrigerant handling and piping work on the air conditioners made by Toshiba Carrier Corporation or, alternatively, he or she has been instructed in such matters by an individual or individuals who have been trained and is thus thoroughly acquainted with the knowledge related to this work.</li> <li>• The qualified installer who is allowed to work at heights has been trained in matters relating to working at heights with the air conditioners made by Toshiba Carrier Corporation or, alternatively, he or she has been instructed in such matters by an individual or individuals who have been trained and is thus thoroughly acquainted with the knowledge related to this work.</li> </ul>
<ul style="list-style-type: none"> <li>• Qualified service person</li> </ul>	<ul style="list-style-type: none"> <li>• The qualified service person is a person who installs, repairs, maintains, relocates and removes the air conditioners made by Toshiba Carrier Corporation. He or she has been trained to install, repair, maintain, relocate and remove the air conditioners made by Toshiba Carrier Corporation or, alternatively, he or she has been instructed in such operations by an individual or individuals who have been trained and is thus thoroughly acquainted with the knowledge related to these operations.</li> <li>• The qualified service person who is allowed to do the electrical work involved in installation, repair, relocation and removal has the qualifications pertaining to this electrical work as stipulated by the local laws and regulations, and he or she is a person who has been trained in matters relating to electrical work on the air conditioners made by Toshiba Carrier Corporation or, alternatively, he or she has been instructed in such matters by an individual or individuals who have been trained and is thus thoroughly acquainted with the knowledge related to this work.</li> <li>• The qualified service person who is allowed to do the refrigerant handling and piping work involved in installation, repair, relocation and removal has the qualifications pertaining to this refrigerant handling and piping work as stipulated by the local laws and regulations, and he or she is a person who has been trained in matters relating to refrigerant handling and piping work on the air conditioners made by Toshiba Carrier Corporation or, alternatively, he or she has been instructed in such matters by an individual or individuals who have been trained and is thus thoroughly acquainted with the knowledge related to this work.</li> <li>• The qualified service person who is allowed to work at heights has been trained in matters relating to working at heights with the air conditioners made by Toshiba Carrier Corporation or, alternatively, he or she has been instructed in such matters by an individual or individuals who have been trained and is thus thoroughly acquainted with the knowledge related to this work.</li> </ul>

## ■ Warning indications on the air conditioner unit

Warning indication		Description
	<b>WARNING</b>	<b>WARNING</b>  <b>ELECTRICAL SHOCK HAZARD</b> Disconnect all remote electric power supplies before servicing.
	<b>ELECTRICAL SHOCK HAZARD</b> Disconnect all remote electric power supplies before servicing.	
	<b>WARNING</b>	<b>WARNING</b>  Moving parts. Do not operate unit with grille removed. Stop the unit before the servicing.
	Moving parts. Do not operate unit with grille removed. Stop the unit before the servicing.	
	<b>CAUTION</b>	<b>CAUTION</b>  High temperature parts. You might get burned when removing this panel.
	High temperature parts. You might get burned when removing this panel.	
	<b>CAUTION</b>	<b>CAUTION</b>  Do not touch the aluminum fins of the unit. Doing so may result in injury.
	Do not touch the aluminum fins of the unit. Doing so may result in injury.	
	<b>CAUTION</b>	<b>CAUTION</b>  <b>BURST HAZARD</b> Open the service valves before the operation, otherwise there might be the burst.
	<b>BURST HAZARD</b> Open the service valves before the operation, otherwise there might be the burst.	
	<b>CAUTION</b>	<b>CAUTION</b>  <b>Do not climb onto the fan guard.</b> Doing so may result in injury.
	<b>Do not climb onto the fan guard.</b> Doing so may result in injury.	

# 1. Precautions for Safety

## WARNING

### General

- Carefully read Owner's Manual before starting the air conditioner. There are many important things to keep in mind for daily operation.
- Ask for installation to be performed by the dealer or a professional. Only a qualified installer (\*1) is able to install an air conditioner. If a non-qualified person installs an air conditioner, it may result in problems such as fire, electric shock, injury, water leakage, noise and vibration.
- Places where the operation sound of the outdoor unit may cause a disturbance. (Especially at the boundary line with a neighbour, install the air conditioner while considering the noise.)

### Transportation and storage

- To transport the air conditioner, wear shoes with protective toe caps, protective gloves, and other protective clothing.
- To transport the air conditioner, do not take hold of the bands around the packing carton. You may injure yourself if the bands should break.
- Before stacking the packing cartons for storage or transportation, heed the precautions written on the packing cartons. Failure to heed the precautions may cause the stack to collapse.
- The air conditioner must be transported in stable condition. If any part of the product broken, contact your dealer.

### Installation

- Only a qualified installer(\*1) or qualified service person(\*1) is allowed to carry out the electrical work of the air conditioner. Under no circumstances must this work be done by an unqualified individual since failure to carry out the work properly may result in electric shocks and / or electrical leaks.
- After the installation work has been completed, have the installer explain about the circuit breaker positions. In the event that trouble has occurred in the air conditioner, set the circuit breaker to the OFF position, and contact a service person.
- If the unit is installed in a small room, take appropriate measures to prevent the refrigerant from exceeding the limit concentration even if it leaks. Consult the dealer from whom you purchased the air conditioner when you implement the measures. Accumulation of highly concentrated refrigerant may cause an oxygen deficiency accident.
- Do not install the air conditioner in a location that may be subject to a risk of expire to a combustible gas. If a combustible gas leaks and becomes concentrated around the unit, a fire may occur.
- Use the company-specified products for the separately purchased parts. Use of non-specified products may result in fire, electric shock, water leakage or other trouble. Have the installation performed by a professional.
- Confirm that earthing is performed correctly.

## Operation

- Before opening the intake grille of the indoor unit or service panel of the outdoor unit, set the circuit breaker to the OFF position. Failure to set the circuit breaker to the OFF position may result in electric shocks through contact with the interior parts. Only a qualified installer(\*1) or qualified service person(\*1) is allowed to remove the intake grille of the indoor unit or service panel of the outdoor unit and do the work required.
- Inside the air conditioner are high-voltage areas and rotating parts. Due to the danger of electric shocks or of your fingers or physical objects becoming trapped in the rotating parts, do not remove the intake grille of the indoor unit or service panel of the outdoor unit. When work involving the removal of these parts is required, contact a qualified installer or a qualified service person.
- Do not move or repair any unit by yourself. Since there is high voltage inside the unit, you may get electric shock when removing the cover and main unit.
- Use of a stand more than 50 cm high to clean the filter of the indoor unit or to carry out other such jobs constitutes working at heights. Due to the danger of falling off the stand and injuring yourself while working at heights, this kind of work should not be done by unqualified individuals. When this kind of work must be carried out, do not do it yourself but ask a qualified installer or a qualified service person to do it for you.
- Do not touch the aluminum fin of the outdoor unit. You may injure yourself if you do so. If the fin must be touched, do not touch it yourself but contact a qualified installer or a qualified service person.
- Do not climb onto or place objects on top of the outdoor unit. You may fall or the objects may fall off of the outdoor unit and result in injury.
- Do not place any combustion appliance in a place where it is directly exposed to the wind of air conditioner, otherwise it may cause imperfect combustion.
- When the air conditioner is operated with a combustion appliance in the same place, be careful of ventilation to let fresh air enter the room. Poor ventilation causes oxygen shortage.
- When the air conditioner is used in a closed room, be careful of sufficient ventilation of the room. Poor ventilation causes oxygen shortage.
- Do not expose your body to cool air directly for a long time and do not cool yourself excessively. Doing so may result in deteriorated physical condition and ill health.
- Do not insert your finger or a stick into the air intake or discharge. Doing so may result injury as the fan is rotating at high speed inside the unit.
- Consult the shop where you purchased the air conditioner if air conditioning (cooling and heating) is not performed properly as a refrigerant leakage may be the cause. Confirm the repair details with a qualified service person(\*1) when the repair includes additional charging of the refrigerant.
- Stop running the air conditioner and turn off the breaker before cleaning. Otherwise, injury may result as the fan is rotating at high speed inside the unit.

**Repairs**

- If there is any kind of trouble (such as when an error display has appeared, there is a smell of burning, abnormal sounds are heard, the air conditioner fails to cool or heat or water is leaking) has occurred in the air conditioner, do not touch the air conditioner yourself but set the circuit breaker to the OFF position, and contact a qualified service person. Take steps to ensure that the power will not be turned on (by marking "out of service" near the circuit breaker, for instance) until qualified service person arrives. Continuing to use the air conditioner in the trouble status may cause mechanical problems to escalate or result in electric shocks or other trouble.
- If the fan grille is damaged, do not approach the outdoor unit but set the circuit breaker to the OFF position, and contact a qualified service person to have the repairs done. Do not set the circuit breaker to the ON position until the repairs are completed.
- If there is a danger of the indoor unit's falling, do not approach the indoor unit but set the circuit breaker to the OFF position, and contact a qualified installer or a qualified service person to refit the unit. Do not set the circuit breaker to the ON position until the unit has been refitted.
- If there is a danger of the outdoor unit's toppling over, do not approach the outdoor unit but set the circuit breaker to the OFF position, and contact a qualified installer or a qualified service person to have the improvements or refitting done. Do not set the circuit breaker to the ON position until the improvements or refitting is completed.
- Do not customize the unit. Doing so may result in fire, electric shock or other trouble.

**Relocation**

- When the air conditioner is to be relocated, do not relocate it yourself but contact a qualified installer or a qualified service person. Failure to relocate the air conditioner properly may result in electric shocks and / or a fire.
-

 **CAUTION****To disconnect the appliance from the main supply.**

- This appliance must be connected to the mains by means of a switch with a contact separation of at least 3 mm.

**The installation fuse (all types can be used) must be used for the power supply line of this air conditioner.****Installation**

- Certainly lay the drain hose for perfect draining. Bad drainage may cause flooding in the house and getting furniture wet.
- Connect the air conditioner to an exclusive power supply of the rated voltage, otherwise the unit may break down or cause a fire.
- Confirm that the outdoor unit are fixed on the base. Otherwise, falling down of the units or other accidents may occur.

**Operation**

- Do not use this air conditioner for special purpose such as preserving food, precision instruments, art objects, breeding animals, car, vessel.
- Do not touch any switches with wet finger, otherwise you may get an electric shock.
- If the air conditioner will not be used for a considerably long time, turn off the main switch or the circuit breaker, for safety.
- To make the air conditioner operate in its original performance, operate it within the range of the operating temperature specified in the instructions. Otherwise it may cause a malfunction, or water leak from the unit.
- Prevent any liquid from falling into the remote controller. Do not spill juice, water or any kind of liquid.
- Do not wash the air conditioner. Doing so may result in electric shock.
- Check whether the installation base and other equipment have become deteriorated after being used for a long time. Leaving them such condition may result in the unit's falling down and causing injury.
- Do not leave flammable sprays or other flammable materials near the air conditioner, and do not spray flammable aerosol directly to the air conditioner. They may catch fire.
- Stop running the air conditioner and turn off the breaker before cleaning. Otherwise, injury may result as the fan is rotating at high speed inside the unit.
- Ask for cleaning of the air conditioner to be performed by the dealer. Cleaning the air conditioner in an improper manner may cause damage to plastic parts, insulation failure of electric parts and result in a malfunction. In the worst case, it may result in water leakage, electric shock, smoke emission and fire.
- Do not put a water container such as a vase on the unit. Water intrusion into the unit may occur and it may cause deterioration of electric insulation and result in electric shock.









---

(\*1) Refer to the "Definition of Qualified Installer or Qualified Service Person."

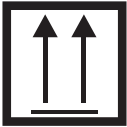

■ Information on the transportation, handling and storage of the carton

Examples of indication on the carton

Symbol	Description	Symbol	Description
	Keep dry	 DO NOT DROP	Do not drop
 <b>FRAGILE</b>	Fragile	 DO NOT LAY DOWN	Do not lay down
 11 cartons	Stacking height (12 cartons can be stacked in this case)	 DO NOT WALK ON THIS CARTON	Do not walk on this carton
	This side up		Do not step
	Handle with care		

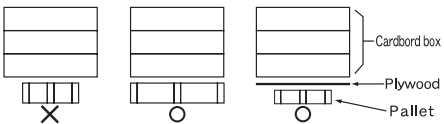
Other cautions	Description
 <div style="border: 1px solid black; padding: 5px; margin-top: 5px;"> <p><b>Caution</b></p> <p>Injury possibility. Don't handle with packing band, or may get injured in case of broken band.</p> </div>	<p><b>CAUTION</b></p> <p>Injury possibility. Don't handle with packing band, or may get injured in case of broken band.</p>
<p style="text-align: center;"><b>Stacking notice.</b></p> <p>In case that cardboard boxes protrude out of pallet when stacking, lay a 10mm thick plywood over the pallet.</p> 	<p><b>Stacking notice.</b></p> <p>In case that cardboard boxes protrude out of pallet when stacking, lay a 10 mm thick plywood over the pallet.</p>

## 2. Accessory Parts

### Remote controller

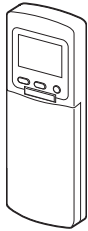

### Remote controller holder

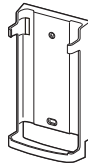

### Batteries (two) (R03 [AAA])

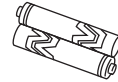

## 3. Parts Name

### ■ Indoor unit

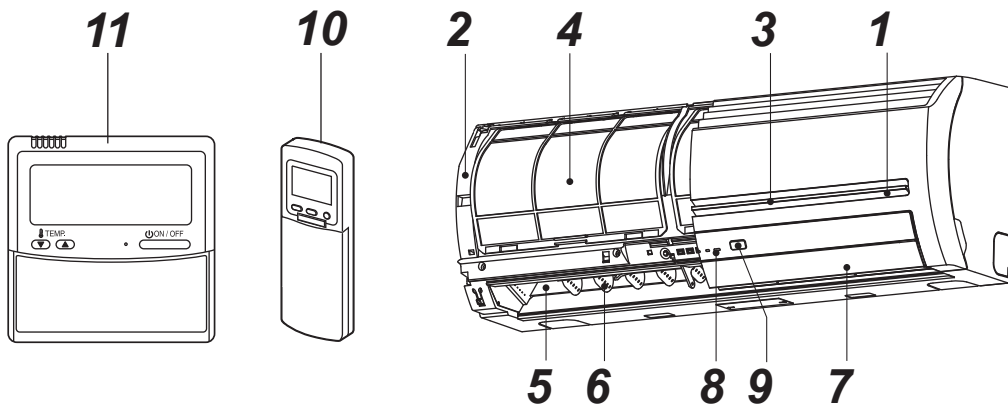

- 1** Room temperature sensor
- 2** Front panel
- 3** Air intake grille
- 4** Air filter
- 5** Air discharge

- 6** Horizontal airflow louver
- 7** Vertical airflow louver
- 8** Display panel
- 9** Infrared signal receiver
- 10** Remote controller (wireless)
- 11** Remote controller (wired, sold separately)

## ■ Names and functions of indicators and controls on indoor unit

### Display panel

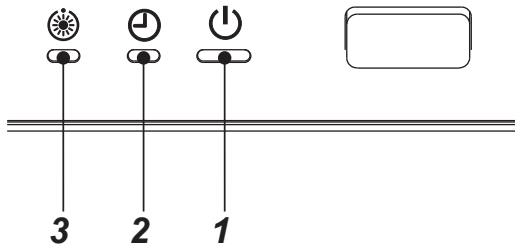

The operating conditions are indicated below.

#### 1 OPERATION (Green)

This lamp goes on during operation.

#### 2 TIMER (Green)

This lamp goes on while the timer is reserved.

#### NOTE

When timer is set by wired remote controller, TIMER lamp does not light.

During group control, TIMER lamp goes on header unit only. (see "6. Limited Operation by Group Control")

#### 3 Preheat / Defrost (Orange)

This lamp lights up when the power is turned on or right after heating operation starts or during defrost operation.

### ⚠ CAUTION

#### • Disagreement in operation mode

If AUTOMATIC OPERATION is selected in a model (except Super Heat Recovery Multi) with no auto-changeover control setting or if you select HEAT in a Cooling Only model, an alarm sound (pi, pi) from the air conditioner due to disagreement in operation mode. Change the operation mode with the MODE button on the wireless remote controller. This disagreement indication cannot be deleted by the wired remote controller.

- When local prohibition is set by the central control from other equipment, no signal is received even if the remote controller button is pushed. However, a signal of START / STOP button is accepted. (An alarm sound "pi" arises intermittently five times.)

#### 4 TEMPORARY operation

If the wireless remote controller is misplaced or lost or its batteries are exhausted, push the TEMPORARY button.

- Push the TEMPORARY button to start the air conditioner.  
Push this button once again to stop it.

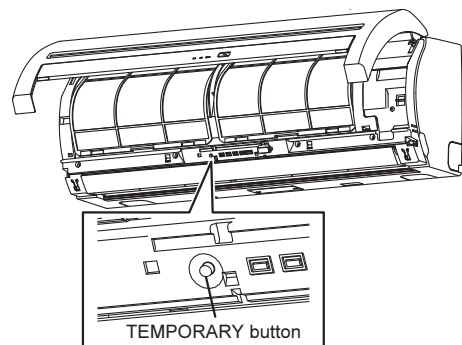

## 4. Parts Name of Remote Controller

### ■ Wireless remote controller and its functions

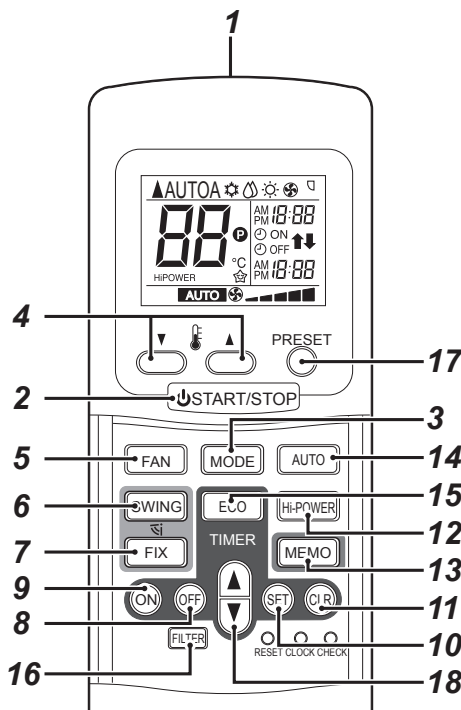

#### 1 Infrared signal emitter

Transmits a signal to the indoor unit.

#### 2 START / STOP button

Push the button to start operation.

(A receiving beep is heard.)

Push the button again to stop operation.

(A receiving beep is heard.)

If no receiving sound is heard from the indoor unit, push the button twice.

#### 3 Mode select button (MODE)

Push this button to select a mode.

Each time the button is pushed, a mode is selected in a sequence that goes from A : Auto changeover control, : Cool, : Dry, : Heat, : Fan only, and back to A. (A receiving beep is heard.)

#### 4 Temperature button (▲ ▼)

▲..... The set temperature is increased up to 30 °C.

▼..... The set temperature is dropped down to 17 °C. (A receiving beep is heard.)

#### 5 Fan speed button (FAN)

Push this button to select fan speed. When AUTO is selected, the fan speed is automatically adjusted according to the room temperature.

A desired fan speed can also be selected manually from among five settings.

(LOW , LOW<sup>+</sup> , MED , MED<sup>+</sup> , HIGH )  
(A receiving beep is heard.)

#### 6 Auto louver button (SWING)

Push this button to swing the louver.

(A receiving beep is heard.)

Push the SWING button to stop the louver swinging.

(A receiving beep is heard.)

#### 7 Set louver button (FIX)

Push this button to adjust the air flow direction.

(A receiving beep is heard.) While this button is kept depressed, the receiving tone continuously sounds.

#### 8 Off timer button (OFF)

Push this button to set the OFF timer.

#### 9 On timer button (ON)

Push this button to set the ON timer.

#### 10 Reserve button (SET)

Push this button to reserve time settings.

(A receiving beep is heard.)

#### 11 Cancel button (CLR)

Push this button to cancel ON timer and OFF timer.

(A receiving beep is heard.)

#### 12 High power button (Hi POWER)

This function is not operated group control.

Push this button to start the high power operation.

#### 13 Memory button (MEMO)

Push this button to stand by memorizing the settings.

Push the button again for more than 3 seconds to memorize the setting indicated on the remote control and mark is indicated.

#### 14 Automatic operation button (AUTO)

Push this button to operate the air conditioner automatically. (A receiving beep is heard.)

#### 15 ECO timer button (ECO)

This function is not operated group control.

Push this button to start the ECO timer (OFF timer) operation.

The OFF timer time can be selected from among four settings (1, 3, 5 or 9 hours).

#### 16 FILTER button

This function is not used this unit.

#### 17 PRESET button

Push this button to operate the air conditioner according to settings memorized by the MEMO button.

#### 18 TIMER button

Use this button to change the clock, ON timer, and OFF timer times.

To forward the time, push the "TIMER

To set back the time, push the "TIMER

## ■ Names and functions of indications on wireless remote controller

### Display

All indications, except for clock time indication, are indicated by pushing the START / STOP button.

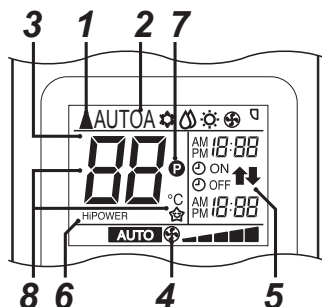

- In the illustration, all indications are indicated for explanation. During operation, only the relevant indications will be indicated on the remote controller.

### 1 Transmission mark

This transmission mark (▲) indicates when the remote control transmits signals to the indoor unit.

### 2 Mode display

Indicates the current operation mode.

(AUTO: Automatic control, A: Auto changeover control, ☼ : Cool, ☹ : Dry, ☀ : Heat, ☼ : Fan only)

### 3 Temperature display

Indicates the temperature setting (17 °C to 30 °C).

When the operation mode is set to ☼ : Fan only, no temperature setting is indicated.

### 4 FAN speed display

Indicates the selected fan speed. AUTO or one of five fan speed levels (LOW, LOW<sup>+</sup>, MED, MED<sup>+</sup>, HIGH) can be indicated.

Indicates **AUTO** when the operation mode is ☹ : Dry.

### 5 TIMER and clock time display

The time set for timer operation or clock time is indicated.

The present time is always indicated except for TIMER operation.

### 6 Hi POWER display

Indicates when the Hi POWER operation starts.

Push the Hi-POWER button to start and push it again to stop the operation.

### 7 (P) (MEMORY) display

Flashes for 3 seconds when the MEMO button is pushed during operation.

(P) mark is indicated when the button is not pushed for more than 3 seconds while the mark is flashing. Push another button to turn off the mark.

### 8 ECO TIMER display

Indicates when the ECO TIMER is in operation.

Each time the ECO button is pushed, the display changes in the sequence of 1, 3, 5 or 9 h.

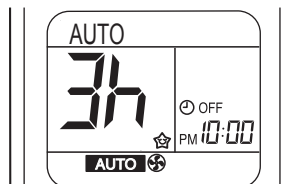

### NOTE

When both wired remote controller and wireless remote controller are used, display on the screen of wireless remote controller may differ from the actual operation in some cases.

## ■ Preparation and check before use

### Loading Batteries

- 1 Remove the cover, and insert 2 new batteries (R03 [AAA]).

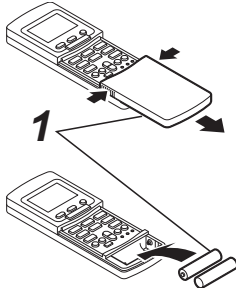

- 2 Push the RESET button.

The clock display flashes.

Adjust the clock. Place back the cover.

- Slide off the cover while pushing the sides.

- **Battery replacement**

Be careful not to reverse the (+) position and the (-) position.

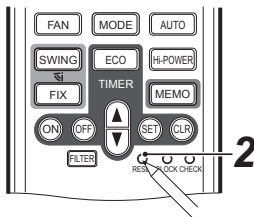

### Batteries

- To replace the batteries, use two new batteries (R03 [AAA]).
- In normal use, the batteries will last about one year.
- Replace the batteries if there is no receiving beep from the indoor unit or when the air conditioner cannot be operated using the remote controller.
- To avoid malfunctions by battery leakage, remove the batteries when the remote controller will not be used for more than one month.

## 5. Adjusting Clock

### Setting the clock

Before you start operating the air conditioner, set the clock of the remote controller using the procedures given in this section. The clock panel on the remote controller will indicate the time regardless of whether the air conditioner is in use or not.

### Initial setting

When batteries are inserted in the remote controller the clock panel will indicate AM 0:00 and will flash.

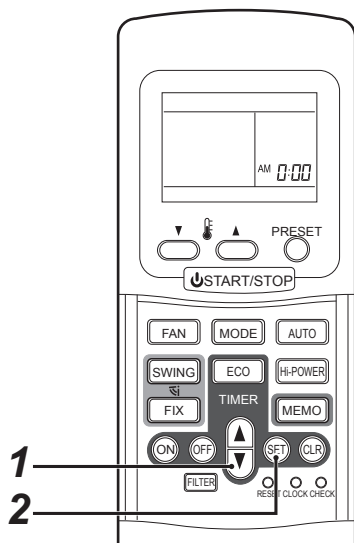

#### 1 TIMER button

Push the TIMER  button to set the current time.  
Each push of the TIMER button changes the time in one minute steps.  
Pushing the TIMER button continually changes the time in ten minute steps.

#### 2 SET button

Push the SET  button.  
The current time is indicated and the clock starts.

### ■ Clock adjusting

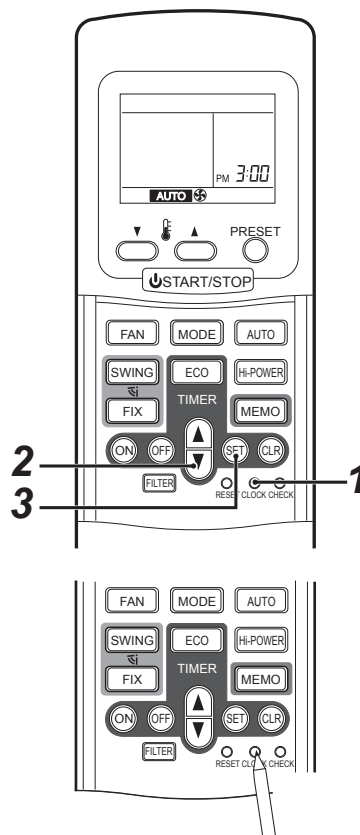

#### 1 CLOCK button

Push the CLOCK button.  
The CLOCK display flashes.

#### 2 TIMER button

Push the TIMER  button to set the current time.  
Each push of the TIMER button changes the time by one minute.  
Pushing the TIMER button continually changes the time by ten minutes.

#### 3 SET button

Push the SET  button.  
The current time is indicated and the clock starts.

## 6. Limited Operation by Group Control

### NOTE

Group control: Operate air conditioners in more than one system in same time.

Header indoor unit: The representative unit during group control. Receive commands from wired remote controller and transmit the commands to follower units.

(Header indoor unit is indoor unit that receives START / STOP signal from the wireless remote controller.)

Follower indoor unit: Indoor units other than the Header unit are called follower unit.

A wired remote controller (separately available) is required for the group control.

### ▼ Example of group combination

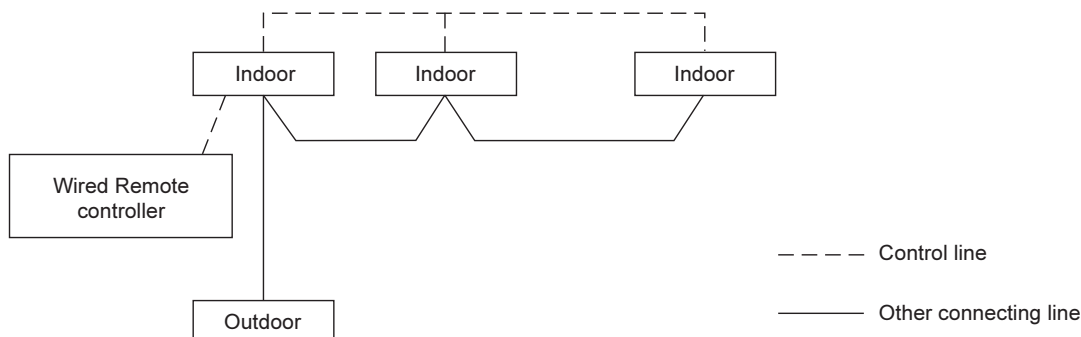

### ⚠ CAUTION

When indoor unit is used in group control.

#### 1. ECO-Timer and Hi POWER operation will not function.

When Hi POWER or ECO is transmitted from wireless remote control, the receiving sound will be heard from the indoor unit and display on the remote control will also change. (see page 27.) However, the indoor unit does not operate ECO-Timer or Hi POWER. (When ECO-Timer is transmitted, ordinary OFF-TIMER operation is performed.) Restore the display on the remote control pushing Hi POWER or ECO-Timer button.

#### 2. Units other than the Header unit cannot be operated with remote control and the TEMPORARY button.

When the air conditioner is operated with wireless remote control, transmission should be sent to the Header unit.

Header and follower indoor units are decided through address setting upon installation. Follower unit will not receive any signals from remote control.

Air conditioner will not work even if the TEMPORARY button on the follower unit is pushed.

(Some Follower units may receive SWING and FIX, but these operations are performed only on the unit that received the signal.)

(When wireless remote control is used, only the Header unit receives SWING signal. If the SWING signal is transmitted to follower unit, the sound to refuse receiving signal (3 beeps) is heard and the follower unit does not receive the signal.)

For FIX operation, both Header and follower unit perform the operation by itself.

When wired remote controller is used, air flow direction can be changed on each unit by selecting the indoor unit.)

#### 3. ⏰ lamp lights up only on the Header unit.

When the timer is set with wired remote controller, even the ⏰ lamp on the Header unit will not light up.



## 7. Handling the Remote Controller

### CAUTION

- The air conditioner will not operate if curtains, doors or other materials block the signals from the remote controller to the indoor unit.
- Prevent any liquid from falling into the remote controller.  
Do not expose the remote controller to direct sunlight or heat.
- If the infrared signal receiver on the indoor unit is exposed to direct sunlight, the air conditioner may not function properly.  
Use curtains to prevent the sunlight from reaching the receiver.
- If the room using the air conditioner has fluorescent lighting with electronic starters, signals may not be properly received. If you are planning to use such fluorescent lamps, consult your local dealer.
- If other electrical appliances react to the remote controller move these appliances or consult your local dealer.

### ■ Location of the remote controller

- Keep the remote controller where its signals can reach the receiver of the indoor unit (a distance of 7 m is allowed).
- When the timer operation is selected, the remote controller automatically transmits a signal to the indoor unit at the specified time.  
If you keep the remote controller in a position that hinders proper signal transmission, a time lag of up to 15 minutes may occur.

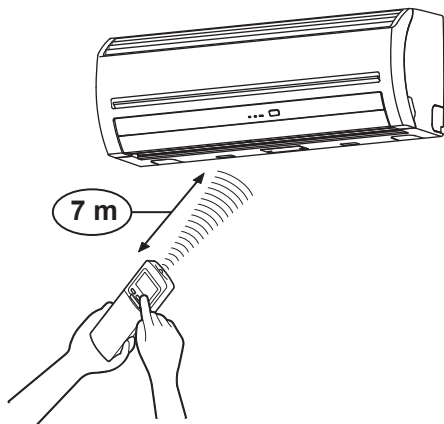

### ■ Remote controller holder

#### Installing the remote controller holder

- Before you actually install the remote controller holder on a wall or pillar, check whether the remote controller signals can be received by the indoor unit.

#### Mounting and removing the remote controller

- To mount the remote controller hold it parallel to the remote controller holder and push it in fully.  
To remove the remote controller slide the remote controller upwards and out from the holder.

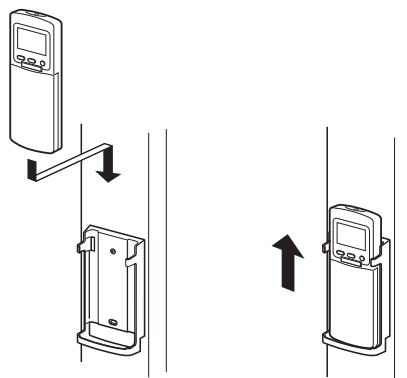

## 8. How to Use Remote Controller

### ■ Cooling / heating / fan only operation

#### Start

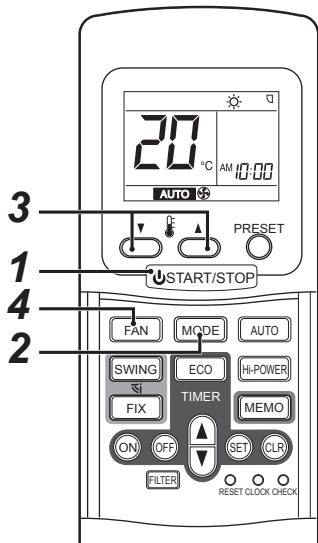

#### 1 START / STOP button

Push this button to start the air conditioner.

#### 2 Mode select button (MODE)

Select Cool , Heat , or Fan only .



#### 3 Temperature button (▼ ▲)

Set the desired temperature.

When the air conditioner is in FAN ONLY operation, the temperature display is not indicated.

#### 4 Fan speed button (FAN)

Select one of **AUTO**, LOW , LOW<sup>+</sup> , MED , MED<sup>+</sup> , HIGH .

- The  lamp (green) on the display panel of the indoor unit goes on. And operation starts after approximately 3 minutes. (If you select FAN ONLY mode, the unit will start immediately.)
- The : Fan only mode does not control temperature. Therefore, perform only steps **1**, **2** and **4** to select this mode.

#### Stop

##### START / STOP button

Push this button again to stop the air conditioner.

#### NOTE

When the indoor unit is operated together with a cooling only outdoor unit,  (Heat) appears on the remote controller but the heating operation is disabled.

### ■ Dry operation

#### Start

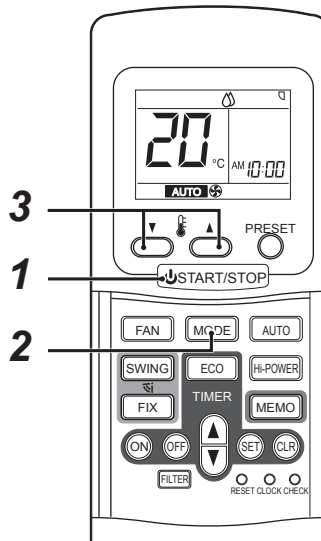

#### 1 START / STOP button

Push this button to start the air conditioner.

#### 2 Mode select button (MODE)

Select DRY .

#### 3 Temperature button (▼ ▲)

Set the desired temperature.

- The fan speed display indicates **AUTO**
- The  lamp (green) on the display panel of the indoor unit lights, and operation starts after approximately 3 minutes.

#### Stop

##### START / STOP button

Push this button again to stop the air conditioner.

## ■ Automatic operation

This function is available only for use in combination with a heat recovery model outdoor unit. If this function is used with another model of outdoor unit, "A" (Auto) appears on the remote controller but the automatic operation is disabled.

### Start

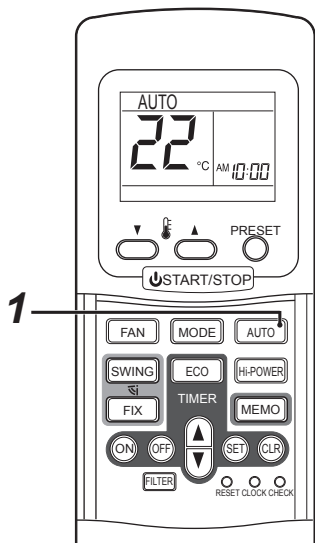

#### 1 AUTO button (AUTO)

Push AUTO button.

- The  lamp (green) on the display panel of the indoor unit lights. The operation mode is selected in accordance with the room temperature and operation starts after approximately 3 minutes.
- If the AUTO mode is uncomfortable, you can select the desired conditions manually. Temperature, fan speed and louver position can be changed. When fan speed or louver position is changed, MODE is also changed from AUTO to A. At the same time, fan speed and louver positioning indications are indicated.

### Stop

#### START / STOP button

Push this button again to stop the air conditioner.

## ■ Automatic operation (auto changeover)

### Start

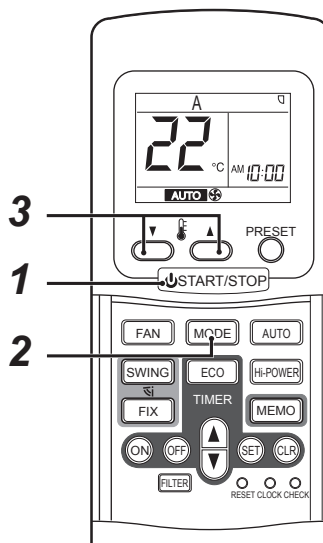

#### 1 START / STOP button

Push this button to start the air conditioner.

#### 2 Mode select button (MODE)

Select A.

#### 3 Temperature button (▼ ▲)

Set the desired temperature.

- The  lamp (green) on the display panel of the indoor unit lights. The operation mode is selected in accordance with the room temperature and operation starts after approximately 3 minutes.
- When the A mode is selected, it is unnecessary to set the fan speed. The FAN speed display will show **AUTO** and the fan speed will be automatically controlled.
- If the A mode is uncomfortable, you can select the desired conditions manually.

### Stop

#### START / STOP button

Push this button again to stop the air conditioner.

## ■ Timer operation

Use the wired remote controller for timer setting if it is also in use.

### ON timer and OFF timer

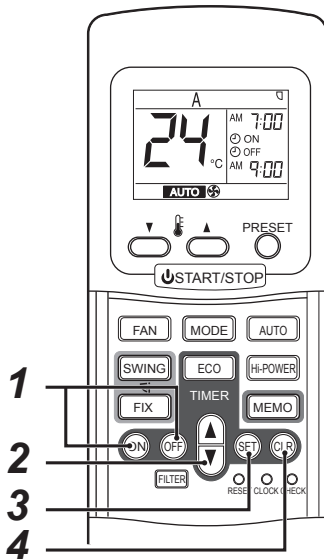

## ⚠ CAUTION

- When the timer operation is selected, the remote controller automatically transmits the timer signal to the indoor unit at the specified time. Therefore, keep the remote controller in a location where it can transmit the signal to the indoor unit properly. Otherwise, the time lag of up to 15 minutes will occur.
- If the SET (SET) button is not pushed within 30 seconds after setting the time, the setting will be cancelled.

### Setting TIMER

#### 1 ON / OFF TIMER button

Push the ON or OFF TIMER buttons as required.

- The previous timer setting is displayed and flashes along with ON / OFF timer display.

#### 2 TIMER (TIMER) button

Push the TIMER (TIMER) button.

Set the timer to the desired time.

Each push of the TIMER button changes the time in ten minute steps.

Pushing the TIMER button continually changes the time in one hour step.

#### 3 SET (SET) button

Push the SET (SET) button to set the timer.

The timer time is indicated and the timer starts.

### Cancelling TIMER

#### 4 CLR (CLR) button

Push the CLR (CLR) button to cancel the timer setting.

### Combined timer (Setting both ON and OFF timers simultaneously)

#### **OFF timer → ON timer (Operation → Stop → Operation)**

This feature is useful when you want to stop the air conditioner after you go to sleep, and start it again in the morning when you wake up or you return home.

Example:

To stop the air conditioner and start it again next morning.

#### ▼ **Setting combined TIMER**

1. Push the OFF (OFF) button.
2. Push the TIMER (TIMER) button to adjust the OFF timer.
3. Push the ON (ON) button.
4. Push the TIMER (TIMER) button to adjust the ON timer.
5. Push the SET (SET) button.

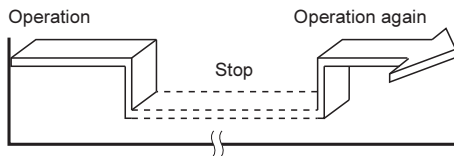

#### **ON timer → OFF timer (Stop → Operation → Stop)**

You can use this setting to start the air conditioner when you wake up and stop it when you leave the house.

Example:

To start the air conditioner next morning and stop it.

#### ▼ **Setting combined TIMER**

1. Push the ON (ON) button.
2. Push the TIMER (TIMER) button to adjust the ON timer.
3. Push the OFF (OFF) button.
4. Push the TIMER (TIMER) button to adjust the OFF timer.
5. Push the SET (SET) button.

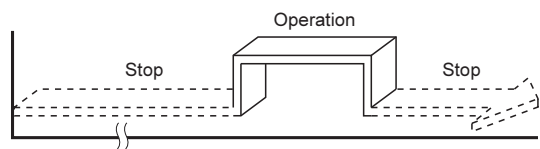

- Either ON or OFF timer function which is closer to the current time, is activated first.
- If the same time is set for both ON and OFF timers, no timer operation is performed. Also, the air conditioner may stop operating.

### Every day combined timer (setting both ON and OFF timer simultaneously and activate every day.)

This feature is useful when you want to use combined timer at the same time every day.

#### ▼ Setting combined TIMER

1. Push the ON (ON) button.
2. Push the TIMER (A) button to adjust the ON timer.
3. Push the OFF (OFF) button.
4. Push the TIMER (A) button to adjust the OFF timer.
5. Push the SET (SET) button.
6. After step 5, an arrow mark (↑ or ↓) flashes for about 3 seconds and during this flashing, push the SET (SET) button.

- During the every day timer is activating, both arrows (↑, ↓) are indicated.

### Cancel the timer operation

Push the CLR (CLR) button.

### Clock display

During the TIMER operation (ON-OFF, OFF-ON, OFF timer) clock display is disappeared so as to show the setting time. To see the present time, push SET button briefly and the present time is displayed about 3 seconds.

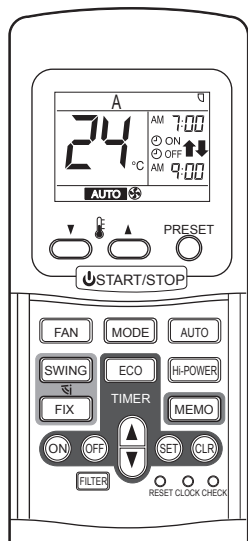

## ■ High power operation

### High power (Hi POWER)

- The Hi POWER (high power operation) mode automatically controls room temperature, airflow and operation mode so that the room is quickly cooled in summer and warmed in winter.

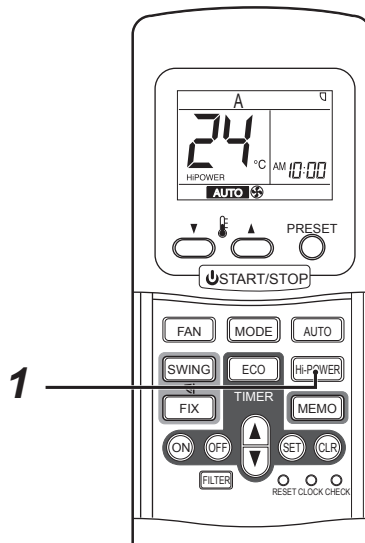

### Setting Hi POWER mode

#### 1 Hi POWER button

Push the Hi POWER button after starting any operation. At the same time, the "Hi POWER" mark on the remote controller is indicated.

### Cancelling Hi POWER mode

#### 1 Hi POWER button

Push the Hi POWER button once again. At the same time, the "Hi POWER" mark on the remote controller goes out.

### ⚠ CAUTION

- The Hi POWER mode cannot be activated in the DRY and FAN ONLY operation and when the ON TIMER operation is reserved.
  - Hi POWER mode is not available for group control.
- When Hi POWER is transmitted to the Header indoor unit, the receiving sound is heard but the Hi POWER mode will not be performed. Please cancel the Hi POWER mode.

## ■ Memory / Preset Operation

Memorize the frequently used operation setting by the MEMO button for convenience.

Start the air conditioner in the operation mode which you want the remote control to memorize.

Push the button as follows while the air conditioner is in operation.

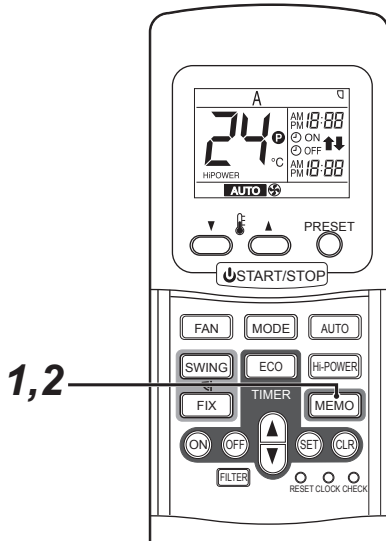

### 1 MEMO button

Push this button briefly to standby memorizing the setting.

All the icons currently displayed except for the clock display and **P** mark flashes.

### 2 MEMO button

Push and hold the MEMO button for more than 3 seconds while the display flashes.

The **P** mark is indicated and the setting is memorized.

- If the MEMO button is not pushed within 3 seconds or if another button is pushed, the MEMORY setting is cancelled.
- Operation modes which can be memorized with the MEMO button are MODE, Temperature, FAN, TIMER and Hi POWER.

To operate the air conditioner with the setting memorized by the MEMO button.

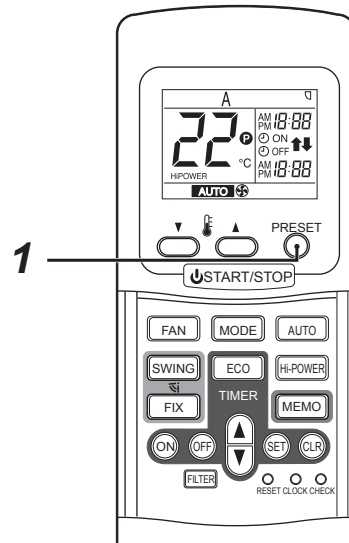

### 1 PRESET button

Push the PRESET button. The setting memorized with the MEMO button will be indicated and the air conditioner operates with regards to the setting.

- The **P** lamp (green) on the display panel of the indoor unit goes on, and operation starts after approximately 3 minutes.
- Initial setting:  
 MODE : AUTO  
 Temperature : 22

## ■ Adjusting airflow direction

- Adjust the airflow direction properly. Otherwise, it might cause discomfort and make the room temperature uneven.
- Adjust the vertical airflow using the remote controller.
- Adjust the horizontal airflow manually.

### Adjust the vertical airflow

The air conditioner automatically adjusts the vertical airflow direction in accordance with the operating conditions when AUTO or A mode is selected.

### To set the airflow direction you desire

Perform this function when the air conditioner is in operation.

### To automatically swing the airflow direction

Perform this function when the air conditioner is in operation.

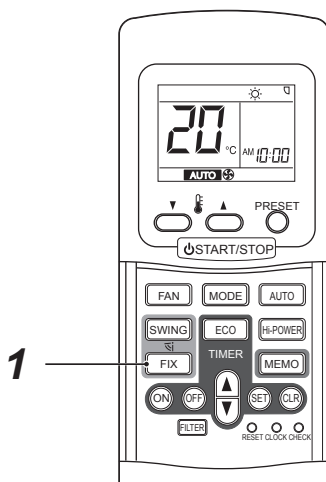
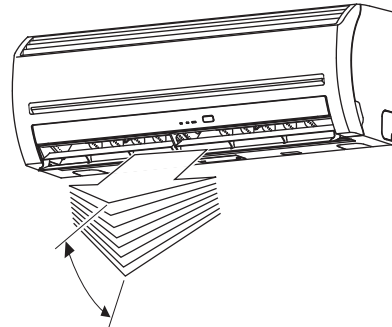

#### 1 FIX button

Keep pushing or pushing briefly the FIX button on the remote controller to move the louver in the desired direction.

- In subsequent operations, the vertical airflow is automatically set in the direction to which you adjusted the louver using the FIX button.

### NOTE

Operating angle of vertical airflow louver will be different during cooling, dry and heating operation.

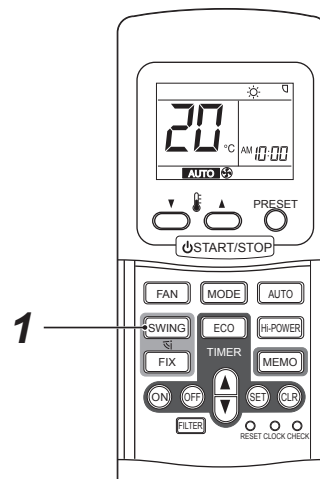

#### 1 SWING button

Push the SWING button on the remote controller.

- To stop the function, push the SWING button.



## CAUTION

- The FIX and SWING buttons will be disabled when the air conditioner is not in operation (including when the ON timer is set).
- Do not operate the air conditioner for long hours with the airflow direction set downward during the cooling or dry operation. Otherwise, condensation may occur on the surface of the vertical airflow louver and cause dew dripping.
- Do not move the vertical airflow louver manually. Always use the FIX button. If you move the louver manually, it may malfunction during operation. If the louver malfunctions, stop the air conditioner once, and restart.
- When the air conditioner is started immediately after it was stopped, the vertical airflow louver might not move for 10 seconds or so.
- Louver operation is limited when group control is used. (Refer to 6. Limited Operation by Group Control)

## ■ Adjust the horizontal airflow

### Preparation

- Take hold of the lever on the horizontal airflow louver and move them to adjust the airflow direction as required.
- You can adjust the airflow at the left, and right locations of the louver.

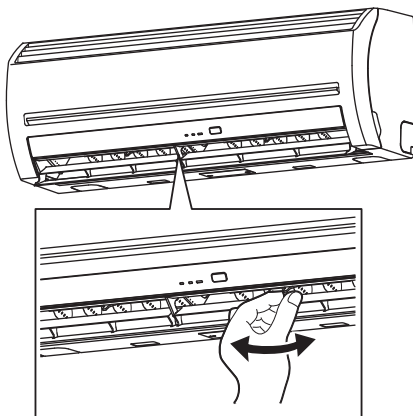

## 9. Hints for Economical Operation

### ■ Maintain room temperature at comfortable level

#### Clean air filters

The clogged air filters impairs the performance of the air conditioner.

Clean them once two weeks.

#### Do not open doors and windows more often than necessary

To keep cool or warm air in the room, do not open doors and windows more often than necessary.

#### Window curtains

In cooling, close the curtains to avoid direct sunlight.

In heating, close the curtains to keep the heat in.

#### Use the timer effectively

Set the timer for the desired operating time.

#### Get uniform circulation of room air

Adjust airflow direction for even circulation of room air.

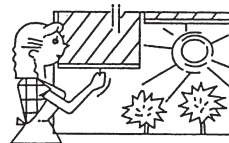
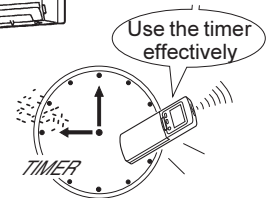
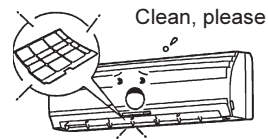
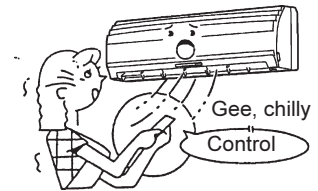

Blows upward

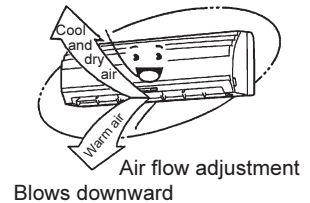
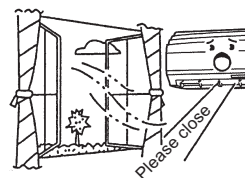

Air flow adjustment  
Blows downward

# 10. Temporary Operation

## ■ TEMPORARY operation

This function is used to operate the unit temporarily if the wireless remote controller is misplaced or its batteries are exhausted.

- Push the TEMPORARY button once (less than 3 seconds) to start the air conditioner.
- The last operation conducted with the wireless remote controller will be performed. (When wireless remote controller is not used, models with the auto-changeover (cooling / heating) function perform "A" operation, and those without the function perform cooling operation (set temperature: 24 °C, fan: HIGH).)

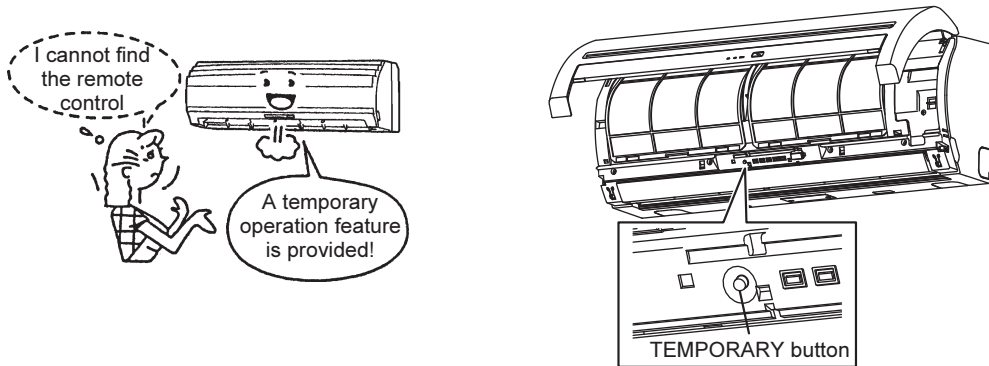

### CAUTION

Continuous pushing of the TEMPORARY button for 10 seconds and above will start the forced cooling operation. (This will impose burden on the air conditioner. Do not perform this for the purposes other than test run.) In this time all indicators of indoor unit go on.

# 11. How the Air Conditioner Works

## NOTE

This manual describes wireless remote control specific operations.  
For other operations, refer to the operation manual supplied with the outdoor unit.

### Hi POWER operation

When the Hi POWER button is pushed during cooling, heating or A operation, the air conditioner will start the following operation.

- **Cooling operation**

Performs the cooling operation at 1 °C lower than the setting temperature.  
Only when the fan speed before the Hi POWER operation is not high, the fan speed will be increased.

- **Heating operation**

Performs the heating operation at 2 °C higher than the setting temperature.  
Only when the fan speed before the Hi POWER operation is not high, the fan speed will be increased.

### ECO timer operation

When the ECO button is pushed during cooling, heating or AUTO operation, the air conditioner will start the following operation.

The fan speed display will indicate AUTO and low speed will be used.

- **Cooling operation**

In the operation suppression zone, where capacity is kept to the minimum, over cooling is prevented by raising the temperature setting by 1 °C after 1 hour and by 2 °C after 2 hours of operation. The room temperature is thus regulated between the operation suppression zone and the set temperature.

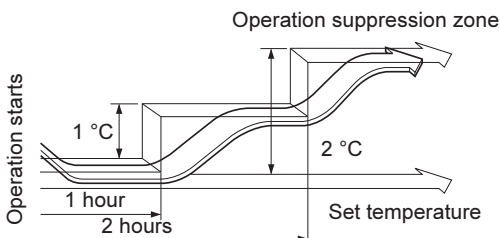

- **Heating operation**

In the operation suppression zone, where capacity is kept to the minimum, overheating is prevented by lowering the temperature setting by 1 °C after 1 hour and by 2 °C after 2 hours of operation.

The room temperature is thus regulated between the set temperature and the operation suppression zone.

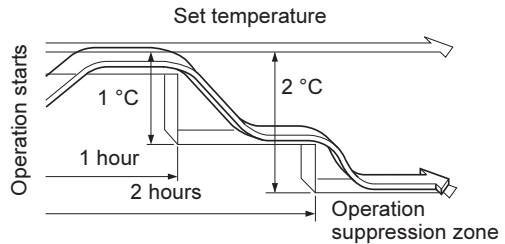

## CAUTION

ECO-TIMER operation is not available for group control. When ECO-TIMER is transmitted to the main unit, the receiving sound is heard but the ECO-TIMER operation will not be performed. Display panel on the remote control will change to ECO-TIMER setting display. Cancel the setting, push cancel button.

# 12. Maintenance

## WARNING

Before cleaning the air conditioner, turn off the circuit breaker or main power switch.

### ■ Cleaning of indoor unit and remote controller

## CAUTION

- Use a dry cloth to wipe the indoor unit and remote controller.
- A cloth dampened with cold water may be used on the indoor unit if it is very dirty.
- Do not use a damp cloth on the remote controller.
- Do not use a chemically-treated duster for wiping or leave such materials on the unit for long. It may damage or fade the surface of the unit.
- Do not use benzene, thinner, polishing powder, or similar solvents for cleaning.  
These may cause the plastic surface to crack or deform.

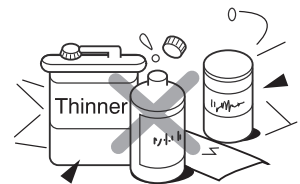

### If you will not use the unit for at least 1 month

1. Operate the air conditioner in FAN ONLY mode for about half a day to dry the inside of the unit.
2. Stop the air conditioner and turn off the main power switch.
3. Remove the batteries from the remote controller.

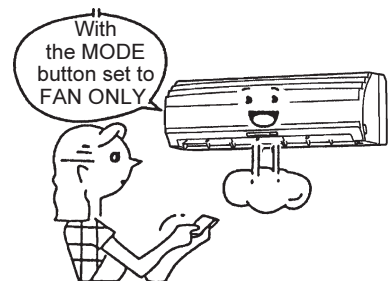

### Check before operation

## CAUTION

- Check that the air filters are installed.
- Check that the air discharge or intake of the outdoor unit is not blocked.

## ■ Cleaning the air filter

Clean the air filters every 2 weeks.

If the air filters are covered with dust, the performance of the air conditioner will deteriorate.

Clean the air filters as often as possible.

### 1 Open the air intake grille.

Lift the air intake grille up to the horizontal position.

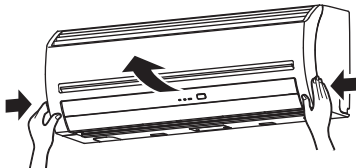

### 2 Take hold of the left and right handles of the air filter and lift it up slightly, then pull it downward to take it out from the filter holder.

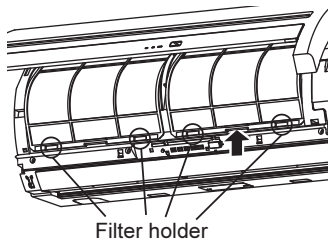

### 3 Use a vacuum cleaner to remove the dust from the filters or wash them with water.

If you wash the air filters, dry them in the shade.

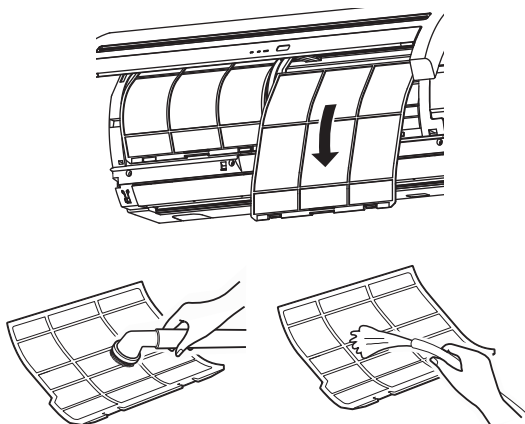

### 4 Insert the upper portion of air filter confirming to fit its right and left edges on the indoor unit until it is firmly set.

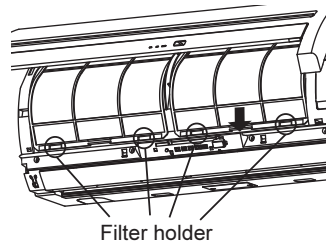
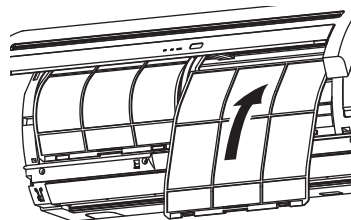

### 5 Close the air intake grille.

## ■ Cleaning the air intake grille

### 1 Remove the air intake grille.

Hold the two sides of the air intake grille and open upwards.  
Move the centre arm to the left and remove the grille.

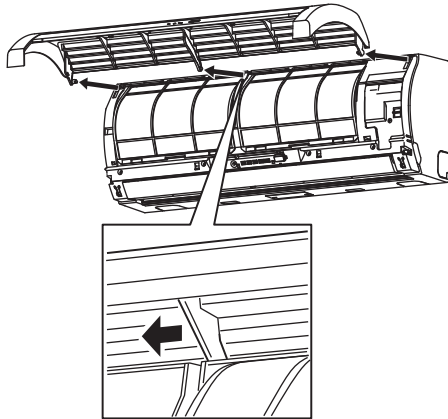

### 2 Wash it with water using a soft sponge or towel.

**(Do not use metallic scrubbing brush or other hard brushes.)**

- Use of such hard objects will cause scratches on the surface of the grille, and the metal coating to peel off.
- If very dirty, clean the air intake grille with a neutral detergent for kitchen use, and rinse it off with water.

### 3 Wipe out water from the air intake grille and dry it.

### 4 Fit the left and right arms of the air intake grille to the shafts on the two sides of the air conditioner and push in completely, and then push in the centre arm.

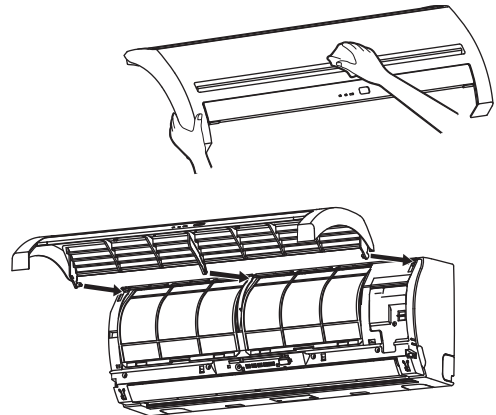

### 5 Check that the centre arm has been completely inserted and close the air intake grille.

- Push the arrow locations (four) at the bottom of the air intake grille to check whether the grille is completely closed.

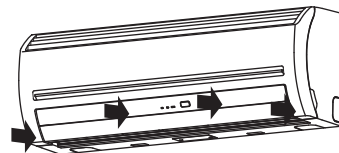

# 13. Troubles and Causes

For contents of the outdoor unit, combinations or other details, refer to the owner's manual supplied with the outdoor unit.

## CAUTION

If any of the following conditions occur, stop the air conditioner immediately, set to off the main power switch and contact the dealer:

- Switch operation are erratic.
- The main power fuse often blows out, or the circuit breaker is often activated.
- Foreign matter or water has fallen inside the air conditioner.
- Any other unusual condition is observed.
- Abnormal display appears on the remote controller display while using wired remote controller.

## Before you ask for servicing or repairs, check the following points.

### ▼ Recheck

#### Inoperative

- The power main switch is turned off. (Indoor)
- The circuit breaker is activated to cut off the power supply.
- The main power fuse has blown out.
- Stoppage of electric current.
- The batteries in the remote controller are exhausted.
- ON TIMER is set.
- Signal is sent to the follower indoor unit with the remote controller. (see page 16)
- Operation of the indoor unit is limited by the wired remote controller that is controlling some other system. (When signal is transmitted, warning sound (5 beeps) will be heard.)
- Disagreement in operation mode occurred. (When the operation mode disagrees, the "OPERATION" lamp lights up, and the "TIMER" and "Preheat / Defrost" lamps blink alternately with an alarm sound.) (see page 10)

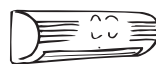

#### Poor cooling or heating performance

- Doors or windows are opened.
- The air filter is clogged with dust.
- The louver is not at the correct position.
- The fan speed is set to low.
- The air conditioner is set in the ECO or DRY mode.
- The set temperature is too high. (In cooling operation)
- The set temperature is too low. (In heating operation)
- (Only when the air is not cooled even during cooling operation)  
When another indoor unit in the same system is heating.





▼ **These are not failures.**

**The back of indoor unit is dewed.**

- Dewdrops on the back of the indoor unit are automatically collected and drained out.

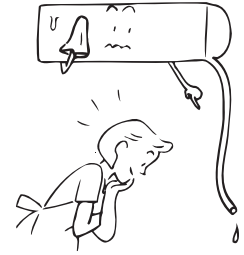

**Indoor unit or outdoor unit makes a strange noise.**

- When temperature sharply changes, the indoor or outdoor unit occasionally makes a strange noise because of expansion / contraction of parts or change of refrigerant flow.

**The room air is smelly.**

**A bad odour comes from the air conditioner.**

- Smells impregnated in the wall, carpet, furniture, clothing, or furs, are coming out.

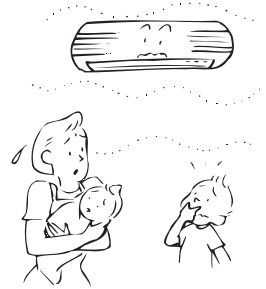

**Louver does not work in the FIX or SWING mode.**

- The FIX and SWING modes are restricted under the group control. (see page 15)



**Fan and louvers of the indoor unit moves when the unit is not operated.**

- When the other indoor unit(s) is operating within the system, a fan of switched off indoor unit may temporary operate.

# 14 Specifications

Model	Sound pressure level (dBA)		Weight (kg) Main unit
	Cooling	Heating	
MMK-AP0054MHP-E	*	*	11
MMK-AP0074MH-E	*	*	11
MMK-AP0094MH-E	*	*	11
MMK-AP0124MH-E	*	*	11
MMK-AP0054MHP-E1	*	*	11
MMK-AP0074MHP-E1	*	*	11
MMK-AP0094MHP-E1	*	*	11
MMK-AP0124MHP-E1	*	*	11

\* Under 70 dBA

# Declaration of Conformity

Manufacturer: Toshiba Carrier (Thailand) Co., Ltd.  
144/9 Moo5, Bangkadi Industrial Park, Tivanon Road, Tambol Bangkadi,  
Amphur Muang, Pathumthani 12000 Thailand

Authorized Representative / TCF holder: Nick Ball  
Toshiba EMEA Engineering Director  
Toshiba Carrier UK Ltd.  
Porsham Close, Belliver Industrial Estate,  
PLYMOUTH, Devon, PL6 7DB.  
United Kingdom

Hereby declares that the machinery described below:

Generic Denomination: Air Conditioner

Model / type: MMK-AP0054MHP-E, MMK-AP0074MH-E, MMK-AP0094MH-E, MMK-AP0124MH-E,  
MMK-AP0054MHP-E1, MMK-AP0074MHP-E1, MMK-AP0094MHP-E1, MMK-AP0124MHP-E1

Commercial name: Super Modular Multi System Air Conditioner  
Super Heat Recovery Multi System Air Conditioner  
Mini-Super Modular Multi System Air Conditioner (MiNi-SMMS series)

Complies with the provisions of the "Machinery" Directive (Directive 2006/42/EC) and the regulations transposing into national law

## NOTE

This declaration becomes invalid if technical or operational modifications are introduced without the manufacturer's consent.

<b>Information according to EMC Directive 2004/108/EC</b>	
(Name of the manufacturer)	<b>TOSHIBA CARRIER (THAILAND) CO., LTD.</b>
(Address, city, country)	144/9 Moo 5, Bangkadi Industrial Park, Tivanon Road, Tambol Bangkadi, Amphur Muang, Pathumthani 12000, Thailand
(Name of the Importer / Distributor in EU)	<b>Toshiba Carrier UK Ltd.</b>
(Address, city, country)	Porsham Close, Belliver Industrial Estate, PLYMOUTH, Devon, PL6 7DB. United Kingdom

## **TOSHIBA CARRIER (THAILAND) CO.,LTD.**

144 / 9 Moo 5, Bangkadi Industrial Park, Tivanon Road, Tambol Bangkadi, Amphur Muang, Pathumthani 12000, Thailand