

Refrigerant Monitoring

RBC-AIP4 Leak Detection Panel

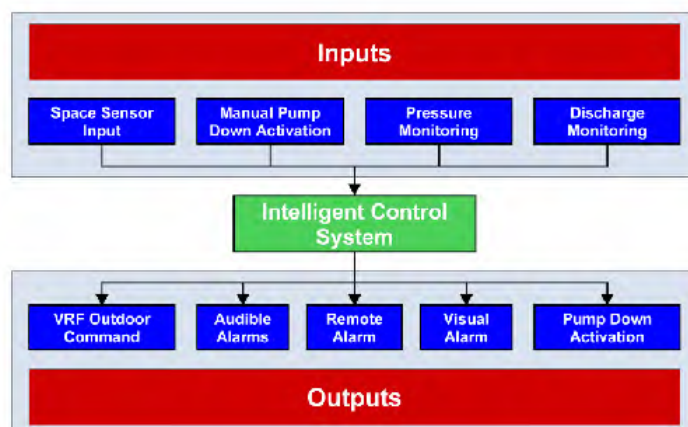

Original instruction

ADOPTION OF NEW REFRIGERANT

This Air Conditioner uses R410A an environmentally friendly refrigerant.

Contents

1	Precautions for safety	5
2	Installation of new refrigerant air conditioner	8
3	Selection of installation place	9
4	Refrigerant piping	9
5	Electric wiring	13
6	Installation Examples	14
7	Control Schematic.....	15
8	Specifications	16
9	RBC-AIP4 Remote Room Indicator.....	18

Thank you for purchasing Toshiba air conditioning products.

This Installation Manual describes the installation method of the outdoor unit. For installation of indoor units, follow the Installation Manual supplied with the indoor unit.

Moreover, as this installation manual includes the important articles concerning the “Machinery” Directive (Directive 2006/42/ EC), please read through the manual and make sure you understand it. After installation, give this Installation Manual, the Owner’s Manual and the Installation Manual supplied with the indoor unit to the customer and tell the customer to keep them safe.

Prepare an exclusive power source for indoor units, independent to that for outdoor units.

Y-shaped branching joints or a branching header (separately purchased) are required for connecting pipes between indoor and outdoor units. Choose either of them considering the system capacity concerning piping. For installing branching pipes, refer to the installation manual of the Y-shaped branching unit or branching header (separately purchased).

Outdoor connecting branching joints are required for connecting between outdoor units.

Generic Denomination: Air Conditioner

Definition of Qualified Installer or Qualified Service Person

The air conditioner must be installed, maintained, repaired and removed by a qualified installer or qualified service person. When any of these jobs is to be done, ask a qualified installer or qualified service person to do them for you.

A qualified installer or qualified service person is an agent who has the qualifications and knowledge described in the table below.

Agent	Qualifications and knowledge which the agent must have
Qualified installer	<ul style="list-style-type: none"> • The qualified installer is a person who installs, maintains, relocates and removes the air conditioners made by Toshiba Carrier Corporation. He or she has been trained to install, maintain, relocate and remove the air conditioners made by Toshiba Carrier Corporation or, alternatively, he or she has been instructed in such operations by an individual or individuals who have been trained and is thus thoroughly acquainted with the knowledge related to these operations. • The qualified installer who is allowed to do the electrical work involved in installation, relocation and removal has the qualifications pertaining to this electrical work as stipulated by the local laws and regulations, and he or she is a person who has been trained in matters relating to electrical work on the air conditioners made by Toshiba Carrier Corporation or, alternatively, he or she has been instructed in such matters by an individual or individuals who have been trained and is thus thoroughly acquainted with the knowledge related to this work. • The qualified installer who is allowed to do the refrigerant handling and piping work involved in installation, relocation and removal has the qualifications pertaining to this refrigerant handling and piping work as stipulated by the local laws and regulations, and he or she is a person who has been trained in matters relating to refrigerant handling and piping work on the air conditioners made by Toshiba Carrier Corporation or, alternatively, he or she has been instructed in such matters by an individual or individuals who have been trained and is thus thoroughly acquainted with the knowledge related to this work. • The qualified installer who is allowed to work at heights has been trained in matters relating to working at heights with the air conditioners made by Toshiba Carrier Corporation or, alternatively, he or she has been instructed in such matters by an individual or individuals who have been trained and is thus thoroughly acquainted with the knowledge related to this work.
Qualified service person	<ul style="list-style-type: none"> • The qualified service person is a person who installs, repairs, maintains, relocates and removes the air conditioners made by Toshiba Carrier Corporation. He or she has been trained to install, repair, maintain, relocate and remove the air conditioners made by Toshiba Carrier Corporation or, alternatively, he or she has been instructed in such operations by an individual or individuals who have been trained and is thus thoroughly acquainted with the knowledge related to these operations. • The qualified service person who is allowed to do the electrical work involved in installation, repair, relocation and removal has the qualifications pertaining to this electrical work as stipulated by the local laws and regulations, and he or she is a person who has been trained in matters relating to electrical work on the air conditioners made by Toshiba Carrier Corporation or, alternatively, he or she has been instructed in such matters by an individual or individuals who have been trained and is thus thoroughly acquainted with the knowledge related to this work. • The qualified service person who is allowed to do the refrigerant handling and piping work involved in installation, repair, relocation and removal has the qualifications pertaining to this refrigerant handling and piping work as stipulated by the local laws and regulations, and he or she is a person who has been trained in matters relating to refrigerant handling and piping work on the air conditioners made by Toshiba Carrier Corporation or, alternatively, he or she has been instructed in such matters by an individual or individuals who have been trained and is thus thoroughly acquainted with the knowledge related to this work. • The qualified service person who is allowed to work at heights has been trained in matters relating to working at heights with the air conditioners made by Toshiba Carrier Corporation or, alternatively, he or she has been instructed in such matters by an individual or individuals who have been trained and is thus thoroughly acquainted with the knowledge related to this work.

Definition of Protective Gear







When the air conditioner is to be transported, installed, maintained, repaired or removed, wear protective gloves and ‘safety’ work clothing.

In addition to such normal protective gear, wear the protective gear described below when undertaking the special work detailed in the table below.

Failure to wear the proper protective gear is dangerous because you will be more susceptible to injury, burns, electric shocks and other injuries.

Work undertaken	Protective gear worn
All types of work	Protective gloves 'Safety' working clothing
Electrical-related work	Gloves to provide protection for electricians and from heat Insulating shoes Clothing to provide protection from electric shock
Work done at heights (50 cm or more)	Helmets for use in industry
Transportation of heavy objects	Shoes with additional protective toe cap
Repair of outdoor unit	Gloves to provide protection for electricians and from heat

■ Warning Indications on the Air Conditioner Unit

Warning indication	Description		
 <table border="1" style="display: inline-table; vertical-align: top;"> <tr> <td style="text-align: center;">WARNING</td> </tr> <tr> <td>ELECTRICAL SHOCK HAZARD Disconnect all remote electric power supplies before servicing.</td> </tr> </table>	WARNING	ELECTRICAL SHOCK HAZARD Disconnect all remote electric power supplies before servicing.	<p>WARNING ELECTRICAL SHOCK HAZARD Disconnect all remote electric power supplies before servicing.</p>
WARNING			
ELECTRICAL SHOCK HAZARD Disconnect all remote electric power supplies before servicing.			
 <table border="1" style="display: inline-table; vertical-align: top;"> <tr> <td style="text-align: center;">WARNING</td> </tr> <tr> <td>Moving parts. Do not operate unit with grille removed. Stop the unit before the servicing.</td> </tr> </table>	WARNING	Moving parts. Do not operate unit with grille removed. Stop the unit before the servicing.	<p>WARNING Moving parts. Do not operate unit with grille removed. Stop the unit before the servicing.</p>
WARNING			
Moving parts. Do not operate unit with grille removed. Stop the unit before the servicing.			
 <table border="1" style="display: inline-table; vertical-align: top;"> <tr> <td style="text-align: center;">CAUTION</td> </tr> <tr> <td>High temperature parts. You might get burned when removing this panel.</td> </tr> </table>	CAUTION	High temperature parts. You might get burned when removing this panel.	<p>CAUTION High temperature parts. You might get burned when removing this panel.</p>
CAUTION			
High temperature parts. You might get burned when removing this panel.			
 <table border="1" style="display: inline-table; vertical-align: top;"> <tr> <td style="text-align: center;">CAUTION</td> </tr> <tr> <td>Do not touch the aluminum fins of the unit. Doing so may result in injury.</td> </tr> </table>	CAUTION	Do not touch the aluminum fins of the unit. Doing so may result in injury.	<p>CAUTION Do not touch the aluminium fins of the unit. Doing so may result in injury.</p>
CAUTION			
Do not touch the aluminum fins of the unit. Doing so may result in injury.			
 <table border="1" style="display: inline-table; vertical-align: top;"> <tr> <td style="text-align: center;">CAUTION</td> </tr> <tr> <td>BURST HAZARD Open the service valves before the operation, otherwise there might be the burst.</td> </tr> </table>	CAUTION	BURST HAZARD Open the service valves before the operation, otherwise there might be the burst.	<p>CAUTION BURST HAZARD Open the service valves before the operation; otherwise there might be the burst.</p>
CAUTION			
BURST HAZARD Open the service valves before the operation, otherwise there might be the burst.			
 <table border="1" style="display: inline-table; vertical-align: top;"> <tr> <td style="text-align: center;">CAUTION</td> </tr> <tr> <td>Do not climb onto the fan guard. Doing so may result in injury.</td> </tr> </table>	CAUTION	Do not climb onto the fan guard. Doing so may result in injury.	<p>CAUTION Do not climb onto the fan guard. Doing so may result in injury.</p>
CAUTION			
Do not climb onto the fan guard. Doing so may result in injury.			

1 Precautions for safety

The manufacturer shall not assume any liability for the damage caused by not observing the description of this manual.

WARNING

General

- Before starting to install the air conditioner, read through the Installation Manual carefully, and follow its instructions to install the air conditioner. Otherwise, falling down of the unit may occur, or the unit may cause noise, vibration or water leakage.
- Only a qualified installer (*1) or qualified service person (*1) is allowed to do installation work. If installation is carried out by an unqualified individual, a fire, electric shocks, injury, water leakage, noise and/or vibration may result.
- If using separately sold products, make sure to use Toshiba specified products only. Using unspecified products may cause fire, electric shock, water leak or other failure.
- Do not use any refrigerant different from the one specified for complement or replacement. Otherwise, abnormally high pressure may be generated in the refrigeration cycle, which may result in a failure or explosion of the product or an injury to your body.
- Before opening the service panel of the outdoor unit, set the circuit breaker to the OFF position. Failure to set the circuit breaker to the OFF position may result in electric shocks through contact with the interior parts. Only a qualified installer (*1) or qualified service person (*1) is allowed to remove the service panel of the outdoor unit and do the work required.
- Before carrying out the installation, maintenance, repair or removal work, be sure to set the circuit breakers for both the indoor and outdoor units to the OFF position. Otherwise, electric shock may result.
- Place a "Work in progress" sign near the circuit breaker while the installation, maintenance, repair or removal work is being carried out. There is a danger of electric shocks if the circuit breaker is set to ON by mistake.
- Only a qualified installer (*1) or qualified service person (*1) is allowed to undertake work at heights using a stand of 50 cm or more or to remove the intake grille of the indoor unit to undertake work.
- Wear protective gloves and safety work clothing during installation, servicing and removal.
- Do not touch the aluminium fin of the outdoor unit. You may injure yourself if you do so. If the fin must be touched for some reason, first put on protective gloves and safety work clothing, and then proceed.
- Do not climb onto or place objects on top of the outdoor unit. You may fall or the objects may fall off of the outdoor unit and result in injury.
- When working at height, put a sign in place so that no-one will approach the work location before proceeding with the work. Parts or other objects may fall from above, possibly injuring a person below. Also, be sure that workers put on helmets.
- When cleaning the filter or other parts of the outdoor unit, set the circuit breaker to OFF without fail, and place a "Work in progress" sign near the circuit breaker before proceeding with the work.
- When working at heights, put a sign in place so that no-one will approach the work location, before proceeding with the work. Parts and other objects may fall from above, possibly injuring a person below.
- The refrigerant used by this air conditioner is the R410A.
- You shall ensure that the air conditioner is transported in stable condition. If you find any part of the product broken, contact your dealer.
- Do not disassemble, modify, repair or move the product yourself. Doing so may cause fire, electric shock, injury or water leaks. Ask a qualified installer or qualified service person to do any repairs or to move the product.
- Selection of installation location
- If you install the unit in a small room, take appropriate measures to prevent the refrigerant from exceeding the limit concentration even if it leaks. Consult the dealer from whom you purchased the air conditioner when you implement the measures. Accumulation of highly concentrated refrigerant may cause an oxygen deficiency accident.
- Do not install in a location where flammable gas may leak and accumulate around the unit, it may ignite and cause a fire.
- When transporting the air conditioner, wear shoes with protective toe caps, protective gloves and other protective clothing.
- When transporting the air conditioner, do not take hold of the bands around the packing carton. You may injure yourself if the bands should break.
- Install the indoor unit at least 2.5 m above the floor level since otherwise the users may injure themselves or receive electric shocks if they poke their fingers or other objects into the indoor unit while the air conditioner is running.
- Do not place any combustion appliance in a place where it is directly exposed to the wind of air conditioner, otherwise it may cause imperfect combustion.
- Places where the operation sound of the outdoor unit may cause a disturbance. (Especially at the boundary line with a neighbour, install the air conditioner while considering the noise.)
- Installation
- Follow the instructions in the Installation Manual to install the air conditioner. Failure to follow these instructions may cause the product to fall down or topple over or give rise to noise, vibration, water leakage or other failure.
- The designated bolts (M12) and nuts (M12) for securing the outdoor unit must be used when installing the unit.
- Install the outdoor unit properly in a location that is durable enough to support the weight of the outdoor unit. Insufficient durability may cause the outdoor unit to fall, which may result in injury.
- Install the unit in the prescribed manner for protection against strong wind and earthquake. Incorrect installation may result in the unit falling down, or other accidents.
- Be sure to fix the screws back which have been removed for installation or other purposes.

Refrigerant Piping

- Install the refrigerant pipe securely during the installation work before operating the air conditioner. If the compressor is operated with the valve open and without refrigerant pipe, the compressor sucks air and the refrigeration cycle is over pressurized, which may cause an injury.
- Tighten the flare nut with a torque wrench in the specified manner. Excessive tightening of the flare nut may cause a crack in the flare nut after a long period, which may result in refrigerant leakage.
- Ventilate the air if the refrigerant gas leaks during installation. If the leaked refrigerant gas comes into contact with fire, toxic gas may be produced.
- After the installation work, confirm that refrigerant gas does not leak. If refrigerant gas leaks into the room and flows near a fire source, such as a cooking range, noxious gas may be generated.
- When the air conditioner has been installed or relocated, follow the instructions in the Installation Manual and purge the air completely so that no gases other than the refrigerant will be mixed in the refrigerating cycle. Failure to purge the air completely may cause the air conditioner to malfunction.
- Nitrogen gas must be used for the airtight test.
- The charge hose must be connected in such a way that it is not slack.
- If refrigerant gas has leaked during the installation work, ventilate the room immediately. If the leaked refrigerant gas comes in contact with fire, noxious gas may be generated.

Electrical Wiring

- Only a qualified installer (*1) or qualified service person (*1) is allowed to carry out the electrical work of the air conditioner. Under no circumstances must this work be done by an unqualified individual since failure to carry out the work properly may result in electric shocks and/or electrical leaks.
- When connecting the electrical wires, repairing the electrical parts or undertaking other electrical jobs, wear gloves to provide protection for electricians and from heat, insulating shoes and clothing to provide protection from electric shocks. Failure to wear this protective gear may result in electric shocks.
- When executing address setting, test run, or troubleshooting through the checking window on the electrical control box, put on insulated heat-proof gloves, insulated shoes and other clothing to provide protection from electric shock. Otherwise you may receive an electric shock.
- Use wiring that meets the specifications in the Installation Manual and the stipulations in the local regulations and laws. Use of wiring which does not meet the specifications may give rise to electric shocks, electrical leakage, smoking and/or a fire.
- Check that the product is properly earthed. (grounding work) Incomplete earthing may cause electric shock.
- Do not connect the earth wire to a gas pipe, water pipe, lightning conductor, or a telephone earth wire.
- After completing the repair or relocation work, check that the ground wires are connected properly.
- Install a circuit breaker that meets the specifications in the installation manual and the stipulations in the local regulations and laws.
- Install the circuit breaker where it can be easily accessed by the agent.
- When installing the circuit breaker outdoors, install one which is designed to be used outdoors.
- Under no circumstances must the power cable be extended. Connection trouble in the places where the cable is extended may give rise to smoking and/or a fire.
- Electrical wiring work shall be conducted according to law and regulation in the community and installation manual. Failure to do so may result in electrocution or short circuit.
- Do not supply power from the power terminal block equipped on the outdoor unit to another outdoor unit. Capacity overflow may occur on the terminal block and may result in fire.
- When carrying out electric connection, use the wire specified in the Installation Manual and connect and fix the wires securely to prevent them applying external force to the terminals. Improper connection or fixing may result in fire.

Test Run

- Before operating the air conditioner after having completed the work, check that the electrical control box cover of the indoor unit and service panel of the outdoor unit are closed, and set the circuit breaker to the ON position. You may receive an electric shock if the power is turned on without first conducting these checks.
- When you have noticed that some kind of trouble (such as when an error display has appeared, there is a smell of burning, abnormal sounds are heard, the air conditioner fails to cool or heat or water is leaking) has occurred in the air conditioner, do not touch the air conditioner yourself but set the circuit breaker to the OFF position, and contact a qualified service person. Take steps to ensure that the power will not be turned on (by marking "out of service" near the circuit breaker, for instance) until qualified service person arrives. Continuing to use the air conditioner in the trouble status may cause mechanical problems to escalate or result in electric shocks or other failure.
- After the work has finished, be sure to use an insulation tester set (500 V Megger) to check the resistance is 2 MΩ or more between the charge section and the non-charge metal section (Earth section). If the resistance value is low, a disaster such as a leak or electric shock is caused at user's side.
- Upon completion of the installation work, check for refrigerant leaks and check the insulation resistance and water drainage. Then conduct a test run to check that the air conditioner is operating properly.

Explanations Given To User

- Upon completion of the installation work, tell the user where the circuit breaker is located. If the user does not know where the circuit breaker is, he or she will not be able to turn it off in the event that trouble has occurred in the air conditioner.
- If you have discovered that the fan grille is damaged, do not approach the outdoor unit but set the circuit breaker to the OFF position, and contact a qualified service person(*1) to have the repairs done. Do not set the circuit breaker to the ON position until the repairs are completed.
- After the installation work, follow the Owner's Manual to explain to the customer how to use and maintain the unit.

Relocation

- Only a qualified installer (*1) or qualified service person (*1) is allowed to relocate the air conditioner. It is dangerous for the air conditioner to be relocated by an unqualified individual since a fire, electric shocks, injury, water leakage, noise and/or vibration may result.
- When carrying out the pump-down work shut down the compressor before disconnecting the refrigerant pipe. Disconnecting the refrigerant pipe with the service valve left open and the compressor still operating will cause air or other gas to be sucked in, raising the pressure inside the refrigeration cycle to an abnormally high level, and possibly resulting in rupture, injury or other trouble.
- Never recover the refrigerant into the outdoor unit. Be sure to use a refrigerant recovery machine to recover the refrigerant when moving or repairing. It is impossible to recover the refrigerant into the outdoor unit. Refrigerant recovery into the outdoor unit may result in serious accidents such as explosion of the unit, injury or other accidents.

(*1) Refer to the "Definition of Qualified Installer or Qualified Service Person."



New refrigerant air conditioner installation

- **This air conditioner adopts the new HFC refrigerant (R410A) which does not destroy ozone layer.**
- The characteristics of R410A refrigerant are; easy to absorb water, oxidizing membrane or oil, and its pressure is approx. 1.6 times higher than that of refrigerant R22. Accompanied with the new refrigerant, refrigerating oil has also been changed. Therefore, during installation work, be sure that water, dust, former refrigerant, or refrigerating oil does not enter the refrigerating cycle.
- To prevent charging an incorrect refrigerant and refrigerating oil, the sizes of connecting sections of charging port of the main unit and installation tools are changed from those for the conventional refrigerant.
- Accordingly the exclusive tools are required for the new refrigerant (R410A).
- For connecting pipes, use new and clean piping designed for R410A, and please care so that water or dust does not enter.

Disconnection of the appliance from mains power supply.

- This appliance must be connected to the main power supply by means of a switch with a contact separation of at least 3 mm.

The installation fuse (all type can be used) must be used for the power supply line of this conditioner.

2 Installation of New Refrigerant Air Conditioner

This air conditioner adopts the new HFC refrigerant (R410A) which does not deplete the ozone layer.

- R410A refrigerant is vulnerable to impurities such as water, oxidizing membranes, or oils because the pressure of R410A refrigerant is higher than that of the former refrigerant by approximately 1.6 times.
- As well as the adoption of the new refrigerant, the refrigerating oil has been also changed. Therefore, pay attention so that water, dust, former refrigerant, or refrigerating oil does not enter the refrigerating cycle of the new refrigerant air conditioner during installation.
- To prevent mixing of refrigerant or refrigerating oil, the size of the charge port of the main unit or connecting section of the installation tool differs to that of an air conditioner for the former refrigerant. Accordingly, exclusive tools are required for the new refrigerant (R410A) as shown below.
- For connecting pipes, use new and clean piping materials so that water or dust does not enter.

■ Required Tools and Cautions on Handling

It is necessary to prepare the tools and parts for installation as described below. The tools and parts which will be newly prepared in the following items should be restricted to exclusive use.

Explanation of symbols

- △ : Newly prepared (It is necessary to use it exclusively with R410A, separately from those for R22 or R407C.)
 ○ : Former tool is available.

Used Tools	Usage	Proper Use of Tools / Parts
Gauge manifold	Vacuuming, charging refrigerant and operation check	△ Exclusive to R410A
Charging hose		△ Exclusive to R410A
Charging cylinder	Charging refrigerant	Unusable (Use the Refrigerant charging balance.)
Gas leak detector	Checking gas leak	△ Exclusive to R410A
Vacuum pump	Vacuum drying	Usable if a counter-flow preventive adapter is attached
Vacuum pump with counter flow	Vacuum drying	○ R22 (Existing article)
Flare tool	Flare processing of pipes	○ Usable by adjusting size
Bender	Bending processing of pipes	○ R22 (Existing article)
Refrigerant recovery device	Recovering refrigerant	△ Exclusive to R410A
Torque wrench	Tightening flare nut	△ Exclusive to Ø12.7 mm and Ø15.9 mm
Pipe cutter	Cutting pipes	○ R22 (Existing article)
Refrigerant canister	Charging refrigerant	△ Exclusive to R410A Enter the refrigerate name for identification
Welding machine / Nitrogen gas cylinder	Welding of pipes	○ R22 (Existing article)
Refrigerant charging balance	Charging refrigerant	○ R22 (Existing article)

3 Selection of Installation Place

Upon customer's approval, install the air conditioning apparatus in a place which satisfies the following conditions:

- Place where it can be installed horizontally.
- Place which can reserve a sufficient service space for safe maintenance or checks.
- Place where there is no problem even if the drained water overflows.

Avoid the following places:

- Salty places (seaside area) or places with much gas sulphide (hot spring area) (If selecting such a place, special maintenance is required.)
- Places where oil (including machine oil), steam, oil smoke or corrosive gas is generated.
- Places where iron or other metal dust is present. If iron or other metal dust adheres to or collects on the interior of the air conditioner, it may spontaneously combust and start a fire.
- Places where an organic solvent is used.
- Chemical plants with a cooling system using liquid carbon dioxide.
- Places where a device generating high frequency (inverter, non-utility generator, medical apparatus, or communication equipment) is set. (Malfunction or abnormal control of the air conditioner, or interference to devices listed above may occur.)
- Places unable to bear the weight of the apparatus.
- Places with poor ventilation.
- Places where ambient temperature falls below -15°C for more than 72 hours running.

4 Refrigerant Piping

■ -GAS Label

The air conditioning product contains fluorinated greenhouse gases covered by the Kyoto Protocol

Chemical Name of Gas R410A

Global Warming Potential (GWP) of Gas 1975



-
1. Stick the enclosed refrigerant label adjacent to the charging and/or recovering location.
 2. Clearly write the charged refrigerant quantity on the refrigerant label using indelible ink. Then, place the included transparent protective sheet over the label to prevent the writing from rubbing off.
 3. Prevent emission of the contained fluorinated greenhouse gas. Ensure that the fluorinated greenhouse gas is never vented to the atmosphere during installation, service or disposal. When any leakage of the contained fluorinated greenhouse gas is detected, the leak shall be stopped and repaired as soon as possible.
 4. Only qualified service personnel are allowed to access and service this product.
 5. Any handling of the fluorinated greenhouse gas in this product, such as when moving the product or recharging the gas, shall comply under (EC) Regulation No. 842/2006 on certain fluorinated greenhouse gases and any relevant local legislation.
 6. Periodical inspections for refrigerant leaks may be required depending on European or local legislation.
 7. Contact dealers, installers, etc., for any questions.
-

WARNING

- If the refrigerant gas leaks during installation, ventilate the room. If the leaked refrigerant gas comes into contact with fire, noxious gas may be generated.
- After installation, check that the refrigerant gas does not leak.
- If the refrigerant gas leaks into the room and comes into contact with fire such as a fan heater, stove, or kitchen range, noxious gas may be generated.

REQUIREMENT

- For a brazing work of the refrigerant pipes, be sure to use nitrogen gas in order to prevent oxidation of the inside of the pipes; otherwise clogging of the refrigerating cycle due to oxidized scale may occur.
- Use clean and new pipes for the refrigerant pipes and perform piping work so that water or dust does not contaminate the refrigerant.
- *Remove all flux after brazing.
- Be sure to use a double spanner to loosen or tighten the flare nut. If a single spanner is used, the required level of tightening cannot be obtained. Tighten the flare nut with the specified torque. (If it is hard to loosen or tighten the flare nut of the balance pipe or packed valve of the liquid side with a double spanner, loosen or tighten the flare nut while holding the valve mounting plate with a spanner.)

Extruding margin of copper pipe with flare tools: A (Unit: mm)

Copper pipe outer dia.	+0 A -0.4
9.5	13.2
12.7	16.6
15.9	19.7
19.1	24.0

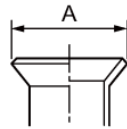

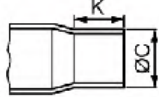
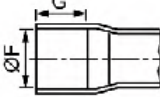
Connected section	
External size	Internal size
	

Extruding margin of copper pipe with flare machining: B (Unit: mm)

Copper pipe outer dia.	When using R410A tool	When using conventional tool
9.5 12.7 15.9 19.1	0 to 0.5	1.0 to 1.5

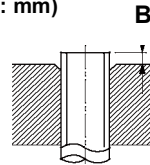

- When using the conventional flare tool, to connect R410A pipes with flaring, make a margin approx. 0.5 mm longer than that of an R22 pipe so that the flare size matches the one specified. It is convenient to use a copper pipe gauge for size adjustment of the extruding margin. Half hard or hard materials may be cracked and may cause leakage of refrigerant when it is flared.
- After flaring the connection, be sure the flared part is not damaged, deformed, uneven, or flattened, and that there are no cutting chips on it. Coupling size of brazed pipe

Standard outer dia. of connected copper pipe	Connected section					Min. thickness of coupling
	External size	Internal size	Min. depth of insertion		Oval value	
	Standard outer dia. (Allowable difference)		K	G		
	C	F				
6.35	6.35 (±0.03)	6.45 ^(+0.04) _{-0.02)}	7	6	0.06 or less	0.50
9.52	9.52 (±0.03)	9.62 ^(+0.04) _{-0.02)}	8	7	0.08 or less	0.60
12.70	12.70 (±0.03)	12.81 ^(+0.04) _{-0.02)}	9	8	0.10 or less	0.70
15.88	15.88 (±0.03)	16.00 ^(+0.04) _{-0.02)}	9	8	0.13 or less	0.80
19.05	19.05 (±0.03)	19.19 ^(+0.03) _{-0.03)}	11	10	0.15 or less	0.80
22.22	22.22 (±0.03)	22.36 ^(+0.03) _{-0.03)}	11	10	0.16 or less	0.82
28.58	28.58 (±0.04)	28.75 ^(+0.06) _{-0.02)}	13	12	0.20 or less	1.00
34.92	34.90 (±0.04)	35.11 ^(+0.04) _{-0.04)}	14	13	0.25 or less	1.20
38.10	38.10 (±0.05)	38.31 ^(+0.08) _{-0.02)}	15	14	0.27 or less	1.26
41.28	41.28 (±0.05)	41.50 ^(+0.08) _{-0.02)}	15	14	0.28 or less	1.35

Warnings on Refrigerant Leakage

Check of Concentration Limit

The room in which the air conditioner is to be installed requires a design that in the event of refrigerant gas leaking out, its concentration will not exceed a set limit.

The refrigerant R410A which is used in the air conditioner is safe, without the toxicity or combustibility of ammonia, and is not restricted by laws to be imposed which protect the ozone layer. However, since it contains more than air, it poses the risk of suffocation if its concentration should rise excessively. Suffocation from leakage of R410A is almost non-existent. With the recent increase in the number of high concentration buildings, however, the installation of multi air conditioner systems is on the increase because of the need for effective use of floor space, individual control, energy conservation by curtailing heat and carrying power etc.

Most importantly, the multi air conditioner system is able to replenish a large amount of refrigerant compared with conventional individual air conditioners. If a single unit of the multi conditioner system is to be installed in a small room, select a suitable model and installation procedure so that if the refrigerant accidentally leaks out, its concentration does not reach the limit (and in the event of an emergency, measures can be made before injury can occur).

1. In a room where the concentration may exceed the limit, create an opening with adjacent rooms, or install mechanical ventilation combined with a gas leak detection device. The concentration is calculated as detailed below.

$$\frac{\text{Total amount of refrigerant (kg)}}{\text{Min. volume of the indoor unit installed room (m}^3\text{)}} \leq \text{Concentration limit (kg/m}^3\text{)}$$

The concentration limit of R410A which is used in multi air conditioners is 0.3 kg/m³.

▼ NOTE 1

If there are 2 or more refrigerating systems in a single refrigerating device, the amounts of refrigerant should be as charged in each independent device.

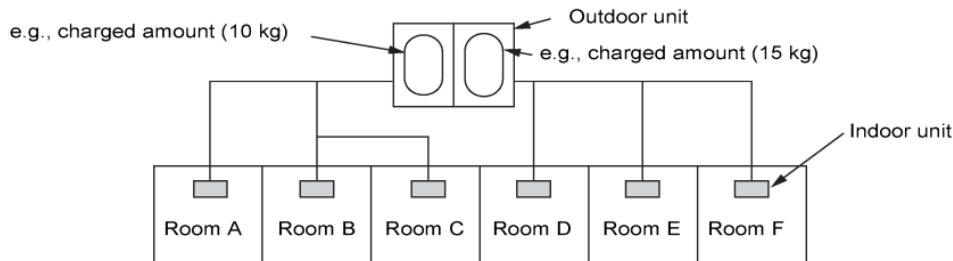

For the amount of charge in this example:

The possible amount of leaked refrigerant gas in rooms A, B and C is 10 kg. The possible amount of leaked refrigerant gas in rooms D, E and F is 15 kg.

▼ NOTE 2

The standards for minimum room volume are as follows. 1) No partition (shaded portion)

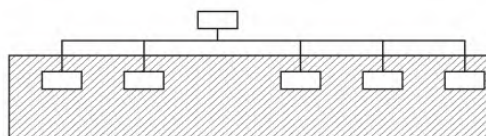

IMPORTANT

2. When there is an effective opening with the adjacent room for ventilation of leaking refrigerant gas (opening without a door, or an opening 0.15 % or larger than the respective floor spaces at the top or bottom of the door).

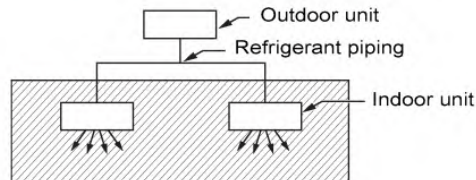

3. If an indoor unit is installed in each partitioned room and the refrigerant piping is interconnected, the smallest room of course becomes the object. But when a mechanical ventilation is installed interlocked with a gas leakage detector in the smallest room where the density limit is exceeded, the volume of the next smallest room becomes the object.

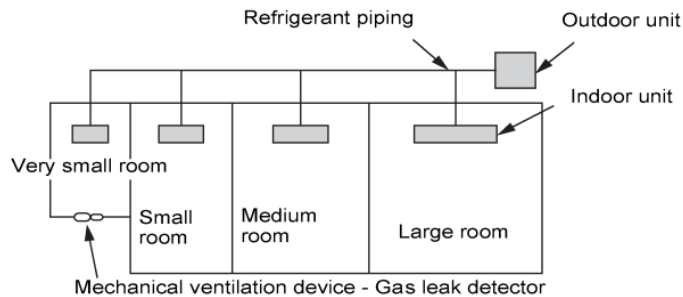

▼ NOTE 3

The minimum indoor floor area compared with the amount of refrigerant is roughly as follows: (When the ceiling is 2.7 m high)

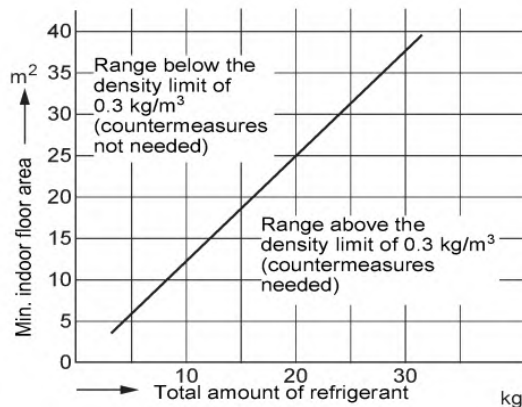

5 Electric wiring

WARNING

The appliance shall be installed in accordance with national wiring regulations.
Capacity shortages of the power circuit or an incomplete installation may cause an electric shock or fire.

CAUTION

- Perform wiring of power supply complying with the rules and regulations of the local electric company.
- Refer to H07RN-F or 60245 IEC 66 regarding specifications of the power supply wire.
- Do not connect 380 V - 415 V power to the terminal blocks for control cables (U1, U2, U3, U4, U5, U6); otherwise, the unit may break down.
- Be sure that electric wiring does not come into contact with high-temperature parts of piping; otherwise, the coating of cables may melt and cause an accident.
- After connecting wires to the terminal block, take off the traps and fix the wires with cord clamps.
- Follow the same structure for both the control wiring and refrigerate piping.
- Do not conduct power to indoor units until vacuuming of the refrigerant pipes has finished.
- Refer to the installation manuals of indoor unit and flow selector unit for power wiring and communication wiring of indoor unit and flow selector unit.
- Communication wiring and central control wiring use 2-core non-polarity wires. Use 2-core shield wires to prevent noise trouble.
- Connecting the closed end terminal of shield wire. (Connected to all connecting sections in each unit)
- Use 2-core non-polarity wire for remote controller. (A, B terminals) Use 2-core non-polarity wire for wiring of group control. (A, B terminals)

Table-1 Communication wiring between indoor and outdoor units (L1, L2, L3), Central control wiring (L4)

Wiring	2-core, non-polarity
Type	Shield wire
Size / Length	1.50mm ² (min. 1.25 mm ²): Up to 1000m 2.50mm ² (min. 2.00 mm ²): Up to 2000m (*1)

(*1): Total length of Communication wiring length for all refrigerant circuits (L1 + L2 + L3 + L4)

Table-2 Communication wiring between outdoor units (L5)

Wiring	2-core, non-polarity
Type	Shield wire
Size / Length	1.50mm ² (min. 1.25 mm ² to 2.0 mm ²) up to 100m (L5)

Table-3 Remote controller wiring (L6, L7)

Wire	2-core, non-polarity
Size	1.50mm ² (min. 0.5 mm ² to 2.0 mm ²)
Length	Up to 500m (L6 + L7) Up to 400m in case of wireless remote controller in group control. Up to 200m total length of communication wiring between indoor units L6

6 Installation Examples

Example of Refrigerant Monitoring & Detection

RBC-RD6-PE

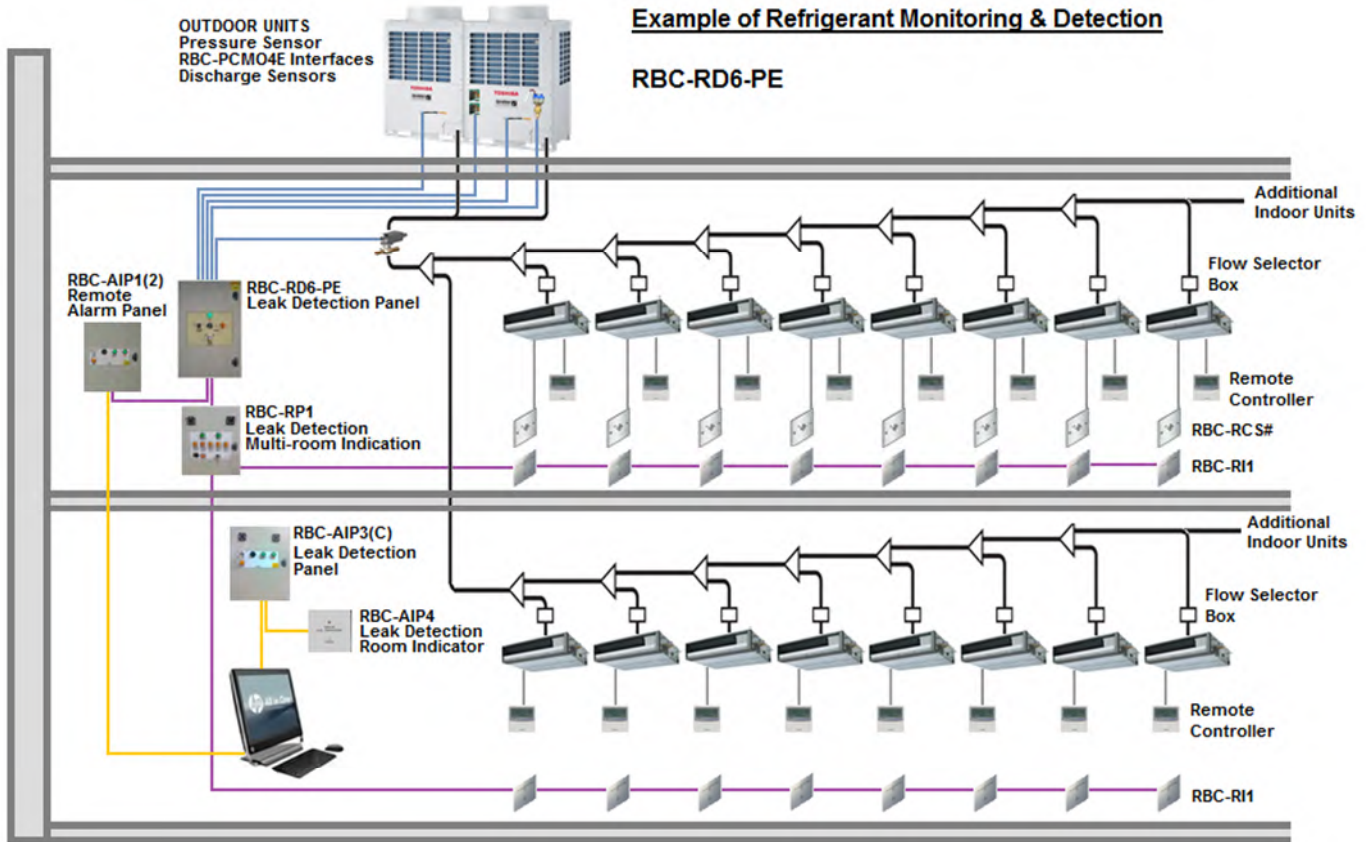

Example of Refrigerant Monitoring & Detection

**RBC-RD6-DI
RBC-RD7**

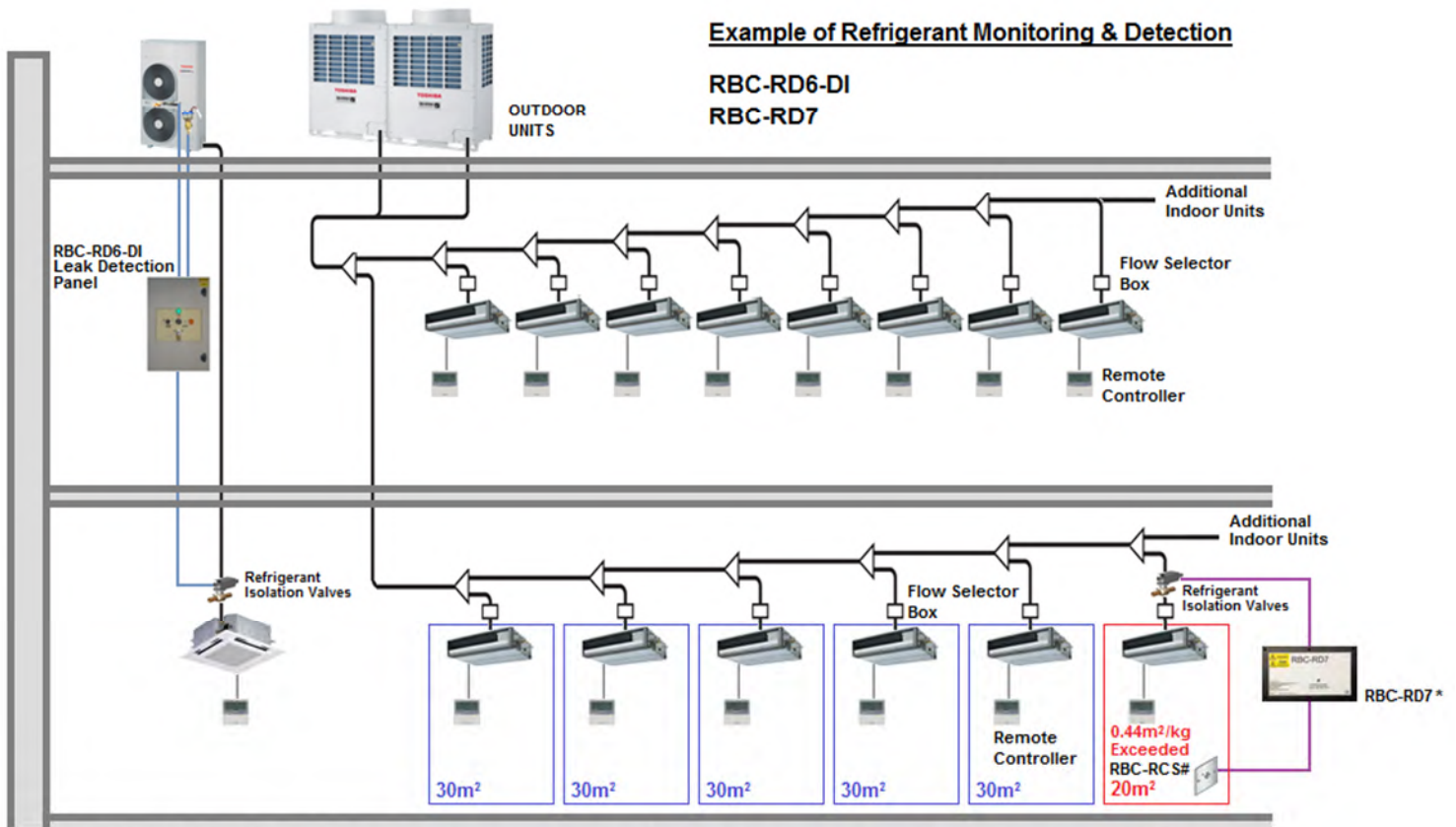

* RBC-RD7 enables isolation of a single Indoor Unit and continuous operation of unaffected system(s) with significant cost saving versus RBC-RD6

7 Control Schematic

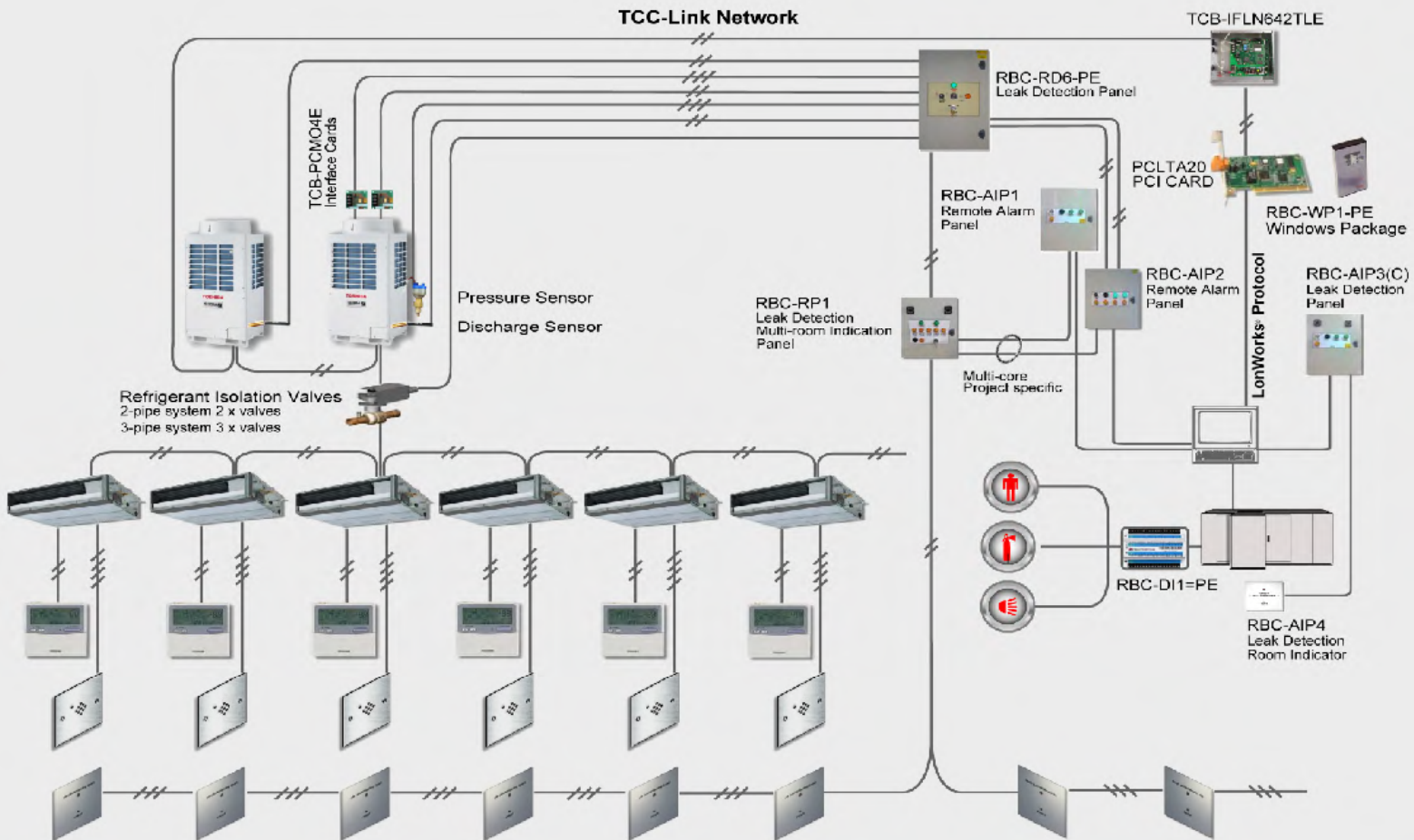

Optional Detection Methods:

-  RBC-RCS#
Refrigerant Sensor(s)
Connects to Indoor PCB
-  RBC-RCS#
Floor Leak Detection Indicator
Connects to RBC-RD6#
Max. 4 Circuits / Max. 10 per Circuit

Example
Interactive Intelligence System with
Refrigerant Leak Detection & Monitoring

8 Specification

LEAK DETECTION PANEL		RBC-RD6	RBC-RD6-DI			RBC-RD7
LEAK DETECTION PANEL						
LEAK DETECTION REPEATER PANEL (MULTI-ROOM INDICATION)				RBC-RP1		
REFRIGERANT LEAK DETECTOR						
LEAK DETECTION ROOM INDICATOR					RBC-R11	
PRODUCTS		VRF	RAV-DI/SDI	VRF - RAV DI/SDI	VRF - RAV DI/SDI	VRF - RAV DI/SDI
Standard Rating	(IP)	65		40	40	50
Enclosure		Metal		Metal	Plastic	Plastic
Colour		Light grey RAL 7035		Light grey RAL 7035	White	Black
Colour Cost Option Upgrade	(Various)	-		-	Facia Plate	-
Height	(mm)	600		500	92	114
Width	(mm)	400		400	92	194
Depth	(mm)	200		150	60	62
Weight	(kg)	12		15	0.2	700
Isolating Gas Valve (Supplied Loose)	(mm)	Bespoke per application	-	-	-	-
Isolating Liquid Valve (Supplied Loose)	(mm)	Bespoke per application		-	-	Bespoke per application
Isolating Suction Valve (Supplied Loose)	(mm)	Bespoke per application		-	-	Bespoke per application
Sensor(s) Type (Supplied Loose)		Discharge pipe sensing		-	-	-
Interface Cards (Supplied Loose)		2 x TCB-PCM04E	-	-	-	-
		Sockets CN510 & CN512		-	-	-
Option BMS Interface Card (Panel Fitted)		-	RBC-FDP3	-	-	-
Audible Alarm		Yes		Yes	Yes	-
Audible Alarm Sound Level	(dB)	-		-	95 (3400Hz ±500)	-
Alarm Mute		Yes (Key Switch)		Yes	Mute Button / Powered OFF	-
Visual Indicator (Neon)		Live		Live	Yes	Leak Detected
		Alarm		Healthy		
				Alarm		
Fault Code Generated To Local Remote Controller		-		-	-	-
Interconnecting Multi-core Cable Length / Fused	(m)	-		-	-	-
Interconnecting Cable Max. Length	(m)	12	12	100	100	24
Interconnecting Cable Type	(mm ²)	0.75	0.75	3 core 1.5	3 core 1.5	0.5
Interconnecting Cable Type Remote Indication		-		2 core 0.75	-	-
Control Circuit Power	(Volts)	24	24	24	24 (via RP1)	-
Power Supply		1 phase 230v 50Hz	1 phase 230v 50Hz	1 phase 230v 50Hz	-	1 phase 230v 50Hz
Power Consumption Min. / Max.	(mA)	-		-	-	-
Suggested Fused Supply	(Amps)	3	3	6	(via RP1)	1
Interface Card(S) (Required Accessory) *Max. 4 Circuits		-		*RBC-R11	-	-
In Room Detector (Required Accessory) *Max. 10 per Circuit		-		*RBC-RD3 / RCS1 / RCS2	-	*RBC-RD3 / RCS1 / RCS2
Circuit Protection Fuse Supplied With Cable		-		-	-	-
Cable Link For Remote ON / OFF (Ving Card)		-		-	-	-
Screw Terminal Connections		-		-	-	-
Fail Safe Relay Operation		-		-	-	-
Mounting Height Above Floor Level	(mm)	-		-	-	-
On-site Commissioning Support		-		-	-	-

			RBC-AIP1	RBC-AIP2	RBC-AIP3	RBC-AIP3C	
RBC-RD3	RBC-RCS1	RBC-RCS2					RBC-AIP4
ALL COMMON HFC's	ALL COMMON HFC's	ALL COMMON HFC's	VRF - RAV DI/SDI	VRF - RAV DI/SDI	VRF - RAV DI/SDI	VRF - RAV DI/SDI	VRF - RAV DI/SDI
Surface Mounted	Recessed	Recessed	30	30	40	40	40
Plastic	Plastic	Steel	Metal	Metal	Metal	Metal	Plastic
White	White	Stainless	Light grey RAL 7035	Light grey RAL 7035	Light grey RAL 7035	Light grey RAL 7035	White
Facia Plate	Facia Plate	Facia Plate	-	-	-	-	Facia Plate
85	85	85	500	500	500	500	92
85	85	85	400	400	400	400	92
32	32	32	150	150	150	150	60
0.085	0.085	0.085	15	15	15	15	0.2
-	-	-	-	-	-	-	-
-	-	-	-	-	-	-	-
-	-	-	-	-	-	-	-
-	-	-	-	-	-	-	-
-	-	-	-	-	-	-	-
-	-	-	-	-	-	-	-
-	-	-	-	-	-	-	-
Yes	Yes	Yes	Yes	Yes	Yes	Yes	Yes
85 (2300Hz ±300)	85 (2300Hz ±300)	85 (2300Hz ±300)	95 (3400Hz ±500)	95 (3400Hz ±500)	95 (3400Hz ±500)	95 (3400Hz ±500)	95 (3400Hz ±500)
Powered OFF	Powered OFF	Powered OFF	Yes (Key Switch)	Yes (Key Switch) & Remote	Yes (Key Switch)	Yes (Key Switch)	Mute Button / Powered OFF
3-coloured LED	3-coloured LED	3-coloured LED	Live	Live	Live	Live	Yes
			Healthy	Healthy	Healthy	Healthy	
			Alarm	Alarm	Alarm	Alarm	
L30	L30	L30	-	-	-	-	-
10 / Yes	10 / Yes	10 / Yes	-	-	-	-	-
-	-	-	100	100	3	3	100
-	-	-	3 core 1.5	3 core 1.5	USB	USB	3 core 1.5
-	-	-	-	2 core 0.75	-	-	-
12-24 AC/DC	12-24 AC/DC	12-24 AC/DC	24	24	24	24	24 (via RP1)
Local indoor unit PCB	Local indoor unit PCB	Local indoor unit PCB	1 phase 230v 50Hz	1 phase 230v 50Hz	Battery Back-up	Battery Back-up	-
40 / 100	40 / 100	40 / 100	-	-	-	-	-
-	-	-	6	6	-	-	(via RP1)
-	-	-	inc. RBC-DI1	inc. RBC-DI1	-	-	-
-	-	-	-	-	-	-	-
Yes	Yes	Yes	-	-	-	-	-
Yes	Yes	Yes	-	-	-	-	-
5	5	5	-	-	-	-	-
Yes	Yes	Yes	-	-	-	-	-
150	150	150	-	-	-	-	-
-	-	-	-	-	Half Day Included	Full Day Included	-

18 RBC-AIP4 Remote Room Indicator



The RBC-AIP4 remote room Indicator is designed to work in conjunction with the Toshiba RBC-AIP3 Indicator panel. In the event of the RBC-AIP3 panel activation the RBC-AIP4 remote room Indicator will signal an audible/visual alarm.

Part Name	Qty	Shape	Usage
Control Panel	1		Panel with visual & audible alarm

Precautions for Safety

- Read these "Precautions for Safety" carefully before installation work.
- The precautions described below include important items regarding safety. Observe them without fail. Understand the following details (indications and symbols) before reading the body text, and follow the instructions.

The meanings of indications

 WARNING	Text set off in this manner indicates that failure to adhere to the directions in the warning could result in serious bodily harm or loss of life if the product is handled improperly.
 CAUTION	Text set off in this manner indicates that failure to adhere to the directions in the caution could result in serious bodily injury or damage to property if the product is handled improperly.

- After completion of installation, perform trial operation to check for any problems. Explain method of use and maintenance to the customer by following the descriptions in the manual. Ask customer to keep this Manual at accessible place for future reference.

WARNING

- Only a qualified installer or qualified service person is allowed to do installation work. If installation is carried out by an unqualified individual, fire or electric shock may result.
- Perform installation work reliably according to this installation manual. Incomplete installation may cause electric shock, fire or abnormal operation.
- Electrical work must be performed by a qualified installer or qualified service person in accordance with this installation manual. The work must satisfy all local, national and international regulations. Inappropriate work may result in electric shock or fire.
- Connect the specified wires firmly and clamp them securely so that external force applied to the wires does not affect the connector pins. Improper wire connection or clamping may result in fire or malfunction.
- Do not disassemble, modify, repair or move the product yourself. Doing so may cause fire, electric shock, injury or water leaks.
- Ask a qualified installer or qualified service person to do any repairs or to move the product.

Dimensions

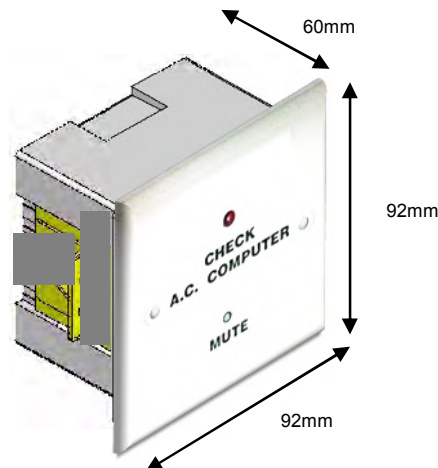

Mounting the Control Panel

1. The RBC-AIP4 is supplied in a 47mm deep single dry lining box.
2. It should be mounted in a prominent location

CAUTION

Toshiba will not accept any liability for scratched or damaged Indicator facia cause through mishandling or poor installation. Take care when accessing and removing facia from fixing box.

- The RBC-AIP4 must connect to the RBC-AIP3 Leak Detection monitoring panel of the associated refrigerant system.
- The computer connected to the RBC-AIP3 Leak Detection panel must be operating the Toshiba RBC-WP1 Interactive Intelligence Windows software program.

Details of Operation and Wiring

24V (-)
DC (+)



- Connect the room sensor to the RBC-AIP3 Leak Detection Panel using 3 core a 0.75mm² cable
- Connect the RBC-AIP3 link wire terminal 7 to the (+) connection on the RBC-AIP4 remote room indicator
- Connect the RBC-AIP3 link wire terminal 8 to the (-) connection on the RBC-AIP4 remote room indicator

RBC-AIP3 - Control Circuit Wiring

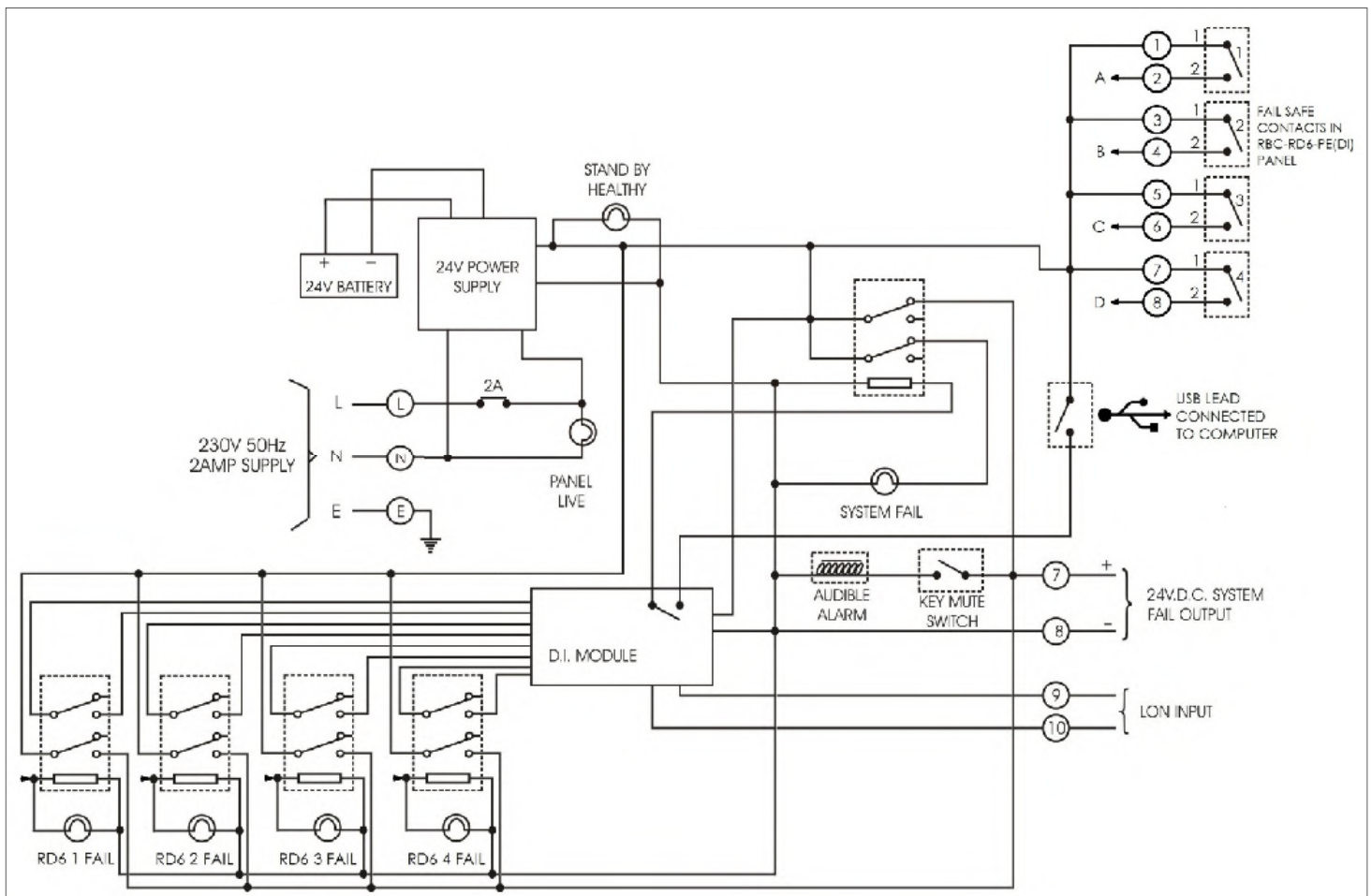

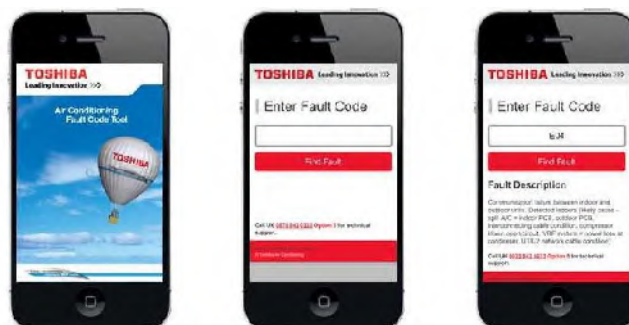

Fault code diagnosis apps now available
Platforms are Apple iPhone & Android



24 Hour Technical Helpline: 0870 843 0333
Fault & DN Code Apps: Android & iPhone
Web Page toshiba-calc.co.uk/fault-codes/
Fault Code Text Service: 07624 803 017
technical.enquiries@toshiba-ac.com

Technical Department

TOSHIBA

AIR CONDITIONING

A division of Toshiba Carrier UK Limited
Parkfield House, Manchester Old Road, Middleton, Manchester, M24 4DY

www.toshiba-aircon.co.uk

Tel: 44 (0) 870 843 0333 Fax: 44 (0) 161 794 4743