

MMU-UP_WH 2-WAY CASSETTE



Slim, compact and lightweight, the 2-Way Cassette has been designed to fit easily and discreetly into any room interior.

CAPACITY



0.8HP < 6HP

SOUND PRESSURE LEVEL



30dB(A)

OUTDOOR UNITS COMPATIBILITY



Side Blow & Mini SMMS-e SMMS-u SMMS-e SHRM-e

LOCAL CONTROLS



RBC-AXU31UW-E RBC-AXU31-E RBC-ASCU11-E RBC-AMTU31-E RBC-AMSU51-EN/ES

Features

Model name	MMU-UP0071WH-E	UP0091WH-E	UP0121WH-E	UP0151WH-E	UP0181WH-E	UP0241WH-E	UP0271WH-E	UP0301WH-E	UP0361WH-E	UP0481WH-E	UP0561WH-E								
Capacity code	HP	0.8	1	1.3	1.7	2	2.5	3	3.2	4	5	6							
Cooling capacity	kW	2.2	2.8	3.6	4.5	5.6	7.1	8.0	9.0	11.2	14.0	16.0							
Heating capacity	kW	2.5	3.2	4.0	5.0	6.3	8.0	9.0	10.0	12.5	16.0	18.0							
Electrical characteristics	Power supply	1 phase 50Hz 220-240V / 1 phase 60Hz 220V (Separate power supply for indoor units is required.)																	
	Running current	50 Hz	A	0.23	0.23	0.23	0.24	0.32	0.39	0.39	0.46	0.48	0.57	0.75					
	Power consumption H/L	kW	0.029 / 0.026	0.029 / 0.026	0.029 / 0.026	0.03 / 0.026	0.044 / 0.037	0.054 / 0.045	0.054 / 0.045	0.064 / 0.062	0.073 / 0.60	0.088 / 0.07	0.117 / 0.089						
Appearance	Starting current	A	0.35	0.35	0.35	0.36	0.48	0.59	0.69	0.72	0.86	1.13							
	Main unit	Heat-insulating material attached Zinc hot dipping steel plate																	
	Ceiling panel Model	RBC-UW283PG(W)-E			RBC-UW803PG(W)-E				RBC-UW1403PG(W)-E										
Outer dimensions	Panel colour	Moon white_(Munsell 2.5GY9.0/0.5)																	
	Main unit HxLxP	mm	295x815x570			345x1180x570				345x1600x570									
	Ceiling panel HxLxP	mm	20x1050x680			20x1415x680				20x1835x680									
Total weight	Main unit	kg	19	19	19	19	26	26	26	36	36	36							
	Ceiling panel	kg	10	10	10	10	10	14	14	14	14	14							
Heat exchanger	Finned tube																		
Soundproof / Heat-insulating material	Non-flammable insulation																		
Fan unit	Fan	Turbo fan						Centrifugal fan											
	Standard air flow (High/Mid/Low)	m ³ /h	558 / 498 / 450			600/534/ 450		900/750/ 618		1050 / 840 / 738		1250/900/ 780		1740/1434/ 1182		1800/1482/ 1230		2040/1578/ 1320	
	Motor output	W	20			30		40		50		70							
Sound pressure level (High/Mid/Low)	dB(A)	34 / 32 / 30			35 / 33 / 30		38 / 35 / 33		40/37/34		42/39/36		43/40/37		46/42/39				
Sound power level (High)	dB(A)	49			50		53		55		57		58		61				
Air filter	Standard filter (Long life filter)																		
Controller	Infrared or wired remote controller																		
Connecting pipe	Gas pipe	inch	3/8"	3/8"	3/8"	1/2"	1/2"	5/8"	5/8"	5/8"	5/8"	5/8"	5/8"						
	Liquid pipe	inch	1/4"	1/4"	1/4"	1/4"	1/4"	3/8"	3/8"	3/8"	3/8"	3/8"	3/8"						
	Drain port (Nominal dia.)	mm	25 (Polyvinyl chloride tube)																

Drawings

Unit: mm

MMU-UP0071WH-E to MMU-UP0151WH-E

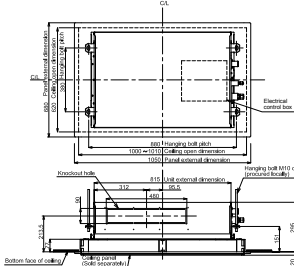

MMU-UP0181WH-E to MMU-UP0301WH-E

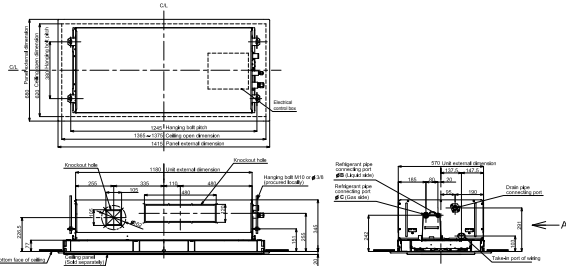

MMU-UP0361WH-E to MMU-UP0561WH-E

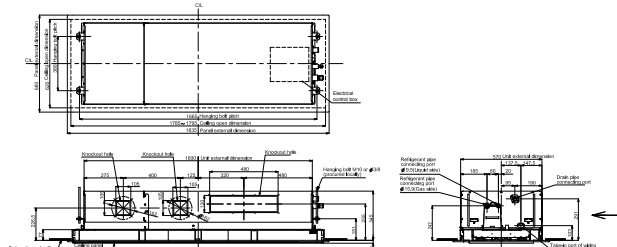

Sound pressure levels

Unit: dB(A)

MMU-UP0071WH-E, UP0091WH-E, UP0121WH-E

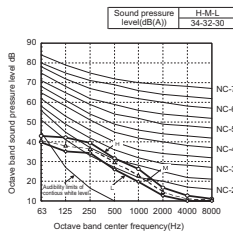

MMU-UP0151WH-E

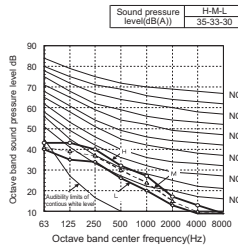

MMU-UP0181WH-E

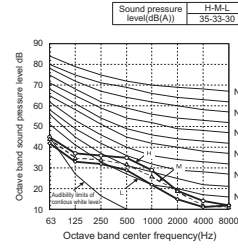

MMU-UP0241WH-E, UP0271WH-E

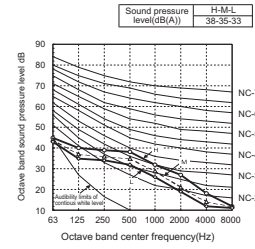

MMU-UP0301WH-E

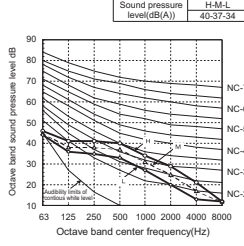

MMU-UP0361WH-E

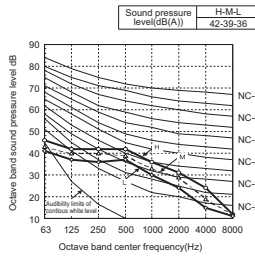

MMU-UP0481WH-E

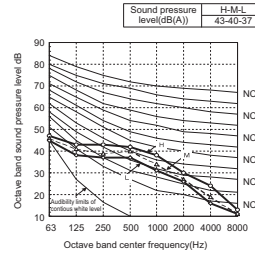

MMU-UP0561WH-E

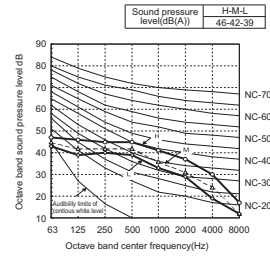

Air diffusion

Unit: m/s

MMU-UP0071WH-E/UP0091WH-E, UP0121WH-E, UP0151WH-E

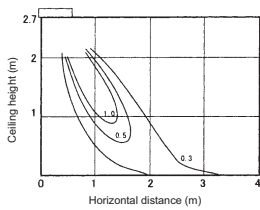

MMU-UP0181WH-E

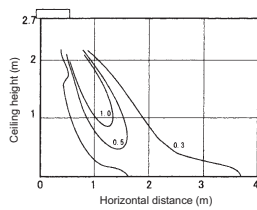

MMU-UP0241WH-E, UP0271WH-E

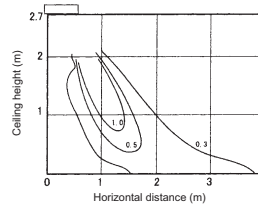

MMU-UP0301WH-E

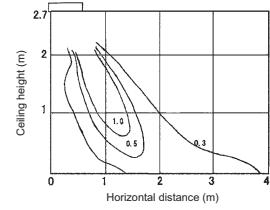

MMU-UP0361WH-E, UP0481WH-E

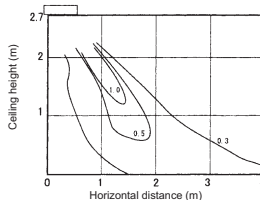

MMU-UP0561WH-E

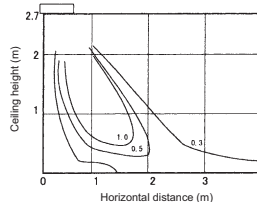

Accessories

No	Part name	Model name	Applied model	Notes	Remarks
1	Ceiling panel	RBC-UW283PG(W)-E	MMU-UP0071 to 0151WH	Required accessory	
		RBC-UW803PG(W)-E	MMU-UP0181 to 0301WH		
		RBC-UW1403PG(W)-E	MMU-UP0361 to 0561WH		
2	Super long life filter	TBC-LF283UW-E	MMU-UP0071 to 0151WH	Dust collecting effect: 50% (Weight method)	Use with TBC-FC283UW-E
		TBC-LF803UW-E	MMU-UP0181 to 0301WH		Use with TBC-FC803UW-E
		TBC-LF1403UW-E	MMU-UP0361 to 0561WH		Use with TBC-FC1403UW-E
3	Filter chamber	TBC-FC283UW-E	MMU-UP0071 to 0151WH	For super long life filter	
		TBC-FC803UW-E	MMU-UP0181 to 0301WH		
		TBC-FC1403UW-E	MMU-UP0361 to 0561WH		
4	Auxiliary fresh air flange	TBC-FF151US-E	MMU-UP0071 to 0561WH	For fresh air intake by using the knockout hole of indoor unit.	

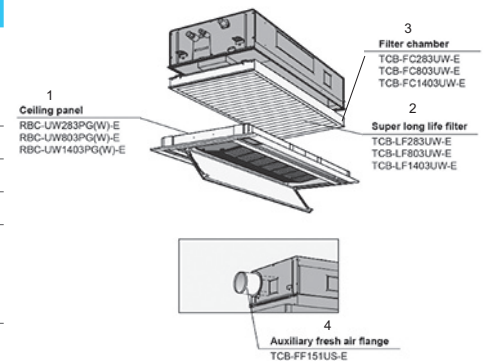

2-way cassette connectors

CN32	CN60	CN61	CN70	CN73	CN80
Additional ventilation control from remote control	Operation status signal output (cooling, heating, fan, defrost, thermo-on)	External On/Off, operation output and alarm output	Warning symbol on remote control based on signal input. No IDU thermo off.	Forced IDU thermo-off based on signal input	Forced IDU thermo-off and IDU lock based on signal input
•	•	•	•	•	•

