

Wall hung boilers

VISION PLUS 30S

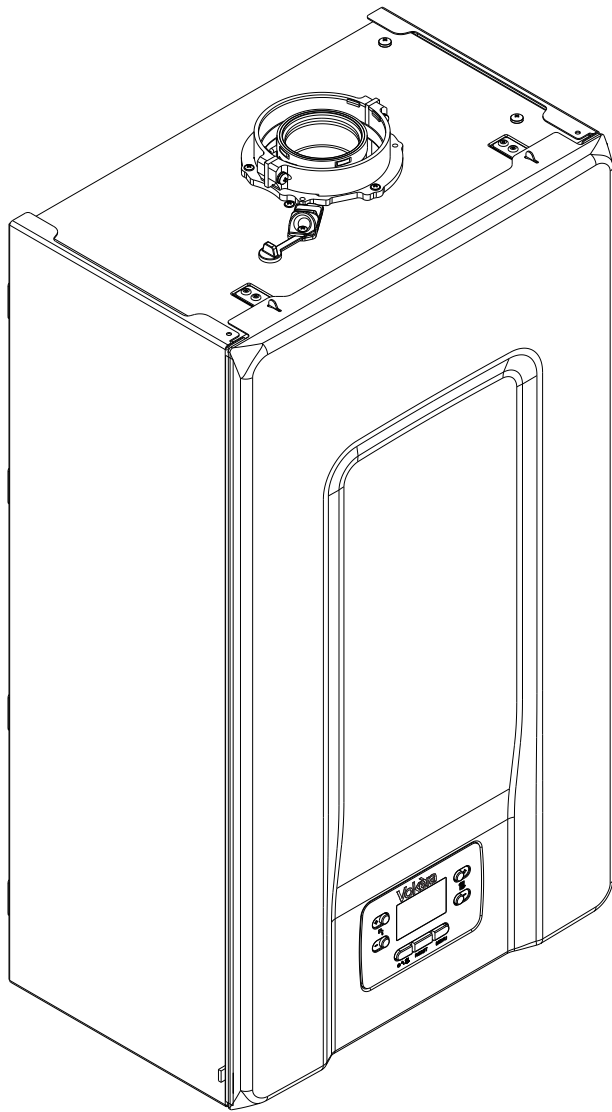

MODEL	PART NUMBER	
	MTN	GPL
Vision Plus 30S	20174729	-

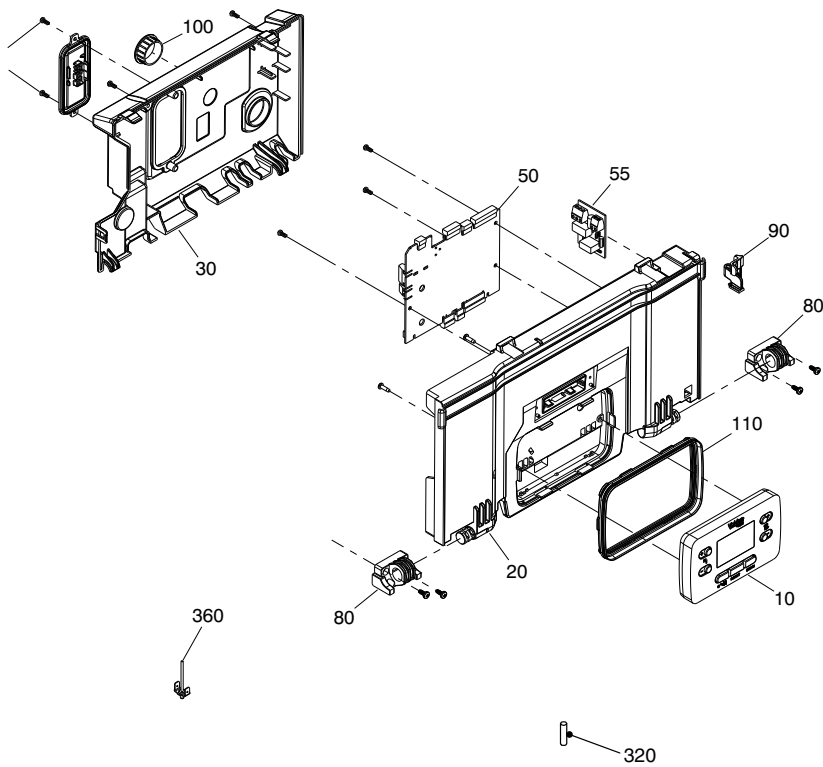
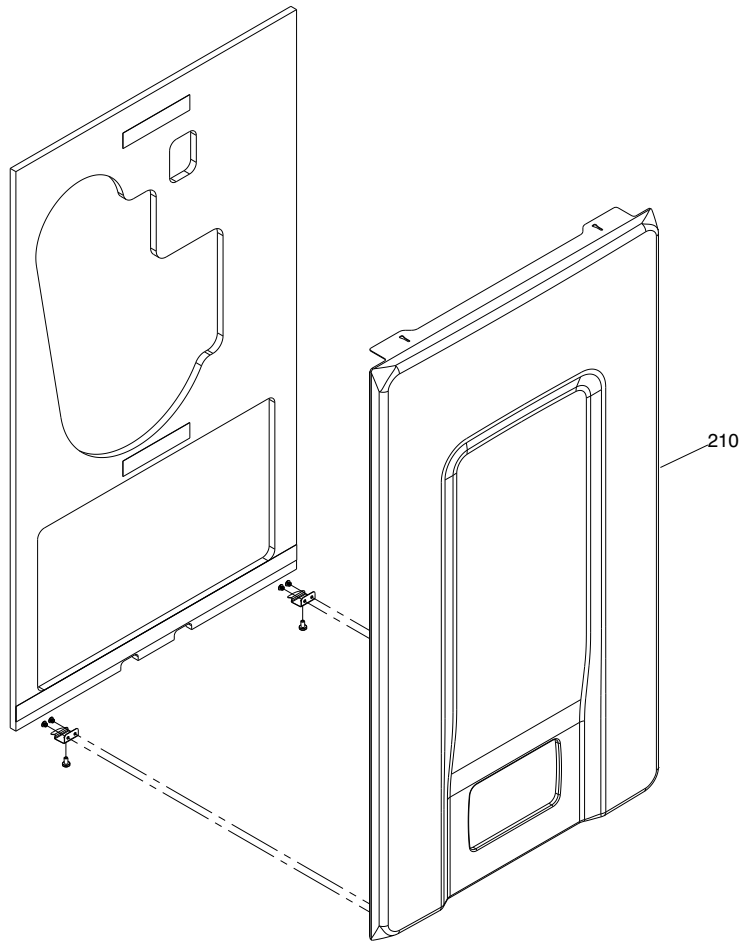

POS.	DESCRIPTION	30S
10	Control panel	20181023
20	Instrumental panel	20154280
30	Electric parts cover	20154281
50	Control board	20178237
55	Printed circuit board	20076436
80	Rolling hinge	20123231
90	Instrumental panel fastener	20123230
110	Shaped gasket	20123240
210	Front panel	20178204
320	Fuse	R3478
360	Ground rivet	20154023

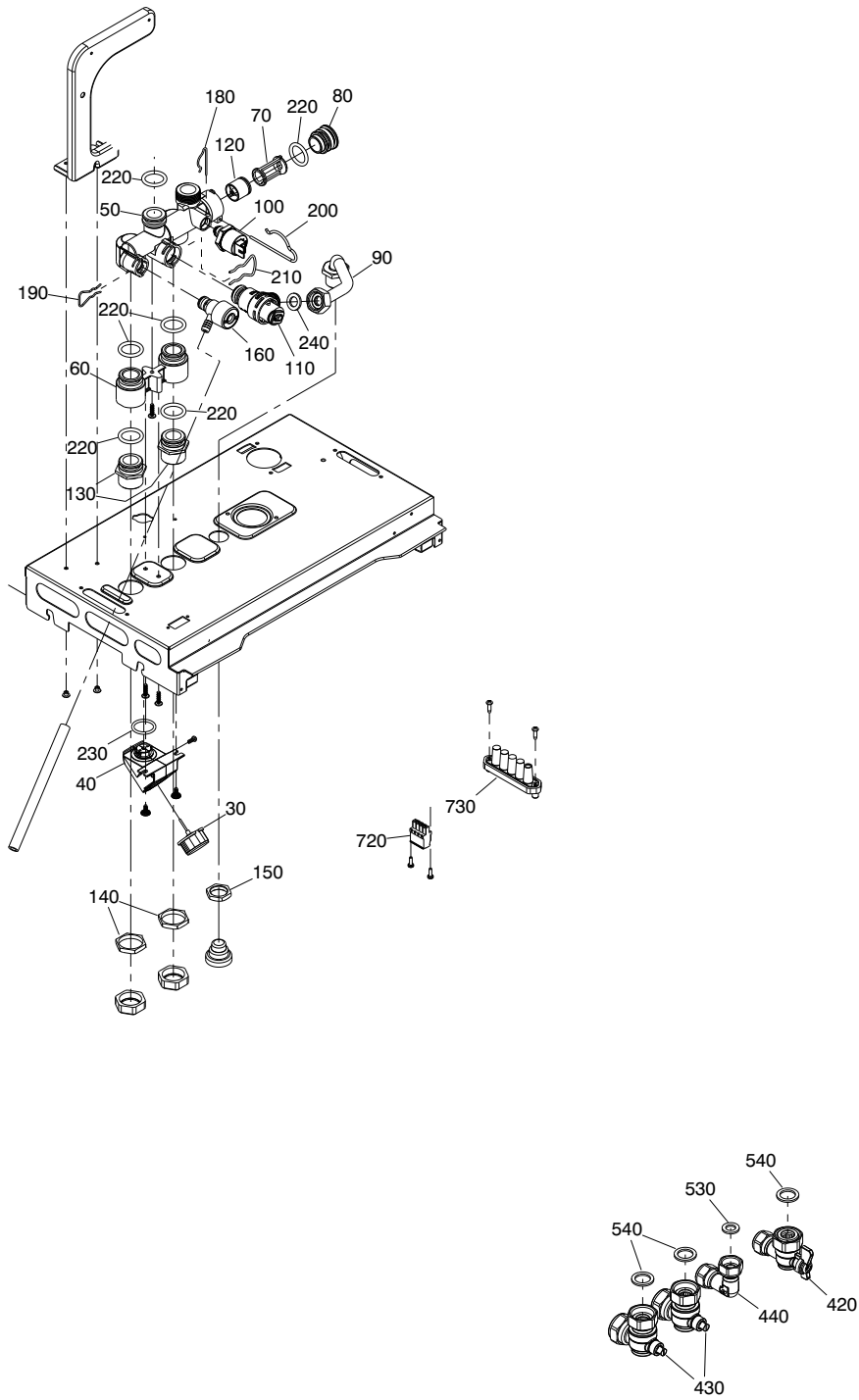

POS.	DESCRIPTION	30S
30	Quick primer pressure gauge	20049617
40	Water gauge carrier	20123121
50	Heating distrib.	20005568
60	Hydraulic connection	20130718
70	by-pass valve support	20068965
80	Automatic by-pass plug	R10024645
90	Pipe	20130719
100	Pressure transducer	20024559
110	Safety valve	20043820
120	High head by-pass valve	R1552
130	Connection	20014074
140	3/4" locknut	R4026
150	1/2" lock nut	R4274
160	Cock	20000533
180	Clip	R2165
190	Clip	20000539
200	Clip	R2223
210	Clip	R10025062
220	O-ring	R6898
230	O-ring	R10023533
240	Washer	R10023698
420	Heating cock	20132650
430	Heat water cock	20132653
440	Angle pipe	20132654
530	Washer	R5026
540	Washer	R5023
720	4-pin connector	20154287
730	Five positions fairlead	20123125

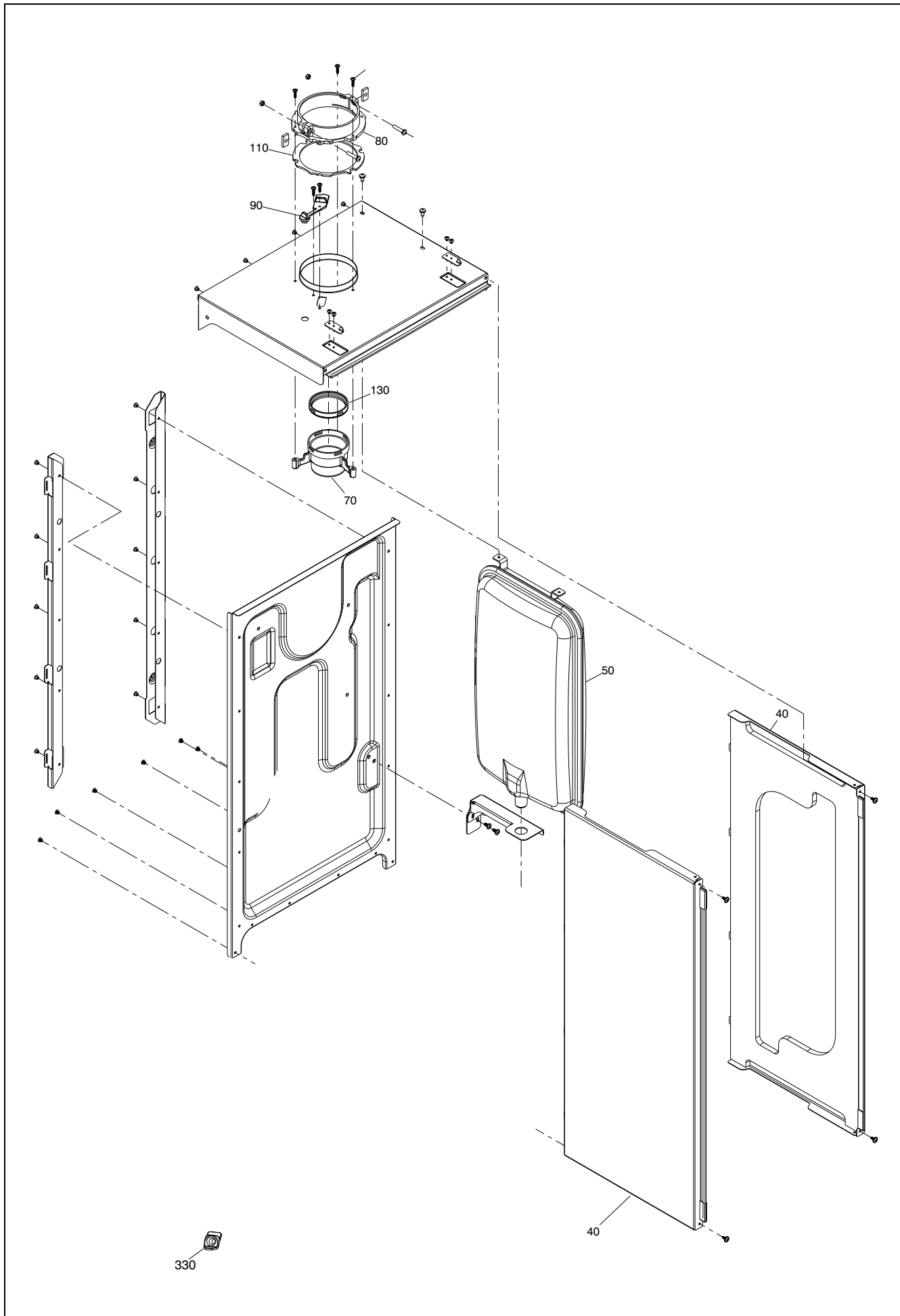

POS.	DESCRIPTION	30S
40	Side panel	20135296
50	9 lt. expansion tank	20135958
70	Flue drain connection	R10028421
80	Fumes flange	20157132
90	Cap smoke analysis	20157134
110	Flange gasket	20157133
130	Washer Ø 60	R10026345
330	Cap smoke analysis	20171129

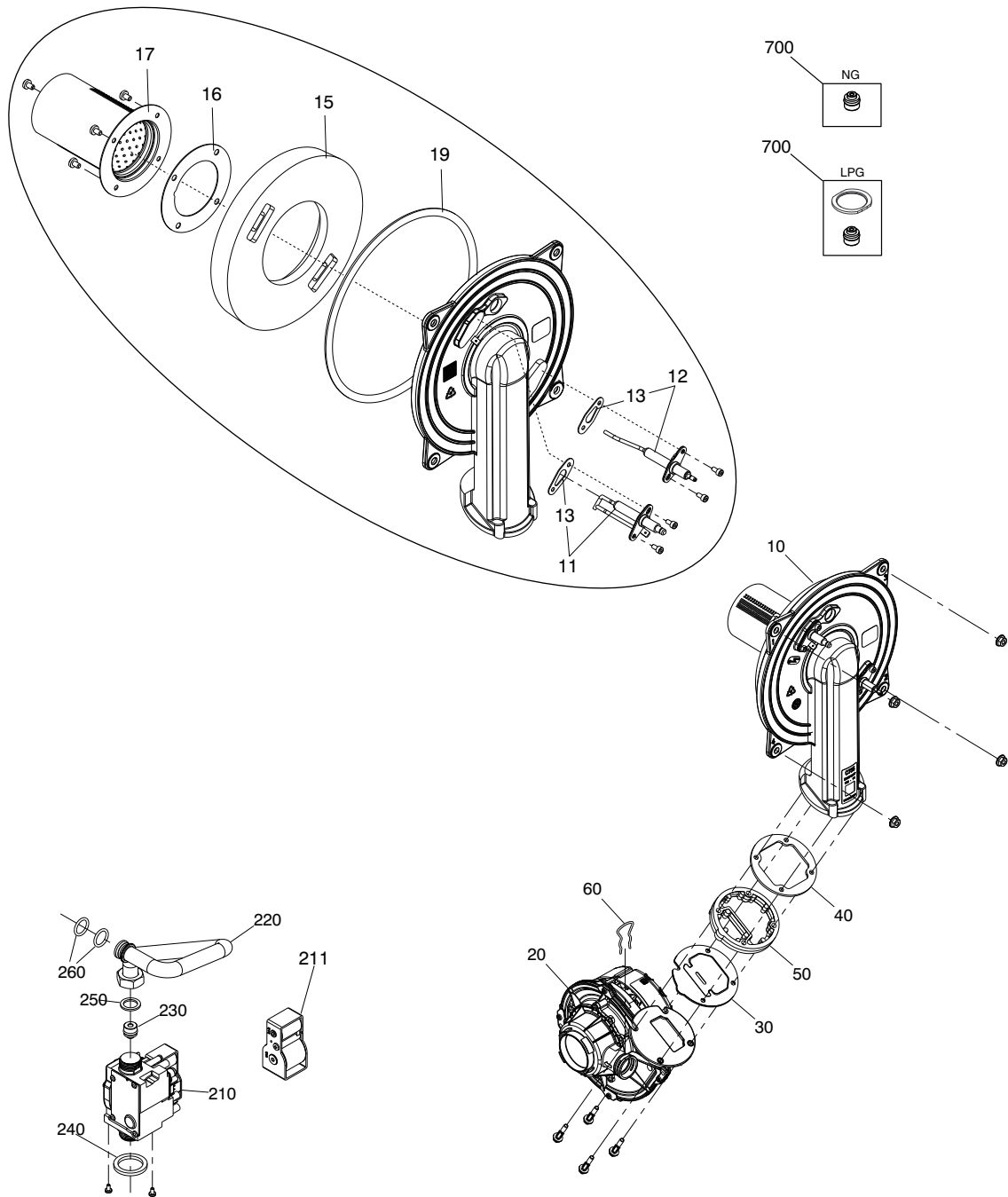

POS.	DESCRIPTION	30S
10	Air/gas conveyor	20177651
11	Ignition electrode	20135946
12	Sensing electrode	20135947
13	Electrode seal	20157191
15	Insulation panel	20177648
16	Seal burner	20135949
17	Premix burner	20136089
19	Washer	20135951
20	Integrated fan	20136075
30	Non return valve	20169395
40	Washer	20135952
50	Spacer	20177790
60	Clip	R10025062
210	Gas valve	20039202
211	Gas valve solenoid	20040675
220	Pipe	20181036
230	gas diaphragm	R10029209
240	Gasket	20123159
250	Washer	R5023
260	Washer	20024869
700	LPG conversion kit	20080711
700	Ng conversion kit	20167315

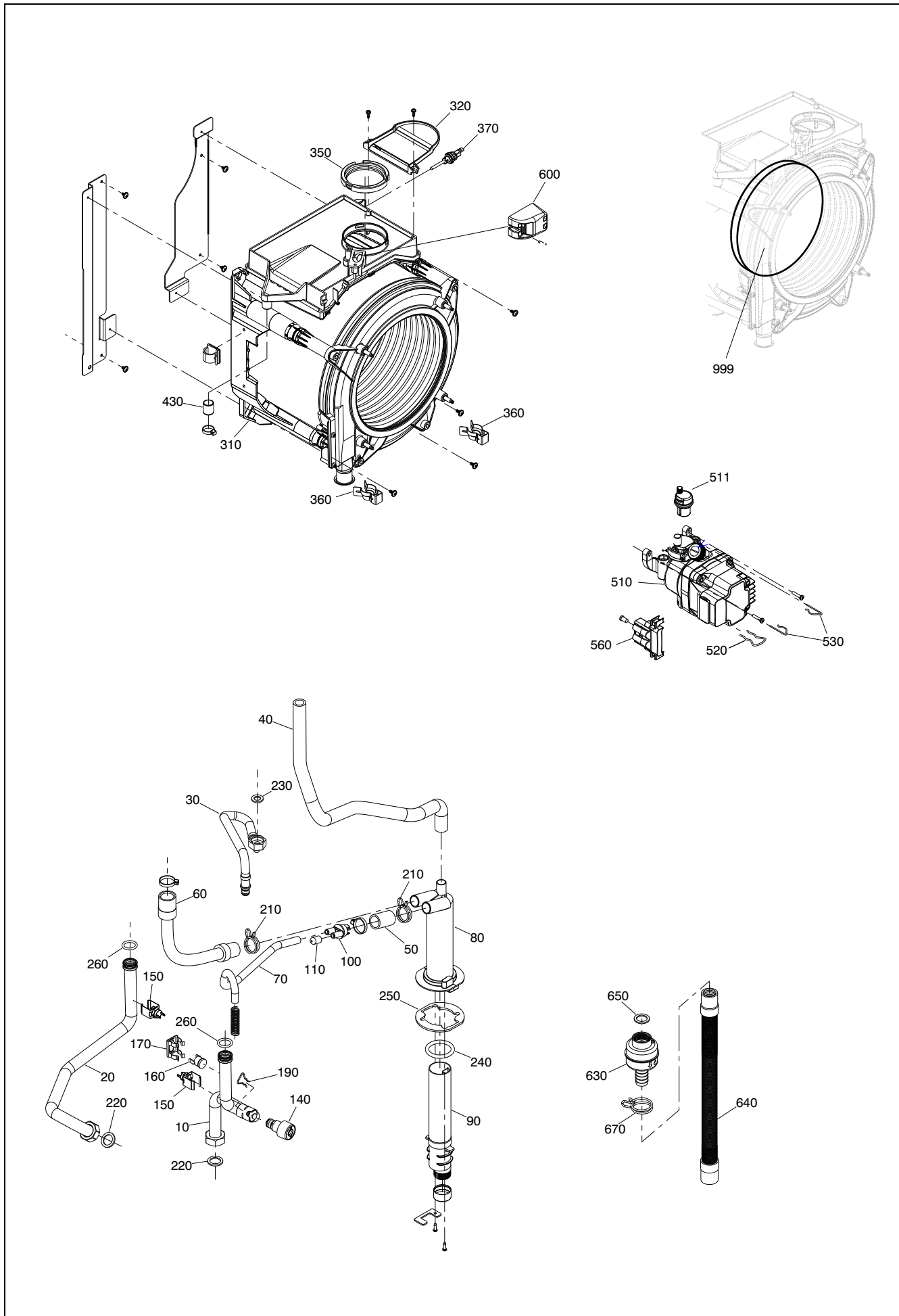

POS.	DESCRIPTION	30S
10	Pipe	20181038
20	Pipe	20154283
30	Pipe	R10025188
40	Condensation outlet tube	20139779
50	Pipe	20135786
60	Condensation outlet pipe	20169396
70	Tube kit	20136087
80	Trap upper body	20123188
90	Trap lower body	20123189
100	Adapter siphon condensate drain	20135945
110	Plug	20081059
140	Cock	20000533
150	NTC Detector	20078350
160	High limit thermostat	20005585
170	Clip	R5472
190	Clip	20000539
210	Hose clamp	20152419
220	Washer	R10023699
230	Washer	R5026
240	O ring	20123187
250	Trap gasket	20123190
260	O ring	20152424
310	Condensing exchanger assembly	20177653
320	Rain coat for exchanger	20135930
350	Washer Ø 60	R10028426
360	Spring pipe	20000130
370	Flue sensor	20135782
430	Hole cover	20181027
510	Pump 6 mt.	20178238
511	Air vent bottle	20169571
520	Clip	R10025062
530	Clip	R2165
560	Cover	20180465
600	Ignition transformer	20001563
630	Safety float	20127819
640	Condensation outlet tube	20100816
650	Washer	R10023699
670	Hose clamp	20152306
999	Retarder insulating panel	20159693

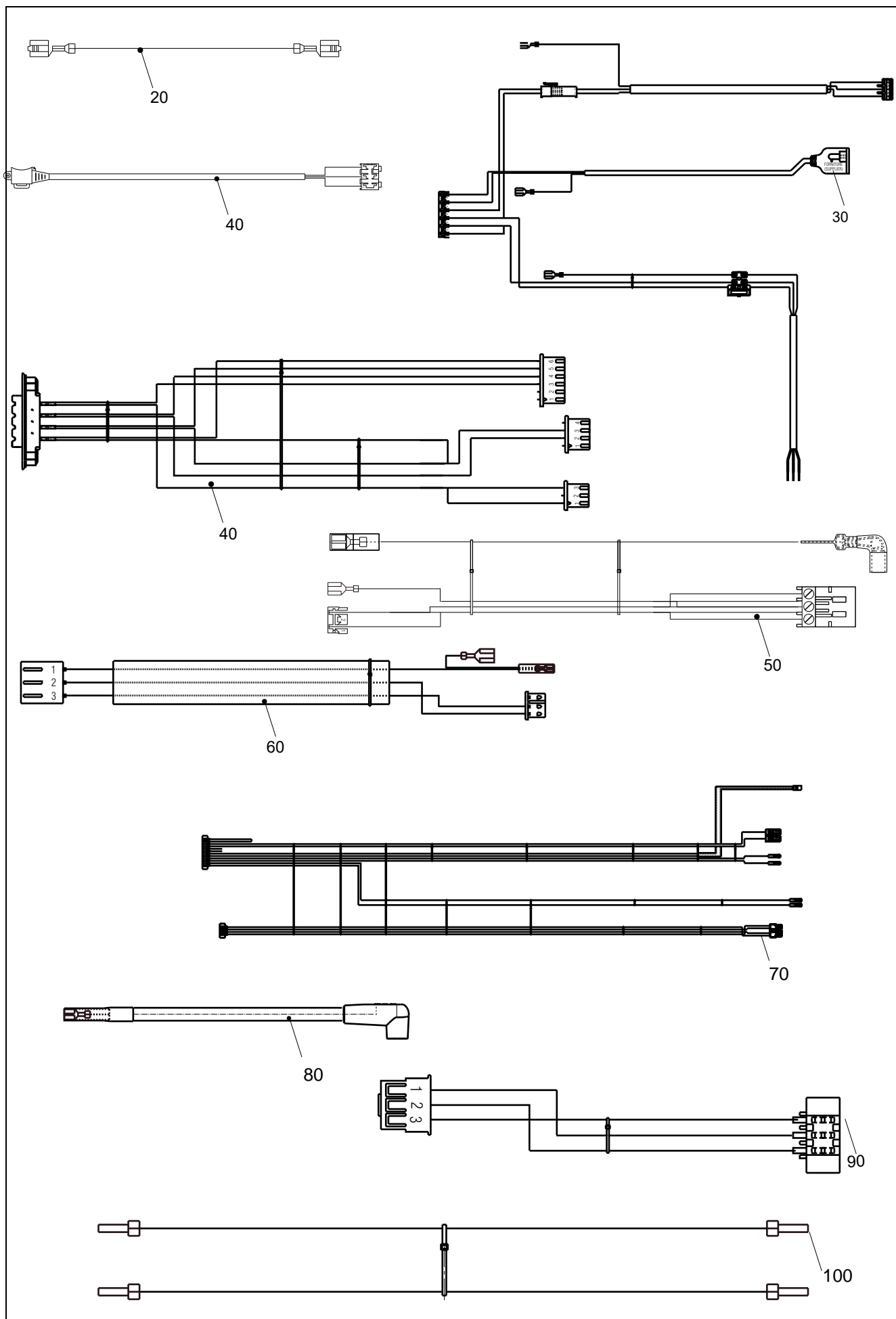

POS.	DESCRIPTION	30S
20	Wiring harness	20167256
30	Power wiring harness	20181024
40	Bus wiring harness	20167255
50	Fan wiring harness	20167257
60	Flame wiring harness	20167258
70	Wiring harness	20181022
80	Ignition electrode wiring harness	20135792
90	pressure transducer wiring	20167261
92	Wiring harness	20181035

Rev	Data	Descrizione



Vokera reserve the right to change the specifications without prior notice.
Consumers' statutory rights are not affected.