

VISION PLUS

High efficiency combi boiler

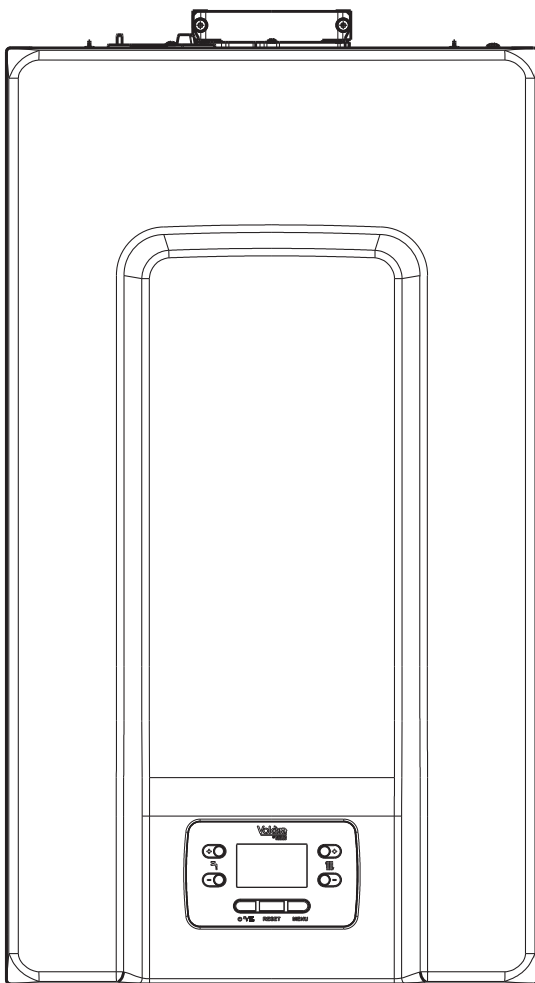

Users Instructions

Installation & Servicing Instructions



VISION PLUS 35 C G.C. N° 47-364-54
VISION PLUS 40 C G.C. N° 47-364-55

THESE INSTRUCTIONS
TO BE RETAINED
BY USER



Vokèra is a licensed member of the Benchmark scheme which aims to improve the standards of installation and commissioning of domestic hot water systems in the UK.

| | | | | | |
|-----------|---|-----------|-----------|--|-----------|
| 1.1A | GAS APPLIANCES | 3 | 5.3 | SETTINGS MENU TREE STRUCTURE | 24 |
| 1.2A | ELECTRICAL SUPPLY | 3 | 5.4 | STARTING THE BOILER | 25 |
| 1.3A | WARRANTY REGISTRATION | 3 | 5.5 | BOILER CONFIGURATION | 26 |
| 1.4A | APPLIANCE COMMISSIONING CHECKLIST (UK ONLY) | 3 | 5.6 | FIRST COMMISSIONING | 28 |
| 1.5A | HOW DOES IT WORK? | 3 | 5.7 | VENT CYCLE | 28 |
| 1.6A | DIMENSION | 3 | 5.8 | OPERATING STATUS | 28 |
| 1.7A | CLEARANCES REQUIRED | 3 | 6 | COMMISSIONING | 31 |
| 1.8A | FROST PROTECTION SYSTEM | 3 | 6.1 | GAS SUPPLY INSTALLATION | 31 |
| 1.9A | CONTROL PANEL | 4 | 6.2 | THE HEATING SYSTEM | 31 |
| 2a | GETTING STARTED | 5 | 6.3 | INITIAL FILLING OF THE SYSTEM | 31 |
| 2.1A | PARAMETERS ACCESS | 5 | 6.4 | PRE-OPERATION CHECKS | 31 |
| 2.2A | PROGRAMMING THE BOILER | 5 | 6.5 | INITIAL LIGHTING | 31 |
| 2.3A | OPERATING MODE | 6 | 6.6 | CHECKING GAS PRESSURE AND COMBUSTION ANALYSIS | 31 |
| 2.4A | OTBus REMOTE CONTROL CONNECTION | 7 | 6.7 | FINAL FLUSHING OF THE HEATING SYSTEM | 31 |
| 2.5A | BOILER FAULT CODES | 8 | 6.8 | SETTING THE FLOW OUTLET TEMPERATURE | 31 |
| 2.6A | INFO MENU | 8 | 6.9 | SETTING THE SYSTEM DESIGN PRESSURE | 31 |
| 3a | HOW TO... | 9 | 6.10 | REGULATING THE CENTRAL HEATING SYSTEM | 32 |
| 3.1A | HOW TO TOP-UP THE SYSTEM PRESSURE | 9 | 6.11 | FINAL CHECKS | 32 |
| 3.2A | HOW TO RESET THE APPLIANCE | 9 | 6.12 | INSTRUCTING THE USER | 32 |
| 3.3A | HOW TO SHUT DOWN THE SYSTEM FOR SHORT PERIODS | 9 | 7 | SERVICING INSTRUCTIONS | 32 |
| 3.4A | HOW TO SHUT DOWN THE SYSTEM FOR LONG PERIODS | 9 | 7.1 | GENERAL | 32 |
| 3.5A | HOW TO CARE FOR THE APPLIANCE | 9 | 7.2 | ROUTINE ANNUAL SERVICING | 32 |
| 3.6A | KEYBOARD LOCKOUT FUNCTION | 9 | 7.3 | CLEANING THE PRIMARY HEAT EXCHANGER | 33 |
| 4a | WHAT IF... | 10 | 7.4 | CLEANING THE BURNER | 33 |
| 4.1A | WHAT IF I SUSPECT A GAS LEAK | 10 | 7.5 | CLEANING THE SIPHON | 33 |
| 4.2A | WHAT IF I HAVE FREQUENTLY TO TOP-UP THE SYSTEM | 10 | 7.6 | ELECTRODES VERIFICATION | 33 |
| 4.3A | WHAT IF THE APPLIANCE IS DUE ITS ANNUAL SERVICE | 10 | 7.7 | CLAPET | 33 |
| 4.4A | WHAT IF I NEED TO CALL AN ENGINEER | 10 | 7.8 | REPLACEMENT OF COMPONENTS | 33 |
| 3.7A | INTERFACE STAND BY | 10 | 7.9 | COMPONENT REMOVAL PROCEDURE | 33 |
| 1 | INTRODUCTION | 11 | 7.10 | CASING REMOVAL (Fig. 26) | 34 |
| 2 | DESIGN PRINCIPLES AND OPERATING SEQUENCE | 12 | 7.11 | PUMP ASSEMBLY (Fig. 27) | 34 |
| 2.1 | PRINCIPLE COMPONENTS | 12 | 7.12 | SAFETY VALVE (Fig. 28) | 34 |
| 2.2 | MODE OF OPERATION (AT REST) | 12 | 7.13 | LOWER ATOMATIC AIR RELEASE VALVE (Fig. 27) | 34 |
| 2.3 | MODE OF OPERATION (HEATING) | 12 | 7.14 | WATER PRESSURE TRANSDUCER (Fig. 29) | 34 |
| 2.4 | MODE OF OPERATION (HOT WATER) | 12 | 7.15 | DHW THERMISTOR (Fig. 29) | 34 |
| 2.5 | SAFETY DEVICES | 12 | 7.16 | FLOW THERMISTOR (FIG. 3 - POS. 7) | 34 |
| 2.6 | TECHNICAL DATA | 13 | 7.17 | RETURN THERMISTOR (FIG. 3 - POS. 21) | 34 |
| 2.7 | PUMP DUTY | 15 | 7.18 | PRINTED CIRCUIT BOARD (FIG. 30) | 34 |
| 2.8 | HOW TO FREE THE PUMP | 15 | 7.19 | GAS VALVE (FIG. 31) | 35 |
| 3 | GENERAL REQUIREMENTS (UK) | 16 | 7.20 | ELECTRODES (FIG. 32) | 35 |
| 3.1 | RELATED DOCUMENTS | 16 | 7.21 | EXPANSION VESSEL (FIG. 33) | 35 |
| 3.2 | LOCATION OF APPLIANCE | 16 | 7.22 | HEAT EXCHANGER (FIG. 34) | 35 |
| 3.3 | GAS SUPPLY | 16 | 7.23 | COMBUSTION UNIT (FIG. 36) | 36 |
| 3.4 | FLUE SYSTEM | 16 | 7.24 | FAN AND MIXER (FIG. 37) | 36 |
| 3.5 | AIR SUPPLY | 16 | 7.25 | DIVERTER VALVE ASSEMBLY (FIG. 38) | 36 |
| 3.6 | WATER CIRCULATION | 16 | 7.26 | REMOVING THE SIPHON (FIG. 39) | 37 |
| 3.7 | ELECTRICAL SUPPLY | 17 | 7.27 | REPLACING INTERFACE | 37 |
| 3.8 | MOUNTING ON A COMBUSTIBLE SURFACE | 17 | 7.28 | REPLACING PCB OR INTERFACE | 37 |
| 3.9 | TIMBER FRAMED BUILDINGS | 17 | 8 | CHECKS, ADJUSTMENTS AND FAULT FINDING | 38 |
| 3.10 | WATER TREATMENT | 17 | 8.1 | CHECKING APPLIANCE OPERATION | 38 |
| 3.11 | SHOWERS | 17 | 8.2 | APPLIANCE MODES OF OPERATION | 38 |
| 3E | GENERAL REQUIREMENTS (EIRE) | 17 | 8.3 | CHECKING THE CO ₂ AND ADJUSTING THE GAS VALVE | 38 |
| 3.1E | RELATED DOCUMENTS | 17 | 8.4 | CHECKING THE EXPANSION VESSEL | 39 |
| 3.2E | LOCATION OF APPLIANCE | 17 | 8.5 | EXTERNAL FAULTS | 39 |
| 3.3E | GAS SUPPLY | 18 | 8.6 | ELECTRICAL CHECKS | 40 |
| 3.4E | FLUE SYSTEM | 18 | 8.7 | FAULT FINDING | 40 |
| 3.5E | AIR SUPPLY | 18 | 8.8 | COMPONENT VALUES & CHARACTERISTICS | 40 |
| 3.6E | WATER CIRCULATION | 18 | 8.9 | ADJUSTMENTS | 40 |
| 3.7E | ELECTRICAL SUPPLY | 18 | 8.10 | GAS VALVE CALIBRATION | 41 |
| 3.8E | MOUNTING ON A COMBUSTIBLE SURFACE | 18 | 8.11 | RANGE RATED | 41 |
| 3.9E | TIMBER FRAMED BUILDINGS | 18 | 8.12 | SETTING THE THERMOREGULATION | 41 |
| 3.10E | WATER TREATMENT | 18 | 8.13 | LIGHTS AND FAULTS | 42 |
| 3.11E | SHOWERS | 18 | 8.14 | BOILER FAULT CODES | 43 |
| 3.12E | DECLARATION OF CONFORMITY | 18 | 8.15 | INFO MENU | 44 |
| 4 | INSTALLATION | 19 | 8.16 | EMBEDDED CLOCK | 45 |
| 4.1 | PREPARATION FOR MOUNTING THE APPLIANCE | 19 | 8.17 | CLOCK FUNCTIONALITY | 45 |
| 4.2 | FITTING THE FLUE | 19 | 8.18 | PROGRAMMING THE EMBEDDED CLOCK | 45 |
| 4.3 | CONNECTING THE GAS AND WATER ("FIG. 18") | 21 | 9 | WIRING DIAGRAMS | 46 |
| 4.4 | INSTALLATION OF CONDENSATE DRAIN PIPE | 21 | 9.1 | EXTERNAL WIRING | 46 |
| 4.5 | INSTRUCTION FOR CONDENSATION EXHAUST CONNECTION | 22 | 9.2 | OTHER DEVICES | 46 |
| 4.6 | ELECTRICAL CONNECTIONS | 22 | 9.3 | OTBUS CONNECTION | 46 |
| 4.7 | CASING REMOVAL | 22 | 10 | LPG INSTRUCTIONS | 48 |
| 4.8 | CONNECTING THE MAINS (230V) INPUT | 22 | 10.1 | RELATED DOCUMENTS | 48 |
| 5 | OPERATION | 23 | 10.2 | TECHNICAL DATA | 48 |
| 5.1 | ACCESS TO THE PARAMETERS | 23 | 10.3 | GAS CONVERSION | 48 |
| 5.2 | CONTROL PANEL | 23 | 10.4 | COMPLETION | 48 |

USERS INSTRUCTIONS

INTRODUCTION

Dear Customer

Your Vokèra **VISION PLUS** boiler has been designed to meet and exceed the very latest standards in gas central heating technology, and if cared for, will give years of reliable use and efficiency. Please therefore take some time to read these instructions carefully.

Do's and Don't's

- **Do** ensure that the system pressure is periodically checked
- **Do** ensure that the boiler should not be used by children or unassisted disabled people
- **Do** ensure that you know how to isolate the appliance in an emergency
- **Do** ensure that you are familiar with the appliance controls
- **Do** ensure that your installer has completed the appliance log book section
- **Do not** attempt to remove the appliance casing or gain internal access
- **Do not** hang clothes etc. over the appliance
- **Do not** forget to have the appliance serviced annually.

This booklet is an integral part of the appliance. It is therefore necessary to ensure that the booklet is handed to the person responsible for the property in which the appliance is located/installed. A replacement copy can be obtained from the Vokera website.



At the end of its life, the product should be not be disposed of as solid urban waste, but rather it should be handed over to a differentiated waste collection centre.

1A THINGS YOU SHOULD KNOW

1.1A GAS APPLIANCES

Gas Safety (Installation and Use) Regulation (UK).

In the interests of your safety and that of others it is a legal requirement that all gas appliances are installed and correctly maintained by a competent person and in accordance with the latest regulations.

1.2A ELECTRICAL SUPPLY

Please ensure that this appliance has been properly connected to the electrical supply by means of a double pole isolator or un-switched socket, and that the correct size of fuse (3 AMP) has been fitted.

Warning: this appliance must be earthed!

1.3A WARRANTY REGISTRATION

The appliance warranty can be registered online or by contacting our warranty registration helpline using the contact number displayed on the registration label on the front of your appliance.

1.4A APPLIANCE COMMISSIONING CHECKLIST (UK ONLY)

A checklist section can be found at the rear of the appliance installation booklet. This important document must be completed during the installation/commissioning of your boiler. All GAS SAFE registered installers carry a GAS SAFE ID card, and have a registration number. These details should be recorded in the Benchmark commissioning checklist section within the installation booklet. You can check your installers details by calling GAS SAFE direct on 08004085500. Failure to install and commission the appliance in accordance with the manufacturers instructions will invalidate the warranty. This does not affect your statutory rights.

1.5A HOW DOES IT WORK?

Your **VISION PLUS** boiler supplies heated water to your radiators and hot water to your hot water taps. The central heating and hot water are controlled via a time clock and any thermostats that your installer may have fitted. The boiler will light when it receives a request from the time clock via any thermostat that may be installed, or whenever a hot water outlet (tap) is opened. Your **VISION PLUS** boiler lights electronically and does not have a pilot light.

In the unlikely event of a fault developing with your boiler, the supply of gas to the burner will be terminated automatically.

1.6A DIMENSION

| VISION PLUS | 35C - 40C |
|-------------|-----------|
| HEIGHT | 740 mm |
| WIDTH | 420 mm |
| DEPTH | 350 mm |

1.7A CLEARANCES REQUIRED

| | |
|-----------|--------------------|
| ABOVE | 100mm* |
| BELOW | 200mm [^] |
| LEFT SIDE | 2mm |

| | |
|------------|--------|
| RIGHT SIDE | 2mm** |
| FRONT | 4mm*** |

* 100mm if rear-flue outlet is used or 25mm above flue bend if top flue outlet is used. Consideration should be given to providing reasonable clearance for the insertion of a FGA probe.

** Disconnection of adjacent components may be required in order to facilitate syphon removal.

*** Provided that a door or removal panel enables 450mm access for maintenance.

[^] Can be reduced to 5mm if a removal panel enables 200mm for maintenance.

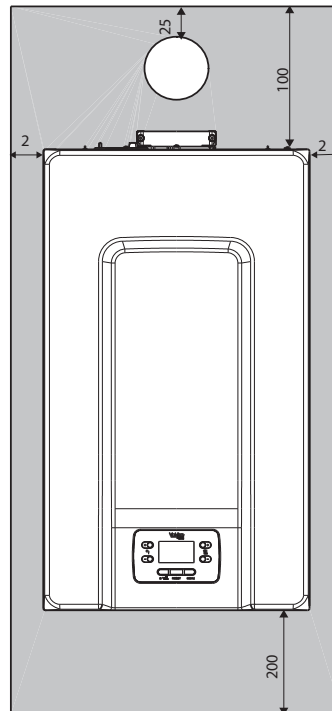

1.8A FROST PROTECTION SYSTEM

The **VISION PLUS** is equipped with a built-in frost protection system, this enables the boiler to over-ride the time controls – even if switched off – and operate the burner and/or pump, should the temperature drop below 5°C for the main and for the DHW line. In particular the burner will be in ON status until the main temperature reaches 35°C for CH appliance and 55°C for DHW appliance. Please note that the frost protection system is designed to protect the appliance only, should frost protection be required for the heating system, additional controls may be required.

NOTE

The frost protection system is reliant on the appliance having a permanent electrical supply, and being in a non-fault condition.

1.9A CONTROL PANEL

Your boiler is equipped with a large LCD display that indicates the appliance operating status.

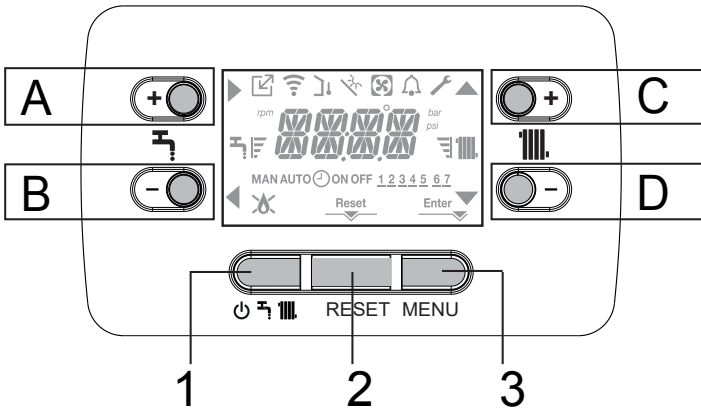

Fig. 1

| | |
|------------|--|
| A | It is normally used to raise the domestic hot water temperature, when the arrow ► is highlighted it has the confirm function |
| B | It is normally used to lower the domestic hot water temperature, when the arrow ◀ is highlighted it has the back/cancel function |
| A+B | Access to the domestic hot water comfort functions (see paragraph "2.3.9a DOMESTIC HOT WATER COMFORT FUNCTION") |
| C | It is normally used to raise the heating water temperature, when the arrow ▲ is highlighted you can move inside the P1 menu |
| D | It is normally used to lower the heating water temperature, when the arrow ▼ is highlighted you can move inside the P1 menu |
| A+C | Access to the menu for setting the clock (see paragraph "2.2a PROGRAMMING THE BOILER") |
| 1 | Used to change the operating status of the boiler (OFF, SUMMER and WINTER) |
| 2 | Used to reset the alarm status or to interrupt the vent cycle |
| 3 | Used to access the INFO and P1 menus. When the icon Enter is shown on the display, the key has the ENTER function and is used to confirm the value set during the programming of a technical parameter |
| 1+3 | Lock and unlock keys |
| 2+3 | When the boiler is set to OFF it is used to start the combustion analysis function (CO) |

| | |
|---------------|---|
| | Indicates the connection to a remote device (OT or RS485) |
| | Indicates the connection to a WIFI device |
| | Indicates the presence of an outdoor temperature sensor |
| | Indicates the activation of special domestic hot water functions or the presence of a system for managing the solar thermal array |
| | Indicates the connection to a heat pump (not used on this model) |
| | Displayed when a fault occurs and/or when there is an alarm |
| | Fault and/or service indicator |
| | Indicates the presence of a flame, in the event of a flame lockout the icon looks like |
| | It comes on when there are alarms that require a manual reset by the user |
| | It comes on when there is an operation confirmation request |
| | When the icon is active, it indicates that the "confirm" function of button A is active |
| | When the icon is active, it indicates that the "back/cancel" function of button B is active |
| | When the icon is active, it is possible to navigate the menu or raise the value of the selected parameter |
| | When the icon is active, it is possible to navigate the menu or lower the value of the selected parameter |
| | The icon comes on if central heating is active, it blinks if a heating request is in progress |
| | The icon comes on if domestic hot water is active, it blinks if a domestic hot water request is in progress |
| | They indicate the set point level set (1 bar minimum value, 4 bars maximum value) |
| 1 2 3 4 5 6 7 | Indicates the days of the week |
| | Only if clock is enabled |
| | Only if clock is enabled |
| | Only if clock is enabled |

The remote control has the function of a machine interface, displaying the system settings and providing access to the parameters. The display normally shows the temperature of the flow sensor unless there is a domestic hot water request in progress, then the domestic hot water probe temperature is displayed; if no key is touched within 10 sec the current time is displayed (backlight unlit). The configuration MENU is organised with a multi-level tree structure. An access level has been fixed for each sub-menu: USER level always available; TECHNICAL level password protected.

2A GETTING STARTED

2.1A PARAMETERS ACCESS

Pressing the MENU key for at least 2 sec provides access to the P1 menu, allowing the parameters to be programmed.

If the case the menu is empty, P8.04 is displayed, otherwise the first item in the menu appears.



IMPORTANT

The parameters dedicated to the user are the following:

| Menu | Parameters | Scrolling message only if parameter P1.05 = 1 | Value | Password level |
|------|------------|---|---|----------------|
| P1 | | SETTINGS | | |
| | P1.01 | LANGUAGES | 0 IT 1 RO 2 FR 3 EN 4 SR 5 HR 6 ES 7 EL 8 BG 9 PL 10 SL | USER |
| | P1.02 | TIME | | USER |
| | P1.03 | TIME PROGRAM | Only if clock is enabled - see 8.16 | |
| | P1.05 | SCROLLING | 0 / 1 | USER |

P1 (SETTINGS menu)

P1.01

Select the parameter to set the desired language (see above table).

P1.02

From this menu the time and the number of the day of the week can be adjusted.

P1.03

Available only if embedded clock has been enabled.

P1.05

This parameter allows you to enable scrolling text after the parameter code itself:

0= OFF

1= ON

2.2A PROGRAMMING THE BOILER

Ensure the gas and electrical supplies to the appliance are switched on.



- With power on the backlight comes on, then all the icons and the segments come on for 1sec and in sequence the firmware revision is displayed for 3sec:

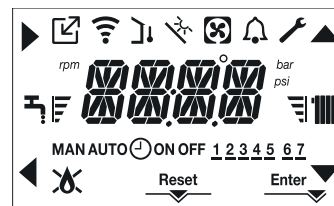

- Then the interface displays the status active at that moment.

If necessary, the interface automatically goes to the clock menu. On the main screen the icons ▲, ▼, ► and ◀ and ENTER come on while 00:00 is displayed with the first two digits blinking with a frequency of 0.5 sec ON, 0.5 sec OFF.



To set the time and day proceed as follows:

- set the hour with the ▲ and ▼ arrows, then confirm with **A**
- set the minutes with the ▲ and ▼ arrows, then confirm with **A**
- set the day of the week with the ▲ and ▼ arrows. The segment of the day selected blinks, press MENU at the icon Enter per to confirm the time and day setting. The clock blinks for 4sec and then returns to the main screen
- to exit the time programming without saving the modified values, just press ◀

NOTE: It is possible to change the TIME and DAY settings also later by accessing the P1.02 parameter in the P1 menu, or by pressing the **A+C** keys for at least 2sec.

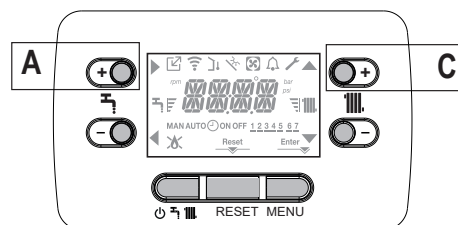

- If you need to set the **language**, select the menu P1 and confirm your choice using ►.
- Use the arrows to display parameter P1.01, then enter the submenu by pressing ►.
- Use the ▲ and ▼ buttons to set the desired language – see “2.1a PARAMETERS ACCESS”. To confirm your choice, press Enter.



Vent cycle

Whenever the electrical supply to the appliance has been disrupted (OFF) and then restored (ON), it will enter a 4-min vent cycle.

- ⚠ When the air purging cycle is in progress, all heat requests are inhibited except those for domestic hot water when the boiler is not set to OFF and -AIR is displayed on the interface screen.

The display shows the message -AIR lighting up the icon RESET.



The purge cycle can be interrupted early by keeping key 2 (the icon **RESET** comes on). The purge cycle can also be interrupted, if the boiler is not set to OFF, by a domestic hot water request.

- Adjust the ambient temperature thermostat to the desired temperature (~20°C) or, if the system is equipped with a programmable thermostat or timer, ensure that the thermostat or timer is "active" and set correctly (~20°C)
- Then set the boiler on **WINTER** or **SUMMER** depending on the type of operation desired.
- The boiler will start up and continue working until the set temperatures are reached, after which it will then go back to standby.

2.3A OPERATING MODE

For changing the operating status from WINTER to SUMMER to OFF press key 1 until the icon for the desired function is displayed.

2.3.1A WINTER MODE

- Set the boiler to the WINTER status by pressing key 1 until both the domestic hot water icon and the heating icon are displayed.



The interface normally displays the delivery temperature unless there is a domestic hot water request in progress, in which case the domestic hot water temperature is displayed.

- When there is a heat request and the burner is lit, the icon  appears on the display.

Heating REQUEST, the radiator icon blinks:

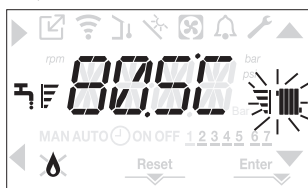

2.3.2A SUMMER MODE

- Set the boiler to the SUMMER status by pressing key 1 until the domestic hot water icon is displayed.

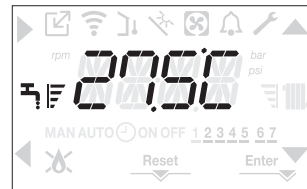

In this status the boiler activates the traditional function of just domestic hot water, the interface normally displays the delivery temperature. In the event of a domestic hot water pick up, the display shows the temperature of the domestic hot water.

Domestic hot water REQUEST, the tap icon blinks:

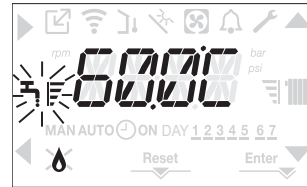

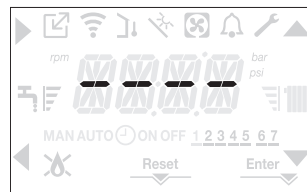

2.3.3A OFF

- Set the boiler to the OFF status by pressing key 1 until the central segments are displayed.



2.3.4A ADJUSTING THE HEATING WATER TEMPERATURE WITHOUT AN OUTDOOR TEMPERATURE SENSOR CONNECTED

If there is no outdoor temperature sensor the boiler operates at a fixed point, the HEATING setpoint in this case can be set on the main page of the screen.

The successive pressing of the key **C** or **D** on the main screen displays the current value of the heating setpoint; the value blinks with a frequency of 0.5 sec ON, 0.5 sec OFF and the icons  and  come on.

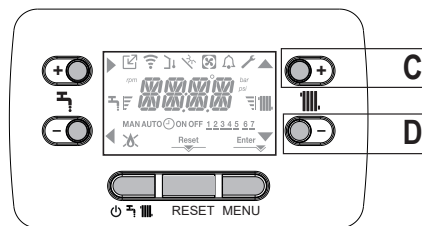

The successive pressing of the key **C** or **D** allows you to set the value of the heating setpoint within the preset range:

[40°C - 80.5°C] for high temperature systems

[20°C - 45 °C] for low temperature systems

with steps of 0.5°C. The level bars beside the heating icon show the setpoint value set with respect to the operating range:

- four bars on = max setpoint 

- one bar on = min setpoint 

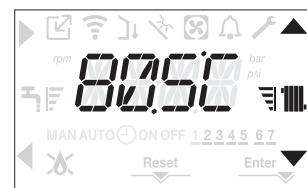

Keeping one of the two keys **C** or **D** pressed for longer, the meter increases the speed of advancement modifying the set value. If no key is pressed for 5sec, the value set is taken as the new heating setpoint and the display returns to the main page.

2.3.5A ADJUSTING THE HEATING WATER TEMPERATURE WITH AN OUTDOOR TEMPERATURE SENSOR CONNECTED

If an outdoor temperature sensor is installed and thermoregulation is enabled (parameter P4.18=1), the delivery temperature is automatically selected by the system, which quickly adjusts the ambient temperature according to the variations in the outdoor temperature.

If you want to change the temperature, raising it or lowering it with respect to that automatically calculated by the electronic board, it is possible to change the HEATING setpoint selecting the desired comfort level within the range (-5 - +5).

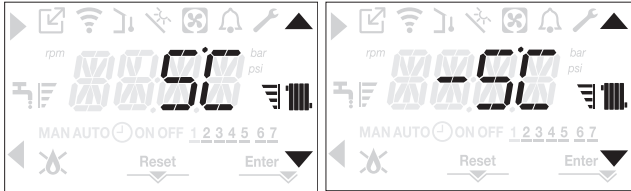

Note: if an outdoor temperature sensor is connected it is in any event possible to have the boiler operate at a fixed point by setting the parameter P4.18 = 0 (menu P4).

2.3.6A ADJUSTING THE DOMESTIC HOT WATER TEMPERATURE

On the main screen, pressing the key **A** rather than **B** displays the current domestic hot water setpoint, the value blinks with a frequency of 0.5 sec ON, 0.5 sec OFF and the icons ▲ and ▼ come on.

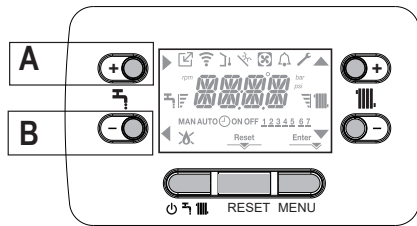

The successive pressing of the keys **A** or **B** allows you to set the value of the domestic hot water setpoint raising or lowering the value within the preset range in steps of 0.5°C. The level bars beside the heating icon show the setpoint value set with respect to the operating range:

- four bars on = max setpoint
- one bar on = min setpoint



2.3.7A SAFETY STOP

If there are ignition faults or boiler operation malfunctions, carry out a "SAFETY STOP". On the display, in addition to the fault code, the icon 🔔 is also displayed, which blinks with a frequency of 0.5sec ON and 0.5sec OFF.

The backlight blinks for 1min after which it switches off, while the icon 🔔 continues blinking.

On the 4 digits a message scrolls containing the error code and its description.

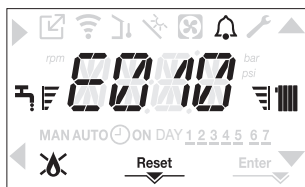

2.3.8A RESET FUNCTION

The "RESET" icon comes on when there is an alarm that requires a manual reset by the user (for example flame lockout). To reset the lockout press key 2 RESET.

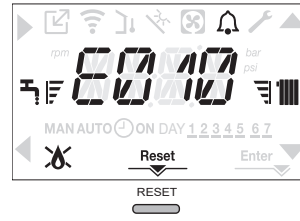

If the reset attempts do not restart the boiler, contact you engineer or Vokera Ltd. for help or advice.

2.3.9A DOMESTIC HOT WATER COMFORT FUNCTION

Pressing the keys **A+B** for at least 2sec gives you access to the domestic hot water comfort functions. COFF is shown on the display and the icons ▲, ▼, ► and ◀ come on:

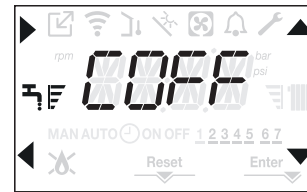

Using the keys ▲, ▼ you can scroll through the options in sequence CSTD and then COFF again. Using the ► key activates the desired function and you exit the menu returning to the initial screen. A scrolling message appears on the display with the following mode:

| Function | Scrolling message |
|----------|-------------------|
| CSTD | COMFORT STANDARD |
| COFF | COMFORT OFF |

CSTD (PREHEATING function)

By setting CSTD, the domestic hot water preheating function of the boiler activates. This function keeps the water in the domestic hot water exchanger hot, to reduce standby times when a request is made. When the preheating function is enabled the scrolling message PREHEATING FUNCTION IN PROGRESS is displayed. To deactivate the preheating function set COFF. The function is not active when the boiler is OFF.

2.4A OTBus REMOTE CONTROL CONNECTION

When an OTBus remote control is connected to the system, the boiler display shows the following screen:

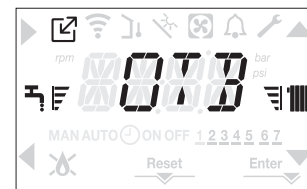

In particular on the boiler display:

- it is no longer possible to set the boiler OFF/WINTER/SUMMER status (it is set by the OTBus remote control)
- it is no longer possible to set the domestic hot water setpoint (it is set by the OTBus remote control)
- the combination of the **A+B** keys remains active for the setting of the DOMESTIC HOT WATER COMFORT function
- the domestic hot water setpoint is displayed in the INFO menu.

2.5A BOILER FAULT CODES

| ERROR CODE | FAULT | DESCRIPTION OF ALARM TYPE |
|------------|---|--|
| E010 | flame lockout/ condensate discharge blockage fumes discharge alarm/air intake obstructed | definitive |
| E011 | extraneous flame | transitional |
| E020 | limit thermostat | definitive |
| E030 | fan fault | definitive |
| E040 | pressure transducer – load system | definitive |
| E041 | water transducer – load system | transitional |
| E042 | water transducer fault | definitive |
| E060 | domestic hot water probe fault | transitional |
| E070 | flow sensor fault flow sensor overtemperature flow/return sensor differential alarm | transitional definitive definitive |
| E077 | water thermostat main zone or zone 1 (when enabled) | transitional |
| E080 | return line probe fault return line probe overtemperature outlet/return line probe differential alarm | transitional definitive definitive |
| E084 | delivery line probe fault - zone 1 | transitional |
| E086 | delivery line probe fault - main zone | transitional |
| E090 | flue gas probe fault flue gas probe overtemperature | transitional definitive |
| E091 | clean primary heat exchanger | transitional |
| E099 | reset attempts exhausted, boiler blocked | definitive, not resettable |
| <0,6 bar | Low water pressure check the HTG system | |
| >3,0 bar | High water pressure check the HTG system | |
| COM | lost communication with boiler board | transitional |
| COMP | lost communication with main zone | transitional |
| COM1 | lost communication with zone 1 | transitional |
| FWER | FW version not compatible | definitive |
| OBCD | damaged clock | signalisation |
| OTER | OTBus configuration fault | |

For reset faults, except for E40-E041, call engineer,

2.6A INFO MENU

Pressing key 3 on the display screen displays a list of information regarding the operation of the boiler listed by parameter name and value. Passing from the display of one parameter to the next takes place by pressing respectively the keys ▲ and ▼. Pressing the key ► allows the selected parameter to be displayed; pressing the key ◀ returns you to the main screen:

| Parameter name | Scrolling message only if parameter P1.05 = 1 | Description |
|----------------|---|--|
| 10.01 | SCREED HEATING HOURS | Number of hours passed with screed heater function |
| 10.02 | CH PROBE | Boiler delivery sensor value |
| 10.03 | RETURN PROBE | Boiler return sensor value |
| 10.04 | DHW PROBE | Domestic hot water probe value |
| 10.08 | EXHAUST PROBE | Flue gas probe value |
| 10.09 | OUTDOOR TEMP PROBE | Outdoor temperature sensor instantaneous value |
| 10.10 | FILTERED OUTDOOR TEMP | Outdoor temperature filtered value used in the thermoregulation algorithm for calculating the heating setpoint |
| 10.11 | DHW FLOW RATE | For instantaneous boiler with flowmeter |
| | DHW SETPOINT | Only in case of OTBus connection |
| 10.12 | FAN SPEED | Number of turns of the fan (rpm) |
| 10.13 | MAIN ZONE OUTLET | Main zone flow sensor value (when P4.12 = 1) |
| 10.14 | ZONE 1 OUTLET | Zone 1 flow sensor value (when P4.13 = 1) |
| 10.15 | EXHAUST PROBE HOURS | Number of hours the heat exchanger has been operating in “condensing mode” |
| 10.16 | MAIN ZONE SET | Main zone delivery setpoint |
| 10.17 | ZONE 1 SET | Zone 1 delivery setpoint (when P4.23 = 1) |
| 10.18 | WATER PRESSURE | System pressure |
| 10.30 | COMFORT | Domestic hot water comfort (COFF, CSTD) |
| 10.31 | SUN ON | Special functions active for high domestic hot water temperature inputs |
| 10.33 | PCB ID | Electronic board card identification |
| 10.34 | PCB FW | Electronic board card fmw revision |
| 10.35 | INTERFACE FW | Interface fmw |

3A HOW TO...

3.1A HOW TO TOP-UP THE SYSTEM PRESSURE

The system pressure must be checked periodically to ensure the correct operation of the boiler. Scroll the INFO menu to 10.18, the displayed pressure should be reading between 1 and 1.5 BAR when the boiler is in an off position and has cooled to room temperature. If the pressure requires 'topping-up' use the following instructions as a guide.

- Locate the filling valve connections (usually beneath the boiler, see "Fig. 2").
- Attach the filling loop to both connections.
- Open the filling valve slowly until you hear water entering the system.
- Close the filling valve when the pressure (on the boiler) reads between 1 and 1.5 bar.
- Remove the filling loop from the connections.

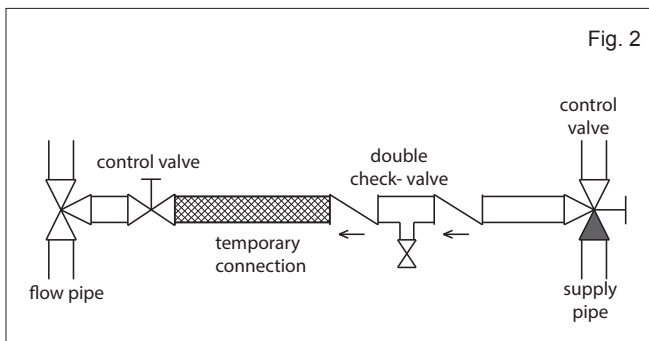

Fig. 2

3.2A HOW TO RESET THE APPLIANCE

When the fault code is displayed, the appliance will require to be reset manually. Before resetting the boiler, check what action is required to be taken, using the information on the fault code table.

RESET FUNCTION

Press the RESET button. At this point, if the correct operating conditions have been restored, the boiler will restart automatically. There are a maximum of 3 consecutive attempts. In case of all the attempts are exhausted the definitive fault E099 occurs on the display. To restore from an 'E099' fault code, it is necessary to momentarily switch off the electrical supply to the appliance and then restore the electrical supply to the appliance.

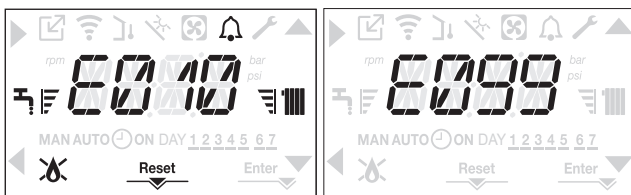

IMPORTANT

If the appliance requires to be reset frequently, it may be indicative of a fault, please contact your installer or Vokera Customer Services for further advice.

3.3A HOW TO SHUT DOWN THE SYSTEM FOR SHORT PERIODS

The system and boiler can be shut down, in the event of temporary absences (weekends, short breaks, etc.) setting the boiler status to OFF.

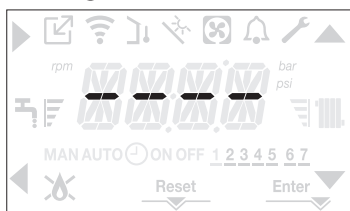

While the electrical supply and the fuel supply remain active, the boiler is protected by the systems:

- heating anti-freeze: this function is activated if the temperature measured by the flow sensor drops below 5°C. A heat request is generated in this phase with the ignition of the burner at minimum output, which is maintained until the outlet water temperature reaches 35°C;
- domestic hot water anti-freeze: this function is activated if the temperature measured by the domestic hot water probe drops below 5°C. A heat request is generated in this phase with the ignition of the burner at minimum output, which is maintained until the outlet water temperature reaches 55°C.



The operation of the ANTI-FREEZE function is indicated by a scrolling message on the interface display: AF1 (DHW antifreeze in progress) - AF2 (CH antifreeze in progress), as the case may be.

- circulator anti-locking: the circulator activates every 24 hours of stoppage for 30 seconds.

3.4A HOW TO SHUT DOWN THE SYSTEM FOR LONG PERIODS

If the house is to be left unoccupied for any length of time – especially during the winter – the system should be thoroughly drained of all water. The gas, water, and electricity supply to the house should also be turned off. For more detailed advice contact your installer.

3.5A HOW TO CARE FOR THE APPLIANCE

To clean the outer casing use only a clean damp cloth. Do not use any scourers or abrasive cleaners.

3.6A KEYBOARD LOCKOUT FUNCTION

Pressing buttons 1+3 for at least 2sec activates the key lockout; pressing buttons 1+3 again for at least 2sec re-activates the key. The display will show LOCK.

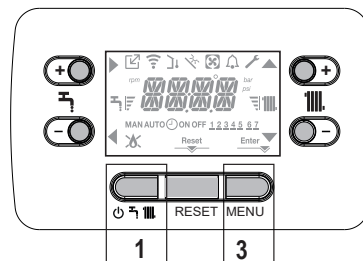

Button '2' (reset) remains active if there is a fault to allow the alarm to be reset.

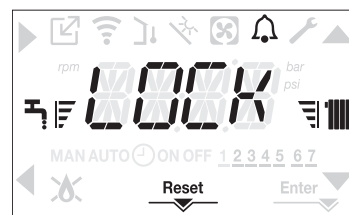

3.7A INTERFACE STAND BY

Usually, when there are no faults or heat requests, the display always shows the temperature measured by the flow sensor. If within 10 seconds there is no heat request without any key being pressed the interface goes into stand by. The display shows the current time, the two points separating the time from the minutes blink with a frequency of 0.5sec ON and 0.5sec OFF, while the status icons will be active if necessary:



In the case of stand by press any button to return to normal operating conditions.

4A WHAT IF...

4.1A WHAT IF I SUSPECT A GAS LEAK

If you suspect a gas leak, turn off the gas supply at the gas meter and contact your installer or local gas supplier. If you require further advice please contact your nearest Vokèra office.

4.2A WHAT IF I HAVE FREQUENTLY TO TOP-UP THE SYSTEM

If the system regularly requires topping-up, it may be indicative of a leak. Please contact your installer and ask him to inspect the system.

4.3A WHAT IF THE APPLIANCE IS DUE ITS ANNUAL SERVICE

Advice for tenants only

Your landlord should arrange for servicing.

Advice for homeowners

Please contact Vokèra Customer Service (**0844 3910999 (UK)** or **056 7755057 (ROI)**) if you would prefer a Vokèra service engineer or agent to service your appliance. Alternatively your local GAS SAFE registered engineer may be able to service the appliance for you.

4.4A WHAT IF I NEED TO CALL AN ENGINEER

If you think your boiler may have developed a fault, please contact your installer or Vokèra Customer Services (**0844 3910999 (UK)** or **056 7755057 (ROI)**) have all your details to hand including full address and postcode, relevant contact numbers, and your completed appliance log book.

INSTALLATION AND SERVICING INSTRUCTIONS

1 INTRODUCTION

All installers are asked to follow the Benchmark Scheme by adhering to the Code of Practice, which can be obtained from www.centralheating.co.uk.

The **VISION PLUS** is comprised of a 7-model range of high efficiency appliances, with outputs ranging from 20kW to 40kW. These appliances – by design – incorporate electronic ignition, circulating pump, expansion vessel, safety valve, pressure transducer and automatic by-pass.

The **VISION PLUS** range is produced as room sealed, category II2H3P appliances, suitable for internal wall mounting applications only. Each appliance is provided with a fan powered flue outlet with an annular co-axial combustion air intake that can be rotated – horizontally – through 360 degrees for various horizontal or vertical applications.

The **VISION PLUS** is approved for use with C13 & C33 type flue applications.

These appliances are designed for use with a sealed system only; consequently they are not intended for use on open vented systems.

This booklet is an integral part of the appliance. It is therefore necessary to ensure that the booklet is handed to the person responsible for the property in which the appliance is located/installed. A replacement copy can be obtained from Vokèra customer services.

VISION PLUS boiler complies with basic requirements of the following Directives:

- Regulation (EU) 2016/426;
- Yield directive: Article 7(2) and Annex III of directive 92/42/EEC;
- Electromagnetic compatibility directive 2014/30/EU;
- Low-voltage directive 2014/35/EU;
- Directive 2009/125/EC Ecodesign for energy-using appliances;
- Regulation (EU) No. 2017/1369 Energy Labelling;
- Delegated Regulation (EU) No. 811/2013;
- Delegated Regulation (EU) No. 813/2013;
- Delegated Regulation (EU) No. 814/2013.



At the end of its life, the product should not be disposed of as solid urban waste, but rather it should be handed over to a differentiated waste collection centre.

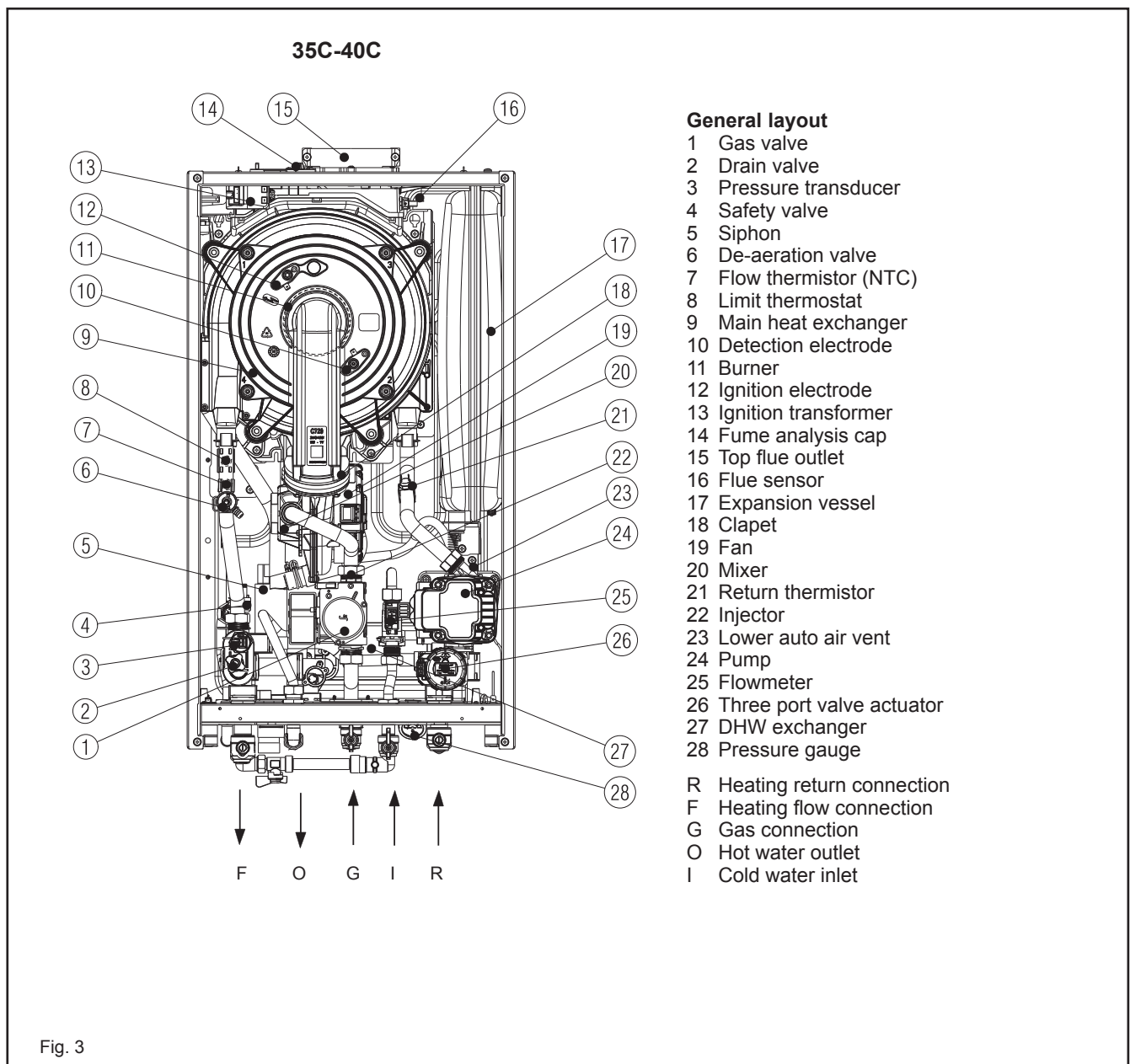

2 DESIGN PRINCIPLES AND OPERATING SEQUENCE

2.1 PRINCIPLE COMPONENTS

- A fully integrated electronic control board featuring electronic temperature control, anti-cycle control, pump over-run, self-diagnostic fault indicator, full air/gas modulation
- Stainless-steel heat exchanger
- Electronic ignition with flame supervision
- Integral high-head pump
- Fan
- Expansion vessel
- Water pressure transducer
- Flue sensor
- Safety valve

2.2 MODE OF OPERATION (AT REST)

When the appliance is at rest and there are no requests for heating or hot water, the following functions are active:

- frost-protection system: the frost-protection system protects the appliance against the risk of frost damage both for CH and DHW. For CH line, if the main temperature falls to 5°C, the appliance will function on minimum power until the temperature on main reaches 35°C. Moreover if the DHW temperature falls to 5°C, the appliance will function on minimum power until the temperature on main reaches 55°C.
- anti-block function: the anti-block function enables the pump and diverter valve actuator to be energised for short periods, when the appliance has been inactive for more than 24-hours.

2.3 MODE OF OPERATION (HEATING)

When there is a request for heat via the time clock and/or any external control, the pump and fan are started, the fan speed will modulate until the correct signal voltage is received at the control PCB. At this point an ignition sequence is enabled.

Ignition is sensed by the electronic circuit to ensure flame stability at the burner. Once successful ignition has been achieved, the electronic circuitry increases the gas rate to 75% for a period of 15 minutes.

Thereafter, the boiler's output will either be increase to maximum or modulate to suit the set requirement. When the appliance reaches the desired temperature the burner will shut down and the boiler will perform a three-minute anti-cycle (timer delay). When the request for heat has been satisfied the appliance pump and fan may continue to operate to dissipate any residual heat within the appliance.

2.4 MODE OF OPERATION (HOT WATER)

When there is a request for DHW via a hot water outlet or tap, the pump and fan are started, the fan speed will modulate until the correct signal voltage is received at the control PCB. At this point an ignition sequence is enabled.

Ignition is sensed by the electronic circuit to ensure flame stability at the burner. Once successful ignition has been achieved, the electronic circuitry increases the gas rate to maximum or will modulate output to stabilise the temperature.

In the event of the appliance exceeding the desired temperature (set point) the burner will shut down until the temperature drops. When the request for DHW has been satisfied the appliance pump and fan may continue to operate to dissipate any residual heat within the appliance.

2.5 SAFETY DEVICES

When the appliance is in use, safe operation is ensured by:

- a water pressure transducer that monitors system water pressure and will de-activate the pump, fan, and burner should the system water pressure drop below the rated tolerance;
- fan speed sensor to ensure safe operation of the burner;
- a high limit thermostat that over-rides the temperature control circuit to prevent or interrupt the operation of the burner;
- flame sensor that will shut down the burner when no flame signal is detected;
- flue sensor;
- a safety valve which releases excess pressure from the primary circuit.

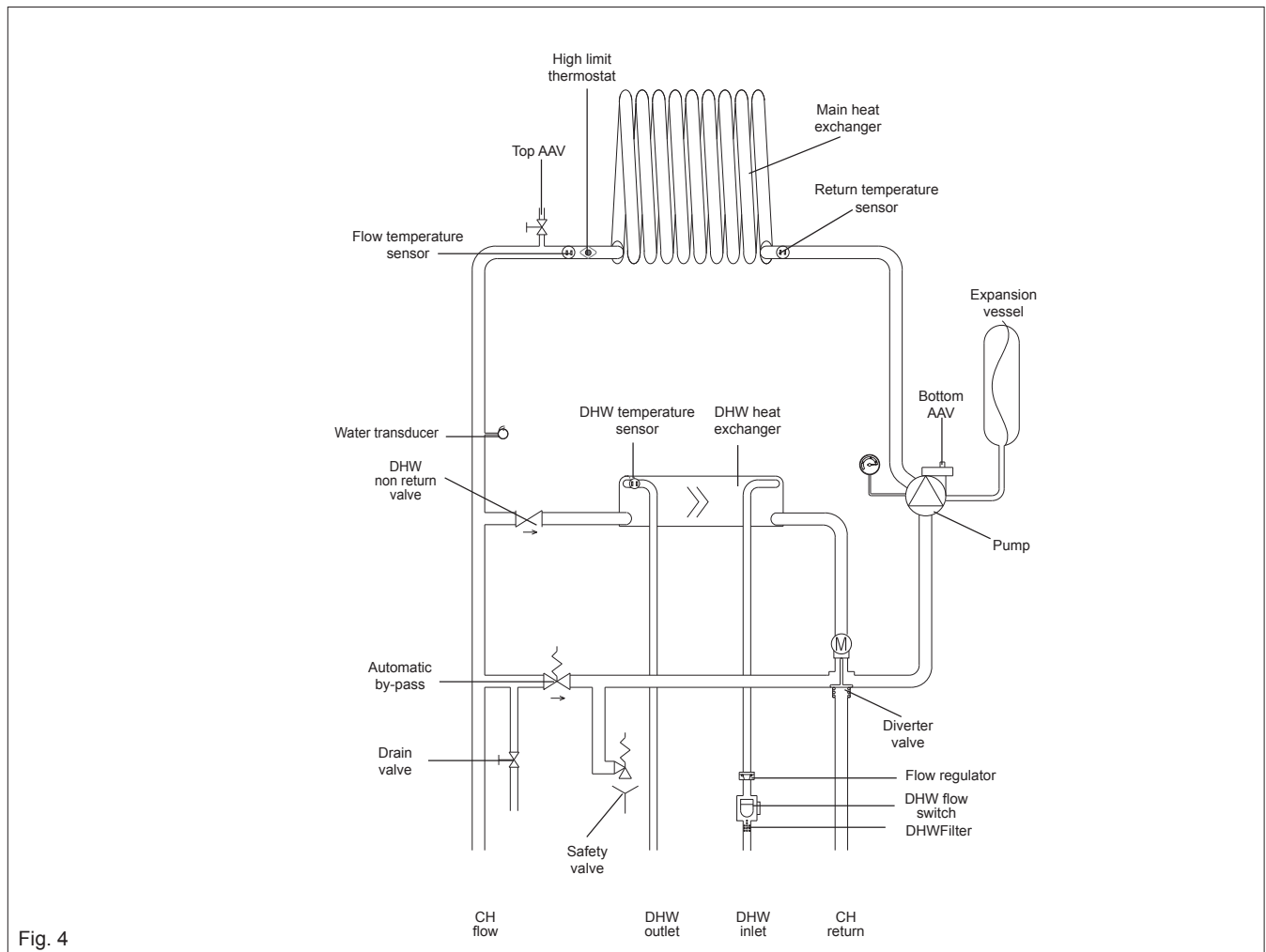

Fig. 4

2.6 TECHNICAL DATA

| Central Heating | VISION PLUS 35C | VISION PLUS 40C |
|---|--|-----------------|
| Heat input (kW) | 30.00 | 30.00 |
| Maximum heat output (kW) 60/80°C | 29.25 | 29.25 |
| Minimum heat output (kW) 60/80°C | 4.65 | 4.65 |
| Maximum heat output (kW) 30/50°C | 32.25 | 32.25 |
| Minimum heat output (kW) 30/50°C | 5.08 | 5.08 |
| Minimum working pressure | 0.25-0.45 bar | |
| Maximum working pressure | 2.5 bar | |
| Minimum flow rate | 350 l/h | |
| Domestic Hot Water | VISION PLUS 35C | VISION PLUS 40C |
| Heat input (kW) | 34.60 | 40.00 |
| Flow Rate: ΔT35°C | 14.20 | 16.40 |
| Maximum inlet pressure | 8 bar | |
| Minimum inlet pressure | 0.15 bar | |
| Minimum flow rate | 2 l/min | |
| Gas Pressures | VISION PLUS 35C | VISION PLUS 40C |
| Inlet pressure (G20) | 20.0 mbar | 20.0 mbar |
| Heating maximum gas rate (m³/hr) | 3.17 | 3.17 |
| DHW maximum gas rate (m³/hr) | 3.66 | 4.23 |
| Minimum gas rate (m³/hr) | 0.52 | 0.52 |
| Injector size (mm) | 5.7 | 5.7 |
| Fan speed (G20) | VISION PLUS 35C | VISION PLUS 40C |
| Slow ignition (rpm) | 5.500 | 5.500 |
| CH maximum number of fan rotation (rpm) | 6.900 | 6.900 |
| DHW maximum number of fan rotation (rpm) | 7.800 | 9.200 |
| Minimum number of fan rotation (rpm) | 1.700 | 1.700 |
| Expansion Vessel | VISION PLUS 35C | VISION PLUS 40C |
| Capacity | 9 litres | |
| Maximum system volume | 74 litres | |
| Pre-charge pressure | 1 bar | |
| Dimensions | VISION PLUS 35C | VISION PLUS 40C |
| Height (mm) | 740 | |
| Width (mm) | 420 | |
| Depth (mm) | 350 | |
| Dry weight (kg) | 37 | 37 |
| Clearances | VISION PLUS 35C | VISION PLUS 40C |
| Sides | 2mm* | |
| Top | 100mm** from casing or 25mm above flue elbow (whichever is applicable)** | |
| Bottom | 200mm [^] | |
| Front | 450mm ^{^^} | |
| | * It may be necessary to remove adjacent components if component removal/replacement is required ** Consideration should be given to providing reasonable clearance for the insertion of a FGA probe. [^] This can be reduced to 5mm if a removal panel enables the required 200mm ^{^^} When installed in a cupboard, this dimension can be reduced to 4mm provided that the required 450mm is available when the door is opened/removed. | |
| Connections | VISION PLUS 35C | VISION PLUS 40C |
| Flow & return | 22mm | |
| Gas | 15mm | |
| DHW hot & cold | 15mm | |
| Safety valve | 15mm | |
| Condense | 21mm | |
| Electrical | VISION PLUS 35C | VISION PLUS 40C |
| Power consumption (Watts) DHW | 92 | 118 |
| Power consumption (Watts) CH | 79 | 79 |
| Voltage (V/Hz) | 230/50 | |
| Internal fuse | 3.15A T (for PCB) - 3.15A F (for connections block) | |
| External fuse | 3A | |
| Flue Details (concentric 60-100) | VISION PLUS 35C | VISION PLUS 40C |
| Maximum horizontal flue length (60/100mm) | 6.0m | 6.0m |
| Maximum vertical flue length (60/100mm) | 7.0m | 7.0m |
| Flue Details (concentric 80-125) | VISION PLUS 35C | VISION PLUS 40C |
| Maximum horizontal flue length (80/125mm) | 15.0m | 15.0m |
| Maximum vertical flue length (80/125mm) | 16.0m | 16.0m |
| Efficiency | VISION PLUS 35C | VISION PLUS 40C |
| SEDBUK 2005 (%) | 90.00 | 90.03 |
| Emissions | VISION PLUS 35C | VISION PLUS 40C |
| CO ₂ @ maximum output (%) | 9.1 | 9.1 |
| CO ₂ @ minimum output (%) | 9.0 | 9.0 |
| CO @ maximum output (ppm) | 150 | 150 |
| CO @ minimum output (ppm) | 10 | 10 |
| NOx rating | class 6 | class 6 |

VISION PLUS 35C

| Seasonal space heating energy efficiency class | | | | Water heating energy efficiency class | | | |
|--|--------|-------|------|--|-------------|--------|--------|
| A | | | | A | | | |
| Parameter | Symbol | Value | Unit | Parameter | Symbol | Value | Unit |
| Rated heat output | Prated | 29 | kW | Seasonal space heating energy efficiency | η_s | 92 | % |
| For boiler space heaters and boiler combination heaters: useful heat output | | | | For boiler space heaters and boiler combination heaters: useful efficiency | | | |
| At rated heat output and high-temperature regime (*) | P4 | 29,3 | kW | At rated heat output and high-temperature regime (*) | η_4 | 87,6 | % |
| At 30% of rated heat output and low-temperature regime (**) | P1 | 9,7 | kW | At 30% of rated heat output and low-temperature regime (**) | η_1 | 96,5 | % |
| Auxiliary electricity consumption | | | | Other parameters | | | |
| At full load | elmax | 41,0 | W | Stand-by heat loss | Pstby | 38,0 | W |
| At part load | elmin | 14,0 | W | Pilot flame energy consumption | Pign | - | W |
| In Stand-by mode | PSB | 3,0 | W | Annual energy consumption | QHE | 65 | GJ |
| | | | | Sound power level, indoors | LWA | 52 | dB |
| | | | | Emissions of nitrogen oxides | NOx | 43 | mg/kWh |
| For combination heaters: | | | | | | | |
| Declared load profile | XXL | | | Water heating energy efficiency | η_{wh} | 88 | % |
| Daily electricity consumption | Qelec | 0,158 | kWh | Daily fuel consumption | Qfuel | 27,482 | kWh |
| Annual electricity consumption | AEC | 35 | kWh | Annual fuel consumption | AFC | 22 | GJ |
| (*) High-temperature regime means 60 °C return temperature at heater inlet and 80 °C feed temperature at heater outlet. | | | | | | | |
| (**) Low temperature means for condensing boilers 30 °C, for low-temperature boilers 37 °C and for other heaters 50 °C return temperature (at heater inlet). | | | | | | | |

VISION PLUS 40C

| Seasonal space heating energy efficiency class | | | | Water heating energy efficiency class | | | |
|--|--------|-------|------|--|-------------|--------|--------|
| A | | | | A | | | |
| Parameter | Symbol | Value | Unit | Parameter | Symbol | Value | Unit |
| Rated heat output | Prated | 29 | kW | Seasonal space heating energy efficiency | η_s | 92 | % |
| For boiler space heaters and boiler combination heaters: useful heat output | | | | For boiler space heaters and boiler combination heaters: useful efficiency | | | |
| At rated heat output and high-temperature regime (*) | P4 | 29,3 | kW | At rated heat output and high-temperature regime (*) | η_4 | 87,6 | % |
| At 30% of rated heat output and low-temperature regime (**) | P1 | 9,7 | kW | At 30% of rated heat output and low-temperature regime (**) | η_1 | 96,5 | % |
| Auxiliary electricity consumption | | | | Other parameters | | | |
| At full load | elmax | 41,0 | W | Stand-by heat loss | Pstby | 38,0 | W |
| At part load | elmin | 14,0 | W | Pilot flame energy consumption | Pign | - | W |
| In Stand-by mode | PSB | 3,0 | W | Annual energy consumption | QHE | 65 | GJ |
| | | | | Sound power level, indoors | LWA | 52 | dB |
| | | | | Emissions of nitrogen oxides | NOx | 43 | mg/kWh |
| For combination heaters: | | | | | | | |
| Declared load profile | XXL | | | Water heating energy efficiency | η_{wh} | 86 | % |
| Daily electricity consumption | Qelec | 0,167 | kWh | Daily fuel consumption | Qfuel | 28,125 | kWh |
| Annual electricity consumption | AEC | 37 | kWh | Annual fuel consumption | AFC | 22 | GJ |
| (*) High-temperature regime means 60 °C return temperature at heater inlet and 80 °C feed temperature at heater outlet. | | | | | | | |
| (**) Low temperature means for condensing boilers 30 °C, for low-temperature boilers 37 °C and for other heaters 50 °C return temperature (at heater inlet). | | | | | | | |

NOTE (if the outdoor temperature sensor or the control panel, or even both devices, are present in the boiler)

With reference to the Delegated Regulation (EU) No. 811/2013, the information in the table can be used for completing the product data sheet and the labelling for room heating appliances, for mixed heating appliances, for all those appliances for enclosed space heating, for temperature control devices and solar devices:

| ADDED DEVICES | CLASS | BONUS |
|---|-------|-------|
| OUTDOOR TEMPERATURE SENSOR | II | 2% |
| CONTROL PANEL* | V | 3% |
| OUTDOOR TEMPERATURE SENSOR + CONTROL PANEL* | VI | 4% |

(*) Set as ambient regulator

2.7 PUMP DUTY

Fig. 4 shows the flow-rate available – after allowing for pressure loss through the appliance – for system requirements. When using this graph, apply only the pressure loss of the system.

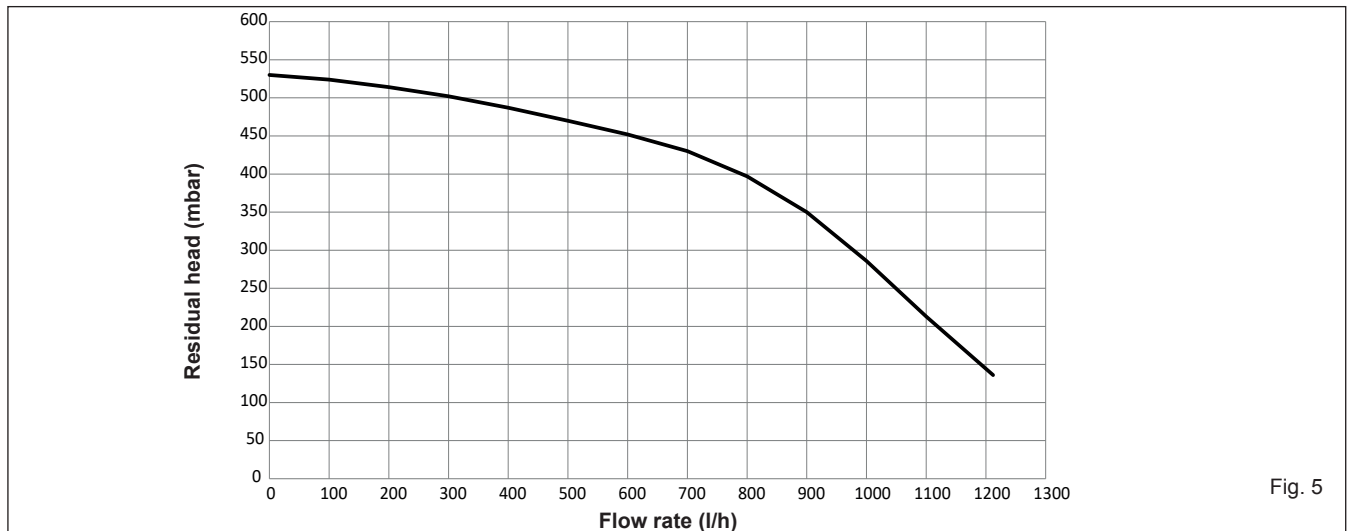

Fig. 5

2.8 HOW TO FREE THE PUMP

To “release” the seized rotor shaft:

- set boiler status to OFF by pressing button 1
- remove the casing as detailed in paragraph “4.7”
- remove the circulator cap
- with a slotted screwdriver, rotate the shaft being careful not to strain the seat (Fig. 6)
- to extract the connector holder, lever with a screwdriver as shown in Fig. 7
- refit the cap and press key 1 to select the type of operation desired.

Carry out the operation with extreme caution so as not to damage the components themselves.

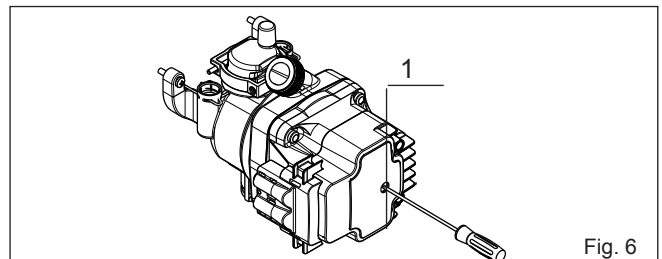

Fig. 6

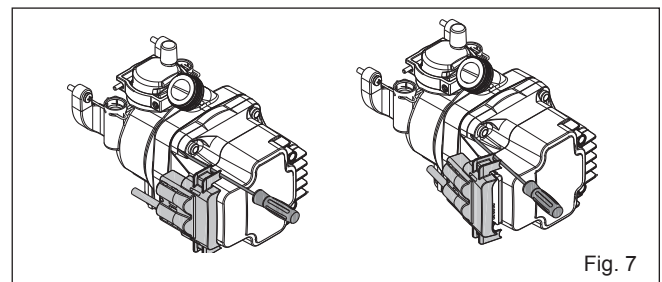

Fig. 7

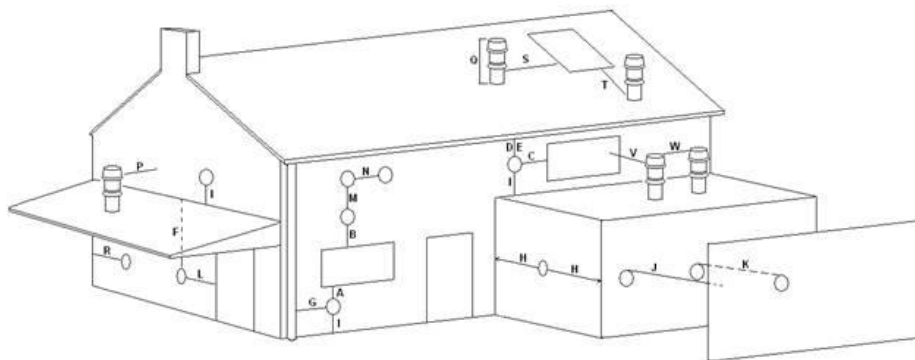

Fig. 8

| Key | Location | Minimum distance |
|-----|---|--|
| A | Below an opening (window, air-brick, etc.) | 300 mm |
| B | Above an opening (window, air-brick, etc.) | 300 mm |
| C | To the side of an opening (window, air-brick, etc.) | 300 mm |
| D | Below gutter, drain-pipe, etc. | 25 mm |
| E | Below eaves | 25 mm |
| F | Below balcony, car-port roof, etc. | 25 mm |
| G | To the side of a soil/drain-pipe, etc. | 25 mm (60mm for 80/125 - 5" flue) |
| H | From internal/external corner | 25 mm (60mm for 80/125 - 5" flue) |
| I | Above ground, roof, or balcony level | 300 mm |
| J | From a surface or boundary facing the terminal | 600 mm |
| K | From a terminal facing a terminal | 1200 mm |
| L | From an opening in the car-port into the building | 1200 mm |
| M | Vertically from a terminal on the same wall | 1500 mm |
| N | Horizontally from a terminal on the same wall | 300 mm |
| P | From a structure to the side of the vertical terminal | 300 mm |
| Q | From the top of the vertical terminal to the roof flashing | As determined by the fixed collar of the vertical terminal |
| R | To the side of a boundary | 300 mm |
| S | To the side of an opening or window on a pitched roof | 600 mm |
| T | Below an opening or window on a pitched roof | 2000 mm |
| V | From a vertical terminal to an adjacent opening (window, air-brick, etc.) | (call Vokera technical for advice) |
| W | From a vertical terminal to an adjacent vertical terminal | 300 mm (only if both terminals are the same height) |

3 GENERAL REQUIREMENTS (UK)

This appliance must be installed by a competent person in accordance with the Gas Safety (Installation & Use) Regulations.

3.1 RELATED DOCUMENTS

The installation of this boiler must be in accordance with the relevant requirements of the Gas Safety (Installation & Use) Regulations, the local building regulations, the current I.E.E. wiring regulations, the bylaws of the local water authority, the Building Standards (Scotland) Regulation and Building Standards (Northern Ireland) Regulations.

It should be in accordance also with any relevant requirements of the local authority and the relevant recommendations of the following British Standard Codes of Practice.

ATTENTION

The use of PPE (Personal Protective Equipment) such as but not limited to gloves, mask, safety glasses, etc. is strongly recommended whenever carrying out the installation, repair, or maintenance of this appliance – please pay particular attention to:

- Sharp edges that may be encountered when:- handling or lifting the appliance, removing parts, etc. during installation and maintenance
- Airborne particles that may be released and/or disturbed when cleaning or removing components during maintenance
- Water treatment chemicals that could have been added to the system water may spill from the appliance and or components during maintenance

Please refer to an appropriate Health and Safety document such as HSE L23 (UK) or S.I. 299 (Ireland), for more detailed advice on safe working practices and procedures.

| | | |
|----------------|---------------|--|
| BS 5440 | PART 1 | FLUES |
| BS 5440 | PART 2 | FLUES & VENTILATION |
| BS 5449 | PART 1 | FORCED CIRCULATION HOT WATER SYSTEMS |
| BS 5546 | | INSTALLATION OF GAS HOT WATER SUPPLIES FOR DOMESTIC PURPOSES |
| BS 6798 | | INSTALLATION OF BOILERS OF RATED INPUT NOT EXCEEDING 60kW |
| BS 6891 | | LOW PRESSURE INSTALLATION PIPES |
| BS 7074 | PART 1 | APPLICATION, SELECTION, AND INSTALLTION OF EXPANSION VESSELS AND ANCILLARY EQUIPMENT FOR SEALED WATER SYSTEMS |

3.2 LOCATION OF APPLIANCE

The appliance may be installed in any room or internal space, although particular attention is drawn to the requirements of the current I.E.E. wiring regulations, and in Scotland, the electrical provisions of the Building Regulations, with respect to the installation of the appliance in a room or internal space containing a bath or shower.

When an appliance is installed in a room or internal space containing a bath or shower, the appliance or any control pertaining to it must not be within reach of a person using the bath or shower. The location chosen for the appliance must permit the provision of a safe and satisfactory flue and termination. The location must also permit an adequate air supply for combustion purposes and an adequate space for servicing and air circulation around the appliance. Where the installation of the appliance will be in an unusual location special procedures may be necessary, BS 6798 gives detailed guidance on this aspect. A compartment used to enclose the appliance must be designed and constructed specifically for this purpose. An existing compartment/cupboard may be utilised provided that it is modified to suit. Details of essential features of compartment/cupboard design including airing cupboard installations are given in BS 6798. This appliance is not suitable for external installation.

3.3 GAS SUPPLY

The gas meter – as supplied by the gas supplier – must be checked to ensure that it is of adequate size to deal with the maximum rated input of all the appliances that it serves. Installation pipes must be fitted in accordance with BS 6891.

Pipe work from the meter to the appliance must be of adequate size. Pipes of a smaller size than the appliance gas inlet connection must not be used. The installation must be tested for tightness in accordance with BS6891.

If the gas supply serves more than one appliance, it must be ensured that an adequate supply is maintained to each appliance when they are in use at the same time.

NOTE

It is recognised that 'pressure loss' through the gas cock and gas valve may result in a pressure drop of approximately 2mbar between the gas meter and gas valve inlet test point; this will not impair the performance of the appliance, provided that a dynamic pressure of 18mbar is available at the appliance inlet.

3.4 FLUE SYSTEM

The terminal should be located where the dispersal of combustion products is not impeded and with due regard for the damage and discoloration that may occur to building products located nearby. The terminal must not be located in a place where it is likely to cause a nuisance (see "Fig. 8"). In cold and/or humid weather, water vapour will condense on leaving the terminal; the effect of such plumbing must be considered.

If installed less than 2m above a pavement or platform to which people have access (including balconies or flat roofs) the terminal must be protected by a guard of durable material. The guard must be fitted centrally over the terminal. Refer to BS 5440 Part 1, when the terminal is 0.5 metres (or less) below plastic guttering or 1 metre (or less) below painted eaves.

3.5 AIR SUPPLY

The following notes are intended for general guidance only. This appliance is a room-sealed, fan-flued boiler, consequently it does not require a permanent air vent for combustion air supply. When installed in a cupboard or compartment, ventilation for cooling purposes is also not required.

3.6 WATER CIRCULATION

Detailed recommendations are given in BS 5449 Part 1 and BS 6798. The following notes are for general guidance only.

3.6.1 PIPEWORK

It is recommended that copper tubing to BS 2871 Part 1 is used in conjunction with soldered capillary joints. Where possible pipes should have a gradient to ensure air is carried naturally to air release points and that water flows naturally to drain cocks. Except where providing useful heat, pipes should be insulated to avoid heat loss and in particular to avoid the possibility of freezing. Particular attention should be paid to pipes passing through ventilated areas such as under floors, loft space and void areas.

3.6.2 AUTOMATIC BY-PASS

The appliance has a built-in automatic by-pass, consequently there is no requirement for an external by-pass, however the design of the system should be such that it prevents boiler 'cycling'.

3.6.3 DRAIN COCKS

These must be located in accessible positions to facilitate draining of the appliance and all water pipes connected to the appliance. The drain cocks must be manufactured in accordance with BS 2879.

3.6.4 AIR RELEASE POINTS

These must be positioned at the highest points in the system where air is likely to be trapped. They should be used to expel trapped air and allow complete filling of the system.

3.6.5 EXPANSION VESSEL

The appliance has an integral expansion vessel to accommodate the increased volume of water when the system is heated. It can accept up to 9 litres of expansion from within the system, generally this is sufficient, however if the system has an unusually high water content, it may be necessary to provide additional expansion capacity (see 7.21).

3.6.6 FILLING POINT

A method for initial filling of the system and replacing water lost during servicing etc. directly from the mains supply, is required (see "Fig. 17"). This method of filling should comply with the current Water Supply (Water Fittings) Regulations 1999 and Water Bylaws 2000 (Scotland). If an alternative location is preferred, it should be connected as detailed in Fig. 9.

3.6.7 LOW PRESSURE SEALED SYSTEM

An alternative method of filling the system would be from an independent make-up vessel or tank mounted in a position at least 1 metre above the highest point in the system and at least 5 metres above the boiler (see "Fig. 10").

The cold feed from the make-up vessel or tank must be fitted with an approved non-return valve and stopcock for isolation purposes. The feed pipe should be connected to the return pipe as close to the boiler as possible.

3.6.8 FREQUENT FILLING

Frequent filling or venting of the system may be indicative of a leak. Care should be taken during the installation of the appliance to ensure all aspects of the system are capable of withstanding pressures up to at least 3 bar.

3.7 ELECTRICAL SUPPLY

The appliance is supplied for operation on 230V @ 50Hz electrical supply; it must be protected with a 3-amp fuse. The method of connection to the mains electricity supply must allow for complete isolation from the supply. The preferred method is by using a double-pole switch fused spur with a contact separation of at least 3.5mm (3° high-voltage category). The switch must only supply the appliance and its corresponding controls, i.e. time clock, room thermostat, etc. Alternatively an un-switched shuttered socket with a fused 3-pin plug both complying with BS 1363 is acceptable.

NOTE

Vokera Ltd. cannot guarantee the performance or reliability of the appliance if/when it is supplied via an inverter or generator; in particular those that incorporate a 'floating' earth or 'modified' sine wave.

Warning!

This appliance must be earthed.

3.8 MOUNTING ON A COMBUSTIBLE SURFACE

The appliance can be mounted on a wall of combustible material without any requirement to fit any additional protective (fire-resistant) material.

3.9 TIMBER FRAMED BUILDINGS

If the appliance is to be fitted in a timber framed building, it should be fitted in accordance with the Institute of Gas Engineers publication (IGE/UP/7) 'Guide for Gas Installations in Timber Frame Buildings'.

3.10 WATER TREATMENT

Vokera recommend that an inhibitor - suitable for use with stainless-steel heat exchangers - is used to protect the boiler and system from the effects of corrosion and/or electrolytic action. The inhibitor must be administered in strict accordance with the manufacturer's instructions*.

*Water treatment of the complete heating system - including the boiler - should be carried out in accordance with BS 7593 and the Domestic Water Treatment Association's (DWTA) code of practice. Vokera recommend that water treatment be carried out in accordance with the Benchmark Guidance on water treatment in central heating systems. If water treatment products are to be used, then they must be entirely suitable for use with an Stainless-steel heat exchanger. Any water treatment product, must be administered in strict accordance with the manufacturer's instructions.

If the appliance is to be installed to an existing system; water treatment and flushing of the complete heating system should be carried out in accordance with BS 7593 and the Benchmark Guidance on water treatment in central heating systems.

3.11 SHOWERS

If the appliance is intended for use with a shower, the shower must be thermostatically controlled and be suitable for use with a combination boiler.

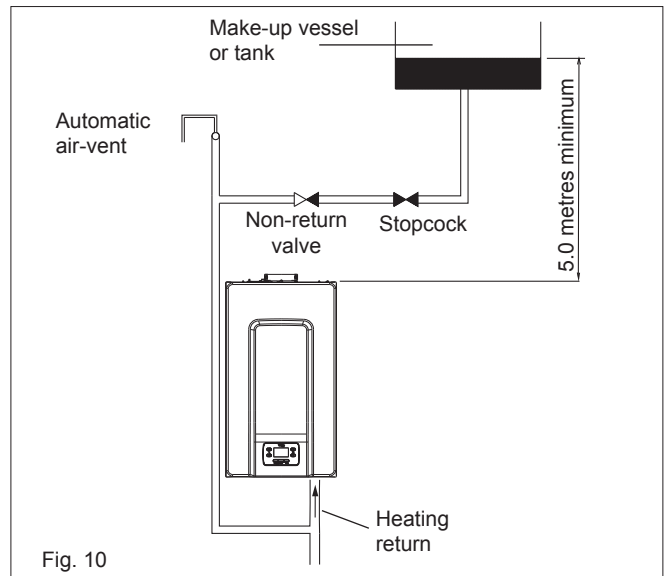
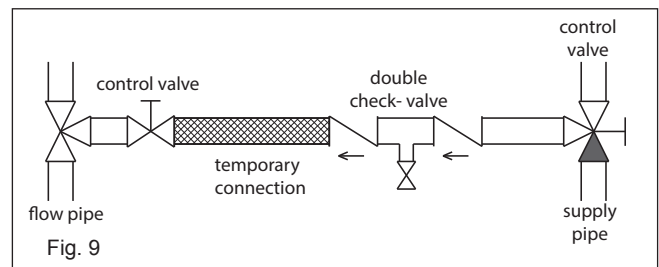

3E GENERAL REQUIREMENTS (EIRE)

This appliance must be installed by a competent person in accordance with and defined by, the Standard Specification (Domestic Gas Installations) Declaration (I.S. 813).

3.1E RELATED DOCUMENTS

The installation of this boiler must be in accordance with the relevant requirements of the local building regulations, the current ETCI National Rules for Electrical Installations and the bylaws of the local water undertaking.

It should be in accordance also with any relevant requirements of the local and/or district authority.

ATTENTION

The use of PPE (Personal Protective Equipment) such as but not limited to gloves, mask, safety glasses, etc. is strongly recommended whenever carrying out the installation, repair, or maintenance of this appliance – please pay particular attention to:

- Sharp edges that may be encountered when:- handling or lifting the appliance, removing parts, etc. during installation and maintenance

- Airborne particles that may be released and/or disturbed when cleaning or removing components during maintenance
- Water treatment chemicals that could have been added to the system water may spill from the appliance and or components during maintenance

Please refer to an appropriate Health and Safety document such as HSE L23 (UK) or S.I. 299 (Ireland), for more detailed advice on safe working practices and procedures.

3.2E LOCATION OF APPLIANCE

The appliance may be installed in any room or internal space, although particular attention is drawn to the requirements of the current ETCI National Rules for Electrical Installations, and I.S. 813, Annex K. When an appliance is installed in a room or internal space containing a bath or shower, the appliance or any control pertaining to it must not be within reach of a person using the bath or shower. The location chosen for the appliance must permit the provision of a safe and satisfactory flue and termination. The location must also permit an adequate air supply for combustion purposes and an adequate space for servicing and air circulation around the appliance.

Where the installation of the appliance will be in an unusual location special procedures may be necessary, refer to I.S. 813 for detailed guidance on this aspect.

A compartment used to enclose the appliance must be designed and constructed specifically for this purpose. An existing compartment/cupboard may be utilised provided that it is modified to suit.

This appliance is not suitable for external installation.

3.3E GAS SUPPLY

The gas meter – as supplied by the gas supplier – must be checked to ensure that it is of adequate size to deal with the maximum rated input of all the appliances that it serves. Installation pipes must be fitted in accordance with I.S. 813.

Pipe work from the meter to the appliance must be of adequate size. Pipes of a smaller size than the appliance gas inlet connection must not be used. The installation must be tested for tightness in accordance with I.S. 813.

If the gas supply serves more than one appliance, it must be ensured that an adequate supply is maintained to each appliance when they are in use at the same time.

NOTE

It is recognised that 'pressure loss' through the gas cock and gas valve may result in a pressure drop of approximately 2mbar between the gas meter and gas valve inlet test point; this will not impair the performance of the appliance, provided that a dynamic pressure of 18mbar is available at the appliance inlet.

3.4E FLUE SYSTEM

The terminal should be located where the dispersal of combustion products is not impeded and with due regard for the damage and discoloration that may occur to building products located nearby. The terminal must not be located in a place where it is likely to cause a nuisance (see I.S. 813).

In cold and/or humid weather, water vapour will condense on leaving the terminal; the effect of such plumbing must be considered.

If installed less than 2m above a pavement or platform to which people have access (including balconies or flat roofs) the terminal must be protected by a guard of durable material. The guard must be fitted centrally over the terminal. Refer to I.S. 813, when the terminal is 0.5 metres (or less) below plastic guttering or 1 metre (or less) below painted eaves.

3.5E AIR SUPPLY

The following notes are intended for general guidance only. This appliance is a room-sealed, fan-flued boiler, consequently it does not require a permanent air vent for combustion air supply. When installed in a cupboard or compartment, ventilation for cooling purposes is also not required.

3.6E WATER CIRCULATION

Specific recommendations are given in I.S. 813. The following notes are for general guidance only.

3.6.1E PIPEWORK

It is recommended that copper tubing be used in conjunction with soldered capillary joints.

Where possible pipes should have a gradient to ensure air is carried naturally to air release points and that water flows naturally to drain cocks.

Except where providing useful heat, pipes should be insulated to avoid heat loss and in particular to avoid the possibility of freezing. Particular attention should be paid to pipes passing through ventilated areas such as under floors, loft space and void areas.

3.6.2E AUTOMATIC BY-PASS

The appliance has a built-in automatic by-pass, consequently there is no requirement for an external by-pass, however the design of the system should be such that it prevents boiler 'cycling'.

3.6.3E DRAIN COCKS

These must be located in accessible positions to facilitate draining of the appliance and all water pipes connected to the appliance.

3.6.4E AIR RELEASE POINTS

These must be positioned at the highest points in the system where air is likely to be trapped. They should be used to expel trapped air and allow complete filling of the system.

3.6.5E EXPANSION VESSEL

The appliance has an integral expansion vessel to accommodate the increased volume of water when the system is heated. Refer to the specification table for more detailed information.

3.6.6E FILLING POINT

A method for initial filling of the system and replacing water lost during servicing etc. directly from the mains supply, should be provided (see "Fig. 17"). This method of filling complies with the current Water Supply (Water Fittings) Regulations 1999 and Water Bylaws 2000 (Scotland).

3.6.7E LOW PRESSURE SEALED SYSTEM

An alternative method of filling the system would be from an independent make-up vessel or tank mounted in a position at least 1 metre above the highest point in the system and at least 5 metres above the boiler (see "Fig. 10"). The cold feed from the make-up vessel or tank must be fitted with an approved non-return valve and stopcock for isolation purposes. The feed pipe should be connected to the return pipe as close to the boiler as possible.

3.6.8E FREQUENT FILLING

Frequent filling or venting of the system may be indicative of a leak. Care should be taken during the installation of the appliance to ensure all aspects of the system are capable of withstanding pressures up to at least 3 bar.

3.7E ELECTRICAL SUPPLY

The appliance is supplied for operation on 230V @ 50Hz electrical supply; it must be protected with a 3-amp fuse. The method of connection to the mains electricity supply must allow for complete isolation from the supply. The preferred method is by using a double-pole switch fuse spur with a contact separation of at least 3,5 mm (3° high-voltage category). The switch must only supply the appliance and its corresponding controls, i.e. time clock, room thermostat, etc.

NOTE

Vokera Ltd. cannot guarantee the performance or reliability of the appliance if/when it is supplied via an inverter or generator; in particular those that incorporate a 'floating' earth or 'modified' sine wave.

3.8E MOUNTING ON A COMBUSTIBLE SURFACE

The appliance can be mounted on a wall of combustible material without any requirement to fit any additional protective (fire-resistant) material.

3.9E TIMBER FRAMED BUILDINGS

If the appliance is to be fitted in a timber framed building, it should be fitted in accordance with I.S. 813 and local Building Regulations.

The Institute of Gas Engineers publication (IGE/UP/7) 'Guide for Gas Installations in Timber Frame Buildings' gives specific advice on this type of installation.

3.10E WATER TREATMENT

Vokera recommend that an inhibitor - suitable for use with Stainless-steel heat exchangers - is used to protect the boiler and system from the effects of corrosion and/or electrolytic action. The inhibitor must be administered in strict accordance with the manufacturers instructions*.

*Water treatment of the complete heating system - including the boiler - should be carried out in accordance with BS 7593 and the Domestic Water Treatment Association's (DWTA) code of practice. Vokera recommend that water treatment be carried out in accordance with the Benchmark Guidance on water treatment in central heating systems. If water treatment products are to be used, then they must be entirely suitable for use with an Stainless-steel heat exchanger. Any water treatment product, must be administered in strict accordance with the manufacturer's instructions.

If the appliance is to be installed to an existing system; water treatment and flushing of the complete heating system should be carried out in accordance with BS 7593 and the Benchmark Guidance on water treatment in central heating systems.

3.11E SHOWERS

If the appliance is intended for use with a shower, the shower must be thermostatically controlled and be suitable for use with a combination boiler.

3.12E DECLARATION OF CONFORMITY

A Declaration of Conformity (as defined in I.S. 813) must be provided on completion of the installation.

A copy of the declaration must be given to the responsible person and also to the gas supplier if required.

4 INSTALLATION

NOTE

Please refer to 3 - 3E and use the appropriate PPE when carrying out any of the actions or procedures contained within this section.

4.1 PREPARATION FOR MOUNTING THE APPLIANCE

The appliance should be mounted on a smooth, vertical surface, which must be capable of supporting the full weight of the appliance. Care should be exercised when determining the position of the appliance with respect to hidden obstructions such as pipes, cables, etc.

When the position of the appliance has been decided – using the template supplied – carefully mark the position of the wall mounting bracket (see Fig. 11) and flue-hole (if applicable).

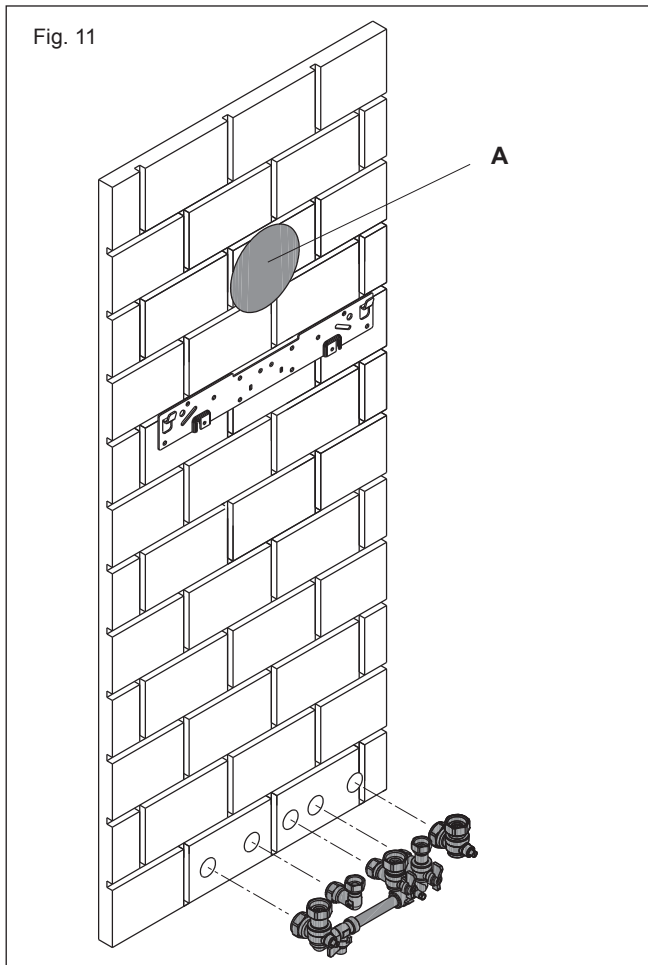

Fig. 11

4.2 FITTING THE FLUE

This appliance incorporates a 'click-fit' flue connection at the top of the appliance.

4.2.1 CONCENTRIC HORIZONTAL FLUE

These instructions relate specifically to the installation of this appliance with the Vokera 60/100mm 'X-type' (click-fit) flue terminals accessories. For specific instructions on installing this appliance with an alternative Vokera flue system, e.g. 80/125mm; please refer to the instructions supplied with the specific flue system, or download the instructions from the Vokera website. The appliance flue outlet elbow can be rotated through 360° on its vertical axis. In addition the flue may be extended from the outlet elbow in the horizontal plane. A reduction must also be made to the maximum length (see table below) when additional bends are used.

Reduction for additional bends

| Bend | Reduction in maximum flue length for each bend |
|----------|--|
| 45° bend | 1.0 metre |
| 90° bend | 1.0 metre |

Horizontal flue terminals and accessories

| Part No. | Description | Length |
|----------|------------------------------|-----------|
| 20122759 | Standard horizontal flue Kit | 900mm |
| 20122761 | Telescopic flue kit | 700mm |
| 20132059 | 90-degree bend | N/A |
| 20132058 | 45-degree bend (2) | N/A |
| 20132060 | 500mm extension | 500mm |
| 20132061 | 1000mm extension | 1000mm |
| 20132062 | 2000mm extension | 2000mm |
| 20131979 | telescopic extension | 372/519mm |
| 522 | plume management kit | 1370mm |
| 20135587 | 100mm flue brackets (5) | N/A |

Fig. 11: Using the template (A) provided with the kit, mark and drill a 125mm hole (B) for the passage of the flue pipe. The hole should be drilled to ensure any condense fluid that forms, is allowed to drain back to the appliance. The fixing holes for the wall-mounting bracket should now be drilled and plugged, an appropriate type and quantity of fixing should be used to ensure that the bracket is mounted securely. Once the bracket has been secured to the wall, mount the appliance onto the bracket.

NOTE PRE-FIXING JIG

A 'Pre-fixing Jig' is available as an accessory (code 20177531), should it be necessary to pre-fabricate the appliance pipework, i.e. first-fix, prior to installing the appliance.

4.2.2 FITTING THE TELESCOPIC HORIZONTAL FLUE KIT

In some instances it may necessary to cut the inner 60mm pipe of the flue bend at the point indicated (Fig. 13- pos. A) to allow for easier insertion to the boiler flue spigot.

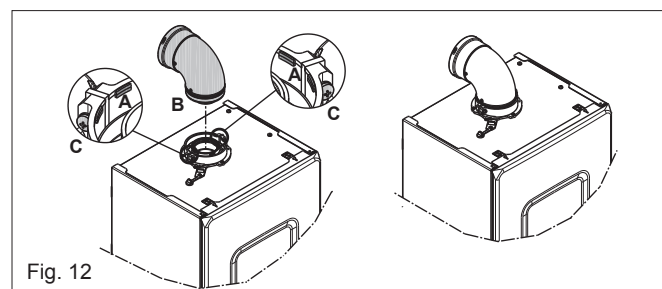

Fig. 12

4.2.3 FITTING THE HORIZONTAL FLUE KIT

Carefully measure the distance from the centre of the appliance flue outlet to the edge of the finished outside wall (dimension X). Add 65mm to dimension X to give you Dimension Y (see Fig. 13). Measure dimension Y from the terminal end of the concentric flue pipe and cut off the excess ensuring any burrs are removed. Pass the concentric flue pipe through the previously drilled hole. Fit the flue bend to the boiler flue outlet and insert the concentric flue pipe into the flue bend ensuring the correct seal is made.

NOTE (Fig. 14): The appliance incorporates a 'click-fit' flue connection. Ensure that both screws 'C' on the 'click-fit' have been slackened off. Ensure that the connector is correctly aligned with the 'click-fit' and insert it into the 'click-fit' until it clicks into position (this is when the tabs at points 'A' are located in the groove of the flue bend connector). Both screws (C) should now be tightened.

NOTE

Fit the internal (white) trim to the flue assembly prior to connecting the flue pipe to the bend. You must ensure that the entire flue system is properly supported and connected. Seal the flue assembly to the wall using cement or a suitable alternative that will provide satisfactory weatherproofing. The exterior trim can now be fitted.

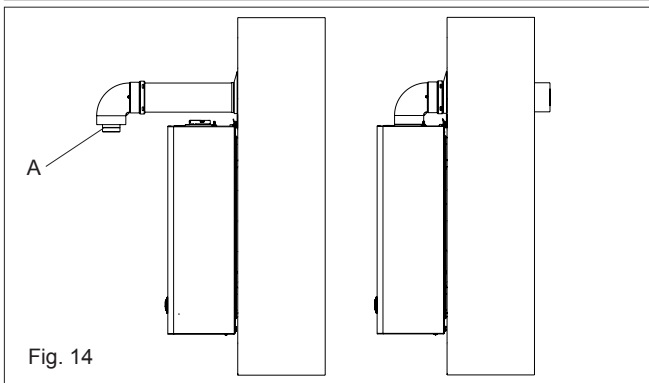
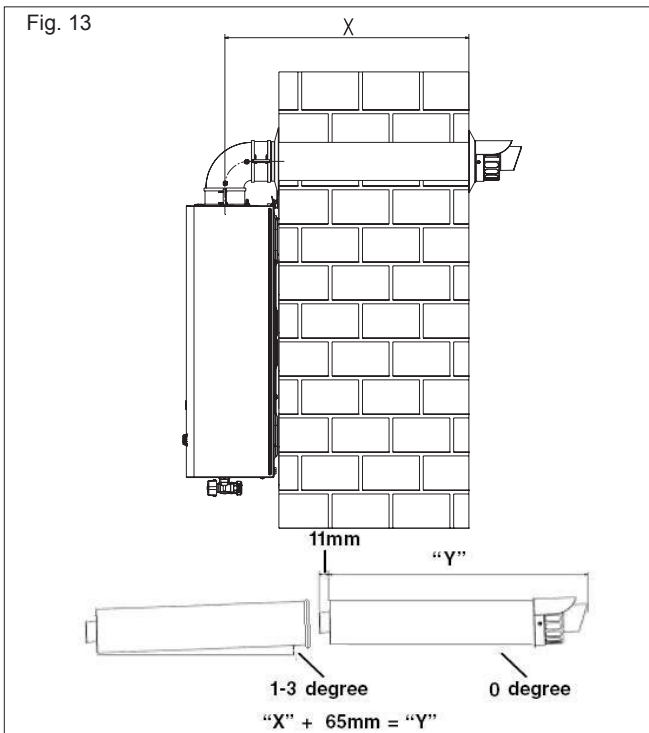

4.2.4 EXTENDING THE FLUE

Connect the bend – supplied with the terminal kit – to the top of the boiler using clamp (supplied). The additional bends & extensions have push-fit connections, care should be taken to ensure that the correct seal is made when assembling the flue system. Connect the required number of flue extensions or bends (up to the maximum equivalent flue length) to the flue terminal (Fig. 15). The flue system should have a 3° rise from the boiler to outside, to ensure any condense fluid that forms, is allowed to drain back to the appliance.

NOTE

When cutting an extension to the required length, you must ensure that the excess is cut from the plain end of the extension (Fig. 15). Remove any burrs, and check that all seals are located properly. You must ensure that the entire flue system is properly supported and connected. Seal the flue assembly to the wall using cement or a suitable alternative that will provide satisfactory weatherproofing. The interior and exterior trim can now be fitted.

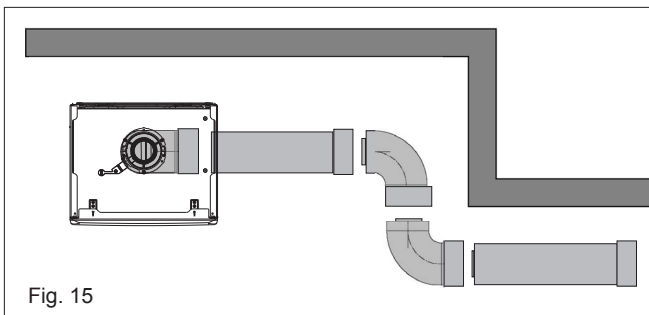

4.5.2 CONCENTRIC VERTICAL FLUE

Using Fig. 17 as a reference, cut a 110mm diameter hole in the roof and/or ceiling to facilitate the route of the vertical flue system. **NOTE:** ensure that the top of the appliance - if already in position - is covered and protected from the possibility of any dust or debris falling or entering the appliance via the flue outlet.

Fit the appropriate flashing to the roof and insert the vertical flue terminal through the flashing from outside, ensuring that the collar of the terminal is located over the outlet of the flashing.

The fixing holes for the appliance wall mounting bracket should now be drilled and plugged. An appropriate type and quantity of fixing should be used to ensure that the bracket is mounted securely. Once the bracket has been secured to the wall, mount the appliance onto the bracket.

If the vertical flue system requires additional extensions or bends, connect these to the vertical terminal, ensuring the following:

- the maximum permitted flue length is not exceeded
- reductions to the maximum flue length have been made for any bends that are used on the vertical flue system
- any horizontal sections of the flue system, incorporate a 3-degree fallback to the appliance
- the entire flue system is fully supported and secured using the appropriate brackets
- if/when an extension is cut to a shorter length, ensure that the excess length is cut from the plain end of the extension, and that any burrs or rough edges are removed
- all seals are properly located before assembling or connecting the flue system.

IMPORTANT: The VX flue terminal is supplied with a sachet of silicone lubricant; smear a small amount of the lubricant around both inner and outer connections, at both ends of the vertical flue connector (supplied with the VX terminal).

NOTE (Fig. 14): The appliance incorporates a 'click-fit' flue connection. Ensure that both screws 'C' on the 'click-fit' have been slacked off. Ensure that the connector is correctly aligned with the 'click-fit' and insert it into the 'click-fit' until it clicks into position (this is when the tabs at points 'A' are located in the groove of the vertical flue connector). Both screws (C) should now be tightened.

NOTE: If more convenient, the vertical flue connector can be attached to the vertical flue terminal/extension before connecting it to the appliance.

NOTE

Additional bends and/or extensions can be connected to the terminal connector if desired, however if additional bends are fitted, a reduction must be made to the maximum flue length (see table below).

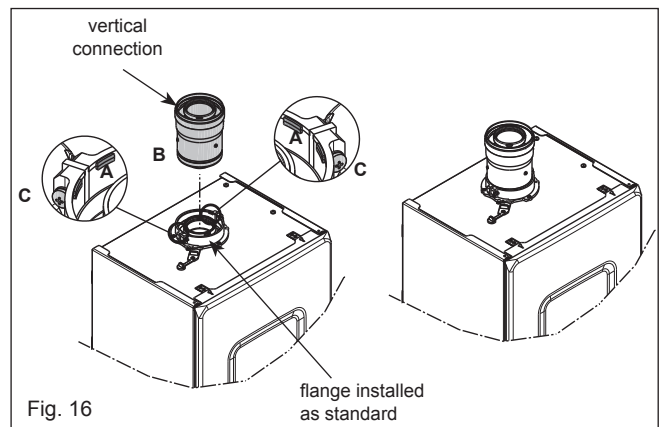

Reduction for bends

| Bend | Reduction in maximum flue length for each bend |
|----------|--|
| 45° bend | 1.0 metre |
| 90° bend | 1.0 metre |

Vertical Flue Terminals & Accessories

| Code | Description | Length |
|----------|-------------------------|-----------|
| 20122763 | Vertical Flue Kit | 1000mm |
| 20132059 | 90-degree bend | N/A |
| 20132058 | 45-degree bend (2) | N/A |
| 20132060 | 500mm extension | 500mm |
| 20132061 | 1000mm extension | 1000mm |
| 20132062 | 2000mm extension | 2000mm |
| 20131979 | telescopic extension | 372/519mm |
| 20135587 | 100mm flue brackets (5) | N/A |
| 20132050 | pitched roof flashing | N/A |
| 20135582 | flat roof flashing | N/A |

IMPORTANT

The vertical flue terminal is 1.0 metre in length and cannot be cut; therefore it may be necessary to adjust the height of the appliance to suit or use a suitable extension.

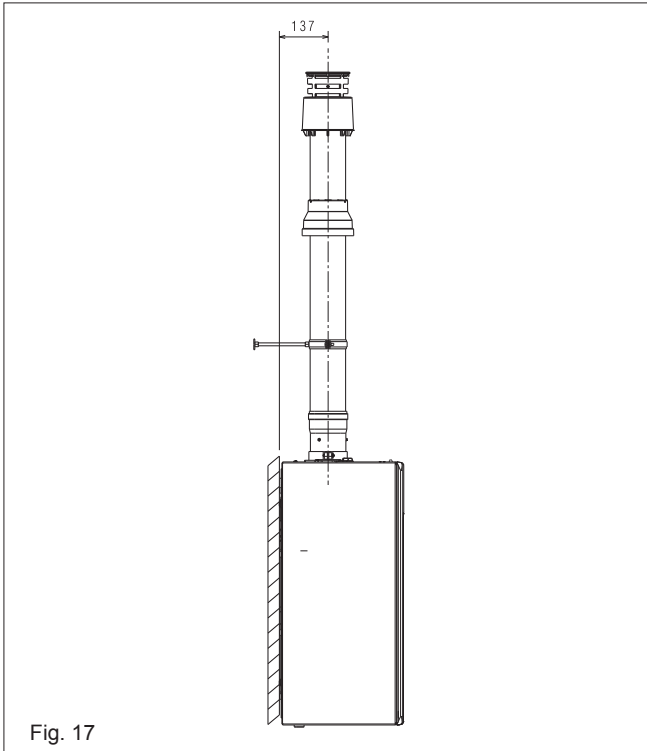

Fig. 17

4.3 CONNECTING THE GAS AND WATER ("FIG. 17")

The appliance is supplied with an accessory pack that includes service valves. The service valves are of the compression type. The accessory pack contains sealing washers' etc, for use with the service valves. When connecting pipe work to the valves, tighten the compression end first then insert the sealing washers before tightening the valve to the appliance.

NOTE

It will be necessary to hold the valve with one spanner whilst tightening with another.

4.3.1 GAS

The appliance is supplied with a 15mm service valve, connect a 15mm pipe to the inlet of the valve and tighten both nuts.

NOTE

It will be necessary to calculate the diameter of the gas supply pipe to ensure the appliance has an adequate supply of gas.

4.3.2 FLOW & RETURN

The appliance is supplied with 22mm service valves for the flow and return connections, connect a 22mm pipe to the inlet of each valve and tighten both nuts.

NOTE

Depending on system requirements, it may necessary to increase the size of the flow & return pipe work after the service valve connections.

4.3.3 COLD WATER INLET

The appliance is supplied with a 15mm stopcock, connect a 15mm pipe to the inlet of the stopcock and tighten both nuts.

4.3.4 HOT WATER OUTLET

The appliance is supplied with a 15mm outlet connection, connect a 15mm pipe to the outlet connection and tighten both nuts.

4.3.5 SAFETY VALVE

Connect the safety valve connection pipe to the safety valve outlet and tighten. The discharge pipe must have a continuous fall away from the appliance to outside and allow any water to drain away thereby eliminating the possibility of freezing.

The discharge pipe must terminate in a position where any water - possibly boiling - discharges safely without causing damage or injury, but is still visible.

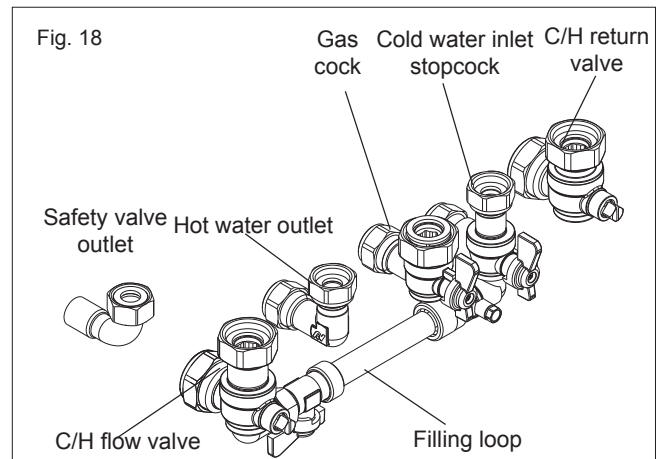

4.3.6 CONDENSE PIPE

This appliance will - under normal operating conditions - produce condensate fluid that will require to be disposed of via the dwelling's waste water drainage system.

Vokera strongly recommends that the condensate pipe is connected to the internal waste water pipework in accordance with BS6798. BS6798 provides comprehensive instruction and advice on all permissible condensate disposal methods; notwithstanding this, it is essential that the following is strictly adhered to:

Use only plastic drainage pipe (minimum OD of 21.5mm).

Horizontal runs must incorporate a minimum 45mm fall per metre, away from the appliance.

External pipework and/or pipework in unheated areas, must have a minimum OD of 32mm and be insulated with Class-O pipe insulation.

The route, type, and termination of the condensate disposal method, must not permit any spillage of condensate fluid, into the dwelling in the event of a blockage or freezing of the condensate pipework. Should it not be possible to route and terminate the condensate pipework internally using 'gravity discharge'; Vokera recommends that the Vokera condensate pump (code 404) be considered as an alternative solution.

Ensure that the end-user is aware of the effect/consequences of the condensate pipework becoming blocked or frozen.

4.4 INSTALLATION OF CONDENSATE DRAIN PIPE

Before starting the boiler, even just temporarily, the SRD device supplied must be installed.

The manufacturer does NOT accept liability for damage to persons or objects caused by the boiler operating without the SRD device being installed correctly.

For the installation proceed as follows:

- remove the plug (T) from the siphon
- fix the SRD device to the siphon, placing the gasket in-between, screwing it on all the way and checking its seal
- connect the condensate discharge pipe supplied as standard with the product, then drain the condensate into a suitable drainage system in compliance with current norms.

If it is not possible to fit the SRD device due to the interference with other objects under the boiler, it is possible to fit it in a different position by inserting a connecting pipe between the SRD device and the siphon in order to provide a fully airtight seal. The SRD device should always be positioned VERTICALLY in order to ensure it functions correctly.

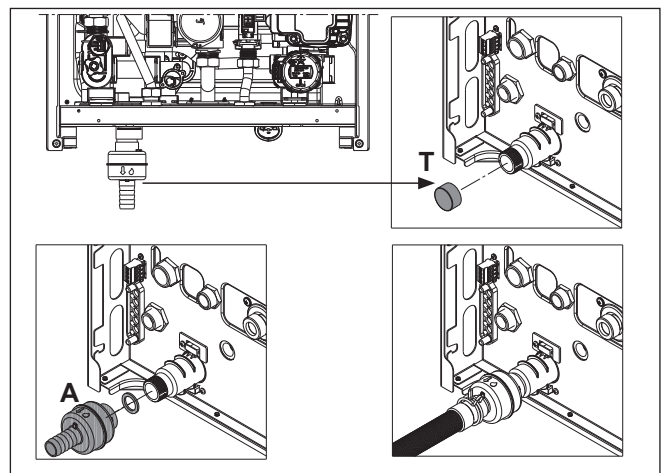

4.5 INSTRUCTION FOR CONDENSATION EXHAUST CONNECTION

This product is designed to prevent the escape of gaseous products of combustion through the condensation drain pipe with which it is equipped, this is obtained by using a special siphon placed inside the appliance.

 All components of the product condensation drain system must be properly maintained in accordance with the manufacturer instructions and cannot be modified in any way.

The condensation exhaust system downstream of the appliance (1) must comply with the relevant legislation and standards. The construction of the condensation exhaust system downstream of the appliance is the responsibility of the installer. The condensation exhaust system must be dimensioned and installed in such a way as to guarantee the correct evacuation of the condensation produced by the appliance and/or collected by the evacuation systems of combustion products. All the components of the condensation exhaust system must be made in a workmanlike manner using materials that are suitable for withstanding the mechanical, thermal and chemical stresses of the condensation produced by the appliance over time.

Note: If the condensation exhaust system is exposed to the risk of frost, always provide an adequate level of insulation of the pipe and consider any increase in the diameter of the pipe itself.

The condensation exhaust pipe must always have an adequate slope level to prevent the condensation from stagnating and its proper drainage.

The condensation exhaust system must have an inspectable disconnection (2) between the condensation exhaust pipe of the appliance and the condensation exhaust system.

The disconnection must be such as to ensure an atmospheric connection between the inside of the condensation exhaust system pipe and the environment in order to avoid that the downstream exhaust pipe of the product can take on positive or negative pressure with respect to the environment itself. "Fig. 20": example of a connection between the condensation exhaust pipe (3) and the exhaust system (4).

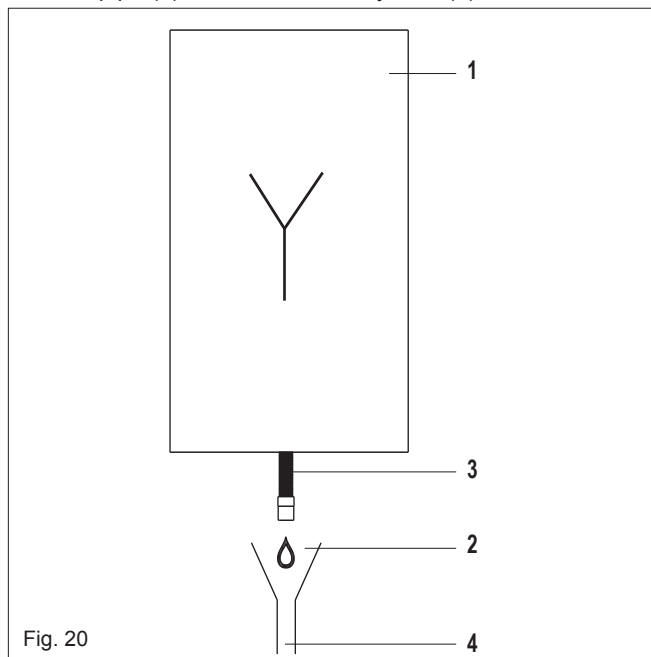

4.6 ELECTRICAL CONNECTIONS

The boiler is supplied with a short fly-lead. This lead can be used for connection to the electrical supply. Connect the fly-lead to a fused plug or fused isolator in the following way:

- brown wire to LIVE supply
- blue wire to NEUTRAL supply
- green/yellow to EARTH connection.

Insert the supplied 3-AMP fuse into the fused isolator or fused plug. Should the fly-lead be unsuitable, refer to 4.8 for details on how to connect the electrical supply directly to the boiler.

The electrical supply must be as specified in section 3/3E. A qualified electrician should connect the appliance to the electrical supply. If controls - external to the appliance - are required, a competent person must undertake the design of any external electrical circuits, please refer to section 8 for detailed instructions. ANY EXTERNAL CONTROL OR WIRING MUST BE SERVED FROM THE SAME ISOLATOR AS THAT OF THE APPLIANCE. The supply cable from the isolator to the appliance must be 3-core flexible sized 0.75mm to BS 6500 or equivalent. Wiring to the appliance must be rated for operation in contact with surfaces up to 90 °C.

4.7 CASING REMOVAL

To gain internal access to the appliance you must first remove the casing, proceed as outlined below:

- locate and unscrew the 2-screws (A) that secure the outer casing to the appliance
- lift the casing upward to disengage it from the top locating hooks and then remove
- store the casing and screws safely until required. Re-fit in the reverse order
- remove the screw below the control fascia and gently lower it until it rests.

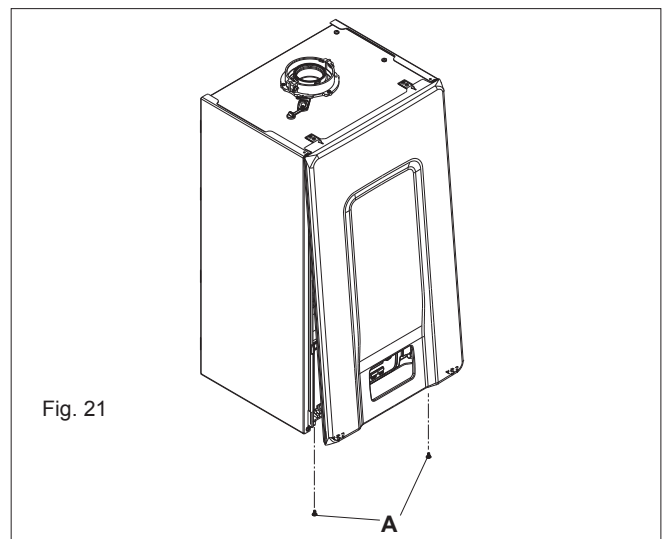

4.8 CONNECTING THE MAINS (230V) INPUT

Unhook and remove the terminal block cover (230V). Pass the cable through the cable anchorage point. Connect the supply cable wires (LIVE, NEUTRAL, & EARTH) to their corresponding terminals (L, N, & E) on the appliance – high voltage – terminal block. When connecting the EARTH wire, ensure that it's left slightly longer than the others, this will prevent strain on the EARTH wire unless additional external controls are to be fitted (see section 8) route the electrical supply via the cable entry/exit point and secure using the cable anchorage grip and screws.

The appliance comes with a factory fitted link ('TA') to allow basic operation of the boiler via the mode selector switch. If it is anticipated that external controls will be required please refer to the wiring diagrams in section 8 for more detailed information.

NOTE

It is the installer's responsibility to ensure that the appliance is properly Earthed. Vokèra Ltd. cannot be held responsible for any damages or injuries caused as a result of incorrect Earth wiring.

5 OPERATION

NOTE

Please refer to 3 - 3E and use the appropriate PPE when carrying out any of the actions or procedures contained within this section.

Ensure that steps 6.1 through to 6.6 have been completed before supplying the gas and electrical supply to the appliance.

5.1 ACCESS TO THE PARAMETERS

Pressing the MENU key for at least 2 sec provides access to the P1 menu, allowing the parameters to be programmed. If the menu is empty, P8.04 is displayed, otherwise the first item in the menu appears.

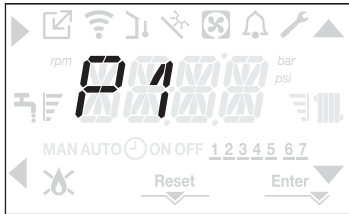

Access to the TECHNICAL parameters programming menu is password protected; pressing MENU a second time for at least 2sec, PWD is displayed blinking with a frequency of 0.5sec ON and 0.5sec OFF for 2sec.



Then <<0000>> is displayed blinking with a frequency of 0.5sec ON and 0.5sec OFF; the icons ▲, ▼, ► and ◀ come on to allow the password to be entered.



There are two levels of access to the parameters:

- INSTALLER
- SERVICE

(the user level does not require a password).

Set the password supplied by the manufacturer for the desired access level using the button at the ▲, ▼ arrows to enter the value.

Press the key A at the ► arrow to confirm.

Pressing key B at the ◀ arrow returns you to the previous level, exiting the P1 menu.

It is now possible to navigate the menu using the C and D arrow keys, confirming access to the sub-menu with arrow key A or else returning to the previous level using arrow key B.

Prolonged pressure at any point of the menu (>2sec) of the ◀ key returns you to the main page.

The interface also reverts automatically to the main screen if no key is pressed within 60sec.





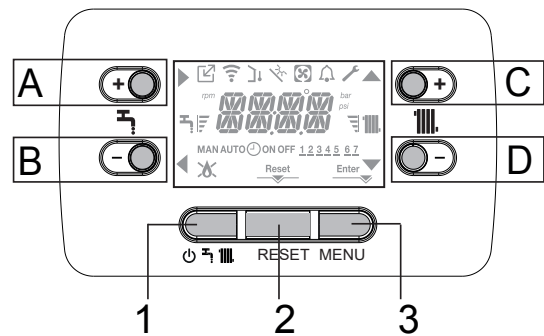

5.2 CONTROL PANEL

Your boiler is equipped with a large LCD display that indicates the appliance operating status.



| | |
|------------|--|
| A | It is normally used to raise the domestic hot water temperature, when the arrow ► is highlighted it has the confirm function |
| B | It is normally used to lower the domestic hot water temperature, when the arrow ◀ is highlighted it has the back/cancel function |
| A+B | Access to the domestic hot water comfort functions (see paragraph "5.8.9 Domestic hot water comfort function") |
| C | It is normally used to raise the heating water temperature, when the arrow ▲ is highlighted you can move inside the P1 menu |
| D | It is normally used to lower the heating water temperature, when the arrow ▼ is highlighted you can move inside the P1 menu |
| A+C | Access to the menu for setting the clock (see paragraph "5.4 STARTING THE BOILER") |
| 1 | Used to change the operating status of the boiler (OFF, SUMMER and WINTER) |
| 2 | Used to reset the alarm status or to interrupt the vent cycle |
| 3 | Used to access the INFO and P1 menus. When the icon Enter is shown on the display, the key has the ENTER function and is used to confirm the value set during the programming of a technical parameter |
| 1+3 | Lock and unlock keys |
| 2+3 | When the boiler is set to OFF it is used to start the combustion analysis function (CO) |

| | |
|--|---|
| | Indicates the connection to a remote device (OT or RS485) |
| | Indicates the connection to a WIFI device |
| | Indicates the presence of an outdoor temperature sensor |
| | Indicates the activation of special domestic hot water functions or the presence of a system for managing the solar thermal array |
| | Indicates the connection to a heat pump (not used on this model) |
| | Icon that lights up when there is an alarm |
| | It comes on when there is a fault together with the icon except for flame and water alarms |
| | Indicates the presence of a flame, in the event of a flame lockout the icon looks like |
| | It comes on when there are alarms that require a manual reset by the operator |
| | It comes on when there is an operation confirmation request |
| | When the icon is active, it indicates that the "confirm" function of button A is active |
| | When the icon is active, it indicates that the "back/cancel" function of button B is active |

| | |
|--|---|
|  | When the icon is active, it is possible to navigate the menu or raise the value of the selected parameter |
|  | When the icon is active, it is possible to navigate the menu or lower the value of the selected parameter |
|  | The icon comes on if central heating is active, it blinks if a heating request is in progress |
|  | The icon comes on if domestic hot water is active, it blinks if a domestic hot water request is in progress |
|  | They indicate the set point level set (1 notch minimum value, 4 notches maximum value) |
| 1 2 3 4 5 6 7 | Indicates the days of the week |
| AUTO  | Only if clock has been enabled |
| MAN ON | Only if clock has been enabled |
| MAN OFF | Only if clock has been enabled |

5.3 SETTINGS MENU TREE STRUCTURE

Below is a list of the parameters that can be programmed; if the adjustment board does not support the relative function, the interface returns an error message. Some of the information might not be available depending on the access level, the status of the machine or the system configuration.

| Menu | Parameters | Scrolling message only if parameter P1.05 = 1 | Value | Password level | Value set in the factory | Personalised values |
|-----------|------------|---|---|----------------|--------------------------|---------------------|
| P1 | | SETTINGS | | | | |
| | P1.01 | LANGUAGES | 0 IT 1 RO 2 FR 3 EN 4 SR 5 HR 6 ES 7 EL 8 BG 9 PL 10 SL | USER | | |
| | P1.02 | TIME | | USER | | |
| | P1.03 | TIME PROGRAMM | NOT AVAILABLE ON THIS MODEL | | | |
| | P1.05 | SCROLLING | 0 / 1 | USER | | |
| P3 | | CONFIGURATION | | | | |
| | P3.01 | HYDRAULIC CONFIGURATION | 0 / 1 / 2 / 3 / 4 | INSTALLER | 1 | |
| | P3.02 | WATER PRESSURE TRANSDUCER | 0 / 1 | SERVICE | 1 | |
| | P3.03 | AUTO FILL ENABLE | 0 / 1 | SERVICE | 0 | |
| | P3.04 | BEGIN SYSTEM FILLING | NOT AVAILABLE ON THIS MODEL | | | |
| | P3.05 | AIR PURGING CYCLE | 0 / 1 | SERVICE | 1 | |
| | P3.06 | MIN FAN SPEED | 1.200-3.600 | INSTALLER | see technical data table | |
| | P3.07 | MAX FAN SPEED | 3.700-9.999 | INSTALLER | see technical data table | |
| | P3.08 | SLOW IGNITION | MIN - MAX | INSTALLER | see technical data table | |
| | P3.09 | MAX FAN SPEED HTG | MIN - MAX | INSTALLER | see technical data table | |
| | P3.10 | RANGE RATED | MIN - MAX_CH | INSTALLER | see technical data table | |
| | P3.11 | CONFIG AUX 1 | 0 / 1 / 2 | INSTALLER | 0 | |
| | P3.12 | EXHAUST PROBE RESET | 0 / 1 | INSTALLER | 0 | |
| P4 | | HEATING | | | | |
| | P4.01 | HYST OFF HIGH TEMP | 2 - 10 | SERVICE | 5 | |
| | P4.02 | HYST ON HIGH TEMP | 2 - 10 | SERVICE | 5 | |
| | P4.03 | HYST OFF LOW TEMP | 2 - 10 | SERVICE | 3 | |
| | P4.04 | HYST ON LOW TEMP | 2 - 10 | SERVICE | 3 | |
| | P4.05 | PUMP CONTROL TYPE | 41-100 | INSTALLER | 85 | |
| | P4.08 | OT CASCADE CONTROL | NOT AVAILABLE ON THIS MODEL | | | |
| | P4.09 | SCREED FUNCTION | 0 / 1 | INSTALLER | 0 | |
| | P4.10 | ANTI CYCLE FUNCTION | 0 - 20min | INSTALLER | 3min | |
| | P4.11 | RESET CH TIMERS | 0 / 1 | INSTALLER | 0 | |
| | P4.12 | MAIN ZONE ACTUATION TYPE | 0 / 1 | INSTALLER | 0 | |
| | P4.13 | MAIN ZONE ADDRESS | 1 - 6 | INSTALLER | 3 | |
| | P4.14 | MAIN ZONE HYDRAULIC CONF | 0 / 1 | INSTALLER | 0 | |

| Menu | Parameters | Scrolling message only if parameter P1.05 = 1 | Value | Password level | Value set in the factory | Personalised values |
|-----------|------------|---|--|----------------|--------------------------|---------------------|
| | P4.15 | MAIN ZONE TYPE | 0 / 1 | INSTALLER | 0 | |
| | P4.16 | MAX CH SET | AT: MIN CH SET - 80.5 BT: MIN CH SET - 45.0 | INSTALLER | 80.5 | |
| | P4.17 | MIN CH SET | AT: 40 - MAX CH SET BT: 20 - MAX CH SET | INSTALLER | 40 | |
| | P4.18 | WEATHER COMP ENABLE | 0 / 1 | INSTALLER | 0 | |
| | P4.19 | WEATHER COMP CURVE | 1.0-3.0 → AT 0.2-0.8 → BT | INSTALLER | 2.0 | |
| | P4.20 | NIGHT COMPENSATION | 0 / 1 | INSTALLER | 0 | |
| | P4.21 | CH CLOCK ENABLE | DON'T MODIFY | INSTALLER | 0 | |
| | P4.22 | MODE SELECTION | DON'T MODIFY | INSTALLER | 0 | |
| | P4.23 | ZONE1 ENABLE | 0 / 1 | INSTALLER | 0 | |
| | P4.24 | ZONE1 ADDRESS | 1 - 6 | INSTALLER | 1 | |
| | P4.25 | ZONE1 HYDRAULIC CONFIG | 0 / 1 | INSTALLER | 0 | |
| | P4.26 | ZONE1 TYPE | 0 / 1 | INSTALLER | 0 | |
| | P4.27 | ZONE1 SET | ZONE1 MIN CH SET - ZONE1 MAX CH SET | USER | 40 - 80.5 | |
| | P4.28 | ZONE1 MAX CH SET | AT: ZONE1 MIN CH SET - 80,5 BT: ZONE1 MIN CH SET - 45,0 | INSTALLER | 80.5 | |
| | P4.29 | ZONE1 MIN CH SET | AT: 40 - ZONE1 MAX CH SET BT: 20 - ZONE1 MAX CH SET | INSTALLER | 40 | |
| | P4.30 | ZONE1 OTR | 0 / 1 | INSTALLER | 0 | |
| | P4.31 | ZONE1 OTD CURVES | 1.0-3.0 → AT 0.2-0.8 → BT | INSTALLER | 2.0 | |
| | P4.32 | ZONE1 NIGHT COMP | 0 / 1 | INSTALLER | 0 | |
| P5 | | DHW | | | | |
| | P5.11 | DHW ENHANCED FUNCTION | 0 / 3 | INSTALLER | 0 | |
| P7 | | SERVICE | | | | |
| | P7.06 | AUTOSTOP FUNCTION | refer to AUTOSTOP instructions | | 0 | |
| | P7.07 | SERVICE EXPIRY | NOT AVAILABLE ON THIS MODEL | | 52 | |
| P8 | | CONNECTIVITY | | | | |
| | P8.01 | BUS 485 CONFIG | 0 / 1 / 2 | SERVICE | 0 | |
| | P8.03 | OT CONFIG | 0 / 1 | SERVICE | 1 | |

5.4 STARTING THE BOILER

Ensure that steps 6.1 through to 6.6 have been completed before supplying the gas and electrical supply to the appliance.
- Position the system's master switch to the "on" position.

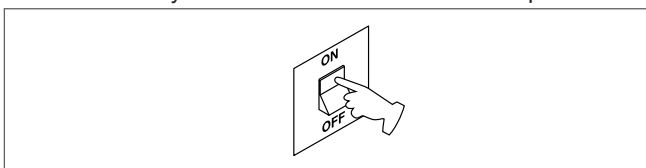

If necessary, the interface automatically goes to the clock menu. On the main screen the icons ▲, ▼, ► and ◀ and ENTER come on while 00:00 is displayed with the first two digits blinking with a frequency of 0.5 sec ON, 0.5 sec OFF.



To set the time and day follow the following instructions:

- set the hour with the ▲ and ▼ arrows, then confirm with **A**
- set minutes with the ▲ and ▼ arrows, then confirm with **B**
- set the day of the week with the ▲ and ▼ arrows. The segment in line with the day selected blinks, press the MENU key at the icon Enter to confirm the time and day setting. The clock blinks for 4sec and then returns to the main screen

- to exit the time programming without saving the modified values just press ◀.

NOTE: It is possible to change the TIME and DAY settings also later by accessing the P1.02 parameter in the P1 menu, or by pressing the **A+C** keys for at least 2sec.

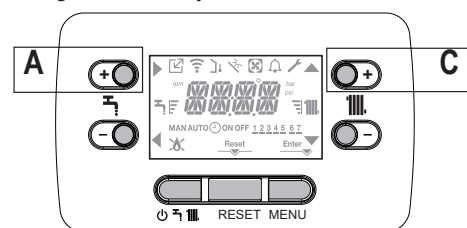

- If you need to set the language, select the menu P1 and confirm your choice using ►.
- Use the arrows to display parameter P1.01, then enter the submenu by pressing ►.
- Use the ▲ and ▼ buttons to set the desired language – see "5.3 SETTINGS MENU TREE STRUCTURE". To confirm your choice, press Enter.

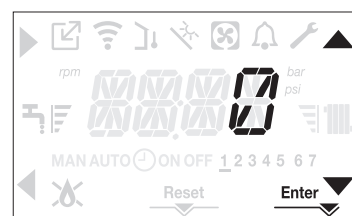

Each time that the boiler is powered a vent cycle is carried out lasting 4 min. The display shows the message -AIR lighting up the icon RESET.

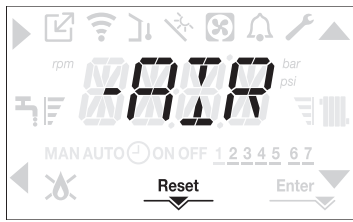

To interrupt the vent cycle press RESET.

Set the boiler to OFF by pressing

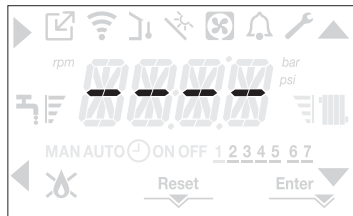

5.5 BOILER CONFIGURATION

To access the boiler configuration menu, access the technical parameters menu, as indicated in the paragraph "5.1 Access to the parameters".

Use the and arrows to scroll through the parameters of the pre-selected sub-menu, confirming the selection with **A**; change the value of the pre-selected parameter with **C** and **D** confirming the selection with the key indicated by the icon .

Description of the settings menu

Some of the following functions might not be available depending on the access level and the type of machine.

P1 (SETTINGS menu)

P1.01

Select the parameter to set the desired language (see the tree-view menu in paragraph "5.3 SETTINGS MENU TREE STRUCTURE").

P1.02

From this menu the time and the number of the day of the week can be adjusted.

P1.03

This parameter allows you to set the time programm, only if the clock is enabled.

P1.05

This parameter allows you to enable scrolling text after the parameter code itself:

0= OFF

1= ON

P3 (CONFIGURATION menu)

P3.01

This parameter allows you to set the type of hydraulic configuration of the boiler:

0 = ONLY HEATING

1 = INSTANTANEOUS FLOWSWITCH

2 = INSTANTANEOUS FLOWMETER

3 = STORAGE CYLINDER WITH PROBE

4 = STORAGE CYLINDER WITH THERMOSTAT

The factory setting for this parameter is 1. When replacing the electronic board make sure that this parameter is set to 1.

P3.02

This parameter allows you to set the type of water pressure transducer:

0 = water pressure switch

1 = pressure transducer

The factory setting for this parameter is 1 do not change! When replacing the electronic board make sure that this parameter is set to 1.

P3.03

This parameter allows you to enable the "semi-automatic filling" function since the boilers have a pressure transducer and a filling solenoid valve installed. The factory setting for this parameter is 0, do not change! When replacing the electronic board make sure that this parameter is set to 0.

P3.04

This only appears if P3.03=1. NOT AVAILABLE ON THIS MODEL

P3.05

This parameter allows you to disable the vent cycle function; the factory setting is 1, set the parameter to 0 to disable the function.

P3.06

This parameter allows you to change the minimum number of the fan's rpm.

P3.07

This parameter allows you to change the maximum number of the fan's rpm.

P3.08

This parameter allows you to change the slow ignition value.

P3.09

This parameter allows you to change the maximum number of the fan's rpm in heating mode. Do not change!

P3.10

This parameter allows you to change the heat output in heating mode, the factory setting for this parameter is P3.09 and can be programmed within the P3.06 - P3.09 range. For more information about the use of this parameter see the paragraph "8.11 Range rated".

P3.11

This parameter allows you to configure the operation of an additional relay (only if the relay board is installed (not supplied as standard)) to bring a phase (230Vac) to a second heating pump (additional pump) or a zone valve. The factory setting for this parameter is 0 and can be set within the 0 - 2 range with the following meaning:

| Pin 1 and 2 of X21 | Not present | Jumpered |
|--------------------|----------------------------|----------------------------|
| P3.11 = 0 | additional pump management | zone valve management |
| P3.11 = 1 | zone valve management | zone valve management |
| P3.11 = 2 | additional pump management | additional pump management |

P3.12

This parameter allows operating hours meter to be reset in certain conditions (see "8.13 Lights and faults" for more information, E091 faults). The factory setting for this parameter is 0, set to 1 to reset the flue gas probe hours meter after the primary heat exchanger has been cleaned. Once the reset procedure is finished, the parameter returns automatically to 0.

P4 (HEATING menu)

P4.01

For high temperature systems, this parameter allows you to set the hysteresis value used by the adjustment board for calculating the switching off delivery temperature of the burner:

SWITCHING OFF TEMPERATURE = HEATING SETPOINT + P4.01.

The factory setting for this parameter is 5°C, it can be changed within the 2 - 10°C range.

P4.02

For high temperature systems, this parameter allows you to set the hysteresis value used by the adjustment board for calculating the ignition delivery temperature of the burner:

IGNITION TEMPERATURE = HEATING SETPOINT - P4.02.

The factory setting for this parameter is 5°C, it can be changed within the 2 - 10°C range.

P4.03

For low temperature systems, this parameter allows you to set the hysteresis value used by the adjustment board for calculating the switching off delivery temperature of the burner:

SWITCHING OFF TEMPERATURE = HEATING SETPOINT + P4.03.

The factory setting for this parameter is 3°C, it can be changed within the 2 - 10°C range.

P4.04

For low temperature systems, this parameter allows you to set the hysteresis value used by the adjustment board for calculating the ignition delivery temperature of the burner:

IGNITION TEMPERATURE = HEATING SETPOINT - P4.04.

The factory setting for this parameter is 3°C, it can be changed within the 2 - 10°C range.

P4.05

Not used on this model.

P4.08

This parameter allows you to set the boiler for cascade applications via an OTBus signal. Not applicable to this model of boiler.

P4.09

This parameter allows you to activate the screed heater function (see paragraph "5.8.11 Screed heating function" for more details). The factory setting is 0, with the boiler set to OFF, set to 1 to activate the screed heater function on the low temperature heating zones.

The parameter automatically returns to 0 once the screed heater function is finished, it is possible to interrupt it earlier by setting the value to 0.

P4.10

This parameter allows you to change the FORCED HEATING TIMING OFF, regarding the delay time introduced for re-igniting the burner in the face of an off due to the heating temperature being reached. The factory setting for this parameter is 3 minutes and can be set to a value between 0 min and 20 min.

P4.11

This parameter allows you to cancel the ANTI CYCLE and REDUCED HEATING MAXIMUM OUTPUT TIMING, lasting 15 min during which the speed of the fan is limited to 75% of the maximum heating output that has been set. The factory setting for this parameter is 0, set 1 to reset the timings.

P4.12

This parameter allows you to configure the system to manage a mixing valve and an additional pump on the main heating system (the use of the BE16 accessory board is required, not supplied as standard). The factory setting for this parameter is 0, set to 1 for the connection of a BE16 board.

Note: this parameter cannot be changed when an OTBus chronothermostat is connected.

P4.13

When P4.12 = 1, this parameter allows you to set the address of the BE16 board.

The factory setting for this parameter is 3 and can be set within the 1 - 6 range.

Note: see the instruction sheet of the BE16 accessory board for more information about the use of this parameter.

P4.14

When P4.12 = 1, this parameter allows you to set the hydraulic configuration of the main heating zone. The factory setting for this parameter is 0 and allows a direct zone to be managed, set the parameter to 1 for the management of a mixed zone.

Note: see the instruction sheet of the BE16 accessory board for more information about the use of this parameter.

P4.15

This parameter allows you to specify the type of zone to be heated, it is possible to choose from the following options:

0 = HIGH TEMPERATURE (factory setting)

1 = LOW TEMPERATURE

P4.16

This parameter allows you to specify the maximum heating setpoint that can be set:

- range 20°C - 80.5°C, default 80.5°C for high temperature systems

- range 20°C - 45°C, default 45°C for low temperature systems.

Note: the P4.16 value cannot be less than P4.17.

P4.17

This parameter allows you to specify the minimum heating setpoint that can be set:

- range 20°C - 80.5°C, default 40°C for high temperature systems

- range 20°C - 45°C, default 20°C for low temperature systems.

Note: the P4.17 value cannot be greater than P4.16.

P4.18

This parameter allows you to activate the thermoregulation when the system has an outdoor temperature probe connected. The factory setting is 0, the boiler always operates at a fixed point. With the parameter on 1 and an outdoor temperature probe connected, the boiler operates in thermoregulation. With an outdoor temperature probe disconnected the boiler always operates at a fixed point. See paragraph "8.12 Setting the thermoregulation" for more details.

P4.19

This parameter allows you to set the number of the compensation curve used by the boiler when in thermoregulation. The factory setting for this parameter is 2.0 for high temperature systems and 0.5 for low temperature ones. The parameter can be set with the range 1.0 - 3.0 for high temperature systems, 0.2 - 0.8 for low temperature ones.

See paragraph "8.12 Setting the thermoregulation" for more details.

P4.20

With this parameter you activate the "night compensation" function. The default value is 0, set to 1 to activate the function.

See paragraph "8.12 Setting the thermoregulation" for more details.

P4.21

Set to 1 to enable or 0 to disable (factory default setting is 0).

P4.22

Set to 1 to enable or 0 to disable (factory default setting is 0).

P4.23

This parameter allows you to activate the management of an additional heating zone (the use of the BE16 accessory board is required, not supplied as standard). The default value is 0, set to 1 to activate the function.

Note: this parameter cannot be changed when an OTBus chronothermostat is connected.

P4.24

When P4.23 = 1, this parameter allows you to set the address of the BE16 board of zone 1. The factory setting is 1 and can be set within the 1 - 6 range. Note: see the instruction sheet of the BE16 accessory board for more information about the use of this parameter.

P4.25

When P4.12 = 1, this parameter allows you to set the hydraulic configuration of heating zone 1. The factory setting for this parameter is 0 and allows you to manage a direct zone, set to 1 to manage a mixed zone.

Note: see the instruction sheet of the BE16 accessory board for more information about the use of this parameter.

P4.26

When P4.12 = 1 this parameter allows you to specify the type of zone to be heated. It is possible to choose from the following options:

0 = HIGH TEMPERATURE (factory setting)

1 = LOW TEMPERATURE

P4.27

When P4.12 = 1, this parameter allows you to the setpoint value of heating zone 1. The factory setting for this parameter is P4.28 and can be programmed within the P4.29 and P4.28 range.

P4.28

This parameter allows you to specify the maximum heating setpoint that can be set for zone 1:

- range 20°C - 80.5°C, default 80.5°C for high temperature systems

- range 20°C - 45°C, default 45°C for low temperature systems.

Note: the P4.28 value cannot be less than P4.29.

P4.29

This parameter allows you to specify the minimum heating setpoint that can be set for zone 1:

- range 20°C - 80.5°C, default 40°C for high temperature systems

- range 20°C - 45°C, default 20°C for low temperature systems

Note: the P4.29 value cannot be greater than P4.28.

P4.30

This parameter allows you to activate thermoregulation mode for zone 1 when the system has an outdoor temperature sensor connected. The factory setting is 0, the boiler always operates for zone 1 at a fixed point; to have the boiler work in climate mode connect an outdoor temperature sensor and set the parameter to 1, connect an outdoor temperature sensor. With an outdoor temperature probe disconnected the boiler always operates at a fixed point. See paragraph "8.12 Setting the thermoregulation" for more details.

P4.31

This parameter allows you to set the number of the compensation curve for zone 1 used by the boiler when in climatic mode. The factory setting for this parameter is 2.0 for high temperature systems and 0.5 for low temperature ones. The parameter can be set with the range 1.0 - 3.0 for high temperature systems, 0.2 - 0.8 for low temperature ones.

See paragraph "8.12 Setting the thermoregulation" for more details.

P4.32

This parameter allows you to activate "night compensation" for zone 1. The default value is 0, set to 1 to activate the function. See paragraph "8.12 Setting the thermoregulation" for more details.

P5 (DHW menu)

P5.11

This parameter allows you to activate the following functions related to the operation of the boiler in domestic hot water mode:

0 = no function; the boiler in domestic hot water mode starts immediately and uses the related domestic hot water thermostats, i.e. it switches off at setpoint +5°C and switches back on at setpoint +4°C (factory setting)

3 = the boiler uses absolute domestic hot water thermostats, i.e. in domestic hot water mode it always switches off at 65°C and switches back on at 63°C, independently of the domestic hot water setpoint that has been set

P7 (SERVICE MENU)

P7.06

This parameter is factory set to 0. Contact Vokera Technical for further advice.

P7.07

Contact Vokera Technical for further advice.

P8 (CONNECTIVITY menu)

P8.01

This parameter is used to manage the boiler remotely. Three values are available for this parameter:

0 = FACTORY SET VALUE. The boiler interface is in function, the remote control via ModBus is enabled

1 = The boiler interface is in function, the remote control via ModBus is disabled

2 = The boiler interface isn't in function, the remote control via ModBus is enabled via REC10H. Only the MENU button is enable to modify P8.01 parameter.

P8.03

This parameter is used to enable remote boiler management using an Open-Term device:

0 = With the OT+ function disabled, you cannot control the boiler remotely using an OT+ device. If this parameter is set to 0, any OT+ connection is instantly interrupted, and the  icon and "OTB" message on the display are switched off

1 = FACTORY-SET VALUE. With the OT+ function enabled, you can connect an OT+ device to control the boiler remotely. When you connect an OT+ device to the boiler, the  icon lights up on the display and "OTB" appears.

5.6 FIRST COMMISSIONING

Ensure that steps 6.1 through to 6.6 have been completed before supplying the gas and electrical supply to the appliance.

- Position the system's master switch to the "on" position.
- Open the gas tap to allow fuel to flow.

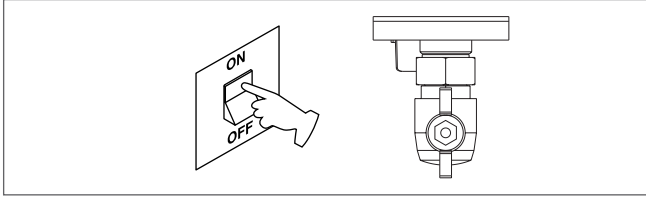

- With power on the backlight comes on, then all the icons and the segments come on for 1sec and in sequence the firmware revision is displayed for 3sec:

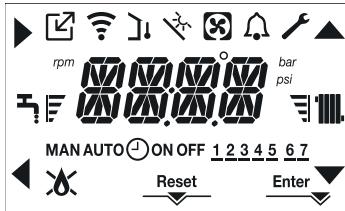

- Then the interface displays the status active at that moment.

5.7 VENT CYCLE



Each time that the boiler is powered, an automatic vent cycle is carried out lasting 4 min. When the air purging cycle is in progress all heat requests are inhibited except those for domestic hot water when the boiler is not set to OFF and -AIR is displayed on the interface screen.

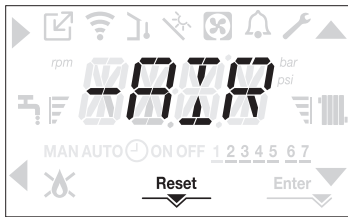

The purge cycle can be interrupted early by keeping key 2 (the icon RESET comes on). The purge cycle can also be interrupted, if the boiler is not set to OFF, by a domestic hot water request.

- Adjust the ambient temperature thermostat to the desired temperature (~20°C) or, if the system is equipped with a programmable thermostat or timer, ensure that the thermostat or timer is "active" and set correctly (~20°C).
- Then set the boiler on WINTER or SUMMER depending on the type of operation desired.
- The boiler will start up and continue working until the set temperatures are reached, after which it will then go back to standby.

5.8 OPERATING STATUS

For changing the operating status from WINTER to SUMMER to OFF press key 1 until the icon for the desired function is displayed.

5.8.1 WINTER MODE

- Set the boiler to the WINTER status by pressing key 1 until both the domestic hot water icon and the heating icon are displayed.



The interface normally displays the delivery temperature unless there is a domestic hot water request in progress, in which case the domestic hot water temperature is displayed.

- When there is a heat request and the boiler is igniting, the icon  appears on the display.

Heating REQUEST, the radiator icon blinks:



5.8.2 SUMMER MODE

- Set the boiler to the SUMMER status by pressing key 1 until the domestic hot water icon is displayed.

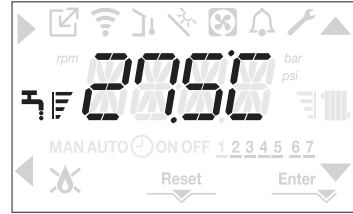

In this status the boiler activates the traditional function of just domestic hot water, the interface normally displays the delivery temperature. In the event of a domestic hot water pick up, the display shows the temperature of the domestic hot water.

Domestic hot water REQUEST, the tap icon blinks:

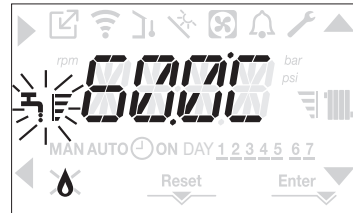

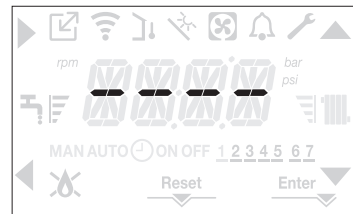

5.8.3 OFF

- Set the boiler to the OFF status by pressing key 1 until the central segments are displayed.



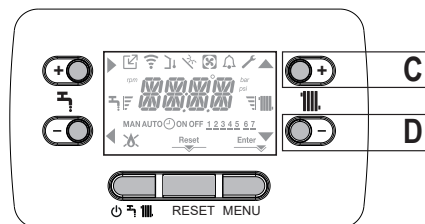

5.8.4 ADJUSTING THE HEATING WATER TEMPERATURE WITHOUT AN OUTDOOR TEMPERATURE SENSOR CONNECTED

If there is no outdoor temperature sensor the boiler operates at a fixed point, the HEATING setpoint in this case can be set on the main page of the screen. Pressing the key C or D displays the current heating setpoint; the value blinks with a frequency of 0.5 sec ON, 0.5 sec OFF and the icons  and  come on.



The successive pressing of the key C or D allows you to set the value of the heating setpoint within the preset range:
 [40°C - 80.5°C] for high temperature systems
 [20°C - 45 °C] for low temperature systems
 with steps of 0.5°C.

The level bars beside the heating icon show the setpoint value set with respect to the operating range:

- four bars on = max setpoint 
- one bar on = min setpoint 



Keeping one of the two keys **C** or **B** pressed for longer, the meter increases the speed of advancement modifying the set value. If no key is pressed for 5sec, the value set is taken as the new heating setpoint and the display returns to the main page.

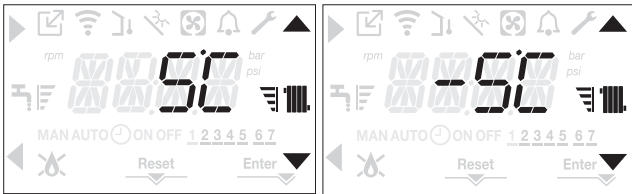

5.8.5 ADJUSTING THE HEATING WATER TEMPERATURE WITH AN OUTDOOR TEMPERATURE SENSOR CONNECTED

If an outdoor temperature sensor is installed and thermoregulation is enabled (parameter P4.18 = 1), the delivery temperature is automatically selected by the system, which quickly adjusts the ambient temperature according to the variations in the outdoor temperature. If you want to change the temperature, raising it or lowering it with respect to the temperature automatically calculated by the electronic board, it is possible to change the HEATING setpoint as follows: press the keys **C** or **D** and select the desired level of comfort within the range (-5 - +5).





Note: if an outdoor temperature sensor is connected it is in any event possible to have the boiler operate at a fixed point by setting the parameter P4.18 = 0 (menu P4).

5.8.6 ADJUSTING THE DOMESTIC HOT WATER TEMPERATURE

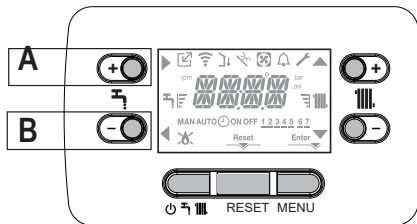
On the main screen, pressing the key **A** rather than **B** displays the current domestic hot water setpoint, the value blinks with a frequency of 0.5 sec ON, 0.5 sec OFF and the icons  and  come on.





The successive pressing of the keys **A** or **B** allows you to set the value of the domestic hot water setpoint raising or lowering the value within the preset range in steps of 0.5°C. The level bars beside the heating icon show the setpoint value set with respect to the operating range:

- four bars on = max setpoint 
- one bar on = min setpoint 



5.8.7 SAFETY STOP

If there are ignition faults or boiler operation malfunctions, carry out a "SAFETY STOP". On the display, in addition to the fault code, the icon  is also displayed, which blinks with a frequency of 0.5sec ON and 0.5sec OFF.

The backlight blinks for 1min after which it switches off, while the icon  continues blinking.

On the 4 digits a message scrolls containing the error code and its description.

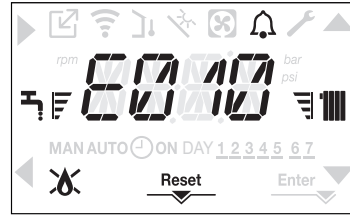



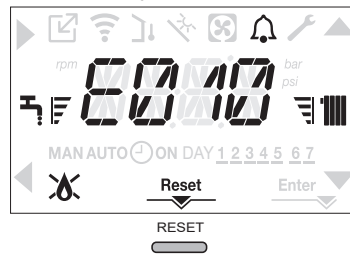

5.8.8 RESET FUNCTION

The RESET icon comes on when there is an alarm that requires a manual reset by the user (for example flame lockout). To reset press key 2 RESET.





If the release attempts do not restart the boiler, contact your local Technical Assistance Centre.

5.8.9 DOMESTIC HOT WATER COMFORT FUNCTION

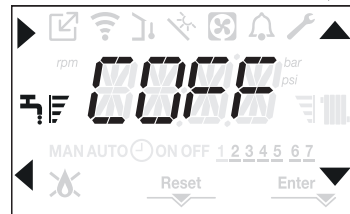
Pressing the keys **A+B** for at least 2sec gives you access to the domestic hot water comfort functions. COFF is shown on the display and the icons , ,  and  come on:



Using the keys ,  you can scroll through the options in sequence CSTD and then COFF again. Using the  key activates the desired function and you exit the menu returning to the initial screen. A scrolling message appears on the display with the following mode:

| Function | Scrolling message |
|----------|-------------------|
| CSTD | COMFORT STANDARD |
| COFF | COMFORT OFF |

CSTD (PREHEATING FUNCTION)

By setting CSTD, the domestic hot water preheating function of the boiler activates. This function keeps the water in the domestic hot water exchanger hot, to reduce standby times when a request is made. When the preheating function is enabled the scrolling message PREHEATING FUNCTION IN PROGRESS is displayed. To deactivate the preheating function set COFF. The function is not active when the boiler is OFF.

5.8.10 SPECIAL DOMESTIC HOT WATER FUNCTIONS

The boiler has special functions more a more efficient management of the domestic hot water when there a high domestic hot water temperature input. By programming the P5.11 parameter it is possible to activate the following function, for more information about setting the parameter see the relative paragraph “5.5 Boiler configuration”.

- Absolute thermostats domestic hot water function: normally the boiler in domestic hot water mode switches on and off based on thermostats related to the value of the domestic hot water setpoint (off at setpoint + 5°C and switching back on at setpoint + 4°C). Activating this function the boiler will switch on ad off based on thermostats independent of the domestic hot water setpoint (off at setpoint + 65°C and switching back on at 63°C).

5.8.11 SCREED HEATING FUNCTION

For a low temperature system the boiler has a “screed heating” function that can be activated in the following way:

- set the boiler to OFF by pressing button 1 



- access the technical parameters menu, as indicated in the paragraph “5.1 Access to the parameters”
- select the P4 menu and then P4.09 with the keys ▲, ▼, confirming the selection with ►.

(Note: SCREED HEATING is not available if the boiler is a status other than OFF).

- To activate the function set the parameter to 1, to deactivate it set the parameter to 0.

The “SCREED HEATING” function lasts 168 hours (7 days) during which, in the zones configured as low temperature, a heating request is simulated with an initial zone outlet of 20°C, then increased in line with the table on the side.

Accessing the INFO menu from the main page of the interface it is possible to display the I0.01 value regarding the number of hours that have passed since the activation of the function. Once activated, the function takes priority, if the machine is shut down by disconnecting the power supply, when it is restarted the function picks up from where it was interrupted. The function can be interrupted before it has finished by setting the boiler to a status other than OFF or by selecting P4.09 = 0 from the menu P4.

Note: The temperature and increase values can be set to different values only by qualified personnel, only if strictly necessary. The manufacturer declines all responsibility if the parameters are incorrectly set.

| DAY | TIME | TEMPERATURE |
|-----|------|-------------|
| 1 | 0 | 20°C |
| | 6 | 22°C |
| | 12 | 24°C |
| | 18 | 26°C |
| 2 | 0 | 28°C |
| | 12 | 30°C |
| 3 | 0 | 32°C |
| 4 | 0 | 35°C |
| 5 | 0 | 35°C |
| 6 | 0 | 30°C |
| 7 | 0 | 25°C |

6 COMMISSIONING

NOTE

Please refer to 3 - 3E and use the appropriate PPE when carrying out any of the actions or procedures contained within this section.

6.1 GAS SUPPLY INSTALLATION

Inspect the entire installation including the gas meter, test for tightness and purge. Refer to BS 6891 (I.S. 813 in ROI) for specific instruction.

6.2 THE HEATING SYSTEM

The appliance contains components that may become damaged or rendered inoperable by oils and/or debris that are residual from the installation of the system, consequently it is essential that the system be flushed in accordance with the following instructions.

6.3 INITIAL FILLING OF THE SYSTEM

Ensure both flow and return service valves are open, remove appliance casing as described in 4.7, identify the automatic air release valve (AAV), and loosen the dust cap by turning the cap anti-clockwise one full turn. Ensure all manual air release valves located on the heating system are closed. Connect the filling loop as shown in "Fig. 9", slowly proceed to fill the system by firstly opening the inlet valve connected to the flow pipe, and then turning the lever on the fill valve, to the open position. As water enters the system the pressure gauge will begin to rise. Once the gauge has reached 1 bar close both valves and begin venting all manual air release valves, starting at the lowest first. It may be necessary to go back and top-up the pressure until the entire system has been filled. Inspect the system for water tightness, rectifying any leaks.

6.3.1 AUTO AIR VENT (AAV)

When the boiler has been filled for the first time or the system has been drained and refilled, it will be necessary to release any air that may have become trapped within the appliance heat exchanger. Slacken the lower air vent valve, connect the supplied silicone pipe to the de-aeration valve (Fig. 23) and take a bucket to collect any water that may come out after bleeding. Open the de-aeration valve, turn the lever on the fill valve and wait until the water is released and then close it.

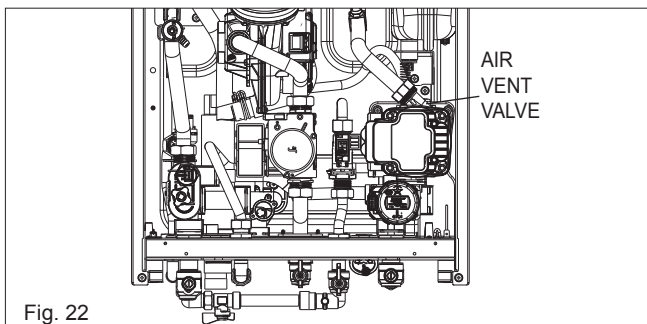

Fig. 22

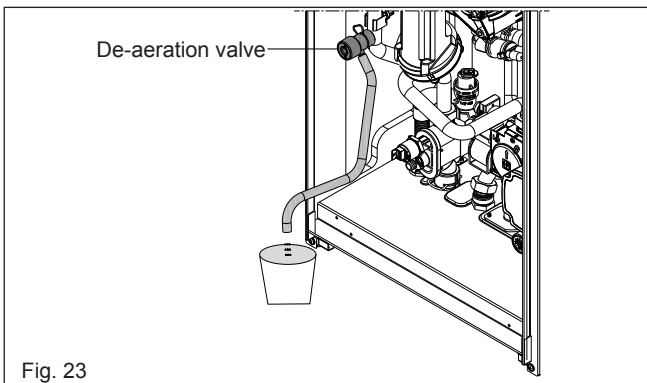

Fig. 23

INITIAL FLUSHING OF THE SYSTEM

The whole of the heating system must be flushed both cold and hot as detailed in 6.7. Open all radiator or heating valves and the appliance flow & return service valve. Drain the boiler and system from the lowest points. Open the drain valve full bore to remove any installation debris from the boiler prior to lighting. Refill the boiler and heating system as described in 6.3.

6.4 PRE-OPERATION CHECKS

Before attempting the initial lighting of the appliance, the following checks must be carried out:

- ensure all gas service valves from the meter to the appliance are open and the supply pipe has been properly purged;
- ensure the proper electrical checks have been carried out, (see 8.6) particularly continuity, polarity and resistance to earth;
- ensure the 3 AMP fuse – supplied with the appliance – has been fitted;
- ensure the system has been filled, vented and the pressure set to 1 bar;
- ensure the flue system has been fitted properly and in accordance with the instructions;
- ensure all appliance service valves are open.

6.5 INITIAL LIGHTING

Ensure the electrical supply to the appliance is switched on. Ensure any external controls are switched to an 'ON' position and are calling for heat. Pressing button 1  the appliance will now operate as described in 2.2. Should the appliance fail to ignite, refer to 6.5 and/or section 8 (mode of operation & fault finding).

6.6 CHECKING GAS PRESSURE AND COMBUSTION ANALYSIS

The appliance is factory set so should require no additional adjustment once installed. However to satisfy the requirements of GSIUR 26/9 (I.S. 813 ROI), it will be necessary to gas rate the appliance using the gas meter that serves the appliance and carry out a combustion analysis check in accordance with BS 7967 (UK) to ensure that correct combustion is occurring, see flow chart on page 51.

Additionally, if the gas valve has been adjusted, replaced, or the appliance has been converted for use with another gas type, then it becomes necessary to carry out a combustion analysis check to ensure that correct combustion is occurring. If there are no means to carry out a combustion analysis check, then it will not be possible to complete the commissioning procedure.

Details on how to carry out the combustion analysis can be found in section 8.

IMPORTANT

It's imperative that a sufficient dynamic – gas – pressure is maintained at all times. Should the dynamic gas pressure fall below an acceptable level, the appliance may malfunction or sustain damage.

6.7 FINAL FLUSHING OF THE HEATING SYSTEM

The system shall be flushed in accordance with BS 7593 (I.S. 813 ROI). Should a cleanser be used, it must be suitable for Stainless-steel heat exchangers. It shall be from a reputable manufacturer and shall be administered in strict accordance with the manufacturers' instructions and the DWTA code of practice.

NOTE

Chemicals used to cleanse the system and/or inhibit corrosion must be pH neutral, i.e. they should ensure that the level of the pH in the system water remains neutral. Premature failure of certain components can occur if the level of pH in the system water is out-with normal levels.

6.7.1 INHIBITORS

See Section "3 GENERAL REQUIREMENTS (UK)".

6.8 SETTING THE FLOW OUTLET TEMPERATURE

The flow outlet temperature can be adjusted between 40 °C - 80 °C for standard CH system by using the buttons **C & D** (Fig. 1).

SETTING THE DHW OUTLET TEMPERATURE

The DHW outlet temperature can be adjusted between 37 °C - 60 °C via the buttons **A & B** (Fig. 1).

6.9 SETTING THE SYSTEM DESIGN PRESSURE

The design pressure should be a minimum of 0.5 bar and a maximum of 1.5 bar. The actual reading should ideally be 1bar plus the equivalent height in metres (0.1 bar = 1 metre) to the highest point in the system above the base of the appliance (up

to the maximum of 1.5 bar total). **N.B.** The safety valve is set to lift at 3 bar/30 metres/45 psig. To lower the system pressure to the required value, drain off some water from the appliance drain valve until the pressure is correct .

6.10 REGULATING THE CENTRAL HEATING SYSTEM

Fully open all radiator and circuit valves and run the appliance for both heating and hot water until heated water is circulating. If conditions are warm remove any thermostatic heads. Adjust radiator return valves and any branch circuit return valves until the individual return temperatures are correct and are approximately equal.

6.10.1 REGULATING THE DHW FLOW-RATE

The appliance is fitted with a flow rate restrictor that limits the maximum flow rate that can be drawn through the appliance. The restrictor eliminates the need to manually adjust the DHW flow rate. However if it is felt necessary to further increase or decrease the available flow rate, spare restrictors are available from Vokèra spare parts.

The spare flow rate restrictors can be fitted to either increase or decrease the maximum flow rate.

6.10.2 FLOW-RATE RESTRICTOR

The boiler is supplied with the following flow restrictor.

VISION PLUS 35C: 12 - litres flow restrictor

VISION PLUS 40C: 14 - litres flow restrictor

6.11 FINAL CHECKS

- ENSURE ALL TEST NIPPLES ON THE APPLIANCE GAS VALVE ARE TIGHT AND CHECKED FOR TIGHTNESS.
- ENSURE THE APPLIANCE FLUE SYSTEM IS FITTED CORRECTLY AND IS PROPERLY SECURED.
- ENSURE ALL PIPE WORK IS RE-CHECKED FOR TIGHTNESS.
- RE-FIT APPLIANCE CASING.
- COMPLETE BENCHMARK CHECKLIST.

FOR UK ONLY

Complete details of the boiler, controls, installation and commissioning in the Benchmark checklist at the back of this book. It is important that the Benchmark checklist is correctly completed and handed to the user. Failure to install and commission the appliance to the manufacturers instructions will invalidate the warranty.

6.12 INSTRUCTING THE USER

Hand over all documentation supplied with this appliance – including these instructions – and explain the importance of keeping them in a safe place.

Explain to the user how to isolate the appliance from the gas, water and electricity supplies and the locations of all drain points. Show the user how to operate the appliance and any associated controls correctly.

Show the user the location of the filling valve and how to top-up the system pressure correctly and show the location of all manual air release points.

Explain to the user how to turn off the appliance for both long and short periods and advise on the necessary precautions to prevent frost damage.

Explain to the user that for continued safe and efficient operation, the appliance must be serviced annually by a competent person.

IMPORTANT

To validate the appliance warranty, it's necessary to register the appliance details with us. The warranty can be registered in several ways:

- online at: www.vokera.co.uk (UK) or www.vokera.ie (Ireland)
- for UK residents by calling: 0800 479 0754
- for ROI residents by calling: 056 7755 055.

7 SERVICING INSTRUCTIONS

NOTE

Please refer to 3 - 3E and use the appropriate PPE when carrying out any of the actions or procedures contained within this section.

7.1 GENERAL

Once the appliance has been serviced, the benchmark Service Record must be completed.

For UK only: It is important that the Benchmark Service Record is correctly completed and handed to the user. Failure to install and commission the appliance to the manufacturers instructions will invalidate the warranty.

To ensure the continued safe and efficient operation of the appliance, it is recommended that it is checked and serviced at regular intervals. To ensure correct and safe operation of the appliance, it is essential that any worn or failed component be replaced only with a **genuine Vokèra spare part**. It should be remembered that although certain generic components may look similar, they will be specific to an individual appliance or product range. Use of non-genuine Vokèra spare parts could invalidate your warranty and may pose a potential safety hazard. The frequency of servicing will depend upon the particular installation conditions, but in general, once per year should be sufficient. It is the law that any servicing work is carried out by competent person such as a Vokèra engineer, an approved service agent, British Gas, GAS SAFE registered personnel or other suitably qualified personnel. The following instructions apply to the appliance and its controls, but it should be remembered that the central heating and the domestic hot water systems would also require attention from time to time.

7.2 ROUTINE ANNUAL SERVICING

- Check the operation of the appliance and ensure it functions as described in section 8.
- Compare the performance of the appliance with its design specification. The cause of any noticeable deterioration should be identified and rectified without delay.
- Thoroughly inspect the appliance for signs of damage or deterioration especially the flue system and the electrical apparatus.
- Check and adjust – if necessary – all burner pressure settings (see 8.3).
- Check and adjust – if necessary – the system design pressure (see 6.9).
- Carry out an analysis of the flue gases (see 8.3), and visually check the condition of the entire flue assembly.
- Compare the results with the appliance design specification. Any deterioration in performance must be identified and rectified without delay.
- Check that the main heat exchanger is clean and free from any debris or obstruction.
- Check and clean – if necessary – the condense trap to ensure correct operation.

The flame side of the burner is made of state-of-the-art material. Being fragile:

- be particularly careful when handling, mounting or dismantling the burner and adjacent components (e.g. electrodes, insulation panelling etc.)
- avoid direct contact with any cleaning appliance (e.g. brushes, aspirators, blowers, etc.).

This component does not need any maintenance, please do not remove it from its housing, except where the O-ring may have to be replaced.

The manufacturer declines all responsibility in cases of damages due to failing to observe the above.

7.3 CLEANING THE PRIMARY HEAT EXCHANGER

- Switch off the electrical supply by turning the system's main switch to "Off".
- Close the gas shut-off valve.
- Remove the casing as indicated in the paragraph 7.10.
- Disconnect the connecting cables of the electrodes.
- Disconnect the power cables of the fan.
- Remove the combustion unit as described in 7.23.
- Take out the air/gas conveyor assembly including the fan and mixer, being careful not to damage the insulating panel and the electrodes.
- Remove the siphon connecting pipe from the condensate drain fitting of the heat exchanger and connect a temporary collecting pipe. At this point proceed with the heat exchanger cleaning operations.
- Vacuum out any dirt residues inside the heat exchanger, being careful NOT to damage the retarder insulating panel.
- Clean the coils of the heat exchanger with a soft bristled brush.

⚠ DO NOT USE METAL BRUSHES THAT COULD DAMAGE THE COMPONENTS.

- Clean the spaces between the coils using 0.4 mm thick blade, also available in a kit.
- Vacuum away any residues produced by the cleaning.
- Rinse with water, being careful NOT to damage the retarder insulating panel.
- Make sure the retarder insulation panel is undamaged and replace it if necessary following the relative procedure.
- Once the cleaning operations are finished, carefully reassemble all the components, following the above instructions in the reverse order.
- To close the fixing nuts of the air/gas conveyor assembly, use a tightening torque of 8 Nm.
- Turn the power and gas feeding to the boiler back on.

⚠ If there are obstinate combustion products on the surface of the heat exchanger, clean by spraying natural white vinegar, being careful NOT to damage the retarder insulating panel.

- Leave it to work for a few minutes
- Clean the coils of the heat exchanger with a soft bristled brush.

⚠ DO NOT USE METAL BRUSHES THAT COULD DAMAGE THE COMPONENTS.

- Rinse with water, being careful NOT to damage the retarder insulating panel
- Turn the power and gas feeding to the boiler back on.

7.4 CLEANING THE BURNER

Refer to 7.9 and carry out the component removal procedure.

- Remove the casing as indicated in the paragraph 7.10.
- Disconnect the connecting cables of the electrodes.
- Disconnect the power cables of the fan.
- Remove the combustion unit as described in 7.23.
- Take out the air/gas conveyor assembly including the fan and mixer, being careful not to damage the ceramic panel and the electrodes. At this point proceed with the burner cleaning operations.
- Clean the burner with a soft bristled brush, being careful not to damage the insulating panel and the electrodes.
- DO NOT USE METAL BRUSHES THAT COULD DAMAGE THE COMPONENTS.
- Check that the burner insulating panel and the sealing gasket are undamaged and replace them if necessary, following the relative procedure.
- Once the cleaning operations are finished, carefully reassemble all the components, following the above instructions in the reverse order.
- To close the fixing nuts of the air/gas conveyor assembly, use a tightening torque of 8 Nm.
- Turn the power and gas feeding to the boiler back on.

7.5 CLEANING THE SIPHON

Remove the syphon as indicated in the section "Removing the siphon".

- Clean the siphon, it can be washed with detergent water.
- Wash the SRD device making water circulate from the discharge attachment. Never use metal or pointed tools to remove deposits or residues inside the device, which could damage it.
- After the cleaning operations, reassemble the siphon and the SRD device, taking care to fit the components with due care.

⚠ Having cleaned the siphon and the SRD device, the

siphon must be filled with water before starting the boiler again. At the end of the maintenance operations on the siphon and the SRD device we recommend run the boiler in condensate regime for a few minutes and check there are no leaks from the entire condensate evacuation line.

7.6 ELECTRODES VERIFICATION

The electrodes play an important role in the boiler ignition phase; in this regard, if they are replaced, they must always be positioned correctly and the reference position indicated in the figure must be complied with.

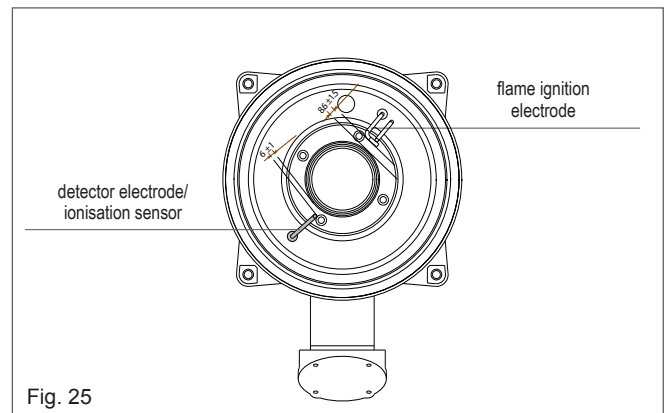

⊘ Do not sandpaper the electrodes.

⚠ During the annual maintenance, check the state of wear of the electrodes and replace them if have badly deteriorated.

The removal and eventual replacement of the electrodes involves also the replacement of the sealing gaskets.

7.7 CLAPET

Refer to 7.9 and carry out the component removal procedure. The boiler has a check valve.(clapet)

To access the check valve:

- remove the fan by unscrewing the 4 screws (D) fixing it to the conveyor
- make sure there are no foreign material deposits on the membrane of the check valve and if any remove them and checking for damage
- check the valve opens and closes correctly
- re-assemble the components in reverse order, making sure the check valve is put back in the correct direction.

When there is maintenance work on the check valve make sure that it is positioned correctly to ensure the system operates correctly and safely.

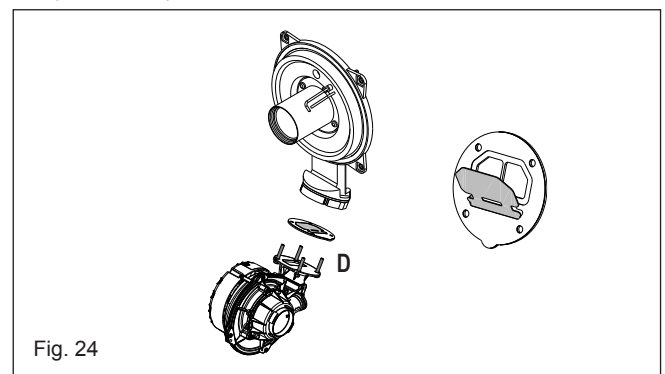

7.8 REPLACEMENT OF COMPONENTS

Although it is anticipated that this appliance will give years of reliable, trouble free service, the life span of components will be determined by factors such as operating conditions and usage. Should the appliance develop a fault, the fault finding section will assist in determining which component is malfunctioning.

7.9 COMPONENT REMOVAL PROCEDURE

To remove a component, access to the interior of the appliance is essential. Isolate the appliance from the electrical supply and remove the fuse. And when necessary, close all service valves on the appliance, remove the appliance casing as described

in section 4.7 and drain the water content from the appliance via the drain valve. Ensure some water absorbent cloths are available to catch any residual water that may drip from the appliance or removed component. Undertake a complete commissioning check as detailed in section 6, after replacing any component. **ALWAYS TEST FOR GAS TIGHTNESS IF ANY GAS CARRYING COMPONENTS HAVE BEEN REMOVED OR DISTURBED.**

7.10 CASING REMOVAL (Fig. 26)

To remove the casing, locate and unscrew the 2-screws (A) that secure the outer casing to the appliance, lift the casing upward to disengage it from the top locating hooks and then remove.

7.11 PUMP ASSEMBLY (Fig. 27)

Carry out component removal procedure as described in 7.9. Disconnect and remove the pump outlet pipe (A) from the pump assembly/combustion chamber connection.

Remove the expansion pipe locking pin (B) from the top of the pump assembly and withdraw the flexible pipe. Disconnect the electrical wiring from the pump's electrical connection point (D). Locate and remove the 2 securing screws (E) at the rear of the pump assembly. Remove locking pin (F) from pump base and lift pump assembly clear of the hydraulic manifold. The pump assembly can now be removed from the appliance. Replace carefully in the reverse order.

7.12 SAFETY VALVE (Fig. 28)

Carry out component removal procedure as described in 7.9. Disconnect the outlet pipe (H) from the safety valve, remove safety valve locking pin (G) from the hydraulic manifold. Replace in the reverse order.

7.13 LOWER AUTOMATIC AIR RELEASE VALVE (Fig. 27)

Carry out component removal procedure as described in 7.9. Remove the expansion pipe locking pin (B) from the pump assembly and remove the expansion pipe. Locate and remove the AAV locking pin (I) from the pump assembly and remove the AAV assembly (J). Replace in the reverse order.

7.14 WATER PRESSURE TRANSDUCER (Fig. 29)

Carry out component removal procedure as described in 7.9. Locate and remove the locking pin (M) from the water pressure transducer (N). Remove the wiring. Carefully withdraw the transducer. Replace in the reverse order.

7.15 DHW THERMISTOR (Fig. 29)

Carry out component removal procedure as described in 7.9. Locate and remove the thermistor locking pin (I2). Gently ease the thermistor assembly (J2) from the hydraulic manifold. Replace in the reverse order.

7.16 FLOW THERMISTOR (FIG. 3 - POS. 7)

Carry out component removal procedure as described in 7.9. Unclip and remove the air chamber front cover. Unclip the flow thermistor from the flow outlet pipe. Disconnect thermistor electrical plug. Replace in the reverse order.

7.17 RETURN THERMISTOR (FIG. 3 - POS. 21)

Carry out component removal procedure as described in 7.9. Unclip the return thermistor from the return inlet pipe. Disconnect thermistor electrical plug. Replace in the reverse order.

7.18 PRINTED CIRCUIT BOARD (FIG. 30)

Carry out component removal procedure as described in 7.9. Pull the control fascia forward and lower it. Push the clips (O) which secure the PCB cover, remove cover, after carefully taking note of all wiring connections and jumper tag configuration. Unhook and remove connection block (P). Disconnect all wiring from the PCB, locate and remove the PCB securing screws, remove the required PCB. Replace in the reverse order ensuring that the position of the 2 control knobs are correctly aligned with the respective potentiometers on the PCB. Ensure that the correct jumper tag configuration has been respected. It will be necessary to check the functioning of the PCB is set for the correct boiler type/application. Also refer to 7.28.

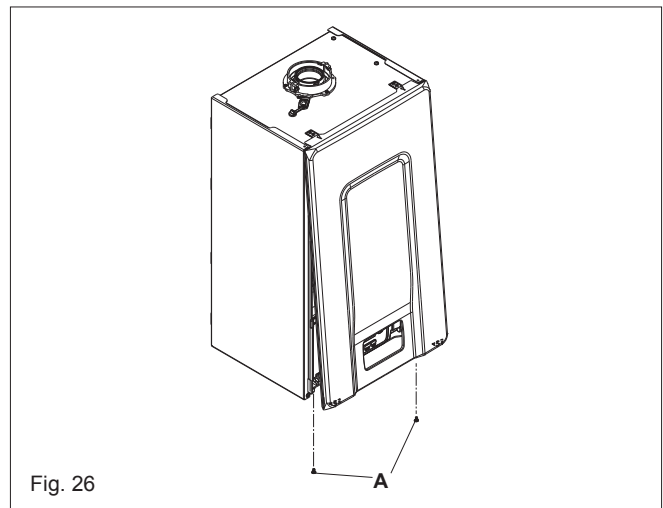

Fig. 26

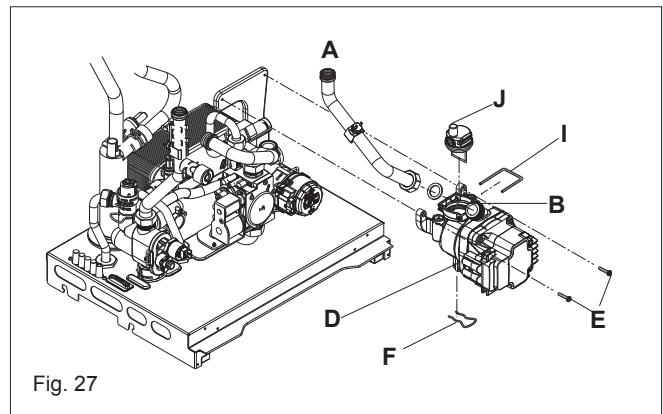

Fig. 27

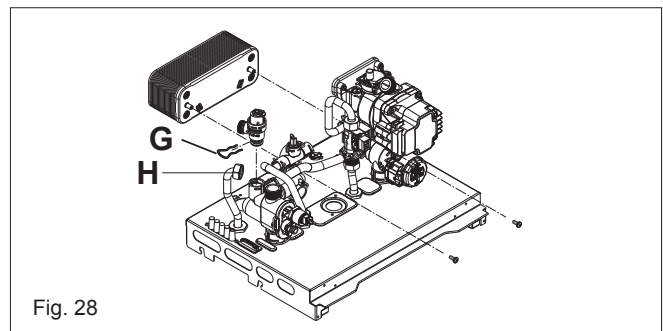

Fig. 28

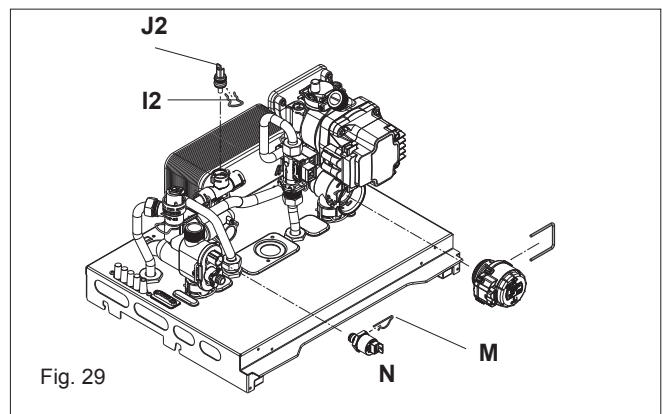

Fig. 29

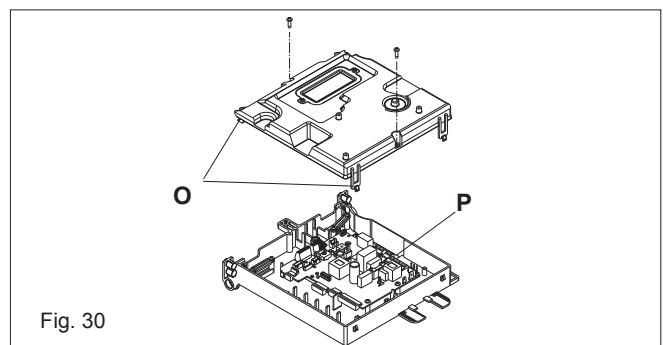

Fig. 30

7.19 GAS VALVE (FIG. 31)

Carry out component removal procedure as described in 7.9. The gas valve must be changed as complete unit. Disconnect the electrical plug and leads from the gas valve, slacken and unscrew gas valve inlet and outlet connections. **Please note**, the sealing washers (**Q**) must be discarded and replaced with new sealing washers. Unscrew gas pipe connections (**S-T**), the gas valve can now be removed. Replace in the reverse order. Check and adjust burner pressure settings.

WARNING, A GAS TIGHTNESS CHECK MUST BE CARRIED OUT.

7.19.1 INJECTOR (FIG. 31)

Carry out component removal procedure as described in 7.9. Unscrew and remove gas pipe connections (**S-T**). Locate and remove the injector (**U**) inside the valve. Replace in the reverse order. Check and adjust burner pressure settings.

WARNING, A GAS TIGHTNESS CHECK MUST BE CARRIED OUT.

7.20 ELECTRODES (FIG. 32)

Carry out component removal procedure as described in 7.9. Remove the air chamber front cover. Disconnect the electrode leads and ancillary wiring from their respective connectors. Remove the retaining screws (**V**) for electrode. Remove the spark ignition electrode (**W**). Remove the flame sensor electrode (**Y**).

7.21 EXPANSION VESSEL (FIG. 33)

Carry out component removal procedure as described in 7.9. Disconnect the flexible expansion pipe from the vessel. Unscrew the nut that secures the vessel to the lower frame. Locate and remove the screw (**Z**) that secures the vessel to the top. Disconnect the connection pipe (**Z1**).

The expansion vessel can now be removed. Replace in the reverse order. Ensure all seals are in good condition, taking care to ensure they are replaced correctly.

7.22 HEAT EXCHANGER (FIG. 34)

Refer to 7.9 and carry out the component removal procedure.

- Carry out the component removal procedure as described in 7.23 chapter.
- Loosen the nuts on the 2 ramps (**A** and **B**).
- Remove the clips (**C**) to remove the 2 ramps (**A** and **B**).
- Remove the 2 ramps (**A** and **B**) from the exchanger.
- Remove the condensate drain pipe (**D**).
- Disconnect the flue gas probe connector.
- Remove the screw (**F**) of the flue gas analysis socket and remove the cap.
- Remove the screw (**G**) that fixes the rain cover.
- Unscrew the 4 screws (**E**) that secure the exchanger to the seat.
- Remove the exchanger.

Once all the operations have been completed, reassemble all the components operating in the opposite direction to that described.

Pay particular attention to the insertion of ramps **A** and **B**, use tongs at the base of the signposting to avoid the overshoot at the inlet of the exchanger connections.

Restore voltage and gas supply to the boiler.

7.22.1 REMOVING THE RETARDER INSULATION PANEL

Refer to 7.9 and carry out the component removal procedure

- Carry out the component removal procedure as described in 7.23 chapter.

- Protect the lower part of the internal coils of the exchanger to prevent dust and parts of the insulating panel from falling into them during subsequent operations.

THE CHARACTERISTICS OF THE MATERIAL MAKE THE INDIVIDUAL PROTECTION DEVICES NOT NECESSARY BUT, FOR SAFETY, WE RECOMMEND THE USE OF A MASK, GLOVES AND PROTECTIVE GLASSES.

- With the aid of a blade, cut the insulating panel to be replaced approximately 60 mm from the circumference.
- Lift and remove the 2 pieces of panel from the seat.
- The panel is fixed with a clip; if, during the removal operations, the clip should remain fixed to the relative pin, remove it by unscrewing it or, if damaged, with the aid of a pliers.
- Vacuum any residual material present on the exchanger coils and retarder support.
- Position the new retarder insulation panel near the seat and insert it fully by pressing on the central part.
- Once all the operations have been completed, reassemble all the components operating in the opposite direction to that described.
- Restore voltage and gas supply to the boiler.

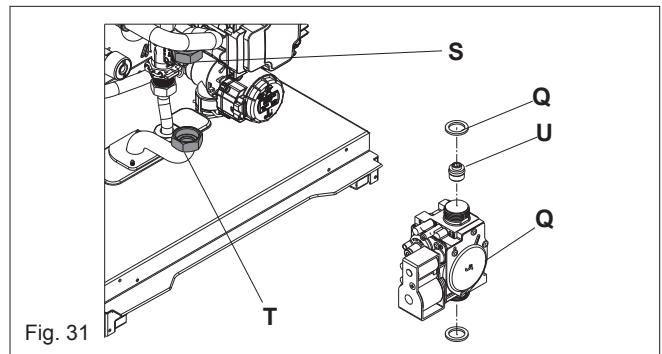

Fig. 31

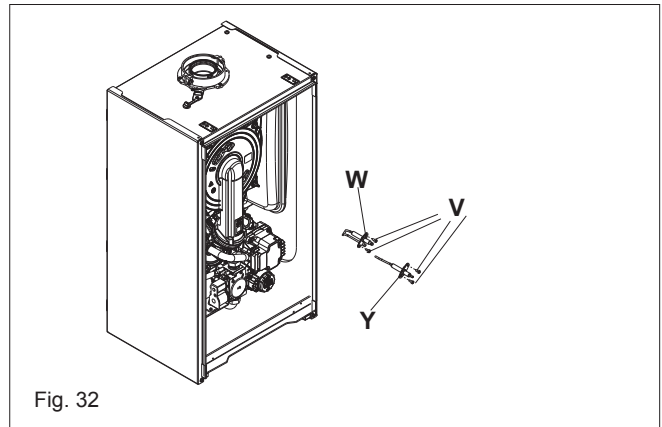

Fig. 32

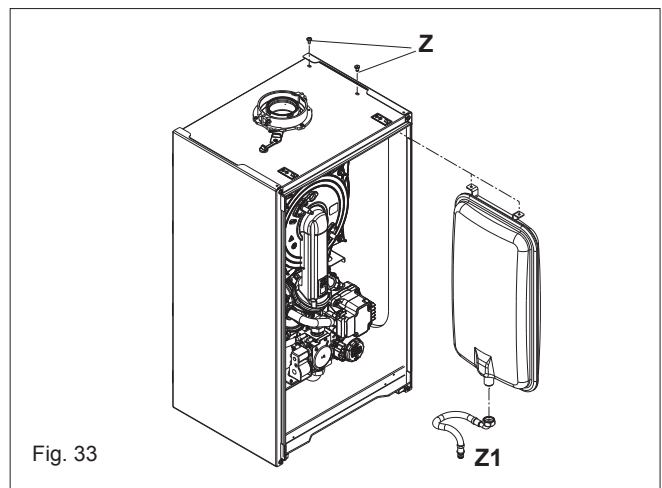

Fig. 33

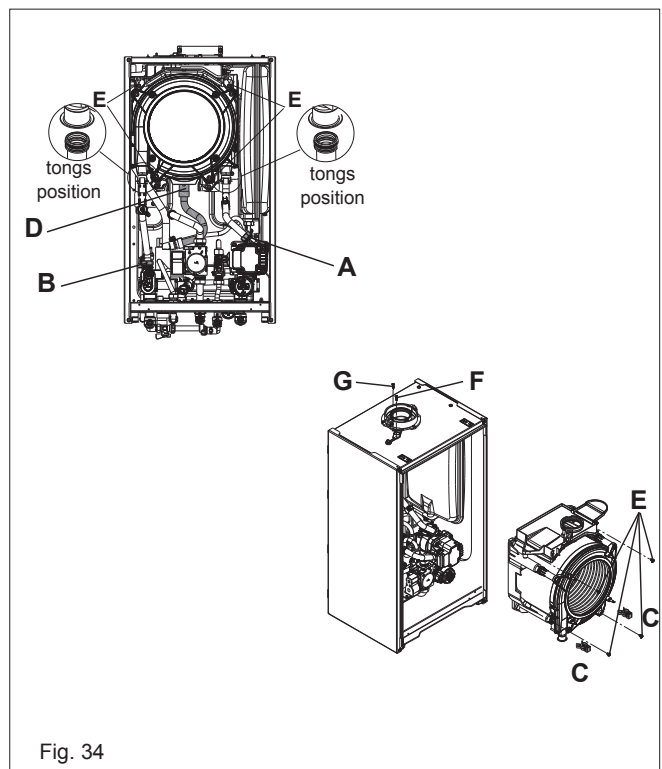

Fig. 34

7.22.2 TRANSFORMER (FIG. 35)

Carry out component removal procedure as described in 7.9. Unscrew the screw that fixes the transformer and remove it.

7.23 COMBUSTION UNIT (Fig. 36)

Refer to 7.9 and carry out the component removal procedure

- Remove the casing as indicated in paragraph 7.10.
- Disconnect the electrode connection cables.
- Disconnect the fan power cables.
- Remove the mixer clip (A).
- Loosen the gas ramp nut (B).
- Remove and rotate the gas train.

Remove the 4 nuts (C) together with the gasket (E) and extract the air/gas conveyor assembly including fan and mixer taking care not to damage the insulating panel and the electrodes. Check the integrity of the burner insulation panel and the sealing gasket and replace it if necessary, following the appropriate procedure.

7.24 FAN AND MIXER (FIG. 37)

Refer to 7.9 and carry out the component removal procedure

- Carry out the component removal procedure as described in 7.23 chapter.
- Completely unscrew the 2 screws (B) and loosen the 2 screws (C) to extract the fan.
- Unscrew the 3 screws (A) that fix the mixer to the fan and remove it.
- To disassemble the non-return valve (clapet - D) completely unscrew the 2 screws (C).

Once all the operations have been completed, reassemble all the components operating in the opposite direction to that described.

Restore voltage and gas supply to the boiler.

7.25 DIVERTER VALVE ASSEMBLY (FIG. 38)

Carry out component removal procedure as described in 7.9. Remove the valve actuator as described in Fig. 32. Locate and remove the locking pin (G2) that secures the valve housing cover to the hydraulic manifold. Gently prise the valve assembly from the manifold (K2). Replace in the reverse order ensuring that the seating assembly is inserted properly. Ensure all seals are in good condition, taking care to ensure they are replaced correctly.

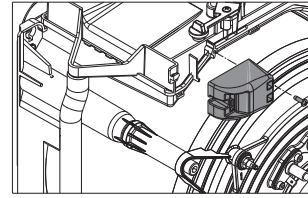

Fig. 35

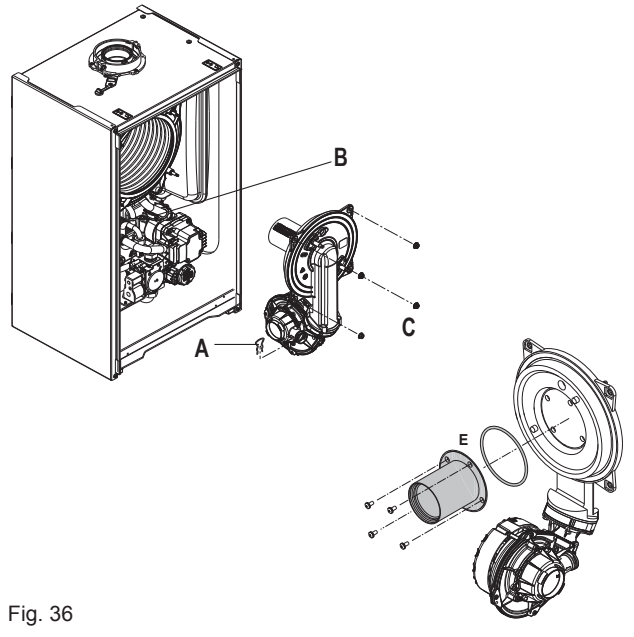

Fig. 36

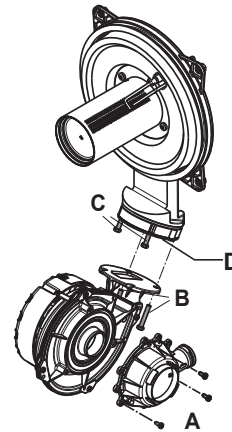

Fig. 37

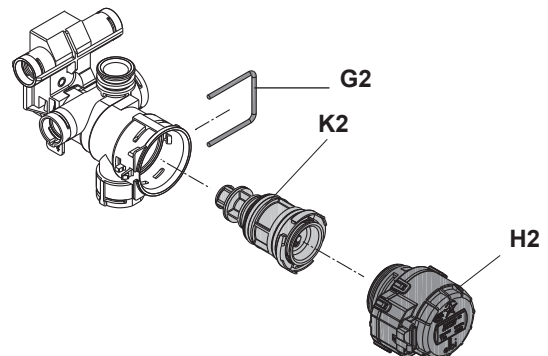

Fig. 38

7.26 REMOVING THE SIPHON (FIG. 39)

Refer to 7.9 and carry out the component removal procedure

- Take out the condensate collection pipe
- Unscrew the SRD device
- Unscrew the screw (A) and remove the plate (B)
- Take out the inside part (C) of the siphon.

Once the operations are finished, put back the components in the reverse order to that described, checking the gasket and sealing OR are correctly positioned.

7.27 REPLACING INTERFACE

Refer to 7.9 and carry out the component removal procedure. Remove the appliance PCB as detailed in 7.18. Locate and remove the securing screws that hold the interface to the control panel, and gently lift the interface away from the panel. Disconnect the 4-wire plug from the interface, noting its position.

Replace in the reverse order, ensuring that the interface is correctly located and engaged with the corresponding interface buttons (also refer to 7.28).

7.28 REPLACING PCB OR INTERFACE

When either the PCB or interface has been replaced, it may be necessary to re-programme the parameters of the appliance to suit the personalised settings, e.g. enable clock, appliance, type, etc.

Check that the following parameters are matched to suit the needs of the specific installation/application.

- P3.01
- P3.02
- P3.03
- P3.06
- P3.07
- P3.08
- P3.09
- P3.10.

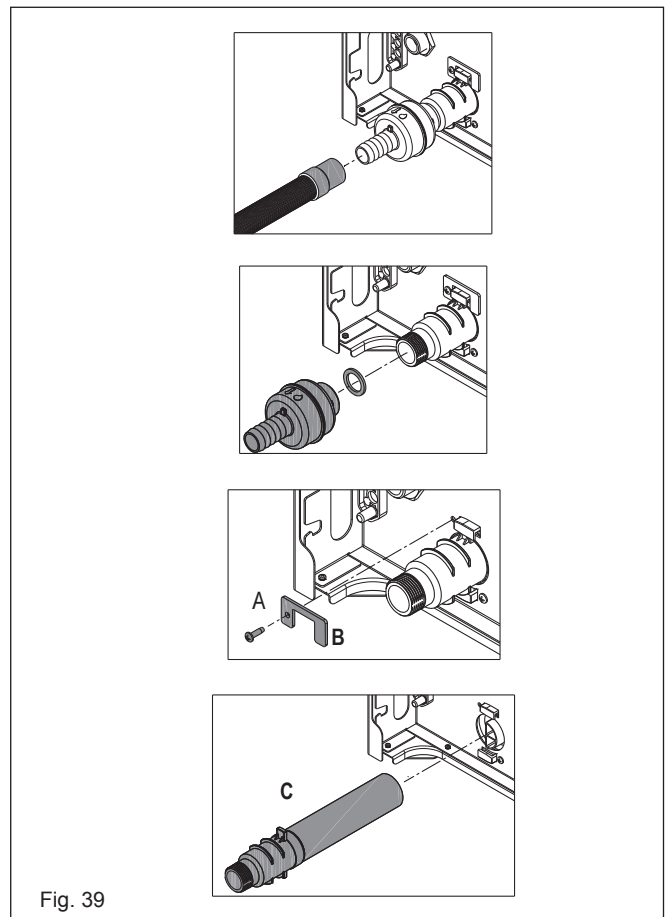

Fig. 39

8 CHECKS, ADJUSTMENTS AND FAULT FINDING

NOTE

Please refer to 3 - 3E and use the appropriate PPE when carrying out any of the actions or procedures contained within this section.

8.1 CHECKING APPLIANCE OPERATION

When carrying out any repairs or servicing to the appliance, the relevant commissioning procedure must be undertaken to ensure the continued safe operation of the appliance. Particular attention should be made to ensure gas tightness, water tightness and the electrical integrity of the appliance.

8.2 APPLIANCE MODES OF OPERATION

NOTE

There must be sufficient system water pressure (min. 0.5 bar) to ensure the water pressure switch is activated. If there is insufficient system pressure the pump and fan will be prevented from operating and the low-pressure fault code will be indicated.

8.2.1 MODE SELECTION IN THE OFF/RESET POSITION

When the mode selection is in the OFF/RESET position, the following functions are active.

Active functions:

- frost-protection system
- pump & actuator anti-block.

8.2.2 ON-BOARD FUNCTIONS

- **CO FUNCTION:** the CO function when activated, will allow the appliance to run at CH maximum, DHW maximum or minimum output whilst a combustion analysis check or a mechanical gas valve calibration is being carried out. Whilst the CO function is active, all other functions are disabled (minimum power operating period, anti-cycle, set-point, etc). Once enabled, the CO function will remain active for a 15-minute period, or until the function is manually deactivated
- **FROST-PROTECTION:** this function is only active when there are no requests for heating or HW. If the temperature drops below 5°C, the boiler will operate on minimum power until the temperature of the thermistors reaches 35°C for CH and 55°C for DHW. Thereafter the pump & fan will over-run for 30-seconds.
- **ANTI-CYCLE FUNCTION:** the anti-cycle function ensures the burner remains switched off for at least 3-minutes after the set-point hysteresis (set-point + 5-deg) for CH heat request.
- **PUMP ANTI-BLOCK FUNCTION:** when there has been no heating or HW request for 24-hours, the anti-block cycle is activated. The pump will be activated for a period of 30-seconds.
- **ACTUATOR ANTI-BLOCK FUNCTION:** when there has been no heating or HW request for 24-hours, the anti-block cycle is activated. The diverter valve actuator will motor briefly to the heating position, and then back to the DHW position. The pump will run briefly.
- **DHW PRE-HEAT FUNCTION:** when the DHW pre-heat function is enabled, the appliance will light periodically to maintain the temperature of the DHW heat exchanger. When the DHW thermistor and the primary thermistor fall below 35°C and 55°C respectively, the boiler will fire on minimum +25% power until the primary thermistor exceeds 55°C. Thereafter the pump will over-run for a period of 30-seconds.

8.2.3 HEATING MODE

With the mode selection in the heating & hot water position and any additional controls (time clock, programmer, room thermostat, etc.) calling for heat, the appliance will operate in the heating mode. The pump and fan will be activated via the flow temperature sensor. When the fan is sensed to be operating correctly (tacho signal), the ignition sequence commences. Ignition is sensed by the electronic circuit to ensure flame stability at the burner. Once successful ignition has been achieved, the electronic circuitry increases the gas rate to 75% for a period of 15 minutes.

The speed of the fan and therefore the output of the boiler is determined by the temperature of the water sensed by the flow temperature sensor, consequently a high temperature at the flow sensor results in a lower fan speed. As the water temperature increases, the temperature sensors – located on the flow pipe of the boiler – reduce the fan speed via the electronic circuitry. Depending on the load, either the water temperature will continue to rise until the set point is achieved or the water temperature will fall whereby fan speed will increase relative to the output required. When the boiler has reached the set point (+ hysteresis), the burner will switch off. The built-in anti-cycle device prevents the burner from re-lighting for approximately 3-minutes.

When the temperature of the flow sensor falls below the set point (- hysteresis), the burner will re-light.

NOTE

If the spark/sensing electrode does not sense ignition the appliance will re-attempt ignition a further 4-times then go to lockout. When the set-point has been reached (the position of the heating temperature selector) as measured at the primary thermistor, the appliance will begin the modulation phase whereby the fan and gas valve will continuously modulate to maintain the set-point. If the temperature continues to rise and exceeds the set-point by 5°C (hysteresis), the burner will shut down. A new ignition sequence will be enabled when the 3- minute anti-cycle has been performed and the temperature at the primary thermistor has dropped 5°C (hysteresis) below the set-point.

8.2.4 DHW MODE

With the selector switch in either the hot water only or heating & hot water position, the appliance will operate in the hot water mode whenever a DHW outlet is opened. A flow rate exceeding 2-litres per minute will activate the DHW flow switch whereupon the pump and fan will be activated via the flow temperature sensor. When the fan is sensed to be operating correctly (tacho signal), the ignition sequence commences. Ignition is sensed by the electronic circuitry to ensure flame stability at the burner. Once successful ignition has been achieved, the electronic circuit allows the gas rate to achieve the modulation value.

NOTE

When the request for heating and/or hot water has been satisfied, the appliance pump and fan may continue to circulate to dissipate any residual heat within the appliance.

ATTENTION

Gas type and appliance output **must be set** according to the specific appliance specification. Vokèra accepts no responsibility if the gas type is not correctly adjusted according to the respective appliance specification as detailed on the appliance data badge.

8.3 CHECKING THE CO₂ AND ADJUSTING THE GAS VALVE

THE GAS VALVE MUST BE SET-UP OR ADJUSTED WITH THE AID OF A PROPERLY CALIBRATED FLUE GAS ANALYSER. Isolate the appliance from the electrical supply and remove the appliance casing as described in 4.7.

Set the flue gas analyser to read CO₂ and insert the probe into the flue analysis test point.

8.3.1 COMBUSTION CHECK

To carry out the combustion analysis, proceed as follows:

- set the boiler to the OFF status by pressing button 1 

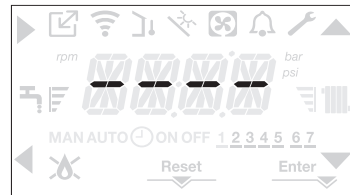

- Remove the screw and the cover on the air distribution box (A-B).
- Insert the analysis probe adaptor (D) located in the documentation envelope, into the hole for the combustion analysis.
- Insert the flue gases analysis probe into the adaptor.

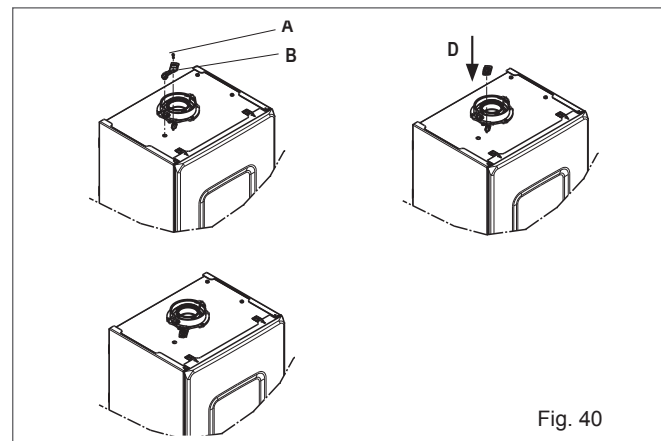

Fig. 40

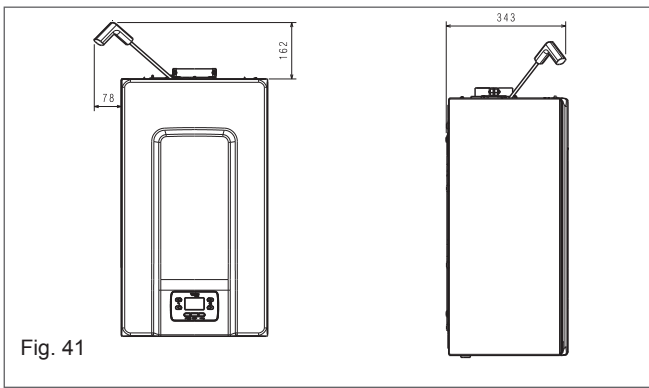
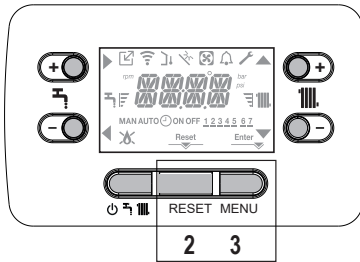

Fig. 41

- Activate the combustion control function by pressing buttons **2+3** for at least 2sec



- the display shows the scrolling text CO and the icons ▲, ▼, ► and ◀ come on:



- using the ▲, ▼ keys it is possible to change the fan speed
- set the max value (rpm) and confirm the choice with ►.

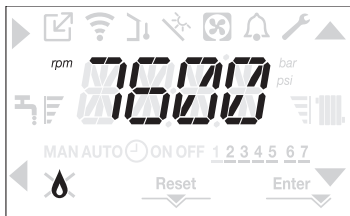

The display shows for 10 sec. the number of revs set, together with the rpm icon.

- The boiler will function at max power.
- Check on the analyser that the max CO₂ complies with what indicated in the table, if data are different proceed with the calibration of the gas valve - see paragraph "8.10 Gas valve calibration".

| CO ₂ max | NATURAL GAS (G20) | LPG (G31) | |
|---------------------|-------------------|-----------|---|
| 35 C | 9,1 | 10,0 | % |
| 40C | 9,1 | 10,0 | % |

- Set the min value (rpm) and confirm the choice with ►.

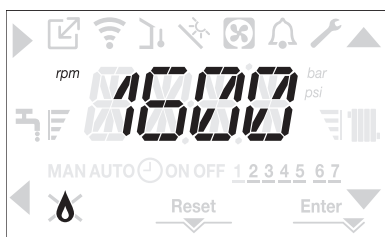

- The display shows for 10 sec. the number of revs set, together with the rpm icon.
- The boiler will function at min power.
- Check on the analyser that the min CO₂ complies with what indicated in the table, if data are different proceed with the calibration of the gas valve - see paragraph "8.10 Gas valve calibration".

| CO ₂ min | NATURAL GAS (G20) | LPG (G31) | |
|---------------------|-------------------|-----------|---|
| 35 C | 9,0 | 10,0 | % |
| 40 C | 9,0 | 10,0 | % |

- by pressing ◀ button it is possible to stop function in advance.

When the checks are completed:

- exit the function by pressing the button ◀
- remove the analyzer probe and close the combustion analysis sockets with the appropriate plugs and relative screw
- replace and store the analysis probe adapter supplied with the boiler, in the documentation envelope
- set the boiler in the desired operating mode according to the season
- adjust the required temperature values according to customer requirements.

⚠ When the combustion analysis is in progress all heat requests are inhibited and a message is shown on the display.

IMPORTANT

The combustion analysis function is active for a maximum time of 15 minutes; the burner shuts down if an outlet temperature of 95° C is reached. It will ignite again when the temperature falls below 75° C.

⚠ With OTBus device connected it is not possible to activate the combustion control function. To perform flue gas analysis, disconnect the OTBus connection wires and wait 4 minutes, or disconnect the power supply and re-power the boiler.

⚠ The combustion analysis function is normally performed with the three-way valve positioned in heating mode. It is possible to switch the three ways to the DHW generating a request for domestic hot water at the maximum flow rate during the execution of the function itself. In this case, the domestic hot water temperature is limited to a maximum value of 65° C. Wait for the burner to ignite.

This procedure must be undertaken by qualified personnel.

8.4 CHECKING THE EXPANSION VESSEL

Carry out the component removal procedure as described in 7.9. You must ensure that the boiler is completely drained of water. Using a suitable pressure gauge, remove dust cap on expansion vessel and check the charge pressure. The correct charge pressure should be 1.0 bar ± 0.1 bar. If the charge pressure is less, use a suitable pump to increase the charge.

NOTE

You must ensure the drain valve is in the open position whilst re-charging takes place. Replace the dust cap and carry out the relevant commissioning procedure (section 6).

8.5 EXTERNAL FAULTS

Before carrying out any faultfinding or component replacement, ensure the fault is not attributable to any aspect of the installation.

8.5.1 INSTALLATION FAULTS

| Symptom | Possible cause |
|--------------|--------------------------------------|
| No ignition | Check wiring/check electrical supply |
| No hot water | Check pipe-work |
| No heating | Check external controls |

| Fault | Possible cause |
|------------|---|
| Fault code | Check gas supply, check flue system, check polarity |

8.6 ELECTRICAL CHECKS

Any electrical checks must be carried out by a suitably qualified person.

8.6.1 EARTH CONTINUITY TEST

Isolate the appliance from the electrical supply, and using a suitable multi-meter carry out a resistance test. Connect test leads between an appliance earth point and the earth wire of the appliance supply cable. The resistance should be less than 1 OHM. If the resistance is greater than 1 OHM check all earth wires and connectors for continuity and integrity.

8.6.2 SHORT CIRCUIT CHECK

Isolate the appliance from the electrical supply, and using a suitable multi-meter, carry out a short circuit test between the Live & Neutral connections at the appliance terminal strip. Repeat above test on the Live & Earth connections at the appliance terminal strip.

NOTE

Should it be found that the fuse has failed but no fault is indicated, a detailed continuity check will be required to trace the fault. A visual inspection of components may also assist in locating the fault.

8.6.3 POLARITY CHECK

With the appliance connected to the electrical supply and using a suitable multimeter, carry out the following voltage tests:

- connect test leads between the Live & Neutral connections at the appliance terminal strip. The meter should read approximately 230V ac. If so proceed to next stage. If not, see 8.6.4.
- connect test leads between the Live & Earth connections at the appliance terminal strip. The meter should read approximately 230V ac. If so proceed to next stage. If not, see 8.6.4.
- connect test leads between the Neutral & Earth connections at the appliance terminal strip. The meter should read approximately 0 – 15Vac. If so polarity is correct. If not, see 8.6.4.

8.6.4 REVERSED POLARITY OR SUPPLY FAULT

Repeat the above tests at the appliance isolator, if testing reveals correct polarity and/or supply at the isolator, re-check wiring and connections between the isolator and the appliance. If tests on the isolator also reveal reversed polarity or a supply fault, consult the local electricity supplier for advice.

8.6.5 RESISTANCE TO EARTH CHECK

Isolate the appliance from the electrical supply, and using a suitable multi-meter carry out a resistance test. Connect test leads between the Live & Earth connections at the appliance terminal strip. If the meter reads other than infinity there is a fault that must be isolated, carry out a detailed continuity check to identify the location of the fault.

These series of checks must be carried out before attempting any faultfinding procedures on the appliance. On completion of any task that required the disconnection and re-connection of any electrical wiring or component, these checks must be repeated.

8.7 FAULT FINDING

Before attempting any fault finding, the electrical checks as detailed in 8.6 must be carried out. Isolate the appliance from the electrical supply.

Disconnect any external controls from terminal plug (CN5 - Fig. 43), and insert a link-wire between the two wires at the 'TA' connections.

NOTE

Restore the electrical supply to the boiler and turn the selector switch to the on position. The boiler should now function as described in section 8. Should the boiler fail to respond, the internal fuses and connectors should be checked to ensure integrity and continuity.

8.8 COMPONENT VALUES & CHARACTERISTICS

| COMPONENT | VALUE |
|---|---------|
| Fan | 230Vac |
| Pump | 230Vac |
| Valve actuator | 230Vac |
| Ignition transformer | 230Vac |
| Gas valve | 230Vac |
| Room thermostat connection | 24Vdc |
| NTC thermistor (dry contact) | 10Kohm |
| NTC thermistor (wet contact) | 10Kohm |
| FUNCTION | VALUE |
| Standard Heating temperature range (min – max °C) | 40 - 80 |
| DHW temperature range (min – max °C) | 37 - 60 |
| 75% maximum CH time | 15 min |
| Heating OFF hysteresis (°C) | SP + 5 |
| Heating ON hysteresis (°C) | SP – 5 |
| DHW OFF hysteresis (°C) | SP + 5 |
| DHW ON hysteresis (°C) | SP + 4 |
| Anti-cycle delay | 3-min |
| Pump over-run | 30-sec |
| Low output (min. output + %) | Min+25 |
| CO function max temp. (°C) | 90 |
| CO re-light temp. (°C) | 78 |
| CO function time | 15-min |
| Flow NTC max temp. (°C) | 90 |
| High limit thermostat (°C) | 105 |
| Flue NTC max temp. (°C) | 125 |
| Maximum differential (°C) | 35 |
| IGNITION CONTROL | VALUE |
| Ignition attempts before L/O (lockout) | 5 |
| Re-ignition attempts after loss of flame signal | 5 |

APPLIANCE STATUS AND FAULT CODES

When the boiler detects a temporary fault condition, the appropriate code is shown. If/when the fault is final a fault code will be displayed. See "8.13 Lights and faults".



8.9 ADJUSTMENTS

The boiler has already been adjusted by the manufacturer, if, however, adjustments have to be made again, for example after extraordinary maintenance, after the gas valve has been replaced or after a gas conversion from natural gas to LPG, or vice versa, follow the procedures described in following.

The maximum and minimum power settings, maximum heating and slow ignition must be performed strictly in the sequence indicated and only by qualified personnel:

- power the boiler
- carry out the access procedure to the parameters as indicated in paragraph "5.1 Access to the parameters"
- select menu P3 and confirm the selection with 
- display the desired parameter using the arrows - see table -

| | |
|-------|------------------|
| P3.06 | min fan speed |
| P3.07 | max fan speed |
| P3.08 | slow ignition |
| P3.09 | max CH fan speed |

- then enter the sub-menu by pressing 
- set the desired values with  and , referring to the following tables

| MAX RPM FAN SPEED | NATURAL GAS (G20) | LPG (G31) | |
|-------------------|-------------------|---------------|-----|
| 35C CH-DHW | 6.900 - 7.800 | 6.800 - 7.700 | rpm |
| 40C CH-DHW | 6.900 - 9.200 | 6.800 - 8.900 | rpm |

| table 2 | | | |
|-------------------|-------------------|-----------|-----|
| MIN RPM FAN SPEED | NATURAL GAS (G20) | LPG (G31) | |
| 35C | 1.700 | 2.000 | rpm |
| 40C | 1.700 | 2.000 | rpm |

| table 3 | | | |
|---------------|-------------------|-----------|-----|
| Slow ignition | NATURAL GAS (G20) | LPG (G31) | |
| 35C - 40C | 5.500 | 5.500 | rpm |

- confirm values with **Enter**.

8.10 GAS VALVE CALIBRATION

Perform the CO₂ verification procedure as indicated in paragraph “8.3.1 Combustion check”, if it is necessary to modify the values, proceed as follows:

- turn clockwise on the maximum power adjustment screw to decrease the value
- turn the minimum power adjustment screw clockwise to increase the value.

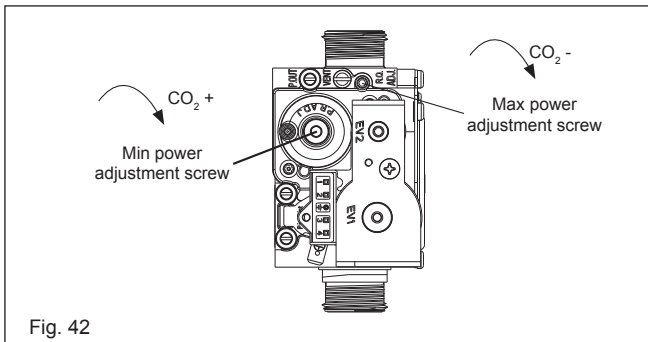
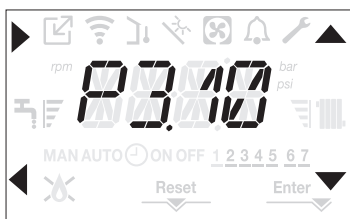

Fig. 42

8.11 RANGE RATED

This boiler can be adapted to the heating requirements of the system, in fact it is possible to set the maximum delivery for heating operation of the boiler itself:

- power up the boiler
- access the technical parameters menu, as indicated in the paragraph “5.1 Access to the parameters”
- select the P3 menu and confirm the selection with **▶**
- the display shows P3.10, enter the sub-menu by pressing **▶**



- set the maximum desired heating value (rpm) with the **▲** and **▼** keys, confirming the selection with **Enter**

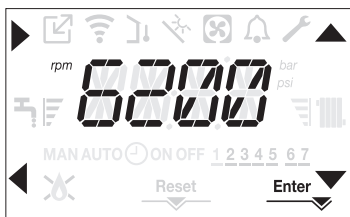

- Once the required output has been set (maximum heating), put the value on the self-adhesive label on the back cover of this manual. For subsequent controls and adjustments, refer to the set value.

⚠ The calibration does not entail the ignition of the boiler.

The boiler is delivered with the adjustments shown in the technical data table.

Depending on plant engineering requirements or regional flue gas emission limits it is, however, possible to modify this value, referring to the following graphs.

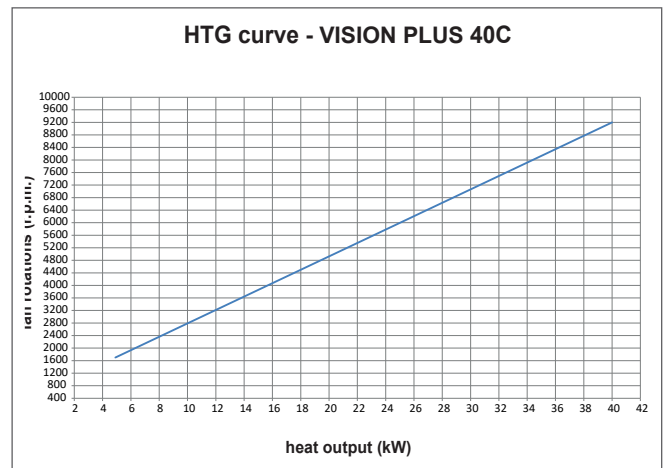
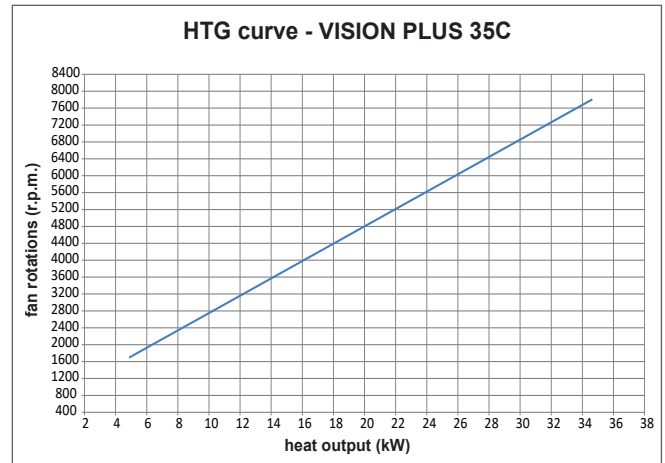

8.12 SETTING THE THERMOREGULATION

Enabling THERMOREGULATION occurs in the following way:

- access the technical parameters menu, as indicated in the paragraph “5.1 Access to the parameters”
- select the menu P4 and then P4.18 = 1.



Thermoregulation only works with the outdoor temperature sensor connected and active only for the HEATING function. If P4.18 = 0 or outdoor temperature probe disconnected the boiler operates at a fixed point. The temperature measured by the outdoor temperature sensor is displayed in “8.15 INFO menu” under I0.09. The thermoregulation algorithm will not directly use the outdoor temperature, but rather a calculated outdoor temperature that takes into account the building’s insulation: in buildings that are well insulated, the outdoor temperature variations will have less impact than those that are poorly insulated by comparison.

REQUEST FROM OT CHRONOTHERMOSTAT

In this case the delivery setpoint is calculated by the chronothermostat according to the outdoor temperature value and the difference between the ambient temperature and the desired ambient temperature.

REQUEST FROM ROOM THERMOSTAT

In this case the delivery setpoint is calculated by the adjustment board according to the outdoor temperature value so as to obtain an estimated outdoor temperature of 20° (reference ambient temperature). There are 2 parameters that compete to calculate the output setpoint:

- slope of the compensation curve (KT)
- offset on the reference ambient temperature.

SELECTING THE THERMOREGULATION CURVE (PARAMETER P4.19)

The thermoregulation curve for heating maintains a theoretical temperature of 20°C indoors, when the outdoor temperature is between +20°C and -20°C. The choice of the curve depends on the minimum outdoor temperature envisaged (and therefore on the geographical location), and on the delivery temperature envisaged (and therefore on the type of system). It is carefully calculated by the installer on the basis of the following formula:

$$KT = \frac{T_{\text{outlet envisaged}} - T_{\text{shift}}}{20 - \text{min. design external } T}$$

Tshift = 30°C standard system
25°C floor installations

If the calculation produces an intermediate value between two curves, you are advised to choose the thermoregulation curve nearest the value obtained.

Example: if the value obtained from the calculation is 1.3, this is between curve 1 and curve 1.5. Choose the nearest curve, i.e. 1.5.

The settable KT values are as follows:

- standard system: 1.0-3.0
- floor system 0.2-0.8.

Through the interface it is possible to access the menu P4 and the parameter P4.19 to set the pre-selected thermoregulation curve:

- access the technical parameters menu, as indicated in the paragraph "5.1 Access to the parameters"
- select the menu P4 and then P4.19
- press the key **▶** to confirm
- set the desired climatic curve with the **▲** and **▼** arrow keys
- confirm with **Enter**.

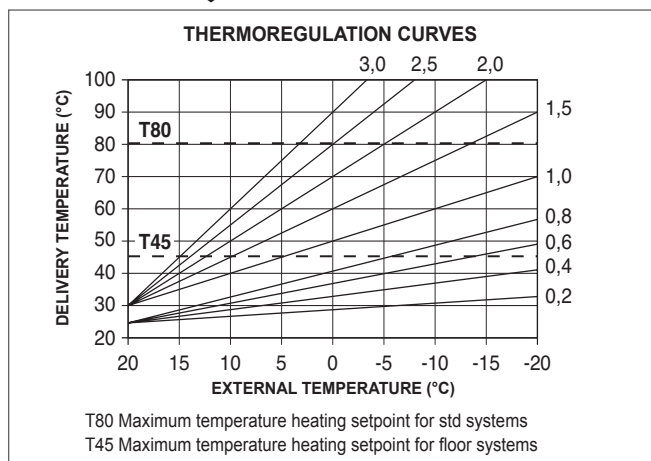

OFFSET ON THE REFERENCE AMBIENT TEMPERATURE

The user can, in any event, indirectly intervene on the value of the HEATING setpoint setting, with reference to the reference temperature (20°C), an offset within the range -5 - +5 (offset 0 = 20°C). For correcting the offset see the paragraph "5.8.5 Adjusting the heating water temperature with an outdoor temperature sensor connected".

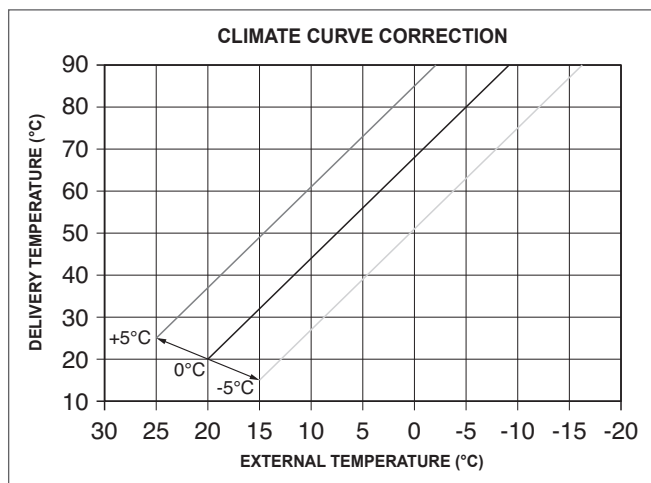

NIGHT COMPENSATION (PARAMETER P4.20)

If a ROOM THERMOSTAT is connected to a programming timer, from the menu P4 parameter P4.20 the night compensation can be enabled.

To set the night compensation:

- access the technical parameters menu, as indicated in the paragraph "5.1 Access to the parameters"
- select the menu P4 and then P4.20
- press the key **▶** to confirm
- set the parameter to 1
- confirm with **Enter**.

In this case, when the CONTACT is CLOSED, the heat request is made by the flow sensor, on the basis of the outdoor temperature, to obtain a nominal ambient temperature on DAY level (20°C). The opening of the contact does not produce a switch-off, but a reduction (parallel translation) of the climatic curve on NIGHT level (16°C). Also in this case, the user can indirectly modify the value of the HEATING setpoint inserting once again an offset on the reference DAY temperature (20°C) rather than NIGHT (16°C) that can vary within the range [-5 - +5]. For correcting the offset see the paragraph "5.8.5 Adjusting the heating water temperature with an outdoor temperature sensor connected".

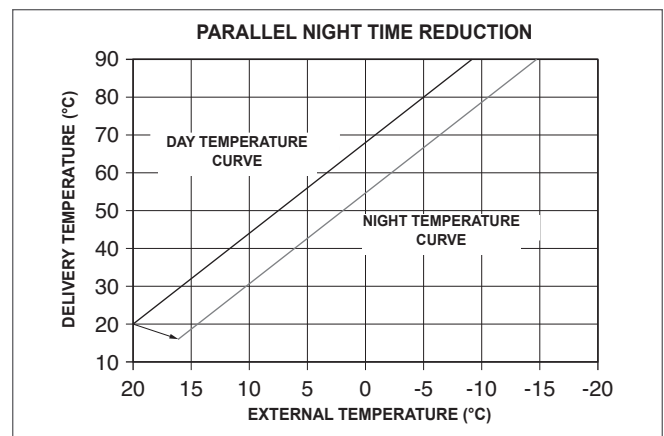

8.13 LIGHTS AND FAULTS

When there is a fault the icon blinks with a frequency of 0.5sec ON and 0.5sec OFF, the backlight blinks for 1min with a frequency of 1sec ON and 1sec OFF after which it switches off; while the bell continues to flash.

On the 4 digits of the display a scrolling message that describes the error code is shown.

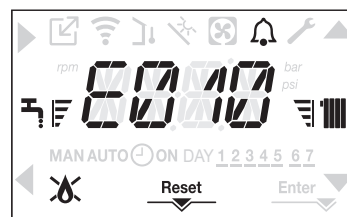



When a fault occurs the following icons can appear:

- it comes on when there is a flame alarm (E010)
- RESET comes on when there is an alarm that requires the manual reset by the user (flame lockout for example)
- comes on together with the icon , except for flame and water alarms.

RESET FUNCTION

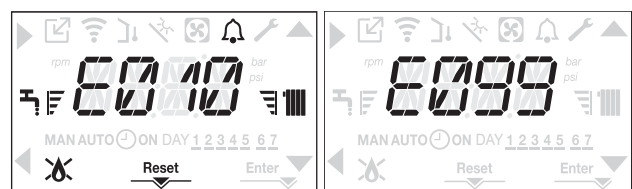
In order to reset the boiler's operation in the event of a fault, it is necessary to press the RESET button. At this point, if the correct operating conditions have been restored, the boiler will restart automatically. There are a maximum of 3 consecutive attempts.



 If the reset attempts do not activate the boiler, contact your installer or Vokera Ltd.

FOR FAULT E041

If the pressure drops below the safety threshold of 0.3 bar the boiler displays the fault code E041 for a transitional time of 10 min.

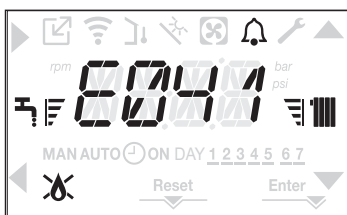

When the transitional time has finished, if the fault persists the fault code E040 is displayed.

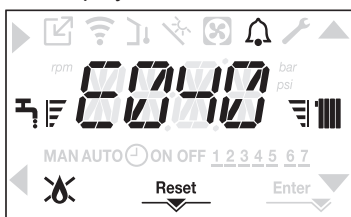

When the boiler has fault E040 it will be necessary to re-pressurise the system as indicated in section “4.2a WHAT IF I HAVE FREQUENTLY TO TOP-UP THE SYSTEM”. If the drop in pressure is very frequent, contact your installer or Vokera Ltd.

FOR FAULT E060

The boiler is working normally, but does not provide any stability of the domestic hot water temperature that, in any event, is supplied at a temperature of around 50°C. The intervention of the Technical Assistance Service is required.

FOR FAULT E091

The boiler has an auto-diagnostic system which, based on the total number of hours in certain operating conditions, can signal the need to clean the primary exchanger (alarm code E091).

Once the cleaning operation (made with special kit supplied as an accessory) it is necessary to reset to zero the total hour meter following procedure indicated below:

- access the technical parameters as explained in the section “5.1 Access to the parameters”
- select the P3 menu and then P3.12 with the keys ▲ and ▼
- set the parameter to 1 confirming the selection with Enter.

NOTE: The meter resetting procedure should be carried out after each in-depth cleaning of the primary exchanger or if this latter is replaced.

The total hours can be verified in the following way:

- access the INFO menus as indicated in the paragraph “8.15 INFO menu” at I0.15 to display the value of the flue gases probe meter.

8.14 BOILER FAULT CODES

| ERROR CODE | FAULT | DESCRIPTION OF ALARM TYPE |
|------------|--|----------------------------|
| E010 | flame lockout/ condensate discharge blockage fumes discharge alarm/air intake obstructed | definitive |
| E011 | extraneous flame | transitional |
| E020 | limit thermostat | definitive |
| E030 | fan fault | definitive |
| E040 | pressure transducer – load system | definitive |
| E041 | water transducer – load system | transitional |
| E042 | water transducer fault | definitive |
| E060 | domestic hot water probe fault | transitional |
| E070 | flow sensor fault | transitional |
| | flow sensor overtemperature | definitive |
| | flow/return sensor differential alarm | definitive |
| E077 | water thermostat main zone or zone 1 (when enabled) | transitional |
| E080 | return line probe fault | transitional |
| | return line probe overtemperature | definitive |
| | outlet/return line probe differential alarm | definitive |
| E084 | delivery line probe fault - zone 1 | transitional |
| E086 | delivery line probe fault - main zone | transitional |
| E090 | flue gas probe fault | transitional |
| | flue gas probe overtemperature | definitive |
| E091 | clean primary heat exchanger | transitional |
| E099 | reset attempts exhausted, boiler blocked | definitive, not resettable |
| <0,6 bar | low pressure verify the system | |
| >3,0 bar | high pressure verify the system | |
| COM | lost communication with boiler board | transitional |
| COMP | lost communication with main zone | transitional |
| COM1 | lost communication with zone 1 | transitional |
| FWER | FW version not compatible | definitive |
| OBCD | damaged clock | signalisation |
| OTER | OTBus configuration fault | |

For reset faults, except for E40-E041, call engineer.

8.15 INFO MENU

Pressing key 3 on the display screen displays a list of information regarding the operation of the boiler listed by parameter name and value. Passing from the display of one parameter to the next takes place by pressing respectively the keys ▲ and ▼.

Pressing the key ► allows the selected parameter to be displayed; pressing the key ◀ returns you to the main screen:

| Parameter name | Scrolling message only if parameter P1.05 = 1 | Description |
|----------------|---|--|
| I0.01 | SCREED HEATING HOURS | Number of hours passed with screed heater function |
| I0.02 | CH PROBE | Boiler delivery sensor value |
| I0.03 | RETURN PROBE | Boiler return sensor value |
| I0.04 | DHW PROBE | Domestic hot water probe value |
| I0.08 | EXHAUST PROBE | Flue gas probe value |
| I0.09 | OUTDOOR TEMP PROBE | Outdoor temperature sensor instantaneous value |
| I0.10 | FILTERED OUTDOOR TEMP | Outdoor temperature filtered value used in the thermoregulation algorithm for calculating the heating setpoint |
| I0.11 | DHW FLOW RATE | For instantaneous boiler with flowmeter |
| | DHW SETPOINT | Only in case of OTBus connection |
| I0.12 | FAN SPEED | Number of turns of the fan (rpm) |
| I0.13 | MAIN ZONE OUTLET | Main zone flow sensor value (when P4.12 = 1) |
| I0.14 | ZONE 1 OUTLET | Zone 1 flow sensor value (when P4.13 = 1) |
| I0.15 | EXHAUST PROBE HOURS | Number of hours the heat exchanger has been operating in "condensing mode" |
| I0.16 | MAIN ZONE SET | Main zone delivery setpoint |
| I0.17 | ZONE 1 SET | Zone 1 delivery setpoint (when P4.23 = 1) |
| I0.18 | WATER PRESSURE | System pressure |
| I0.30 | COMFORT | Domestic hot water comfort (COFF, CSTD) |
| I0.31 | SUN ON | Special functions active for high domestic hot water temperature inputs |
| I0.33 | PCB ID | Electronic board card identification |
| I0.34 | PCB FW | Electronic board card firmware revision |
| I0.35 | INTERFACE FW | Interface firmware |

8.16 EMBEDDED CLOCK

The appliance incorporates an embedded clock that can be enabled and used to insert ON/OFF time periods for boiler operation; and this can be used in series with additional external controls if necessary.

NOTES

- It is necessary to insert the correct day and time before enabling/setting the embedded clock
- It is necessary enter parameter P4.21 in order to enable or disable the embedded clock (factory default is disabled).
- It is necessary to enter parameter P4.22 in order to enable or disable mode selection (factory default is disabled).
- Use pass-code '18' in order to access the above parameters

8.17 CLOCK FUNCTIONALITY

The embedded clock has the following functionality:

- Up to 4 different ON/OFF periods (time bands) can be programmed independently for each day
- Weekdays (Mon-Fri) can be grouped
- Weekend (Sat & Sun) can be grouped
- Manual OFF (heating programme is suspended and boiler operates only for hot water)
- Manual ON (heating programme is suspended and boiler operates continuously for heating)*
- AUTO (boiler operates heating according to the set schedule)*

*a room thermostat – if fitted – will over-ride the operation of the heating

8.18 PROGRAMMING THE EMBEDDED CLOCK

To access the programming timing menu press the keys **B+D** for at least 2 sec.

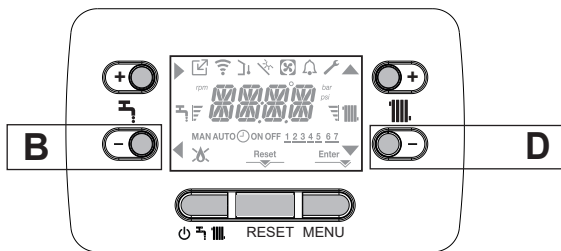

The display appears as in the following figure:

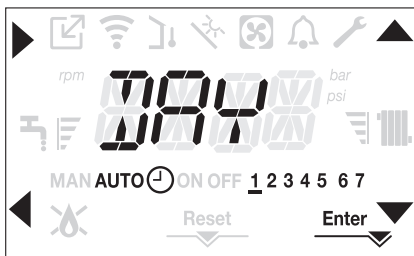

Using the ▲, ▼ arrows select the day or the pre-selected group of days:

1-2-3-4-5-6-7 programming of the individual days

1-5 programming from Monday to Friday

6-7 programming from Saturday to Sunday

1-7 programming the whole week

With the ► key you confirm the selection made and you pass to the programming of the time bands.

With the Enter key you exit the programming timing menu and you confirm the changes made.

With the ◀ key you exit without saving the selections.

Setting the time bands

The display shows TIME ON, press ► to set the ignition time, with ▲, ▼ change the time and confirm with ►.

The display shows TIME OFF, press ► to set the switching OFF time, with ▲, ▼ change the time and confirm with ►.

Time ON is displayed again, then the programming of the time bands is resumed up to the maximum of the programmable bands (four), or else Enter is pressed to confirm the bands set and you move on to the programming of the next day.

For each day of the week it is possible to program up to a maximum of 4 bands, each characterized by a start time and an end time.

Outside these time bands, heat requests from the room thermostat are ignored.

The central heating time bands enabled by default are:

07:30 ÷ 08:30/12:00 ÷ 13:30/18:00 ÷ 22:30 from MON to FRI

08:00 ÷ 22:30 from SAT to SUN.

When heating programming time is enabled, pressing the **C + D** keys allows you to switch from AUTO time programming to MAN ON or MAN OFF.

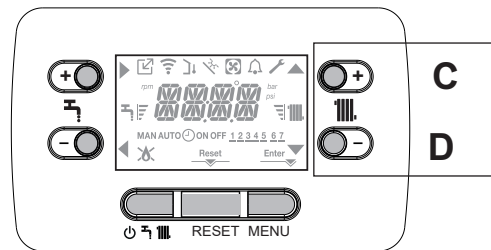

9 WIRING DIAGRAMS

NOTE

Please refer to 3 - 3E and use the appropriate PPE when carrying out any of the actions or procedures contained within this section.

9.1 EXTERNAL WIRING

The appliance comes with a factory fitted (TA) link to allow basic operation of the boiler via the mode selector switch. If external controls are to be added to the system, they must be connected to the appliance as shown in the following diagrams. For advice on controls that are not featured in this book, please contact Vokèra technical on 0844 391 0999.

9.1.1 EXTERNAL WIRING LIMITATIONS

Low voltage and High voltage cables must be run separately. Any external wiring must remain within the limits as detailed: room thermostat = 30-metres

9.1.2 OUTSIDE SENSOR

The outside sensor can be connected via a controls interface which enables a connection to be made directly on the PCB at plug CN6 (see "Fig. 44").

9.2 OTHER DEVICES

Contact the controls manufacturer and/or Vokèra technical department should you require more specific information on the suitability of a particular control. Further guidance on the recommended practice for the installation of external controls, can be found in CHeSS – HC5/HC6 (www.energyefficiency.gov.uk).

IMPORTANT

- The boiler must always be supplied with a permanent 230V electrical supply.
- The room thermostat connection is low voltage (24 Vdc)
- Do not connect any controls or auxiliary equipment to the low-voltage terminal strip, other than that approved/supplied by Vokèra Ltd.

9.3 OTBUS CONNECTION

When an OTBus remote control is connected to the system, the boiler display shows the following screen:



In particular on the boiler display:

- it is no longer possible to set the boiler OFF/WINTER/SUMMER status (it is set by the OTBus remote control)
- it is no longer possible to set the domestic hot water setpoint (it is set by the OTBus remote control)
- the combination of the **A+B** keys remains active for the setting of the DOMESTIC HOT WATER COMFORT function
- the domestic hot water setpoint is displayed in the INFO menu
- the heating setpoint set on the boiler display is used only if there are heat requests from the TA and the OTBus remote control does not have a request if the parameter:
 - P3.11 = 1
 - or
 - P3.11 = 0 and the jumper on 1-2pin of X 21 is closed
- to activate the COMBUSTION CHECK function with an OTBus remote control connected, you must temporarily disable the connection by setting the parameter P8.03 = 0. Remember to reset this parameter once the function has finished.

We can see that it is not possible, with the OTBus remote control connected, to change the values of the parameter P4.12 and P4.23 from 0 to 1.

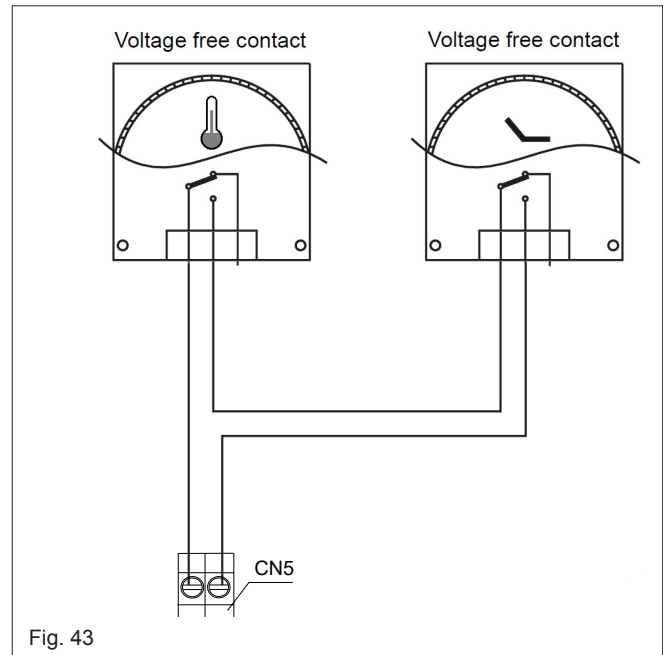

Fig. 43

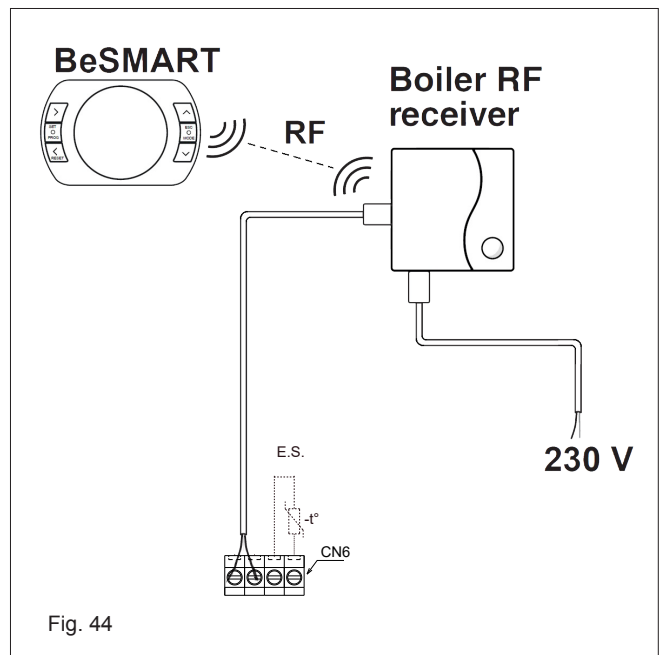
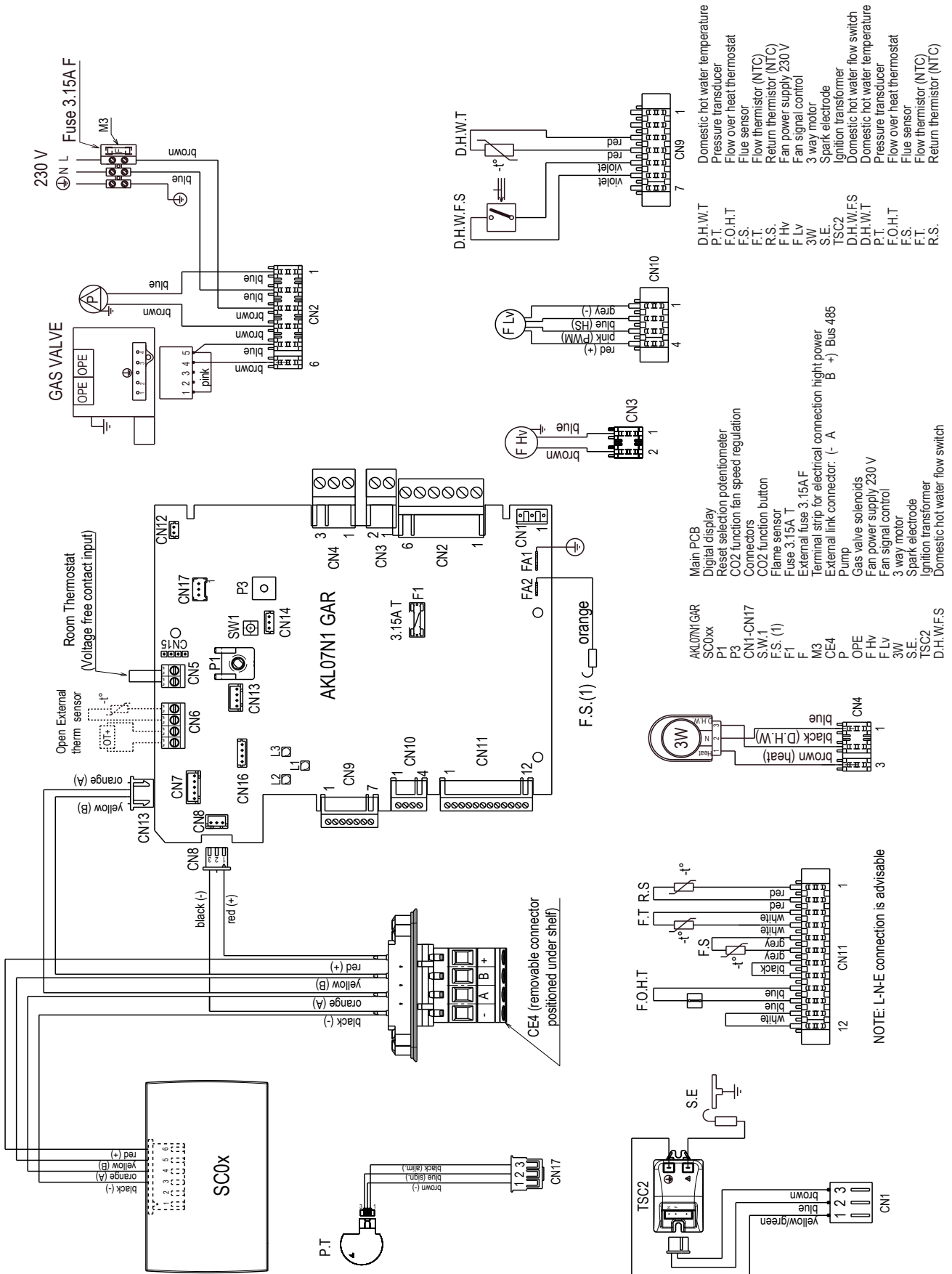

Fig. 44

FUNCTIONAL DIAGRAM

Fig. 45



NOTE: L-N-E connection is advisable

10 LPG INSTRUCTIONS

10.1 RELATED DOCUMENTS

| | | |
|---------|-------------|--|
| BS 5440 | PARTS 1 & 2 | FLUES & VENTILATION REQUIREMENTS |
| BS 5449 | PART 1 | FORCED CIRCULATION OF HOT WATER SYSTEMS |
| BS 5482 | PART 1 | DOMESTIC BUTANE & PROPANE GAS BURNERS IN PERMANENT DWELLINGS |
| BS 5546 | | INSTALLATION OF GAS HOT WATER SUPPLIES FOR DOMESTIC PURPOSES |
| BS 6798 | | INSTALLATION OF BOILERS OF RATED NOT EXCEEDING 60kW |

10.2 TECHNICAL DATA

| Gas Pressures | VISION PLUS 35C | VISION PLUS 40C |
|--|-----------------|-----------------|
| Inlet pressure | 37.0 mbar | 37.0 mbar |
| Heating maximum gas rate (kg/hr) | 2.33 | 2.33 |
| DHW maximum gas rate (kg/hr) | 2.69 | 3.11 |
| Minimum gas rate (kg/hr) | 0.54 | 0.54 |
| Injector size | 4.5 mm | 4.5 mm |
| CO ₂ @ maximum output (%) | 10.0 | 10.0 |
| CO ₂ @ minimum output (%) | 10.0 | 10.0 |
| CO @ maximum output (ppm) | 160 | 160 |
| CO @ minimum output (ppm) | 20 | 20 |
| Slow ignition (rpm) | 5.500 | 5.500 |
| CH maximum number of fan rotation (rpm) | 6.800 | 6.800 |
| DHW maximum number of fan rotation (rpm) | 7.700 | 8.900 |
| Minimum number of fan rotation (rpm) | 2.000 | 2.000 |

NOTE

Please refer to 3 - 3E and use the appropriate PPE when carrying out any of the actions or procedures contained within this section.

10.3 GAS CONVERSION

Conversion from a family gas to other family gas can be performed easily also when the boiler is installed.

This operation must be carried out by professionally qualified personnel.

The boiler is delivered to operate with methane gas (G20). To convert the boiler to propane gas (G31) use the specific accessory kits.

For disassembly, refer to the instructions below:

- remove the power supply to the boiler and close the gas tap
- remove the casing as indicated in paragraph "4.7 CASING REMOVAL"
- unhook and rotate the dashboard forward
- remove the gas valve (A)
- remove the nozzle (B) contained in the gas valve and replace it with the one contained in the kit

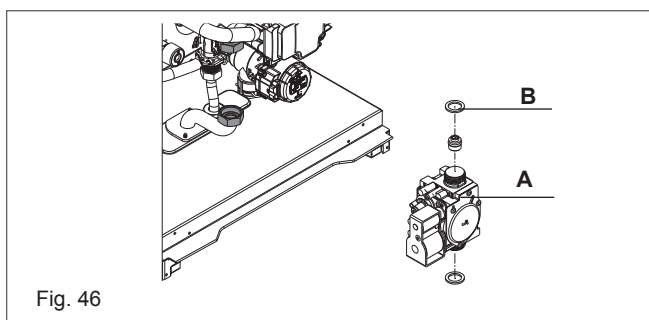

Fig. 46

- refit the gas valve
- reassemble the previously removed components
- power the boiler and open the gas tap.

Adjust the boiler as described in the paragraph "8.9 Adjustments".

! The conversion must be carried out by qualified personnel.

! After the conversion has been carried out, apply the new identification label contained in the documentation envelope.

10.4 COMPLETION

On completion of the combustion analysis check and/or any gas valve adjustment, refit the plug (see paragraph "8.3.1 Combustion check"). Remove the test probe from the test point and refit the sealing screw/s and/or cap.

IMPORTANT

A GAS TIGHTNESS CHECK MUST BE CARRIED OUT IF ANY GAS CARRYING COMPONENTS HAVE BEEN REMOVED, REPLACED OR DISTURBED.

ATTENTION

Gas type and appliance output **must be set** according to the specific appliance specification. Vokèra accepts no responsibility if the gas type is not correctly adjusted according to the respective appliance specification as detailed on the appliance data badge.

COMMISSIONING: CO AND COMBUSTION RATIO CHECK

BEFORE CO AND COMBUSTION RATIO CHECK

The installation instructions should have been followed, gas type verified and gas supply pressure/rate checked as required prior to commissioning.

As part of the installation process, **ESPECIALLY WHERE A FLUE HAS BEEN FITTED BY PERSONS OTHER THAN THE BOILER INSTALLER**, visually check the integrity of the whole flue system to confirm that all components are correctly assembled, fixed and supported. Check that the maximum flue lengths have not been exceeded and all guidance has been followed (e.g. Technical Bulletin 008).

The flue gas analyser should be of the correct type, as specified by BS 7967.

Before use, the flue gas analyser should have been maintained and calibrated as specified by the manufacturer. The installer must have the relevant competence for use of the analyser. Check and zero the analyser **IN FRESH AIR**, as per analyser manufacturer's instructions.

NOTE

The air/gas ratio valve is factory-set and must not be adjusted during commissioning unless this action is recommended, following contact with the Vokera technical help line. If any such adjustment is recommended and further checking of the boiler is required, the engineer must be competent to carry out this work and to use the flue gas analyser accordingly. If the boiler requires conversion to operate with a different gas family (e.g., conversion from natural gas to LPG) separate guidance will be provided by the Vokera technical help line and must be followed.

SET BOILER TO MAXIMUM RATE

In accordance with, section 7.3, set boiler to operate at maximum rate (full load condition). Allow sufficient time for combustion to stabilise. , insert analyser probe into air inlet sampling point.

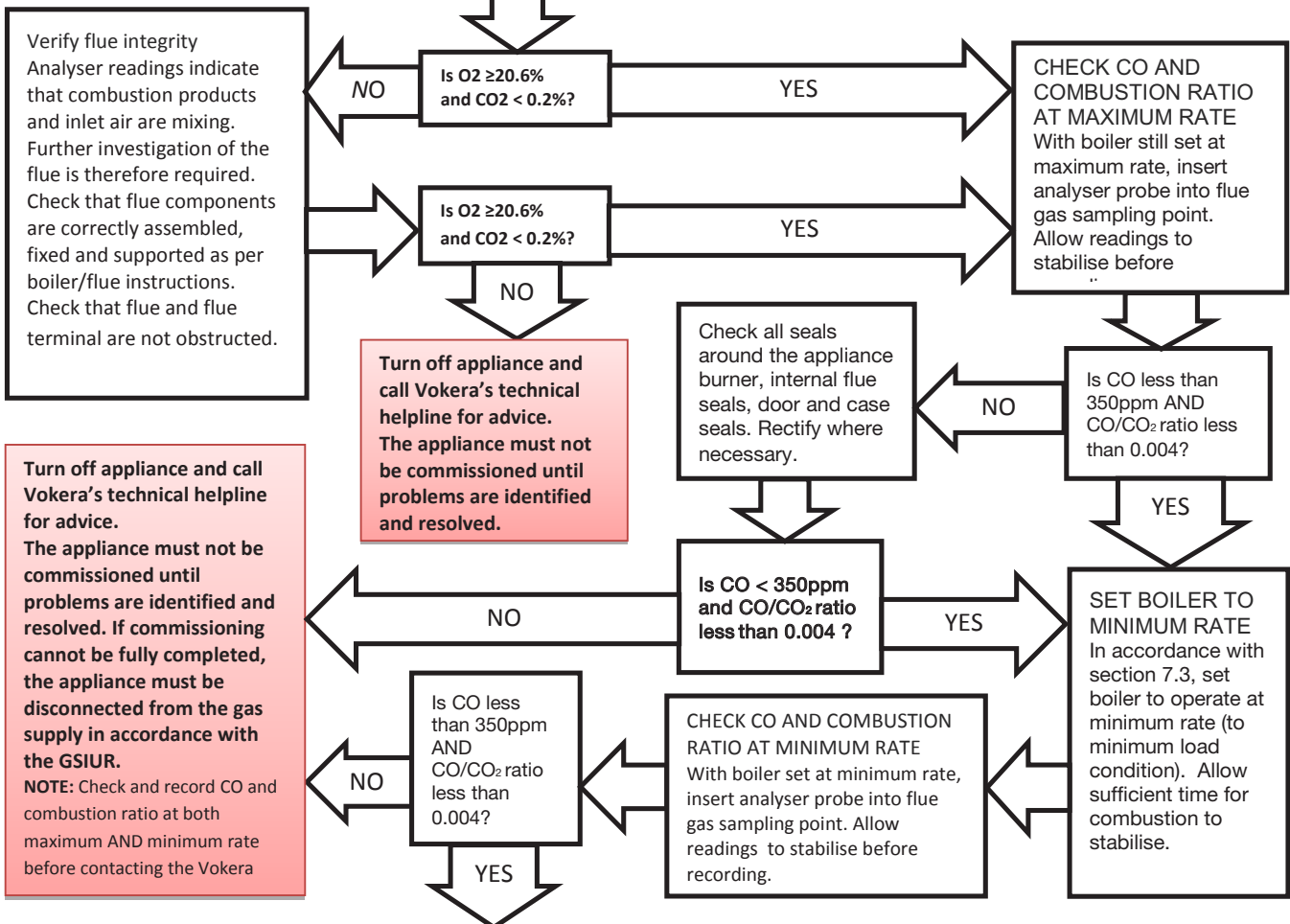

Boiler is operating satisfactorily No further actions required.

Ensure test points are capped, boiler case is correctly replaced and all other commissioning procedures are completed. Complete Benchmark Checklist, recording CO and combustion ratio readings as required.

Benchmark Commissioning & Warranty Validation Service Record

It is a requirement that the boiler is installed and commissioned to the manufacturers' instructions and the data fields on the commissioning checklist completed in full.

To instigate the boiler warranty the boiler needs to be registered with the manufacturer within one month of the installation. The warranty rests with the end-user (consumer), and they should be made aware it is ultimately their responsibility to register with the manufacturer, within the allotted time period.

It is essential that the boiler is serviced in line with the manufacturers' recommendations, at least annually. This must be carried out by a competent Gas Safe registered engineer. The service details should be recorded on the Benchmark Service and Interim Boiler Work Record and left with the householder. Failure to comply with the manufacturers' servicing instructions and requirements will invalidate the warranty.



www.hhic.co.uk

This Commissioning Checklist is to be completed in full by the competent person who commissioned the boiler as a means of demonstrating compliance with the appropriate Building Regulations and then handed to the customer to keep for future reference.

Failure to install and commission according to the manufacturers' instructions and complete this Benchmark Commissioning Checklist will invalidate the warranty. This does not affect the customer's statutory rights.

All installations in England and Wales must be notified to Local Authority Building Control (LABC) either directly or through a competent Persons Scheme. A Building Regulations Compliance Certificate will then be issued to the customer.

Heating and Hotwater Industry Council (HHIC)



www.centralheating.co.uk

GAS BOILER SYSTEM COMMISSIONING CHECKLIST & WARRANTY VALIDATION RECORD

| | | | | | | | | | | | | | | | |
|---|--|------------------------------|--|----|--|-------------------------------|--|-----------------|--|---------------------|-----|---------------------|--|-------|--|
| Address: | | | | | | | | | | | | | | | |
| Boiler make and model: | | | | | | | | | | | | | | | |
| Boiler serial number: | | | | | | | | | | | | | | | |
| Commissioned by (PRINT NAME): | | | | | | Gas Safe registration number: | | | | | | | | | |
| Company name: | | | | | | Telephone number: | | | | | | | | | |
| Company email: | | | | | | Company address: | | | | | | | | | |
| | | | | | | | | | | Commissioning date: | | | | | |
| Heating and hot water system complies with the appropriate Building Regulations? | | | | | | | | | | | Yes | | | | |
| Optional: Building Regulations Notification Number (if applicable): | | | | | | | | | | | | | | | |
| Time, temperature control and boiler interlock provided for central heating and hot water | | | | | | | | | | | Yes | | | | |
| Boiler Plus requirements (tick the appropriate box(s)) | | | | | | | | | | | | | | | |
| Boiler Plus option chosen for combination boiler in ENGLAND | | | | | | Weather compensation | | | Smart thermostat with automisation and optimisation | | | | | | |
| | | | | | | Load compensation | | | Flue Gas Heat Recovery | | | | | | |
| Time and temperature control to hot water | | | Cylinder thermostat and programmer/timer | | | | | | Combination boiler | | | | | | |
| Zone valves | | | pre-existing | | | Fitted | | | Not required | | | | | | |
| Thermostatic radiator valves | | | pre-existing | | | Fitted | | | Not required | | | | | | |
| Automatic bypass to system | | | pre-existing | | | Fitted | | | Not required | | | | | | |
| Underfloor heating | | | pre-existing | | | Fitted | | | Not required | | | | | | |
| Water quality | | | | | | | | | | | | | | | |
| The system has been flushed, cleaned and a suitable inhibitor applied upon final fill, in accordance with BS7593 and boiler manufacturers' instructions | | | | | | | | | | | Yes | | | | |
| What system cleaner was used? | | | | | | Brand: | | | Product: | | | | | | |
| What inhibitor was used? | | | | | | Brand: | | | Product: | | | | | | |
| Primary water system filter | | | pre-existing | | | Fitted | | | Not required | | | | | | |
| CENTRAL HEATING MODE measure and record (as appropriate) | | | | | | | | | | | | | | | |
| Gas rate (for combination boilers complete DHW mode gas rate) | | | | | | m ³ /hr | | | or | | | ft ³ /hr | | | |
| Central heating output left at factory settings? | | | | | | Yes | | | No | | | | | | |
| If no, what is the maximum central heating output selected? | | | | | | | | | | | | kW | | | |
| Dynamic gas inlet pressure | | | | | | | | | | | | mbar | | | |
| Central heating flow temperature | | | | | | | | | | | | °C | | | |
| Central heating return temperature | | | | | | | | | | | | °C | | | |
| System correctly balanced/rebalanced? | | | | | | Yes | | | | | | | | | |
| COMBINATION BOILERS ONLY | | | | | | | | | | | | | | | |
| Is the installation in a hard water area (above 200ppm)? | | | | | | Yes | | | No | | | | | | |
| Water scale reducer/softener | | | pre-existing | | | Fitted | | | Not required | | | | | | |
| What type of scale reducer/softener has been fitted? | | | | | | Brand: | | | Product: | | | | | | |
| Water meter fitted? | | | | | | Yes | | | No | | | | | | |
| If yes- DHW expansion vessel | | | pre-existing | | | Fitted | | | Not required | | | | | | |
| Pressure reducing valve | | | pre-existing | | | Fitted | | | Not required | | | | | | |
| DOMESTIC HOT WATER MODE Measure and record | | | | | | | | | | | | | | | |
| Gas rate | | | | | | m ³ /hr | | | or | | | ft ³ /hr | | | |
| Dynamic gas inlet pressure at maximum rate | | | | | | | | | | | | mbar | | | |
| Cold water inlet temperature | | | | | | | | | | | | °C | | | |
| Hot water has been checked at all outlets | | | | | | Yes | | | Temperature | | | °C | | | |
| CONDENSATE DISPOSAL | | | | | | | | | | | | | | | |
| The condensate drain has been installed in accordance with the manufacturers' instructions and/or BS5546/BS6798 | | | | | | | | | | | Yes | | | | |
| Point of termination | | | | | | Internal | | | External (only where internal termination impractical) | | | | | | |
| Method of disposal | | | | | | Gravity | | | Pumped | | | | | | |
| ALL INSTALLATIONS | | | | | | | | | | | | | | | |
| Record the following | | At max rate: | | CO | | ppm | | CO ₂ | | % | | CO/CO ₂ | | Ratio | |
| | | At min rate (where possible) | | CO | | ppm | | CO ₂ | | % | | CO/CO ₂ | | Ratio | |
| Where possible, has a flue integrity check been undertaken in accordance with manufacturers' instructions, and readings are correct? | | | | | | | | | | | Yes | | | | |
| The operation of the boiler and system controls have been demonstrated to and understood by the customer | | | | | | | | | | | Yes | | | | |
| The manufacturers' literature, including Benchmark Checklist and Service Record, has been explained and left with the customer | | | | | | | | | | | Yes | | | | |
| Commissioning Engineer's signature | | | | | | | | | | | | | | | |
| Customer's signature (To confirm satisfactory demonstration and receipt of manufacturers' literature) | | | | | | | | | | | | | | | |

* All installations in England and Wales must be notified to Local Authority Building Control (LABC) either directly or through a Competent Persons Scheme. A Building Regulations Compliance Certificate will then be issued to the customer.

© Heating and Hotwater Industry Council (HHIC)



www.centralheating.co.uk

SERVICE & INTERIM BOILER WORK RECORD

It is recommended that your boiler and heating system are regularly serviced and maintained, in line with manufacturers' instructions, and that the appropriate service / interim work record is completed.

Service provider

When completing a service record (as below), please ensure you have carried out the service as described in the manufacturers' instructions. Always use the manufacturers specified spare parts.

| SERVICE/INTERIM WORK ON BOILER <small>delete as appropriate</small> | | | | | Date: | |
|--|-------------------|---------------------------|--------------------|---|--------------------|-----|
| Engineer name: | | Company name: | | | | |
| Telephone N°: | | Gas Safe registration N°: | | | | |
| Max rate | CO | ppm | CO ₂ | % | CO/CO ₂ | |
| Min rate | CO | ppm | CO ₂ | % | CO/CO ₂ | |
| Where possible, has a flue integrity check been undertaken in accordance with manufacturers' instructions, and readings are correct?* | | | | | yes | |
| Gas rate: | m ³ /h | OR | ft ³ /h | | | |
| Were parts fitted? <small>delete as appropriate</small> | | Yes | No | | | |
| Parts fitted: | | | | | | |
| System inhibitor concentration has been checked and appropriate action taken, in accordance with BS 7593 and boiler manufacturers' instructions. * | | | | | yes | n/a |
| Comments: | | | | | | |
| Signature: | | | | | | |

*A System inhibitor efficacy test is required on every annual service in accordance with the manufacturers' instructions and BS 7593. It is only acceptable to not have undertaken this if the service engineers attendance visit was in between annual services to attend a non-water facing component.

| SERVICE/INTERIM WORK ON BOILER <small>delete as appropriate</small> | | | | | Date: | |
|--|-------------------|---------------------------|--------------------|---|--------------------|-----|
| Engineer name: | | Company name: | | | | |
| Telephone N°: | | Gas Safe registration N°: | | | | |
| Max rate | CO | ppm | CO ₂ | % | CO/CO ₂ | |
| Min rate | CO | ppm | CO ₂ | % | CO/CO ₂ | |
| Where possible, has a flue integrity check been undertaken in accordance with manufacturers' instructions, and readings are correct?* | | | | | yes | |
| Gas rate: | m ³ /h | OR | ft ³ /h | | | |
| Were parts fitted? <small>delete as appropriate</small> | | Yes | No | | | |
| Parts fitted: | | | | | | |
| System inhibitor concentration has been checked and appropriate action taken, in accordance with BS 7593 and boiler manufacturers' instructions. * | | | | | yes | n/a |
| Comments: | | | | | | |
| Signature: | | | | | | |

*A System inhibitor efficacy test is required on every annual service in accordance with the manufacturers' instructions and BS 7593. It is only acceptable to not have undertaken this if the service engineers attendance visit was in between annual services to attend a non-water facing component.

| SERVICE/INTERIM WORK ON BOILER <small>delete as appropriate</small> | | | | | Date: | |
|--|-------------------|---------------------------|--------------------|---|--------------------|-----|
| Engineer name: | | Company name: | | | | |
| Telephone N°: | | Gas Safe registration N°: | | | | |
| Max rate | CO | ppm | CO ₂ | % | CO/CO ₂ | |
| Min rate | CO | ppm | CO ₂ | % | CO/CO ₂ | |
| Where possible, has a flue integrity check been undertaken in accordance with manufacturers' instructions, and readings are correct?* | | | | | yes | |
| Gas rate: | m ³ /h | OR | ft ³ /h | | | |
| Were parts fitted? <small>delete as appropriate</small> | | Yes | No | | | |
| Parts fitted: | | | | | | |
| System inhibitor concentration has been checked and appropriate action taken, in accordance with BS 7593 and boiler manufacturers' instructions. * | | | | | yes | n/a |
| Comments: | | | | | | |
| Signature: | | | | | | |

*A System inhibitor efficacy test is required on every annual service in accordance with the manufacturers' instructions and BS 7593. It is only acceptable to not have undertaken this if the service engineers attendance visit was in between annual services to attend a non-water facing component.

| SERVICE/INTERIM WORK ON BOILER <small>delete as appropriate</small> | | | | | Date: | |
|--|-------------------|---------------------------|--------------------|---|--------------------|-----|
| Engineer name: | | Company name: | | | | |
| Telephone N°: | | Gas Safe registration N°: | | | | |
| Max rate | CO | ppm | CO ₂ | % | CO/CO ₂ | |
| Min rate | CO | ppm | CO ₂ | % | CO/CO ₂ | |
| Where possible, has a flue integrity check been undertaken in accordance with manufacturers' instructions, and readings are correct?* | | | | | yes | |
| Gas rate: | m ³ /h | OR | ft ³ /h | | | |
| Were parts fitted? <small>delete as appropriate</small> | | Yes | No | | | |
| Parts fitted: | | | | | | |
| System inhibitor concentration has been checked and appropriate action taken, in accordance with BS 7593 and boiler manufacturers' instructions. * | | | | | yes | n/a |
| Comments: | | | | | | |
| Signature: | | | | | | |

*A System inhibitor efficacy test is required on every annual service in accordance with the manufacturers' instructions and BS 7593. It is only acceptable to not have undertaken this if the service engineers attendance visit was in between annual services to attend a non-water facing component.

| SERVICE/INTERIM WORK ON BOILER <small>delete as appropriate</small> | | | | | Date: | |
|--|-------------------|---------------------------|--------------------|---|--------------------|-----|
| Engineer name: | | Company name: | | | | |
| Telephone N°: | | Gas Safe registration N°: | | | | |
| Max rate | CO | ppm | CO ₂ | % | CO/CO ₂ | |
| Min rate | CO | ppm | CO ₂ | % | CO/CO ₂ | |
| Where possible, has a flue integrity check been undertaken in accordance with manufacturers' instructions, and readings are correct?* | | | | | yes | |
| Gas rate: | m ³ /h | OR | ft ³ /h | | | |
| Were parts fitted? <small>delete as appropriate</small> | | Yes | No | | | |
| Parts fitted: | | | | | | |
| System inhibitor concentration has been checked and appropriate action taken, in accordance with BS 7593 and boiler manufacturers' instructions. * | | | | | yes | n/a |
| Comments: | | | | | | |
| Signature: | | | | | | |

*A System inhibitor efficacy test is required on every annual service in accordance with the manufacturers' instructions and BS 7593. It is only acceptable to not have undertaken this if the service engineers attendance visit was in between annual services to attend a non-water facing component.

| SERVICE/INTERIM WORK ON BOILER <small>delete as appropriate</small> | | | | | Date: | |
|--|-------------------|---------------------------|--------------------|---|--------------------|-----|
| Engineer name: | | Company name: | | | | |
| Telephone N°: | | Gas Safe registration N°: | | | | |
| Max rate | CO | ppm | CO ₂ | % | CO/CO ₂ | |
| Min rate | CO | ppm | CO ₂ | % | CO/CO ₂ | |
| Where possible, has a flue integrity check been undertaken in accordance with manufacturers' instructions, and readings are correct?* | | | | | yes | |
| Gas rate: | m ³ /h | OR | ft ³ /h | | | |
| Were parts fitted? <small>delete as appropriate</small> | | Yes | No | | | |
| Parts fitted: | | | | | | |
| System inhibitor concentration has been checked and appropriate action taken, in accordance with BS 7593 and boiler manufacturers' instructions. * | | | | | yes | n/a |
| Comments: | | | | | | |
| Signature: | | | | | | |

*A System inhibitor efficacy test is required on every annual service in accordance with the manufacturers' instructions and BS 7593. It is only acceptable to not have undertaken this if the service engineers attendance visit was in between annual services to attend a non-water facing component.

* All installations in England and Wales must be notified to Local Authority Building Control (LABC) either directly or through a Competent Persons Scheme. A Building Regulations Compliance Certificate will then be issued to the customer.

© Heating and Hotwater Industry Council (HHIC)



www.centralheating.co.uk

SERVICE & INTERIM BOILER WORK RECORD

It is recommended that your boiler and heating system are regularly serviced and maintained, in line with manufacturers' instructions, and that the appropriate service / interim work record is completed.

Service provider

When completing a service record (as below), please ensure you have carried out the service as described in the manufacturers' instructions. Always use the manufacturers' specified spare parts.

| | | | | | | |
|--|-------------------|---------------------------|--------------------|---|--------------------|-----|
| SERVICE/INTERIM WORK ON BOILER <small>delete as appropriate</small> | | | | | Date: | |
| Engineer name: | | Company name: | | | | |
| Telephone N°: | | Gas Safe registration N°: | | | | |
| Max rate | CO | ppm | CO ₂ | % | CO/CO ₂ | |
| Min rate | CO | ppm | CO ₂ | % | CO/CO ₂ | |
| Where possible, has a flue integrity check been undertaken in accordance with manufacturers' instructions, and readings are correct?" | | | | | yes | |
| Gas rate: | m ³ /h | OR | ft ³ /h | | | |
| Were parts fitted? <small>delete as appropriate</small> | | Yes | No | | | |
| Parts fitted: | | | | | | |
| System inhibitor concentration has been checked and appropriate action taken, in accordance with BS 7593 and boiler manufacturers' instructions. * | | | | | yes | n/a |
| Comments: | | | | | | |
| Signature: | | | | | | |

*A System inhibitor efficacy test is required on every annual service in accordance with the manufacturers' instructions and BS 7593. It is only acceptable to not have undertaken this if the service engineers attendance visit was in between annual services to attend a non-water facing component.

| | | | | | | |
|--|-------------------|---------------------------|--------------------|---|--------------------|-----|
| SERVICE/INTERIM WORK ON BOILER <small>delete as appropriate</small> | | | | | Date: | |
| Engineer name: | | Company name: | | | | |
| Telephone N°: | | Gas Safe registration N°: | | | | |
| Max rate | CO | ppm | CO ₂ | % | CO/CO ₂ | |
| Min rate | CO | ppm | CO ₂ | % | CO/CO ₂ | |
| Where possible, has a flue integrity check been undertaken in accordance with manufacturers' instructions, and readings are correct?" | | | | | yes | |
| Gas rate: | m ³ /h | OR | ft ³ /h | | | |
| Were parts fitted? <small>delete as appropriate</small> | | Yes | No | | | |
| Parts fitted: | | | | | | |
| System inhibitor concentration has been checked and appropriate action taken, in accordance with BS 7593 and boiler manufacturers' instructions. * | | | | | yes | n/a |
| Comments: | | | | | | |
| Signature: | | | | | | |

*A System inhibitor efficacy test is required on every annual service in accordance with the manufacturers' instructions and BS 7593. It is only acceptable to not have undertaken this if the service engineers attendance visit was in between annual services to attend a non-water facing component.

| | | | | | | |
|--|-------------------|---------------------------|--------------------|---|--------------------|-----|
| SERVICE/INTERIM WORK ON BOILER <small>delete as appropriate</small> | | | | | Date: | |
| Engineer name: | | Company name: | | | | |
| Telephone N°: | | Gas Safe registration N°: | | | | |
| Max rate | CO | ppm | CO ₂ | % | CO/CO ₂ | |
| Min rate | CO | ppm | CO ₂ | % | CO/CO ₂ | |
| Where possible, has a flue integrity check been undertaken in accordance with manufacturers' instructions, and readings are correct?" | | | | | yes | |
| Gas rate: | m ³ /h | OR | ft ³ /h | | | |
| Were parts fitted? <small>delete as appropriate</small> | | Yes | No | | | |
| Parts fitted: | | | | | | |
| System inhibitor concentration has been checked and appropriate action taken, in accordance with BS 7593 and boiler manufacturers' instructions. * | | | | | yes | n/a |
| Comments: | | | | | | |
| Signature: | | | | | | |

*A System inhibitor efficacy test is required on every annual service in accordance with the manufacturers' instructions and BS 7593. It is only acceptable to not have undertaken this if the service engineers attendance visit was in between annual services to attend a non-water facing component.

| | | | | | | |
|--|-------------------|---------------------------|--------------------|---|--------------------|-----|
| SERVICE/INTERIM WORK ON BOILER <small>delete as appropriate</small> | | | | | Date: | |
| Engineer name: | | Company name: | | | | |
| Telephone N°: | | Gas Safe registration N°: | | | | |
| Max rate | CO | ppm | CO ₂ | % | CO/CO ₂ | |
| Min rate | CO | ppm | CO ₂ | % | CO/CO ₂ | |
| Where possible, has a flue integrity check been undertaken in accordance with manufacturers' instructions, and readings are correct?" | | | | | yes | |
| Gas rate: | m ³ /h | OR | ft ³ /h | | | |
| Were parts fitted? <small>delete as appropriate</small> | | Yes | No | | | |
| Parts fitted: | | | | | | |
| System inhibitor concentration has been checked and appropriate action taken, in accordance with BS 7593 and boiler manufacturers' instructions. * | | | | | yes | n/a |
| Comments: | | | | | | |
| Signature: | | | | | | |

*A System inhibitor efficacy test is required on every annual service in accordance with the manufacturers' instructions and BS 7593. It is only acceptable to not have undertaken this if the service engineers attendance visit was in between annual services to attend a non-water facing component.

| | | | | | | |
|--|-------------------|---------------------------|--------------------|---|--------------------|-----|
| SERVICE/INTERIM WORK ON BOILER <small>delete as appropriate</small> | | | | | Date: | |
| Engineer name: | | Company name: | | | | |
| Telephone N°: | | Gas Safe registration N°: | | | | |
| Max rate | CO | ppm | CO ₂ | % | CO/CO ₂ | |
| Min rate | CO | ppm | CO ₂ | % | CO/CO ₂ | |
| Where possible, has a flue integrity check been undertaken in accordance with manufacturers' instructions, and readings are correct?" | | | | | yes | |
| Gas rate: | m ³ /h | OR | ft ³ /h | | | |
| Were parts fitted? <small>delete as appropriate</small> | | Yes | No | | | |
| Parts fitted: | | | | | | |
| System inhibitor concentration has been checked and appropriate action taken, in accordance with BS 7593 and boiler manufacturers' instructions. * | | | | | yes | n/a |
| Comments: | | | | | | |
| Signature: | | | | | | |

*A System inhibitor efficacy test is required on every annual service in accordance with the manufacturers' instructions and BS 7593. It is only acceptable to not have undertaken this if the service engineers attendance visit was in between annual services to attend a non-water facing component.

| | | | | | | |
|--|-------------------|---------------------------|--------------------|---|--------------------|-----|
| SERVICE/INTERIM WORK ON BOILER <small>delete as appropriate</small> | | | | | Date: | |
| Engineer name: | | Company name: | | | | |
| Telephone N°: | | Gas Safe registration N°: | | | | |
| Max rate | CO | ppm | CO ₂ | % | CO/CO ₂ | |
| Min rate | CO | ppm | CO ₂ | % | CO/CO ₂ | |
| Where possible, has a flue integrity check been undertaken in accordance with manufacturers' instructions, and readings are correct?" | | | | | yes | |
| Gas rate: | m ³ /h | OR | ft ³ /h | | | |
| Were parts fitted? <small>delete as appropriate</small> | | Yes | No | | | |
| Parts fitted: | | | | | | |
| System inhibitor concentration has been checked and appropriate action taken, in accordance with BS 7593 and boiler manufacturers' instructions. * | | | | | yes | n/a |
| Comments: | | | | | | |
| Signature: | | | | | | |

*A System inhibitor efficacy test is required on every annual service in accordance with the manufacturers' instructions and BS 7593. It is only acceptable to not have undertaken this if the service engineers attendance visit was in between annual services to attend a non-water facing component.

* All installations in England and Wales must be notified to Local Authority Building Control (LABC) either directly or through a Competent Persons Scheme. A Building Regulations Compliance Certificate will then be issued to the customer.

© Heating and Hotwater Industry Council (HHIC)



www.centralheating.co.uk

Vokèra Warranty Terms and Conditions

Vokèra Ltd offer customers the comfort of a parts and labour warranty repair service subject to the following terms and conditions.

Vokèra Ltd only obligation under the guarantee shall be to repair or replace the faulty appliance at Vokèra Ltd discretion. This will be carried out where a fault arises from defects within the appliance, caused by either material or workmanship of the manufacturer.

1. The boiler must have been installed and commissioned within 12 months of manufacture by a registered Gas Safe (RGII ROI) installer in accordance with the guidelines in the installation and servicing booklet provided with the boiler.
2. This guarantee does not protect malfunction or damage arising from incorrect installation, commissioning or maintenance procedures, as laid out in the installation handbook, inefficient flue system, poor or incorrect electricity, wrong gas supply or pressure, tampering by inexperienced persons and any other cause not directly due to manufacture.
3. Vokèra Ltd cannot accept responsibility for any costs arising from repair or maintenance carried out by any third party.
4. The "Benchmark" commissioning sheet must be completed by the installer and left with the boiler for reference purpose.
5. The warranty will commence from the date of installation. Without proof of purchase ie an invoice or completed "Benchmark" commissioning sheet, the warranty will commence from the date of manufacture as detailed on the appliance data plate.
6. **To qualify for the full term of warranty, the boiler must be serviced once annually by a Gas Safe Registered Engineer (RGII ROI). Proof of annual service in accordance with the manufacturer's instructions must be provided (e.g. Benchmark Service Record). If this condition is not met the period of warranty will extend to only 12 months from date of installation.**

By registering your appliance, you will be helping us provide you with the best after sales service in the unlikely event that your boiler requires attention during the guarantee period.

Register online: www.vokera.co.uk (UK) or www.vokera.ie (ROI)

If the boiler suffers a mechanical or an electrical breakdown or you require an annual service, please contact our Customer Care Centre on:

UK: 01274 866100

ROI: 056 7755057

Our normal working hours, excluding Bank holidays are:

8.15am - 5.00pm Monday to Friday

8.00am - 12.00pm Saturday (UK only)

We will arrange for an engineer or appointed agent, to inspect and repair, or where in our sole opinion repair is not economic, arrange to replace the boiler.

7. Health & Safety:

- a. Engineers will only attend to boiler products where it is considered by the engineer that the installation does not pose a risk to health and safety.
- b. A permanently fixed access ladder must service installations in lofts or attics. Adequate lighting and permanently fixed flooring must also be available.
- c. Cupboard installations must provide minimum working clearances as detailed in the installation instructions. Vokèra will not accept responsibility for the removal of cupboards, kitchen units or trims in order to gain access for repairs.

8. Warranty does not apply:

- a. If the boiler is removed from its place of installation without our prior consent.
- b. To any defect, damage or breakdown caused by inadequate servicing of the boiler or by deliberate action, accident, misuse or third party interference including modification or an attempted repair which does not fully comply with industry standards.
- c. To any defect, damage or breakdown caused by the design, installation and maintenance of the central heating system.

- d. To de-scaling or other work required as a result of hard water scale deposits or from damage caused by aggressive water or sludge resulting from corrosion. Indications that such work may be required include a noisy boiler, cold spots on radiators, sludge in pipes and poor circulation of the central heating system.
- e. If the claim/contact procedure set out in section 6 is not adhered to.
- f. To any other costs or expenses caused by or arising as a result of the breakdown of a Vokèra Boiler.
- g. To any costs incurred during delays in fixing reported faults.

9. We reserve the right to a charge a callout fee where:

- a. There is no completed "Benchmark" commissioning sheet or equivalent control document present.
 - b. There is incomplete or no service record(s) for each and every year the boiler has been installed.
 - c. A fault cannot be found.
 - d. The breakdown or fault has been caused by an event, which is excluded from the warranty – see section 8.
 - e. Failure to cancel an agreed appointment prior to our engineers visit.
 - f. The boiler is outside the period of warranty or the conditions of the warranty have not been met.
10. If we fit replacement parts or replace a boiler it will not extend the period of the warranty. All replaced parts or boilers will become the property of Vokèra Ltd.
11. The warranty applies only where a Vokèra boiler has been installed in a domestic dwelling in the United Kingdom, Northern Ireland or Republic of Ireland, to provide heat and/or hot water to the central heating system.
12. Vokèra Ltd warranty is offered in addition to the rights provided to a consumer by law. Details of these rights can be obtained from a Trading Standards Authority or a Citizen Advice Bureaux.

Your Personal Details

Vokèra takes care of your personal details in order to protect your privacy. Below we detail how we use any data you provide us with and how we manage that data to protect it.

Personal data is collected by us confidentially and in accordance with data protection law regulations. Vokèra is registered as a data controller with the Information Commissioner's Office.

Your personal data is only stored if you volunteer to provide it, for example, to request information, submit a service visit, or to register a product for purposes of warranties and surveys etc. Vokèra will only use your personal data to satisfy the request you have made, and will not disclose information to third parties without your prior consent.

Any personal data stored by Vokèra is protected to ensure unauthorised persons cannot access or disclose the data. Vokèra uses security measures to protect the data we collect, in order to prevent manipulation, loss and destruction. No user information provided is stored anywhere on the internet that can be accessed by the public.

Vokèra may like to inform you of products and services that you could be interested in, and request your opinion of our services. Participation is voluntary and you can request not to receive such communications at any time or request your details to be updated by emailing: marketing@vokera.co.uk.

Contact Us:- Customer Care Centre

Tel: 01274 866100 (UK), 056 7755057 (ROI)

UK:

Vokèra Ltd, Customer Care, Stubs Beck Lane, West 26 Business Park, Whitehall Road, Cleckheaton, BD19 4TT

ROI:

Vokèra Ltd, Customer Care, West Court, Callen, Co Kilkenny, Ireland , R95 PW40

Email: service@vokera.co.uk (UK), eire-service@vokera.co.uk (ROI)

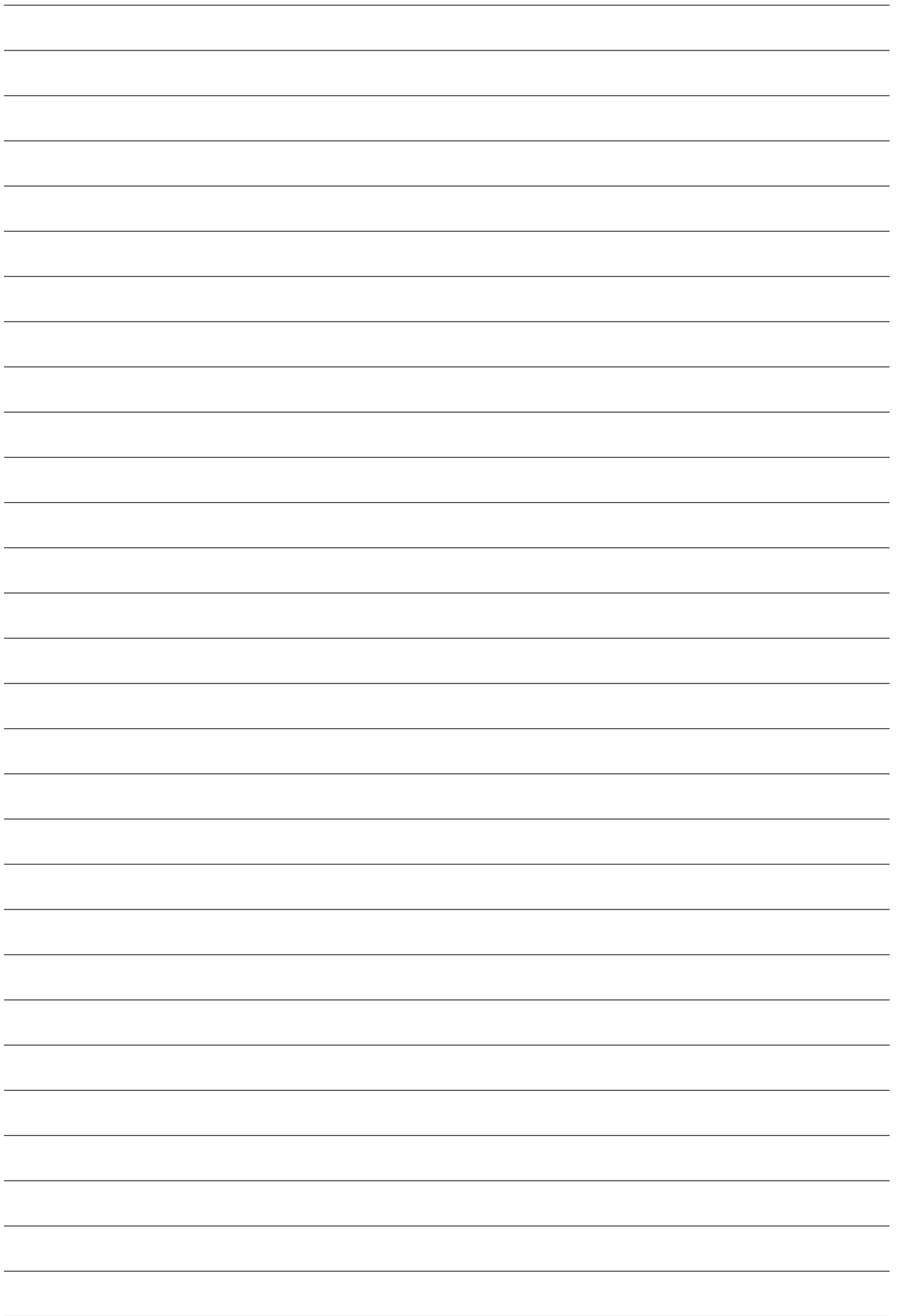



RANGE RATED - EN 15502

The max CH input of this boiler has been adjusted to _____ kW,
equivalent to _____ rpm max CH fan speed.

Date ___ / ___ / ___

Signature _____

Boiler serial number

Registered address:
Vokèra Ltd
Borderlake House
Unit 7 Riverside Industrial Estate
London Colney
Herts AL2 1HG

www.vokera.co.uk
www.vokera.ie

Sales, General Enquires

T 0844 391 0999
F 0844 391 0998

Vokèra Ireland
West Court, Callan
Co Kilkenny
T 056 7755057
F 056 7755060

Vokèra Limited reserve the right to change
specification without prior notice
Consumers statutory rights are not affected.

Company Reg No: 1047779