

UNICA MAX

High efficiency system boiler

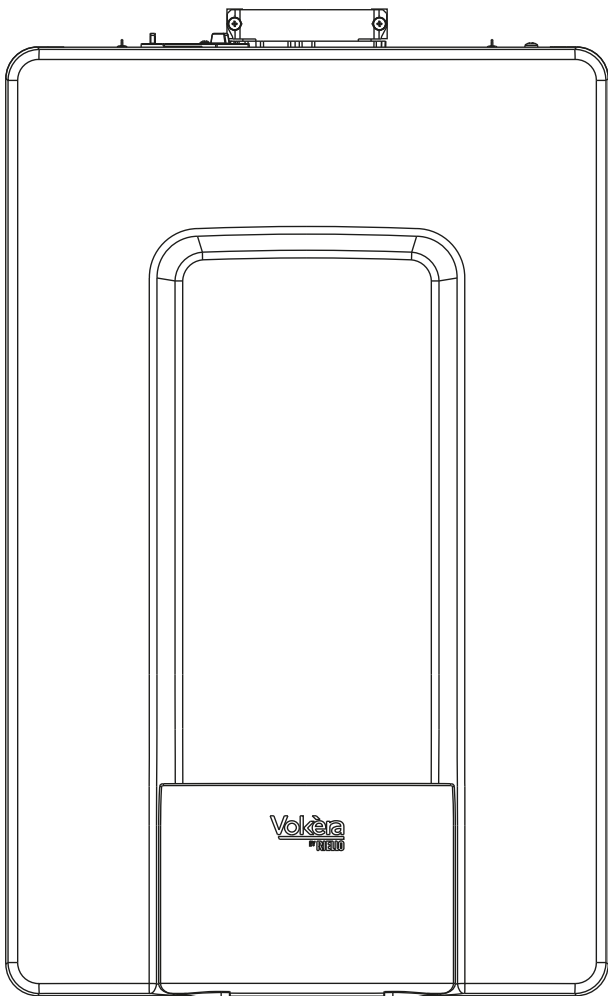

Users Instructions

Installation & Servicing Instructions



UNICA MAX 20S NG G.C. N° 41-364-13
UNICA MAX 30S NG G.C. N° 41-364-14
UNICA MAX 20S LPG G.C. N° 41-364-15
UNICA MAX 30S LPG G.C. N° 41-364-16

THESE INSTRUCTIONS
TO BE RETAINED
BY USER



Vokèra is a licensed member of the Benchmark scheme which aims to improve the standards of installation and commissioning of domestic hot water systems in the UK.

1. THINGS YOU SHOULD KNOW.....	2	SECTION 5 - INSTALLATION	27
2. GETTING STARTED.....	5	SECTION 6 - COMMISSIONING	32
3. HOW TO.....	10	SECTION 7 - SERVICING INSTRUCTIONS.....	42
4. WHAT IF.....	10	SECTION 8 - CHECKS, ADJUSTMENTS AND FAULT FINDING	43
SECTION 1 - DESIGN PRINCIPLES AND OPERATING SEQUENCE	12	SECTION 9 - LPG INSTRUCTIONS.....	48
SECTION 2 - TECHNICAL DATA	13	Commissioning checklist	49
SECTION 3 - CONTROL PANEL (REC10).....	17	Benchmark	50-53
SECTION 4 - GENERAL REQUIREMENTS (UK)	24	Vokèra Warranty Terms and conditions	54-55
SECTION 4A - GENERAL REQUIREMENTS (EIRE).....	25		

USERS INSTRUCTIONS

INTRODUCTION

Dear Customer

Your Vokèra **UNICA MAX** boiler has been designed to meet and exceed the very latest standards in gas central heating technology, and if cared for, will give years of reliable use and efficiency. Please therefore take some time to read these instructions carefully.

Do's and Don't's

- **Do** ensure that the system pressure is periodically checked
- **Do** ensure that the boiler is not used by children or unassisted disabled people
- **Do** ensure that you know how to isolate the appliance in an emergency
- **Do** ensure that you are familiar with the appliance controls
- **Do** ensure that your installer has completed the appliance log book section
- **Do not** attempt to remove the appliance casing or gain internal access
- **Do not** hang clothes etc. over the appliance
- **Do not** forget to have the appliance serviced annually.

This booklet is an integral part of the appliance. It is therefore necessary to ensure that the booklet is handed to the person responsible for the property in which the appliance is located/installed. A replacement copy can be obtained from Vokèra customer services.



At the end of its life, the product should not be disposed of as solid urban waste, but rather it should be handed over to a differentiated waste collection and/or recycling centre.

1. THINGS YOU SHOULD KNOW

1.1 GAS APPLIANCES

Gas Safety (Installation and Use) Regulation (UK).

In the interests of your safety and that of others it is a legal requirement that all gas appliances are installed and correctly maintained by a competent person and in accordance with the latest regulations.

1.2 ELECTRICAL SUPPLY

Please ensure that this appliance has been properly connected to the electrical supply by means of a double pole isolator or un-switched socket, and that the correct size of fuse (3 AMP) has been fitted.

Warning: this appliance must be earthed!

1.3 WARRANTY REGISTRATION

Please take the time to register the appliance warranty using the documentation provided, call 0800 479 0754 (UK) or 056 7755055 to obtain your warranty confirmation code (please have your appliance warranty card to hand).

1.4 APPLIANCE COMMISSIONING CHECKLIST (UK only)

The Benchmark checklist section can be found at the rear of the appliance installation booklet. This important document must be completed during the installation/commissioning of your boiler. All GAS SAFE registered installers carry a GAS SAFE ID card, and have a registration number. These details should be recorded in the Benchmark commissioning checklist section within the installation booklet. You can check your installers details by calling GAS SAFE direct on 08004085500. Failure to install and commission the appliance in accordance with the manufacturers instructions will invalidate the warranty. This does not affect your statutory rights.

1.5 HOW DOES IT WORK?

Your **UNICA MAX** boiler supplies heated water to your radiators and hot water cylinder. The appliance is controlled via a timer or programmer and any thermostats that your installer may have fitted. The boiler will light when it receives a request from the timer, programmer, or thermostat that your installer has fitted. Your **UNICA MAX** boiler lights electronically and does not have a pilot light.

In the unlikely event of a fault developing with your boiler, the supply of gas to the burner will be terminated automatically.

1.6 DIMENSIONS

	HEIGHT	WIDTH	DEPTH
20S	740 mm	420 mm	275 mm
30S	740 mm	470 mm	350 mm

1.7 CLEARANCES REQUIRED

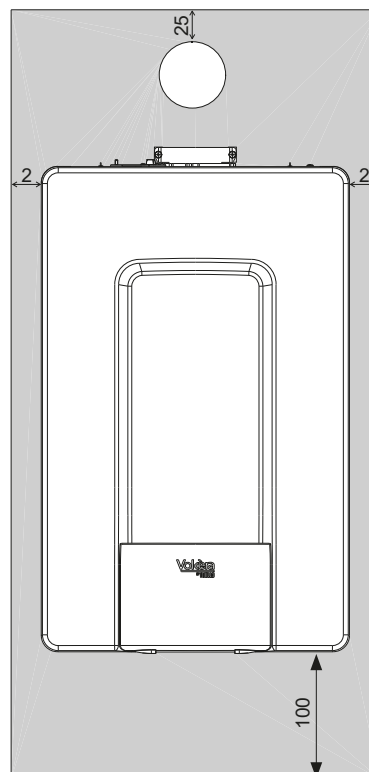

ABOVE	25mm*
BELOW	100mm [^]
LEFT SIDE	2mm
RIGHT SIDE	2mm**
FRONT	4mm***

* 25mm above flue bend if top flue outlet is used. Consideration should be given to providing reasonable clearance for the insertion of a FGA probe.

** Disconnection of adjacent components may be required in order to facilitate syphon removal.

*** Provided that a door or removal panel enables 450mm access for maintenance.

[^] Can be reduced to 5mm if a removal panel enables 100mm for maintenance.

1.8 FROST PROTECTION SYSTEM

The **UNICA MAX** is equipped with a built-in frost protection system, this enables the boiler to over-ride the time controls – even if switched off – and operate the burner and/or pump, should the temperature within the appliance drop below 5 °C. Please note that the frost protection system is designed to protect the appliance only, should frost protection be required for the heating system, additional controls may be required.

NOTE: the frost protection system is reliant on the appliance having a permanent electrical supply, and being in a non-fault condition.

1.9 APPLIANCE STATUS INDICATORS

Your appliance incorporates the REC10H UI (User Interface), that displays information on appliance status and condition.

1.10 CONTROL PANEL (REC10H)

Depending on the type of application, some of the functions described in this manual might not be available.

The REC10H UI is a multi-functional control that enables you to view the operating status of your appliance at a glance; and is also used to adjust/set the various ‘User’ settings, including temperature set-points and it also allows the management of functions related to the solar system and the heat pump (if present). The REC10H UI also incorporates an embedded timer that - if enabled - can be used to program and control the ON/OFF times for your central heating. Please consult your installer for further advice on this function.

The REC10H UI features a backlit liquid crystal display.

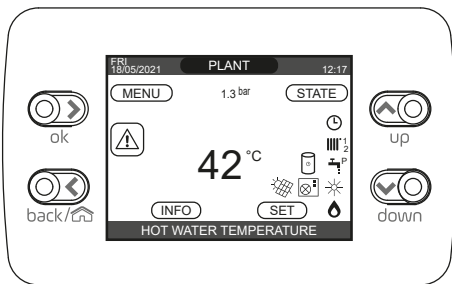

fig. 1

REC10H		Boiler control panel
Key area		Confirm ok
		back= return to the previous screen cancel selection home return to the main screen (press > 2 sec.)
		- From the main screen they allow you to choose between the options: MENU, INFO, SET, STATE, PLANT.
		- From the sub-menus they allow you to navigate through the different options

System Icons may appear on both the left and right of the display; and they signify the following condition/status:

	This icon indicates that the OFF operating status mode has been set. Each ignition request is ignored except for the frost-protection function. The pump anti-lock and frost-protection function remain active.
	This icon indicates that WINTER mode has been selected (HEATING function enabled). If a heating request from the main zone is in progress, the icon will be flashing. If there is a CH request from the additional zone, the number 1 or 2 is flashing.
	Only if heat pump is present. This icon indicates that cooling is active in the SUMMER state. If a cooling request from the main zone is in progress, the icon is flashing. If a cooling request from the additional zone is in progress, number 1 is flashing.
	This icon indicates that the circuit for domestic hot water production is enabled. When a domestic hot water request is in progress, the icon flashes (default value - parameter: "water tank type = 0"). If we are outside the time slots for enabling the sanitary, the icon is crossed out
	When the "central heating programming timing" is enabled this icon indicates that the system heating (main zone) is in AUTOMATIC mode (the management of the heating requests follows what has been set with the timer). If the heating function is not enabled during the current time frame, the icon will be crossed out.
	When the "central heating programming timing" is enabled this icon indicates that the system heating (main zone) is in MANUAL mode (the management of the heating requests does not follow what has been set with the programming timing, but it is always active).
OFF	This icon indicates that the main zone, when the "central heating programming timing" function is not enabled, has been set to off (not active).
	Only if heat pump is present. This icon indicates that the management of a heat pump is enabled. When the heat pump is running, then the icon is flashing.
	Only if solar system is present. This icon indicates that the management of a solar system is enabled. When the solar system circulator is running, then the icon is flashing.
	This icon indicates that the system is detecting the presence of a flame.
	This icon indicates the presence of an anomaly or fault condition, and is always flashing.
	Only with combined boiler and presence of boiler + heat pump enabled for domestic hot water. The icon appears crossed out with an "X" when the system works outside the activation times of the heat pump in the domestic hot water, while it flashes when the heat pump is in operation to load the boiler.
	Only if photovoltaic enabled. When the icon is flashing, it means that the electrical productivity of the photovoltaic system is adequate (closed contact). The system exploits the available energy.

Note:

The temperature of the heating outlet sensor is shown at the centre of the main screen. The value's meaning is indicated at the bottom of the display.

Whenever a heating request is in progress, the value displayed at the centre of the screen refers to the system's flow sensor, with the relative indication.

The value expressed in bar refers to the system's water pressure.

The top of the screen shows the current date and time, as well as the outdoor temperature, if available.

1.11 USER FUNCTIONS

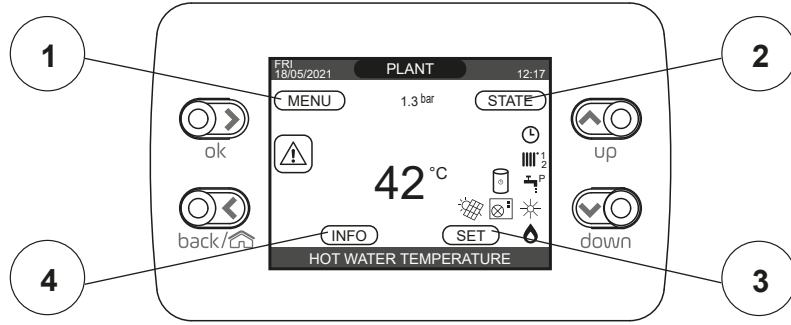

1 MENU

MENU

- SETTINGS
 - TIME & DATE
 - DAYLIGHT SAVINGS TIME
 - LANGUAGE
 - BACKLIGHT
- TIME SCHEDULE
 - MAIN
 - ZONE 1
 - ZONE 2
 - DHW
 - HP DHW

DEFAULT VALUE	FACTORY SET	MINIMUM VALUE	MAXIMUM VALUE	ACCESS LEVEL	NOTES
					USER
					USER
	FUNCTION ACTIVE	FUNCTION NOT ACTIVE	FUNCTION ACTIVE		USER
			ITALIANO / ENGLISH / ...		USER
	5 min	1 min	15 min		USER
					USER
					USER: only if POR = 1
					USER: only if POR = 1 and zone added
					USER: only if POR = 1 and zone added
					USER: only with water tank
					USER: only if HP present and enable for DHW

2 STATE

STATE

- BOILER
- DHW
 - ANTILEGIO CUT OFF
- MAIN ZONE
- HEAT PUMP
 - ENABLE/DISABLE NIGHT REDUCT
 - NIGHT MODE START TIME
 - NIGHT MODE STOP TIME

DEFAULT VALUE	FACTORY SET	MINIMUM VALUE	MAXIMUM VALUE	ACCESS LEVEL	NOTES
	OFF		OFF/SUMMER/WINTER		USER
	AUTO		AUTO/MANUAL		USER
					USER with boiler in OFF and ANTILEGIO active
	AUTO		ON/OFF (if POR=0)		USER
	ON		ON/OFF (if POR=1)		USER
	FUNCTION NOT ACTIVE	FUNCTION ACTIVE	FUNCTION NOT ACTIVE		USER
	20:00	00:00	23:59		USER only if NIGHT REDUCTION active
	20:00	00:00	23:59		USER only if NIGHT REDUCTION active

3 SET

SET

- HEATING
- DHW
- COOLING

DEFAULT VALUE	FACTORY SET	MINIMUM VALUE	MAXIMUM VALUE	ACCESS LEVEL	NOTES
	18 °C	4 °C	20 °C		if you work at a fixed point USER
	0	-5	-6		if you work with climatic curves only if HP enable for cooling

4 INFO See specific paragraph

2. GETTING STARTED

2.1 BEFORE SWITCHING ON

- Before switching the appliance on, please familiarise yourself with:
- how to isolate the appliance from the gas, water, and electricity supplies;
 - how to check and top-up – if necessary – the system water pressure;
 - any external thermostats and their functions;
 - the appliance controls.

2.2 APPLIANCE CONTROLS (see fig. 1)

The appliance controls are concealed behind the front flap of the appliance.

NOTE

The appliance frost protection is active in all the boiler modes. The **control panel functions** can be used to vary the temperature of the water that circulates around your heating system and hot water cylinder.

The heating temperature range can be adjusted between 20C - 40C (low temperature) or 40C - 80C (high temperature) this range is configured by your installer and the default is the high temperature range.

Refer to the main appliance status table for fault indicator and boiler status.

2.3 LIGHTING THE BOILER

Ensure the gas and electrical supply to the boiler are turned on.

After completing all operations required to prepare commissioning, proceed as follows to start the boiler.

2.4 START SCREEN

When the appliance is first connected to the electrical supply, the REC 10 may require you to set the time and date (see 2.9.1), and the appliance will enter its 'pre-purge' mode that will last for several minutes. On completion of the 'pre-purge' phase, the appliance will enter its 'standby' mode unless a heating or HW request has been made.

By pressing the "up" and "down" keys it is possible to move the selection of the functions in this order:

- PLANT - STATE - SET - INFO - MENU.

By pressing the "ok" key you can access the settings of the selected function (except for PLANT).

The "back" key is inactive (except for PLANT).

The highlighted status is that which is currently selected.

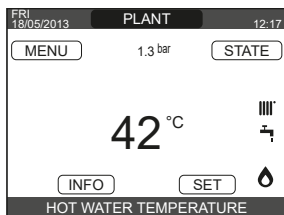

2.5 PLANT

The PLANT menu only becomes available if additional zones have been added and configured with this system via the REC10 H.

In order to change zones (see above), highlight PLANT by additionally pressing the "up" and "down" keys.

Then, pressing the "ok" and "back" keys, it will be possible to select the other zones in this sequence (only if added and configured with the REC10 H):

- PLANT - MAIN ZONE - ZONE 1 - ZONE 2.

The TIME AND DATE, DAYLIGHT SAVINGS TIME, LANGUAGE and BACKLIGHT settings are related to the appliance only.

The information contained in the INFO menu is related to the appliance.

No domestic hot water parameters can be set if MAIN, ZONE 1 or ZONE 2 is selected.

2.6 STATE

This function can be used to set these operating modes. Select **STATE** → **BOILER** or **DHW** (in WATER TANK configuration) or **MAIN ZONE** or **HEAT PUMP** (if present).

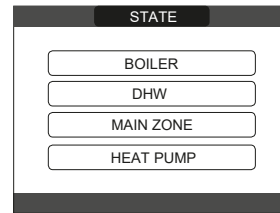

Note: MAIN ZONE is visible in this menu only if the zone is managed by a room thermostat.

HEAT PUMP is only visible if a heat pump is connected to the system.

BOILER

This function can be selected in order to set the boiler's status: Select **STATE** → **BOILER** → **OFF** or **HOT WATER ONLY** (SUMMER - only if water tank connected) or **HEATING AND HOT WATER** (WINTER).

Once the selection has been validated, the display returns to the STATE screen.

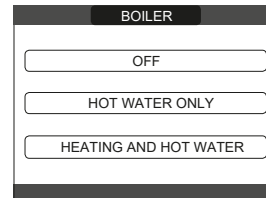

OFF: if **OFF** is selected, the system enters the standby mode, whereby only the standby functions remain active.

SUMMER (only if water tank connected): if **HOT WATER ONLY** is selected, the system produces domestic hot water. Heating is disabled.

WINTER: if **HEATING AND HOT WATER** is selected, the system produces domestic hot water and activates the heating function.

DHW (ONLY IF WATER TANK CONNECTED)

By selecting this function it is possible to set the DHW status by selecting one of the following options: AUTO or MANUAL. The highlighted state is the one currently selected. To select a different status, highlight it using the "up" and "DOWN" keys and then press the "OK" key to validate the selection. Once the selection is validated, the display returns to the STATUS screen. Press BACK to return to the home screen without making any selection.

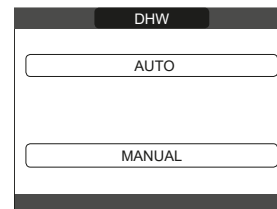

Antilegio CUT OFF (only with water tank): this function can be interrupted in advance in two different ways:

- set the boiler to OFF 
- or
- select **STATE** → **DHW** → **ANTILEGIO CUTOFF**.

If the function is interrupted, it will be repeated at the same time the next day, even if weekly programming is active.

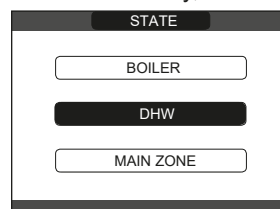

MAIN ZONE

Select **STATE** → **MAIN ZONE** to set the main zone's status, by choosing one of the following options:

- if the embedded time clock is disabled (default):
 - ZONE ON: boiler responds to heating request
 - ZONE OFF: boiler does not respond to any request for heating
- if the embedded time clock has been enabled:
 - AUTO/MANUAL/HEAT OFF.

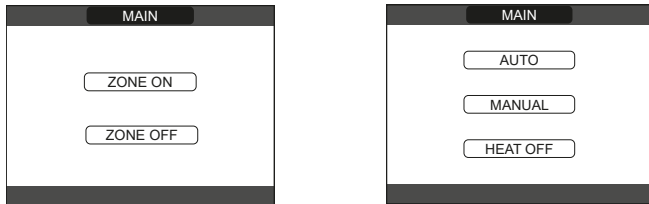

Once the selection has been validated, the display returns to the **STATE** screen.

ZONE ON: if **ZONE ON** is selected, the zone heating requests are met.

AUTO: if **AUTO** is selected, the zone heating requests will be managed based on the scheduled programme.

MANUAL: if **MANUAL** is selected, the zone requests will be managed based on the selection set by the user.

HEAT OFF: If **HEAT OFF** is selected, the zone heating requests will be ignored.

NOTE: to deactivate the zone in **SUMMER** or in **WINTER**, you must select the required season (**SUMMER** or **WINTER** in the **BOILER** menu) and set the zone concerned to **OFF**.

HEAT PUMP (if present)

By selecting **HEAT PUMP** it is possible to enable the **NIGHT REDUCTION**. This parameter is used to reduce the noise of the heat pump by limiting the maximum operating frequency of the compressor in the time band set by the parameters **NIGHT MODE START TIME** and **NIGHT MODE STOP TIME**. **NIGHT MODE START TIME** (if **NIGHT REDUCTION** is active) This parameter is used to set the start time of the heat pump compressor frequency limitation band when the night reduction function is enabled. Range 00:00 - 23:30/Default 22:00. **NIGHT MODE STOP TIME** (if **NIGHT REDUCTION** is active) This parameter is used to set the end time of the heat pump compressor frequency limitation band when the night reduction function is enabled. Range 00:00 - 23:30.

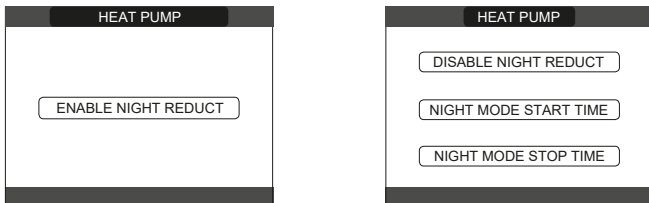

2.7 SET

With this function it is possible to configure the setpoints.

Select **SET** → **HEATING** or **DHW** or **COOLING** setpoints.

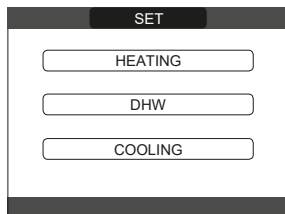

HEATING

The user can change the heating setpoint by pressing the "up" and "down" keys.

When an outdoor temperature sensor is installed, the outlet setpoint temperature is automatically adjusted by the system, in order to maintain the ambient temperature according to any variations in the outdoor temperature. If you want to adjust the outlet temperature, raising it or lowering it with respect to that automatically calculated by the boiler, it is possible to change the **HEATING** setpoint selecting the desired comfort level within the range (-5 ÷ +5).

The user is then asked to confirm the setpoint setting: select **CONFIRM** or **CANCEL** and confirm.

Once the selection is confirmed, the display returns to the **SET** screen. If the selection is cancelled or the "back" key is pressed you return to the previous **SET** screen.

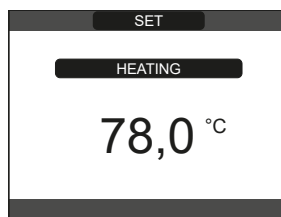

HOT WATER

With heating only boiler connected to a domestic hot water tank, the parameter refers to the temperature of the domestic water stored in the water tank.

Press the "up" and "down" keys to modify the domestic water set point delivered by the boiler and then confirm with **OK**.

The user is then asked to confirm the setpoint setting: select **CONFIRM** or **CANCEL** and confirm. Once the selection is confirmed, the display returns to the **SET** screen. If the selection is cancelled or the "BACK" key is pressed you return to the previous **SET** screen.

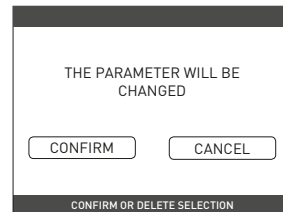
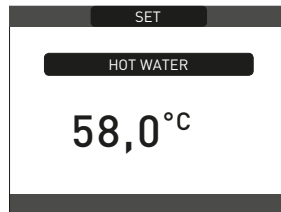

COOLING (AVAILABLE IF HEAT PUMP ENABLED FOR COOLING IS INSTALLED)

Press the "up" and "down" keys to change the cooling setpoint and then confirm. If the thermoregulation in cooling is activated, the flow temperature value is automatically chosen by the system, which rapidly adjusts the room temperature according to the variations in the external temperature. If you want to change the temperature value, increasing or decreasing it compared to that automatically calculated by the electronic board, you can change the **COOLING** setpoint by choosing the desired comfort level (-5 ÷ +5) within the range. Then you are asked to confirm the setpoint setting: select **ENTER** or **BACK** using "up" and "down", validate the choice by pressing **OK**. Confirming the selection returns the display to the previous **SET** screen. Cancelling the selection or pressing the **BACK** button returns the display to the **SET** screen.

NOTE: this parameter is available when in the system a heat pump enabled for room cooling is installed.

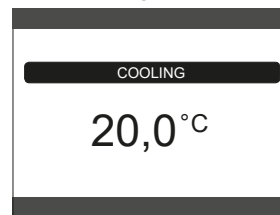

2.8 INFO

The **INFO** function can be used to display a series of data regarding the system.

ATTENTION - The displayed data is for information only and cannot be modified.

SCREED HEATER OPERATING HOURS	ZONE 2 SET-POINT
DELIVERY PROBE	SYSTEM PRESSURE
RETURN PROBE	HEAT PUMP DELIVERY
DOMESTIC HOT WATER PROBE	HEAT PUMP RETURN
HIGH STORAGE TANK PROBE	HEAT PUMP EXT. TEMP.
LOW STORAGE TANK PROBE	TREFR LOW PRESSURE PIPE
SOLAR COLLECTOR	TREFR HIGH PRESSURE PIPE
FLUE GAS PROBE	TREFR CONDENSER
OUTDOOR TEMPERATURE SENSOR	TREFR HEAT EXCHANGER
EXT T FOR THERMOREG	HEAT PUMP OPERATING MODE
FLOW METER / DHW SETPOINT OT+	HEAT PUMP FREQUENCY
FAN	HEAT PUMP COMPRESSOR TIME
DELIVERY ZONE 1	HEAT PUMP CIRCULATOR TIME
DELIVERY ZONE 2	HEAT PUMP FLOW SWITCH
FLUE GAS PROBE OPERATING HOURS	HEAT PUMP OUTPUT
MAIN ZONE SET-POINT	HEAT PUMP SET-POINT
ZONE 1 SET-POINT	NEXT ANTI-LEGIONELLA

The “ok” key is inactive. The “back” key allows you to return to the initial screen. In the absence of additional zones or if the screed heater function is not operating, the relative information will not be displayed.

NOTE: Some of the information might not be available on the REC10CH depending on the access level, the status of the machine or the system configuration.

2.9 MENU

Select **MENU** → **SETTINGS** or **TIME SCHEDULE** (available only if the timer is enabled (POR=1)).

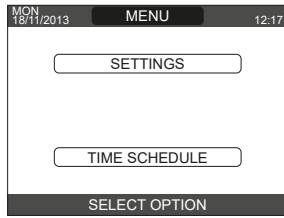

SETTINGS

Select **MENU** → **SETTINGS** → **TIME&DATE** (you can change HOURS, MINUTES, DAY, MONTH, YEAR) or **DAYLIGHT SAVINGS TIME** or **LANGUAGE** (to select the desired language) or **BACKLIGHT**.

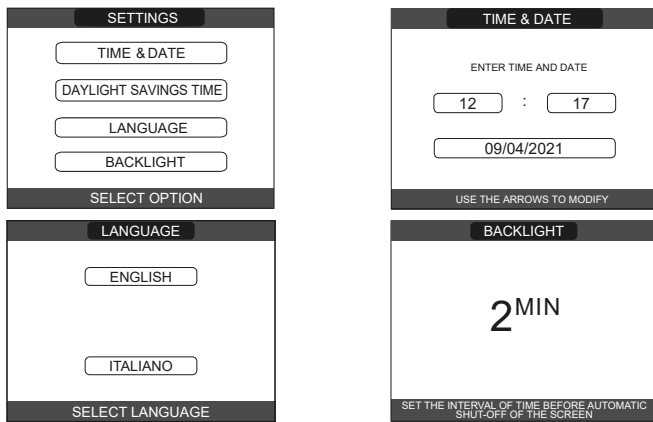

TIME AND DATE: press “ok” to highlight in sequence HOURS, MINUTES, DAY, MONTH, YEAR and press the “up” and “down” keys to change the desired values.

Once the sequence has finished by pressing “ok”, the settings will be saved and the display will return to the initial screen.

By pressing “back” at any time the system will return to the **SETTINGS** cancelling the changes that were made.

DAYLIGHT SAVINGS TIMES: by selecting FUNCTION ACTIVE the device automatically manages the change of time from solar to daylight savings time and vice versa.

LANGUAGE: press the “up” and “down” keys to select the desired language. Pressing “ok” the language selection is confirmed and the display returns to the initial screen.

Pressing “back” the system returns to the **SETTINGS** screen without changing the system’s language.

BACKLIGHT: the screen saver display (backlight off) is automatically activated when the time, that has been set in parameter → MENU → SETTINGS → BACKLIGHT, elapsed without having pressed any buttons.

In the screen saver the current time is normally displayed.

“⚡” symbol and the number of days to STOP appear if the AUTOSTOP function is active. When there is a heat request, the current time is replaced with the boiler flow temperature and turns on the icon concerning the type of request in progress. A system efficiency indicator is also displayed at the top of the screen:

- HIGH EFFICIENCY (if the average value of the return probe > 55°C)
- OPTIMUM EFFICIENCY (if average value of the return probe < 55°C).

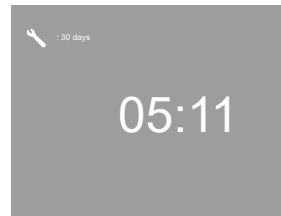

TIME SCHEDULE

Select **MENU** → **TIME SCHEDULE** (only if the time schedule is enabled → **MAIN** (if POR=1) or **ZONE 1** (if POR=1) or **ZONE 2** (if POR=1) or **HP DHW**).

NOTES

- the HP DHW parameter is available if the system is fitted with a heat pump that heats the domestic hot water in the storage tank
- for the HP DHW parameter, there are two time schedules: one for winter and the other for summer. select the required season (HOT WATER ONLY or HEATING AND HOT WATER) from the STATE/BOILER menu, then program the HP DHW parameter.

WARNING: in HOT WATER ONLY, the parameter is factory set to keep time schedule active every day of the week from 05:00 to 08:00, to prevent continuous heat pump cycle reversals if the cooling function is active. If you want to alter this setting, contact the professionally qualified personnel.

For a detailed description of the scheduled programming timer, please refer to the section “2.10 TIME SCHEDULE”.

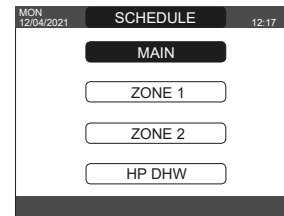

2.10 TIME SCHEDULE

Select the desired day using the “up” and “down” keys.

A table will be displayed indicating the day and the time settings that have been pre-programmed. Press “ok” to access the programming for the selected day.

Pressing “back” takes you back to the initial screen without making any selection.

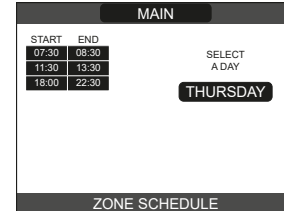

Once the selection has been made, the user can choose from among the following options: **ADD** (you can add up to four start & end periods) - **MODIFY** - **DELETE** - **COPY**.

ADD

This function serves to add a new time frame to the selected day (up to a maximum of 4).

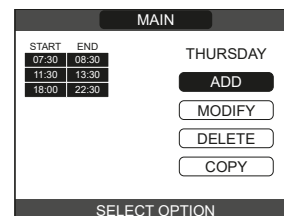

The user can increase or decrease by 30 minutes the **start** time and the **end** time.

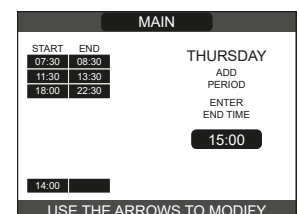
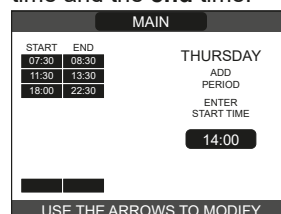

In order to confirm that the operation has been completed successfully, the display will show the table with the new time frame flashing.

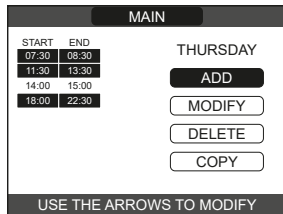

MODIFY

This function serves to edit a time frame already present for the selected day.

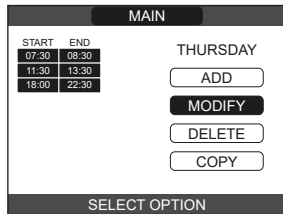

Select the desired time band.

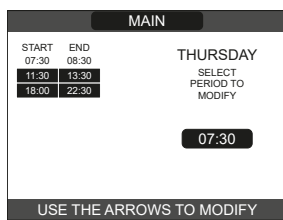

The user can increase or decrease by 30 minutes the **start** time and the **end** time.

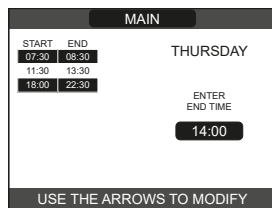
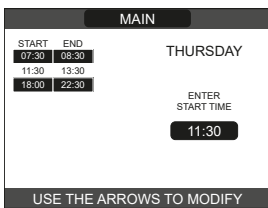

In order to confirm that the operation has been completed successfully, the display will show the table with the new time frame flashing.

At this point the user can select a new time frame to be modified, or else can press **“back”** to return to the previous **TIME SCHEDULE** screen.

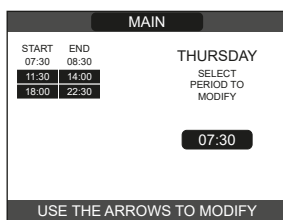

DELETE

This function serves to delete a time frame already present for the selected day.

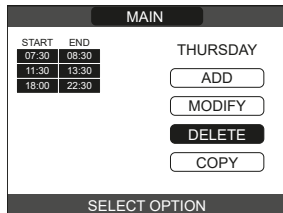

Select the desired time band.

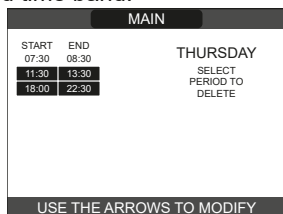

Confirm or cancel the selection made.

In order to confirm that the operation has been completed successfully, the display will show the table with the selected time frame flashing just before deleting it from the table.

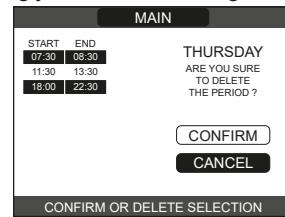

COPY

This function serves to copy the same scheduled programme for other days of the week.

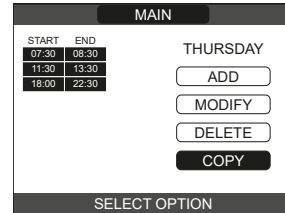

Select the day on which to copy the hourly schedule to.

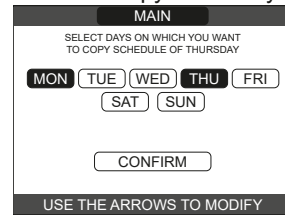

The day will be highlighted and others can be selected using the same procedure → CONFIRM.

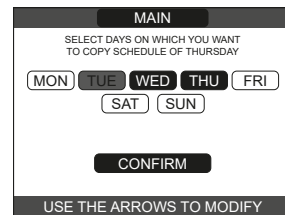

In order to confirm that the operation has been completed successfully, the display will show the list of days to which the scheduled programme has been copied.



2.11 FAULTS

Should a fault occur, a screen will appear on the display indicating the relative error code and a brief alphanumeric description of the fault. Pressing the **“back”** button it is possible to return to the main screen, where a fault is signalled by this flashing icon .

The user can return to the fault description screen by using the **“up”** and **“down”** keys and then pressing the **“ok”** key. The faults description screen is automatically displayed once the display illumination time has elapsed without any button being pressed.

Press the **“up”** and **“down”** keys to display the descriptions of any other faults that may be present.

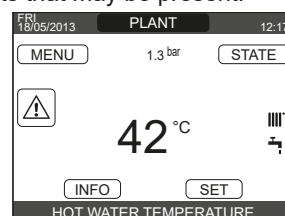

For fault E041

If the pressure drops below the safety threshold of 0.3 bar the boiler displays the fault code “E041 - WATER TRANSDUCER LOAD THE SYSTEM” for a transitional time of 30 sec during which it is possible to open the external filling tap until the pressure is between 1 and 1.5 bar.

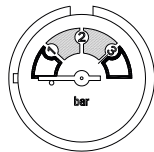
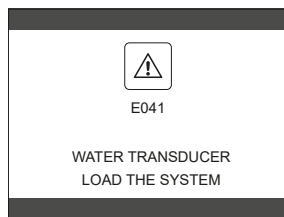

For fault E091

The boiler has an auto-diagnostic system which, based on the total number of hours in certain operating conditions, can signal the need to clean the primary heat exchanger. The intervention of the Technical Assistance Centre is necessary.

 If the pressure drops frequently, contact the Technical Assistance Centre.

Boiler faults list

ERROR CODE	ERROR MESSAGE	DESCRIPTION OF ALARM TYPE
E010	flame lockout/ACF electronic fault	final
E011	extraneous flame	temporary
E020	limit thermostat	final
E030	fan fault	final
E040	water transducer - check system water pressure	final
E041	water transducer - check system water pressure	temporary
E042	water transducer fault	final
E060	configuration fault	temporary
E070	fault flow sensor/overtemperature flow sensor/ flow/return sensor differential alarm	temporary/final/ final
E077	main zone water thermostat	temporary
E080	fault return line probe/return line probe overtemperature/ outlet/return line probe differential alarm	temporary/final/ final
E090	fault flue gases probe/ flue gases overtemperature probe	temporary final
E091	clean primary heat exchanger	temporary
E099	reset attempts exhausted, boiler blocked	definitive, not resettable
--	water pressure low - check the system	temporary
--	water pressure high - check the system	temporary
--	boiler board communication lost	temporary
--	BUS 485 communication lost	temporary

List of combustion faults

ERROR CODE	ERROR MESSAGE	DESCRIPTION OF TYPE OF ALARM
E021	iono alarm	These are temporary alarms that if they occur several times in an hour they become definitive; the alarm E097 is displayed and is followed by post-purging for 45 seconds at the fan's maximum speed. It is always possible to release the alarm before the end of the post-purging.
E022	iono alarm	
E023	iono alarm	
E024	iono alarm	
E067	iono alarm	
E088	iono alarm	
E097	iono alarm	
E085	combustion fault/high CO	These are temporary alarms that if they occur several times in an hour they become definitive; the last error to occur is displayed and is followed by a post-purging of 2 minutes at the fan's maximum speed. It is not possible to release the alarm before the end of the post-purging unless the boiler's power supply is switched off.
E094	combustion fault/high CO	
E095	combustion fault/high CO	
E058	mains voltage fault	These are temporary faults that restrict the ignition cycle.
E065	current modulation alarm	
E086	obstruction fumes alarm	Temporary fault reported during the post ventilation. It is maintained a post ventilation of 5 min at maximum fan speed.

3. HOW TO...

3.1 HOW TO TOP-UP THE SYSTEM PRESSURE

The system pressure must be checked periodically to ensure the correct operation of the boiler. The system pressure is shown at the top of the LCD display or can be read on the gauge located on the underside of the appliance. When the boiler is at room temperature, the system pressure should be approximately 1.0 bar.

If the pressure requires 'topping-up' use the following instructions as a guide.

- Locate the filling valve connections (usually beneath the boiler, see fig. 1).
- Attach the filling loop to both connections.
- Open the filling valve slowly until you hear water entering the system.
- Close the filling valve when the pressure gauge (on the boiler) reads between 1 and 1.5 BAR.
- Remove the filling loop from the connections.

3.2 HOW TO RESET THE APPLIANCE

Reset function

In order to reset the boiler's operation in the event of a fault, it is necessary to access the fault description screen. If the lockout is of a non-volatile type that requires a reset procedure, this will be indicated on the screen, and can be carried out by pressing the "ok" button on the REC10H.

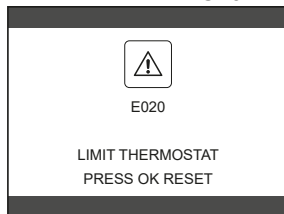

At this point, if the correct operating conditions have been restored, the boiler will restart automatically.

If the attempts to reset the fault do not restore the boiler's functionality, please contact your local Customer Support Service.

Up to a maximum of 3 reset attempts can be made using the REC10CH. In case of all the attempts are exhausted the definitive fault E099 occurs on the display. After these operations the machine must be disconnected from the power supply to reset the number of attempts available.

 If the attempts to reset the fault do not restore the boiler's functionality, please contact your local Customer Support Service.

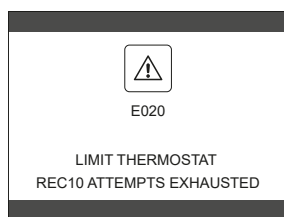

3.3 HOW TO SHUT DOWN THE SYSTEM FOR SHORT PERIODS

If necessary the boiler status can be switched to the OFF  position during short periods of absence.

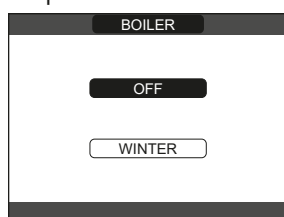

Provided that the electrical and gas supplies remain switched ON to the appliance, the following frost-protection functions will remain active in order to protect the appliance:

- **heating frost-protection:** this function is activated if the temperature measured by the flow sensor drops below 5°C. A heat request is generated in this phase with the ignition of the burner at minimum output, which is maintained until the outlet water temperature reaches 35° C;

- **DHW frost-protection:** the function starts if the temperature measured by the DHW sensor falls below 5°C. A heat request is generated in this phase with the ignition of the burner at minimum output, which is maintained until the outlet water temperature reaches 55° C.

 The activation of the FROST-PROTECTION function is indicated by a scrolling message at the base of the REC10H display.

- **pump anti-blocking:** the circulating pump is energised for a 30-second period if it remains inactive for more than 24-hours.

3.4 HOW TO SHUT DOWN THE SYSTEM FOR LONG PERIODS

If the boiler will not be in used for a prolonged period of time, the following operations must be carried out:

- switch the boiler to OFF 
- isolate the appliance from the gas and electricity supplies.

In this case, the frost-protection and anti-blocking systems are deactivated. Drain both the heating and domestic water systems to avoid any risk of freezing.

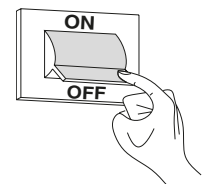
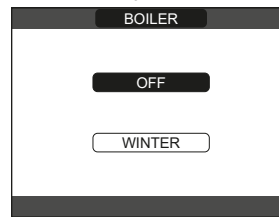

3.5 HOW TO CARE FOR THE APPLIANCE

To clean the outer casing use only a clean damp cloth. Do not use any scourers or abrasive cleaners.

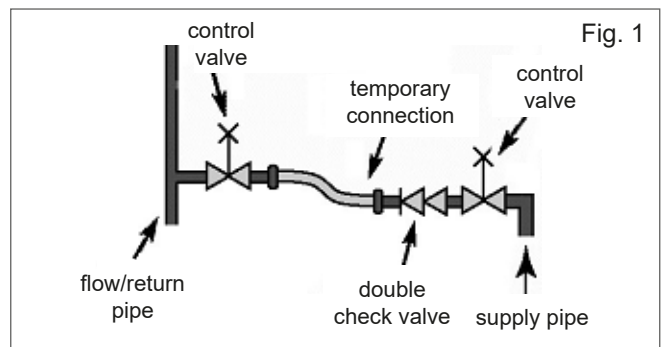

4. WHAT IF...

4.1 WHAT IF I SUSPECT A GAS LEAK

If you suspect a gas leak, turn off the gas supply at the gas meter and contact your installer or local gas supplier. If you require further advice please contact your nearest Vokèra office.

4.2 WHAT IF I HAVE FREQUENTLY TO TOP-UP THE SYSTEM

If the system regularly requires topping-up, it may be indicative of a leak. Please contact your installer and ask him to inspect the system.

4.3 WHAT IF THE APPLIANCE IS DUE ITS ANNUAL SERVICE

Advice for tenants only

Your landlord should arrange for servicing.

Advice for homeowners

Please contact Vokèra Customer Service (**0844 3910999 (UK) or 056 7755057 (ROI)**) if you would prefer a Vokèra service engineer or agent to service your appliance. Alternatively your local GAS SAFE registered engineer may be able to service the appliance for you.

4.4 WHAT IF I NEED TO CALL AN ENGINEER

If you think your boiler may have developed a fault, please contact your installer or Vokèra Customer Services (**0844 3910999 (UK) or 056 7755057 (ROI)**) have all your details to hand including full address and postcode, relevant contact numbers, and your appliance log book. It is a requirement of your warranty terms & conditions that your Benchmark logbook has been filled out correctly and is fully up to date.

INSTALLATION AND SERVICING INSTRUCTIONS

INTRODUCTION

All installers are asked to follow the Benchmark Scheme by adhering to the Code of Practise, details of which can be obtained from www.benchmark.org.uk.

The **UNICA MAX** has a ACC (Active Combustion Control) system. This control system ensures functionality, efficiency and low emissions under any conditions.

The ACC system uses an ionisation sensor immersed in the burner flame, whose information allows the control board to operate the gas valve that regulates the fuel.

This sophisticated control system provides the auto-regulation of the combustion, so there is no need for an initial calibration.

The ACC system is able to adapt the boiler to operate with different gas compositions, different outlet pipes lengths and different altitudes (within the specified design limits).

The ACC system can also perform an auto-diagnostic operation that locks out the burner before the permitted upper emission limit is exceeded.

The **UNICA MAX** product family comprises a range of high-efficiency combination and system boilers. These appliances – by design – incorporate electronic ignition, circulating pump, expansion vessel, safety valve, pressure gauge and automatic by-pass.

The range is produced as room sealed, category II2H3P-II2HY203P appliances, suitable for internal wall mounting applications only. Each appliance is provided with a fan powered flue outlet with an annular co-axial combustion air intake that can be rotated – horizontally – through 360 degrees for various horizontal or vertical applications.

These appliances are designed for use with a sealed system only; consequently they are not intended for use on open vented systems.

This booklet is an integral part of the appliance. It is therefore necessary to ensure that the booklet is handed to the person responsible for the property in which the appliance is located/installed. A replacement copy can be downloaded from the Vokera website - www.vokera.co.uk.

The boiler complies with basic requirements of the following Directives:

- Regulation (EU) 2016/426;
- Yield directive: Article 7(2) and Annex III of directive 92/42/EEC;
- Electromagnetic compatibility directive 2014/30/EU;
- Low-voltage directive 2014/35/EU;
- Directive 2009/125/EC Ecodesign for energy-using appliances;
- Regulation (EU) 2017/1369 Energy labeling;
- Delegated Regulation (EU) No. 811/2013;
- Delegated Regulation (EU) No. 813/2013.

 At the end of its life, the product should be not be disposed of as solid urban waste, but rather it should be handed over to a differentiated waste collection and/or recycling centre.

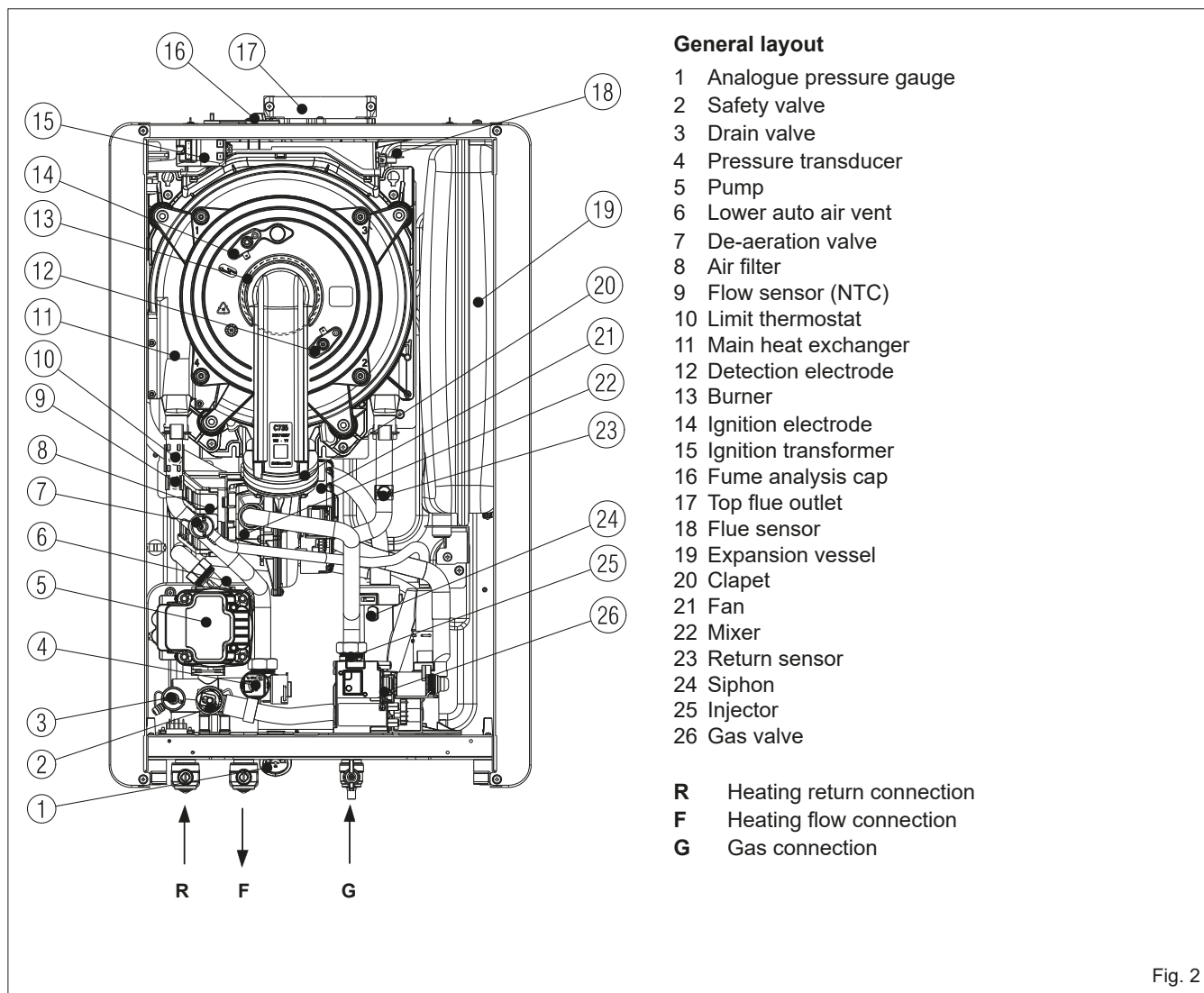

Fig. 2

1. SECTION - DESIGN PRINCIPLES AND OPERATING SEQUENCE

1.1 PRINCIPLE COMPONENTS

- A fully integrated electronic control board featuring electronic temperature control, anti-cycle control, pump over-run, self-diagnostic fault indicator, full air/gas modulation
- Stainless-steel heat exchanger
- Electronic ignition with flame supervision
- Integral high-head pump
- Fan
- Expansion vessel
- Flue sensor
- Pressure transducer
- Safety valve

1.2 MODE OF OPERATION (at rest)

When the appliance is at rest and there are no requests for heating or hot water, the following functions are active:

- frost-protection system: the frost-protection system protects the appliance against the risk of frost damage, if the main temperature falls to 5°C, the appliance will function on minimum power until the temperature on main reaches 35°C.
- anti-block function: the anti-block function enables the pump to be energised for short periods, when the appliance has been inactive for more than 24-hours.

1.3 MODE OF OPERATION (Heating)

When there is a request for heat via the REC/or any external control, the pump and fan are started, the fan speed will modulate until the correct signal voltage is received at the control PCB. At this point an ignition sequence is enabled.

Ignition is sensed by the electronic circuit to ensure flame stability at the burner. Once successful ignition has been achieved, the electronic circuitry increases the gas rate to 75% for a period of 15 minutes. Thereafter, the boiler's output will either be increased to maximum or modulate to suit the set requirement. When the appliance reaches the desired temperature the burner will shut down and the boiler will perform a three-minute anti-cycle (timer delay).

When the request for heat has been satisfied the appliance pump and fan may continue to operate to dissipate any residual heat within the appliance.

1.4 SAFETY DEVICES

When the appliance is in use, safe operation is ensured by:

- a pressure transducer that monitors system water pressure and will de-activate the pump, fan, and burner should the system water pressure drop below the required minimum value;
- fan speed sensor to ensure safe operation of the burner;
- a high limit thermostat that over-rides the temperature control circuit to prevent or interrupt the operation of the burner;
- flame sensor that will shut down the burner when no flame signal is detected and/or when incomplete combustion or high emissions are detected;
- flue sensor that will shut down the burner if the flue threshold temperature is exceeded;
- a safety valve which releases excess pressure from the primary circuit.

NOTE: when the appliance is first switched ON or when the electrical supply is interrupted then restored, the appliance will enter a short 'purge' cycle whereby the pump cycles ON & OFF for approximately 2-minutes. Only when the 'purge' cycle has been completed, will the appliance go through an ignition sequence.

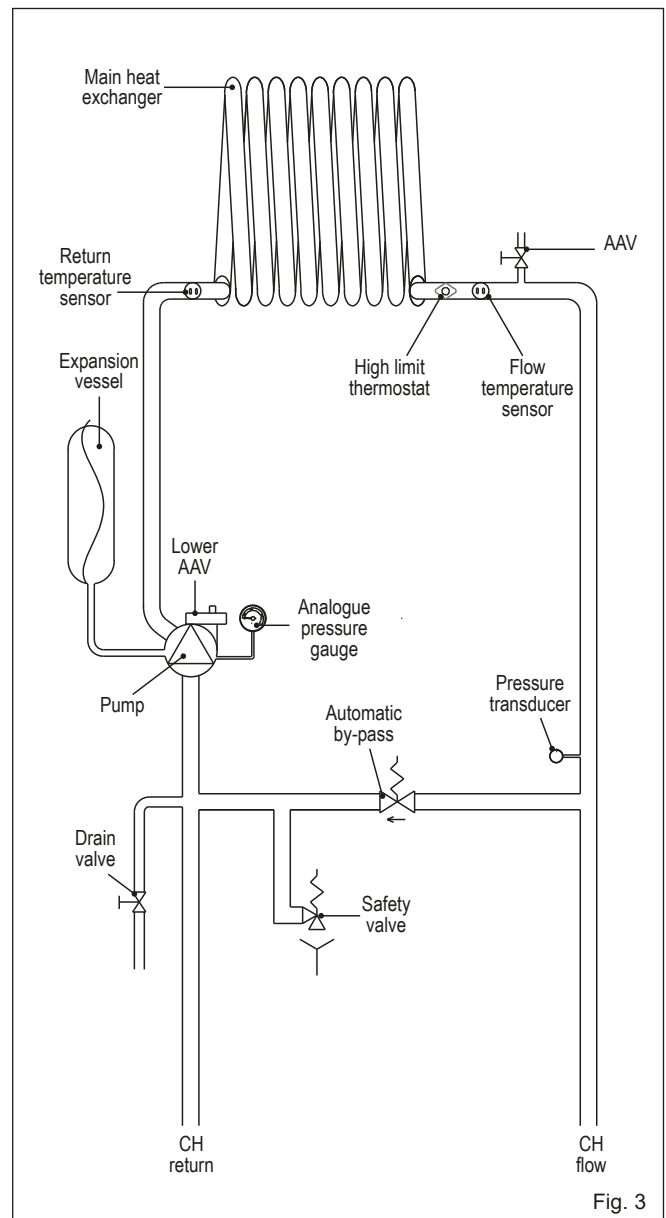

Fig. 3

2. SECTION - TECHNICAL DATA

2.1 Central Heating	UNICA MAX 20S	UNICA MAX 30S
Heat input (kW)	20.00*** <i>(*** The rated heat input with gas G20.2 (I2Y20) undergoes a reduction: Qn heating = 18.9 kW</i>	32.00
Maximum heat output (kW) 60/80°C	19.50	31.23
Minimum heat output (kW) 60/80°C	3.46	4.69
Maximum heat output (kW) 30/50°C	21.32	34.37
Minimum heat output (kW) 30/50°C	3.85	5.06
Minimum working pressure	0.25÷0.45 bar	
Maximum working pressure	3.0 bar	
Minimum flow rate	350 l/h	
2.2 Gas Pressures	UNICA MAX 20S	UNICA MAX 30S
Inlet pressure (G20)	20.0 mbar	20.0 mbar
Heating maximum gas rate (m³/hr)	2.12	3.38
Minimum gas rate (m³/hr)	0.38	0.52
Injector size (mm)	1 x 4.3	1 x 5.2
2.3 Expansion Vessel	UNICA MAX 20S	UNICA MAX 30S
Capacity	9 litres	10 litres
Maximum system volume	74 litres	
Pre-charge pressure	1 bar	
2.4 Dimensions	UNICA MAX 20S	UNICA MAX 30S
Height (mm)	740	
Width (mm)	420	470
Depth (mm)	275	350
Dry weight (kg)	32	37.5
2.5 Clearances required for maintenance	UNICA MAX 20S	UNICA MAX 30S
Sides	2mm*	
Top	100mm** from casing or 25mm above flue elbow (whichever is applicable)**	
Bottom	100mm [^]	
Front	450mm ^{^^}	
* It may be necessary to remove adjacent components if component removal/replacement is required		
** Consideration should be given to providing reasonable clearance for the insertion of a FGA probe.		
[^] This can be reduced to 4mm if a removal panel enables the required 100mm		
^{^^} When installed in a cupboard, this dimension can be reduced to 4mm provided that the required 450mm is available when the door is opened/ removed.		
2.6 Connections	UNICA MAX 20S	UNICA MAX 30S
Flow & return	22mm	
Gas	15mm	
DHW hot & cold	15mm	
Safety valve	15mm	
Condense	21mm	
2.7 Electrical	UNICA MAX 20S	UNICA MAX 30S
Power consumption CH (Watts)	98	112
Voltage (V/Hz)	230/50	
Internal fuse	4 A T (for PCB) - 3.15A F (for connections block)	
External fuse	3A	
2.8 Flue Details (concentric 60-100)	UNICA MAX 20S	UNICA MAX 30S
Maximum horizontal flue length (60/100mm)	10.0 m	6.0 m
Maximum vertical flue length (60/100mm)	11.0 m	7.0 m
2.9 Efficiency	UNICA MAX 20S	UNICA MAX 30S
SEDBUK 2005 (%)	90.1	90.2
2.10 Emissions	UNICA MAX 20S	UNICA MAX 30S
CO ₂ @ maximum output (%) (*)	9.0	9.0
CO ₂ @ minimum output (%) (*)	9.0	9.0
CO @ maximum output (ppm)	130	170
CO @ minimum output (ppm)	10	10
NO _x rating	class 6	class 6
(*) CO ₂ tolerance = +0.6% -1%		
2.11 Fan rotations	UNICA MAX 20S	UNICA MAX 30S
Number of fan rotations with slow ignition (rpm)	5,500	5,500
Maximum number of heating fan rotations (rpm)	6,200	7,300
Minimum number of heating fan rotations (rpm)	1,600	1,700
2.12 Gas pressure	UNICA MAX 20S	UNICA MAX 30S
Nominal methane gas pressure (G20 - I2H)	20 mbar	20 mbar
Nominal methane-hydrogen gas pressure (G20.2 - I2Y20)	20 mbar	20 mbar
Nominal liquid gas LPG pressure (G31 - I3P)	37 mbar	37 mbar

Parameter	Symbol	UNICA MAX 20S	UNICA MAX 30S	Unit
Seasonal space heating energy efficiency class	-	A	A	-
Water heating energy efficiency class	-	-	-	-
Rated heat output	P _{nominal}	20	31	kW
Seasonal space heating energy efficiency	η_s	93	94	%
Useful heat output				
At rated heat output and high-temperature regime (*)	P ₄	19,5	31,2	kW
At 30% of rated heat output and low-temperature regime (**)	P ₁	6,5	10,5	kW
Useful efficiency				
At rated heat output and high-temperature regime (*)	η_4	87,8	87,9	%
At 30% of rated heat output and low-temperature regime (**)	η_1	98,3	98,6	%
Auxiliary electricity consumption				
At full load	e _{lmax}	27,0	49,0	W
At part load	e _{lmin}	13,0	13,0	W
In Stand-by mode	PSB	3,0	3,0	W
Other parameters				
Stand-by heat loss	P _{stby}	30,2	26,0	W
Pilot flame energy consumption	P _{ign}	-	-	W
Annual energy consumption	Q _{HE}	60	96	GJ
Sound power level, indoors	L _{WA}	50	54	dB
Emissions of nitrogen oxides	NO _x	46	38	mg/kWh
For combination heaters				
Declared load profile		-	-	
Water heating energy efficiency	η_{wh}	-	-	%
Daily electricity consumption	Q _{elec}	-	-	kWh
Daily fuel consumption	Q _{fuel}	-	-	kWh
Annual electricity consumption	AEC	-	-	kWh
Annual fuel consumption	AFC	-	-	GJ

(*) High-temperature regime means 60 °C return temperature at heater inlet and 80 °C feed temperature at heater outlet.

(**) Low temperature means for condensing boilers 30 °C, for low-temperature boilers 37 °C and for other heaters 50 °C return temperature (at heater inlet).

NOTE (if the outdoor temperature sensor or the control panel, or even both devices, are present in the boiler)

With reference to the Delegated Regulation (EU) No. 811/2013, the information in the table can be used for completing the product data sheet and the labelling for room heating appliances, for mixed heating appliances, for all those appliances for enclosed space heating, for temperature control devices and solar devices:

ADDED DEVICES	CLASS	BONUS
OUTDOOR TEMPERATURE SENSOR	II	2%
CONTROL PANEL*	V	3%
OUTDOOR TEMPERATURE SENSOR + CONTROL PANEL*	VI	4%

(*) Set as ambient regulator

2.13 Residual head of the circulator

The boiler is equipped with a high efficiency modulating circulator already connected hydraulically and electrically, the available useful performances of which are indicated in the graph. The modulation is managed by the board through the DUTY CYCLE PUMP parameter - INSTALLER access level. The circulator is factory set with a 7 meter head curve.

 The boiler is equipped with an anti-blocking system that starts an operating cycle every 24 hours of rest in any operating state.

 The "anti-blocking" function is active only if the boiler is electrically powered.

If there is a need to use a different curve, the desired level can be selected on the circulator.

 If you need to "release" the seized rotator shaft, please see par. 6.1.1.

2.13.1 Variable speed circulator

The modulating circulator function is active only in the heating function. When switching the three-way to the sanitary, the circulator always works at maximum speed. The modulating circulator function applies only to the boiler circulator and not to the circulators of any external connected devices (e.g. booster circulator). Through the DUTY CYCLE PUMP parameter it is possible to choose between 4 management modes according to the situations and the type of system.

1 - VARIABLE SPEED CIRCULATOR WITH PROPORTIONAL MODE (41 ≤ DUTY CYCLE PUMP ≤ 100)

In this mode the boiler card determines which flow curve to adopt according to the instantaneous power delivered by the boiler.

2 - VARIABLE SPEED CIRCULATOR WITH CONSTANT ΔT MODE (2 ≤ DUTY CYCLE PUMP ≤ 40)

In this mode, the installer sets the ΔT value to be maintained between flow and return (e.g. : by entering a value = 10, the circulator speed will change to obtain a system flow rate with the aim of maintaining the ΔT between the upstream and downstream of the exchanger of 10°C).

3 - CIRCULATOR IN MAXIMUM FIXED SPEED MODE (DUTY CYCLE PUMP = 1)

In this mode the circulator, when activated, always works at maximum speed.

Used on systems with high pressure drop where it is necessary to make the most of the boiler head in order to ensure sufficient circulation (system flow rate at maximum speed less than 600 liters per hour).

Used in the presence of mix bottles with high flow rates in the downstream circuit.

Operationally:

- Enter the DUTY CYCLE PUMP parameter
- Set the value = 1

4 - EXCEPTIONAL USE OF A STANDARD NON-SPEED ADJUSTABLE CIRCULATOR (DUTY CYCLE PUMP = 0)

This mode must be used in exceptional cases in which a traditional UPS circulator is to be used in the boiler.

CONFIGURATIONS RECOMMENDED BY THE MANUFACTURER

	EXTERNAL SENSOR YES (WEATHER COMPENSATION)	EXTERNAL SENSOR (NO WEATHER COMPENSATION)
LOW TEMPERATURE (floor)	ΔT constant (5 ≤ DUTY CYCLE PUMP ≤ 7)	PROPORTIONAL (DUTY CYCLE PUMP = 85)
HIGH TEMPERATURE (radiators without thermostatic valves)	ΔT constant (15 ≤ DUTY CYCLE PUMP ≤ 20)	PROPORTIONAL (DUTY CYCLE PUMP = 85)
HIGH TEMPERATURE (radiators with thermostatic valves)	ΔT constant (15 ≤ DUTY CYCLE PUMP ≤ 20)	PROPORTIONAL (DUTY CYCLE PUMP = 60)

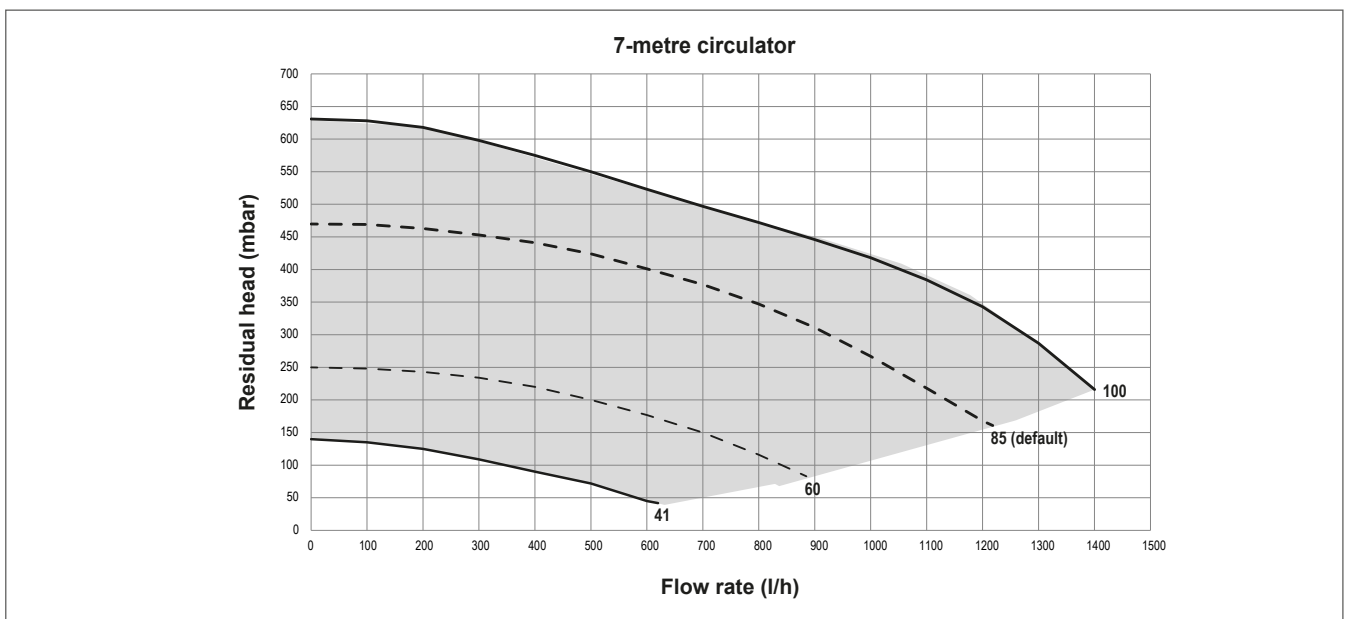

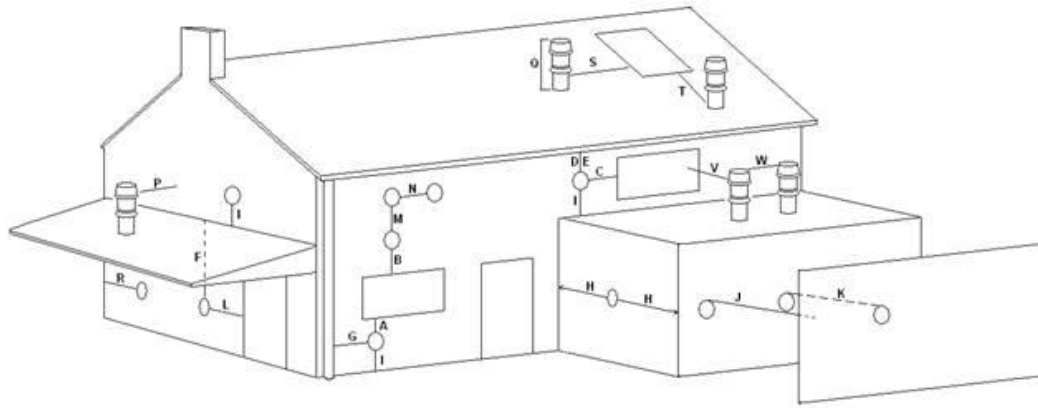

Key	Location	Minimum distance
A	Below an opening (window, air-brick, etc.)	300 mm
B	Above an opening (window, air-brick, etc.)	300 mm
C	To the side of an opening (window, air-brick, etc.)	300 mm
D	Below gutter, drain-pipe, etc.	25 mm
E	Below eaves	25 mm
F	Below balcony, lowest point of carport roof, etc.	25 mm
G	To the side of a soil/drain-pipe, etc.	25 mm (60mm for 80/125mm)
H	From internal/external corner	25 mm (60mm for 80/125mm)
I	Above ground, roof, or balcony level	300 mm
J	From a surface or boundary facing the terminal	600 mm*
K	From a terminal facing a terminal	1200 mm
L	From an opening in the car-port into the building	1200 mm
M	Vertically from a terminal on the same wall	1500 mm
N	Horizontally from a terminal on the same wall	300 mm
P	From a structure to the side of the vertical terminal	300 mm
Q	From the top of the vertical terminal to the roof flashing	As determined by the fixed collar of the vertical terminal
R	To the side of a boundary	300 mm
S	To the side of an opening or window on a pitched roof	600 mm
T	Below an opening or window on a pitched roof	2000 mm
V	From a vertical terminal to an adjacent opening (window, air-brick, etc.)	2000 mm
W	From a vertical terminal to an adjacent vertical terminal	300 mm (only if both terminals are the same height)

*The possibility that this may be deemed as causing a nuisance, should be considered

3. SECTION - CONTROL PANEL (REC10H)

The REC10 is a fully functional UI (User Interface) that acts as a visual reference for the appliance and system status; and can also be used to view, input and adjust relevant system parameters and functions.

The centre of the UI will normally display the current operating temperature (according to the mode of operation); however when the screensaver is active, the current time will be displayed.

The value expressed in bar refers to the system's water pressure.

The top of the screen shows the information regarding the current date and time, as well as the outdoor temperature, if available. On the left and right sides are displayed the icons indicating the status of the system; their meaning is as follows.

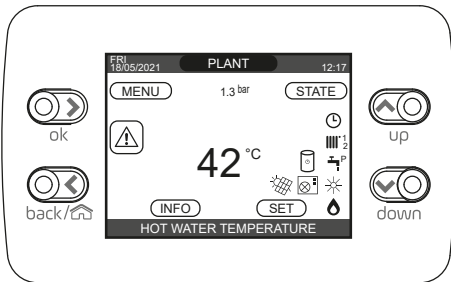

REC10H	Boiler control panel
	Confirm
	back= return to the previous screen cancel selection
	return to the main screen (press > 2 sec.)
	- From the main screen they allow you to choose between the options: MENU, INFO, SET, STATE, PLANT.
	- From the sub-menus they allow you to navigate through the different options

System Icons may appear on both the left and right of the display, and they signify the following condition/status:

	This icon indicates that the OFF operating status mode has been set. Each ignition request is ignored except for the frost-protection function. The pump anti-lock and frost-protection function remain active.
	This icon indicates that WINTER mode has been selected (HEATING function enabled). If a heating request from the main zone is in progress, the icon will be flashing. If there is a CH request from the additional zone, the number 1 or 2 is flashing.
	Only if heat pump is present. This icon indicates that cooling is active in the SUMMER state. If a cooling request from the main zone is in progress, the icon is flashing. If a cooling request from the additional zone is in progress, number 1 is flashing.
	This icon indicates that the circuit for domestic hot water production is enabled. When a domestic hot water request is in progress, the icon flashes (default value - parameter: "water tank type = 0"). If we are outside the time slots for enabling the sanitary, the icon is crossed out
	When the "central heating programming timing" is enabled this icon indicates that the system heating (main zone) is in AUTOMATIC mode (the management of the heating requests follows what has been set with the timer). If the heating function is not enabled during the current time frame, the icon will be crossed out.
	When the "central heating programming timing" is enabled this icon indicates that the system heating (main zone) is in MANUAL mode (the management of the heating requests does not follow what has been set with the programming timing, but it is always active).
OFF	This icon indicates that the main zone, when the "central heating programming timing" function is not enabled, has been set to off (not active).
	Only if heat pump is present. This icon indicates that the management of a heat pump is enabled. When the heat pump is running, then the icon is flashing.
	Only if solar system is present. This icon indicates that the management of a solar system is enabled. When the solar system circulator is running, then the icon is flashing.
	This icon indicates that the system is detecting the presence of a flame.
	This icon indicates the presence of an anomaly or fault condition, and is always flashing.
	Only with combined boiler and presence of boiler + heat pump enabled for domestic hot water. The icon appears crossed out with an "X" when the system works outside the activation times of the heat pump in the domestic hot water, while it flashes when the heat pump is in operation to load the boiler.
	Only if photovoltaic enabled. When the icon is flashing, it means that the electrical productivity of the photovoltaic system is adequate (closed contact). The system exploits the available energy.

Note:

The temperature of the heating outlet sensor is shown at the centre of the main screen. The value's meaning is indicated at the bottom of the display.

Whenever a heating request is in progress, the value displayed at the centre of the screen refers to the system's flow sensor, with the relative indication.

The value expressed in bar refers to the system's water pressure.

The top of the screen shows the current date and time, as well as the outdoor temperature, if available.

Pressing the keys "up" and "down" it is possible to choose from among the following options:

- **PLANT:** the display will indicate the temperature of the flow sensor of the boiler
- **STATE/BOILER:** enables access to choose the operating mode of the appliance: OFF, Winter
- **STATE/MAIN ZONE** (if embedded clock disabled): enables access to choose the operating mode (On or OFF) of the main heating zone
- **STATE/MAIN ZONE** (if embedded clock is enabled): enables access to choose operating mode of the embedded clock (AUTO, MANUAL, OFF)
- **SET:** to view or adjust the heating setpoint value
- **INFO:** to view the current values or status of the various appliance inputs/sensors

- **MENU:** to access the system's configuration menus.

The configuration MENU is organised with a multi-access level tree structure. With the "ok" key you can access the selected submenu, with the "up" and "down" keys it is possible to navigate through the submenus, while the "back" key takes you back to the previous level.

An access level has been fixed for each submenu: USER level, always available; TECHNICAL level, password protected. Below is a summary of the MENU tree structure of the REC10.

Some of the information might not be available on the REC10 depending on the access level, the status of the machine or the system configuration.

The display of the REC10H control panel is equipped with the new "Color Bar" that rapidly informs the user about the boiler operation. The operating states and the alarms are grouped by 4 colours:

- GREEN: normal operation, the system is serving domestic hot water/heating requests or else automatic functions like, for example, anti-legionella, antifreeze, flue cleaning, etc.. Scrolling text describes the function active in that moment
- YELLOW: presence of faults that could be resolved by the user that allow the product to operate even partially. An error triangle on the display gives access to details about the fault like, for example, "call for service", domestic hot water probe fault, etc..
- RED: presence of lockout faults that require the intervention of the Technical Assistance Centre. An error triangle on the display gives access to details about the fault like, for example, "stop for service", lockout, etc..
- GREY: system is ready to meet any requests or functions, no fault detected.

If several conditions are present at the same time, the signal on the main screen corresponds to the highest priority, in the following ascending order: Grey, Green, Yellow and Red.

The configuration MENU is organised with a multi-access level tree structure. An access level has been fixed for each submenu: USER level, always available; TECHNICAL (psw 18)/SERVICE (psw 53) level, password protected.

Below is a summary of the MENU tree structure of the REC10H.

Some of the information might not be available on the REC10H depending on the access level, the status of the machine or the system configuration.



This manual describes the operation of the boiler with the REC10CH machine interface.

In case of installation of additional elements (heat pump, boiler, solar, photovoltaic system, etc.) it is necessary to refer to the instructions contained in the "Programming Manual for the management of hybrid systems"

 **ATTENTION**

Unauthorised or inexperienced personnel, e.g. end-users, should not attempt to access or change any of the passcode protected parameters of the appliance.

Any such changes could render the appliance inoperable, may cause the appliance to malfunction, and could invalidate the appliance warranty.

3.1 Structure of the REC10CH MENU

MENU	DEFAULT VALUE	FACTORY SET	MINIMUM VALUE	MAXIMUM VALUE	ACCESS LEVEL	NOTES	SET VALUE
SETTINGS						USER	
TIME & DATE						USER	
DAYLIGHT SAVINGS TIME						USER	
LANGUAGE		FUNCTION ACTIVE	FUNCTION NOT ACTIVE	FUNCTION ACTIVE		USER	
BACKLIGHT						USER	
5 min			1 min	15 min		USER	
TIME SCHEDULE						USER	
MAIN						USER: only if POR = 1	
ZONE 1						USER: only if POR = 1 and zone added	
ZONE 2						USER: only if POR = 1 and zone added	
DHW						USER: only if PLANT CONFIGURATION = WATER TANK	
HP DHW						USER: only if HP present and USE PER DHW active	
TECHNICAL						INSTALLER	
INSTALLATION						INSTALLER	
ZONES MANAGER						INSTALLER	
MODIFY ZONE						INSTALLER	
ACTUATION TYPE	MAIN		MAIN / ZONE 1 / ZONE 2			INSTALLER	
REQUEST TYPE	ITRF05/boiler card		ITRF05/boiler card	BE16		INSTALLER: only MAIN zone	
BE16 ADDRESS	THERMOSTAT		THERMOSTAT / TEMPERAURE PROBE / REC10CH MASTER / REC10CH SLAVE			INSTALLER	
HYDRAULIC CONF	--		1	6		INSTALLER: only zones with ACTUATION=BE16	
ZONE TYPE	DIRECT ZONE		DIRECT ZONE	MIXING ZONE		INSTALLER: only zones with ACTUATION=BE16	
MIN CH SET	HIGH TEMP		HIGH TEMP	LOW TEMP		INSTALLER	
MAX CH SET	20°C (HT) 20°C (LT)		20°C	MAX CH SET		INSTALLER	
CHANGE NAME	80.5 °C (HT) 45°C (LT)		MIN CH SET	80.5 °C (HT) 45°C (LT)		INSTALLER	
PI - PROPORTIONAL	5		0	99		SERVICE: only mixing zones with ACTUATION=BE16	
PI - INTEGRAL	10		0	99		SERVICE: only mixing zones with ACTUATION=BE16	
VALVE RUN	120 sec		0 sec	120 sec		SERVICE: only mixing zones with ACTUATION=BE16	
CLOSING AT POWER ON	140 sec		0 sec	240 sec		SERVICE: only mixing zones with ACTUATION=BE16	
OUTLET OVER	55°C		0°C	100°C		SERVICE: only LT zones with ACTUATION=BE16	
OUTLET OVER TEST TIME	0 min		0 min	240 min		SERVICE: only LT zones with ACTUATION=BE16	
OUTLET OVER WAIT TIME	2 min		VALVE RUN	240 min		SERVICE: only LT zones with ACTUATION=BE16	
OUTLET OVER REST TIME	2 min		0 min	240 min		SERVICE: only LT zones with ACTUATION=BE16	
FREEZE PROT TEMP	6°C		-10°C	50°C		SERVICE: only zones with ACTUATION=BE16	
FREEZE PROT OFFSET	5°C		1°C	20°C		SERVICE: only zones with ACTUATION=BE16	
FREEZE PROT T EXT	10°C		0°C	100°C		SERVICE: only zones with ACTUATION=BE16	
POR	0 (1 if REC10 in the AMBIENT)		0	1		INSTALLER	
ADD ZONE						INSTALLER	
DELETE ZONE						INSTALLER	
SENSOR CALIBRATION	0.0°C		-6.0°C	6.0°C		INSTALLER	
SYSTEM RESET						INSTALLER	
PARAMETERS						INSTALLER	
ANTI-CYCLE FUNCTION	3 min		0 min	20 min		INSTALLER	
HYST ON HIGH TEMP	5°C		2°C	10°C		SERVICE	
HYST OFF HIGH TEMP	5°C		2°C	10°C		SERVICE	
HYST ON LOW TEMP	3°C		2°C	10°C		SERVICE	
HYST OFF LOW TEMP	3°C		2°C	10°C		SERVICE	
SP INCR HIGH TEMP	5°C (0°C if instantaneous boiler)		0°C	10°C		SERVICE	

	DEFAULT VALUE FACTORY SET	MINIMUM VALUE	MAXIMUM VALUE	ACCESS LEVEL NOTES	SET VALUE
— SP INCR LOW TEMP	0°C	0°C	6°C	SERVICE	
— DECR COOLING SP	0°C	0°C	10°C	SERVICE	
— PUMP DUTY CYCLE	85	0	100	INSTALLER	
— RESET CH TIMERS	FUNCTION NOT ACTIVE	FUNCTION NOT ACTIVE	FUNCTION ACTIVE	INSTALLER	
— SLIDING OUTLET	DEACTIVATE FUNCTION	DEACTIVATE FUNCTION	ACTIVATE FUNCTION	INSTALLER: only in "heating only" config. and water tank with probe	
— CH DELAY POST-DHW	0	0	1	SERVICE	
— CH DELAY TIME	6 sec	1 sec	255 sec	SERVICE: if CH DELAY POST-DHW = 1	
— PRESS TRANSDUCER	1	0	1	SERVICE	
— AUTO WATER FILL ENABLE	0	0	1	SERVICE: only if PRESS TRANSDUCER = 1	
— BEGIN SYSTEM FILLING	0.6	0.4	1	SERVICE: only if AUTO WATER FILL ENABLE = 1	
— DO_AUX1	0	0	2	INSTALLER: only if control boards with OTBus	
— CONFIG OTBUS	1	0	1	SERVICE: only if control boards with OTBus	
— WEATHER COMPENSATION				INSTALLER	
— CLIMATIC CURVES	MAIN	MAIN / ZONE 1 / ZONE 2		INSTALLER	
— FIXED SET POINT	80.5 °C (HT) 45 °C (LT)	MIN CH SET	MAX CH SET	INSTALLER: if EXTERNAL PROBE NOT connected	
— NIGHT COMP	FUNCTION NOT ACTIVE	FUNCTION NOT ACTIVE	FUNCTION ACTIVE	INSTALLER: if EXTERNAL PROBE connected	
— CURVE SLOPE	2.0	1.0	3.0	INSTALLER: if EXTERNAL PROBE, request type TA and zone type HT	
— AMBIENT INFLUENCE	10	0	20	INSTALLER: if request type AMBIENT PROBE or REC10CH	
— OFFSET	20°C	20°C	40°C	INSTALLER: if request type AMBIENT PROBE or REC10CH	
— COOLING	18°C	4°C	20°C	INSTALLER: if COOLING CURVE deactivated	
— COOLING CURVE	1	1	2	INSTALLER: if COOLING CURVE activated	
— BUILDING TYPE	5 min	5 min	20 min	INSTALLER: if EXTERNAL PROBE connected	
— OUTDOOR REACTIVITY	20	0	255	INSTALLER: if EXTERNAL PROBE connected	
— ENABLE/DISABLE COOLING CURVE				INSTALLER: if HP present and enable to COOLING	
— RANGE RATED		not used		INSTALLER	
— CALIBRATION				INSTALLER	
— MIN		see MULTIGAS TABLE		INSTALLER	
— MAX		see MULTIGAS TABLE		INSTALLER	
— RLA		see MULTIGAS TABLE		INSTALLER	
— MAX CH		see MULTIGAS TABLE		INSTALLER	
— COMBUSTION ANALYSIS				INSTALLER	
— ACTIVATE FUNCTION				INSTALLER	
— DEACTIVATE FUNCTION				INSTALLER	
— MAX SPEED	MAX			INSTALLER	
— RANGE RATED SPEED	RANGE RATED			INSTALLER	
— MIN SPEED	MIN			INSTALLER	
— CHANGE FAN SPEED	CURRENT SPEED	MIN	MAX	INSTALLER	
— ANTI-LEGIO	WEEKLY FUNCTION	FUNCTION NOT ACTIVE / DAILY FUNCTION / WEEKLY FUNCTION		INSTALLER: only if "only heating" config. and water tank with probe	
— ANTILEGIO FLOW	80°C	65°C	85°C	INSTALLER	
— ANTILEGIO TIME	03:00	00:00	23:30	INSTALLER	
— ANTILEGIO TEMP	70°C	55°C	WATER TANK T MAX	INSTALLER	
— AIR PURGING CYCLE	FUNCTION DISABLED	FUNCTION DISABLED	FUNCTION ENABLED	SERVICE	
— FUNCTION DISABLED				SERVICE	
— FUNCTION ENABLED				SERVICE	
— STOP FUNCTION				INSTALLER: only if AIR PURGING CYCLE in progress	
— EXHAUST PROBE RESET				INSTALLER	
— ADD WATER TANK				INSTALLER: only if instantaneous and "only heating" config.	

	DEFAULT VALUE	FACTORY SET	MINIMUM VALUE	MAXIMUM VALUE	ACCESS LEVEL	NOTES	SET VALUE
WATER TANK						INSTALLER	
REMOVE WATER TANK						INSTALLER	
WATER TANK TYPE	0		0	1		INSTALLER: only if "only heating" configuration	
TANK FROST PROTECT	7°C		0°C	100°C		SERVICE: only if "only heating" configuration with water-tank	
TANK FR PROT OFFSET	5°C		1°C	20°C		SERVICE: only if "only heating" configuration with water-tank	
WATER TANK FLOW	80°C		50°C	85°C		INSTALLER: only if "only heating" configuration with water-tank	
ADD SOLAR PLANT						INSTALLER: only if solar system is not configured	
SOLAR						INSTALLER	
REMOVE SOLAR PLANT						INSTALLER	
T MAX TANK	60°C		10°	130°C		INSTALLER	
DELTA T ON PUMP	8°C		DELTA T OFF PUMP	30°C		INSTALLER	
DELTA T OFF PUMP	4°C		4°C	DELTA T ON PUMP		INSTALLER	
INTEGRATION DELAY	0 min		0 min	180 min		INSTALLER	
COLLECTOR T MIN	(-)		(-)/-30°C	--°C		INSTALLER	
COLLECTOR T MAX	110°C		COLLECTOR T PROT	180°C		INSTALLER	
COLLECTOR T PROT	110°C		80 °C	COLLECTOR T MAX		INSTALLER	
COLLECTOR T AUTH	40°C		COLLECTOR T LOCK	95°C		INSTALLER	
COLLECTOR T LOCK	35°C		-20°C	COLLECTOR T AUTH		INSTALLER	
PWM COLL PUMP	0 min		0 min	30 min		INSTALLER	
TANK COOLING	FUNCTION NOT ACTIVE		FUNCTION NOT ACTIVE	FUNCTION ACTIVE		INSTALLER	
SOLAR PUMP MODE	OFF		OFF / ON / AUTO			INSTALLER	
ADD HEAT PUMP						INSTALLER: only if HP not configured	
HEAT PUMP						INSTALLER	
ADD HEAT PUMP/REMOVE PDC						INSTALLER: only if HP and boiler present	
USE FREE CONTACTS/USE BUS	USE BUS		USE BUS	USE FREE CONTACT		SERVICE	
ENABLE/DISABLE COOLING	FUNCTION NOT ACTIVE		FUNCTION ACTIVE	FUNCTION NOT ACTIVE		INSTALLER	
USE FOR DHW/DON'T USE FOR DHW	DHW FUNCTION NOT ACTIVE		DHW FUNCTION ACTIVE	DHW FUNCTION NOT ACTIVE		INSTALLER: if BE17 present	
ANTI FREEZE DELTA SET	1°C		0°C	6°C		SERVICE	
ENABLE/DISABLE NIGHT REDUCT	FUNCTION NOT ACTIVE		FUNCTION ACTIVE	FUNCTION NOT ACTIVE		INSTALLER	
REDUCED FREQUENCY	80%		50%	100%		INSTALLER: if NIGHT REDUCTION active	
NIGHT MODE START TIME	20:00		00:00	23:59		INSTALLER: if NIGHT REDUCTION active	
NIGHT MODE STOP TIME	09:00		00:00	23:59		INSTALLER: if NIGHT REDUCTION active	
MIN OUTDOOR TEMP	5°C		-5°C	20°C		INSTALLER	
MIN DHW OUT TEMP	5°C		-5°C	20°C		INSTALLER: only if USE FOR DHW in HP activated	
MIN EMERG OUT T	-10°C		-20°C	10°C and in any case not over the MIN OUTDOOR TEMP value		INSTALLER	
BOILER INTEGR DELAY	30 min		1 min	240 min		SERVICE	
HP INTEGR DELAY	30 min		1 min	240 min		SERVICE	
BOILER WAITING	2 min		1 min	60 min		SERVICE	
HEAT PUMP WAITING	2 min		1 min	60 min		SERVICE	
INTEGRATION OFFSET	5°C		0°C	10°C		SERVICE	
WINTER SUMMER DELAY	0h		0h	24h		SERVICE	
WARNING VALIDATION	60 sec		1 sec	300 sec		SERVICE	
ENABLE CIRC ON/AUTO MODE	AUTO		ON	AUTO		INSTALLER: if boiler in OFF and AIR PURGING CYCLE not present	
DHW HP SETPOINT	60°C		20°C	60°C		SERVICE: only if USE FOR DHW: in HP activated	
DHW OFFSET	10°C		0°C	25°C		SERVICE: only if boiler with water tank with probe and USE FOR DHW in HP activated	
ADD PHOTOVOLTAIC						INSTALLER	
PHOTOVOLTAIC						INSTALLER	
REMOVE PHOTOVOLTAIC						INSTALLER	
ELECTRIC CONVENIENCE	2		0	+10°C		INSTALLER	
BACKUP TYPE	1		0	1		INSTALLER	
BOOSTER OAT THRESHOLD	-7°C		MIN EMERG OUT T	15°C		INSTALLER	
BOOSTER DELAY	30min		1 min	60 min		INSTALLER	

MENU

- BOOSTER DELTA TEMP
- OAT SENSOR TYP
- MINIMUM PUMP SPEED
- MAXIMUM PUMP SPEED
- ENABLE ERROR HISTORY
- ERROR HISTORY
- SCREED HEATING
 - DEACTIVATE FUNCTION
 - ACTIVATE FUNCTION
 - FUNCTION SETTINGS
 - TFMIN
 - TFMAX
- COMBUSTION MONITORING
 - GAS TYPE
 - BOILER TYPE (*)
 - COMBUSTION OFFSET
 - ACC AUTO CAL
- BOILER
 - REMOVE BOILER
 - HYDRAULIC CONFIG

DEFAULT VALUE	FACTORY SET	MINIMUM VALUE	MAXIMUM VALUE	ACCESS LEVEL	NOTES	SET VALUE
5°C		1°C	20°C		INSTALLER	
0		0	3		INSTALLER	
19%		19%	100%		INSTALLER	
100%		19%	100%		INSTALLER	
					SERVICE	
					INSTALLER	
DEACTIVATE FUNCTION		DEACTIVATE FUNCTION	ACTIVATE FUNCTION		INSTALLER: OFF state and low temperature system	
					INSTALLER	
					SERVICE	
20 °C		15 °C	30 °C		SERVICE	
35 °C		30 °C	55 °C		SERVICE	
					SERVICE	
NATURAL GAS		NATURAL GAS / LPG			INSTALLER	
A		A / B / C /			SERVICE	
RESTORE		RESTORE	RESET		SERVICE	
RESTORE		RESTORE	RESET		SERVICE	
					INSTALLER	
4		0	4		INSTALLER	
4		0	4		INSTALLER	
0 = only heating / 1 = instantaneous with flowswitch / 2 = instantaneous with flowmeter / 3 = only heating + water tank with probe / 4 = only heating + water tank with thermostat						
					SERVICE	

—SYSTEM INFO

(*) BOILER TYPE: see “6.18 COMBUSTION PARAMETERS”

3.2 Access to TECHNICAL PARAMETERS

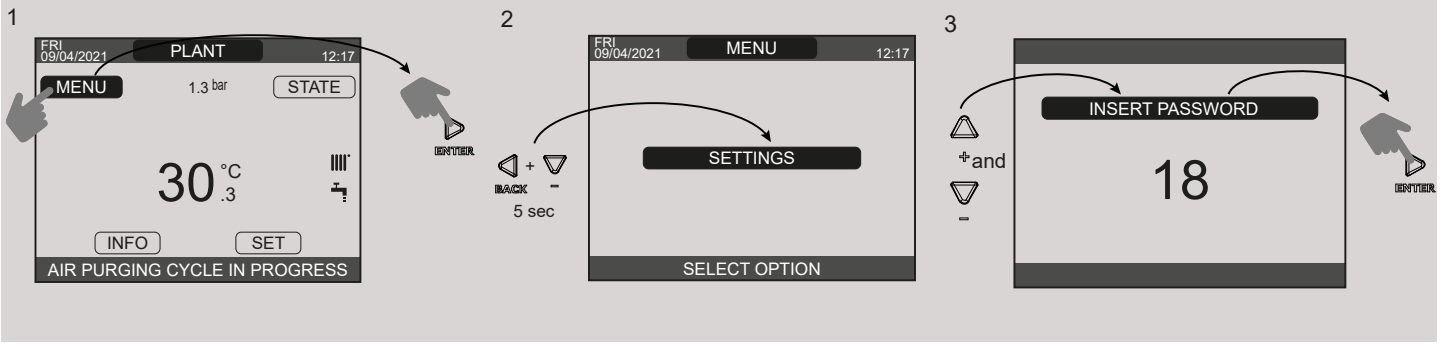

3.3 Access to SETTINGS - TECHNICAL - INFO SYSTEM menu

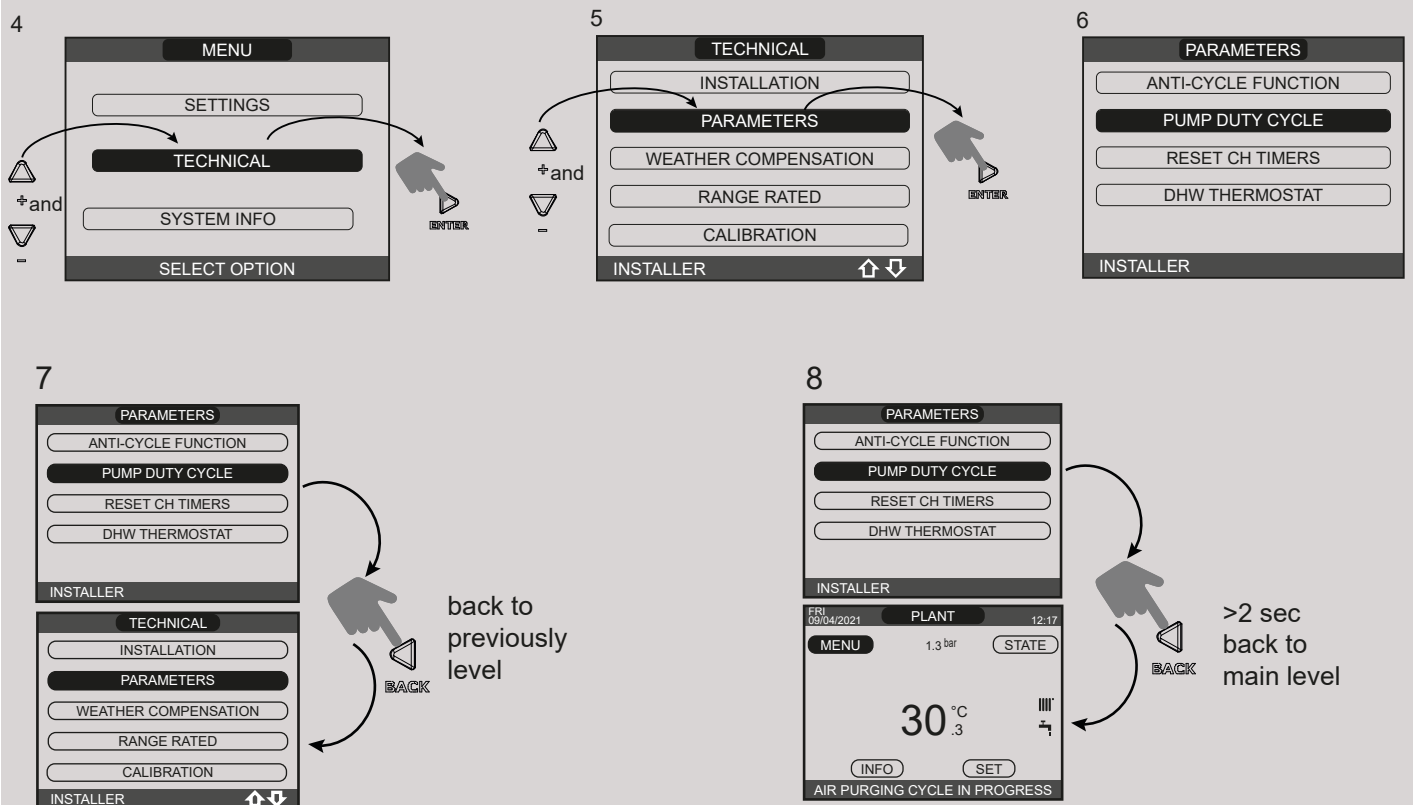

⚠ ATTENTION

Unauthorised or inexperienced personnel, e.g. end-users, should not attempt to access or change any of the passcode protected parameters of the appliance.

Any such changes could render the appliance inoperable, may cause the appliance to malfunction, and could invalidate the appliance warranty.

4. SECTION - GENERAL REQUIREMENTS (UK)

BS 5440	PART 1	FLUES
BS 5440	PART 2	FLUES & VENTILATION
BS EN 12828		DESIGN FOR WATER-BASED HEATING SYSTEMS
BS 6798		INSTALLATION OF BOILERS OF RATED INPUT NOT EXCEEDING 70kW
BS 6891		LOW PRESSURE INSTALLATION PIPES

This appliance must be installed by a competent person in accordance with the Gas Safety (Installation & Use) Regulations.

4.1 RELATED DOCUMENTS

The installation of this boiler must be in accordance with the relevant requirements of the Gas Safety (Installation & Use) Regulations, the local building regulations, the current I.E.E. wiring regulations, the bylaws of the local water undertaking, the Building Standards (Scotland) Regulation, and Building Standards (Northern Ireland) Regulations. It should be in accordance also with any relevant requirements of the local authority and the relevant recommendations of the following British Standard Codes of Practice.

ATTENTION

The use of PPE (Personal Protective Equipment) such as but not limited to gloves, mask, safety glasses, etc. is strongly recommended whenever carrying out the installation, repair, or maintenance of this appliance – please pay particular attention to:

- Sharp edges that may be encountered when:- handling or lifting the appliance, removing parts, etc. during installation and maintenance
- Airborne particles that may be released and/or disturbed when cleaning or removing components during maintenance
- Water treatment chemicals that could have been added to the system water may spill from the appliance and or components during maintenance

Please refer to an appropriate Health and Safety document such as HSE L23 (UK) or S.I. 299 (Ireland), for more detailed advice on safe working practices and procedures.

4.2 LOCATION OF APPLIANCE

The appliance may be installed in any room or internal space, although particular attention is drawn to the requirements of the current I.E.E. wiring regulations, and in Scotland, the electrical provisions of the Building Regulations, with respect to the installation of the appliance in a room or internal space containing a bath or shower. When an appliance is installed in a room or internal space containing a bath or shower, the appliance or any control pertaining to it must not be within reach of a person using the bath or shower (refer to IEE regs). The location chosen for the appliance must permit the provision of a safe and satisfactory flue and termination. The location must also permit an adequate air supply for combustion purposes and an adequate space for servicing and air circulation around the appliance. Where the installation of the appliance will be in an unusual location special procedures may be necessary, BS 6798 gives detailed guidance on this aspect. A compartment used to enclose the appliance must be designed and constructed specifically for this purpose. An existing compartment/cupboard may be utilised provided that it is modified to suit. Details of essential features of compartment/cupboard design including airing cupboard installations are given in BS 6798. This appliance is not configured for external installation applications.

4.3 GAS SUPPLY

The gas meter – as supplied by the gas supplier – must be checked to ensure that it is of adequate size to deal with the maximum rated input of all the appliances that it serves. Installation pipes must be fitted in accordance with BS 6891. Pipe work from the meter to the appliance must be of adequate size. Pipes of a smaller size than the appliance gas inlet connection must not be used. The installation must be tested for soundness in accordance with BS 6891. If the gas supply serves more than one appliance, it must be ensured that an adequate supply is maintained to each appliance when they are in use at the same time.

NOTE: It is recognised that 'pressure loss' through the gas cock and gas valve may result in a pressure drop of approximately 2mbar between the gas meter and gas valve inlet test point; this will not impair the performance of the appliance, provided that a dynamic pressure of 18mbar is available at the appliance inlet.

4.4 FLUE SYSTEM

The terminal should be located where the dispersal of combustion products is not impeded and with due regard for the damage and discoloration that may occur to building products located nearby. The terminal must not be located in a place where it is likely to cause a nuisance (see fig. 5). In cold and/or humid weather, water vapour will condense on leaving the terminal; the effect of such plumbing must be considered.

If installed less than 2m above a pavement or platform to which people have access (including balconies or flat roofs) the terminal must be protected by a guard of durable material. The guard must be fitted centrally over the terminal. Refer to BS 5440 Part 1, when the terminal is 0.5 metres (or less) below plastic guttering or 1 metre (or less) below painted eaves.

4.5 AIR SUPPLY

The following notes are intended for general guidance only. This appliance is a room-sealed, fan-flued boiler, consequently it does not require a permanent air vent for combustion air supply. When installed in a cupboard or compartment, ventilation for cooling purposes is also not required.

4.6 WATER CIRCULATION

Detailed recommendations are given in BS EN 12828 and BS 6798. The following notes are for general guidance only.

4.6.1 PIPEWORK

It is recommended that copper tubing to BS 2871 Part 1 is used in conjunction with soldered capillary joints. Where possible pipes should have a gradient to ensure air is carried naturally to air release points and that water flows naturally to drain cocks. Except where providing useful heat, pipes should be insulated to avoid heat loss and in particular to avoid the possibility of freezing. Particular attention should be paid to pipes passing through ventilated areas such as under floors, loft space, and void areas.

4.6.2 AUTOMATIC BY-PASS

The appliance has a built-in automatic by-pass, consequently there is no requirement for an external by-pass, however the design of the system should be such that it prevents boiler 'cycling'.

4.6.3 DRAIN COCKS

These must be located in accessible positions to facilitate draining of the appliance and all water pipes connected to the appliance. The drain cocks must be manufactured in accordance with BS 2879.

4.6.4 AIR RELEASE POINTS

These must be positioned at the highest points in the system where air is likely to be trapped. They should be used to expel trapped air and allow complete filling of the system.

4.6.5 EXPANSION VESSEL

The appliance has an integral expansion vessel to accommodate the increased volume of water when the system is heated. Refer to the specification table for more detailed information.

4.6.6 FILLING POINT

A method for initial filling of the system and replacing water lost during servicing etc. directly from the mains supply, should be provided (see fig. 6). This method of filling complies with the current Water Supply (Water Fittings) Regulations 1999 and Water Bylaws 2000 (Scotland).

4.6.7 LOW PRESSURE SEALED SYSTEM

An alternative method of filling the system would be from an independent make-up vessel or tank mounted in a position at least 1 metre above the highest point in the system and at least 5 metres above the boiler (see fig. 7).

The cold feed from the make-up vessel or tank must be fitted with an approved non-return valve and stopcock for isolation purposes. The feed pipe should be connected to the return pipe as close to the boiler as possible.

4.6.8 FREQUENT FILLING

Frequent filling or venting of the system may be indicative of a leak. Care should be taken during the installation of the appliance to ensure all aspects of the system are capable of withstanding pressures up to at least 3 bar.

4.7 ELECTRICAL SUPPLY

The appliance is supplied for operation on 230V @ 50Hz electrical supply; it must be protected with a 3-amp fuse (supplied). The method of connection to the mains electricity supply must allow for complete isolation from the supply. The preferred method is by using a double-pole switch with a contact separation of at least 3mm. The switch must only supply the appliance and its corresponding controls, i.e. time clock, room thermostat, etc. Alternatively an un-switched shuttered socket with a fused 3-pin plug both complying with BS 1363 is acceptable.

Warning!

This appliance must be earthed.

4.8 MOUNTING ON A COMBUSTIBLE SURFACE

The appliance can be mounted on a wall of combustible material without any requirement to fit any additional protective (fire-resistant) material.

4.9 TIMBER FRAMED BUILDINGS

If the appliance is to be fitted in a timber framed building, it should be fitted in accordance with the Institute of Gas Engineers publication (IGE/UP/7) 'Guide for Gas Installations in Timber Frame Buildings'.

4.10 WATER TREATMENT

Vokera recommend that water treatment be carried out in accordance with the Benchmark Guidance on water treatment in central heating systems. If water treatment products are to be used, then they must be entirely suitable for use with a stainless steel heat exchanger. Any water treatment product, must be administered in strict accordance with the manufacturer's instructions.

If the appliance is to be installed to an existing system; water treatment and flushing of the complete heating system should be carried out in accordance with BS 7593 and the Benchmark Guidance on water treatment in central heating systems.

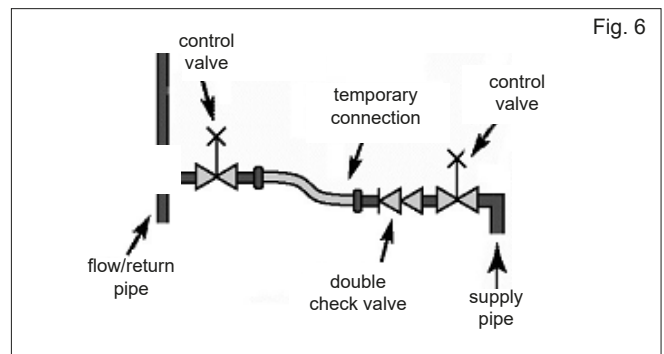

Fig. 6

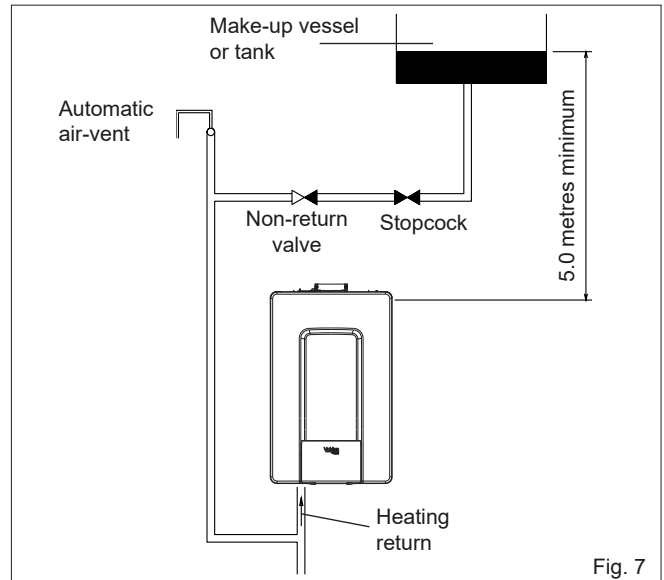

Fig. 7

4A. SECTION - GENERAL REQUIREMENTS (EIRE)

This appliance must be installed by a competent person in accordance with and defined by, the Standard Specification (Domestic Gas Installations) Declaration (I.S. 813).

4A.1 RELATED DOCUMENTS

The installation of this boiler must be in accordance with the relevant requirements of the local building regulations, the current ETCI National Rules for Electrical Installations, and the bylaws of the local water undertaking.

It should be in accordance also with any relevant requirements of the local and/or district authority.

4A.2 LOCATION OF APPLIANCE

The appliance may be installed in any room or internal space, although particular attention is drawn to the requirements of the current ETCI National Rules for Electrical Installations, and I.S. 813, Annex K.

When an appliance is installed in a room or internal space containing a bath or shower, the appliance or any control pertaining to it must not be within reach of a person using the bath or shower.

The location chosen for the appliance must permit the provision of a safe and satisfactory flue and termination. The location must also permit an adequate air supply for combustion purposes and an adequate space for servicing and air circulation around the appliance. Where the installation of the appliance will be in an unusual location special procedures may be necessary, refer to I.S. 813 for detailed guidance on this aspect.

A compartment used to enclose the appliance must be designed and constructed specifically for this purpose. An existing compartment/cupboard may be utilised provided that it is modified to suit.

This appliance is not configured for external installation.

4A.3 GAS SUPPLY

The gas meter – as supplied by the gas supplier – must be checked to ensure that it is of adequate size to deal with the maximum rated input of all the appliances that it serves. Installation pipes must be fitted in accordance with I.S. 813.

Pipe work from the meter to the appliance must be of adequate size. Pipes of a smaller size than the appliance gas inlet connection must not be used. The installation must be tested for soundness in accordance with I.S. 813.

If the gas supply serves more than one appliance, it must be ensured that an adequate supply is maintained to each appliance when they are in use at the same time.

NOTE

It is recognised that 'pressure loss' through the gas cock and gas valve may result in a pressure drop of approximately 2mbar between the gas meter and gas valve inlet test point; this will not impair the performance of the appliance, provided that a dynamic pressure of 18mbar is available at the appliance inlet.

4A.4 FLUE SYSTEM

The terminal should be located where the dispersal of combustion products is not impeded and with due regard for the damage and discoloration that may occur to building products located nearby. The terminal must not be located in a place where it is likely to cause a nuisance (see I.S. 813).

In cold and/or humid weather, water vapour will condense on leaving the terminal; the effect of such plumbing must be considered.

If installed less than 2m above a pavement or platform to which people have access (including balconies or flat roofs) the terminal must be protected by a guard of durable material. The guard must be fitted centrally over the terminal. Refer to I.S. 813, when the terminal is 0.5 metres (or less) below plastic guttering or 1 metre (or less) below painted eaves.

4A.5 AIR SUPPLY

The following notes are intended for general guidance only. This appliance is a room-sealed, fan-flued boiler, consequently it does not require a permanent air vent for combustion air supply. When installed in a cupboard or compartment, ventilation for cooling purposes is also not required.

4A.6 WATER CIRCULATION

Specific recommendations are given in I.S. 813. The following notes are for general guidance only.

4A.6.1 PIPEWORK

It is recommended that copper tubing be used in conjunction with soldered capillary joints..

Where possible pipes should have a gradient to ensure air is carried naturally to air release points and that water flows naturally to drain cocks.

Except where providing useful heat, pipes should be insulated to avoid heat loss and in particular to avoid the possibility of freezing. Particular attention should be paid to pipes passing through ventilated areas such as under floors, loft space, and void areas.

4A.6.2 AUTOMATIC BY-PASS

The appliance has a built-in automatic by-pass, consequently there is no requirement for an external by-pass, however the design of the system should be such that it prevents boiler 'cycling'.

4A.6.3 DRAIN COCKS

These must be located in accessible positions to facilitate draining of the appliance and all water pipes connected to the appliance.

4A.6.4 AIR RELEASE POINTS

These must be positioned at the highest points in the system where air is likely to be trapped. They should be used to expel trapped air and allow complete filling of the system.

4A.6.5 EXPANSION VESSEL

The appliance has an integral expansion vessel to accommodate the increased volume of water when the system is heated. Refer to the specification table for more detailed information.

4A.6.6 FILLING POINT

A method for initial filling of the system and replacing water lost during servicing etc. should be provided (see fig. 6). You should ensure this method of filling complies with the local water authority regulations.

4A.6.7 LOW PRESSURE SEALED SYSTEM

An alternative method of filling the system would be from an independent make-up vessel or tank mounted in a position at least 1 metre above the highest point in the system and at least 5 metres above the boiler (see fig. 7). The cold feed from the make-up vessel or tank must be fitted with an approved non-return valve and stopcock for isolation purposes. The feed pipe should be connected to the return pipe as close to the boiler as possible.

4A.6.8 FREQUENT FILLING

Frequent filling or venting of the system may be indicative of a leak. Care should be taken during the installation of the appliance to ensure all aspects of the system are capable of withstanding pressures up to at least 3 bar.

4A.7 ELECTRICAL SUPPLY

The appliance is supplied for operation on 230V @ 50Hz electrical supply; it must be protected with a 3-amp fuse (supplied). The method of connection to the mains electricity supply must allow for complete isolation from the supply. The preferred method is by using a double-pole switch with a contact separation of at least 3mm. The switch must only supply the appliance and its corresponding controls, i.e. time clock, room thermostat, etc. Alternatively an un-switched shuttered socket with a fused 3-pin plug both complying with BS 1363 is acceptable.

Warning!

This appliance must be earthed.

4A.8 MOUNTING ON A COMBUSTIBLE SURFACE

The appliance can be mounted on a wall of combustible material without any requirement to fit any additional protective (fire-resistant) material.

4A.9 TIMBER FRAMED BUILDINGS

If the appliance is to be fitted in a timber framed building, it should be fitted in accordance with I.S. 813 and local Building Regulations.

The Institute of Gas Engineers publication (IGE/UP/7) 'Guide for Gas Installations in Timber Frame Buildings' gives specific advice on this type of installation.

4A.10 WATER TREATMENT

Vokera recommend that water treatment be carried out in accordance with the Benchmark Guidance on water treatment in central heating systems. If water treatment products are to be used, then they must be entirely suitable for use with a stainless steel heat exchanger. Any water treatment product, must be administered in strict accordance with the manufacturer's instructions.

If the appliance is to be installed to an existing system; water treatment and flushing of the complete heating system should be carried out in accordance with BS 7593 and the Benchmark Guidance on water treatment in central heating systems.

4A.11 DECLARATION OF CONFORMITY

A Declaration of Conformity (as defined in I.S. 813) must be provided on completion of the installation.

A copy of the declaration must be given to the responsible person and also to the gas supplier if required.

5. SECTION - INSTALLATION

NOTE: please refer to section 4, section 4.1 and use the appropriate PPE when carrying out any of the actions or procedures contained within this section.

5.1 DELIVERY

Due to the weight of the appliance it may be necessary for two people to lift and attach the appliance to its wall bracket. The appliance is contained within a heavy-duty cardboard carton. Lay the carton on the floor with the writing the correct way up.

5.2 CONTENTS

Contained within the carton is:

- the boiler
- the wall bracket
- carton template
- an accessories pack containing appliance service connections and washers
- the instruction pack containing the installation, servicing & user instructions, guarantee registration card and a 3-amp fuse.

5.3 UNPACKING

At the top of the carton pull both sides open – do not use a knife – unfold the rest of the carton from around the appliance, carefully remove all protective packaging from the appliance and lay the accessories etc. to one side. Protective gloves should be used to lift the appliance, the appliance back-frame should be used for lifting points.

5.4 PREPARATION FOR MOUNTING THE APPLIANCE

The appliance should be mounted on a smooth, vertical, surface, which must be capable of supporting the full weight of the appliance. Care should be exercised when determining the position of the appliance with respect to hidden obstructions such as pipes, cables, etc.

When the position of the appliance has been decided – using the template supplied – carefully mark the position of the wall mounting bracket and flue-hole (if applicable).

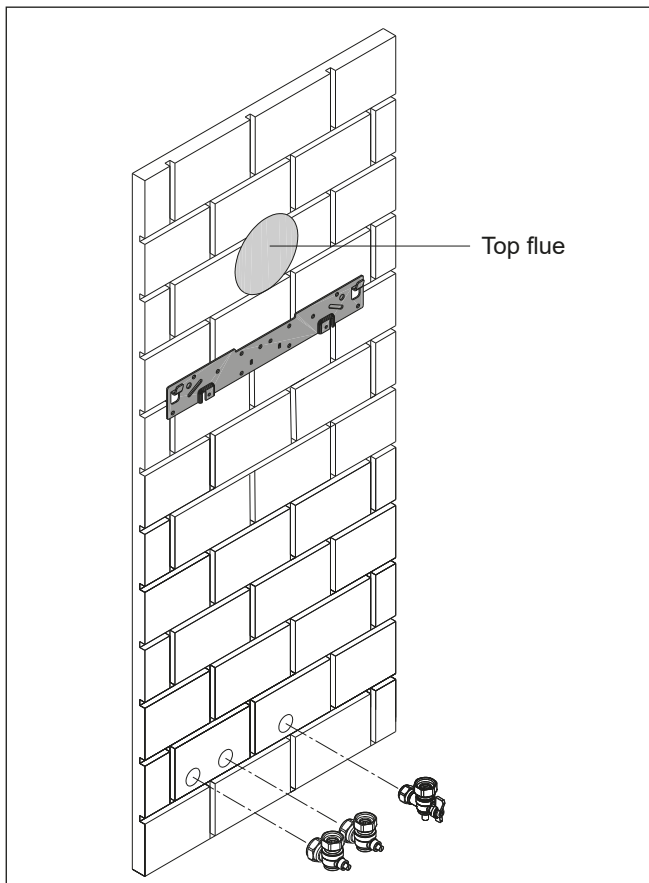

5.5 FITTING THE FLUE

This appliance incorporates a 'click-fit' flue connection at the top of the appliance.

5.5.1 CONCENTRIC HORIZONTAL FLUE

These instructions relate specifically to the installation of this appliance with the Vokera 60/100mm 'X-type' (click-fit) flue terminals and accessories. For specific instructions on installing this appliance with an alternative Vokera flue system, e.g. 80/125mm; please refer to the instructions supplied with the specific flue system, or download the instructions from the Vokera website. The appliance flue outlet elbow can be rotated through 360° on its vertical axis. In addition the flue may be extended from the outlet elbow in the horizontal plane (see 2.9). A reduction must also be made to the maximum length (see table below) when additional bends are used.

Reduction for additional bends

Bend	Reduction in maximum flue length for each bend
45° bend	1.0 metre
90° bend	1.0 metre

Horizontal flue terminals and accessories

Code	Description	Length
20122759	XF standard horizontal flue kit	TBC
20122761	XT telescopic flue kit	TBC
29450123	90-degree bend	N/A
29450124	45-degree bends (2)	N/A
29450125	500mm extension	500mm
29450126	1000mm extension	1000mm
29450127	2000mm extension	2000mm
29450128	Telescopic extension	372/519mm
522	Plume management kit	1370mm
529	100mm flue brackets (5)	N/A

Using the template provided (A), mark and drill a 125mm hole for the passage of the flue pipe. Each horizontal terminal, incorporates an incline on the inner (60mm) pipe; this enables the terminal to be installed on a level plane. However any extended horizontal flue runs must incorporate a 3-degree fall-back from the flue terminal towards the appliance. The fixing holes for the wall-mounting bracket should now be drilled and plugged, an appropriate type and quantity of fixing should be used to ensure that the bracket is mounted securely. Once the bracket has been secured to the wall, mount the appliance onto the bracket.

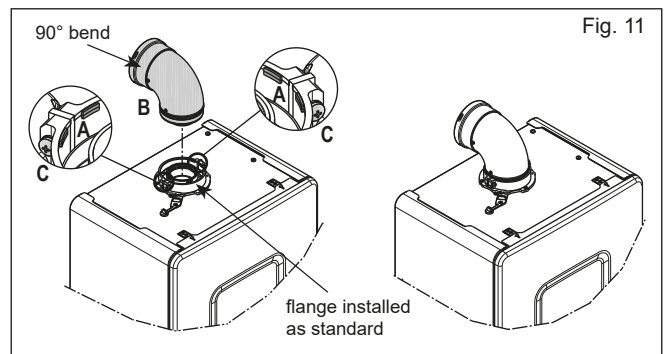

FITTING THE HORIZONTAL FLUE KIT

Carefully measure the distance from the centre of the appliance flue outlet to the edge of the finished outside wall (dimension X). Add 65mm to dimension X to give you Dimension Y (see fig. 12). Measure dimension Y from the terminal end of the concentric flue pipe and cut off the excess ensuring any burrs are removed.

IMPORTANT: The X-type flue terminals are supplied with a sachet of silicone lubricant; smear a small amount of the lubricant around both inner and outer connections, at both ends of the flue bend.

NOTE: Attach the decorative white plastic trim to the flue pipe at this point if it's required.

Attach the flue bend to the flue terminal ensuring that both pipes are fully inserted into the flue bend. Insert the assembled flue terminal and bend into the pre-drilled hole and offer up the flue bend to the appliance flue spigot.

NOTE: The appliance incorporates a 'click-fit' flue connection (see fig. 11). Ensure that both screws 'C' (fig. 11) on the 'click-fit' have been slackened off. Ensure that the bend is correctly aligned with the connector and insert the flue bend into the connector until it clicks into position (this is when the tabs at points 'A' are located in the groove of the flue bend - see fig. 11). Both screws (C) should now be tightened.

NOTE: If more convenient, the flue bend can be attached to the appliance before connecting it to the flue terminal.

NOTE: Ensure that the outlet of the flue terminal is correctly orientated as shown in fig. 12.

NOTE

You must ensure that the entire flue system is properly supported and connected. Seal the flue assembly to the wall using cement or a suitable alternative that will provide satisfactory weatherproofing. The exterior trim can now be fitted.

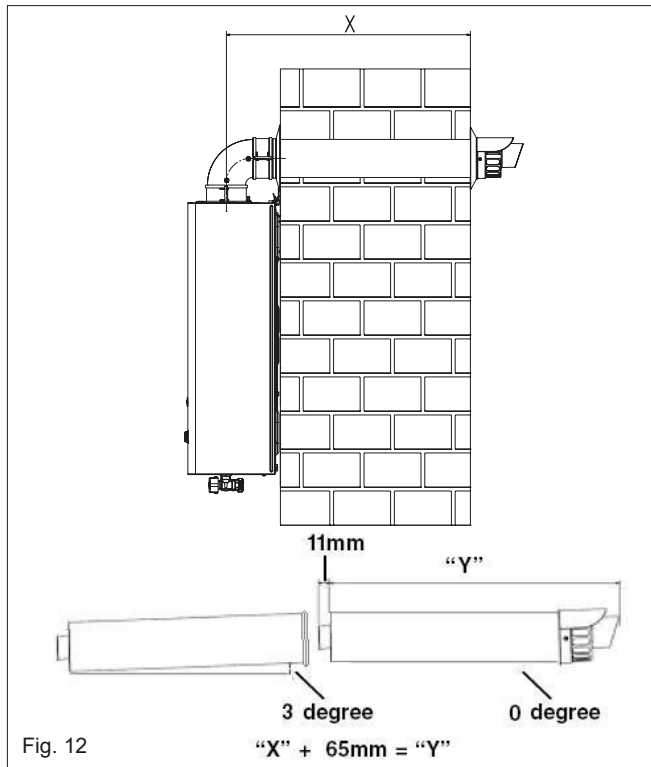

Fig. 12

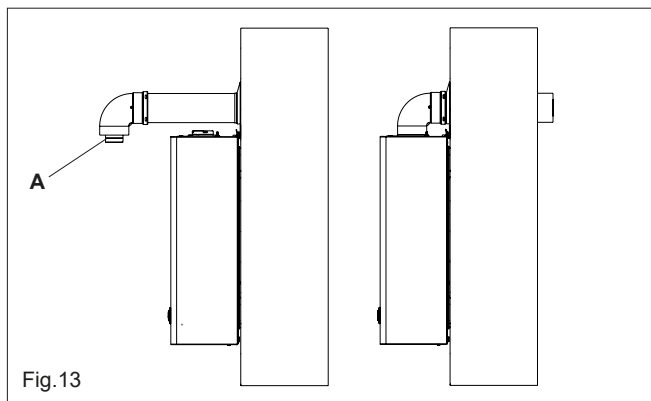

Fig. 13

EXTENDING THE FLUE

Connect the bend - supplied with the flue terminal - to the appliance 'click-fit' connector.

IMPORTANT: The X-type flue terminals are supplied with a sachet of silicone lubricant; smear a small amount of the lubricant around both inner and outer connections, at both ends of the flue bend.

NOTE: The appliance incorporates a 'click-fit' flue connection (see fig. 11). Ensure that both screws 'C' (fig. 11) on the 'click-fit' have been slackened off. Ensure that the bend is correctly aligned with the connector and insert the flue bend into the connector until it clicks into position (this is when the tabs at points 'A' are located in the groove of the flue bend - see fig. 11). Both screws (C) should now be tightened. The additional

bends & extensions have push-fit connections, care should be taken to ensure that the correct seal is made when assembling the flue system. Connect the required number of flue extensions or bends (up to the maximum equivalent flue length) to the flue terminal (see fig. 11-14). The flue system should have a 3° rise from the boiler to outside, to ensure any condense fluid that forms, is allowed to drain back to the appliance.

NOTE

When cutting an extension to the required length, you must ensure that the excess is cut from the plain end of the extension (see fig. 11-14). Remove any burrs, and check that all seals are located properly. You must ensure that the entire flue system is properly supported and connected. Seal the flue assembly to the wall using cement or a suitable alternative that will provide satisfactory weatherproofing. The interior and exterior trim can now be fitted.

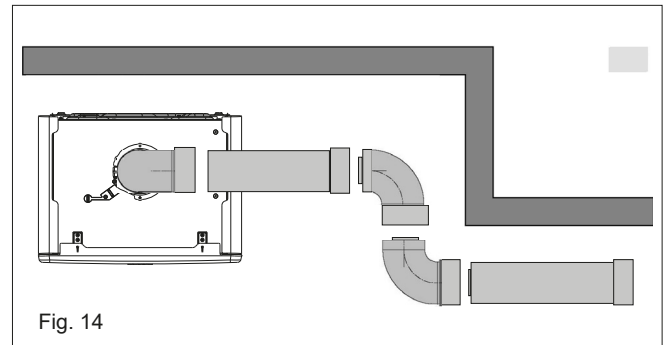

Fig. 14

5.5.2 CONCENTRIC VERTICAL FLUE

Using fig.19 as a reference, cut a 110mm diameter hole in the roof and/or ceiling to facilitate the route of the vertical flue system. **NOTE:** ensure that the top of the appliance - if already in position - is covered and protected from the possibility of any dust or debris falling or entering the appliance via the flue outlet.

Fit the appropriate flashing to the roof and insert the vertical flue terminal through the flashing from outside, ensuring that the collar of the terminal is located over the outlet of the flashing.

The fixing holes for the appliance wall mounting bracket should now be drilled and plugged. An appropriate type and quantity of fixing should be used to ensure that the bracket is mounted securely. Once the bracket has been secured to the wall, mount the appliance onto the bracket.

If the vertical flue system requires additional extensions or bends, connect these to the vertical terminal, ensuring the following:

- the maximum permitted flue length is not exceeded
- reductions to the maximum flue length have been made for any bends that are used on the vertical flue system
- any horizontal sections of the flue system, incorporate a 3-degree fallback to the appliance
- the entire flue system is fully supported and secured using the appropriate brackets
- if/when an extension is cut to a shorter length, ensure that the excess length is cut from the plain end of the extension, and that any burrs or rough edges are removed
- all seals are properly located before assembling or connecting the flue system.

IMPORTANT: The VX flue terminal is supplied with a sachet of silicone lubricant; smear a small amount of the lubricant around both inner and outer connections, at both ends of the vertical flue connector (supplied with the VX terminal).

NOTE: The appliance incorporates a 'click-fit' flue connection (see fig. 18). Ensure that both screws 'C' (fig. 11) on the 'click-fit' have been slackened off. Ensure that the connector is correctly aligned with the 'click-fit' and insert it into the 'click-fit' until it clicks into position (this is when the tabs at points 'A' are located in the groove of the vertical flue connector - see fig. 18). Both screws (C) should now be tightened.

NOTE: If more convenient, the vertical flue connector can be attached to the vertical flue terminal/extension before connecting it to the appliance.

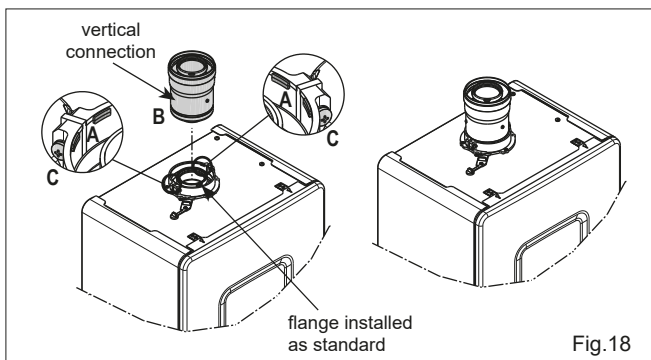

Fig.18

NOTE

Additional bends and/or extensions can be connected to the terminal connector if desired, however if additional bends are fitted, a reduction must be made to the maximum flue length (see table below).

Reduction for bends

Bend	Reduction in maximum flue length for each bend
45° bend	1.0 metre
90° bend	1.0 metre

Vertical flue terminal and accessories

Code	Description	Length
20122763	Vokera XV Vertical Flue kit	1000mm
29450123	90-degree bend	N/A
29450124	45-degree bends (2)	N/A
29450125	500mm extension	500mm
29450126	1000mm extension	1000mm
29450127	2000mm extension	2000mm
29450128	Telescopic extension	372/519mm
529	100mm flue brackets (5)	N/A
531	Pitched roof flashing	N/A
532	Flat roof flashing	N/A

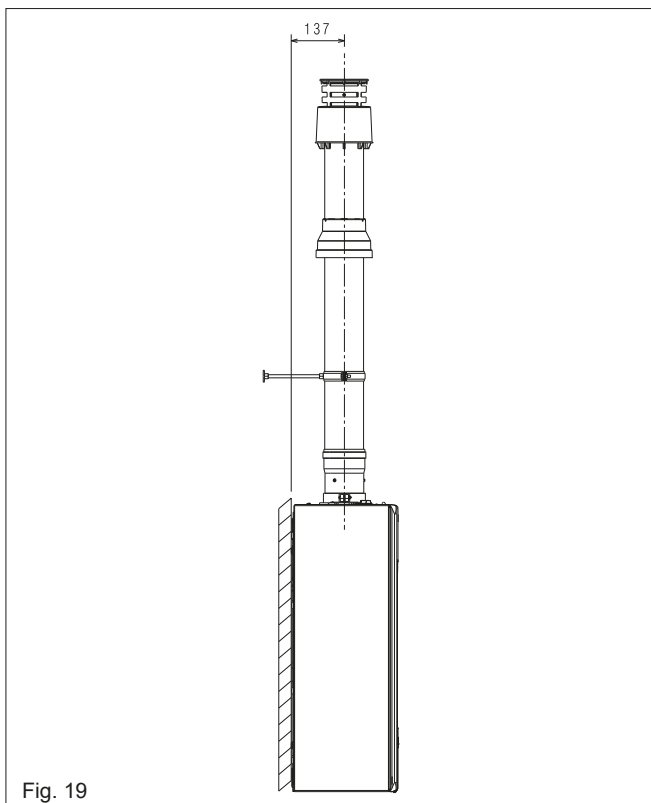

Fig. 19

IMPORTANT

The vertical flue terminal is 1.0 metre in length and cannot be cut; therefore it may be necessary to adjust the height of the appliance to suit or use a suitable extension.

5.6 CONNECTING THE GAS AND WATER (fig. 20)

The appliance is supplied with an accessory pack that includes service valves. The service valves are of the compression type. The accessory pack contains sealing washers' etc, for use with the service valves. When connecting pipe work to the valves, tighten the compression end first then insert the sealing washers before tightening the valve to the appliance.

NOTE

It will be necessary to hold the valve with one spanner whilst tightening with another.

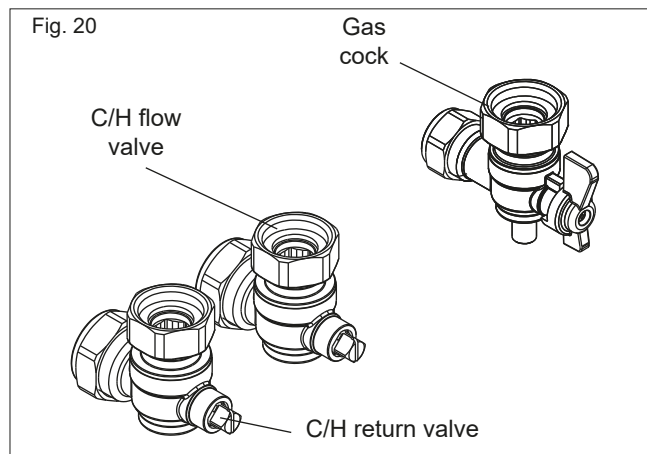

5.6.1 GAS

The appliance is supplied with a 15mm service valve, connect a 15mm pipe to the inlet of the valve and tighten both nuts.

NOTE

It will be necessary to calculate the diameter of the gas supply pipe to ensure the appliance has an adequate supply of gas.

5.6.2 FLOW & RETURN

The appliance is supplied with 22mm service valves for the flow and return connections, connect a 22mm pipe to the inlet of each valve and tighten both nuts.

NOTE

Depending on system requirements, it may necessary to increase the size of the flow & return pipe work after the service valve connections.

5.6.3 SAFETY VALVE

The appliance incorporates a combined safety discharge and condensate discharge arrangement. Consequently the combined discharge pipe must have a continuous fall away from the appliance and should be suitably protected against the risk of freezing.

Alternatively it is permissible to fit a tundish, e.g. Mactun, Hotun, etc. close to or adjacent to the discharge pipe where it exits the appliance.

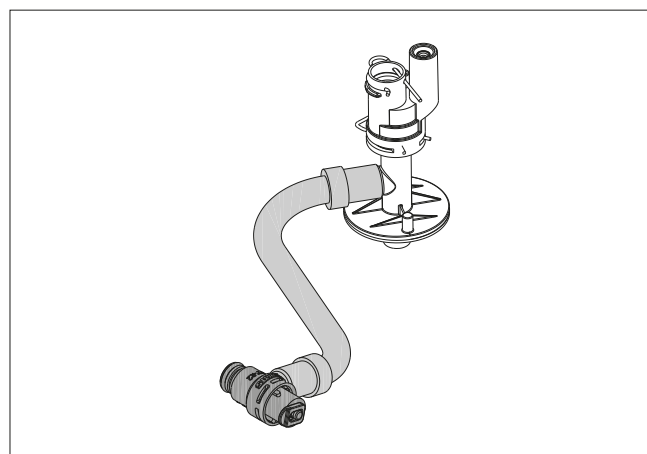

5.6.4 COMBINED PRV & CONDENSATE DISCHARGE PIPE

This appliance will - under normal operating conditions - produce condensate fluid that will require to be disposed of via the dwelling's waste water drainage system. Vokera strongly recommends that the condensate pipe is connected to the internal waste water pipework in accordance with BS6798.

BS6798 provides comprehensive instruction and advice on all permissible condensate disposal methods; notwithstanding this, it is essential that the following is strictly adhered to:

- use only plastic drainage pipe (minimum OD of 21.5mm)
- horizontal runs must incorporate a minimum 45mm fall per metre, away from the appliance
- external pipework and/or pipework in unheated areas, must have a minimum OD of 32mm and be insulated with Class-O pipe insulation
- the route, type, and termination of the condensate disposal method, must not permit any spillage of condensate fluid, into the dwelling in the event of a blockage or freezing of the condensate pipework
- if there is a risk of freezing, Vokera strongly recommends that a tundish is incorporated within the discharge pipework (see 5.6.3 above).

Should it not be possible to route and terminate the condensate pipework internally using 'gravity discharge'; Vokera recommends that the Vokera condensate pump (code 404) be considered as an alternative solution.

Ensure that the end-user is aware of the effect/consequences of the condensate pipework becoming blocked or frozen.

5.7 ELECTRICAL CONNECTIONS

The boiler is supplied with a fly-lead. This lead can be used for connection to the electrical supply. Connect the fly-lead to a fused plug or fused isolator in the following way:

- brown wire to LIVE supply
- blue wire to NEUTRAL supply
- green/yellow to EARTH connection.

Insert the supplied 3-AMP fuse into the fused isolator or fused plug. Should the fly-lead be unsuitable, refer to section 5.7.3 for details on how to connect the electrical supply directly to the boiler.

The electrical supply must be as specified in section 4/4A. A qualified electrician should connect the appliance to the electrical supply. If controls - external to the appliance - are required, a competent person must undertake the design of any external electrical circuits, please refer to section 8 for detailed instructions. ANY EXTERNAL CONTROL OR WIRING MUST BE SERVED FROM THE SAME ISOLATOR AS THAT OF THE APPLIANCE. The supply cable from the isolator to the appliance must be 3-core flexible sized 0.75mm to BS 6500 or equivalent. Wiring to the appliance must be rated for operation in contact with surfaces up to 90 °C.

ModBus 485 Connection (CE4)

Carry out the connections as follows:

- use connector CE4 supplied as standard:
 - 4-poles ModBus connector for BUS 485 (- A B +)

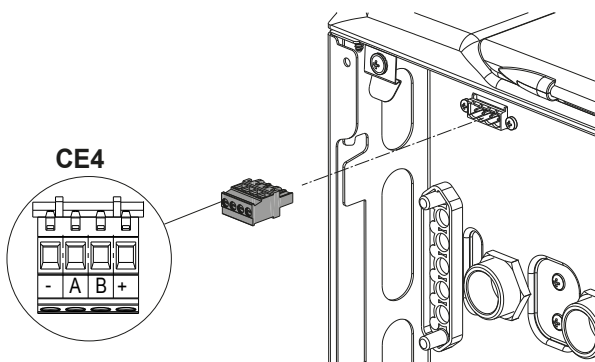

SE - OT+ connections

- Remove front cover as detailed in 5.7.1.
- Remove PCB cover (see diagram).
- Locate 4-pole terminal block (M4) connected to PCB at X11 (see diagram).
- Connect external sensor to terminals marked 'SE' (see diagram).
- Connect Opentherm control to terminals marked 'OT' (see diagram).
- Replace PCB cover and appliance front cover as detailed in 5.7.1.

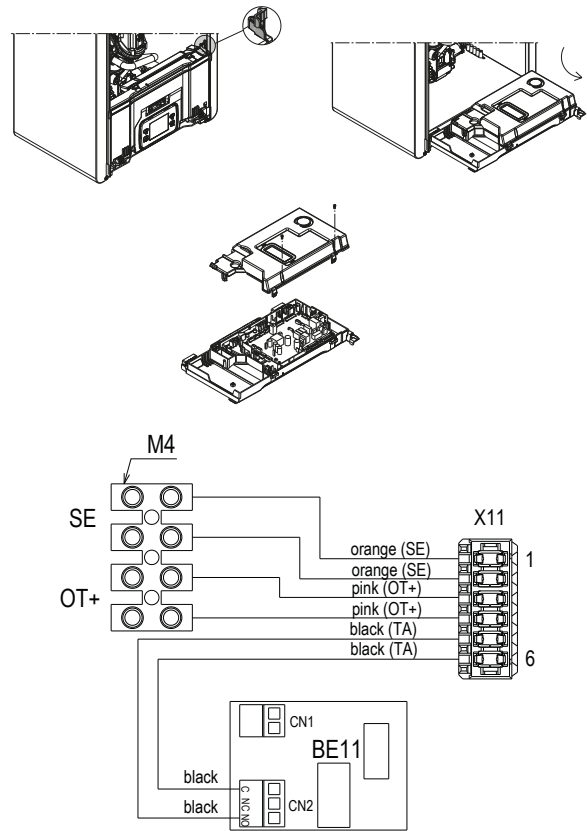

SWITCHED LIVE CONNECTION

Should it be necessary/required to control the appliance using a 230V supply from an external control or wiring centre; the switched supply (L&N) must be connected to the relay board BE11 at terminals CN1.

See above diagram and also Section 7 (7.11 & 7.12).

Opentherm Control

When an OT control is connected to the appliance, the UI screen will display 'Opentherm Connected'. The control functions of the appliance UI will be transferred to the OT control, which can then be used to set/adjust the main heating zone settings and the hot water settings.

UI Functions When OT Control is Connected

STATE function is disabled on the UI and must be set/adjusted via the OT control. The outlet HW temperature cannot be adjusted via the appliance UI, and is set/adjusted via the OT control.

INFO Menu

When an OT control is connected, the info menu will display the HW set-point instead of the HW flow-rate.

NOTE

All/any functions of the 'main' zone are disabled on the appliance UI and can only be accessed/adjusted via the OT control.

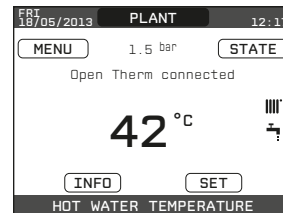

5.7.1 FRONT COVER REMOVAL

Refer to fig. 23.

- Locate and remove screws 'A' that secure the spring clips to the underside of the appliance.
- Gently unclip the spring clips 'C' and pull the front cover outwards and then upwards in order to disengage it from the tabs 'B' at the top of the appliance.
- Place the front cover in a safe area to avoid any risk of damage.
- Replace in the reverse order.

REMOVAL OF SIDE PANEL/S

Remove the front cover as indicated above:

- locate and remove the 2-screws that secure the side panel to the appliance
- gently prise the side panel forward to release it from the securing tabs on the appliance rear
- replace in the reverse order.

WARNING

! **DO NOT** remove the 'side' panels if/when the appliance has been installed to within the minimum clearances, i.e. 2mm.

When refitting the side panels, it is essential that the LH panel is fitted to the left side and the RH panel is fitted to the right side (refer to the attached label).

! **The front cover and side panels are an intrinsic part of the 'room-sealed' element of the appliance; any damage that results in a loss of their integrity will require the replacement of the cover.**

! **The noise absorbing panels that are located inside the front cover and side panels also act as seals to ensure airtightness and the room-sealed integrity of the appliance. It is essential that these are correctly positioned during the refitting of the front cover and/or side panels. Any subsequent damage or deterioration to the noise absorbing panels must be rectified before the appliance is put back into service.**

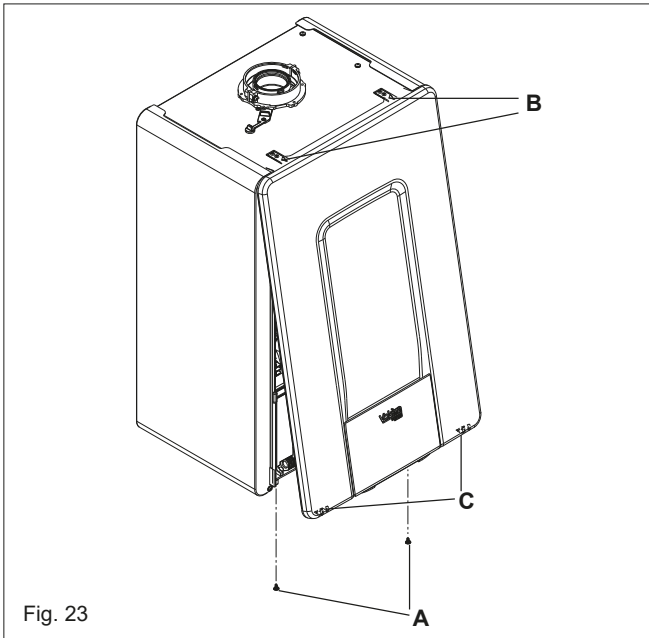

Fig. 23

5.7.2 APPLIANCE MAIN ELECTRICAL SUPPLY INPUT

The appliance is supplied with an electrical fly-lead (approx. 1.5m long) and the BE11 board has a link wire inserted across the TA terminals; these measures enable the basic function of the appliance once the fly-lead is connected to the electrical supply. However if this is not suitable, then it is possible to remove and replace the 'fly-lead' with an alternative method of connection to the electrical supply.

5.7.3 CONNECTING A 230V SUPPLY TO THE APPLIANCE PCB

WARNING

Isolate the appliance from the electrical supply before carrying out this procedure.

Remove the front cover as detailed in 5.7.1. Locate the red clip that retains the control panel in the upright position and move it to the left to release the control panel.

Lower the control panel and remove the two PCB cover retaining screws (located adjacent to the PCB's front retaining clips). Push in the two front clips, and pull out the side clip in order to release the cover and then remove the cover - lifting from the front upwards.

The 230v electrical supply input is located at the rear right hand side of the PCB (see section 8 schematics); disconnect and remove the factory-fitted fly-lead, and use the same cable-entry point, route, and respective electrical terminals for the new 230v supply cable.

NOTE

Ensure that the Earth wire is approximately 30mm longer than the Live and Neutral wires and that each terminal screw is tight.

Carry out any relevant electrical checks as detailed in 8.5 before replacing the PCB cover; ensuring that no cables or wiring is trapped.

Refit the PCB cover screws and move the control panel back to the upright position ensuring the red securing clip, clicks into place.

Replace the appliance front cover as detailed in 5.7.1 paying attention to the importance of ensuring the cover is providing an effective seal.

NOTE

It is the installer and/or electrician's responsibility to ensure that the appliance properly earthed. Vokera Ltd. cannot be held responsible for any damages and/or injuries that result from the incorrect wiring of the appliance; or from an ineffective/defective Earth connection.

6. SECTION - COMMISSIONING

NOTE: please refer to section 4, section 4.1 and use the appropriate PPE when carrying out any of the actions or procedures contained within this section.

6.1 PRELIMINARY CHECKS

Before starting up the boiler, check:

- confirm via the appliance data badge, that the appliance is suitable/configured for the gas type and electrical supply that has been provided to the appliance
- inspect the entire flue system and ensure that it has been installed in accordance with these instructions and the relevant standards that apply locally and/or nationally
- that the required clearances have been met in respect of the requirements for maintenance
- inspect the entire installation including the gas meter, test for tightness and purge. Refer to BS 6891 (I.S. 813 in ROI) for specific instruction
- ensure that the rated delivery of the gas meter is adequate enough to serve this appliance and any other gas appliance connected to the same meter
- ensure that the gas supply pipework is of adequate size to provide the maximum gas rate required by this appliance.

6.1.1 FIRST IGNITION ERRORS

- Ensure that the gas supply is ON, water supply is ON, and electrical supply is ON. Ensure that the system pressure is at least 0.6 bar.
- Pump rotator shaft seized (possible alarm code E020 and no circulation within boiler/heating system); this can occur if the appliance has been stored or inactive for a prolonged period.
- To 'release' the seized rotator shaft:
 - remove front cover as detailed in 5.7.1
 - set the boiler to OFF

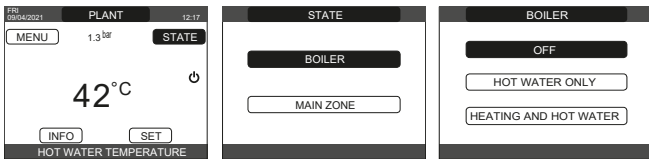

- follow in sequence a-b

! Perform this operation with extreme caution to avoid damaging the components.

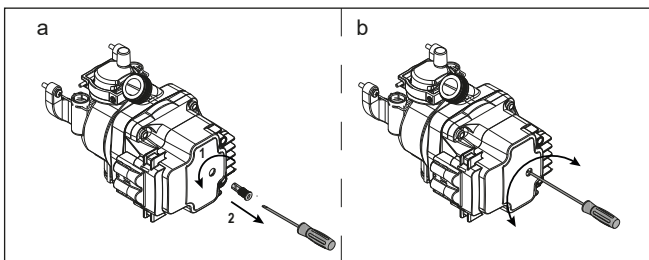

- replace the front cover as detailed in 5.7.1 ensuring correct seal.

6.2 PROGRAMMING THE BOILER

- Position the system's main switch to the "on" position. The boiler display looks like this:

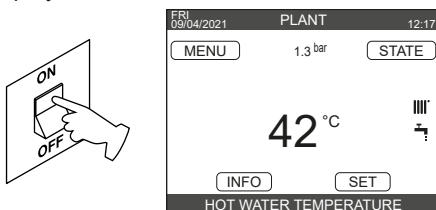

- In some cases it may be necessary to set the TIME and DATE; in this case the machine interface request you to carry out the operation with the message "SET TIME AND DATE". Navigate with the keys to set the values.

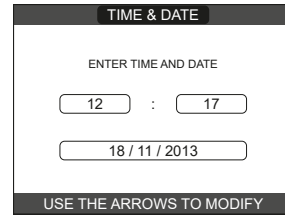

- **Note:** it is possible to change the TIME and DATE, DAYLIGHT SAVINGS TIME settings, as well as LANGUAGE and the duration of the back-lighting, at any time by entering the MENU from the main screen and then selecting SETTINGS.
- The device automatically manages the change of time from solar to daylight savings time and vice versa.

! Whenever the power supply to the appliance is interrupted and then restored, an automatic venting cycle is carried out lasting 6 min. To interrupt the vent cycle, carry out the procedure explained in the section 6.3.

- Set the boiler to OFF from REC10CH selecting STATE

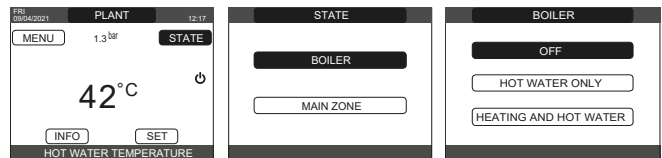

- Through the REC10CH it is possible to access, using the TECHNICAL menu, a series of parameters that can be programmed to allow you to personalise the operation of the boiler based on the type of system. There are 3 access levels: USER, INSTALLER and SERVICE (see "3.1 Structure of the REC10CH MENU").
- Access the parameters and set the operation according to your type of system.

6.2.1 BOILER CONFIGURATION

The REC10 UI is supplied with a default configuration that enables a standard type of external control, e.g. room thermostat & clock, programmable room thermostat, etc. to be connected to the appliance or alternatively the Vokera BeSMART OT+ control. Alternatively and if desired the embedded 7-day clock can be enabled (default is disabled) to control the ON/OFF time schedule for the central heating. In order to enable the embedded clock, it is necessary to access the 'INSTALLATION' parameters as defined in section 8.

NOTE

Do not enable the embedded clock if another type of timing control, e.g. time clock, programmable room thermostat, etc. is – or will be – connected to the appliance, in order to manage the heating timing schedule. The following functions can also be accessed and adjusted via the installer parameters (see section 8) if required/necessary.

NOTE

The 'installer' parameters should only be accessed and adjusted by suitably qualified personnel.

- Select PARAMETERS.

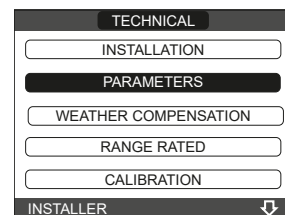

- Select from among the following options, confirming the selection.

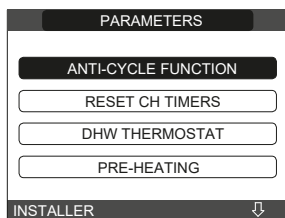

- **ANTI-CYCLE FUNCTION:** once the setpoint has been reached the burner will cycle on and off until an external control, e.g. time clock cancels the heating request. This function imposes a set time between the burner OFF/ON cycles in order to optimise efficiency. The factory setting for this parameter is 3 minutes and can be set to a value between 0 min and 20 min selecting the desired one.



- **RESET CH TIMER:** this parameter allows you to reset the REDUCED HEATING MAXIMUM OUTPUT TIMING, during which the speed of the fan is limited to 75% of the maximum heating output that has been set, and the AIR PURGING CYCLE. The factory setting for this parameter is FUNCTION NOT ACTIVE, select FUNCTION ACTIVE, confirming the selection for resetting the timings.

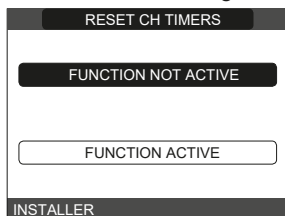

- **SLIDING OUTLET (only if water tank connected):** this parameter allows you to activate the SLIDING OUTLET function for changing the delivery setpoint used by the boiler, when in domestic hot water request mode. The factory value is FUNCTION NOT ACTIVE: modulation at a fixed delivery value of 80°C. By choosing FUNCTION ACTIVE the delivery setpoint is no longer fixed at 80°C, but can be changed and calculated automatically by the boiler on the basis of the difference between the desired domestic hot water setpoint and the temperature measured by the water tank probe. Note: we recommend activating this function for storage cylinders with a capacity greater than 100 litres, loading the cylinder would be too slow.

⚠ It might be necessary to reset the value of this parameter when replacing the adjustment board.

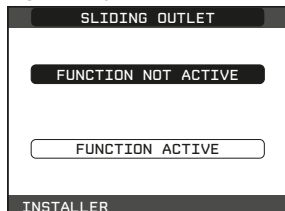

- **DO_AUX1:** through this value it is possible to configure the functions associated with the digital output used to manage the additional pump and the zone valve. The factory setting for this parameter is 0 and can be set within the 0 - 2 range with the following meaning:

Pin 1 and 2 of X21	Jumper not present	Jumpered
DO_AUX1 = 0	additional pump management	zone valve management
DO_AUX1 = 1	zone valve management	zone valve management
DO_AUX1 = 2	additional pump management	additional pump management

- **CONFIG OTBUS:** this parameter is used to enable the remote control of the boiler via an OpenTherm device:
1 = FACTORY VALUE. OTBus function enabled. The message "OPEN THERM CONNECTED" will appear on the display, when an OTBus device connected.
0 = OTBus function disabled. If this parameter is set at 0, any possible OTBus connection is instantaneously interrupted.

6.2.2 CONFIGURATION OF THE ZONE

It is possible to customise the management of the heating zone by accessing the ZONES MANAGER menu.

- Access to menu TECHNICAL → INSTALLATION → ZONES MANAGER → MODIFY ZONE.

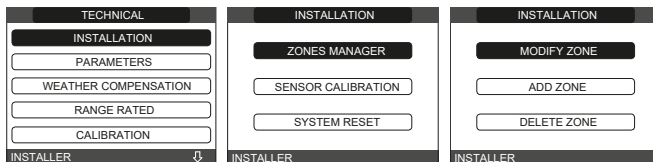

- Select the desired heating zone and then choose from among the options:

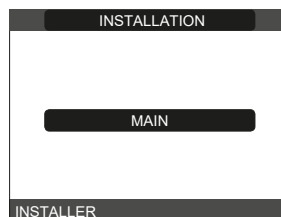

- **TYPE OF ACTUATION:** set the parameter in question to ITRF05/AKM (default value)
- **TYPE OF HEAT REQUEST:** this parameter allows you to specify the type of heat request, it is possible to choose from among the following options:
THERMOSTAT (factory setting): the heat request is generated with an ON/OFF thermostat
REC10 MASTER: the heat request is generated by the REC10 MASTER; in this case the REC10 assumes the function of an HIU (Human Machine Interface)
- **TYPE OF ZONE:** this parameter allows you to specify the type of zone to be heated, it is possible to choose from among the following options:
HIGH TEMPERATURE (factory setting):
LOW TEMPERATURE
- **MIN SET HEAT:** this parameter allows you to specify the minimum heating setpoint that is possible (range 20°C - 80.5°C, default 20°C for high temperature systems; range 20°C - 45°C, default 20°C for low temperature systems)
- **MAX SET HEAT:** this parameter allows you to specify the maximum heating setpoint that is possible (range 20°C - 80.5°C, default 80.5°C for high temperature systems - range 20°C - 45°C, default 45°C for low temperature systems)
- **CHANGING NAME:** this parameter allows you to attribute a specific name to the heating zone
- **POR (embedded clock function):** this parameter enables or disables the embedded clock.
Embedded clock disabled (default) = 0
Central heating is controlled (ON & OFF) by the room thermostat connection (TA).
Embedded clock enabled = 1
Central heating ON/OFF times are controlled according to the (default) heating programme, whilst room temperature is controlled via the room thermostat (TA). Ensure that the operating mode ('STATE' menu) is set to AUTO.

⚠ If you want to deactivate the zone in summer or winter, you must select the pre-established season (SUMMER or WINTER in the boiler MENU) and set the zone in question to off in the STATE or MODE menu.

6.2.3 ANTI-LEGIONELLA FUNCTION (only if connected a water tank with probe)

The machine has an automatic ANTI-LEGIONELLA function that, if necessary, heats the domestic water to 70°C and keeps it at that temperature for 15 minutes to prevent the proliferation of bacteria in the water tank. This function can be set to be activated every day or every week. This function is not performed if the water tank temperature has reached 70°C over the past 24 h - in case it is set to start daily - or over

the last 7 days - in case it is set to start once a week. If the function is activated, it is performed every day at 3:00 a.m. if set to start every day, or on Wednesdays at 3:00 a.m. if set to start every week.

The maximum duration of the anti-legionella cycle is 4 hours; if this function is interrupted because the time has been exceeded, the error message "ANTI-LEGIONELLA FUNCTION NOT COMPLETED" will appear on the display. The system will attempt to execute the function again the following day.

⚠ The function is not performed when the boiler is OFF.

⚠ In the INFO menu, the NEXT ANTILEGIO parameter indicates the number of days left until the next anti-legionella cycle.

This function can be interrupted in advance in two different ways:

- set the boiler to OFF
 - or
 - select STATE → DHW → ANTILEGIO CUT OFF.
- If the function is interrupted, it will be repeated at the same time the next day, even if weekly programming is active.

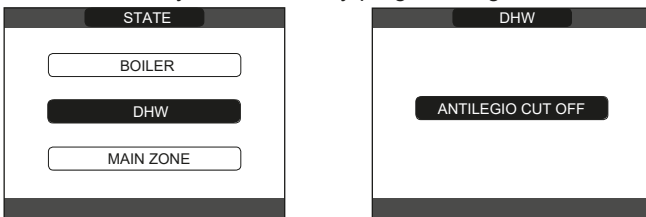

To activate the function:

- select TECHNICAL → ANTI-LEGIONELLA

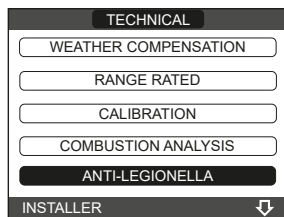

- personalise the following parameters:
- FUNCTION NOT ACTIVE:** the function will not be executed
- DAILY FUNCTION:** the anti-legionella cycle is executed every day at the time set in the ANTILEGIO TIME parameter
- WEEKLY FUNCTION:** the anti-legionella cycle is executed every Wednesday at the time set in the ANTILEGIO TIME parameter
- ANTILEGIO FLOW:** allows you to set the boiler delivery temperature to the storage tank during the execution of the anti-legionella function (default value 80°C)
- ANTILEGIO TIME:** allows you to set the function execution time (default setting 03:00 AM)
- ANTILEGIO TEMP:** allows you to set the storage tank retention temperature during the execution of the anti-legionella function (70°C).

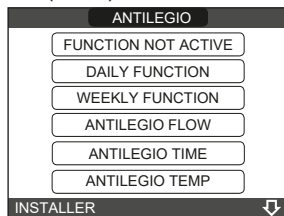

The water tank retention time for anti-legionella varies according to the temperature value set in the ANTILEGIO TEMP parameter, as shown in the table:

ANTILEGIO TEMPERATURE	Retention temperature
ANTILEGIO TEMPERATURE < 58°C	180 min
58°C < ANTILEGIO TEMPERATURE < 62°C	60 min
62°C < ANTILEGIO TEMPERATURE < 66°C	30 min
66°C < ANTILEGIO TEMPERATURE < 75°C	15 min
ANTILEGIO TEMPERATURE > 75°C	1 min

6.2.4 EMBEDDED CLOCK HEATING SCHEDULE

When the embedded clock is enabled (POR=1 - see above), a default heating schedule is used to manage the ON/OFF timings for each day of the week (operating mode = AUTO). if necessary, the default heating schedule can be changed according to the User's needs. Refer to "2.10 TIME SCHEDULE" (User section) for detailed instruction/guidance on how to access and change the default heating schedule.

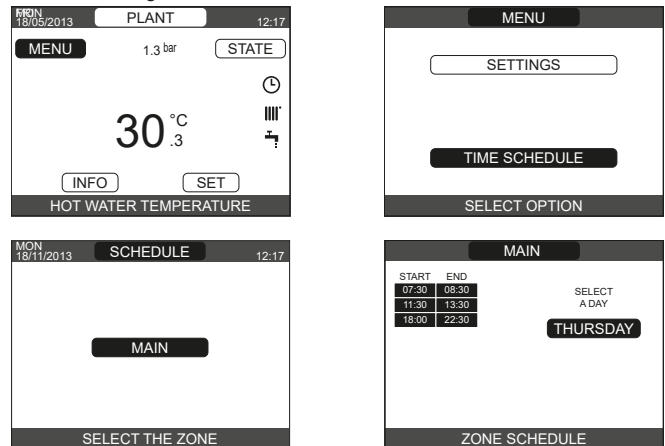

6.2.5 SETTING THE THERMOREGULATION

Thermoregulation (weather compensation) controlled by the appliance, can only be enabled if an external sensor has been installed and connected to the M4 terminal strip. When the presence of an external sensor is detected, the appliance immediately enables the thermoregulation function and calculates a required outlet (flow) temperature that is based on the external temperature and the chosen climatic curve. The temperature measured by the outdoor temperature sensor is displayed on the initial page in the top right, alternating with the display of the time.

When thermoregulation is enabled (outdoor temperature sensor present), the algorithm for automatically calculating the outlet setpoint depends on the type of heat request.

In any case, the thermoregulation algorithm will not directly use the outdoor temperature, but rather a calculated outdoor temperature that takes into account the building's insulation: in buildings that are well insulated, the outdoor temperature variations will have less impact than those that are poorly insulated by comparison. Enabling THERMOREGULATION occurs in the following way:

- select TECHNICAL → WEATHER COMPENSATION

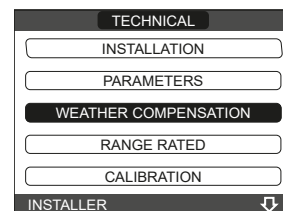

Using the REC10 it is possible to set the value of the following parameters:

BUILDING TYPE: it is indicative of the frequency with which the value of the calculated outdoor temperature for thermoregulation is updated, a low value for this setting will be used for buildings that have little insulation.

Setting range: [5min - 20min]
Factory setting: [5min]

REACTIVITY EXT SENSOR: it is an indication of the speed with which variations of the measured outdoor temperature affect the calculated outdoor temperature value for thermoregulation, low values indicate high speeds.

Setting range: [0 - 255]
Factory setting: [20]

To change the value of the previous parameters, proceed as described below:

- select TECHNICAL → WEATHER COMPENSATION → BUILDING TYPE rather than REACTIVITY EXT SENSOR

- set the desired value.

Note: The value of the calculated outdoor temperature used by the thermoregulation algorithm is displayed in the INFO menu under T EXT FOR THERMOREG.

HEAT REQUEST FROM THERMOSTAT or POR (Programmable Timer)

In this case the outlet setpoint depends on the outdoor temperature for obtaining a reference ambient temperature of 20°C. There are 2 parameters that compete to calculate the output setpoint:

- slope of the compensation curve (KT)
- offset on the reference ambient temperature.

SELECTING THE COMPENSATION CURVE

The compensation curve for heating maintains a theoretical temperature of 20°C indoors, when the outdoor temperature is between +20°C and -20°C. The choice of the curve depends on the minimum outdoor temperature envisaged (and therefore on the geographical location), and on the delivery temperature envisaged (and therefore on the type of system). It is carefully calculated by the installer on the basis of the following formula:

$$KT = \frac{T_{\text{outlet envisaged}} - T_{\text{shift}}}{20 - \text{min. design external } T}$$

Tshift = 30°C standard system
25°C floor installations

If the calculation produces an intermediate value between two curves, you are advised to choose the compensation curve nearest the value obtained.

Example: if the value obtained from the calculation is 1.3, this is between curve 1 and curve 1.5. Choose the nearest curve, i.e. 1.5.

The settable KT values are as follows:
radiator system: 1.0-3.0
under floor heating system 0.2-0.8.

Using the REC10CH it is possible to set the selected thermoregulation curve:

- select TECHNICAL → WEATHER COMPENSATION → CLIMATIC CURVES
- select the heating zone and set the climatic curve.

OFFSET ON THE REFERENCE AMBIENT TEMPERATURE
In any event, the user can indirectly modify the value of the HEATING setpoint inserting an offset on the reference temperature that can vary within the range -5/+5 (offset 0 = 20°C).

NIGHT COMPENSATION

Whenever a programmable timer is connected to the ROOM THERMOSTAT input, the NIGHT COMPENSATION function can be enabled as follows: TECHNICAL menu → WEATHER COMPENSATION → CLIMATIC CURVES → MAIN.

In this case, when the CONTACT is CLOSED, the heat request is made by the flow sensor, on the basis of the outdoor temperature, to obtain a nominal ambient temperature on DAY level (20°C).

The opening of the contact does not produce a switch-off, but a reduction (parallel translation) of the climatic curve on NIGHT level (16°C). Also in this case, the user can indirectly modify the value of the HEATING setpoint inserting once again an offset on the reference DAY temperature (20°C) rather than NIGHT (16°C) that can vary within the range [-5 - +5].

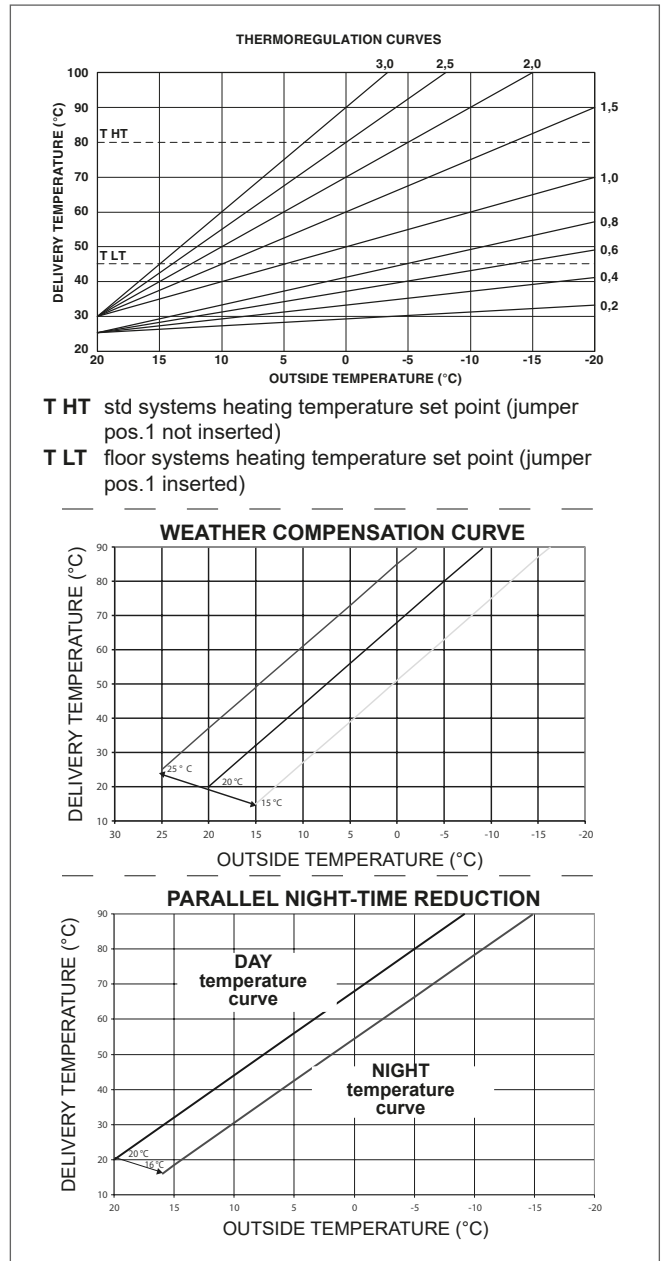

- T HT std systems heating temperature set point (jumper pos.1 not inserted)
- T LT floor systems heating temperature set point (jumper pos.1 inserted)

6.3 FIRST COMMISSIONING

- Carry out the procedure as detailed in “6.1 Preliminary checks”.
- Ensure that all services (gas, water, electricity) are supplied and turned ON at the appliance.
- Ensure that the appliance has been set to HEATING AND HOT WATER (WINTER - access via STATE menu).
- Ensure that any time control and/or temperature control is calling for heat.

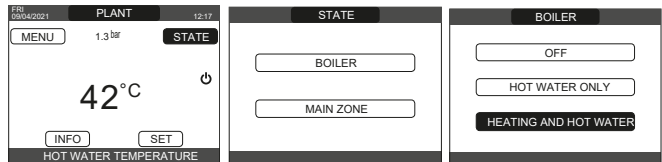

- When any heat request is generated and the burner is lit, the “🔥” icon appears on the display. The boiler will start up and continue working until the set temperatures are reached, after which it will then go back to standby.

VENT CYCLE FUNCTION

⚠ When the appliance is switched on for the first time or whenever the electrical supply has been switched off and then restored, an automatic vent cycle is carried out lasting 6 min. When the vent cycle is in progress, all heat requests are paused except for domestic hot water ones when the boiler is not set to OFF, and a sliding message at the foot of the page appears on the main page of the REC10. In this condition the green and red LEDs are alternately displayed every 0.5 second.

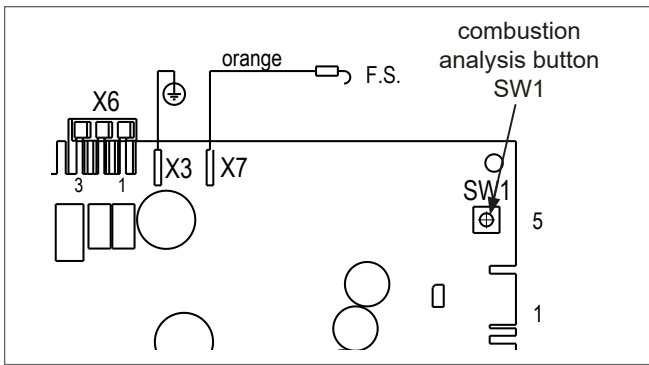

! The vent cycle can be interrupted by removing the cap from the control panel and pressing the combustion analysis button SW1 in the following way:

- select **TECHNICAL** → **AIR PURGING CYCLE** → **STOP FUNCTION**

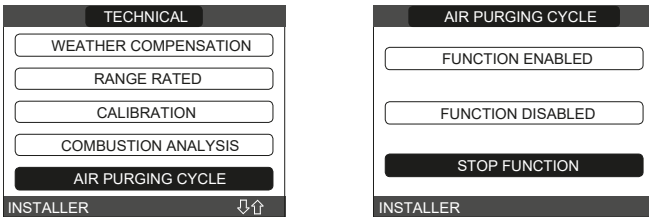

The REC10CH will briefly display a wait message after which you will automatically be taken to the main screen. The vent cycle can also be interrupted, if the boiler is not set to OFF, by a domestic hot water request.

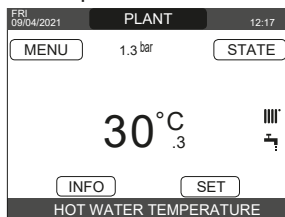

SUMMER (only if a water tank is connected): select **STATE** → **BOILER** → **HOT WATER ONLY (SUMMER)** to activate the traditional function of only domestic hot water. The REC10 normally displays the temperature of the domestic hot water stocked in the water tank (only in case of water tank with probe).

In case of water tank with thermostat or domestic hot water request in progress, the delivery boiler temperature is displayed.

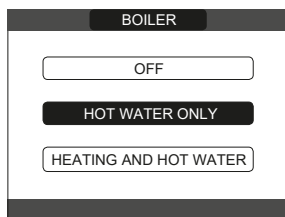

WINTER / : select **STATE** → **BOILER** → **HEATING AND HOT WATER (WINTER)**: the operating mode of the appliance is set to provide both heating and hot water.

NOTE: the main zone also needs to be set to ON (embedded clock disabled) or AUTO/MANUAL (embedded clock enabled) in order for the appliance to provide heating.

The UI will display the flow outlet temperature is displayed.

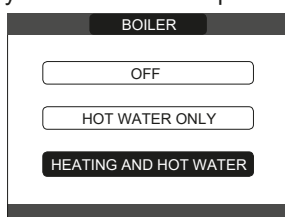

6.4 ADJUSTING THE HEATING WATER TEMPERATURE WITHOUT AN OUTDOOR TEMPERATURE SENSOR CONNECTED

When there is no outdoor temperature sensor, the boiler operates at a fixed-point, the HEATING setpoint in this case can be set selecting SET on the main screen of the REC10 and selecting the desired value within the range [40°C - 80.5°C] for high temperature systems or [20°C - 45°C] for low temperature systems (default is high temperature).

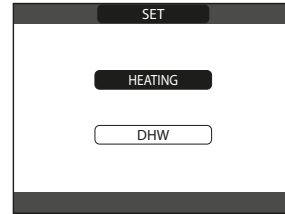

6.5 ADJUSTING THE HEATING WATER TEMPERATURE WITH AN OUTDOOR TEMPERATURE SENSOR CONNECTED

When an outdoor temperature sensor is installed, the outlet temperature is automatically selected by the system, which quickly adjusts the ambient temperature according to the variations in the outdoor temperature. If you want to change the temperature, raising it or lowering it with respect to that automatically calculated by the electronic board, it is possible to change the HEATING setpoint by selecting SET on the main screen of the REC10 and selecting within the range (-5 - +5) the desired comfort level (see "6.2.5 Setting the thermoregulation").

Note: when there is an outdoor temperature sensor connected it is still possible to have the boiler operate at a fixed point setting the values of MIN SP HEAT and MAX SP HEAT at the desired HEATING setpoint.

6.6 ADJUSTING THE DOMESTIC HOT WATER TEMPERATURE

CASE A: only heating with no external water tank connected - adjustment not applicable.

CASE B: only heating with an external water tank managed by a thermostat - adjustment not applicable.

CASE C: only heating with an external water tank managed by a probe.

To set the domestic hot water temperature (bath, shower, kitchen, etc.): **SET** → **DHW** to choose the desired value between the range [37,5°C ÷ 60°C].

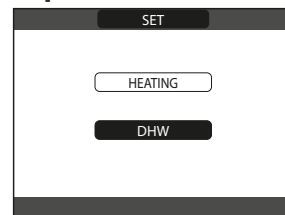

6.7 ADDING DEVICES

- Select **TECHNICAL** → **ADD WATER TANK**

Then complete the configuration of the water tank referring to the specific section (section "6.15 Water tank configuration").

! After adding the water tank, DHW is displayed on the "Programme" page. This function allows the domestic hot water programming timing to be carried out.

6.8 BOILER START-UP

In order to initiate a heating request, it is essential that any time or temperature control is set to an ON period and at a higher than current ambient temperature respectively. The boiler will be in standby until the burner switches on following a heat request. The display shows to indicate the presence of a flame.

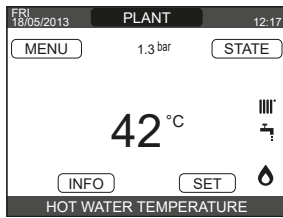

During any heating request, the appliance will attempt to reach and maintain the selected set point, at which point it will modulate the fan speed to maintain the set outlet temperature. Should the outlet temperature begin to exceed the set point, the burner will switch off and the pump will continue to run. In the unlikely event of a fault or malfunction occurring, the appliance will enter a temporary or final fault condition, during which it shutdown; this is signalled via the UI by a warning triangle and a short description of the fault. For further detailed information on fault codes please refer to "6.13 Lights and faults".

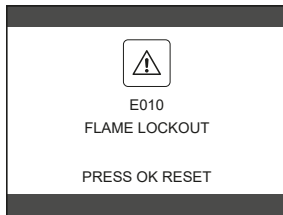

6.9 RESET FUNCTION

In the unlikely event of the appliance entering a fault condition; use the arrow buttons on the UI to navigate to the warning triangle, and press select. Then follow the instruction/advice as shown on the UI screen.

If the release attempts do not restart the boiler, contact the local Technical Assistance Centre.

6.10 SCREED HEATING FUNCTION

For a low temperature system the boiler has a "screed heating" function that can be activated in the following way:

- set the status of the boiler to OFF
- select SCREED HEATING (Note: SCREED HEATING is not available if the boiler is not OFF) FUNCTION ACTIVE or FUNCTION NOT ACTIVE and confirm to enable /disable the function.

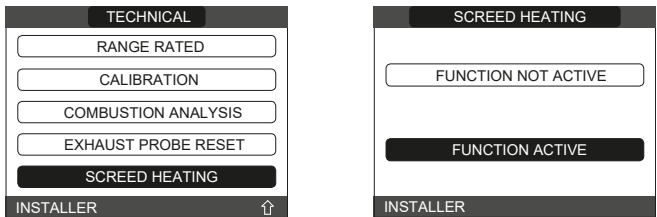

When the SCREED function is enabled, a scrolling message is displayed on the lower part of the UI screen SCREED HEATING FUNCTION IN PROGRESS - OUTLET TEMPERATURE, while on the electronic board the red and green LEDs flash alternately with a frequency of 1 sec ON - 1 sec OFF. The "screed heating" function lasts 168 hours (7 days) during which, in the zones configured as low temperature, a heating request is simulated with an initial zone outlet of 20°C, then increased in line with the table on the side. Accessing the INFO menu from the main page of the REC10 it is possible to display the TIME FUNC SCREED HEATING value regarding the number of hours since the start of the function. Once activated, the function takes priority, if the appliance is shut down by disconnecting the power supply, when it is restarted the function picks up from where it was interrupted. The function can be interrupted before its end by putting the appliance in a condition other than OFF or else by selecting DEACTIVATE FUNCTION from the relative menu.

Note: The temperature and increase values can be set to different values only by qualified personnel, only if strictly necessary. The manufacturer declines all responsibility if the parameters are incorrectly set.

DAY	TIME	TEMPERATURE
1	0	20°C
	6	22°C
	12	24°C
2	18	26°C
	0	28°C
	12	30°C
3	0	32°C
	0	35°C
4	0	35°C
	0	30°C
5	0	30°C
	0	25°C
6	0	25°C
	0	25°C
7	0	25°C
	0	25°C

6.11 CHECKS DURING AND AFTER THE FIRST COMMISSIONING

After start up, check that the boiler carries out the start-up procedures and subsequent shut-down correctly.

NOTE

In order to perform a combustion analysis check, you should ensure that the appliance is HOT; this can be achieved by generating a heating or hot water request for several minutes:

- checking the combustion.

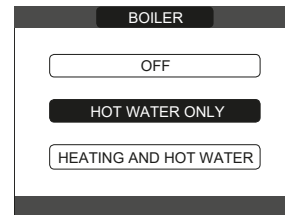

6.12 COMBUSTION CHECK

To carry out the combustion analysis, proceed as follows:

- ensure that the electrical supply to the appliance is switched ON
- set the status of the boiler to OFF
- select TECHNICAL COMBUSTION ANALYSIS ACTIVATE FUNCTION and confirm

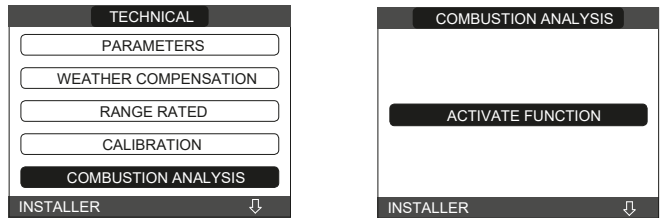

NOTE

The dynamic gas pressure can be checked by attaching a manometer to the test point located on the gas cock (please also refer to section 4.3).

- Select ACTIVATE FUNCTION.
- **Note:** the sweeper function can also be activated by pressing the SW1 key on the electronic board AKM (this requires removing the plug (C) from the cover of the instrument panel to access the electrical components).

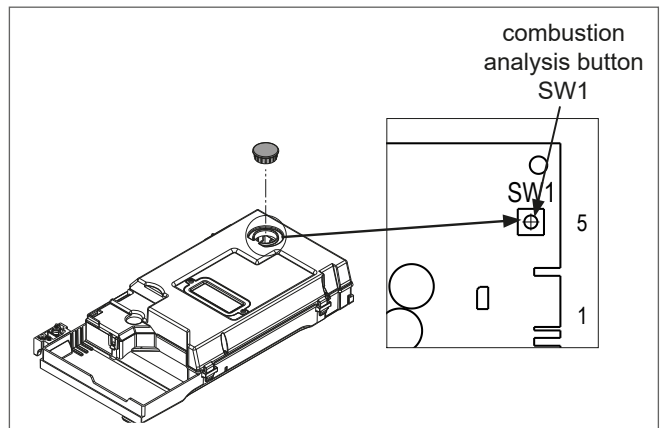

Wait for the burner to ignite.

The boiler will operate at maximum heating output and it will be possible to check the combustion.

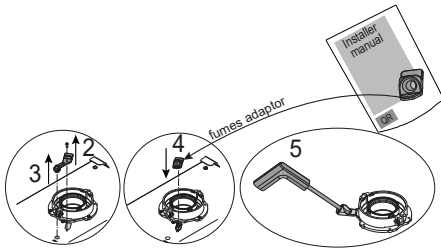
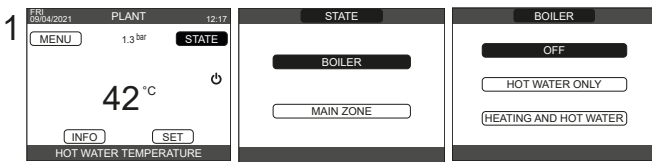

- Perform the combustion check verifying that the CO₂ values correspond to those indicated in section 6.
- Once completed, remove the analyser probe and close the combustion analysis test points, using the previously removed cap and screw..

! Should the readings be significantly different from the values declared in the technical data table; **do not attempt to carry out any adjustment of the gas valve.** Please call the Vokera technical Helpline for assistance and further advice.

! The gas valve is non-adjustable and must not be tampered with. Tampering with the gas valve will result in the malfunction of the appliance and possible damage to components.

! When the sweeper function is in progress all the heat requests are paused and a scrolling message appears at the foot of the main page of the REC10; green and red LEDs are off.

When the checks are completed:

- set the boiler to "SUMMER" or "WINTER" mode depending on the User's requirements
- regulate the heat request temperature values according to the customer's needs.

IMPORTANT

The sweeper function is active for a time limit of 15 minutes; the burner shuts down if an outlet temperature of 95° C is reached. It will ignite again when the temperature falls below 75° C.

6.13 LIGHTS AND FAULTS

In the unlikely event of appliance malfunction and/or a system fault, the appliance will enter a final or temporary fault condition, whereby it will shut down and a warning triangle

! will appear on the left side of the UI screen. Use the arrow buttons on the UI to navigate to the warning triangle, and press select. Then follow the instruction/advice as shown on the UI screen.

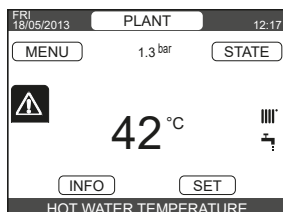

The faults description screen is automatically displayed once the display illumination time has elapsed without any button being pressed.

Press the "up" and "down" keys to display the descriptions of any other faults that may be present.

Reset function

In order to reset the boiler's operation in the event of a fault, it is necessary to access the fault description screen. If the lockout is of a non-volatile type that requires a reset procedure, this will be indicated on the screen, and can be performed by pressing the "ok" button on the REC10.

At this point, if the correct operating conditions have been restored, the boiler will restart automatically.

There are a maximum of 3 consecutive attempts at a release by the REC10, should all 3 attempts at reset fail, the appliance will require to be isolated briefly from the electrical supply in order to carry out any further reset attempts. Once the electrical supply has been restored, further attempts at reset can be carried out. In case of all the attempts are exhausted the definitive fault E099 occurs on the display.

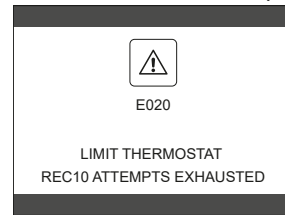

! If the attempts to reset the boiler are unsuccessful, please contact the Vokera technical helpline.

For fault E041

If the pressure drops below the safety pressure limit of 0.3 bar the boiler displays the fault code "E041 - WATER TRANSDUCER LOAD THE SYSTEM" for a transitional time of 30 sec during which it is possible to open the external filling tap until the pressure is between 1 and 1.5 bar.

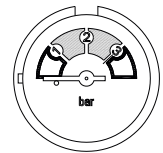
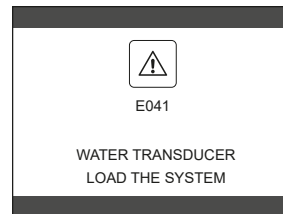

! If the pressure drops frequently, contact your installer or the Vokera customer care centre.

For fault E060

There is a configuration error; check that the appliance has been configured as a CH only boiler.

For fault E091

The boiler has an auto-diagnostic system which, based on the total number of hours in certain operating conditions, can signal the need to clean the primary exchanger (alarm code E091). Once the cleaning operation has been completed, reset to zero the total hour meter following procedure indicated below:

- select TECHNICAL → EXHAUST PROBE RESET → CONFIRM or CANCEL.

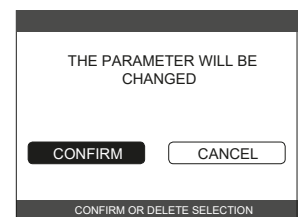
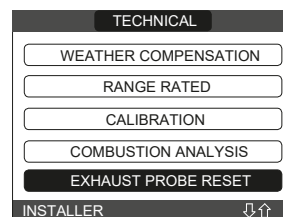

NOTE: the meter resetting procedure should be carried out after each in-depth cleaning of the primary exchanger or if this latter is replaced.

The total hours can be verified in the following way: INFO menu → EXHAUST PROBE (see "2.8 INFO" - User section).

Boiler faults list

ERROR CODE	ERROR MESSAGE	DESCRIPTION OF ALARM TYPE
E010	flame lockout/ACF electronic fault	final
E011	extraneous flame	temporary
E020	limit thermostat	final
E030	fan fault	final
E040	water transducer - check system water pressure	final
E041	water transducer - check system water pressure	temporary
E042	water transducer fault	final
E060	configuration fault	temporary
E070	fault flow sensor/overtemperature flow sensor/ flow/return sensor differential alarm	temporary/final/ final
E077	main zone water thermostat	temporary
E080	fault return line probe/return line probe overtemperature/ outlet/return line probe differential alarm	temporary/final/ final
E090	fault flue gases probe/ flue gases overtemperature probe	temporary final
E091	clean primary heat exchanger	temporary
E099	reset attempts exhausted, boiler blocked	definitive, not resettable
--	water pressure low - check the system	temporary
--	water pressure high - check the system	temporary
--	boiler board communication lost	temporary
--	BUS 485 communication lost	temporary

List of combustion faults

ERROR CODE	ERROR MESSAGE	DESCRIPTION OF TYPE OF ALARM
E021	iono alarm	These are temporary alarms that if they occur several times in an hour they become definitive; the alarm E097 is displayed and is followed by post-purging for 45 seconds at the fan's maximum speed. It is always possible to release the alarm before the end of the post-purging.
E022	iono alarm	
E023	iono alarm	
E024	iono alarm	
E067	iono alarm	
E088	iono alarm	
E097	iono alarm	
E085	combustion fault/high CO	These are temporary alarms that if they occur several times in an hour they become definitive; the last error to occur is displayed and is followed by a post-purging of 2 minutes at the fan's maximum speed. It is not possible to release the alarm before the end of the post-purging unless the boiler's power supply is switched off.
E094	combustion fault/high CO	
E095	combustion fault/high CO	
E058	mains voltage fault	These are temporary faults that restrict the ignition cycle.
E065	current modulation alarm	
E086	obstruction fumes alarm	Temporary fault reported during the post ventilation. It is maintained a post ventilation of 5 min at maximum fan speed.

6.14 ALARM HISTORY

The ALARM HISTORY function is automatically enabled only after the machine has been powered up for at least 2 consecutive hours, during this period of time any alarms that arise will not be saved in the "alarm history".

The alarms can be displayed in chronological order, from the most recent to the oldest, up to a maximum of 50 alarms; to display the alarm history:

- select TECHNICAL → ERROR HISTORY

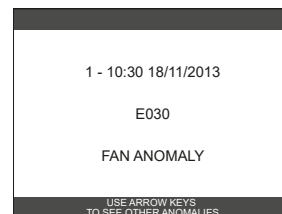
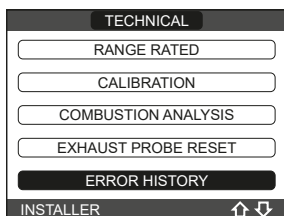

It is possible to return to the start page at any time by keeping the "back" key pressed for at least 2 seconds.

Note: once enabled, the ALARM HISTORY function can no longer be disabled; there is no procedure for resetting the alarm history.

If an alarm repeats consecutively, it is saved only once.

- for each alarms a sequential number is displayed, an error code and the date and time the alarm occurred.

6.15 WATER TANK CONFIGURATION

 The boiler leaves the factory pre-configured for managing a water tank with a thermostat (water tank type parameter = 0).

To modify the configuration of the water tank:

- select TECHNICAL → WATER TANK

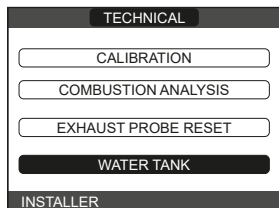

- choose from the following options:

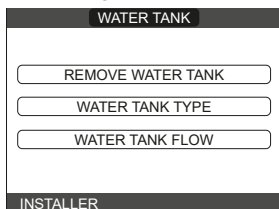

WATER TANK TYPE: this parameter allows you to set the type of the water tank. Set the value to 1 to select a water tank with probe, set the value to 0 to select a water tank with thermostat (factory setting).

REMOVE WATER TANK: this function is used to disable the operation of the water tank; water tank disabled, the relative configuration menu is no longer accessible. If you wish to add a storage cylinder again, after a previous removal, follow the instructions in paragraph section 4.7.

WATER TANK FLOW: the parameter allows you to set the delivery temperature of the boiler to the water tank when the SLIDING OUTLET function is not active. The factory setting is 80°C.

6.16 TEMPORARY SWITCH-OFF

In the event of temporary absences (weekends, short breaks, etc.) set the status of the boiler to OFF .

Refer to section 3.3 for further details.

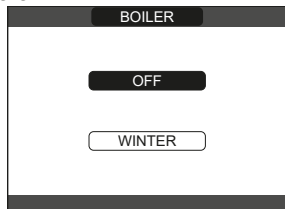

6.17 SWITCHING OFF FOR LENGTHY PERIODS

Refer to section 3.4 for detailed advice on shutting down the appliance for an extended period of time.

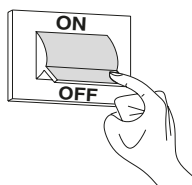
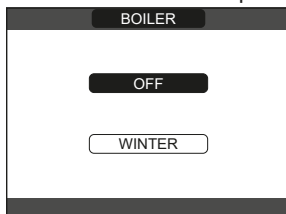

6.18 COMBUSTION PARAMETERS

Although the parameters referring to the combustion control system ACC (Active Combustion Control) are preset in the factory, the simultaneous replacement of **both** electronics boards (AKM and REC 10 MASTER) will require the re-programming of these parameters.

- Set SERVICE password
- Select TECHNICAL → COMBUSTION MONITORING

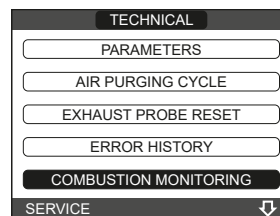

- Select GAS TYPE
- Set this parameter depending on the type of gas of the boiler: NG = NATURAL GAS - LPG = LPG

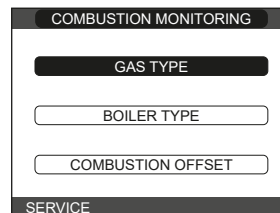

- Select BOILER TYPE and set as shown in the table

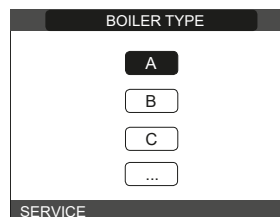

	BOILER TYPE
UNICA MAX 20S	A
UNICA MAX 30S	G

- Select COMBUSTION OFFSET → RESTORE
- Press OK to confirm.

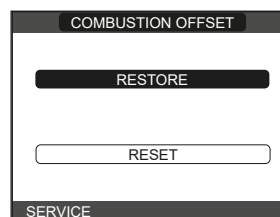

COMBUSTION SELF-CALIBRATION

Function used by the after sales service to make an automatic combustion curve correction if the CO₂ values (shown in the technical data) are outside the permitted range.

- Power the boiler electrically by bringing the main switch to "ON".
- Set the boiler status to OFF.
- Select TECHNICAL → COMBUSTION CONTROL → SELF-CALIBRATION.
- Set the values to:
 - RESTORE = use the old curve (if the CO₂ value is too high)
 - RESET = use the new curve (if the CO₂ value is too low).

This parameter is only available when the system is OFF.

6.19 MAINTENANCE

 In case where, after the replacement of the electronic board or the maintenance of the detection electrode or the burner, the combustion analysis would restore out of tolerance values, it may be necessary to take action on the parameter COMBUSTION OFFSET as described in the *section 6.18*.

Note: in case of replacement of the electrode, slight variations of the combustion parameters can not be excluded. These data will return to nominal values after a few hours of operation.

 Do not clean the appliance or its parts with inflammable substances (e.g. petrol, alcohol, etc.).

 Do not clean panels, painted parts and plastic parts with paint thinner.

- ⚠ Panel cleaning must be carried out only with soapy water.

Cleaning the siphon

- Disconnect the tubes (A) and (B), remove the clip (C) and remove the siphon.
- Unscrew the bottom and top caps, then remove the float.
- Clean the parts of the siphon from any solid residues.

- ⚠ Do not remove the syphon float or seal as these items are integral in preventing the possibility of flue gases escaping to atmosphere if/when the syphon is devoid of any condensate fluid.

- ⚠ Once the operations have been completed, reassemble the components by operating in the reverse order to what is described, checking the floating seal and replace it if necessary. If replacing the float gasket, make sure it is correctly positioned in its seat (see figure in section).

- ⚠ At the end of the cleaning sequence, fill the siphon with water before restarting the boiler as follows:
 - slowly open the de-aeration valve (7 - fig. 3) and leave it open until the amount of water contained in the siphon reaches the maximum level
 - close the de-aeration valve (7 - fig. 3)
 - check that the condensate siphon connection is tight
 - check that the system pressure has not dropped below 1 bar. If necessary, fill the system.

CHECK THAT THE CONDENSATE DRAIN OUTLET SIPHON CONTAINS WATER, IF IT WAS NOT FILLED PROCEED AS DESCRIBED ABOVE.

- ⚠ At the end of the siphon maintenance operations, it is recommended to bring the boiler to condensing mode for a few minutes and to check for leaks from the entire condensate evacuation line.

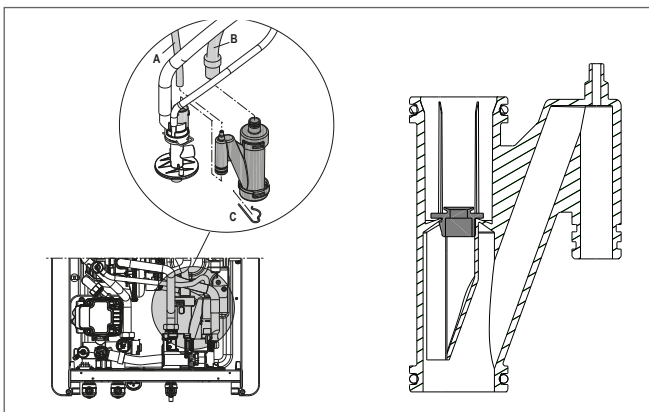

Cleaning the air filter

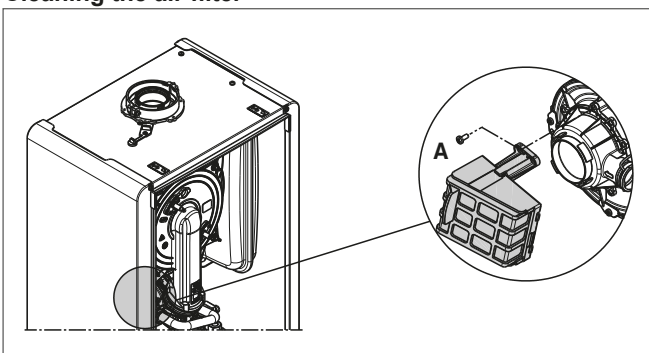

- Unscrew the fixing screw A and remove the air filter.
- Blow compressed air on the filter to remove any impurities.
- In case of persistent dirt wash with water.

Maintenance of the combustion control system

Maintenance electrode

The detection electrode/ionization sensor has an important function in the boiler ignition phase and in the maintenance of optimal combustion; in this context, in the event of replacement, it is necessary to **always ensure** that it is correctly positioned and to strictly observe the reference shown in the figure.

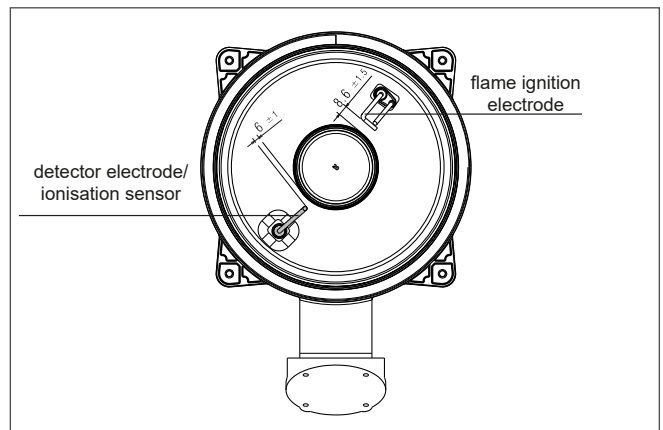

- ⊘ Do not clean the electrode with sandpaper or any other abrasive material.

- ⚠ The 'Iono' electrode will degrade over a period of time and continued usage; it is therefore strongly recommended that it be replaced after 5-years of use; in order to ensure continued performance and efficiency, and avoid appliance malfunction.

6.20 FINAL CHECKS

- ENSURE THE APPLIANCE FLUE SYSTEM IS FITTED CORRECTLY AND IS PROPERLY SECURED.
- ENSURE ALL PIPE WORK IS RE-CHECKED FOR TIGHTNESS.
- COMPLETE BENCHMARK CHECKLIST.

FOR UK ONLY

Complete details of the boiler, controls, installation and commissioning in the Benchmark checklist at the back of this book. It is important that the Benchmark checklist is correctly completed and handed to the user. Failure to install and commission the appliance to the manufacturers instructions will invalidate the warranty.

6.21 INSTRUCTING THE USER

Hand over all documentation supplied with this appliance – including these instructions – and explain the importance of keeping them in a safe place. Explain to the user how to isolate the appliance from the gas, water and electricity supplies and the locations of all drain points. Show the user how to operate the appliance and any associated controls correctly. Show the user the location of the filling valve and how to top-up the system pressure correctly and show the location of all manual air release points. Explain to the user how to turn off the appliance for both long and short periods and advise on the necessary precautions to prevent frost damage.

Explain to the user that for continued safe and efficient operation, the appliance must be serviced annually by a competent person.

IMPORTANT

To validate the appliance warranty, it's necessary to register the appliance details with us. The warranty can be registered in several ways:

- online at: vokera.co.uk
- for UK residents by calling: 0800 479 0751
- for ROI residents by calling: 056 7755055.

7. SECTION - SERVICING INSTRUCTIONS

GENERAL

Once the appliance has been serviced, the benchmark Service Record must be completed.

For UK only

It is important that the Benchmark Service Record is correctly completed and handed to the user. Failure to install and commission the appliance to the manufacturers instructions will invalidate the warranty.

To ensure the continued safe and efficient operation of the appliance, it is recommended that it is checked and serviced at regular intervals. To ensure correct and safe operation of the appliance, it is essential that any worn or failed component be replaced only with a **genuine Vokèra spare part**. It should be remembered that although certain generic components may look similar, they will be specific to an individual appliance or product range. Use of non-genuine Vokèra spare parts could invalidate your warranty and may pose a potential safety hazard. The frequency of servicing will depend upon the particular installation conditions, but in general, once per year should be sufficient. It is the law that any servicing work is carried out by competent person such as a Vokèra engineer, an approved service agent, British Gas, GAS SAFE registered personnel or other suitably qualified personnel. The following instructions apply to the appliance and its controls, but it should be remembered that the central heating and the domestic hot water systems would also require attention from time to time.

ROUTINE ANNUAL MAINTENANCE

The appliance incorporates many 'state-of-the-art' components that are either 'solid-state' or are regarded as 'non-serviceable' items. As a consequence, the requirements for routine annual maintenance are focussed upon:

1. ensuring that the appliance and flue system are in a safe condition
2. ensuring that the appliance is operating safely
3. ensuring that the appliance is performing to its design specification.

When the appliance has been installed to within the minimum stated clearances; the appliance layout is such that it enables routine annual maintenance to be carried out entirely from the front of the appliance.

NOTE

Any noticeable defect or deterioration on or within the appliance and flue system that impacts or affects the above requirements; will warrant further diagnosis and repair, which may result in the replacement of components.

Specific advice and instruction on the removal and replacement of component parts of the appliance can be found online using the adjacent QR code or by visiting our website.

ROUTINE ANNUAL MAINTENANCE REQUIREMENTS

1. Check the operation of the appliance in both the heating and hot water modes and ensure the performance is in line with the appliance specification.
2. Using the UI menu, navigate to the alarms history and check for any recent alarm events (menu string is: MENU → SETTINGS → TECHNICAL → ERROR HISTORY). Refer to the alarm/fault codes description chart for further information.
3. Remove the front cover (see section 6.12) and visually inspect the internal components and electrical wiring for any defect or deterioration.
4. Visually check for any dirt or debris within the condensate trap (the trap is translucent and can be checked visually).
5. Replace the front cover as detailed in section 6.12 taking notice of the importance of ensuring that the effectiveness of the – front cover – seals are not compromised.
6. Carry out a combustion analysis as detailed in section 6.12.
7. Visually check the entire flue system for any damage, defect, or deterioration.

NOTE

In order to access the 'alarms history' it is necessary to access the password protected settings. Refer to section 8 for further details.

UNSCHEDULED MAINTENANCE

The appliance incorporates software that monitors the operating conditions of the appliance, and will record any 'unusual usage conditions' that will affect the requirement to remove and clean the burner/heat exchanger assembly. When the 'unusual usage' hours reach a pre-determined threshold, the appliance will signal – via alarm code E091 – that the heat exchanger requires to be cleaned.

REPLACEMENT OF COMPONENTS

Although it is anticipated that this appliance will provide years of trouble-free service and outstanding performance; the lifespan of any component will be determined by factors such as operating conditions and usage levels. Should the appliance develop a fault, the fault-finding section of this manual will greatly assist in determining the cause; however further advice can be sought from the Vokera Technical Help-line. Remember always to use only genuine Vokera spare parts.

COMPONENT REMOVAL PROCEDURE

To remove/replace a component, access to the interior of the appliance is usually essential.

Always isolate the appliance from the electrical supply – and if necessary remove the fuse.

- Close all service valves if any hydraulic and/or gas carrying item is to be removed.
- Remove the front cover – and where necessary or convenient – the side panels of the appliance as detailed in 5.7.1.
- If required, drain the primary circuit via the drain valve (located adjacent to the diverter valve) using the tubing supplied with the appliance.
- If required, drain the secondary circuit via the available DHW outlets.

NOTE

When removing a hydraulic component, ensure that some water absorbent cloths are available to catch any residual water that may drip from the appliance and/or the removed component.

When the appliance has been installed to within the stated minimum clearances; it may be necessary to remove adjacent components in order to facilitate access to a specific component.

Carry out the relevant elements of the commissioning procedure (section 8) after replacing a component.

ALWAYS TEST FOR GAS TIGHTNESS IF ANY GAS CARRYING COMPONENT HAS BEEN DISTURBED, REMOVED, OR REPLACED.

WHEN REPLACING THE SIDE PANELS AND/OR THE FRONT COVER, ENSURE THE ROOM SEALED INTEGRITY OF THE APPLIANCE HAS NOT BEEN COMPROMISED – REFER TO 5.7.1.

To obtain detailed specific information and instructions on how to remove and replace specific components, please access our online resources by logging on to our website.

www.vokera.co.uk
www.vokera.ie

8. SECTION - CHECKS, ADJUSTMENTS AND FAULT FINDING

NOTE: please refer to section 4, section 4.1 and use the appropriate PPE when carrying out any of the actions or procedures contained within this section.

8.1 CHECKING APPLIANCE OPERATION

When carrying out any repairs or servicing to the appliance, the relevant commissioning procedure must be undertaken to ensure the continued safe operation of the appliance. Particular attention should be made to ensure gas tightness, water tightness and the electrical integrity of the appliance.

8.2 APPLIANCE MODES OF OPERATION

NOTE

There must be sufficient system water pressure (min. 0.5 bar) to ensure the water pressure switch is activated. If there is insufficient system pressure the pump and fan will be prevented from operating and the low-pressure fault code will be indicated.

8.2.1 OFF

When the appliance has been set to OFF via the REC10 UI, the following functions will remain active:

- frost-protection system
- pump anti-block.

8.2.2 ON-BOARD FUNCTIONS

- **FROST-PROTECTION:** this function is only active when there are no requests for heating or HW. If the temperature drops below 5°C, the boiler will operate on minimum power until the temperature of the thermistors reaches 35°C for CH and 55°C for DHW. Thereafter the pump & fan will over-run for 30-seconds.
- **ANTI-CYCLE FUNCTION:** the anti-cycle function ensures the burner remains switched off for at least 3-minutes after the set-point hysteresis (set-point + 5-deg) for CH heat request.
- **PUMP ANTI-BLOCK FUNCTION:** when there has been no heating or HW request for 24-hours, the anti-block cycle is activated. The pump will be activated for a period of 30-seconds.

8.2.3 HEATING MODE

When a 'heating' request is generated via the connected external control/s and/or the REC10 UI, the appliance will operate in the heating mode. The pump and fan will be activated via the flow temperature sensor. When the fan is sensed to be operating correctly (tacho signal), the ignition sequence commences. Ignition is sensed by the electronic circuit to ensure flame stability at the burner. Once successful ignition has been achieved, the electronic circuitry increases the gas rate to 75% for a period of 15 minutes.

The speed of the fan and therefore the output of the boiler is determined by the temperature of the water sensed by the flow temperature sensor, consequently a high temperature at the flow sensor results in a lower fan speed. As the water temperature increases, the temperature sensors – located on the flow pipe of the boiler – reduce the fan speed via the electronic circuitry. Depending on the load, either the water temperature will continue to rise until the set point is achieved or the water temperature will fall whereby fan speed will increase relative to the output required. When the boiler has reached the set point (+ hysteresis), the burner will switch off. The built-in anti-cycle device prevents the burner from re-lighting for approximately 3-minutes.

When the temperature of the flow sensor falls below the set point (- hysteresis), the burner will re-light.

NOTE

If burner ignition is not detected at the first attempt, the appliance will repeat the ignition sequence another two times (3-times in total) before going to lockout. When the set-point has been reached as measured at the primary thermistor, the appliance

will begin the modulation phase whereby the fan and gas valve will continuously modulate to maintain the set-point.

If the temperature continues to rise and exceeds the set-point by 5°C (hysteresis), the burner will shut down. A new ignition sequence will be enabled when the 3- minute anti-cycle has been performed and the temperature at the primary thermistor has dropped 5°C (hysteresis) below the set-point.

NOTE

When the request for heating and/or hot water has been satisfied, the appliance pump and fan may continue to circulate to dissipate any residual heat within the appliance.

ATTENTION

Gas type and appliance outputs are factory set by default, at the values declared in the specification data in section 2.

Vokera cannot accept any responsibility for any damage or malfunction that has been caused as a result of tampering or incorrect set up of this appliance during installation or commissioning.

8.3 CHECKING THE EXPANSION VESSEL

Carry out the component removal procedure. You must ensure that the boiler is completely drained of water. Using a suitable pressure gauge, remove dust cap on expansion vessel and check the charge pressure. The correct charge pressure should be 1.0 bar ± 0.1 bar. If the charge pressure is less, use a suitable pump to increase the charge.

NOTE

You must ensure the drain valve is in the open position whilst re-charging takes place. Replace the dust cap and carry out the relevant commissioning procedure (section 6).

8.4 EXTERNAL FAULTS

Before carrying out any faultfinding or component replacement, ensure the fault is not attributable to any aspect of the installation.

8.4.1 INSTALLATION FAULTS

Symptom	Possible cause
No ignition	Check wiring/check electrical supply/check gas supply
No Heating and/or HW	Check external controls

Fault	Possible cause
Fault code	Check gas supply, check flue system

8.5 ELECTRICAL CHECKS

Any electrical checks must be carried out by a suitably qualified person.

8.5.1 EARTH CONTINUITY TEST

Isolate the appliance from the electrical supply, and using a suitable multi-meter carry out a resistance test. Connect test leads between an appliance earth point and the earth wire of the appliance supply cable. The resistance should be less than 1 OHM. If the resistance is greater than 1 OHM check all earth wires and connectors for continuity and integrity.

8.5.2 SHORT CIRCUIT CHECK

Isolate the appliance from the electrical supply, and using a suitable multi-meter, carry out a short circuit test between the Live & Neutral connections at the appliance terminal strip. Repeat above test on the Live & Earth connections at the appliance terminal strip.

NOTE

Should it be found that the fuse has failed but no fault is indicated, a detailed continuity check will be required to trace the fault. A visual inspection of components may also assist in locating the fault.

8.5.3 POLARITY CHECK

With the appliance connected to the electrical supply and using a suitable multimeter, carry out the following voltage tests:

- connect test leads between the Live & Neutral connections at the appliance terminal strip. The meter should read approximately 230V ac. If so proceed to next stage. If not, see section 8.6.
- connect test leads between the Live & Earth connections at the appliance terminal strip. The meter should read approximately 230V ac. If so proceed to next stage. If not, see section 8.6.
- connect test leads between the Neutral & Earth connections at the appliance terminal strip. The meter should read approximately 0 – 15Vac. If so polarity is correct. If not, see section 8.6.

8.5.4 REVERSED POLARITY OR SUPPLY FAULT

Repeat the above tests at the appliance isolator, if testing reveals correct polarity and/or supply at the isolator, re-check wiring and connections between the isolator and the appliance. If tests on the isolator also reveal reversed polarity or a supply fault, consult the local electricity supplier for advice.

DISTANCE TO EARTH CHECK

Isolate the appliance from the electrical supply, and using a suitable multi-meter carry out a resistance test. Connect test leads between the Live & Earth connections at the appliance terminal strip. If the meter reads other than infinity there is a fault that must be isolated, carry out a detailed continuity check to identify the location of the fault.

These series of checks must be carried out before attempting any faultfinding procedures on the appliance. On completion of any task that required the disconnection and re-connection of any electrical wiring or component, these checks must be repeated.

8.6 FAULT FINDING

Before attempting any faultfinding, the electrical checks as detailed in section 8.5 must be carried out. Isolate the appliance from the electrical supply.

Disconnect any external controls from terminal plug, and insert a link-wire between the two wires at the 'TA' connections of the BE11 board.

NOTE

Restore the electrical supply to the boiler and RESET functioning. The boiler should now function as described in section 8.2. Should the boiler fail to respond, the internal fuses and connectors should be checked to ensure integrity and continuity.

8.7 APPLIANCE STATUS AND FAULT CODES

When the boiler detects a temporary fault condition, the appropriate code is shown. If/when the fault is final, the pump will perform 30 to 60-second post circulation (depending on the error code) and fault code will be displayed. For combustion fault, FAN can also post vent up to 5min if required.

8.8 REC10 SYSTEM RESET

Warning! – This operation must only be carried out by qualified personnel!

If required, the system configuration can be reset back to the factory default configuration; however care needs to be taken in order to carry out a successful reset:

- access to menu **TECHNICAL** → **INSTALLATION** → **SYSTEM RESET** → **CONFIRM** or **CANCEL**

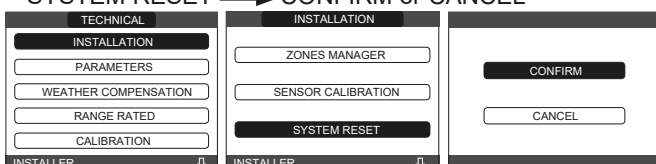

- the UI screen will display the firmware version – press any key to continue
- select language (**ENGLISH**)
- enter the time and date
- select **MASTER**
- select configuration type: **NEW** or **MAIN PCB** (see below)

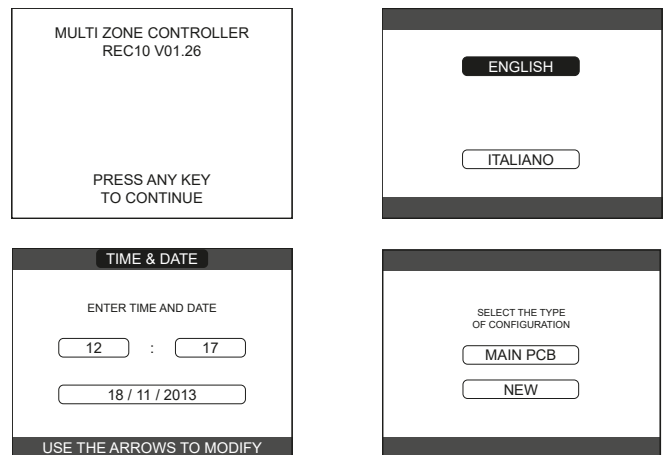

8.8.1 BOILER CONFIGURATION

The **BOILER** menu allows you to change the hydraulic configuration without necessarily having to go through a **SYSTEM RESET** operation.

The **HYDRAULIC CONF** parameter can assume values between 0 and 4 with the following meaning:

- 0 = only heating boiler
- 1 = instantaneous boiler with flowswitch
- 2 = instantaneous boiler with flowmeter
- 3 = only heating boiler with water tank with probe
- 4 = only heating boiler with water tank with thermostat.

8.8.2 CONFIGURATION FROM AKM PCB

- Select configuration type: **MAIN PCB**
- The REC10 will use the information/settings stored on the AKM PCB to configure the appliance

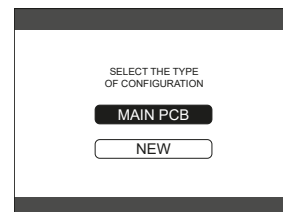

8.8.3 NEW CONFIGURATION

- Select configuration type: **NEW**
- Select location of REC10: **ON BOARD**
- Select **PLANT** type: **CH ONLY – INSTANTANEOUS – HW (STORAGE TANK)** (see below)

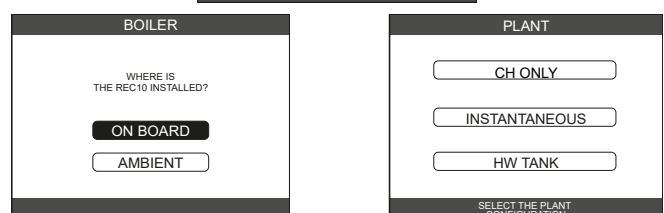
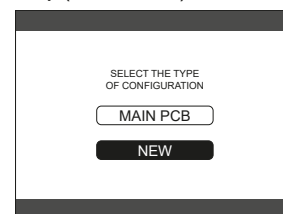

- select **CH ONLY** if the appliance is a 'heat' only system boiler
- select **INSTANTANEOUS** if the appliance is a combination boiler
- then select **FLOW METER (FLUX METER)** (only selectable with **INSTANTANEOUS**).

NOTE

After a system reset where the configuration selection is 'new', carry out a check on the various (applicable) installation parameters to ensure that the 'new' configuration meets the requirements of the system.

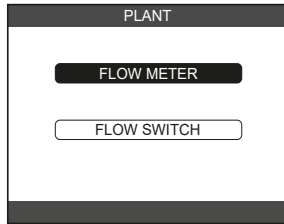

8.9 ACCESS TO INSTALLATION PARAMETERS

Warning! – Unqualified personnel and/or 'end-users' should not attempt to access or adjust ANY installation parameter; serious damage or appliance malfunction may occur as the result of an incorrectly set parameter.

To access the installation parameters:

1. select MENU from the REC10 UI
2. simultaneously press and hold both the 'return' and 'down-arrow' buttons until the display changes to show: INSERT PASSWORD
3. using the 'up-arrow' button, press until '18' is shown in the display, then press 'select'
4. use the following menu string: MENU → TECHNICAL
5. refer to the section 3.1 for further details.

8.10 Typical BeSMART connection – connected to the M4 terminal strip

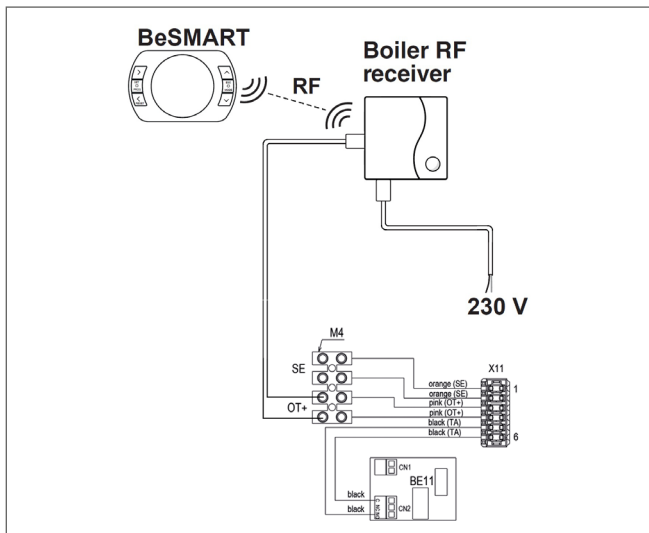

8.11 Typical connection from remote room thermostat and clock – connected to the BE11

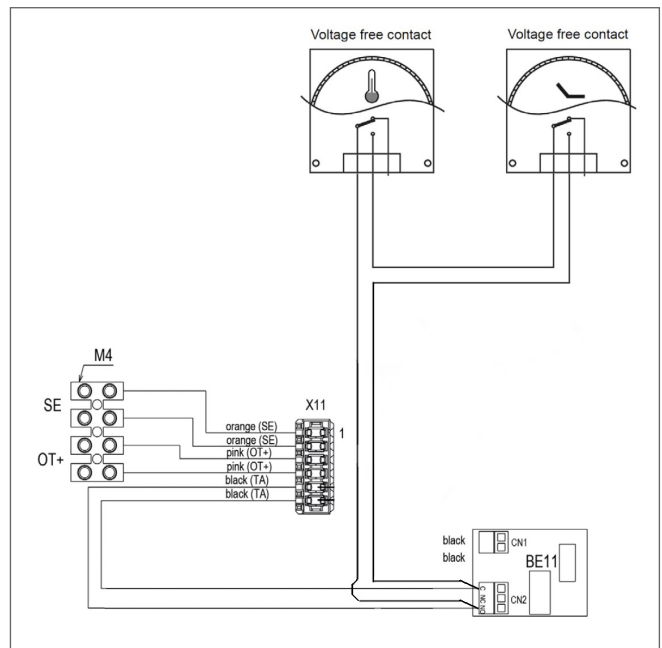

8.12 S-PLAN & Y-PLAN WIRING CONFIGURATIONS

Warning! – Failure to follow the wiring configurations as detailed below, may result in malfunction and/or internal damage to the appliance.

The **UNICA MAX S** system boilers incorporate an internal relay that enables a direct switched 230v supply to be used to generate a heating or hot water request from an external control system such as Y-PLAN or S-PLAN.

To configure an S or Y PLAN control system with the **UNICA MAX S** boiler, proceed as follows:

- 1 Isolate the appliance from the electrical supply and remove the front cover as detailed in section 5.7.1. gain access to the appliance PCB as detailed 5.7.3
- 2 Identify the internal relay PCB (BE11), which is located to the right hand side of the main control PCB
- 3 Route the external wiring from the Y-Plan/S-Plan control system through one of the cable entry points that are located on the lower right-side of the appliance
- 4 Using the (below) relevant diagram as a reference, connect the switched 230v supply (Live & Neutral) from the external control system (Y-Plan/S-Plan) to the small PCB (BE11) at terminals CN1
- 5 Replace the PCB cover ensuring that no internal wiring is trapped or strained
- 6 Replace the appliance front cover as detailed in section 5.7.1.

NOTE

- Under no circumstances should the Y-Plan/S-Plan wiring be connected directly to the TA connections.
- Ensure that the appliance and all other external controls, are served and isolated from the same electrical supply/isolator.
- Ensure that the cable entry point is suitably sealed with silicone sealant or adhesive tape.

S-plan

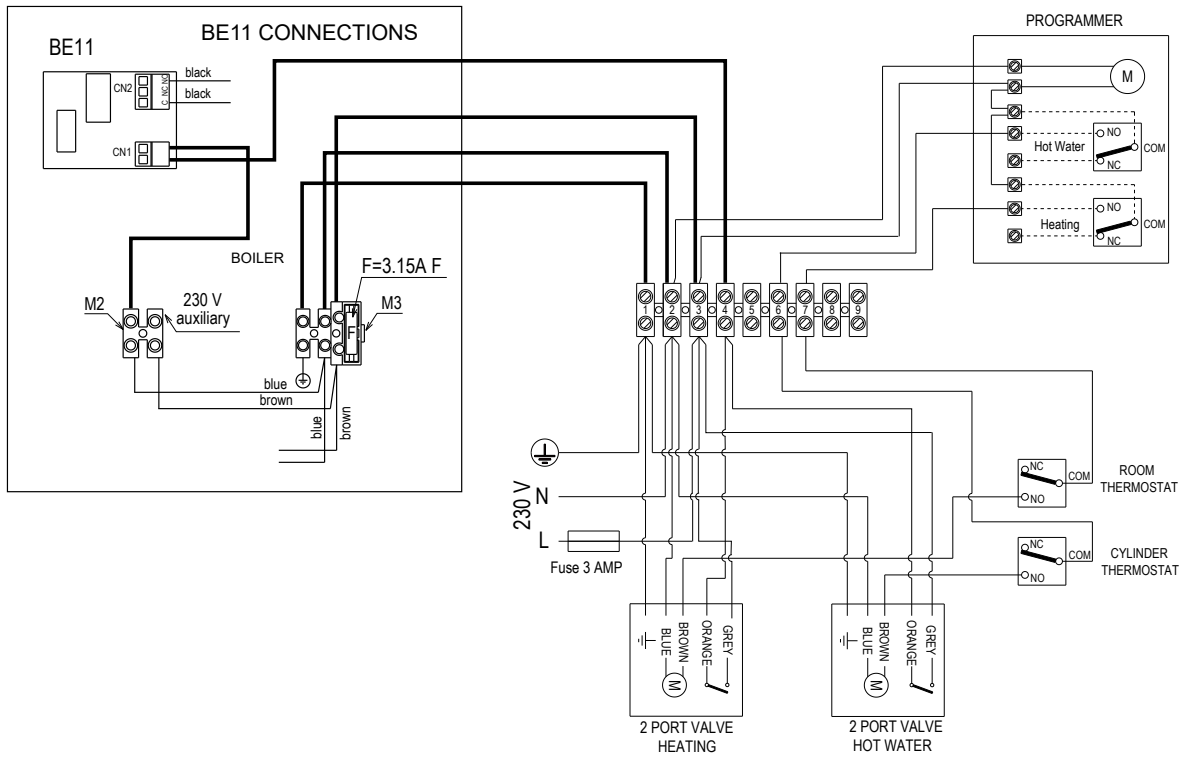

Y-plan

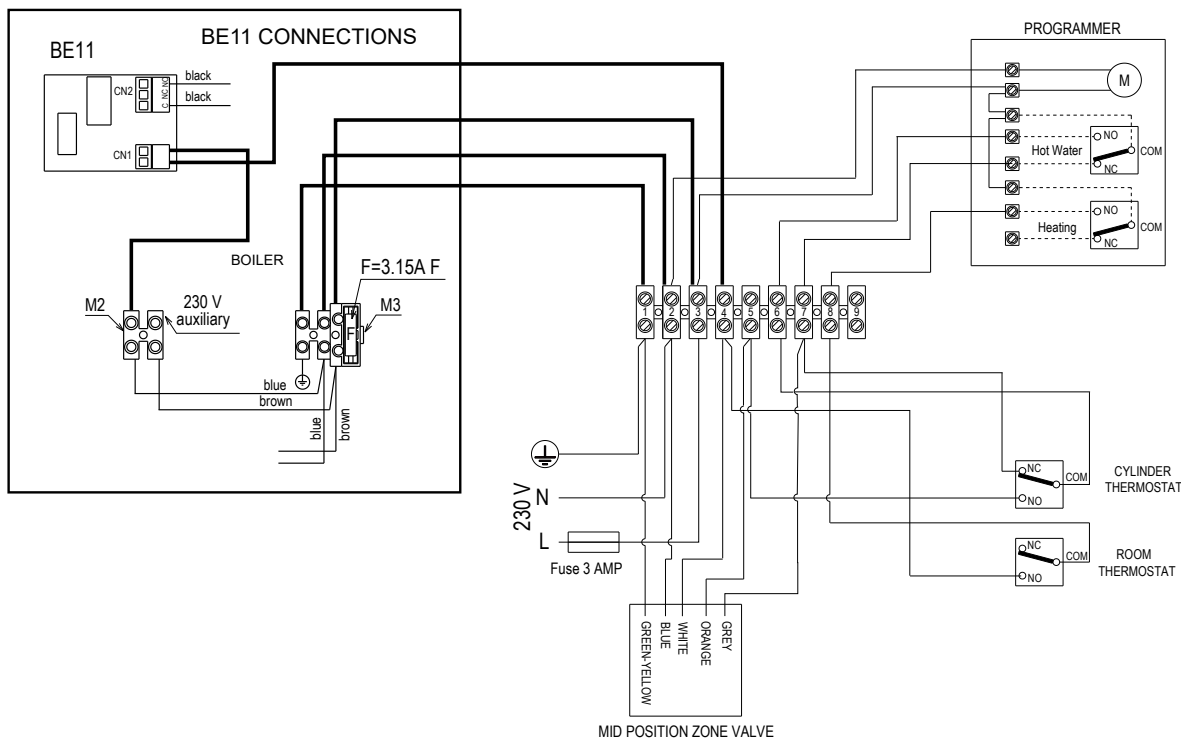

Key

AKM0X	Main PCB
REC	Remote control
BE11	On board relè PCB
X1-X25-CN1	Connectors
S.W.1	CO2 function button
F.S.	Flame sensor
F	External fuse 3.15A F
F1	Fuse 4A T
M2	Terminal strip for electrical connection high power
M4	Terminal strip for electrical connection
OT+	Open therm
SE	External sensor
CE4	External link connector: (- A B +) Bus 485

OPE	Gas valve solenoids
P	Pump
PWM	PWM signal
F Hv	Fan power supply 230 V
TSC2	Ignition transformer
S.E.	Spark electrode
F.O.H.T	Flow over heat thermostat
FS	Flue sensor
FT	Flow thermistor
RS	Return thermistor
P.T.	Pressure transducer
MOD	Modulator
F Lv	Fan signal control

FUNCTIONAL DIAGRAM

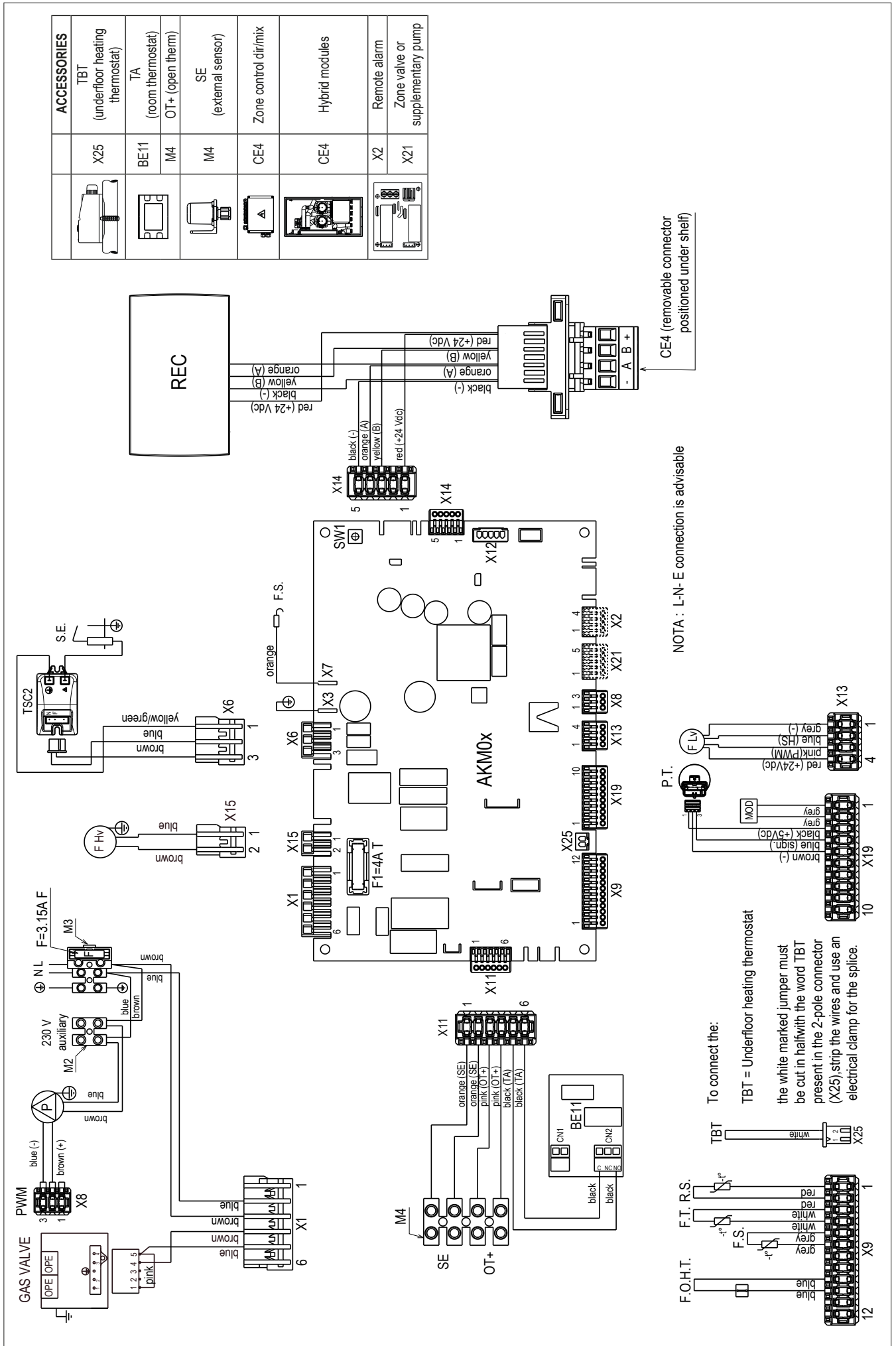

9. SECTION - LPG INSTRUCTIONS

9.1 RELATED DOCUMENTS

BS 6798		INSTALLATION OF BOILERS OF RATED INPUT NOT EXCEEDING 60 kW
BS EN 12828		DESIGN FOR WATER-BASED HEATING SYSTEMS
BS 5440	PARTS 1 & 2	FLUES & VENTILATION
BS 6891		SPECIFICATION FOR THE INSTALLATION AND MAINTENANCE OF LOW PRESSURE GAS INSTALLATION PIPEWORK OF UP TO 35 MM

9.2 TECHNICAL DATA

Gas Pressures	UNICA MAX 20S	UNICA MAX 30S
Inlet pressure	37.0 mbar	37.0 mbar
Maximum gas rate	1.55 (kg/h)	2.48 (kg/h)
Minimum gas rate	0.39 (kg/h)	0.54 (kg/h)
Injector size (mm)	1 x Ø 4.3 mm	1 x Ø 5.2 mm
Number of fan rotations with slow ignition	5,500 (rpm)	5,500 (rpm)
Maximum number of heating fan rotations	6,000 (rpm)	7,200 (rpm)
Minimum number of heating fan rotations	2,000 (rpm)	1,900 (rpm)
Emissions		
NOx (max-min)	30 - 30 p.p.m.	50 - 40 p.p.m.
CO (max-min)	130 - 10 p.p.m.	160 - 10 p.p.m.
CO ₂ (max-min) (*)	10.0 - 10.0 %	10.0 - 10.0 %

(*) CO₂ tolerance = +0.6% -1%

9.3 APPLIANCE RE-CONFIGURATION FOR LPG

WARNING!

The gas supply to the appliance must remain turned OFF until the following procedure has been completed.

1. Select STATE \hookrightarrow BOILER.
2. Set the SERVICE password
3. Select TECHNICAL \hookrightarrow COMBUSTION MONITORING \hookrightarrow GAS TYPE \hookrightarrow LPG

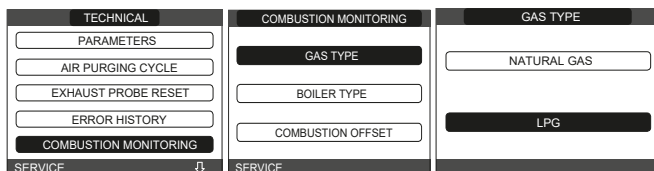

4. Use the 'back' button to return to the 'TECHNICAL' menu and select 'COMBUSTION MONITORING'.
5. Using the data in section 6.2.5, adjust the fan speed settings to the values indicated in section 6.2.5 – pressing the select button to confirm each change.
6. Press and hold the 'back' button for 2-seconds to exit the 'Service' parameters menu.
7. Carry out a combustion check – as detailed in section 6.12 – using the LPG values as indicated in section 6.2.5 above.

NOTE: the appliance gas valve is factory set and therefore non-adjustable. Do not attempt to adjust or interfere with the settings of the gas valve, as to do so, will cause the appliance to malfunction and may lead to serious damage.

The boiler DOES NOT require additional adjustments.



The boiler may only be converted by qualified staff.



After conversion apply the LPG label to the appliance data plate (LPG label is contained within the documentation pack).

COMMISSIONING: CO AND COMBUSTION RATIO CHECK

BEFORE CO AND COMBUSTION RATIO CHECK

The installation instructions should have been followed, gas type verified and gas supply pressure/rate checked as required prior to commissioning.

As part of the installation process, **ESPECIALLY WHERE A FLUE HAS BEEN FITTED BY PERSONS OTHER THAN THE BOILER INSTALLER**, visually check the integrity of the whole flue system to confirm that all components are correctly assembled, fixed and supported. Check that the maximum flue lengths have not been exceeded and all guidance has been followed (e.g. Technical Bulletin 008).

The flue gas analyser should be of the correct type, as specified by BS 7967.

Before use, the flue gas analyser should have been maintained and calibrated as specified by the manufacturer. The installer must have the relevant competence for use of the analyser.

Check and zero the analyser **IN FRESH AIR**, as per analyser manufacturer's instructions.

NOTE

The air/gas ratio valve is factory-set and must not be adjusted during commissioning unless this action is recommended, following contact with the Vokera technical help line. If any such adjustment is recommended and further checking of the boiler is required, the engineer must be competent to carry out this work and to use the flue gas analyser accordingly. If the boiler requires conversion to operate with a different gas family (e.g., conversion from natural gas to LPG) separate guidance will be provided by the Vokera technical help line and must be followed.

SET BOILER TO MAXIMUM RATE

In accordance with, section 7.3, set boiler to operate at maximum rate (full load condition). Allow sufficient time for combustion to stabilise. , insert analyser probe into air inlet sampling point.

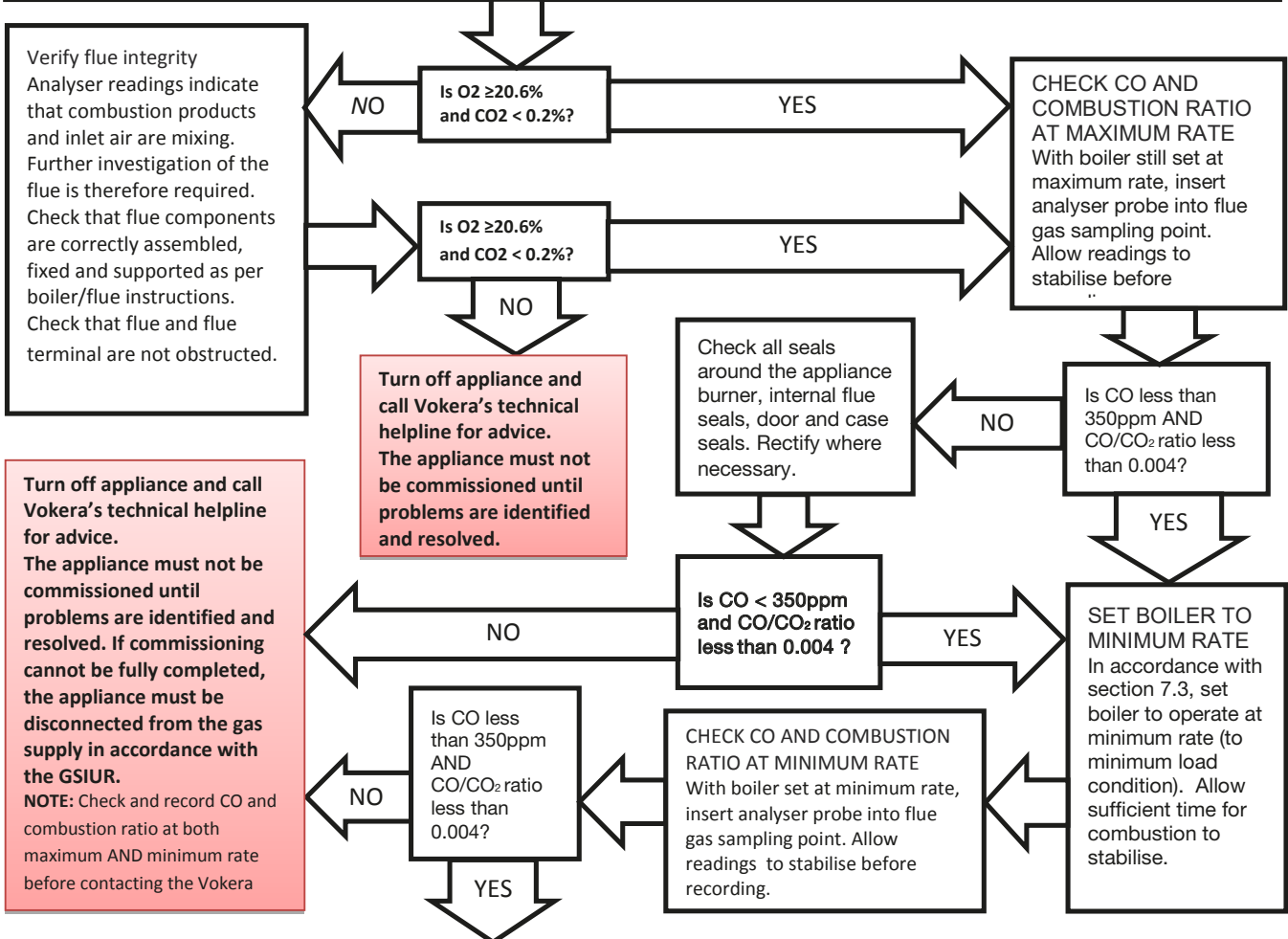

Boiler is operating satisfactorily No further actions required.

Ensure test points are capped, boiler case is correctly replaced and all other commissioning procedures are completed. Complete Benchmark Checklist, recording CO and combustion ratio readings as required.

Benchmark Commissioning & Warranty Validation Service Record

It is a requirement that the boiler is installed and commissioned to the manufacturers' instructions and the data fields on the commissioning checklist completed in full.

To instigate the boiler warranty the boiler needs to be registered with the manufacturer within one month of the installation. The warranty rests with the end-user (consumer), and they should be made aware it is ultimately their responsibility to register with the manufacturer, within the allotted time period.

It is essential that the boiler is serviced in line with the manufacturers' recommendations, at least annually. This must be carried out by a competent Gas Safe registered engineer. The service details should be recorded on the Benchmark Service and Interim Boiler Work Record and left with the householder. Failure to comply with the manufacturers' servicing instructions and requirements will invalidate the warranty.



www.hhic.co.uk

This Commissioning Checklist is to be completed in full by the competent person who commissioned the boiler as a means of demonstrating compliance with the appropriate Building Regulations and then handed to the customer to keep for future reference.

Failure to install and commission according to the manufacturers' instructions and complete this Benchmark Commissioning Checklist will invalidate the warranty. This does not affect the customer's statutory rights.

All installations in England and Wales must be notified to Local Authority Building Control (LABC) either directly or through a competent Persons Scheme. A Building Regulations Compliance Certificate will then be issued to the customer.

Heating and Hotwater Industry Council (HHIC)



www.centralheating.co.uk

GAS BOILER SYSTEM COMMISSIONING CHECKLIST & WARRANTY VALIDATION RECORD

Address:													
Boiler make and model:													
Boiler serial number:													
Commissioned by (PRINT NAME):						Gas Safe registration number:							
Company name:						Telephone number:							
Company email:						Company address:							
										Commissioning date:			
Heating and hot water system complies with the appropriate Building Regulations?											Yes		
Optional: Building Regulations Notification Number (if applicable):													
Time, temperature control and boiler interlock provided for central heating and hot water											Yes		
Boiler Plus requirements (tick the appropriate box(s))													
Boiler Plus option chosen for combination boiler in ENGLAND						Weather compensation			Smart thermostat with automation and optimisation				
						Load compensation			Flue Gas Heat Recovery				
Time and temperature control to hot water			Cylinder thermostat and programmer/timer						Combination boiler				
Zone valves			pre-existing			Fitted			Not required				
Thermostatic radiator valves			pre-existing			Fitted			Not required				
Automatic bypass to system			pre-existing			Fitted			Not required				
Underfloor heating			pre-existing			Fitted			Not required				
Water quality													
The system has been flushed, cleaned and a suitable inhibitor applied upon final fill, in accordance with BS7593 and boiler manufacturers' instructions											Yes		
What system cleaner was used?						Brand:			Product:				
What inhibitor was used?						Brand:			Product:				
Primary water system filter			pre-existing			Fitted			Not required				
CENTRAL HEATING MODE measure and record (as appropriate)													
Gas rate (for combination boilers complete DHW mode gas rate)						m ³ /hr			or			ft ³ /hr	
Central heating output left at factory settings?						Yes			No				
If no, what is the maximum central heating output selected?												kW	
Dynamic gas inlet pressure												mbar	
Central heating flow temperature												°C	
Central heating return temperature												°C	
System correctly balanced/rebalanced?						Yes							
COMBINATION BOILERS ONLY													
Is the installation in a hard water area (above 200ppm)?						Yes			No				
Water scale reducer/softener			pre-existing			Fitted			Not required				
What type of scale reducer/softener has been fitted?						Brand:			Product:				
Water meter fitted?						Yes			No				
If yes- DHW expansion vessel			pre-existing			Fitted			Not required				
Pressure reducing valve			pre-existing			Fitted			Not required				
DOMESTIC HOT WATER MODE Measure and record													
Gas rate						m ³ /hr			or			ft ³ /hr	
Dynamic gas inlet pressure at maximum rate												mbar	
Cold water inlet temperature												°C	
Hot water has been checked at all outlets						Yes			Temperature			°C	
CONDENSATE DISPOSAL													
The condensate drain has been installed in accordance with the manufacturers' instructions and/or BS5546/BS6798											Yes		
Point of termination						Internal			External (only where internal termination impractical)				
Method of disposal						Gravity			Pumped				
ALL INSTALLATIONS													
Record the following		At max rate:		CO ppm		CO ₂ %		CO/CO ₂ Ratio					
		At min rate (where possible)		CO ppm		CO ₂ %		CO/CO ₂ Ratio					
Where possible, has a flue integrity check been undertaken in accordance with manufacturers' instructions, and readings are correct?											Yes		
The operation of the boiler and system controls have been demonstrated to and understood by the customer											Yes		
The manufacturers' literature, including Benchmark Checklist and Service Record, has been explained and left with the customer											Yes		
Commissioning Engineer's signature													
Customer's signature (To confirm satisfactory demonstration and receipt of manufacturers' literature)													

* All installations in England and Wales must be notified to Local Authority Building Control (LABC) either directly or through a Competent Persons Scheme. A Building Regulations Compliance Certificate will then be issued to the customer.

© Heating and Hotwater Industry Council (HHIC)



www.centralheating.co.uk

SERVICE & INTERIM BOILER WORK RECORD

It is recommended that your boiler and heating system are regularly serviced and maintained, in line with manufacturers' instructions, and that the appropriate service / interim work record is completed.

Service provider

When completing a service record (as below), please ensure you have carried out the service as described in the manufacturers' instructions. Always use the manufacturers specified spare parts.

SERVICE/INTERIM WORK ON BOILER <small>delete as appropriate</small>					Date:
Engineer name:		Company name:			
Telephone N°:		Gas Safe registration N°:			
Max rate	CO	ppm	CO ₂	%	CO/CO ₂
Min rate	CO	ppm	CO ₂	%	CO/CO ₂
Where possible, has a flue integrity check been undertaken in accordance with manufacturers' instructions, and readings are correct?"					yes
Gas rate:	m ³ /h	OR	ft ³ /h		
Were parts fitted? <small>delete as appropriate</small>					Yes No
Parts fitted:					
System inhibitor concentration has been checked and appropriate action taken, in accordance with BS 7593 and boiler manufacturers' instructions. *					yes n/a
Comments:					
Signature:					

*A System inhibitor efficacy test is required on every annual service in accordance with the manufacturers' instructions and BS 7593. It is only acceptable to not have undertaken this if the service engineers attendance visit was in between annual services to attend a non-water facing component.

SERVICE/INTERIM WORK ON BOILER <small>delete as appropriate</small>					Date:
Engineer name:		Company name:			
Telephone N°:		Gas Safe registration N°:			
Max rate	CO	ppm	CO ₂	%	CO/CO ₂
Min rate	CO	ppm	CO ₂	%	CO/CO ₂
Where possible, has a flue integrity check been undertaken in accordance with manufacturers' instructions, and readings are correct?"					yes
Gas rate:	m ³ /h	OR	ft ³ /h		
Were parts fitted? <small>delete as appropriate</small>					Yes No
Parts fitted:					
System inhibitor concentration has been checked and appropriate action taken, in accordance with BS 7593 and boiler manufacturers' instructions. *					yes n/a
Comments:					
Signature:					

*A System inhibitor efficacy test is required on every annual service in accordance with the manufacturers' instructions and BS 7593. It is only acceptable to not have undertaken this if the service engineers attendance visit was in between annual services to attend a non-water facing component.

SERVICE/INTERIM WORK ON BOILER <small>delete as appropriate</small>					Date:
Engineer name:		Company name:			
Telephone N°:		Gas Safe registration N°:			
Max rate	CO	ppm	CO ₂	%	CO/CO ₂
Min rate	CO	ppm	CO ₂	%	CO/CO ₂
Where possible, has a flue integrity check been undertaken in accordance with manufacturers' instructions, and readings are correct?"					yes
Gas rate:	m ³ /h	OR	ft ³ /h		
Were parts fitted? <small>delete as appropriate</small>					Yes No
Parts fitted:					
System inhibitor concentration has been checked and appropriate action taken, in accordance with BS 7593 and boiler manufacturers' instructions. *					yes n/a
Comments:					
Signature:					

*A System inhibitor efficacy test is required on every annual service in accordance with the manufacturers' instructions and BS 7593. It is only acceptable to not have undertaken this if the service engineers attendance visit was in between annual services to attend a non-water facing component.

SERVICE/INTERIM WORK ON BOILER <small>delete as appropriate</small>					Date:
Engineer name:		Company name:			
Telephone N°:		Gas Safe registration N°:			
Max rate	CO	ppm	CO ₂	%	CO/CO ₂
Min rate	CO	ppm	CO ₂	%	CO/CO ₂
Where possible, has a flue integrity check been undertaken in accordance with manufacturers' instructions, and readings are correct?"					yes
Gas rate:	m ³ /h	OR	ft ³ /h		
Were parts fitted? <small>delete as appropriate</small>					Yes No
Parts fitted:					
System inhibitor concentration has been checked and appropriate action taken, in accordance with BS 7593 and boiler manufacturers' instructions. *					yes n/a
Comments:					
Signature:					

*A System inhibitor efficacy test is required on every annual service in accordance with the manufacturers' instructions and BS 7593. It is only acceptable to not have undertaken this if the service engineers attendance visit was in between annual services to attend a non-water facing component.

SERVICE/INTERIM WORK ON BOILER <small>delete as appropriate</small>					Date:
Engineer name:		Company name:			
Telephone N°:		Gas Safe registration N°:			
Max rate	CO	ppm	CO ₂	%	CO/CO ₂
Min rate	CO	ppm	CO ₂	%	CO/CO ₂
Where possible, has a flue integrity check been undertaken in accordance with manufacturers' instructions, and readings are correct?"					yes
Gas rate:	m ³ /h	OR	ft ³ /h		
Were parts fitted? <small>delete as appropriate</small>					Yes No
Parts fitted:					
System inhibitor concentration has been checked and appropriate action taken, in accordance with BS 7593 and boiler manufacturers' instructions. *					yes n/a
Comments:					
Signature:					

*A System inhibitor efficacy test is required on every annual service in accordance with the manufacturers' instructions and BS 7593. It is only acceptable to not have undertaken this if the service engineers attendance visit was in between annual services to attend a non-water facing component.

SERVICE/INTERIM WORK ON BOILER <small>delete as appropriate</small>					Date:
Engineer name:		Company name:			
Telephone N°:		Gas Safe registration N°:			
Max rate	CO	ppm	CO ₂	%	CO/CO ₂
Min rate	CO	ppm	CO ₂	%	CO/CO ₂
Where possible, has a flue integrity check been undertaken in accordance with manufacturers' instructions, and readings are correct?"					yes
Gas rate:	m ³ /h	OR	ft ³ /h		
Were parts fitted? <small>delete as appropriate</small>					Yes No
Parts fitted:					
System inhibitor concentration has been checked and appropriate action taken, in accordance with BS 7593 and boiler manufacturers' instructions. *					yes n/a
Comments:					
Signature:					

*A System inhibitor efficacy test is required on every annual service in accordance with the manufacturers' instructions and BS 7593. It is only acceptable to not have undertaken this if the service engineers attendance visit was in between annual services to attend a non-water facing component.

* All installations in England and Wales must be notified to Local Authority Building Control (LABC) either directly or through a Competent Persons Scheme. A Building Regulations Compliance Certificate will then be issued to the customer.

© Heating and Hotwater Industry Council (HHIC)



www.centralheating.co.uk

SERVICE & INTERIM BOILER WORK RECORD

It is recommended that your boiler and heating system are regularly serviced and maintained, in line with manufacturers' instructions, and that the appropriate service / interim work record is completed.

Service provider

When completing a service record (as below), please ensure you have carried out the service as described in the manufacturers' instructions. Always use the manufacturers' specified spare parts.

SERVICE/INTERIM WORK ON BOILER <small>delete as appropriate</small>					Date:
Engineer name:		Company name:			
Telephone N°:		Gas Safe registration N°:			
Max rate	CO	ppm	CO ₂	%	CO/CO ₂
Min rate	CO	ppm	CO ₂	%	CO/CO ₂
Where possible, has a flue integrity check been undertaken in accordance with manufacturers' instructions, and readings are correct?*					yes
Gas rate:	m ³ /h	OR	ft ³ /h		
Were parts fitted? <small>delete as appropriate</small>		Yes	No		
Parts fitted:					
System inhibitor concentration has been checked and appropriate action taken, in accordance with BS 7593 and boiler manufacturers' instructions. *					yes
					n/a
Comments:					
Signature:					

*A System inhibitor efficacy test is required on every annual service in accordance with the manufacturers' instructions and BS 7593. It is only acceptable to not have undertaken this if the service engineers attendance visit was in between annual services to attend a non-water facing component.

SERVICE/INTERIM WORK ON BOILER <small>delete as appropriate</small>					Date:
Engineer name:		Company name:			
Telephone N°:		Gas Safe registration N°:			
Max rate	CO	ppm	CO ₂	%	CO/CO ₂
Min rate	CO	ppm	CO ₂	%	CO/CO ₂
Where possible, has a flue integrity check been undertaken in accordance with manufacturers' instructions, and readings are correct?*					yes
Gas rate:	m ³ /h	OR	ft ³ /h		
Were parts fitted? <small>delete as appropriate</small>		Yes	No		
Parts fitted:					
System inhibitor concentration has been checked and appropriate action taken, in accordance with BS 7593 and boiler manufacturers' instructions. *					yes
					n/a
Comments:					
Signature:					

*A System inhibitor efficacy test is required on every annual service in accordance with the manufacturers' instructions and BS 7593. It is only acceptable to not have undertaken this if the service engineers attendance visit was in between annual services to attend a non-water facing component.

SERVICE/INTERIM WORK ON BOILER <small>delete as appropriate</small>					Date:
Engineer name:		Company name:			
Telephone N°:		Gas Safe registration N°:			
Max rate	CO	ppm	CO ₂	%	CO/CO ₂
Min rate	CO	ppm	CO ₂	%	CO/CO ₂
Where possible, has a flue integrity check been undertaken in accordance with manufacturers' instructions, and readings are correct?*					yes
Gas rate:	m ³ /h	OR	ft ³ /h		
Were parts fitted? <small>delete as appropriate</small>		Yes	No		
Parts fitted:					
System inhibitor concentration has been checked and appropriate action taken, in accordance with BS 7593 and boiler manufacturers' instructions. *					yes
					n/a
Comments:					
Signature:					

*A System inhibitor efficacy test is required on every annual service in accordance with the manufacturers' instructions and BS 7593. It is only acceptable to not have undertaken this if the service engineers attendance visit was in between annual services to attend a non-water facing component.

SERVICE/INTERIM WORK ON BOILER <small>delete as appropriate</small>					Date:
Engineer name:		Company name:			
Telephone N°:		Gas Safe registration N°:			
Max rate	CO	ppm	CO ₂	%	CO/CO ₂
Min rate	CO	ppm	CO ₂	%	CO/CO ₂
Where possible, has a flue integrity check been undertaken in accordance with manufacturers' instructions, and readings are correct?*					yes
Gas rate:	m ³ /h	OR	ft ³ /h		
Were parts fitted? <small>delete as appropriate</small>		Yes	No		
Parts fitted:					
System inhibitor concentration has been checked and appropriate action taken, in accordance with BS 7593 and boiler manufacturers' instructions. *					yes
					n/a
Comments:					
Signature:					

*A System inhibitor efficacy test is required on every annual service in accordance with the manufacturers' instructions and BS 7593. It is only acceptable to not have undertaken this if the service engineers attendance visit was in between annual services to attend a non-water facing component.

SERVICE/INTERIM WORK ON BOILER <small>delete as appropriate</small>					Date:
Engineer name:		Company name:			
Telephone N°:		Gas Safe registration N°:			
Max rate	CO	ppm	CO ₂	%	CO/CO ₂
Min rate	CO	ppm	CO ₂	%	CO/CO ₂
Where possible, has a flue integrity check been undertaken in accordance with manufacturers' instructions, and readings are correct?*					yes
Gas rate:	m ³ /h	OR	ft ³ /h		
Were parts fitted? <small>delete as appropriate</small>		Yes	No		
Parts fitted:					
System inhibitor concentration has been checked and appropriate action taken, in accordance with BS 7593 and boiler manufacturers' instructions. *					yes
					n/a
Comments:					
Signature:					

*A System inhibitor efficacy test is required on every annual service in accordance with the manufacturers' instructions and BS 7593. It is only acceptable to not have undertaken this if the service engineers attendance visit was in between annual services to attend a non-water facing component.

SERVICE/INTERIM WORK ON BOILER <small>delete as appropriate</small>					Date:
Engineer name:		Company name:			
Telephone N°:		Gas Safe registration N°:			
Max rate	CO	ppm	CO ₂	%	CO/CO ₂
Min rate	CO	ppm	CO ₂	%	CO/CO ₂
Where possible, has a flue integrity check been undertaken in accordance with manufacturers' instructions, and readings are correct?*					yes
Gas rate:	m ³ /h	OR	ft ³ /h		
Were parts fitted? <small>delete as appropriate</small>		Yes	No		
Parts fitted:					
System inhibitor concentration has been checked and appropriate action taken, in accordance with BS 7593 and boiler manufacturers' instructions. *					yes
					n/a
Comments:					
Signature:					

*A System inhibitor efficacy test is required on every annual service in accordance with the manufacturers' instructions and BS 7593. It is only acceptable to not have undertaken this if the service engineers attendance visit was in between annual services to attend a non-water facing component.

* All installations in England and Wales must be notified to Local Authority Building Control (LABC) either directly or through a Competent Persons Scheme. A Building Regulations Compliance Certificate will then be issued to the customer.

© Heating and Hotwater Industry Council (HHIC)



www.centralheating.co.uk

Vokèra Warranty Terms and Conditions

Vokèra Ltd offer customers the comfort of a parts and labour warranty repair service subject to the following terms and conditions.

Vokèra Ltd only obligation under the guarantee shall be to repair or replace the faulty appliance at Vokèra Ltd discretion. This will be carried out where a fault arises from defects within the appliance, caused by either material or workmanship of the manufacturer.

1. The boiler must have been installed and commissioned within 12 months of manufacture by a registered Gas Safe (RGII ROI) installer in accordance with the guidelines in the installation and servicing booklet provided with the boiler.
2. This guarantee does not protect malfunction or damage arising from incorrect installation, commissioning or maintenance procedures, as laid out in the installation handbook, inefficient flue system, poor or incorrect electricity, wrong gas supply or pressure, tampering by inexperienced persons and any other cause not directly due to manufacture.
3. Vokèra Ltd cannot accept responsibility for any costs arising from repair or maintenance carried out by any third party.
4. The "Benchmark" commissioning sheet (RGII Installation Certificate, ROI) must be completed by the installer and left with the boiler for reference purpose.
5. The warranty will commence from the date of installation. Without proof of purchase ie an invoice or completed "Benchmark" commissioning sheet (RGII Installation Certificate, ROI), the warranty will commence from the date of manufacture as detailed on the appliance data plate.
6. **To qualify for the full term of warranty, the boiler must be serviced once annually by a Gas Safe Registered Engineer (RGII ROI). Proof of annual service in accordance with the manufacturer's instructions must be provided (e.g. Benchmark Service Record or RGII Service Certificates ROI). If this condition is not met the period of warranty will extend to only 12 months from date of installation.**
7. The Vokèra "parts and labour" warranty is applicable to the boiler only. Vokèra controls and accessories, including all time clocks, room thermostats, smart controls and weather compensation devices are sold subject to a 24 month Return to Base Warranty. No engineer service cover is offered on any Vokèra controls and/or accessories.

By registering your appliance, you will be helping us provide you with the best after sales service in the unlikely event that your boiler requires attention during the guarantee period.

Register online: www.vokera.co.uk (UK) or www.vokera.ie (ROI)

If the boiler suffers a mechanical or an electrical breakdown or you require an annual service, please contact our Customer Care Centre on:

UK: 01274 866100

ROI: 056 7755057

Our normal working hours, excluding Bank holidays are:

8.15am - 5.00pm Monday to Friday (ROI, 8.30am - 5.00pm Monday to Thursday, 8.30am - 4.00pm Friday)

8.00am - 12.00pm Saturday (UK only)

We will arrange for an engineer or appointed agent, to inspect and repair, or where in our sole opinion repair is not economic, arrange to replace the boiler.

8. Health & Safety:

- a. Engineers will only attend to boiler products where it is considered by the engineer that the installation does not pose a risk to health and safety.
- b. A permanently fixed access ladder must service installations in lofts or attics. Adequate lighting and permanently fixed flooring must also be available.
- c. Cupboard installations must provide minimum working clearances as detailed in the installation instructions. Vokèra will not accept responsibility for the removal of cupboards, kitchen units or trims in order to gain access for repairs.

9. Warranty does not apply:

- a. If the boiler is removed from its place of installation without our prior consent.
- b. To any defect, damage or breakdown caused by inadequate servicing of the boiler or by deliberate action, accident, misuse or third party interference including modification or an attempted repair which does not fully comply with industry standards.
- c. To any defect, damage or breakdown caused by the design, installation and maintenance of the central heating system.
- d. To de-scaling or other work required as a result of hard water scale deposits or from damage caused by aggressive water or sludge resulting from corrosion. Indications that such work may be required include a noisy boiler, cold spots on radiators, sludge in pipes and poor circulation of the central heating system.
- e. If the claim/contact procedure set out in section 6 is not adhered to.
- f. To any other costs or expenses caused by or arising as a result of the breakdown of a Vokèra Boiler.
- g. To any costs incurred during delays in fixing reported faults.

10. We reserve the right to a charge a callout fee where:

- a. There is no completed "Benchmark" commissioning sheet or equivalent control document present.
 - b. There is incomplete or no service record(s) for each and every year the boiler has been installed.
 - c. A fault cannot be found.
 - d. The breakdown or fault has been caused by an event, which is excluded from the warranty – see section 9.
 - e. Failure to cancel an agreed appointment prior to our engineers visit.
 - f. The boiler is outside the period of warranty or the conditions of the warranty have not been met.
11. If we fit replacement parts or replace a boiler it will not extend the period of the warranty. All replaced parts or boilers will become the property of Vokèra Ltd.
12. The warranty applies only where a Vokèra boiler has been installed in a domestic dwelling in the United Kingdom, Northern Ireland or Republic of Ireland, to provide heat and/or hot water to the central heating system.
13. Vokèra Ltd warranty is offered in addition to the rights provided to a consumer by law. Details of these rights can be obtained from a Trading Standards Authority or a Citizen Advice Bureaux.

Contact Us:- Customer Care Centre Tel: 01274 866100 (UK), 056 7755057 (ROI)

UK: Vokèra Ltd, Customer Care, Stubs Beck Lane, West 26 Business Park, Whitehall Road, Cleckheaton, BD19 4TT

ROI: Vokèra Ltd, Customer Care, West Court, Callan, Co Kilkenny, Ireland , R95 PW40

Email: service@vokera.co.uk (UK), eire-service@vokera.co.uk (ROI)

RANGE RATED - EN 15502

The max CH input of this boiler has been adjusted to _____ kW,
equivalent to _____ rpm max CH fan speed.

Date ___ / ___ / ___

Signature _____

Boiler serial number

Registered address:

Vokèra Ltd
Borderlake House
Unit 7 Riverside Industrial Estate
London Colney
Herts AL2 1HG

www.vokera.co.uk
www.vokera.ie

Sales, General Enquires

T 0844 391 0999
F 0844 391 0998

Vokèra Ireland
West Court, Callan
Co Kilkenny
T 056 7755057
F 056 7755060

Vokèra Limited reserve the right to change
specification without prior notice
Consumers statutory rights are not affected.

Company Reg No: 1047779